

XPS 14 9440

Owner's Manual

Notes, cautions, and warnings

 **NOTE:** A NOTE indicates important information that helps you make better use of your product.

 **CAUTION:** A CAUTION indicates either potential damage to hardware or loss of data and tells you how to avoid the problem.

 **WARNING:** A WARNING indicates a potential for property damage, personal injury, or death.

Chapter 1: Views of XPS 14 9440.....	6
Left.....	6
Right.....	7
Top.....	8
Front.....	9
Bottom.....	10
Service Tag.....	10
Chapter 2: Set up your XPS 14 9440.....	12
Chapter 3: Specifications of XPS 14 9440.....	14
Dimensions and weight.....	14
Processor.....	14
Chipset.....	15
Operating system.....	15
Memory.....	16
External ports.....	16
Internal slots.....	17
Wireless module.....	17
Audio.....	18
Storage.....	18
Media-card reader.....	18
Keyboard.....	19
Keyboard shortcuts of XPS 14 9440.....	19
Camera.....	20
Touchpad.....	21
Power adapter.....	21
Battery.....	22
Display.....	23
Fingerprint reader.....	23
GPU—Integrated.....	24
GPU—Discrete.....	24
External display support.....	24
Operating and storage environment.....	24
Dell support policy.....	25
Dell low blue light display.....	25
Chapter 4: Working inside your computer.....	26
Safety instructions.....	26
Before working inside your computer.....	26
Safety precautions.....	27
Electrostatic discharge—ESD protection.....	27
ESD Field Service kit	28
Transporting sensitive components.....	29

After working inside your computer.....	29
Recommended tools.....	29
Screw list.....	29
Major components of XPS 14 9440.....	30
Chapter 5: Removing and installing Field Replaceable Units (FRUs).....	33
Base cover.....	33
Removing the base cover.....	33
Installing the base cover.....	37
Battery.....	41
Rechargeable Li-ion battery precautions.....	41
Removing the battery.....	42
Installing the battery.....	43
Solid-state drive.....	45
Removing the M.2 2230 solid-state drive (SSD).....	45
Installing the M.2 2230 solid-state drive (SSD).....	46
Removing the M.2 2280 solid-state drive (SSD).....	48
Installing the M.2 2280 solid-state drive (SSD).....	49
Heat-sink assembly.....	51
Removing the heat-sink assembly - for computers shipped with an integrated graphics card.....	51
Installing the heat sink - for computers shipped with an integrated graphics card.....	53
Removing the heat-sink assembly - for computers shipped with discrete graphics card.....	55
Installing the heat-sink assembly - for computers shipped with discrete graphics card.....	56
Display assembly.....	58
Removing the display assembly.....	58
Installing the display assembly.....	61
System board.....	64
Removing the system board.....	64
Installing the system board.....	67
Power button with fingerprint reader.....	70
Removing the power button with fingerprint reader.....	70
Installing the power button with fingerprint reader.....	71
Keyboard.....	72
Removing the keyboard.....	72
Installing the keyboard.....	74
Palm-rest assembly.....	77
Removing the palm-rest assembly.....	77
Installing the palm-rest assembly.....	79
Chapter 6: Software.....	81
Operating system.....	81
Drivers and downloads.....	81
Chapter 7: BIOS Setup.....	82
Entering BIOS setup program.....	82
Clearing chassis intrusion alert.....	82
F12 One Time Boot menu.....	84
Navigation keys.....	84
System setup options.....	85

Updating the BIOS.....	99
Updating the BIOS in Windows.....	99
Updating the BIOS using the USB drive in Windows.....	100
Updating the BIOS from the F12 One Time Boot menu.....	100
System and setup password.....	101
Assigning a System Setup password.....	101
Deleting or changing an existing system setup password.....	102
Clearing BIOS (System Setup) and System passwords.....	102
Chapter 8: Troubleshooting.....	103
Handling swollen rechargeable Li-ion batteries.....	103
Locate the Service Tag or Express Service Code of your Dell computer	103
Dell SupportAssist Pre-boot System Performance Check diagnostics.....	104
Running the SupportAssist Pre-Boot System Performance Check.....	104
Built-in self-test (BIST).....	104
M-BIST.....	104
LCD Power rail test (L-BIST).....	105
LCD Built-in Self-Test (BIST).....	105
Diagnostic error codes.....	106
Recovering the operating system.....	106
Real-Time Clock (RTC Reset).....	106
Backup media and recovery options.....	106
Wi-Fi power cycle.....	106
Drain residual flea power (perform hard reset).....	107
Chapter 9: Getting help and contacting Dell.....	108

Views of XPS 14 9440

Left



Figure 1. Left view

1. Thunderbolt 4.0 port with Power Delivery and DisplayPort

Supports USB4, DisplayPort 2.1, Thunderbolt 4 and also enables you to connect to an external display using a display adapter. Provides data transfer rates of up to 40 Gbps for USB4 and Thunderbolt 4.

NOTE: You can connect a Dell Docking Station to the Thunderbolt 4 ports. For more information, search in the Knowledge Base Resource at www.dell.com/support.

NOTE: A USB Type-C to DisplayPort adapter (sold separately) is required to connect a DisplayPort device.

NOTE: Thunderbolt 4 is backward compatible with USB 3.2, USB 2.0, and Thunderbolt 3.

NOTE: Thunderbolt 4 supports two 4K displays or one 8K display.

2. Thunderbolt 4.0 port with Power Delivery and DisplayPort

Supports USB4, DisplayPort 2.1, Thunderbolt 4 and also enables you to connect to an external display using a display adapter. Provides data transfer rates of up to 40 Gbps for USB4 and Thunderbolt 4.

NOTE: You can connect a Dell Docking Station to the Thunderbolt 4 ports. For more information, search in the Knowledge Base Resource at www.dell.com/support.

NOTE: A USB Type-C to DisplayPort adapter (sold separately) is required to connect a DisplayPort device.

NOTE: Thunderbolt 4 is backward compatible with USB 3.2, USB 2.0, and Thunderbolt 3.

NOTE: Thunderbolt 4 supports two 4K displays or one 8K display.

Right



Figure 2. Right view

1. microSD-card slot v6.0

The microSD-card slot reads from and writes to the microSD card. The computer supports the following card types:

- microSecure Digital (microSD)
- microSecure Digital High Capacity (microSDHC)
- microSecure Digital Extended Capacity (microSDXC)

2. Thunderbolt 4.0 port with Power Delivery and DisplayPort

Supports USB4, DisplayPort 2.1, Thunderbolt 4 and also enables you to connect to an external display using a display adapter. Provides data transfer rates of up to 40 Gbps for USB4 and Thunderbolt 4.

NOTE: You can connect a Dell Docking Station to the Thunderbolt 4 ports. For more information, search in the Knowledge Base Resource at www.dell.com/support.

NOTE: A USB Type-C to DisplayPort adapter (sold separately) is required to connect a DisplayPort device.

NOTE: Thunderbolt 4 is backward compatible with USB 3.2, USB 2.0, and Thunderbolt 3.

NOTE: Thunderbolt 4 supports two 4K displays or one 8K display.

3. Headset port

Connect headphones or a headset (headphone and microphone combo).

Top



Figure 3. Top view

1. Capacitive touch function row

Displays media and display control keys or standard function keys, with **esc** and **delete** keys.

Press and hold the **fn** key on the physical keyboard to switch to the next set of keys.

Press the **fn** key on the physical keyboard and the **esc** key on the capacitive touch function row to switch to the next set of keys and lock the mode of the panel.

2. Power button with fingerprint reader

Press to turn on the computer if it is turned off, in sleep state, or in hibernate state.

When the computer is turned on, press the power button to put the computer into a sleep state. Press and hold the power button for 10 seconds to force shut-down the computer.

If the power button has a fingerprint reader, place your finger on the power button steadily to log in.

NOTE: The power-status light on the power button is available only on computers without the fingerprint reader. Computers that are shipped with the fingerprint reader that is integrated on the power button do not have the power-status light on the power button.

NOTE: You can customize the power-button behavior in Windows.

3. Speakers

Provide audio output.

4. Haptic touchpad

Move your finger on the touchpad to move the mouse pointer. Tap to left-click and two fingers tap to right-click.

Front



Figure 4. Front view

1. Infrared emitter

The Infrared emitter emits infrared light, which enables the infrared camera to sense and track motion.

2. Infrared camera

The Infrared camera uses facial recognition and enhances security when paired with Windows Hello face authentication.

3. RGB and infrared camera

The RGB and infrared camera enables you to video chat, capture photos, and record videos.

4. Camera-status light

The camera-status light turns on when the camera is in use.

5. Ambient-light sensor

The sensor detects the ambient light and automatically adjusts the display and capacitive touch function row brightness.

Bottom

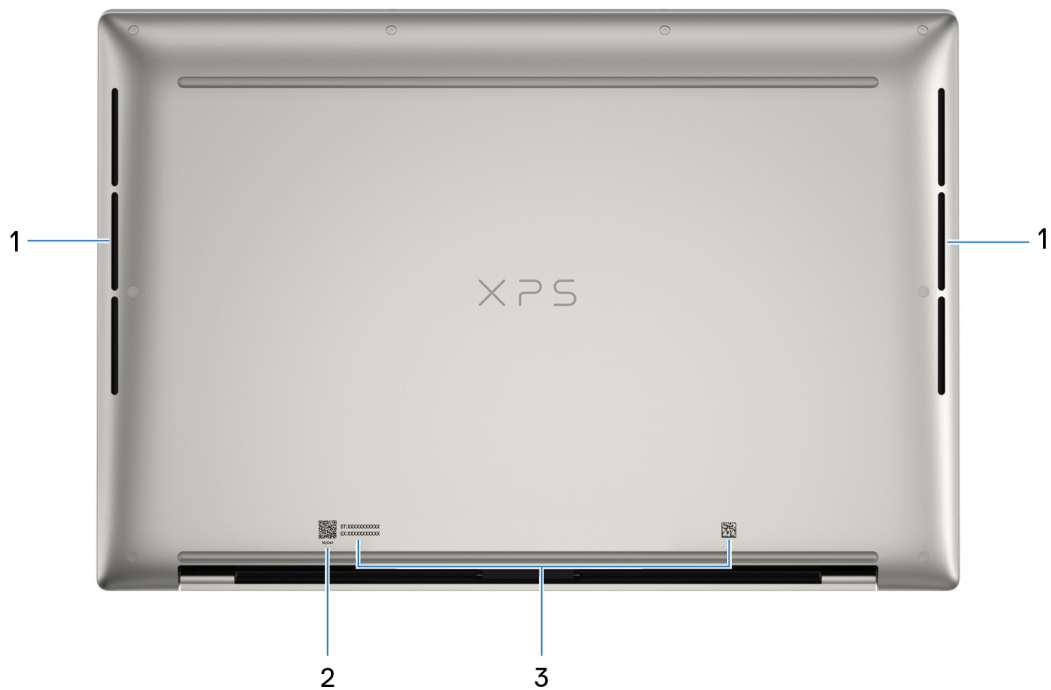

Figure 5. Bottom view

1. Air vents

Air vents provide ventilation for your computer. Clogged air vents can cause overheating and can affect your computer performance and potentially cause hardware issues. Keep the air vents clear of obstructions and clean them regularly to prevent the build-up of dust and dirt. For more information about cleaning air vents, search for articles in the Knowledge Base Resource at www.dell.com/support.

2. MyDell QR code

MyDell provides a consolidated application experience housing capability that helps you get the most out of your computer. Intelligent, AI-based optimization features automatically fine-tune your computer for the best audio, video, battery, and performance. Each MyDell user experience is unique as the software learns and responds to the way you use your computer.

3. Service Tag label

The Service Tag is a unique alphanumeric identifier that enables Dell service technicians to identify the hardware components in your computer and access warranty information.

Service Tag

The service tag is a unique alphanumeric identifier that allows Dell service technicians to identify the hardware components in your computer and access warranty information.

Set up your XPS 14 9440

About this task

NOTE: The images in this document may differ from your computer depending on the configuration you ordered.

Steps

1. Connect the power adapter and press the power button.



Figure 7. Connect the power adapter and press the power button.

NOTE: The battery may go into power-saving mode during shipment to conserve charge on the battery. Ensure that the power adapter is connected to your computer when it is turned on for the first time.

2. Finish the operating system setup.

Follow the on-screen instructions to complete the setup. When setting up, Dell Technologies recommends that you:

- Connect to a network for Windows updates.
 - NOTE:** If connecting to a secured wireless network, enter the password for the wireless network access when prompted.
- If connected to the Internet, sign in with or create a Microsoft account. If not connected to the Internet, create an offline account.
- On the **Support and Protection** screen, enter your contact details.

3. Locate and use Dell apps from the Windows Start menu—Recommended.

Table 1. Locate Dell apps in Windows





Resources	Description
	<p>My Dell</p> <p>MyDell is a software application that offers you a single streamlined engagement platform including account access, device information, and hardware settings. This software delivers intelligent features that automatically fine-tune your computer for the best possible audio, power, and</p>

Table 1. Locate Dell apps in Windows (continued)

Resources	Description
	<p>performance. Get the most out of your Dell device with intelligent, personalized technology from MyDell. Following are the key features of MyDell:</p> <ul style="list-style-type: none"> ● Application ● Audio ● Power ● Color and Display ● Presence detection <p>For more information about how to use MyDell, see product guides at www.dell.com/support.</p>
	<p>Dell Update</p> <p>Updates your computer with critical fixes and latest device drivers as they become available. For more information about using Dell Update, see the product guides and third-party license documents at www.dell.com/support.</p>
	<p>Dell Digital Delivery</p> <p>Download software applications, which are purchased but not preinstalled on your computer. For more information about using Dell Digital Delivery, search in the Knowledge Base Resource at www.dell.com/support.</p>
	<p>SupportAssist</p> <p>SupportAssist proactively and predictively identifies hardware and software issues on your computer and automates the engagement process with Dell Technical support. It addresses performance and stabilization issues, prevents security threats, monitors, and detects hardware failures. For more information, see <i>SupportAssist for Home PCs User's Guide</i> at www.dell.com/support/home/product-support/product/dell-supportassist-pcs-tablets/docs.</p> <p> NOTE: In SupportAssist, click the warranty expiry date to renew or upgrade your warranty.</p>

Specifications of XPS 14 9440

Dimensions and weight

The following table lists the height, width, depth, and weight of your XPS 14 9440.

Table 2. Dimensions and weight

Description	Values
Height:	
Front height	6.70 mm (0.26 in.)
Rear height	18.03 mm (0.71 in.)
Width	320 mm (12.59 in.)
Depth	215.98 mm (8.50 in.)
Weight  NOTE: The weight of your computer depends on the configuration that is ordered and manufacturing variability.	<ul style="list-style-type: none"> • 1.68 kg (3.70 lb) - minimum • 1.80 kg (3.97 lb) - maximum

Processor

The following table lists the details of the processors that are supported for your XPS 14 9440.

Table 3. Processor

Description	Option one	Option two
Processor type	Intel Core Ultra 7 155H	Intel Core Ultra 7 165H
Processor wattage	28 W	28 W
Processor total core count	16	16
Performance-cores	6	6
Efficient-cores	8	8
Processor total thread counts	22	22
 NOTE: Intel Hyper-Threading Technology is only available on Performance-cores.		
Processor speed	Up to 4.80 GHz	Up to 5 GHz
Performance-cores frequency		
Processor base frequency	1.40 GHz	1.40 GHz
Maximum turbo frequency	4.80 GHz	5 GHz
Efficient-cores frequency		
Processor base frequency	0.90 GHz	0.90 GHz
Maximum turbo frequency	3.80 GHz	3.80 GHz
Processor cache	24 MB	24 MB
Integrated graphics	Intel Arc Graphics	Intel Arc Graphics

Chipset

The following table lists the details of the chipset that is supported for your XPS 14 9440.

Table 4. Chipset

Description	Values
Chipset	Integrated in the processor
Processor	<ul style="list-style-type: none"> Intel Core Ultra 7 155H Intel Core Ultra 7 165H
DRAM bus width	64-bit x 2
Flash EPROM	64 MB
PCIe bus	Up to Gen4

Operating system

Your XPS 14 9440 supports the following operating systems:

- Windows 11 Pro
- Windows 11 Home

Memory

The following table lists the memory specifications of your XPS 14 9440.

Table 5. Memory specifications

Description	Values
Memory slots	Dual-channel on-board memory i NOTE: The memory is integrated on the system board and is not upgradeable.
Memory type	LPDDR5X
Memory speed	<ul style="list-style-type: none"> • 6400 MT/s: For computers shipped with integrated graphics card • 7467 MT/s: For computers shipped with discrete graphics card
Maximum memory configuration	64 GB
Minimum memory configuration	16 GB
Memory configurations supported	For computers shipped with integrated graphics card: <ul style="list-style-type: none"> • 16 GB LPDDR5X at 6400 MT/s • 32 GB LPDDR5X at 6400 MT/s For computers shipped with discrete graphics card: <ul style="list-style-type: none"> • 16 GB LPDDR5X at 7467 MT/s • 32 GB LPDDR5X at 7467 MT/s • 64 GB LPDDR5X at 7467 MT/s



External ports

The following table lists the external ports on your XPS 14 9440.

Table 6. External ports

Description	Values
USB ports	Three Thunderbolt 4 USB Type-C ports with Power Delivery and DisplayPort i NOTE: Connect the USB Type-C power adapter to only one of the three USB Type-C ports. i NOTE: You can connect a Dell Docking Station to this port. For more information, search in the Knowledge Base Resource at www.dell.com/support .
Audio port	<ul style="list-style-type: none"> • Three Thunderbolt 4 USB Type-C ports with Power Delivery and DisplayPort • One headset (headphone and microphone combo) port
Video port/ports	Three Thunderbolt 4 USB Type-C ports with Power Delivery and DisplayPort

Table 6. External ports (continued)

Description	Values
	 NOTE: A USB-C to DisplayPort adapter (sold separately) is required to connect a DisplayPort device.
Media-card reader	One microSD-card slot v6.0
Power-adaptor port	DC-IN through one of the three Thunderbolt 4 USB Type-C ports  NOTE: You can connect a Dell Docking Station to this port. For more information, see the knowledge base article 000124295 at www.dell.com/support .
Security-cable slot	Not supported

Internal slots

The following table lists the internal slots of your XPS 14 9440.

Table 7. Internal slots

Description	Values
M.2	One M.2 slot for M.2 2230 or M.2 2280 solid-state drive  NOTE: To learn more about the features of different types of M.2 cards, search in the Knowledge Base Resource at www.dell.com/support .

Wireless module

The following table lists the Wireless Local Area Network (WLAN) module that is supported on your XPS 14 9440.

Table 8. Wireless module specifications

Description	Values
Model number	Intel Killer 1675 (AX211)
Transfer rate	Up to 2400 Mbps
Frequency bands supported	2.4 GHz/5 GHz/6 GHz
Wireless standards	<ul style="list-style-type: none"> ● WiFi 802.11a/b/g ● Wi-Fi 4 (WiFi 802.11n) ● Wi-Fi 5 (WiFi 802.11ac) ● Wi-Fi 6E (WiFi 802.11ax)
Encryption	<ul style="list-style-type: none"> ● 64-bit/128-bit WEP ● AES-CCMP ● TKIP
Bluetooth wireless card	Bluetooth 5.3
	 NOTE: The version of the Bluetooth wireless card may vary depending on the operating system that is installed on your computer.

Audio

The following table lists the audio specifications of your XPS 14 9440.

Table 9. Audio specifications

Description	Values
Audio controller	CirrusLogic CS42L43
Stereo conversion	Supported
Internal audio interface	SoundWire interface
External audio interface	Three Thunderbolt 4 USB Type-C ports with Power Delivery and DisplayPort
Number of speakers	Two tweeter speakers
Internal-speaker amplifier	Not supported
External volume controls	Keyboard shortcut controls
Speaker output:	
Average speaker output	2 W x 2
Peak speaker output	2 W x 2
Subwoofer output	Not supported
Microphone	Dual digital-array microphones

Storage

This section lists the storage options on your XPS 14 9440.

Your XPS 14 9440 supports one M.2 2230 or M.2 2280 solid-state drive.

Table 10. Storage specifications

Storage type	Interface type	Capacity
M.2 2230 solid-state drive	PCIe Gen4 NVMe	512 GB
M.2 2280 solid-state drive	PCIe Gen4 NVMe	Up to 4 TB

Media-card reader

The following table lists the media cards that are supported on your XPS 14 9440.

Table 11. Media-card reader specifications

Description	Values
Media-card type	One microSD card slot v6.0
Media-cards supported	<ul style="list-style-type: none">microSecure Digital (mSD)microSecure Digital High Capacity (mSDHC)

Table 11. Media-card reader specifications (continued)

Description	Values
	<ul style="list-style-type: none"> microSecure Digital Extended Capacity (mSDXC)
<p>NOTE: The maximum capacity supported by the media-card reader varies depending on the standard of the media card that is installed on your computer.</p>	

Keyboard

The following table lists the keyboard specifications of your XPS 14 9440.

Table 12. Keyboard specifications

Description	Values
Keyboard type	Backlit keyboard
Keyboard layout	QWERTY
Number of keys	<ul style="list-style-type: none"> Arabic, English International, Canada (Bilingual) (MUI), English US, Hebrew, Korean: 64 keys English UK, French (European), Czech/Slovakian (MUI), German, Hungarian, Italian, Nordic (MUI), Spanish (Latin America), Swiss European (MUI), Turkish, Portuguese Iberian, Spanish (Castillian): 65 keys Japanese: 68 keys
Keyboard size	<p>X= 19.05 mm key pitch</p> <p>Y=18.05 mm key pitch</p>
Keyboard shortcuts	<p>Some keys on your keyboard have two symbols on them. These keys can be used to type alternate characters or to perform secondary functions. To type the alternate character, press Shift and the desired key. To perform secondary functions, press Fn and the desired key.</p> <p>NOTE: You can define the primary behavior of the function keys (F1–F12) changing Function Key Behavior in BIOS setup program.</p> <p>For more information, see Keyboard shortcuts.</p>

Keyboard shortcuts of XPS 14 9440

NOTE: Keyboard characters may differ depending on the keyboard language configuration. Keys that are used for shortcuts remain the same across all language configurations.

Some keys on your keyboard have two symbols on them. These keys can be used to type alternative characters or to perform secondary functions. The symbol that is shown on the lower part of the key refers to the character that is typed out when the key is pressed. If you press **shift** and the key, the symbol that is shown on the upper part of the key is typed out. For example, if you press **2**, **2** is typed out; if you press **Shift + 2**, **@** is typed out.

The top row of the keyboard is a capacitive touch panel. The **fn** mechanical key toggles between the keys **F1-F12** and keys for multimedia control. Releasing the **fn** key switches back to the previous mode.

Pressing the **fn** key and the **esc** key locks the "mode" of the capacitive touch panel. If the computer restarts, the default mode is the last mode set by the user before the computer is restarted.

The **fn** key is also used with selected keys on the keyboard to invoke other secondary functions.

Table 13. List of keyboard shortcuts

Keyboard shortcut	Behavior
fn	Switch between modes of the capacitive touch panel
fn + B	Pause
fn + S	Toggle scroll lock
fn + R	System request
fn + ctrl + B	Break
fn + esc	Lock the mode of the capacitive touch panel
fn + left arrow	Home
fn + right arrow	End
Copilot	Launch Copilot in Windows NOTE: If Copilot in Windows is not available on your computer, the Copilot key launches Windows Search. For more information about Copilot in Windows, search in the Knowledge Base Resource at www.dell.com/support .

Camera

The following table lists the camera specifications of your XPS 14 9440.

Table 14. Camera specifications

Description	Values
Number of cameras	Two
Camera type	FHD RGB-IR camera
Camera location	Front
Camera sensor type	CMOS sensor technology
Camera resolution:	
Still image	2.07 megapixels
Video	1920 x 1080 at 30 fps
Infrared camera resolution:	
Still image	0.23 megapixels
Video	640 x 360 at 15 fps
Diagonal viewing angle:	
Camera	81.3 degrees
Infrared camera	78.1 degrees

Touchpad

The following table lists the touchpad specifications of your XPS 14 9440.

Table 15. Touchpad specifications

Description	Values
Touchpad resolution:	> 300 DPI
Touchpad dimensions:	
Horizontal	149 mm (5.87 in.)
Vertical	74 mm (2.91 in.)
Touchpad gestures	For more information about touchpad gestures available on Windows, see the Microsoft Knowledge Base article at support.microsoft.com .

Power adapter

The following table lists the power adapter specifications of your XPS 14 9440.

Table 16. Power adapter specifications

Description	Option one	Option two
Type	60 W AC small form factor	100 W AC small form factor
Power-adapter dimensions:		
Height	22 mm (0.86 in.)	26.50 mm (1.04 in.)
Width	55 mm (2.16 in.)	60 mm (2.36 in.)
Depth	66 mm (2.59 in.)	122 mm (4.80 in.)
Input voltage	100 VAC–240 VAC	100 VAC–240 VAC
Input frequency	50 Hz–60 Hz	50 Hz–60 Hz
Input current (maximum)	1.70 A	1.70 A
Output current (continuous)	<ul style="list-style-type: none"> • 20 V/3 A (continuous) • 15 V/3 A (continuous) • 9 V/3 A (continuous) • 5 V/3 A (continuous) 	<ul style="list-style-type: none"> • 20 V/5 A (continuous) • 15 V/3 A (continuous) • 9 V/3 A (continuous) • 5 V/3 A (continuous)
Rated output voltage	<ul style="list-style-type: none"> • 20 VDC • 15 VDC • 9 VDC • 5 VDC 	<ul style="list-style-type: none"> • 20 VDC • 15 VDC • 9 VDC • 5 VDC
Temperature range:		
Operating	0°C to 40°C (32°F to 104°F)	0°C to 40°C (32°F to 104°F)
Storage	-20°C to 70°C (-4°F to 158°F)	-40°C to 70°C (-40°F to 158°F)



Table 16. Power adapter specifications (continued)

Description	Option one	Option two
 CAUTION: Operating and storage temperature ranges may differ among components, so operating or storing the device outside these ranges may impact the performance of specific components.		

Battery

The following table lists the battery specifications of your XPS 14 9440.

Table 17. Battery specifications

Description	Values	
Battery type	6-cell lithium-ion polymer 70 Wh	
Battery voltage	11.70 VDC	
Battery weight (maximum)	0.27 kg (0.59 lb)	
Battery dimensions:		
	Height	6.75 mm (0.27 in.)
	Width	268.70 mm (10.58 in.)
	Depth	73 mm (2.87 in.)
Temperature range:		
	Operating	<ul style="list-style-type: none"> Charge: 0°C to 45°C (32°F to 113°F) Discharge: 0°C to 70°C (32°F to 158°F)
	Storage	-20°C to 65°C (-4°F to 149°F)
Battery operating time	Varies depending on operating conditions and can significantly reduce under certain power-intensive conditions.	
Battery charging time (approximate)	<ul style="list-style-type: none"> Standard charge: Charge from 0% to 80% within 4 hours Express charge: Charge from 0% to 80% within 1 hour, charge from 0% to 100% within 2 hours 	
 NOTE: Control the charging time, duration, start and end time, and so on, using the Dell Power Manager application. For more information about Dell Power Manager, search in the Knowledge Base Resource at www.dell.com/support .		
Coin-cell battery	Not supported	
 CAUTION: Operating and storage temperature ranges may differ among components, so operating or storing the device outside these ranges may impact the performance of specific components.		
 CAUTION: Dell Technologies recommends that you charge the battery regularly for optimal power consumption. If your battery charge is depleted, connect the power adapter, turn on your computer, and then restart your computer to reduce the power consumption.		

Display

The following table lists the display specifications of your XPS 14 9440.

Table 18. Display specifications

Description		Option one	Option two
Display type		14.5-inch 3.2K Organic Light Emitting Diode (OLED), Low Blue Light	14.5-inch White Light Emitting Diode (WLED), Full High Definition (FHD+), Low Blue Light
Touch options		Yes	No
Display-panel technology		Active Matrix Organic Light Emitting Diode (AMOLED)	In-Plane Switching (IPS)
Display-panel dimensions (active area):			
	Height	312.19 mm (12.29 in.)	312.19 mm (12.29 in.)
	Width	195.12 mm (7.68 in.)	195.12 mm (7.68 in.)
	Diagonal	14.50 mm (0.57 in.)	14.50 mm (0.57 in.)
Display-panel native resolution		3200 x 2000	1920 x 1200
Luminance (typical)		400 nits	500 nits
Megapixels		6.40	2.304
Color gamut		100% DCI-P3	100% sRGB
Pixels Per Inch (PPI)		260	156
Contrast ratio (minimum)		1000000:1	2000:1
Response time (maximum)		1 ms	24 ms
Refresh rate		48 Hz to 120 Hz	30 Hz to 120 Hz
Horizontal view angle		+/- 85 degrees	+/- 85 degrees
Vertical view angle		+/- 85 degrees	+/- 85 degrees
Pixel pitch		0.0976 mm	0.1626 mm
Power consumption (maximum)		9.32 W	2.39 W
Anti-glare vs glossy finish		Anti-reflective	Anti-glare

Fingerprint reader

The following table lists the fingerprint-reader specifications of your XPS 14 9440.

 **NOTE:** The fingerprint reader is on the power button.

Table 19. Fingerprint reader specifications

Description	Values
Fingerprint-reader sensor technology	Capacitive
Fingerprint-reader sensor resolution	500 dpi
Fingerprint-reader sensor pixel size	108 x 88

GPU—Integrated

The following table lists the specifications of the integrated Graphics Processing Unit (GPU) supported by your XPS 14 9440.

Table 20. GPU—Integrated

Controller	Memory size	Processor
Intel Arc Graphics	Shared system memory	<ul style="list-style-type: none">• Intel Core Ultra 7 155H• Intel Core Ultra 7 165H

GPU—Discrete

The following table lists the specifications of the discrete Graphics Processing Unit (GPU) supported by your XPS 14 9440.

Table 21. GPU—Discrete

Controller	Memory size	Memory type
NVIDIA GeForce RTX 4050	6 GB	GDDR6

External display support

The following table lists the external display support for your XPS 14 9440.

Table 22. External display support

Graphics card	Supported external displays with laptop display enabled	Supported external displays with laptop display disabled
Intel Arc Graphics	3	4

 **NOTE:** For more information about external display support, see the *External Display Connection Guide* on www.dell.com/support.

Operating and storage environment

This table lists the operating and storage specifications of your XPS 14 9440.

Airborne contaminant level: G1 as defined by ISA-S71.04-1985

Table 23. Computer environment

Description	Operating	Storage
Temperature range	0°C to 35°C (32°F to 95°F)	-40°C to 65°C (-40°F to 149°F)
Relative humidity (maximum)	10% to 90% (non-condensing)	0% to 95% (non-condensing)

Table 23. Computer environment (continued)

Description	Operating	Storage
Vibration (maximum)*	0.66 GRMS	1.30 GRMS
Shock (maximum)	110 G†	160 G†
Altitude range	-15.2 m to 3048 m (-49.87 ft to 10000 ft)	-15.2 m to 10668 m (-49.87 ft to 35000 ft)
 CAUTION: Operating and storage temperature ranges may differ among components, so operating or storing the device outside these ranges may impact the performance of specific components.		

* Measured using a random vibration spectrum that simulates the user environment.

† Measured using a 2 ms half-sine pulse.

Dell support policy

For information about Dell support policy, search in the Knowledge Base Resource at www.dell.com/support.

Dell low blue light display

 **WARNING: Prolonged exposure to blue light from the display may lead to long-term effects such as eye strain, eye fatigue, or damage to the eyes.**

Blue light is a color in the light spectrum which has a short wavelength and high energy. Chronic exposure to blue light, particularly from digital sources may disrupt sleep patterns and cause long-term effects such as eye strain, eye fatigue, or damage to the eyes.

The display on this computer is designed to minimize blue light and complies with TÜV Rheinland's requirement for low blue light displays.

Low blue light mode is enabled at the factory, so no further configuration is necessary.











To reduce the risk of eye strain, it is also recommended that you:

- Position the display at a comfortable viewing distance between 20 and 28 inches (50 cm and 70 cm) from your eyes.
- Blink frequently to moisten your eyes, wet your eyes with water, or apply suitable eye drops.
- Look away from your display, and gaze at a distant object at 20 ft (609.60 cm) away for at least 20 seconds during each break.
- Take an extended break for 20 minutes every two hours.

Working inside your computer



Safety instructions

Use the following safety guidelines to protect your computer from potential damage and to ensure your personal safety. Unless otherwise noted, each procedure in this document assumes that you have read the safety information that shipped with your computer.

-  **WARNING:** Before working inside your computer, read the safety information that is shipped with your computer. For more safety best practices, see the Regulatory Compliance home page at www.dell.com/regulatory_compliance.
-  **WARNING:** Disconnect your computer from all power sources before opening the computer cover or panels. After you finish working inside the computer, replace all covers, panels, and screws before connecting your computer to an electrical outlet.
-  **CAUTION:** To avoid damaging the computer, ensure that the work surface is flat, dry, and clean.
-  **CAUTION:** To avoid damaging the components and cards, handle them by their edges, and avoid touching the pins and the contacts.
-  **CAUTION:** You should only perform troubleshooting and repairs as authorized or directed by the Dell technical assistance team. Damage due to servicing that is not authorized by Dell is not covered by your warranty. See the safety instructions that is shipped with the product or at www.dell.com/regulatory_compliance.
-  **CAUTION:** Before touching anything inside your computer, ground yourself by touching an unpainted metal surface, such as the metal at the back of the computer. While you work, periodically touch an unpainted metal surface to dissipate static electricity which could harm internal components.
-  **CAUTION:** When you disconnect a cable, pull it by its connector or its pull tab, not the cable itself. Some cables have connectors with locking tabs or thumbscrews that you must disengage before disconnecting the cable. When disconnecting cables, keep them evenly aligned to avoid bending the connector pins. When connecting cables, ensure that the ports and the connectors are correctly oriented and aligned.
-  **CAUTION:** Press and eject any installed card from the media-card reader.
-  **CAUTION:** Exercise caution when handling rechargeable Li-ion batteries in laptops. Swollen batteries should not be used and should be replaced and disposed properly.
-  **NOTE:** The color of your computer and certain components may differ from what is shown in this document.

Before working inside your computer

Steps

1. Save and close all open files and exit all open applications.
2. Shut down your computer. For Windows operating system, click **Start** >  **Power** > **Shut down**.
 -  **NOTE:** If you are using a different operating system, see the documentation of your operating system for shut-down instructions.
3. Disconnect your computer and all attached devices from their electrical outlets.
4. Disconnect all attached network devices and peripherals, such as keyboard, mouse, and monitor from your computer.

5. Remove any media card and optical disk from your computer, if applicable.
6. Enter the service mode, if you can turn on your computer.

Service Mode

Service Mode is used to cut off power, without disconnecting the battery cable from the system board prior to conducting repairs in the computer.

 **CAUTION:** If you are unable to turn on the computer to put it into Service Mode, or the computer does not support Service Mode, proceed to disconnect the battery cable. To disconnect the battery cable, follow the steps in [Removing the battery](#).

 **NOTE:** Ensure that your computer is shut down and the AC adapter is disconnected.

- a. Hold the **** key on the keyboard and press the power button for 3 seconds or until the Dell logo appears on the screen.
- b. Press any key to continue.
- c. If the AC adapter is not disconnected, a message prompting you to remove the AC adapter appears on the screen. Remove the AC adapter and then press any key to continue the **Service Mode** process. The **Service Mode** process automatically skips the following step if the **Owner Tag** of the computer is not set up in advance by the user.
- d. When the **ready-to-proceed** message appears on the screen, press any key to proceed. The computer emits three short beeps and shuts down immediately.
- e. Once the computer shuts down, it has successfully entered Service Mode.

 **NOTE:** If you are unable to turn on your computer or unable to enter Service Mode, skip this process.

Safety precautions

The safety precautions chapter details the primary steps to be taken before performing any disassembly instructions.

Observe the following safety precautions before you perform any installation or break-fix procedures involving disassembly or reassembly:

- Turn off the computer and all attached peripherals.
- Disconnect the computer and all attached peripherals from AC power.
- Disconnect all network cables, telephone, and telecommunications lines from the computer.
- Use an ESD field service kit when working inside any to avoid electrostatic discharge (ESD) damage.
- After removing any computer component, carefully place the removed component on an anti-static mat.
- Wear shoes with non-conductive rubber soles to reduce the chance of getting electrocuted.
- Unplugging, pressing, and holding the power button for 15 seconds should discharge residual power in the system board.

Standby power

Dell products with standby power must be unplugged before you open the case. Systems that incorporate standby power are powered while turned off. The internal power enables the computer to be remotely turned on (Wake-on-LAN) and suspended into a sleep mode and has other advanced power management features.

Bonding

Bonding is a method for connecting two or more grounding conductors to the same electrical potential. This is done by using a field service electrostatic discharge (ESD) kit. When connecting a bonding wire, ensure that it is connected to bare metal and never to a painted or nonmetal surface. The wrist strap should be secure and in full contact with your skin, and ensure that you remove all jewelry such as watches, bracelets, or rings prior to bonding yourself and the equipment.

Electrostatic discharge—ESD protection

ESD is a major concern when you handle electronic components, especially sensitive components such as expansion cards, processors, memory modules, and system boards. Slight charges can damage circuits in ways that may not be obvious, such as intermittent problems or a shortened product life span. As the industry pushes for lower power requirements and increased density, ESD protection is an increasing concern.

Due to the increased density of semiconductors used in recent Dell products, the sensitivity to static damage is now higher than in previous Dell products. For this reason, some previously approved methods of handling parts are no longer applicable.

Two recognized types of ESD damage are catastrophic and intermittent failures.

- **Catastrophic** – Catastrophic failures represent approximately 20 percent of ESD-related failures. The damage causes an immediate and complete loss of device functionality. An example of catastrophic failure is a memory DIMM that has received a static shock and immediately generates a "No POST/No Video" symptom with a beep code that is emitted for missing or nonfunctional memory.
- **Intermittent** – Intermittent failures represent approximately 80 percent of ESD-related failures. The high rate of intermittent failures means that most of the time when damage occurs, it is not immediately recognizable. The DIMM receives a static shock, but the tracing is merely weakened and does not immediately produce outward symptoms that are related to the damage. The weakened trace may take weeks or months to melt, and in the meantime may cause degradation of memory integrity, intermittent memory errors, and so on.

The more difficult type of damage to recognize and troubleshoot is the intermittent (also called latent or "walking wounded") failure.

Perform the following steps to prevent ESD damage:

- Use a wired ESD wrist strap that is properly grounded. Wireless anti-static straps do not provide adequate protection. Touching the chassis before handling parts does not ensure adequate ESD protection on parts with increased sensitivity to ESD damage.
- Handle all static-sensitive components in a static-safe area. If possible, use anti-static floor pads and workbench pads.
- When unpacking a static-sensitive component from its shipping carton, do not remove the component from the anti-static packing material until you are ready to install the component. Before unwrapping the anti-static packaging, ensure that you discharge static electricity from your body.
- Before transporting a static-sensitive component, place it in an anti-static container or packaging.

ESD Field Service kit

The unmonitored Field Service kit is the most commonly used service kit. Each Field Service kit includes three main components: anti-static mat, wrist strap, and bonding wire.

Components of an ESD field service kit

The components of an ESD field service kit are:

- **Anti-Static Mat** – The anti-static mat is dissipative and parts can be placed on it during service procedures. When using an anti-static mat, your wrist strap should be snug and the bonding wire should be connected to the mat and to any bare metal on the computer being worked on. Once deployed properly, service parts can be removed from the ESD bag and placed directly on the mat. ESD-sensitive items are safe in your hand, on the ESD mat, in the computer, or inside an ESD bag.
- **Wrist Strap and Bonding Wire** – The wrist strap and bonding wire can be either directly connected between your wrist and bare metal on the hardware if the ESD mat is not required, or connected to the anti-static mat to protect hardware that is temporarily placed on the mat. The physical connection of the wrist strap and bonding wire between your skin, the ESD mat, and the hardware is known as bonding. Use only Field Service kits with a wrist strap, mat, and bonding wire. Never use wireless wrist straps. Always be aware that the internal wires of a wrist strap are prone to damage from normal wear and tear, and must be checked regularly with a wrist strap tester in order to avoid accidental ESD hardware damage. It is recommended to test the wrist strap and bonding wire at least once per week.
- **ESD Wrist Strap Tester** – The wires inside an ESD strap are prone to damage over time. When using an unmonitored kit, it is a best practice to regularly test the strap prior to each service call, and at a minimum, test once per week. A wrist strap tester is the best method for doing this test. If you do not have your own wrist strap tester, check with your regional office to find out if they have one. To perform the test, plug the bonding-wire of wrist-strap into the tester while it is strapped to your wrist and push the button to test. A green LED is lit if the test is successful; a red LED is lit and an alarm sounds if the test fails.
- **Insulator Elements** – It is critical to keep ESD sensitive devices, such as plastic heat sink casings, away from internal parts that are insulators and often highly charged.
- **Working Environment** – Before deploying the ESD Field Service kit, assess the situation at the customer location. For example, deploying the kit for a server environment is different than for a desktop or laptop environment. Servers are typically installed in a rack within a data center; desktops or laptops are typically placed on office desks or cubicles. Always look for a large open flat work area that is free of clutter and large enough to deploy the ESD kit with additional space to accommodate the type of computer that is being repaired. The workspace should also be free of insulators that can cause an ESD event. On the work area, insulators such as Styrofoam and other plastics should always be moved at least 12 inches or 30 centimeters away from sensitive parts before physically handling any hardware components.

- **ESD Packaging** – All ESD-sensitive devices must be shipped and received in static-safe packaging. Metal, static-shielded bags are preferred. However, you should always return the damaged part using the same ESD bag and packaging that the new part arrived in. The ESD bag should be folded over and taped shut and all the same foam packing material should be used in the original box that the new part arrived in. ESD-sensitive devices should be removed from packaging only at an ESD-protected work surface, and parts should never be placed on top of the ESD bag because only the inside of the bag is shielded. Always place parts in your hand, on the ESD mat, in the computer, or inside an anti-static bag.
- **Transporting Sensitive Components** – When transporting ESD sensitive components such as replacement parts or parts to be returned to Dell, it is critical to place these parts in anti-static bags for safe transport.

ESD protection summary

It is recommended to always use the traditional wired ESD grounding wrist strap and protective anti-static mat when servicing Dell products. In addition, it is critical to keep sensitive parts separate from all insulator parts while performing service and use anti-static bags for transporting sensitive components.

Transporting sensitive components

When transporting ESD sensitive components such as replacement parts or parts to be returned to Dell, it is critical to place these parts in anti-static bags for safe transport.

After working inside your computer

About this task

 **CAUTION:** Leaving stray or loose screws inside your computer may severely damage your computer.

Steps

1. Replace all screws and ensure that no stray screws remain inside your computer.
2. Connect any external devices, peripherals, or cables you removed before working on your computer.
3. Replace any media cards, discs, or any other parts that you removed before working on your computer.
4. Connect your computer and all attached devices to their electrical outlets.
 -  **NOTE:** To exit service mode, ensure to connect the AC adapter to the power-adapter port on your computer.
5. Press the power button to turn on the computer. Your computer will automatically return to normal functioning mode.

Recommended tools

The procedures in this document may require the following tools:

- Phillips screwdriver #0
- Torx #5 (T5) screwdriver
- Plastic scribe

Screw list

















-  **NOTE:** When removing screws from a component, it is recommended to note the screw type, and the quantity of screws, and then place them in a screw storage box. This is to ensure that the correct number of screws and correct screw type is restored when the component is replaced.
-  **NOTE:** Some computers have magnetic surfaces. Ensure that the screws are not left attached to such surfaces when replacing a component.
-  **NOTE:** Screw color may vary with the configuration ordered.

Table 24. Screw list

Component	Screw type	Quantity	Screw image
Base cover	M2x3, Torx 5	8	
Battery	M1.6x3.5	6	
M.2 2230 solid state drive	M2x2.5	1	
M.2 2280 solid state drive	M2x2.5	1	
Left fan	M1.6x3	2	
Right fan	M1.6x3	2	
Display assembly	M1.6x4	2	
Display assembly	M1.6x3.5	2	
Display assembly	M2.5x5.5	6	
System board	M1.6x3.5	11	
Power button with fingerprint reader	M1.4x2	4	
Keyboard	M1.4x1.2	18	
Keyboard	M1.4x1.4	7	

Major components of XPS 14 9440

The following image shows the major components of XPS 14 9440.

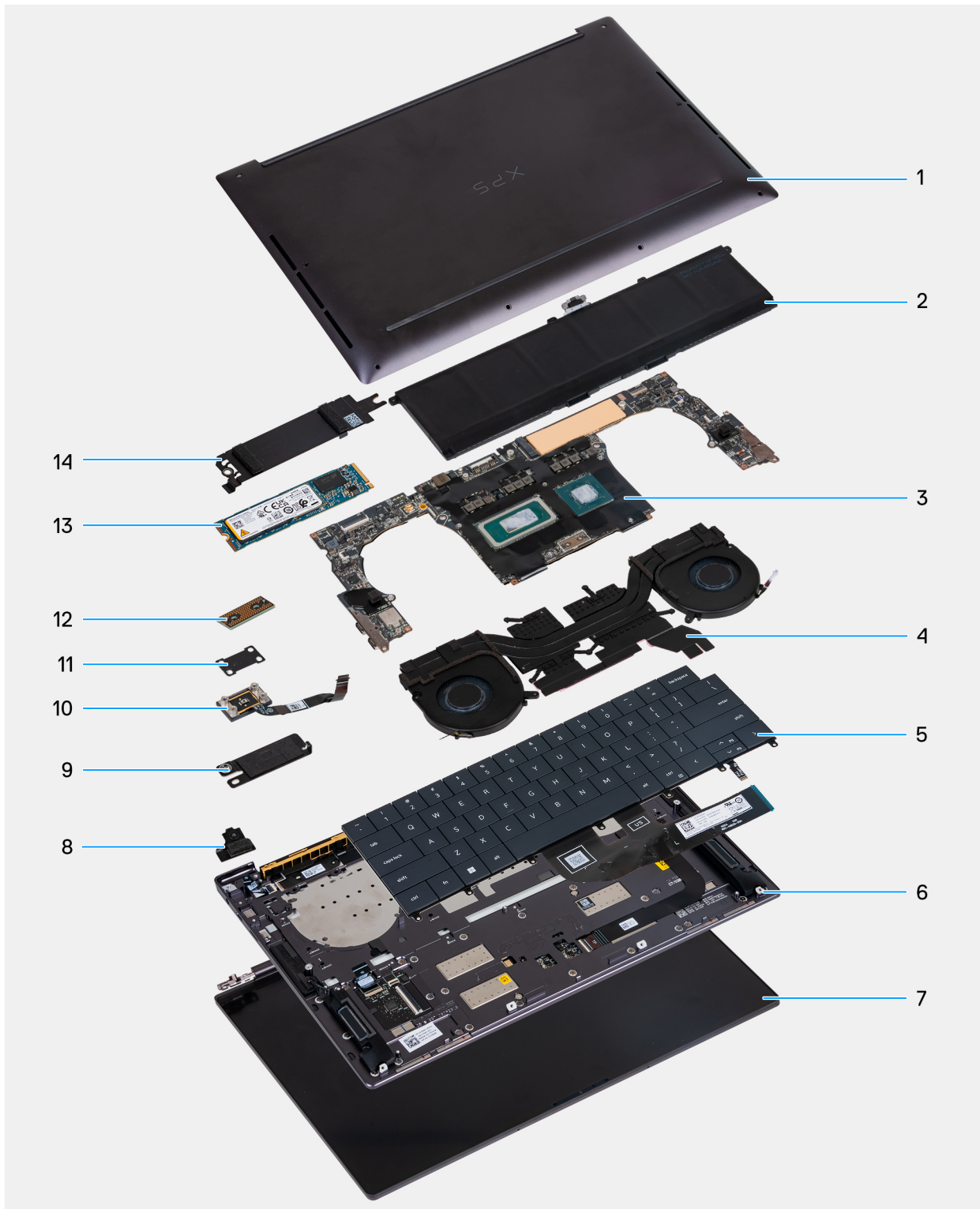





- | | |
|------------------------------|--|
| 1. Base cover | 2. Battery |
| 3. System board | 4. Heat-sink assembly |
| 5. Keyboard | 6. Left speaker |
| 7. Display assembly | 8. Wireless-module bracket |
| 9. Battery connector bracket | 10. Power button with fingerprint reader |
| 11. Power-button bracket | 12. Display cable interposer board |
| 13. M.2 2280 SSD | 14. M.2 SSD thermal shield |

 **NOTE:** Dell provides a list of components and their part numbers for the original computer configuration purchased. These parts are available according to warranty coverage purchased by the customer. Contact your Dell sales representative for purchase options.

Removing and installing Field Replaceable Units (FRUs)

The replaceable components in this chapter are Field Replaceable Units (FRUs).

-  **CAUTION:** The information in this removing and installing FRU's section is intended for authorized service technicians only.
-  **CAUTION:** To avoid any potential damage to the component or loss of data, ensure that an authorized service technician replaces the Field Replaceable Units (FRUs).
-  **CAUTION:** Dell Technologies recommends that this set of repairs, if needed, to be conducted by trained technical repair specialists.
-  **CAUTION:** As a reminder, your warranty does not cover damages that may occur during FRU repairs that are not authorized by Dell Technologies.
-  **NOTE:** The images in this document may differ from your computer depending on the configuration you ordered.



Base cover

Removing the base cover

-  **CAUTION:** The information in this removal section is intended for authorized service technicians only.

Prerequisites

Follow the procedure in [Before working inside your computer](#).

-  **NOTE:** Ensure that your computer is in Service Mode. For more information, see [Before working inside your computer](#).
-  **CAUTION:** If you are unable to turn on the computer, if your computer is unable to enter Service Mode, or the computer does not support Service Mode, go to disconnect the battery cable.

About this task

-  **NOTE:** Before removing the base cover, ensure that there is no microSD card that is installed in the microSD card slot on your computer.

The following images indicate the location of the base cover and provide a visual representation of the removal procedure.



8x
M2x3, T5



1x
M1.6x2



Figure 8. Removing the base cover

Steps

1. Remove the eight screws (M2x3, Torx 5) that secure the base cover to the palm-rest assembly.
NOTE: A Torx #5 (T5) screwdriver is necessary to remove the eight screws (M2x3, Torx 5).
2. Place your thumbs and fingers into the recess at the top edge of the base cover.
3. Use both thumbs to pry the base cover to release it from the palm-rest assembly.



Figure 9. Using both thumbs to pry the base cover

4. Using your hands, pry the base cover from the side of your computer.



Figure 10. Lifting the base cover off the palm-rest assembly

5. Lift the base cover off the palm-rest assembly.

i **NOTE:** Ensure that your computer is in Service Mode. If your computer is unable to enter Service Mode, disconnect the battery cable from the system board. To disconnect the battery cable, follow step 6 to step 8.

6. Loosen the captive screw that secures the battery connector bracket to the palm-rest assembly.
7. Remove the battery connector bracket from the palm-rest assembly.
8. Using the pull tab, disconnect the battery cable from the system board.

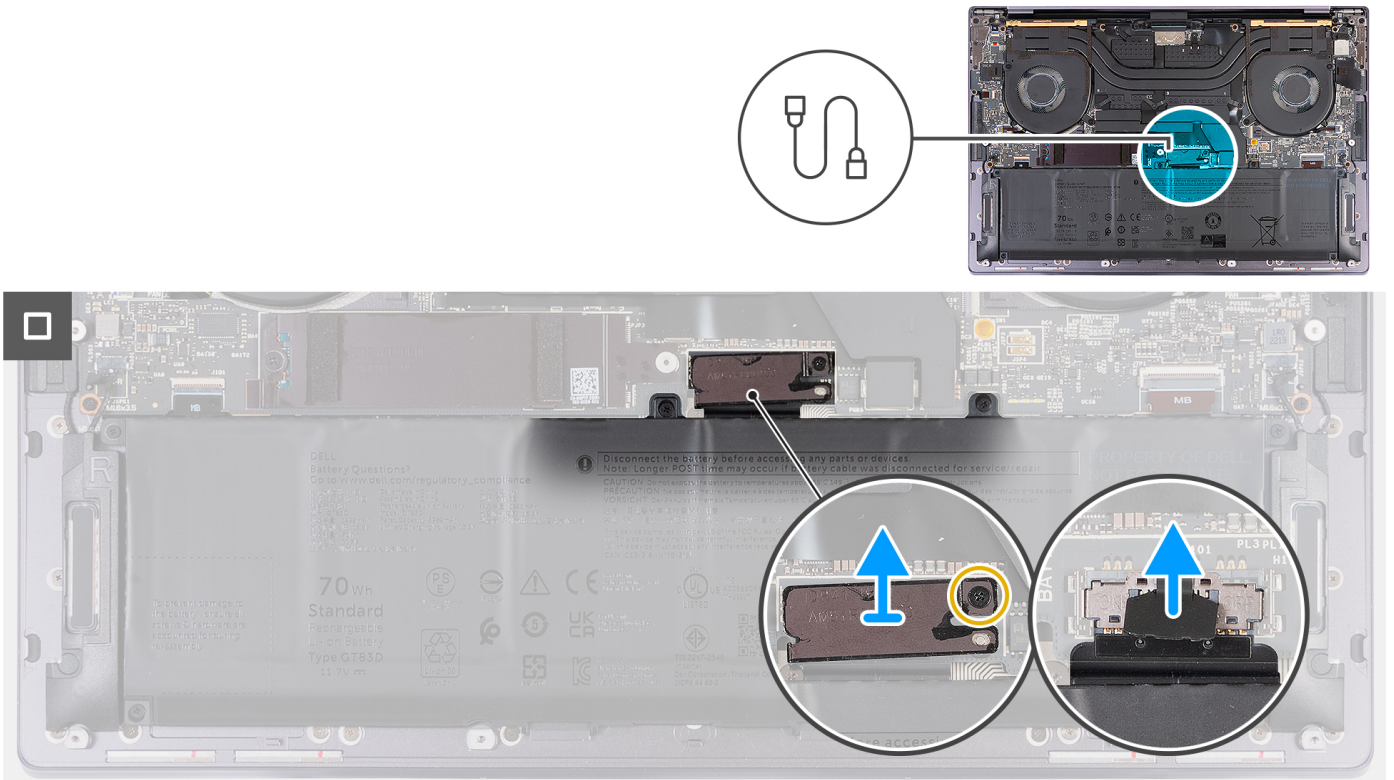

Figure 11. Disconnecting the battery cable from the system board

9. Press and hold the power button for five seconds to ground the computer and drain the flea power.

Installing the base cover

CAUTION: The information in this installation section is intended for authorized service technicians only.

Prerequisites

If you are replacing a component, remove the existing component before performing the installation process.

About this task

The following images indicate the location of the base cover and provide a visual representation of the installation procedure.

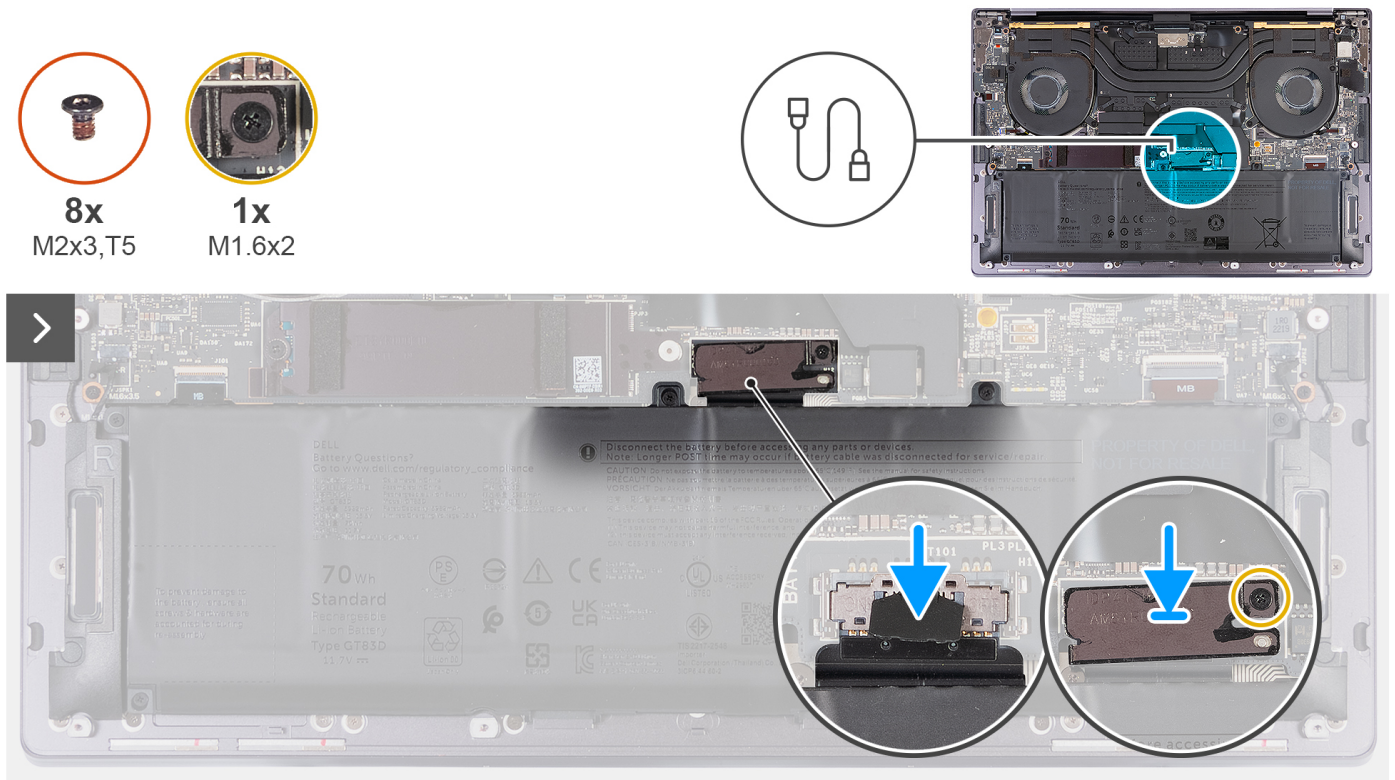

Figure 12. Installing the base cover

i NOTE:

If the battery removal is not a pre-requisite and if you have disconnected the battery cable, ensure to connect the battery cable. To connect the battery cable, follow step 1 to step 3 in the procedure.

Steps

1. Connect the battery cable to the system board.
2. Align and place the battery connector bracket on the palm-rest assembly.
3. Tighten the captive screw that secures the battery connector bracket to the palm-rest assembly.
4. Align and place the base cover into slots on the palm-rest assembly.



Figure 13. Placing the base cover into slots on the palm-rest assembly

5. Align the screw holes on the base cover with the screw holes on the palm-rest assembly before applying slight pressure to the base cover.
6. Snap the base cover into place on the palm-rest assembly.



Figure 14. Snap the base cover into place on the palm-rest assembly

7. Tighten the eight captive screws (M2x3, Torx 5) that secure the base cover to the palm-rest assembly.



Figure 15. Tighten the eight screws that secure the base cover to the palm-rest assembly

Next steps

Follow the procedure in [After working inside your computer](#).

Battery

Rechargeable Li-ion battery precautions

⚠ CAUTION:

- Exercise caution when handling rechargeable Li-ion batteries.
- Discharge the battery completely before removing it. Disconnect the AC power adapter from the computer and operate the computer solely on battery power—the battery is fully discharged when the computer no longer turns on when the power button is pressed.
- Do not crush, drop, mutilate, or penetrate the battery with foreign objects.
- Do not expose the battery to high temperatures, or disassemble battery packs and cells.
- Do not apply pressure to the surface of the battery.
- Do not bend the battery.
- Do not use tools of any kind to pry on or against the battery.

- Ensure any screws during the servicing of this product are not lost or misplaced, to prevent accidental puncture or damage to the battery and other computer components.
- If the battery gets stuck inside your computer as a result of swelling, do not try to release it as puncturing, bending, or crushing a rechargeable Li-ion battery can be dangerous. In such an instance, contact Dell technical support for assistance. See www.dell.com/contactdell.
- Always purchase genuine batteries from www.dell.com or authorized Dell partners and resellers.
- Swollen batteries should not be used and should be replaced and disposed properly. For guidelines on how to handle and replace swollen rechargeable Li-ion batteries, see [Handling swollen rechargeable Li-ion batteries](#).

Removing the battery

 **CAUTION:** The information in this removal section is intended for authorized service technicians only.

Prerequisites

1. Follow the procedure in [Before working inside your computer](#).
2. Remove the [base cover](#).

About this task

 **CAUTION:** Removing the battery resets the BIOS setup settings to default. It is recommended that you note the BIOS setup settings before removing the battery.

The following image indicates the location of the battery and provides a visual representation of the removal procedure.

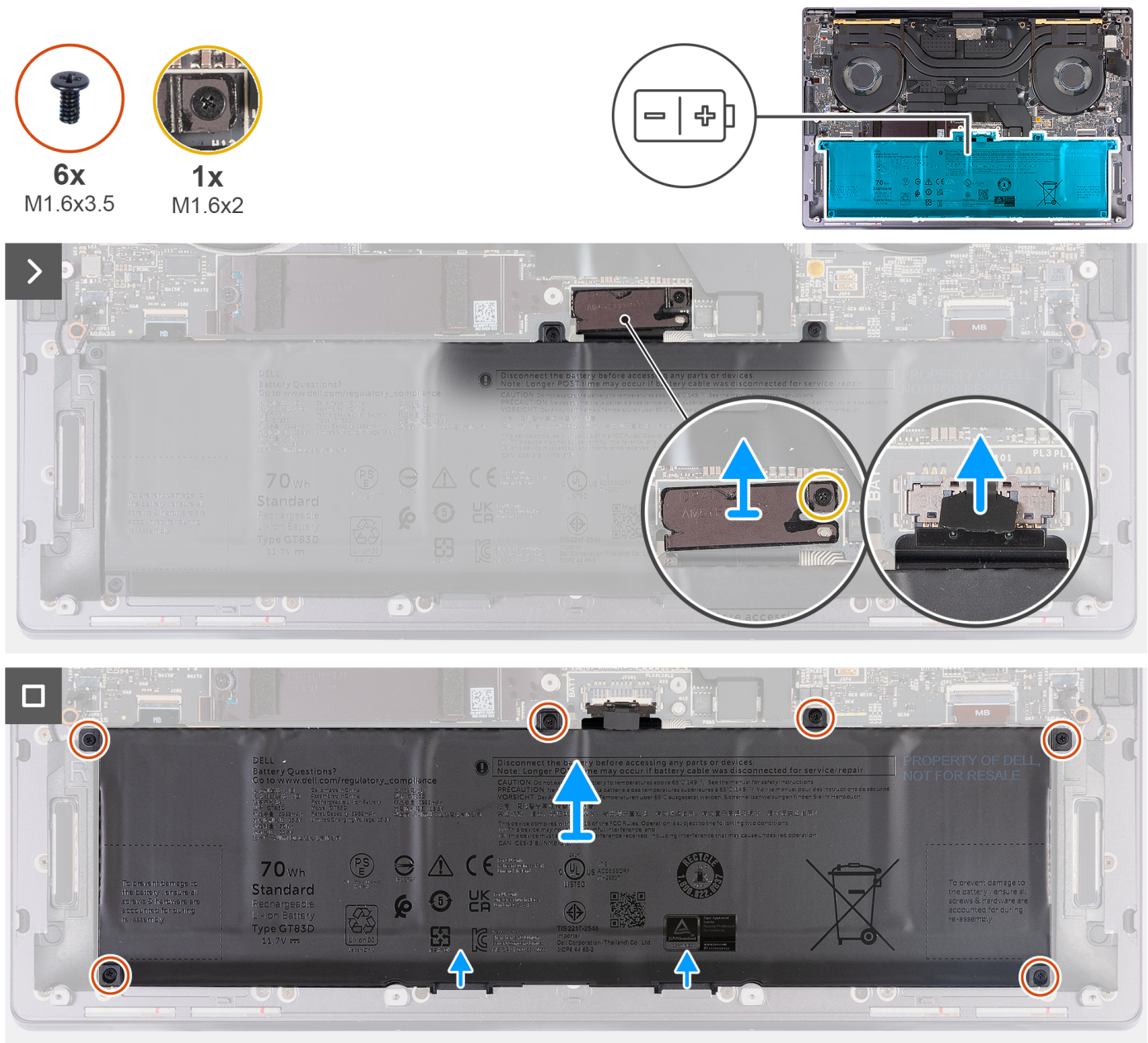

Figure 16. Removing the battery

Steps

1. Loosen the captive screw (M1.6x2) that secures the battery-connector bracket to the palm-rest assembly.
2. Lift the battery-connector bracket off the system board.
3. Using the pull tab, disconnect the battery cable (BATT) from the system board.
4. Remove the six screws (M1.6x3.5) that secure the battery to the palm-rest assembly.
5. Lift the battery off the palm-rest assembly.

Installing the battery

⚠ CAUTION: The information in this installation section is intended for authorized service technicians only.

Prerequisites

If you are replacing a component, remove the existing component before performing the installation process.

About this task

The following image indicates the location of the battery and provides a visual representation of the installation procedure.

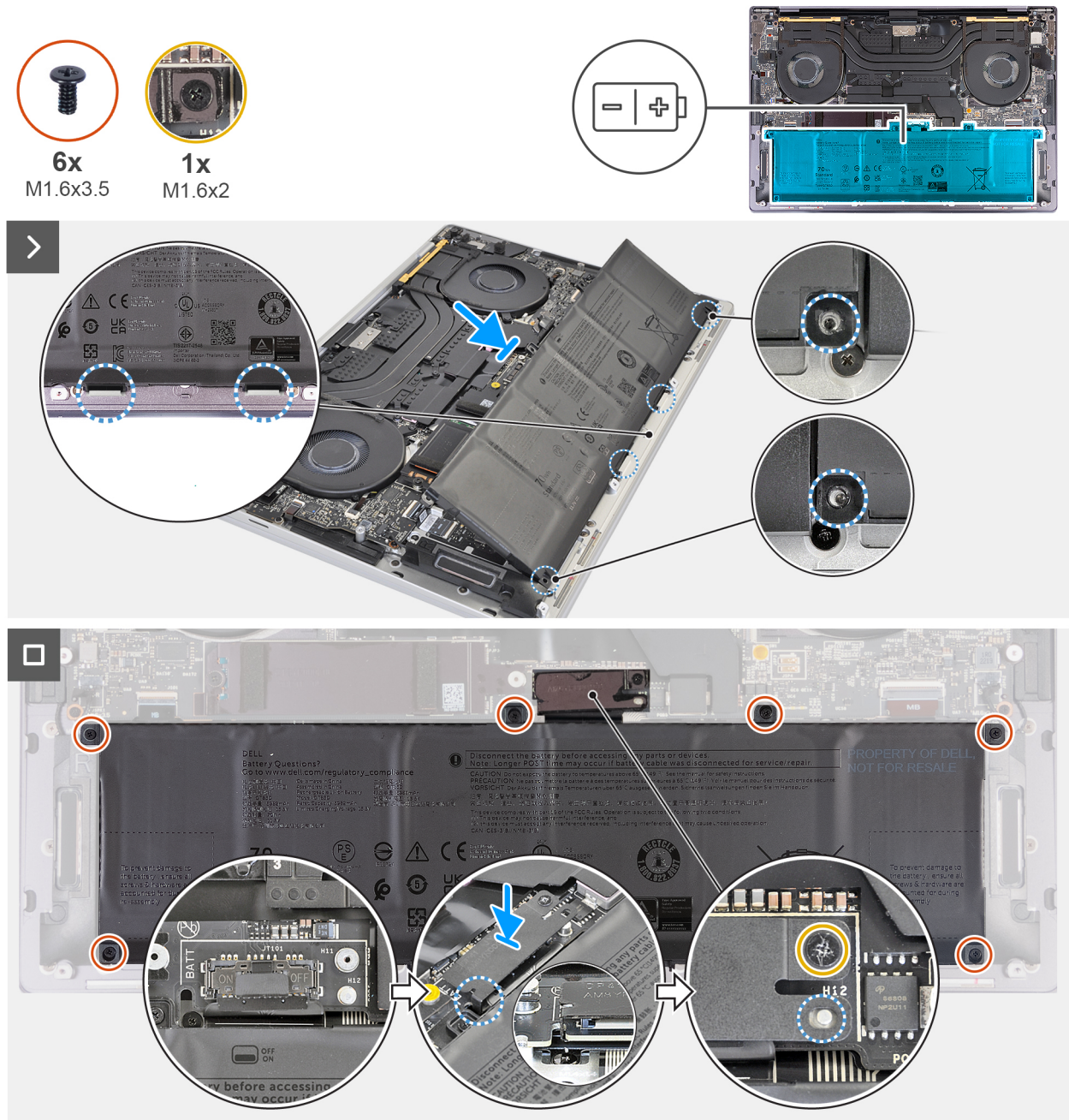

Figure 17. Installing the battery

Steps

1. Align and place the battery edge at an angle so that the tabs on the battery fit into the hooks on the palm-rest assembly.
2. Replace the six screws (M1.6x3.5) that secure the battery to the palm-rest assembly.
3. Connect the battery cable to the system board.
4. Slide the battery-connector bracket to the left of the battery connector. Ensure that the hook at the bottom of the bracket fits into the side of the system board.
5. Align the bracket to the lines marked on the system board.

6. Tighten the captive screw (M1.6x2) ensuring that the positioning stud on the system board fits into the opening on the bracket.

Next steps

1. Install the [base cover](#).
2. Follow the procedure in [After working inside your computer](#).

Solid-state drive

Removing the M.2 2230 solid-state drive (SSD)

CAUTION: The information in this removal section is intended for authorized service technicians only.

Prerequisites

1. Follow the procedure in [Before working inside your computer](#).
2. Remove the [base cover](#).

About this task

NOTE: Depending on the configuration ordered, your computer may support an M.2 2230 SSD or an M.2 2280 SSD.

NOTE: This procedure applies only to computers shipped with an M.2 2230 SSD.

The following image indicates the location of the M.2 2230 SSD and provides a visual representation of the removal procedure.



1x
M2x2.5

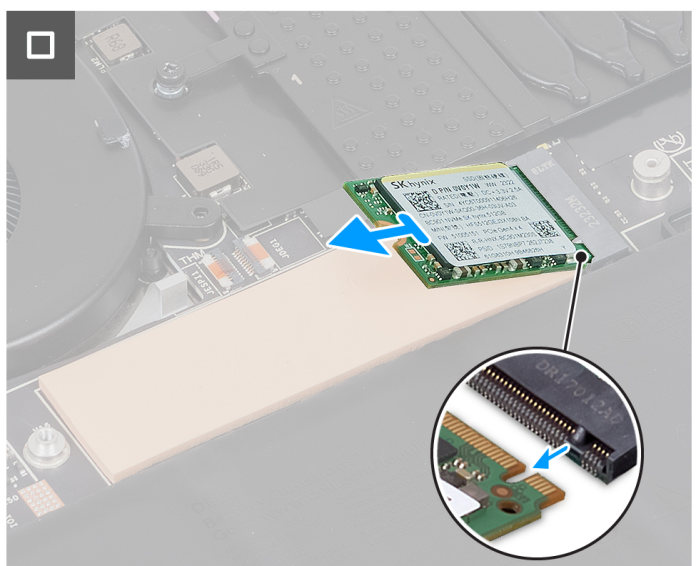
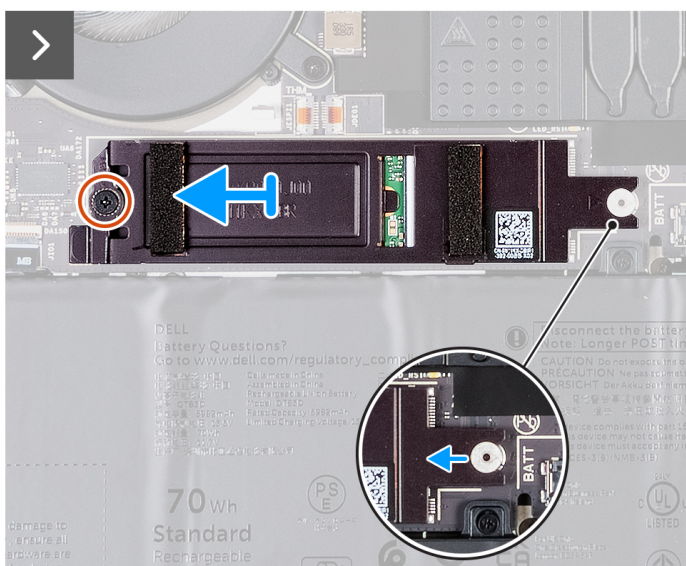
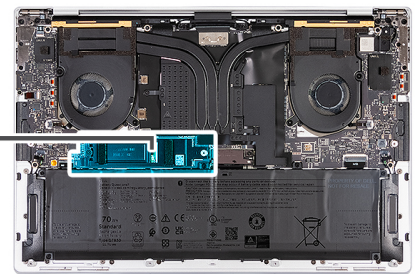

Steps

1. Remove the screw (M2x2.5) that secures the M.2 SSD thermal shield to the system board.

- Slide and remove the M.2 SSD thermal shield off the system board.
- Lift and slide the M.2 2230 SSD out of the SSD slot.

i **NOTE:** XPS 14 9440 has a thermal pad adhered to the system board under the M.2 SSD. The thermal pad may get separated from the system board or get adhered to the SSD. Adhere the thermal pad to the SSD compartment if it is detached from the system board during the removal process.

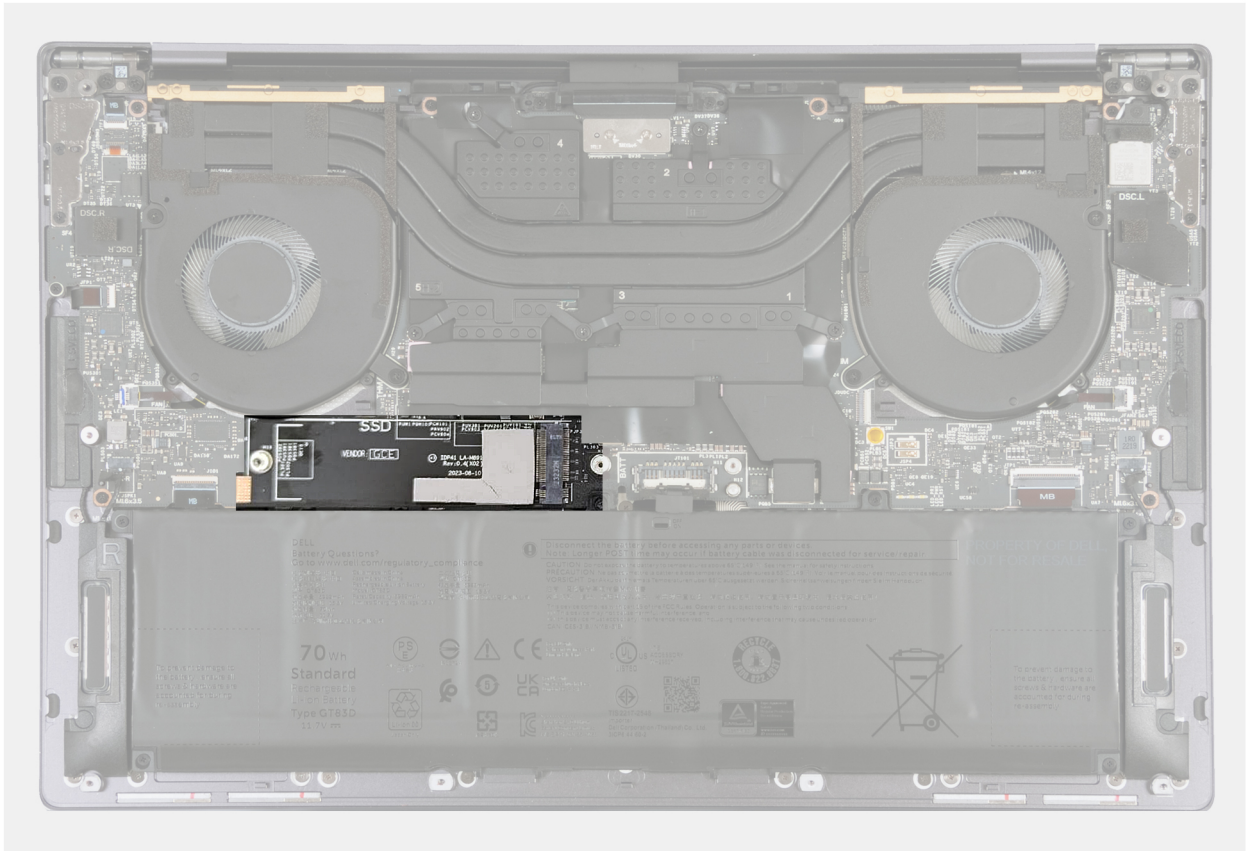

Figure 18. M.2 SSD thermal pad

Installing the M.2 2230 solid-state drive (SSD)

⚠ CAUTION: The information in this installation section is intended for authorized service technicians only.

Prerequisites

If you are replacing a component, remove the existing component before performing the installation process.

About this task

The following image indicates the location of the M.2 2230 SSD and provides a visual representation of the installation procedure.

i **NOTE:** XPS 14 9440 consists of a thermal pad adhered to the system board under the M.2 SSD. The thermal pad may get separated from the system board or get adhered to the SSD. Adhere the thermal pad to the SSD compartment if it is detached from the system board during the removal process.

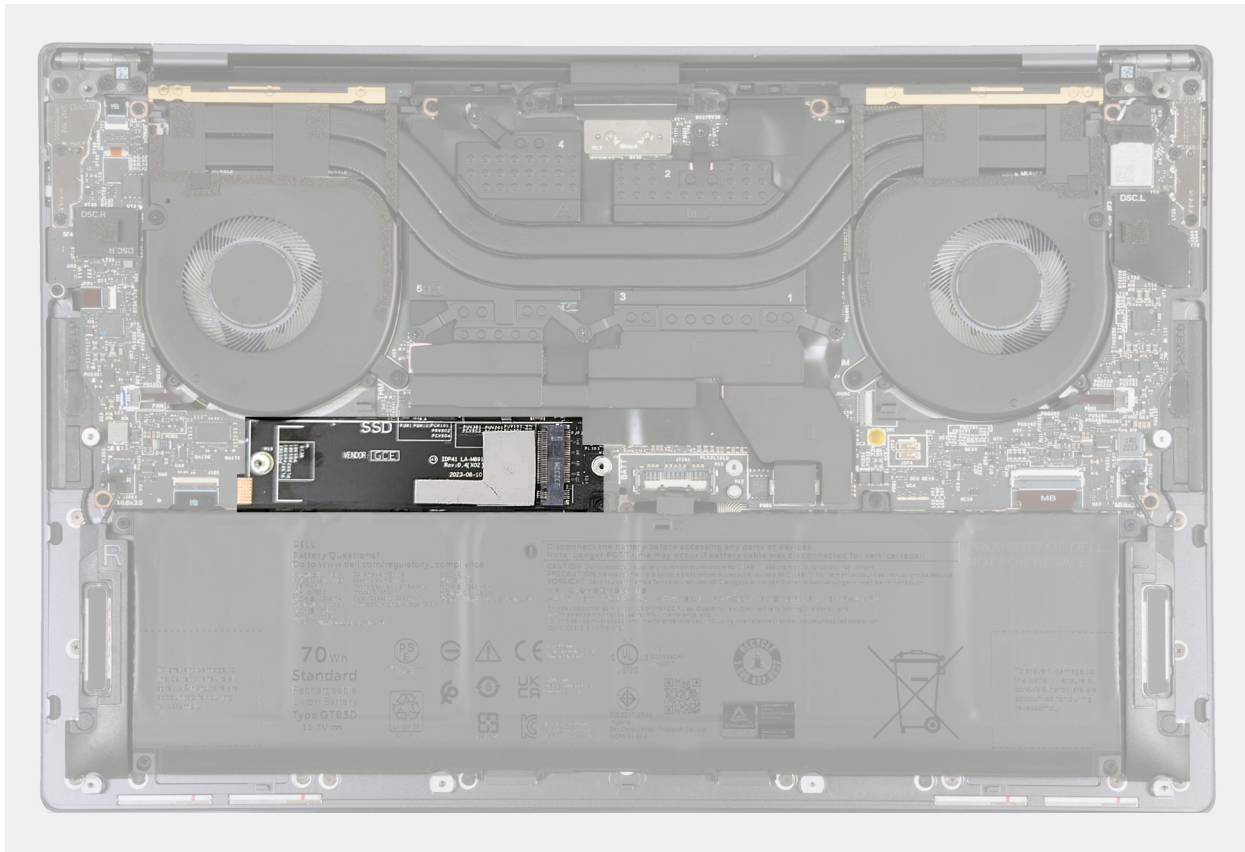

Figure 19. M.2 SSD thermal pad



1x
M2x2.5

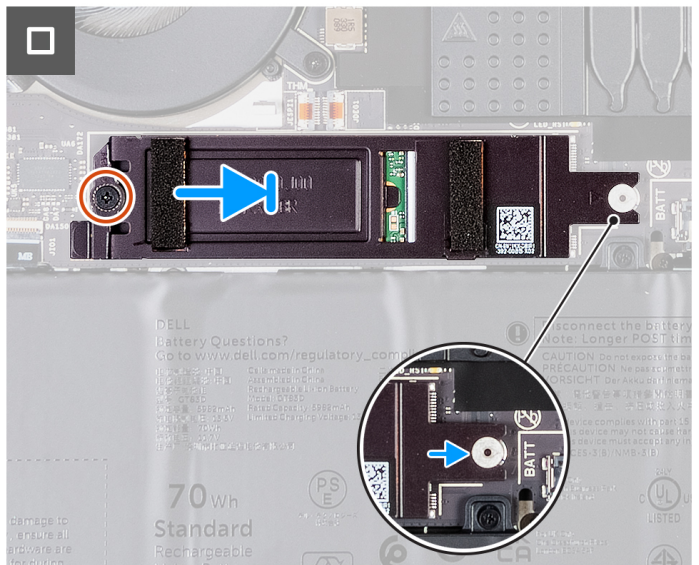
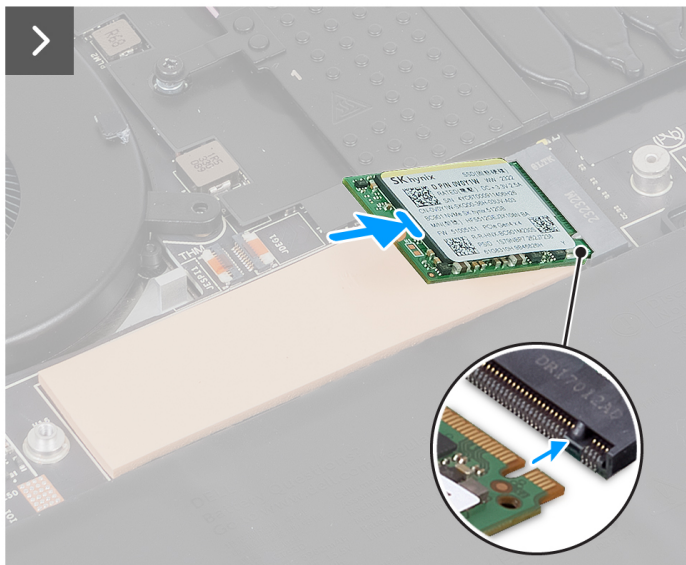
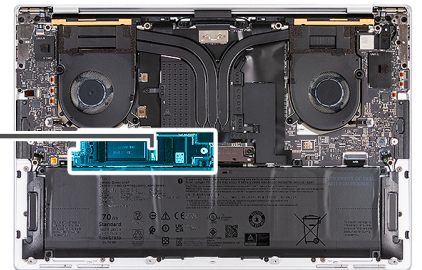

Figure 20. Installing the M.2 2230 solid-state drive

Steps

1. Adhere the M.2 SSD thermal pad if it is detached from the system board during the removal process.
2. Align the notch on the M.2 2230 SSD with the tab on the SSD slot.
3. Slide and place the M.2 2230 SSD on the thermal pad in the SSD slot.
4. Insert the tab of the M.2 SSD shield into the peg on the system board.
5. Replace the screw (M2x2.5) that secures the M.2 SSD shield to the system board.

Next steps

1. Install the [base cover](#).
2. Follow the procedure in [After working inside your computer](#).

Removing the M.2 2280 solid-state drive (SSD)

CAUTION: The information in this removal section is intended for authorized service technicians only.

Prerequisites

1. Follow the procedure in [Before working inside your computer](#).
2. Remove the [base cover](#).

About this task

NOTE: Depending on the configuration ordered, your computer may support an M.2 2280 SSD or an M.2 2280 SSD.

NOTE: This procedure applies only to computers shipped with an M.2 2280 SSD.

The following image indicates the location of the M.2 2280 SSD and provides a visual representation of the removal procedure.

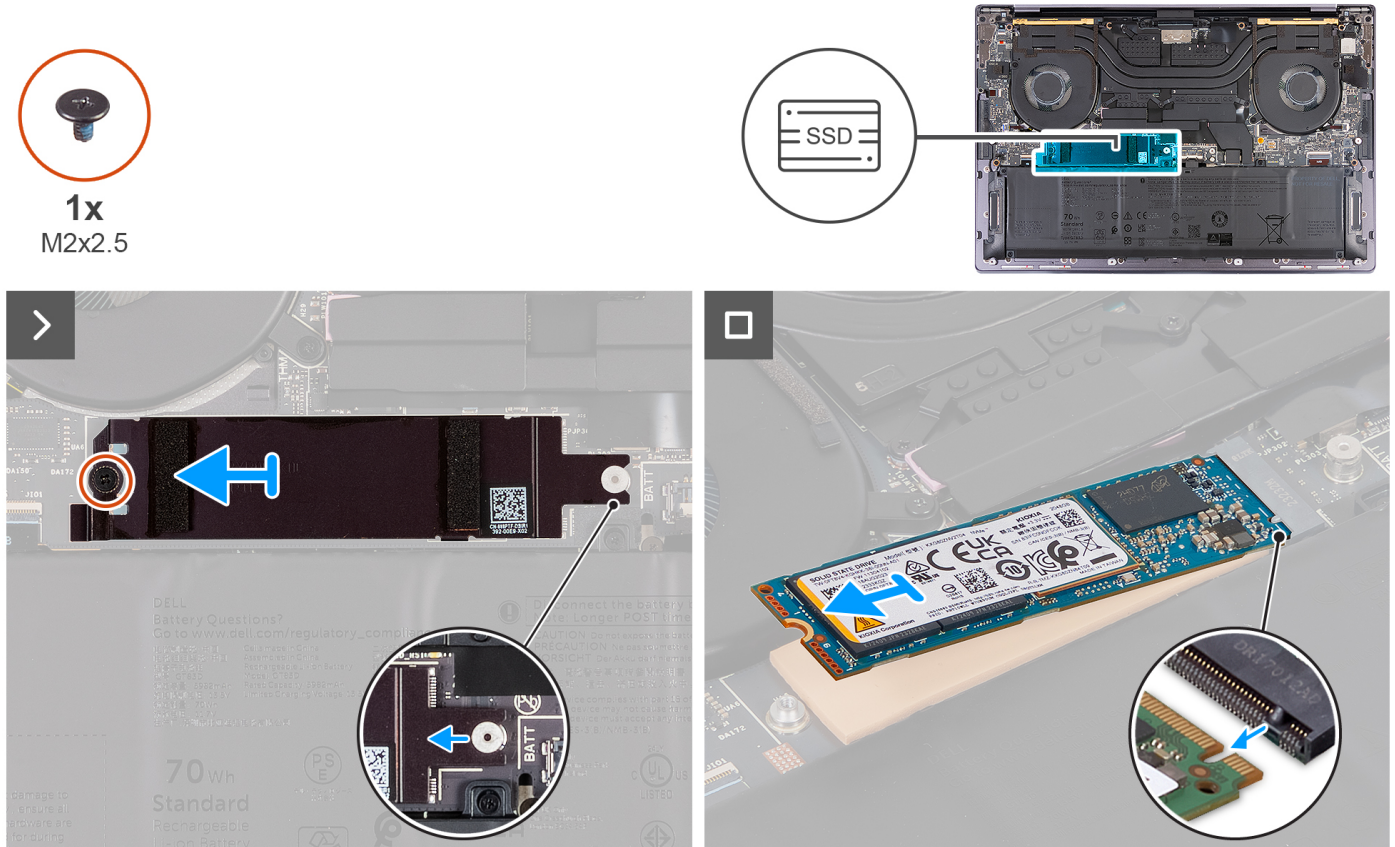

Figure 21. Removing the M.2 2280 solid-state drive

Steps

1. Remove the screw (M2x2.5) that secures the M.2 SSD thermal shield to the system board.
2. Slide and remove the M.2 SSD thermal shield off the system board.
3. Lift and slide the M.2 2280 SSD out of the SSD slot.

NOTE: XPS 14 9440 consists of a thermal pad adhered to the system board under the M.2 SSD. The thermal pad may get separated from the system board or get adhered to the SSD. Adhere the thermal pad to the SSD compartment if it is detached from the system board during the removal process.

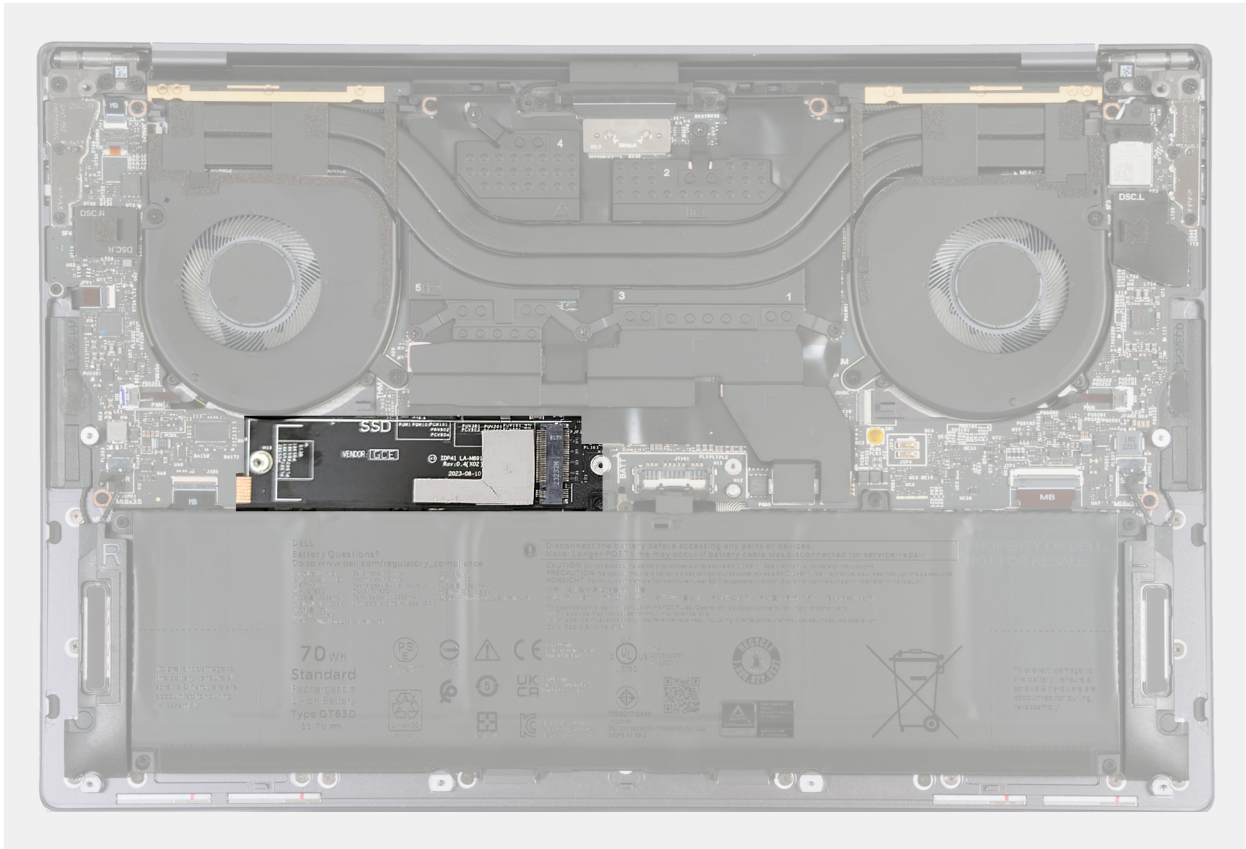

Figure 22. M.2 SSD thermal pad

Installing the M.2 2280 solid-state drive (SSD)

CAUTION: The information in this installation section is intended for authorized service technicians only.

Prerequisites

If you are replacing a component, remove the existing component before performing the installation process.

About this task

NOTE: Depending on the configuration ordered, your computer may support an M.2 2280 SSD or an M.2 2280 SSD.

NOTE: This procedure applies only to computers shipped with an M.2 2280 SSD.

The following image indicates the location of the M.2 2280 SSD and provides a visual representation of the installation procedure.

NOTE: XPS 14 9440 consists of a thermal pad adhered to the system board under the M.2 SSD. The thermal pad may get separated from the system board or get adhered to the SSD. Adhere the thermal pad to the SSD compartment if it is detached from the system board during the removal process.

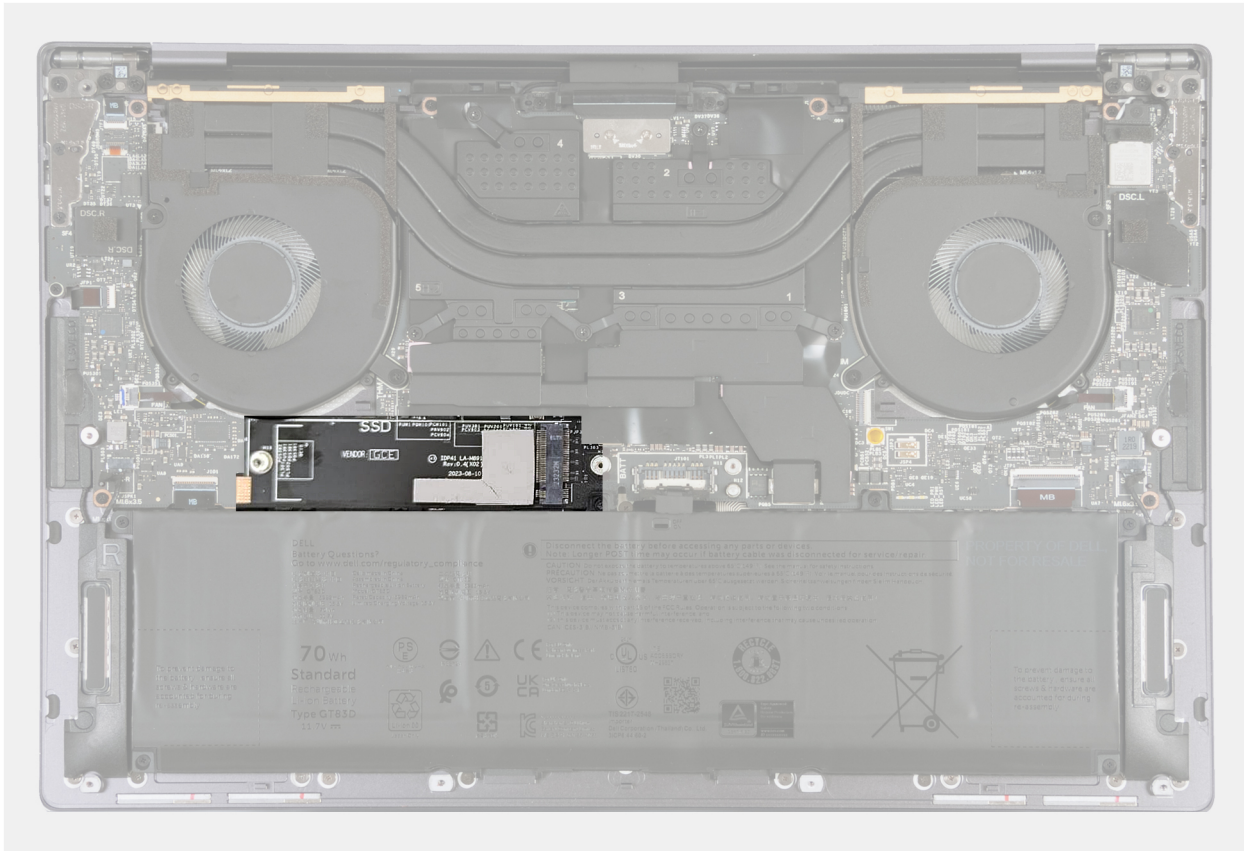
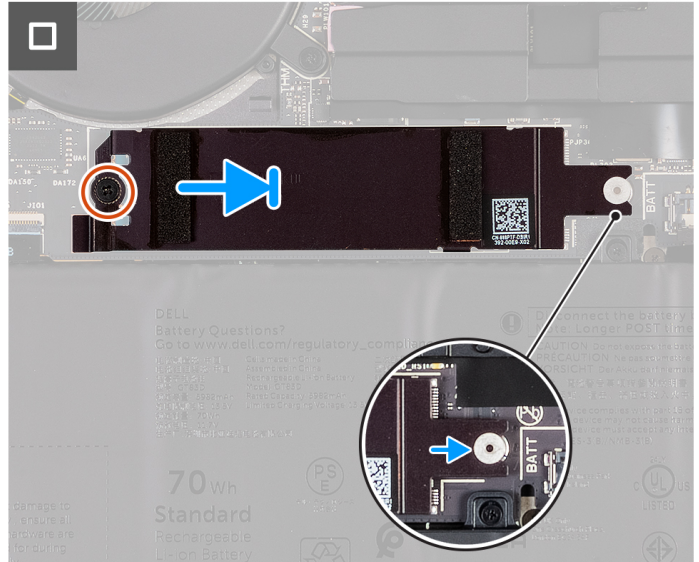
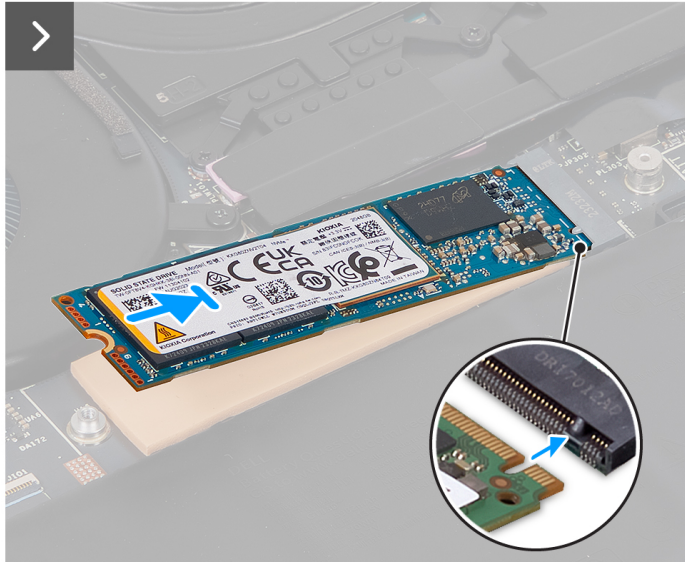
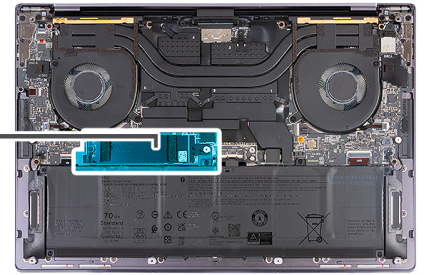

Figure 23. M.2 SSD thermal pad



1x
M2x2.5



Steps

1. Adhere the M.2 SSD thermal pad if it is detached from the system board during the removal process.
2. Align the notch on the M.2 2280 SSD with the tab on the SSD slot.
3. Slide and place the M.2 2280 SSD on the thermal pad in the SSD slot.
4. Insert the tab of the M.2 SSD shield into the peg on the system board.
5. Replace the screw (M2x2.5) that secures the M.2 SSD shield to the system board.

Next steps

1. Install the [base cover](#).
2. Follow the procedure in [After working inside your computer](#).

Heat-sink assembly

Removing the heat-sink assembly - for computers shipped with an integrated graphics card

 **CAUTION:** The information in this removal section is intended for authorized service technicians only.

Prerequisites

1. Follow the procedure in [Before working inside your computer](#).
2. Remove the [base cover](#).

About this task

CAUTION: The heat-sink assembly may become hot during normal operation. Allow sufficient time for the heat-sink assembly to cool before you touch it.

NOTE: For maximum cooling of the processor, do not touch the heat transfer areas on the heat-sink assembly. The oils in your skin can reduce the heat transfer capability of the thermal grease.

The following image indicates the location of the heat-sink assembly and provides a visual representation of the removal procedure.

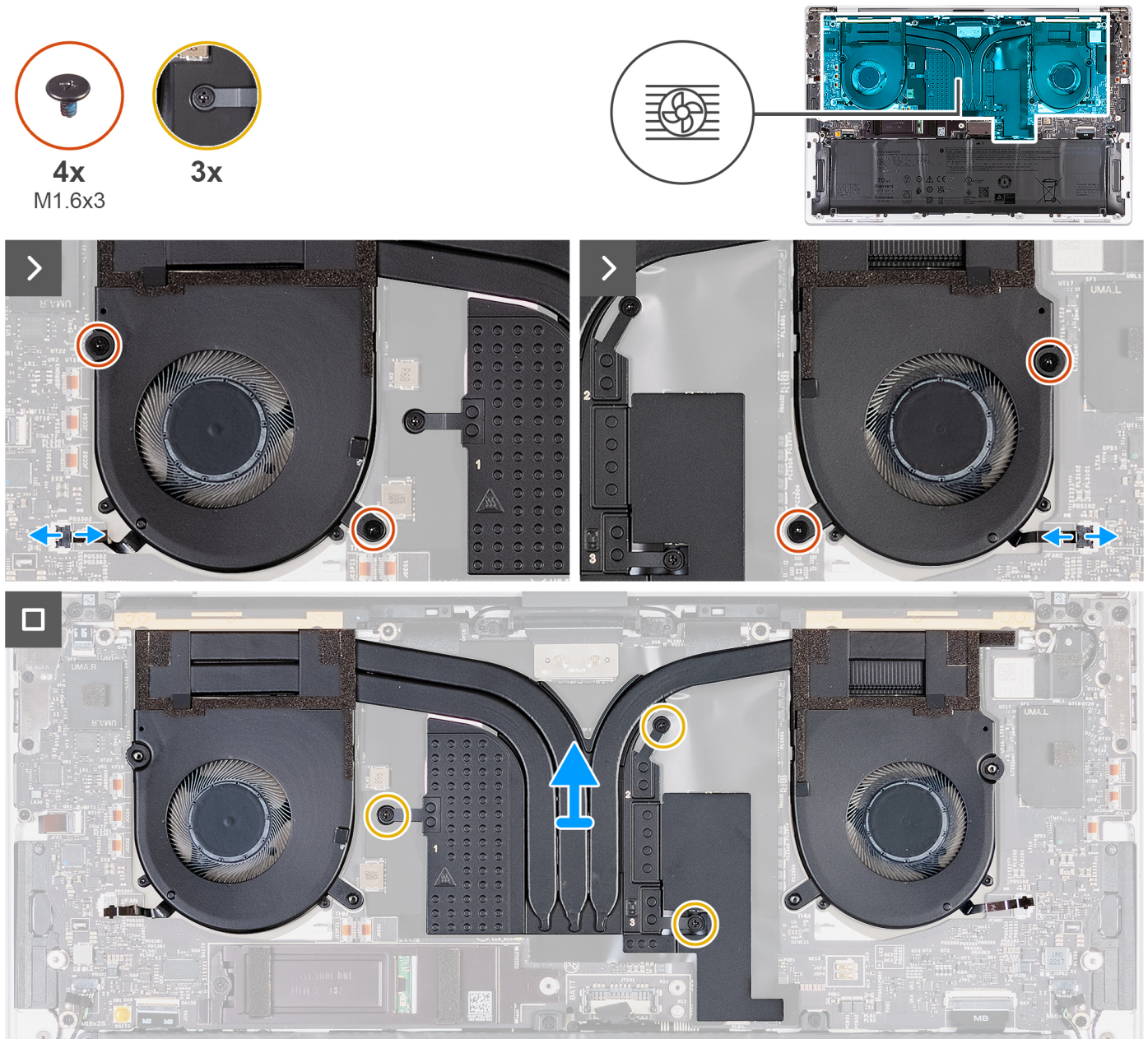

Steps

1. Disconnect the left fan cable (JFAN1) and right fan cable (JFAN2) from the system board.
2. Remove the four screws (M1.6x3) that secure the left and right fans to the palm-rest assembly.
3. In reverse sequential order (3>2>1), loosen the three captive screws that secure the heat-sink assembly to the system board.
4. Lift the heat-sink assembly off the system board.

Installing the heat sink - for computers shipped with an integrated graphics card

 **CAUTION:** The information in this installation section is intended for authorized service technicians only.

Prerequisites

If you are replacing a component, remove the existing component before performing the installation process.

About this task

 **NOTE:** Incorrect alignment of the heat-sink assembly can damage the system board and processor.

 **NOTE:** If the system board or the heat-sink assembly is replaced, use the thermal grease that is provided in the kit to ensure that the thermal conductivity is achieved.

The following image indicates the location of the heat-sink assembly and provides a visual representation of the installation procedure.



4x
M1.6x3



3x

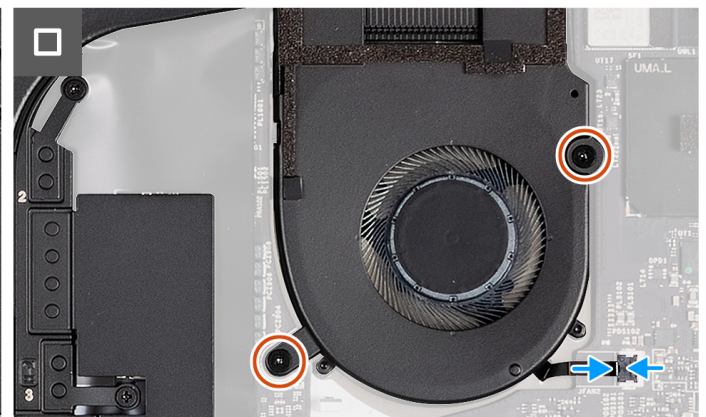
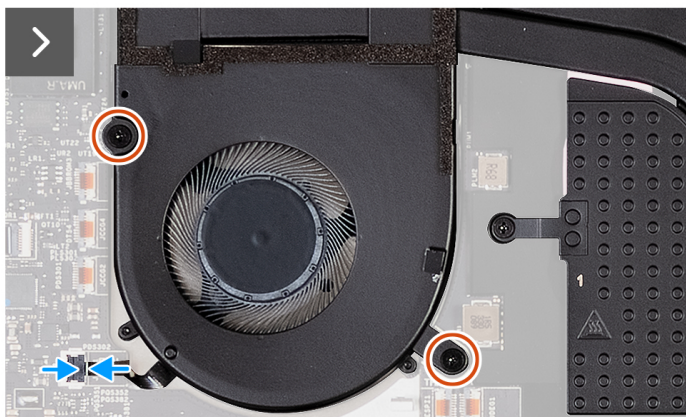
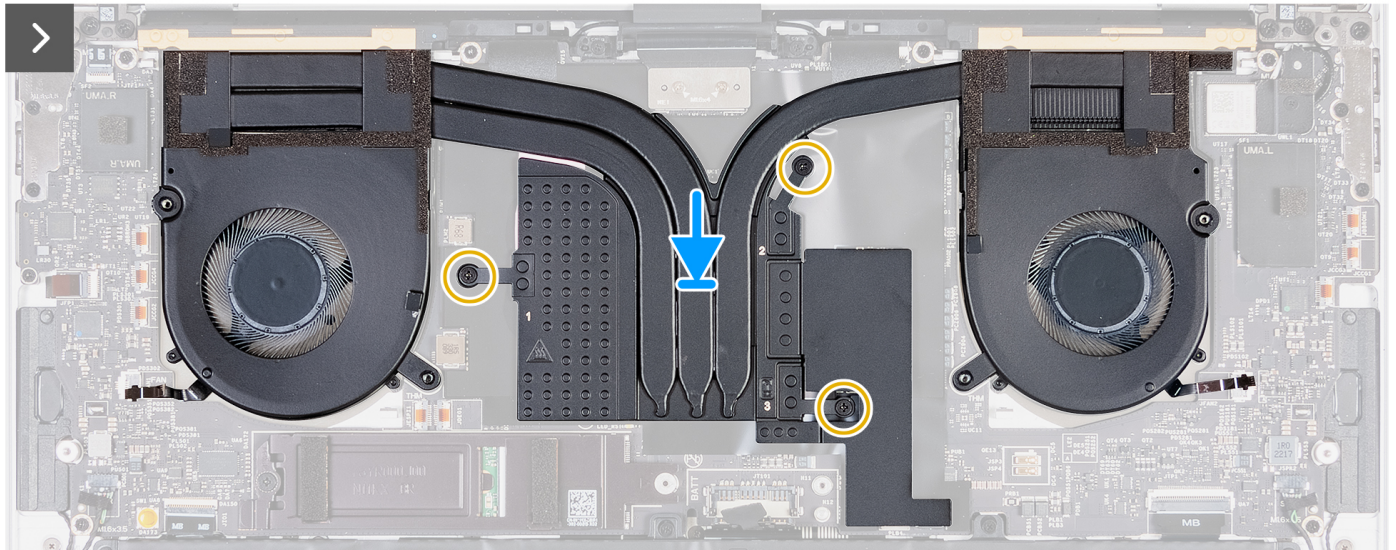
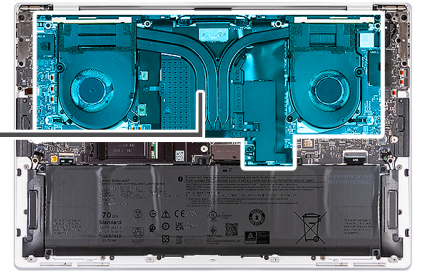
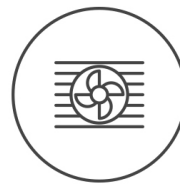

Steps

1. Align and place the heat-sink assembly on the palm-rest assembly.
2. In sequential order (1>2>3) as indicated on the heat-sink assembly, tighten the three captive screws that secure the heat-sink assembly to the system board.
3. Align the screw holes of the heat-sink assembly with the screw holes of the system board.
4. Replace the four screws (M1.6x3) that secure the left and right fans to the palm-rest assembly.
5. Connect the left fan cable (JFAN1) and right fan cable (JFAN2) to the system board.

Next steps

1. Install the [base cover](#).
2. Follow the procedure in [After working inside your computer](#).



Removing the heat-sink assembly - for computers shipped with discrete graphics card

 **CAUTION:** The information in this removal section is intended for authorized service technicians only.

Prerequisites

1. Follow the procedure in [Before working inside your computer](#).
2. Remove the [base cover](#).

About this task

-  **NOTE:** The heat-sink assembly may become hot during normal operation. Allow sufficient time for the heat-sink assembly to cool before you touch it.
-  **NOTE:** For maximum cooling of the processor, do not touch the heat transfer areas on the heat-sink assembly. The oils in your skin can reduce the heat transfer capability of the thermal grease.

The following image indicates the location of the heat-sink assembly and provides a visual representation of the removal procedure.

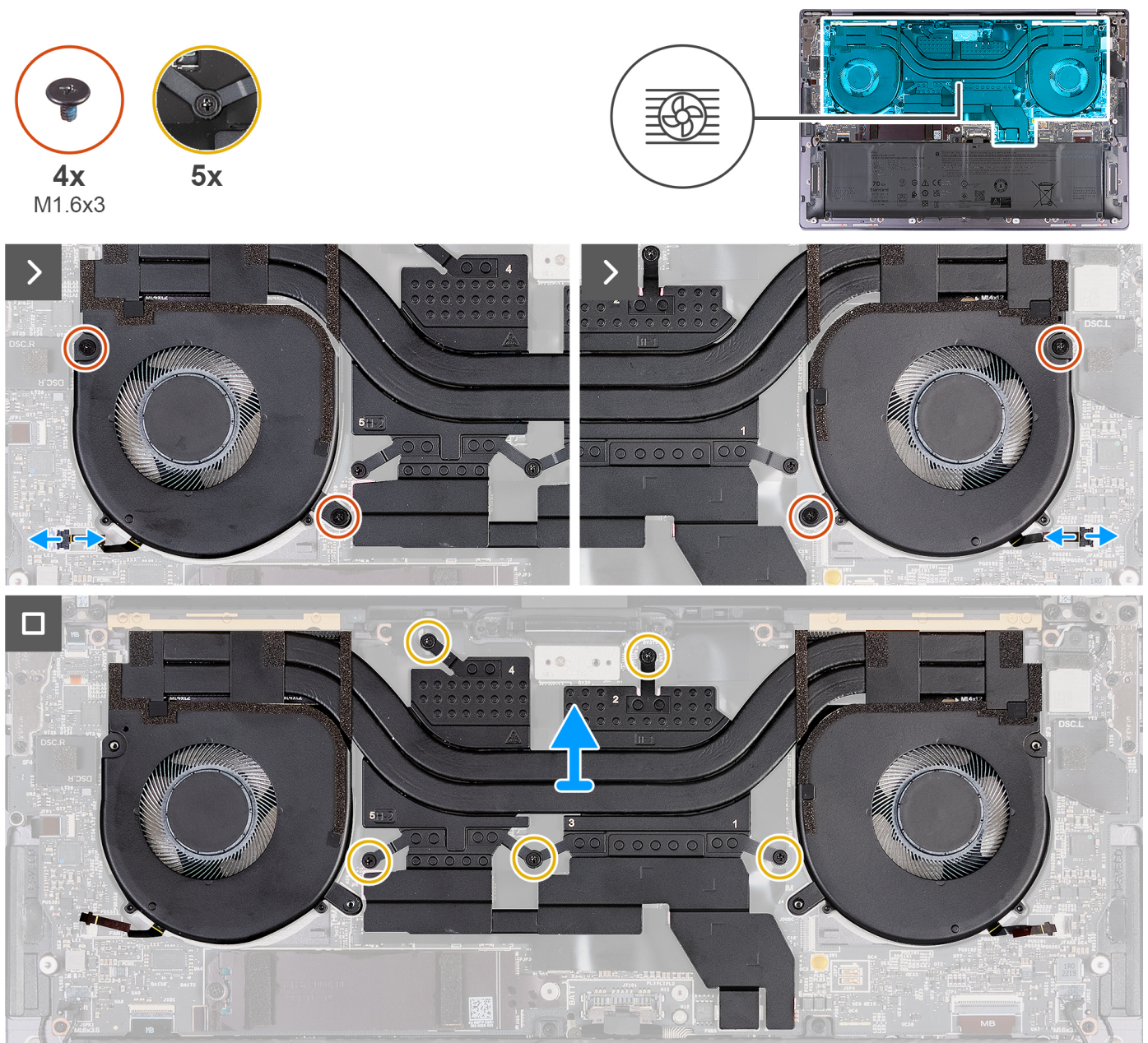

Figure 24. Removing the heat-sink assembly

Steps

1. Disconnect the left fan cable (JFAN1) and right fan cable (JFAN2) from the system board.
2. Remove the four screws (M1.6x3) that secure the left and right fans to the palm-rest assembly.
3. In reverse sequential order (5>4>3>2>1), loosen the five captive screws that secure the heat-sink assembly to the system board.
4. Lift the heat-sink assembly off the system board.

Installing the heat-sink assembly - for computers shipped with discrete graphics card

⚠ CAUTION: The information in this installation section is intended for authorized service technicians only.

Prerequisites

If you are replacing a component, remove the existing component before performing the installation process.

About this task

NOTE: If either the system board or the heat-sink assembly is replaced, use the thermal grease that is provided in the kit to ensure that the thermal conductivity is achieved.

The following images indicate the location of the heat-sink assembly and provide a visual representation of the installation procedure.

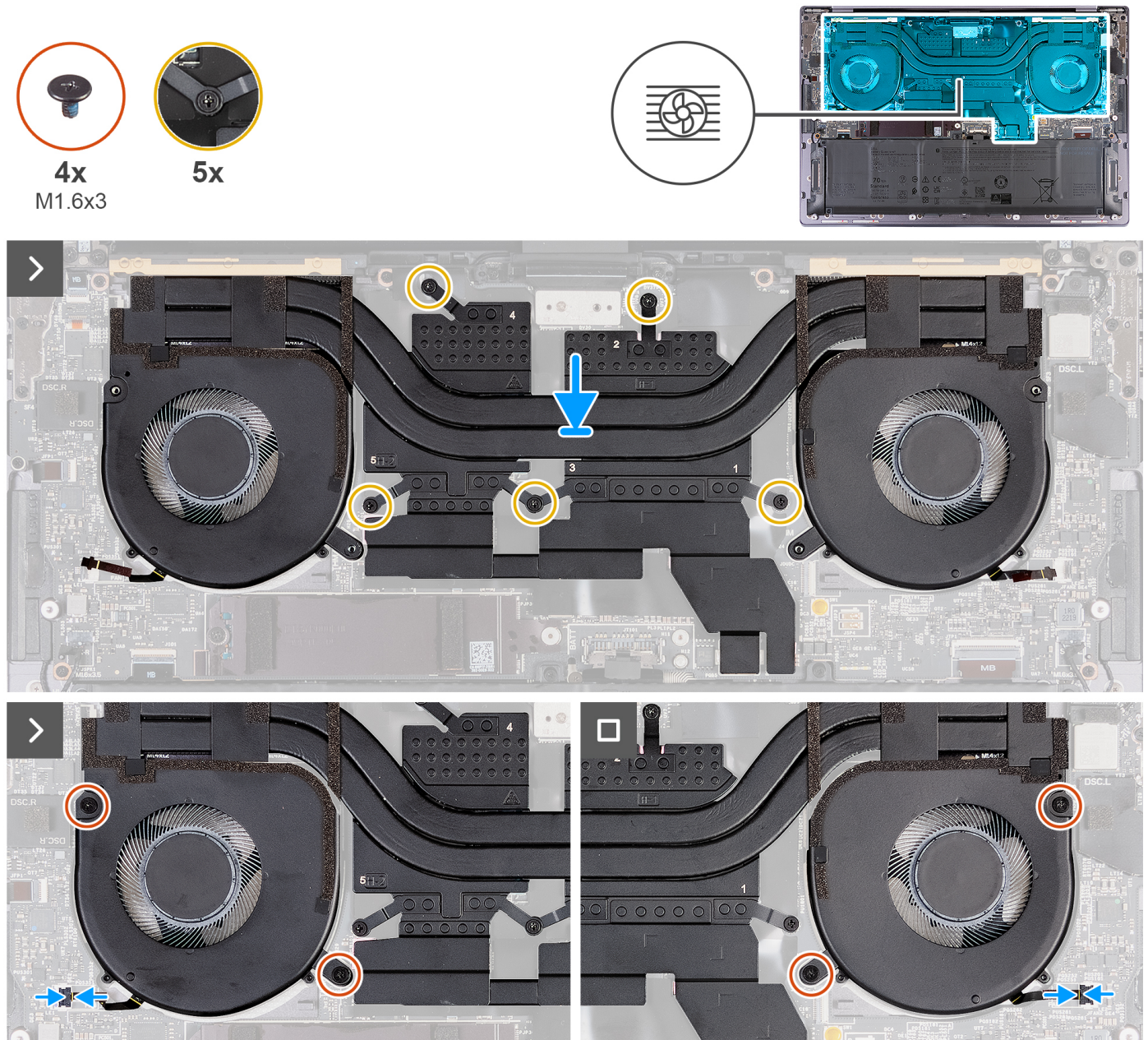

Figure 25. Installing the heat-sink assembly

Steps

1. Align and place the heat-sink assembly on the palm-rest assembly.
2. In sequential order (1>2>3>4>5) as indicated on the heat-sink assembly, tighten the five captive screws that secure the heat-sink assembly to the system board.
3. Align the screw holes of the heat-sink assembly with the screw holes of the system board.

4. Replace the four screws (M1.6x3) that secure the left and right fans to the palm-rest assembly.
5. Connect the left fan cable (JFAN1) and right fan cable (JFAN2) to the system board.

Next steps

1. Install the [base cover](#).
2. Follow the procedure in [After working inside your computer](#).

Display assembly

Removing the display assembly

 **CAUTION:** The information in this removal section is intended for authorized service technicians only.

Prerequisites

1. Follow the procedure in [Before working inside your computer](#).
2. Remove the [base cover](#).

About this task

The following images indicate the location of the display assembly and provide a visual representation of the removal procedure.

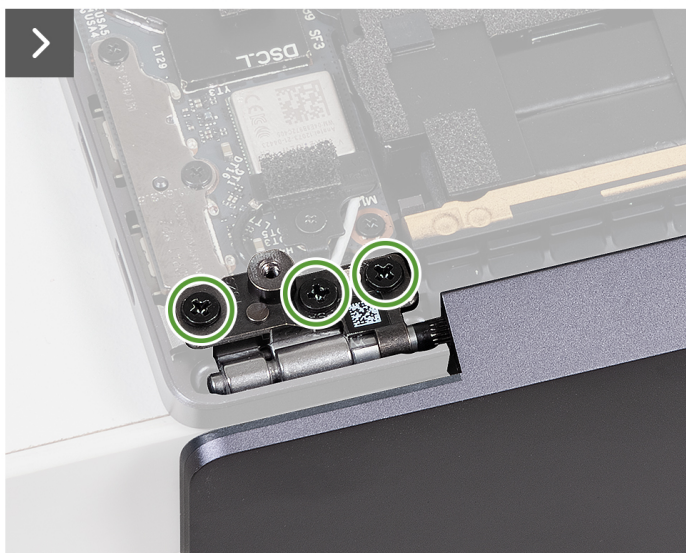
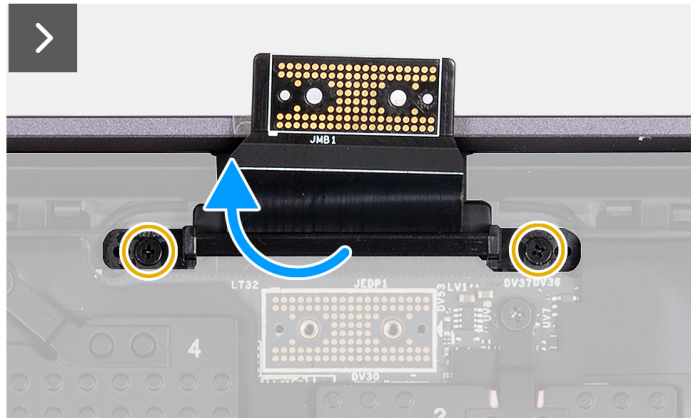
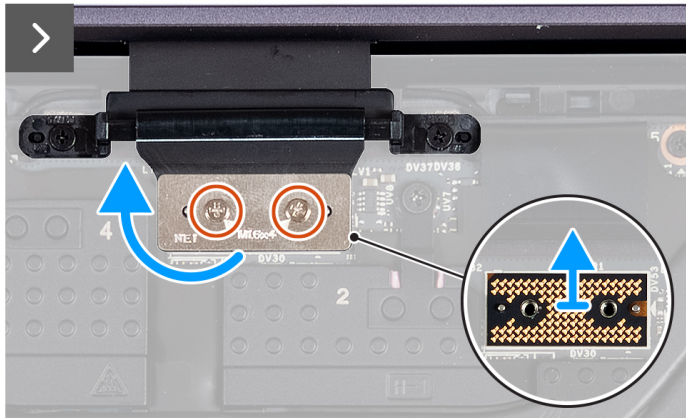
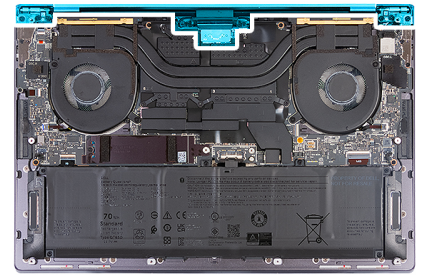
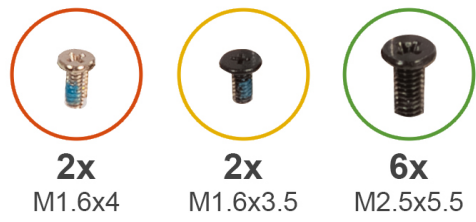

Figure 26. Removing the display assembly



Figure 27. Removing the display assembly

Steps

1. Remove the two screws (M1.6x4) that secures the display cable to the system board.
2. Disconnect the display cable from the display cable connector (JEDP1) on the system board.
3. Remove the display cable interposer board from the system board.

CAUTION: Service technicians must remove the interposer board immediately after disconnecting the display cable to prevent the board from falling out of the computer. The pins on the interposer board are fragile. Avoid contact with the pins on the board, instead handle the board by lifting and holding from the edges or the sides.

4. Remove the two screws (M1.6x3.5) that secures the display cable holder to the palm-rest assembly.
5. Open the display to a 90-degree angle and place the computer at the edge of a flat table.
6. Remove the six screws (M2.5x5.5) that secure the left and right hinges of the display assembly to the system board and palm-rest assembly.
7. Lift the display assembly off the palm-rest assembly.
8. After performing all the above steps, you are left with the display assembly.

NOTE: The display assembly is a Hinge-Up Design (HUD) assembly and cannot be further disassembled once it is removed from the palm-rest assembly. If any components in the display assembly are malfunctioning and must be replaced, replace the entire display assembly.



Figure 28. Display assembly

Installing the display assembly

CAUTION: The information in this installation section is intended for authorized service technicians only.

Prerequisites

If you are replacing a component, remove the existing component before performing the installation process.

About this task

The following images indicate the location of the display assembly and provide a visual representation of the installation procedure.

The following images indicate the location of the display assembly and provide a visual representation of the removal procedure.

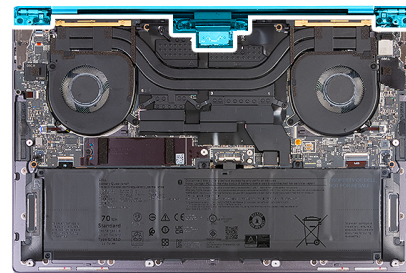
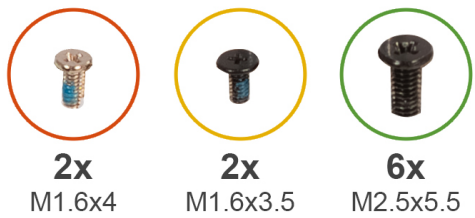

Figure 29. Installing the display assembly

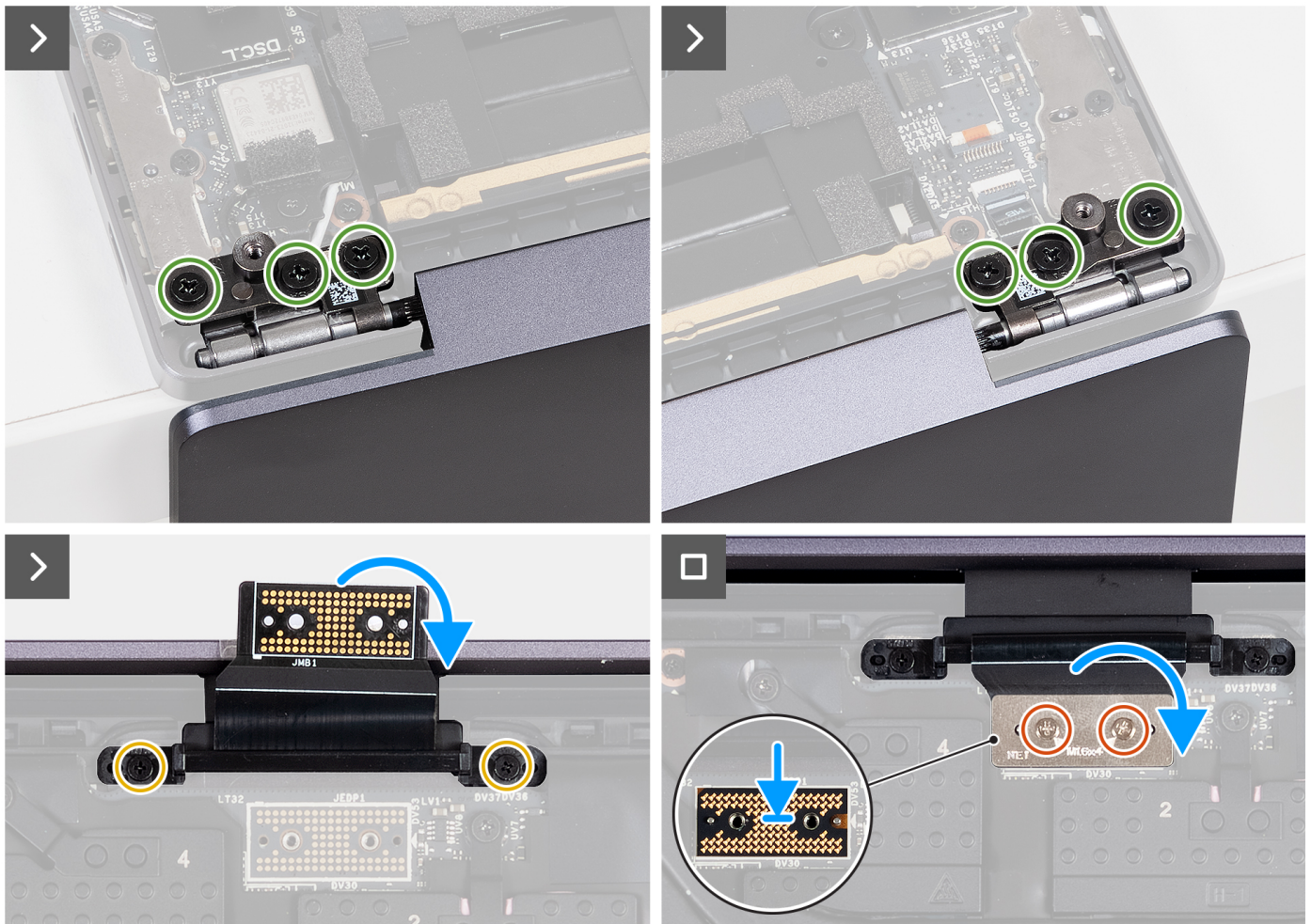

Figure 30. Installing the display assembly

Steps

1. Place the palm-rest assembly at the edge of a flat table.
2. Align the screw holes of the palm-rest assembly with the screw holes on the hinges of the display assembly.
3. Replace the six screws (M2.5x5.5) that secure the left and right hinges of the display assembly to the system board and palm-rest assembly.
4. Close the display assembly, turn the computer over, and place it on the flat surface.
5. Replace the two screws (M1.6x3.5) that secures the display cable holder to the palm-rest assembly.
6. Using the alignment posts, place the display cable interposer board on the system board.
7. Connect the display cable to the display cable connector (JEDP1) on the system board.
8. Align the screw holes on the display cable holder with the screw holes on the system board.
9. Replace the two screws (M1.6x4) that secures the display cable to the system board.

Next steps

1. Install the [base cover](#).
2. Follow the procedure in [After working inside your computer](#).

System board

Removing the system board

CAUTION: The information in this removal section is intended for authorized service technicians only.

Prerequisites

1. Follow the procedure in [Before working inside your computer](#).
2. Remove the [base cover](#).
3. Remove the [M.2 2230 solid-state drive](#) or [M.2 2280 solid-state drive](#) from the M.2 SSD slot, whichever is applicable.
4. Remove the [battery](#).
5. Remove the [display assembly](#).
6. Remove the [heat-sink assembly - for computers shipped with integrated graphics board](#) or [heat-sink assembly - for computers shipped with discrete graphics board](#), whichever is applicable.

About this task

The following image indicates the connectors and components on your system board.

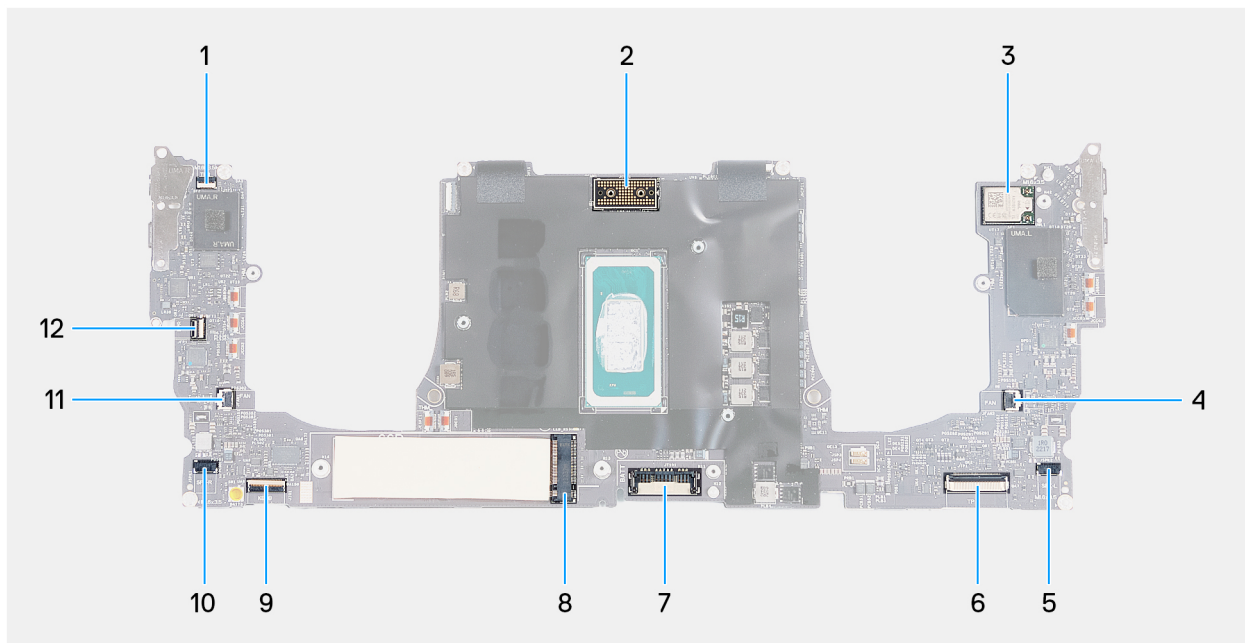

Figure 31. System-board connectors

- | | |
|--|--|
| 1. Touch function row cable connector (JTF1) | 2. Display-assembly cable connector (JEDP1) |
| 3. Integrated wireless card cable connector | 4. Left-fan cable connector (JFAN2) |
| 5. Left-speaker cable connector (JSPK2) | 6. Haptic-module cable connector (JTP1) |
| 7. Battery cable connector (BATT) | 8. M.2 solid-state drive slot |
| 9. Keyboard-control board cable connector (JIO1) | 10. Right-speaker cable connector (JSPK1) |
| 11. Right-fan cable connector (JFAN1) | 12. Power-button and fingerprint-reader cable connector (JFP1) |

The following images indicate the location of the system board and provide a visual representation of the removal procedure.



1x



11x
M1.6x3.5

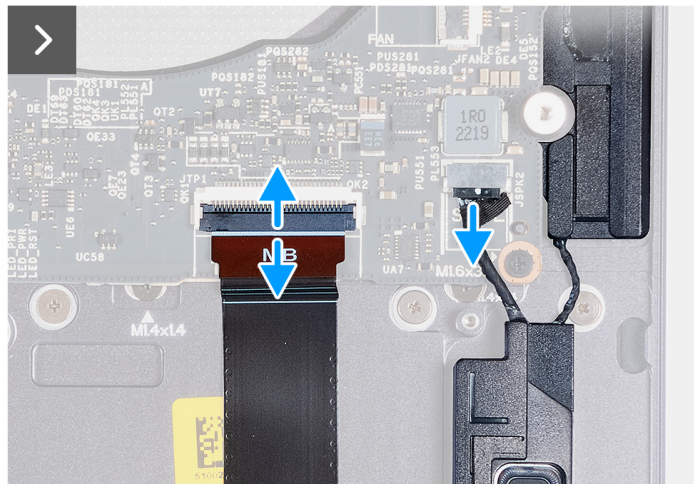
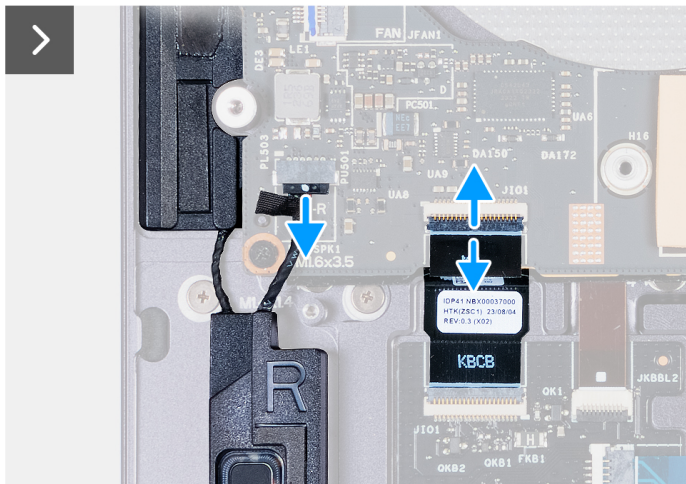
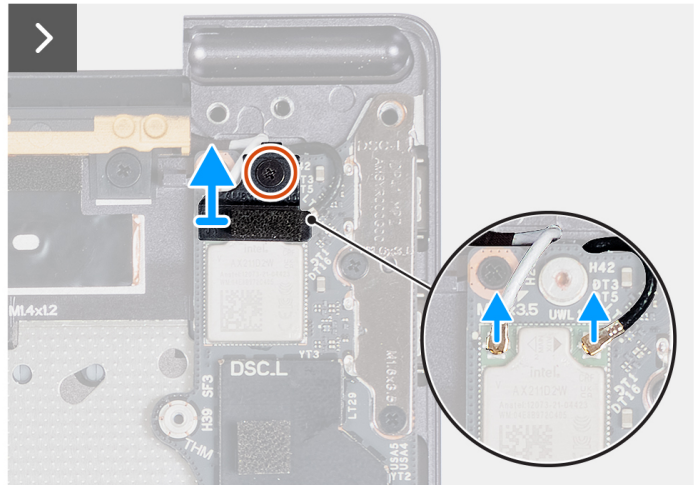
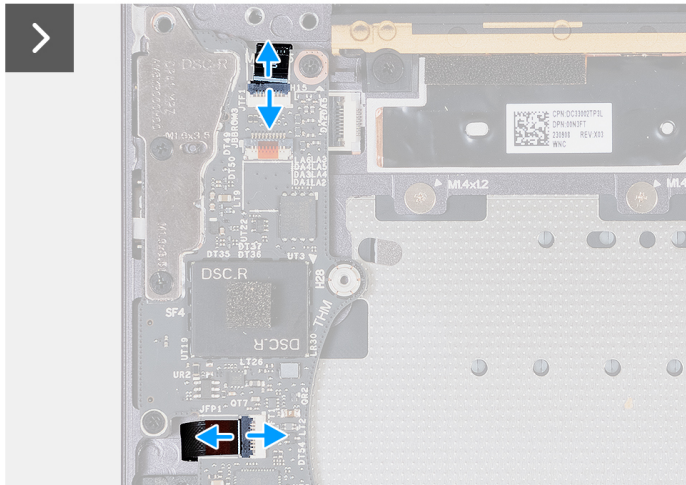
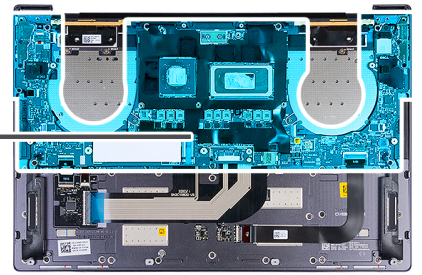

Figure 32. Removing the system board

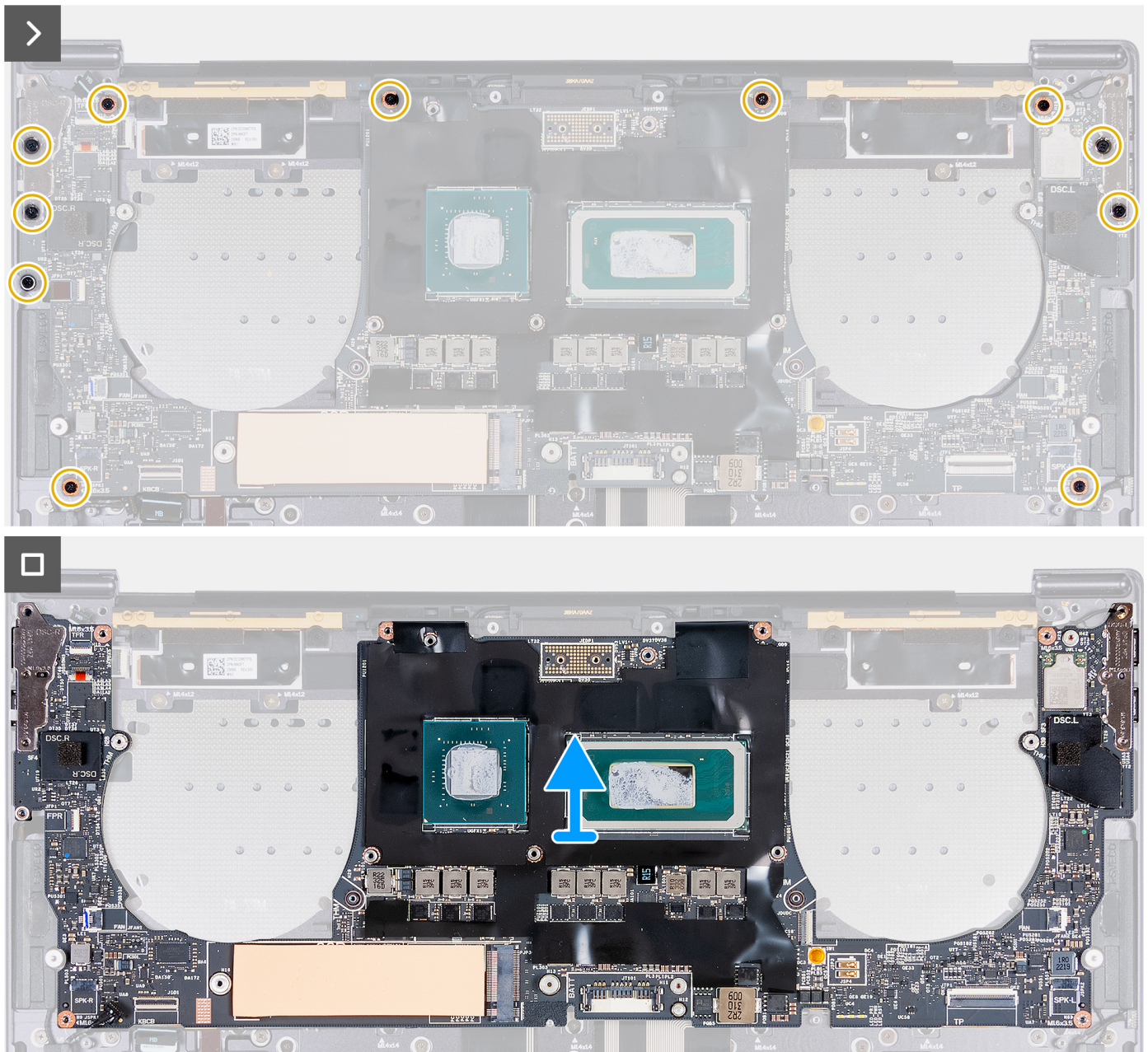

Figure 33. Removing the system board

Steps

1. Open the latch of the capacitive touch-panel connector (JTF1) and disconnect the capacitive touch-panel cable from the system board.
2. Loosen the captive screw that secures the wireless-module bracket to the system board.
 - NOTE:** Ensure that the small, clear washer that holds the captive screw in place does not fall.
3. Lift the wireless-module bracket off the system board.
4. Disconnect the antenna cables from the wireless module.
5. Lift the latch of the power-button and fingerprint-reader cable and disconnect the power-button and fingerprint-reader cable from their respective connectors on the system board.
6. Use the pull tab to disconnect the left-speaker cable from the left-speaker cable connector (JSPK2) on the system board.
7. Open the latch of the keyboard control-board cable and use the pull tab to disconnect the keyboard control-board cable from the keyboard control-board connector (JIO1) on the system board.

8. Open the latch of the haptic-module cable and use the pull tab to disconnect the haptic-module cable from the haptic-module cable connector (JTP1) on the system board.
9. Use the pull tab to disconnect the right-speaker cable from the right-speaker cable connector (JSPK1) on the system board.
10. Remove the 11 screws (M1.6x3.5) that secure the system board to the palm-rest assembly.
11. Hold the system board by the short edges, and lift the board off the palm-rest assembly with care.

Installing the system board

CAUTION: The information in this installation section is intended for authorized service technicians only.

Prerequisites

If you are replacing a component, remove the existing component before performing the installation process.

About this task

The following image indicates the connectors and components on your system board.

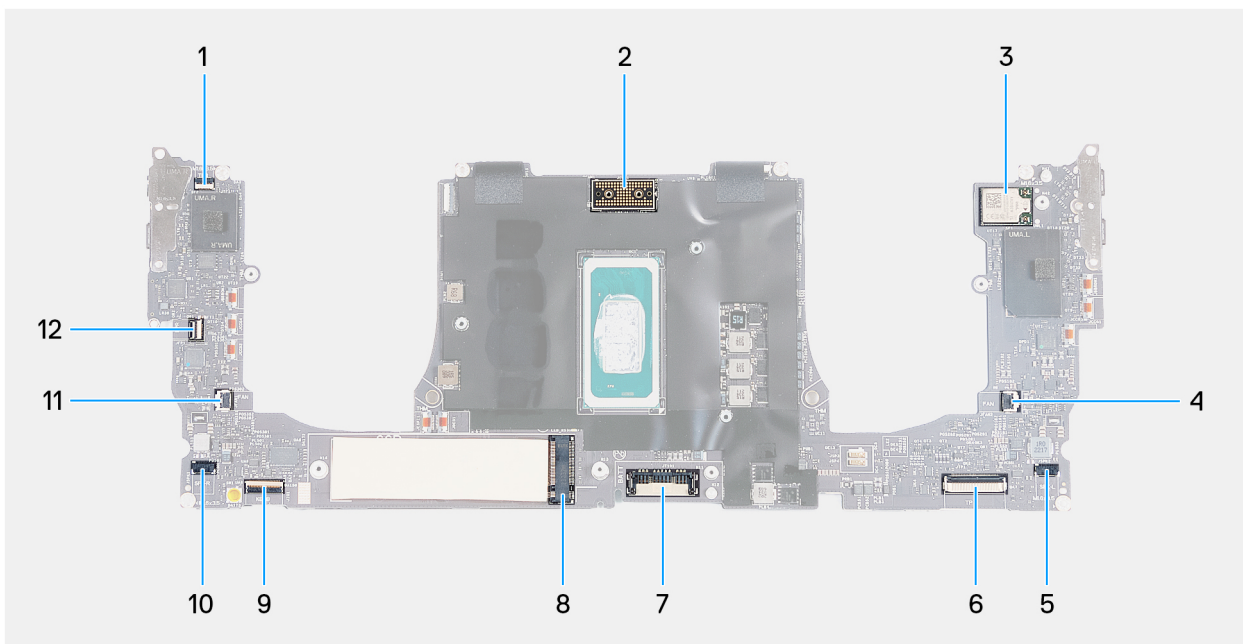

Figure 34. System-board connectors

- | | |
|--|--|
| 1. Touch function row cable connector (JTF1) | 2. Display-assembly cable connector (JEDP1) |
| 3. Integrated wireless card cable connector | 4. Left-fan cable connector (JFAN2) |
| 5. Left-speaker cable connector (JSPK2) | 6. Haptic-module cable connector (JTP1) |
| 7. Battery cable connector (BATT) | 8. M.2 solid-state drive slot |
| 9. Keyboard-control board cable connector (JIO1) | 10. Right-speaker cable connector (JSPK1) |
| 11. Right-fan cable connector (JFAN1) | 12. Power-button and fingerprint-reader cable connector (JFP1) |

The following images indicate the location of the system board and provide a visual representation of the installation procedure.



1x



11x
M1.6x3.5

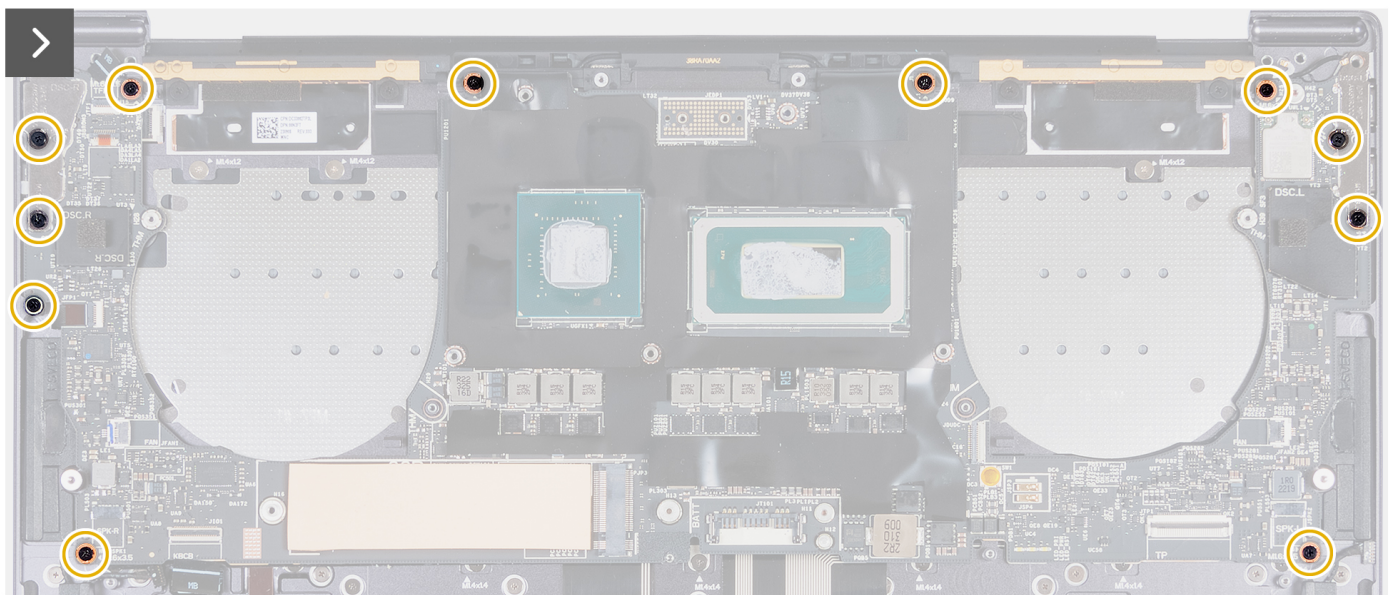
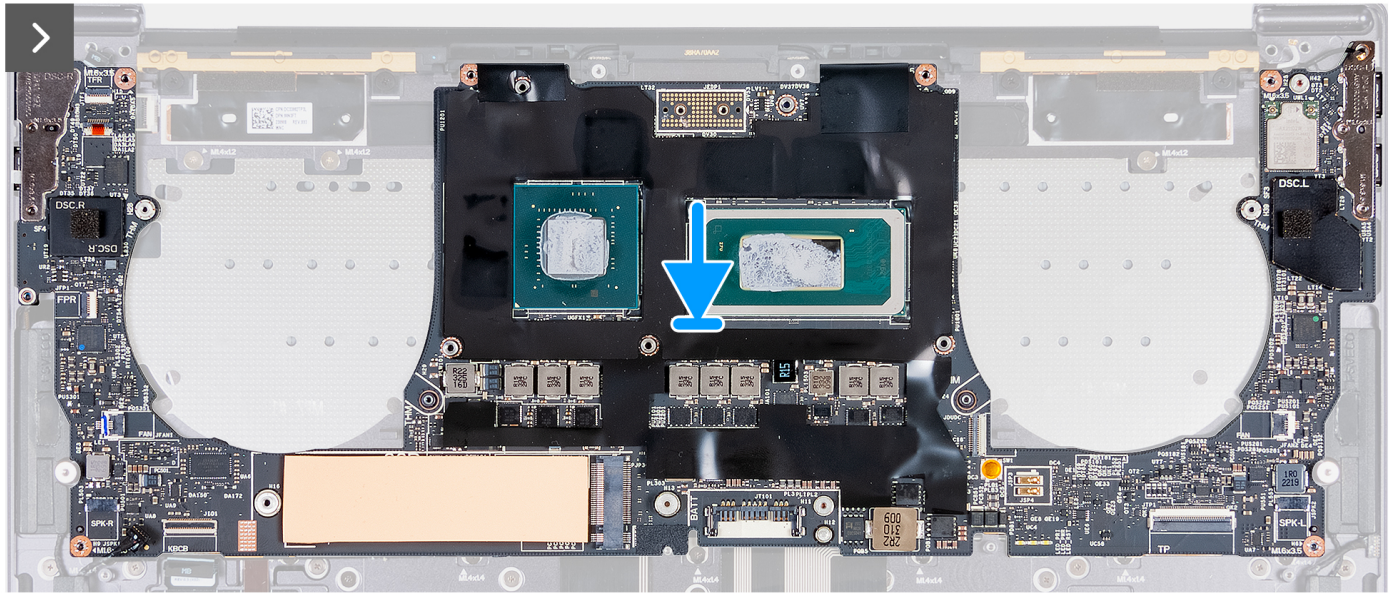
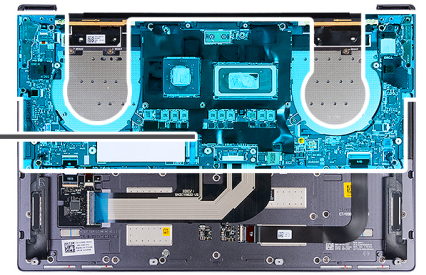

Figure 35. Installing the system board

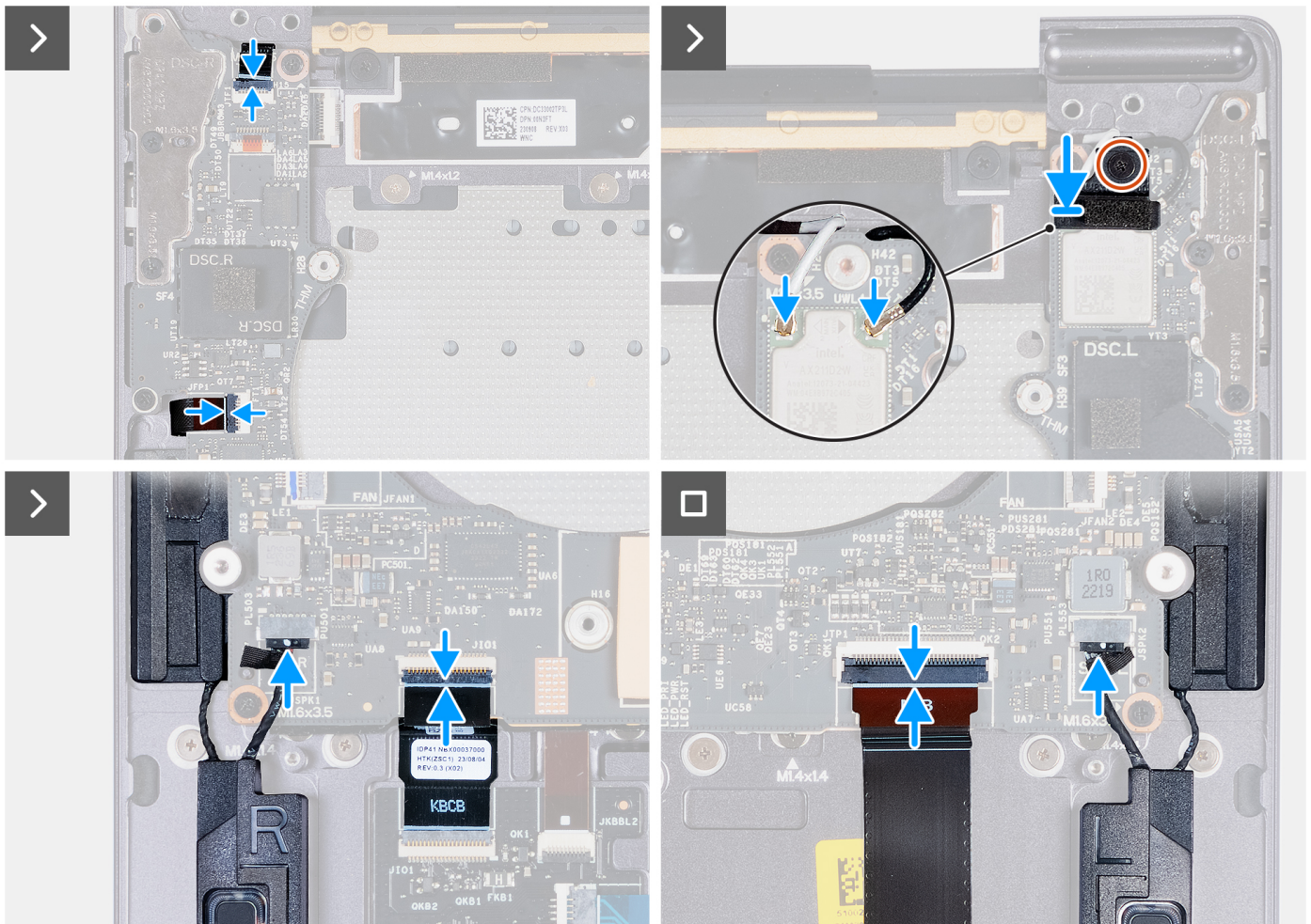

Figure 36. Installing the system board

Steps

1. Using the alignment posts, align the screw holes on the system board with the screw holes on the palm-rest assembly.
2. Place the system board on the palm-rest assembly.
3. Replace the 11 screws (M1.6x3.5) that secure the system board to the palm-rest assembly.
4. Connect the right-speaker cable to the right-speaker cable connector (JSPK1) on the system board.
5. Connect the haptic-module cable to the haptic-module cable connector (JTP1) on the system board and close the latch to secure the cable.
6. Connect the keyboard control-board cable to the keyboard control-board connector (JIO1) on the system board and close the latch to secure the cable.
7. Connect the left-speaker cable to the left-speaker cable connector (JSPK2) on the system board.
8. Connect the power-button and fingerprint-reader cable to the power-button and fingerprint-reader cable connector (JFP1) on the system board and close the latch to secure the cable.
9. Connect the antenna cables to the wireless module.
10. Align and place the wireless-module bracket on the system board.
11. Tighten the captive screw that secures the wireless-module bracket to the system board.
 - NOTE:** Ensure that the small, clear washer that holds the captive screw in place does not fall.
12. Connect the capacitive touch-panel cable to the capacitive touch-panel connector (JTF1) on the system board.

Next steps

1. Install the [heat-sink assembly - for computers shipped with integrated graphics card](#) or [heat-sink assembly - for computers shipped with discrete graphics card](#), whichever is applicable.

2. Install the [display assembly](#).
3. Install the [battery](#).
4. Install the [M.2 2230 solid-state drive](#) or [M.2 2280 solid-state drive](#) from the M.2 SSD slot, whichever is applicable.
5. Install the [base cover](#).
6. Follow the procedure in [After working inside your computer](#).

Power button with fingerprint reader

Removing the power button with fingerprint reader

CAUTION: The information in this removal section is intended for authorized service technicians only.

Prerequisites

1. Follow the procedure in [Before working inside your computer](#).
2. Remove the [base cover](#).
3. Remove the [M.2 2230 solid-state drive](#) or [M.2 2280 solid-state drive](#) from the M.2 SSD slot, whichever is applicable.
4. Remove the [battery](#).
5. Remove the [system board](#).

NOTE: The system board can be removed with the heat sink attached.

About this task

The following images indicate the location of the power button with fingerprint reader and provide a visual representation of the removal procedure.



Figure 37. Removing the power button with fingerprint reader

Steps

1. Remove the four screws (M1.4x2) that secure the power-button bracket to the palm-rest assembly.

2. Lift the power-button bracket off the palm-rest assembly.
3. Peel the power-button and fingerprint-reader cable from the top of the palm-rest assembly.
4. Flip the palm-rest assembly over. Unthread the power-button and fingerprint-reader cable through the opening on the palm-rest assembly, and remove the power button with fingerprint reader.

Installing the power button with fingerprint reader

CAUTION: The information in this installation section is intended for authorized service technicians only.

Prerequisites

If you are replacing a component, remove the existing component before performing the installation process.

About this task

The following images indicate the location of the power button with fingerprint reader and provide a visual representation of the installation procedure.

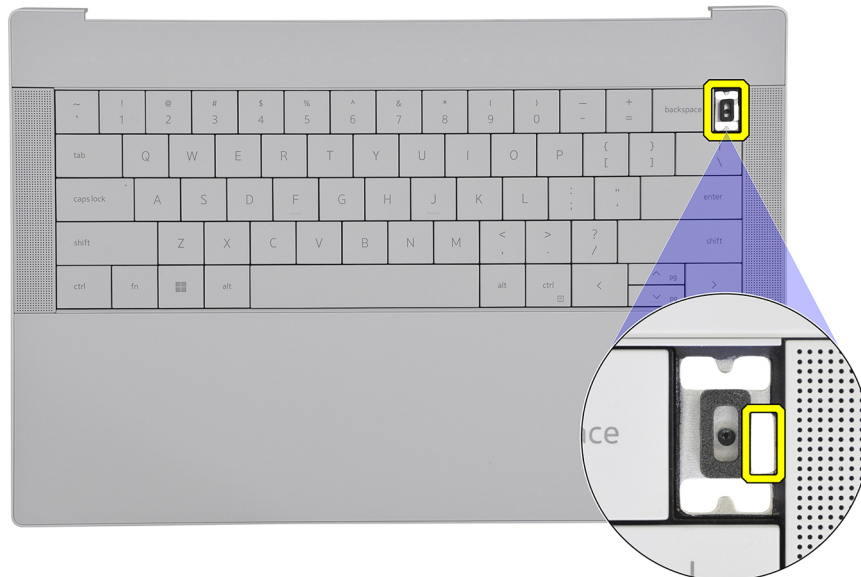

Figure 38. Power button with fingerprint reader

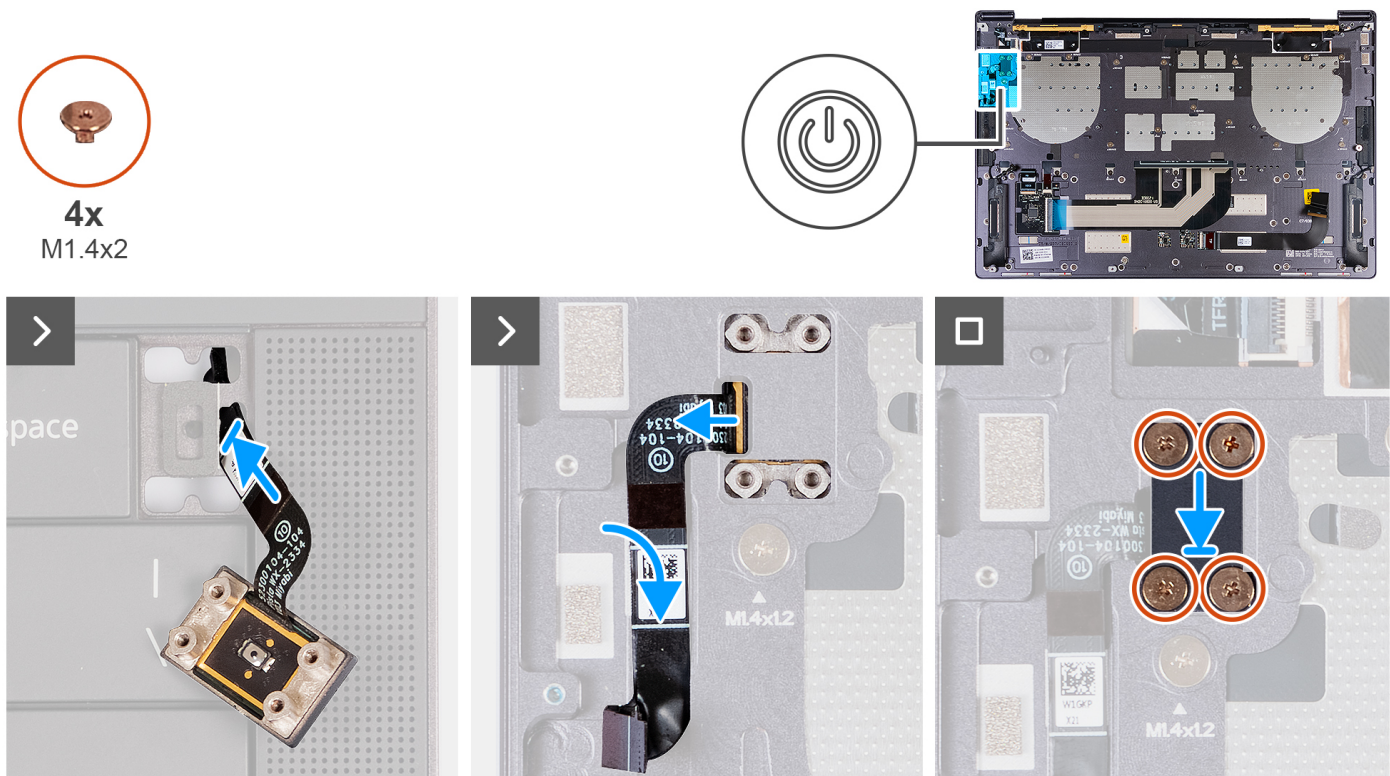

Figure 39. Installing the power button with fingerprint reader

Steps

1. Thread the power-button and fingerprint-reader cable through the opening on the palm-rest assembly.
2. Place the power button with fingerprint reader on the palm-rest assembly.
3. Align the screw holes of the power button with fingerprint reader with the screw holes of the power-button bracket.
4. Replace the four screws (M1.4x2) that secure the power button bracket to the palm-rest assembly.

Next steps

1. Install the [system board](#).
2. Install the [battery](#).
3. Install the [M.2 2230 solid-state drive](#) or [M.2 2280 solid-state drive](#) from the M.2 SSD slot, whichever is applicable.
4. Install the [base cover](#).
5. Follow the procedure in [After working inside your computer](#).

Keyboard

Removing the keyboard

CAUTION: The information in this removal section is intended for authorized service technicians only.

Prerequisites

1. Follow the procedure in [Before working inside your computer](#).
2. Remove the [base cover](#).
3. Remove the [M.2 2230 solid-state drive](#) or [M.2 2280 solid-state drive](#) from the M.2 SSD slot, whichever is applicable.
4. Remove the [battery](#).
5. Remove the [display assembly](#).
6. Remove the [power button with fingerprint reader](#).

7. Remove the [system board](#).

NOTE: The system board can be removed with the heat sink attached.

About this task

The following images indicate the location of the keyboard and provide a visual representation of the removal procedure.

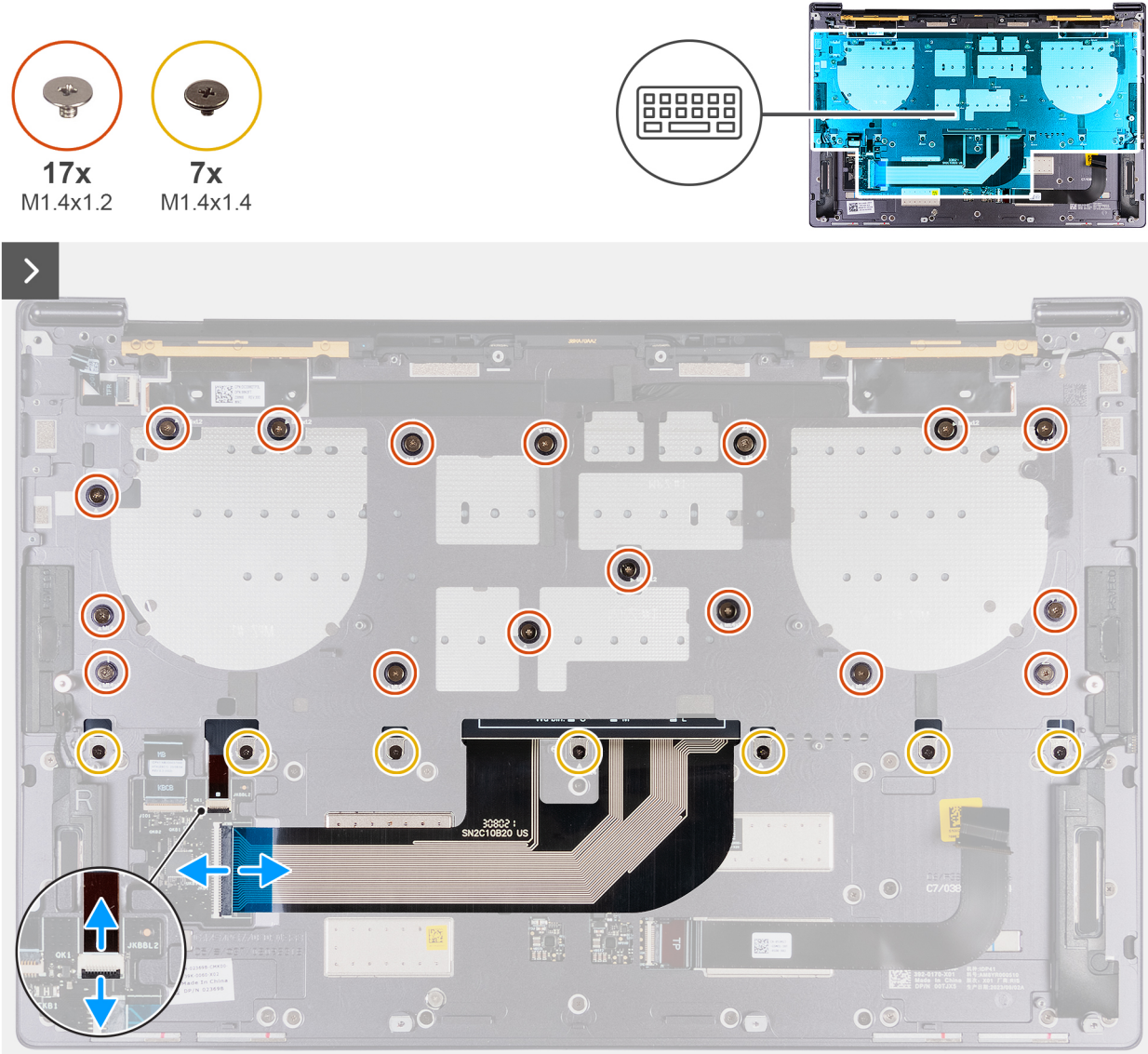

Figure 40. Removing the keyboard



Figure 41. Removing the keyboard

Steps

1. Open the latch of the keyboard-backlit cable and use the pull tab of the cable to disconnect the keyboard-backlit cable from the keyboard-backlit connector (JKBBL2) on the system board.
2. Open the latch of the keyboard cable and use the pull tab to disconnect the keyboard cable from the keyboard cable connector (JKB1) on the system board.
3. Remove the 17 screws (M1.4x1.2) and seven screws (M1.4x1.4) that secure the keyboard to the palm-rest assembly.
4. Unthread the keyboard-backlit cable and the keyboard cable through the opening on the palm-rest assembly.
5. Lift the keyboard off the palm-rest assembly until the tabs of the keyboard are out from the openings on the palm-rest assembly.

Installing the keyboard

CAUTION: The information in this installation section is intended for authorized service technicians only.

Prerequisites

If you are replacing a component, remove the existing component before performing the installation process.

About this task

The following images indicate the location of the keyboard and provide a visual representation of the installation procedure.

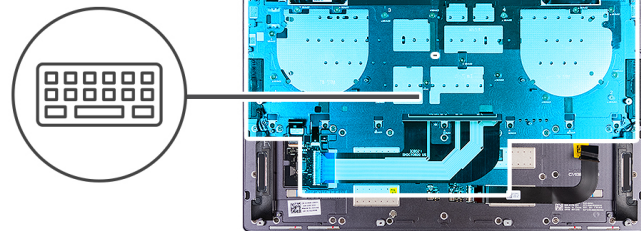
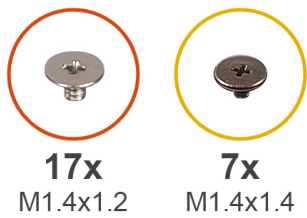

Figure 42. Installing the keyboard

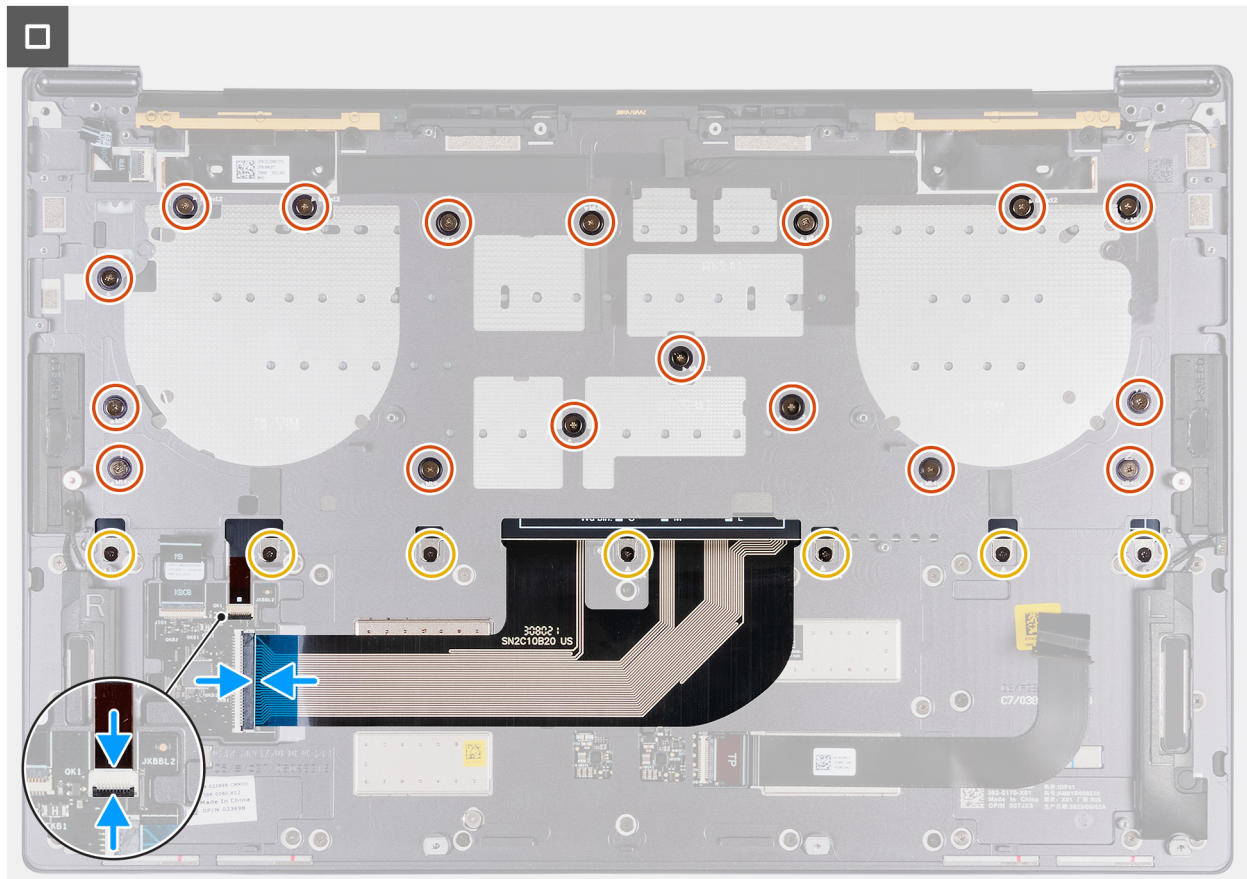

Figure 43. Installing the keyboard

Steps

1. Route the keyboard tabs through the openings of the palm-rest assembly.
2. Thread the keyboard-backlit cable and the keyboard cable through the opening of the palm-rest assembly.
3. Align the screw holes of the keyboard with the screw holes on the palm-rest assembly.

i NOTE: When securing the keyboard to the palm-rest assembly with screws, install the first four screws in the sequence as shown in the following image. The screw holes are labeled according to the required installation sequence.

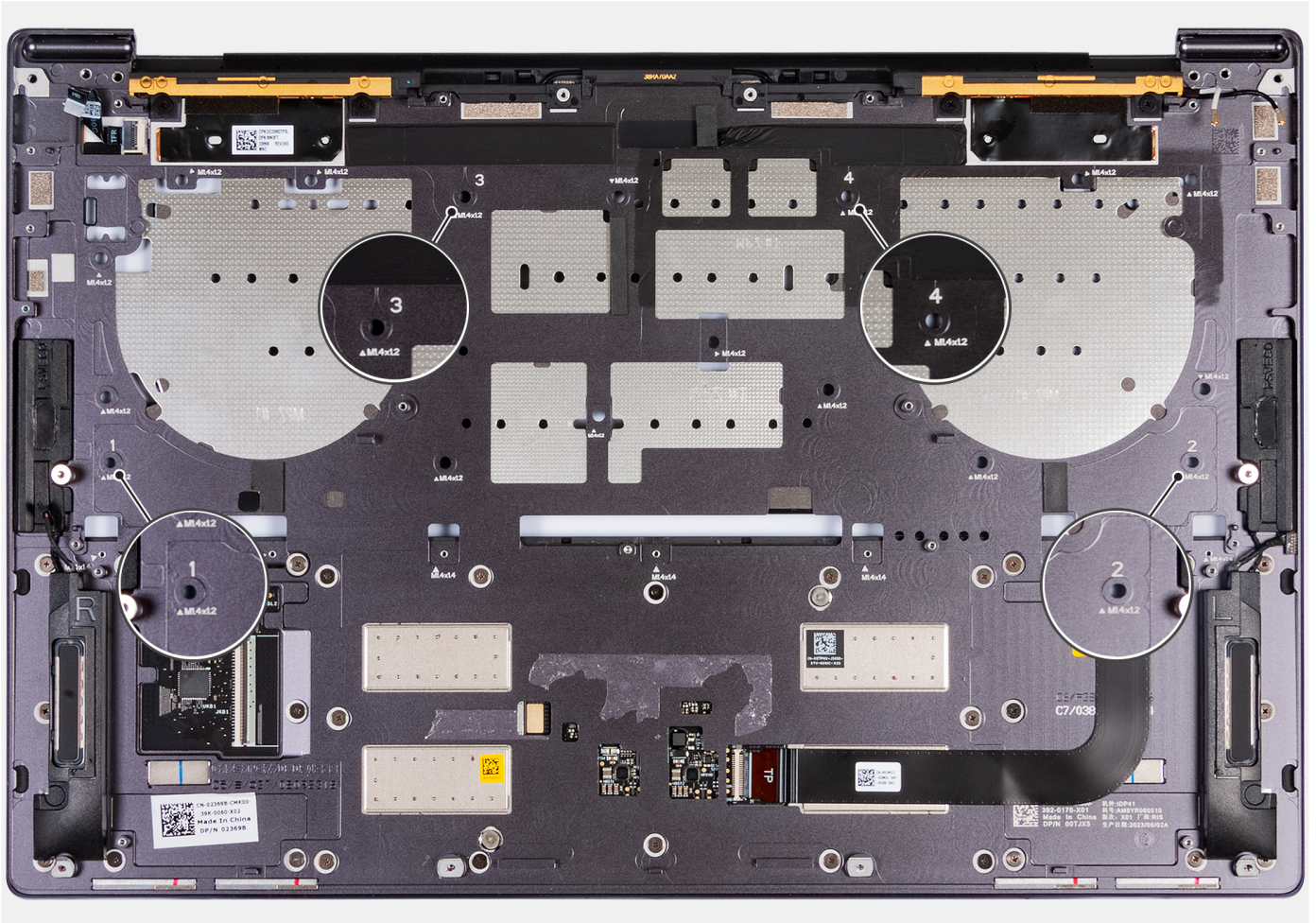

Figure 44. Installing four screws in sequence when securing the keyboard to the palm-rest assembly

4. Replace the 17 screws (M1.4x1.2) and seven screws (M1.4x1.4) that secure the keyboard to the palm-rest assembly.
5. Connect the keyboard-backlit cable to the keyboard-backlit connector (JKBBL2) on the keyboard-control board, and close the latch to secure the cable.
6. Connect the keyboard cable to the keyboard connector (JKB1) on the system board and close the latch to secure the cable.

Next steps

1. Install the [system board](#).
2. Install the [power button with fingerprint reader](#).
3. Install the [display assembly](#).
4. Install the [battery](#).
5. Install the [M.2 2230 solid-state drive](#) or [M.2 2280 solid-state drive](#) from the M.2 SSD slot, whichever is applicable.
6. Install the [base cover](#).
7. Follow the procedure in [After working inside your computer](#).

Palm-rest assembly

Removing the palm-rest assembly

⚠ CAUTION: The information in this removal section is intended for authorized service technicians only.

Prerequisites

1. Follow the procedure in [Before working inside your computer](#).
2. Remove the [base cover](#).
3. Remove the [M.2 2230 solid-state drive](#) or [M.2 2280 solid-state drive](#) from the M.2 SSD slot, whichever is applicable.
4. Remove the [battery](#).
5. Remove the [display assembly](#).
6. Remove the [system board](#).

NOTE: The system board can be removed with the heat sink attached.

7. Remove the [power button with fingerprint reader](#).
8. Remove the [keyboard](#).

About this task

NOTE: The replacement palm-rest assembly comes preassembled with the following components that include the following:

- Palm rest
- Speakers
- Wireless-antenna modules
- Touchpad
- Haptic module
- Keyboard-control board

The following image indicates the location of the palm-rest assembly and provides a visual representation of the removal procedure.

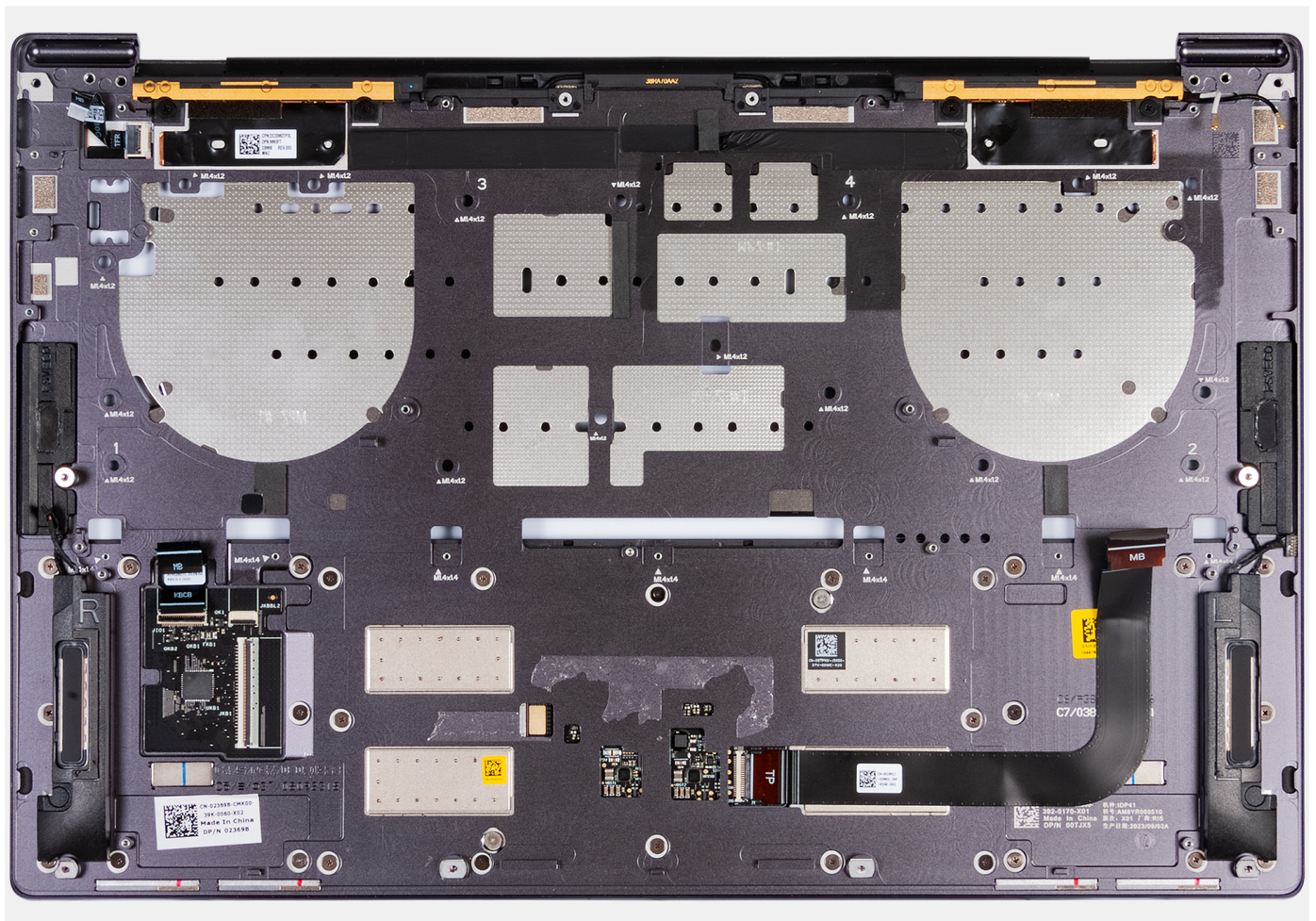

Figure 45. Palm-rest assembly

Steps

After performing the steps in the pre-requisites, you are left with the palm-rest assembly.

Installing the palm-rest assembly

CAUTION: The information in this installation section is intended for authorized service technicians only.

Prerequisites

If you are replacing a component, remove the existing component before performing the installation process.

About this task

NOTE: The replacement palm-rest assembly comes preassembled with the following components that include the following:

- Palm rest
- Speakers
- Wireless-antenna modules
- Touchpad
- Haptic module
- Keyboard-control board

The following image indicates the location of the palm-rest assembly and provides a visual representation of the installation procedure.

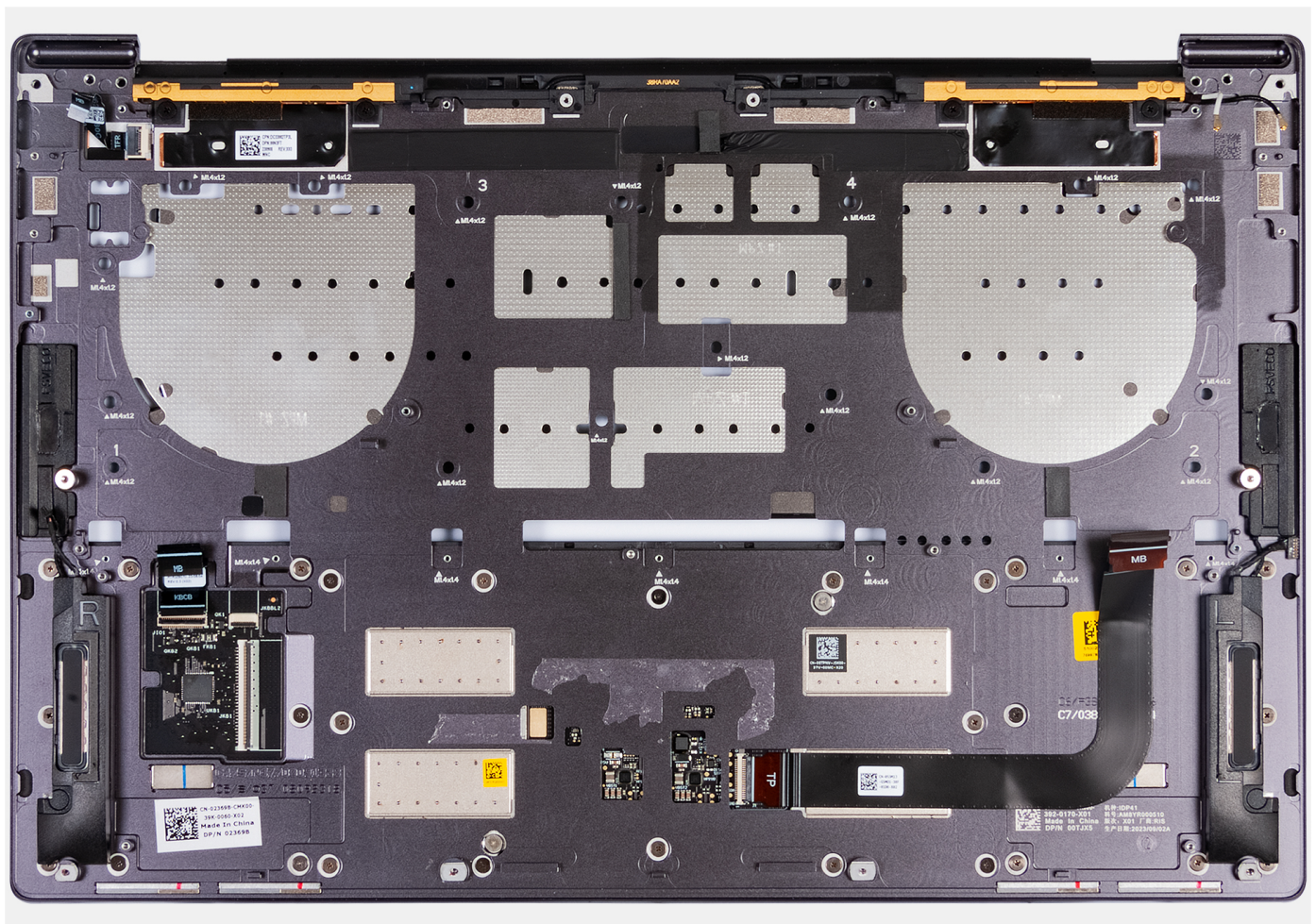

Figure 46. Palm-rest assembly

Steps

Place the palm-rest assembly on a flat surface.

Next steps

1. Install the [keyboard](#).
2. Install the [power button with fingerprint reader](#).
3. Install the [system board](#).
4. Install the [display assembly](#).
5. Install the [battery](#).
6. Install the [M.2 2230 solid-state drive](#) or [M.2 2280 solid-state drive](#) from the M.2 SSD slot, whichever is applicable.
7. Install the [base cover](#).
8. Follow the procedure in [After working inside your computer](#).

Software

This chapter details the supported operating systems along with instructions on how to install the drivers.

Operating system

Your XPS 14 9440 supports the following operating systems:

- Windows 11 Pro
- Windows 11 Home

Drivers and downloads

When troubleshooting, downloading, or installing drivers, it is recommended that you read the Dell Knowledge Base article Drivers and Downloads FAQs [000123347](#).

BIOS Setup

CAUTION: Unless you are an expert computer user, do not change the settings in the BIOS Setup. Certain changes can make your computer work incorrectly.

NOTE: Depending on the computer and its installed devices, the items that are listed in this section may or may not be displayed.

NOTE: Before you change the settings in BIOS Setup, it is recommended that you note down the original settings for future reference.

Use BIOS Setup for the following purposes:

- Get information about the hardware installed in your computer, such as the amount of RAM and the size of the storage device.
- Change the system configuration information.
- Set or change a user-selectable option, such as the user password, type of hard drive installed, and enabling or disabling base devices.

Entering BIOS setup program

About this task

Turn on (or restart) your computer and press F2 immediately.

Clearing chassis intrusion alert

The computer features a chassis intrusion switch that detects when the base cover is removed from the computer.

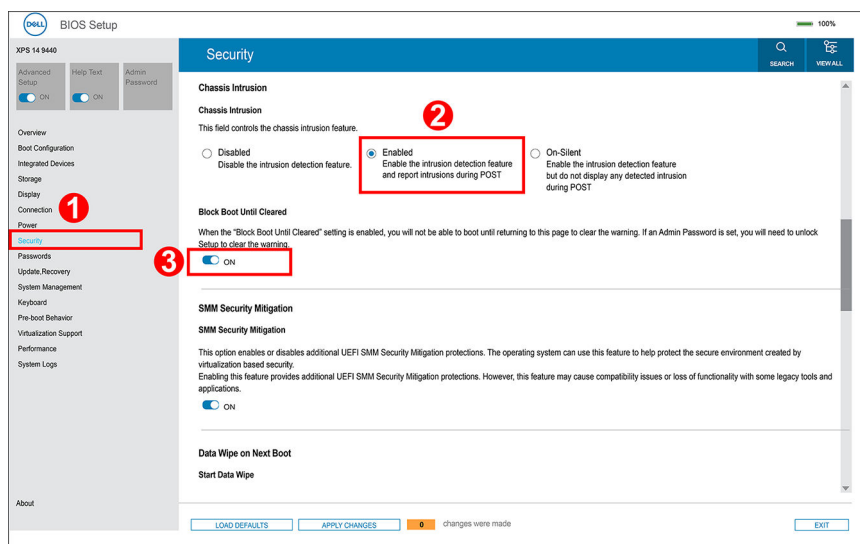

Figure 47. Security menu in BIOS Setup

The chassis intrusion feature raises an alert of any unauthorized attempt to access the internal components of the computer. This feature is configured using the **Chassis Intrusion** field of the **Security** sub-menu in the BIOS setup menu.

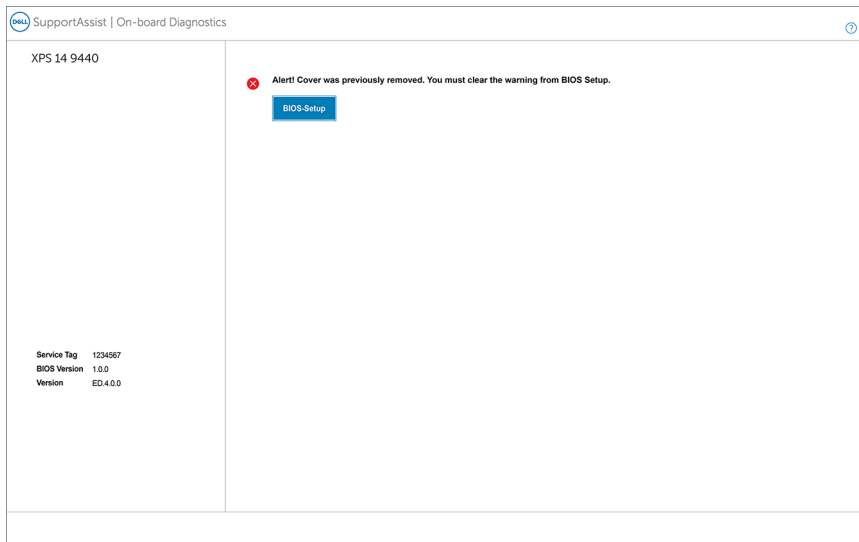

Figure 48. Chassis intrusion alert

When enabled, the **Block Boot Until Cleared** field enables you to choose whether to prevent normal boot of the computer until the intrusion alert is cleared. If **Block Boot Until Cleared** is set to **OFF**, select **Continue** to boot or **BIOS-Setup** to clear the alert.

NOTE: If **Continue** is selected, the alert message appears each time when the computer is turned on until the alert is cleared.

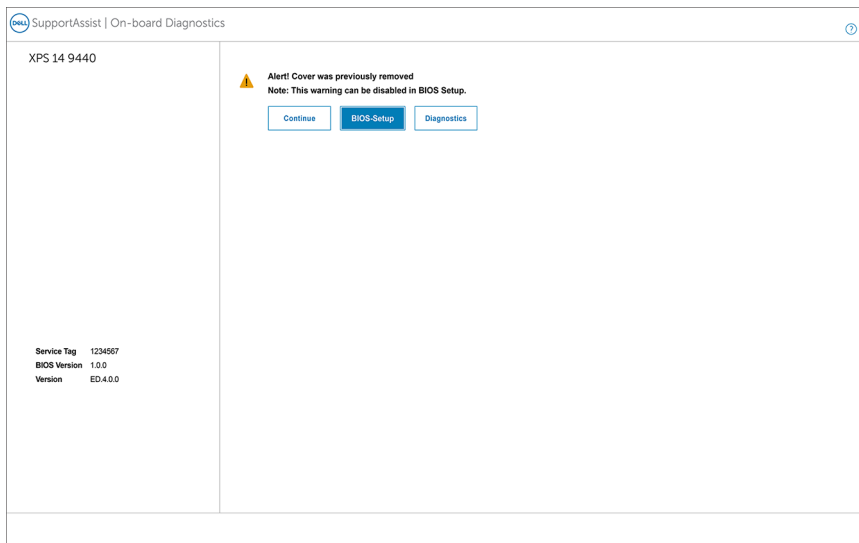

Figure 49. Warning message indicating that the Block Boot Until Cleared field is set to OFF

To clear the alert, select **ON** in the **Clear Intrusion Warning** field in the **Security** sub-menu of the BIOS setup menu.

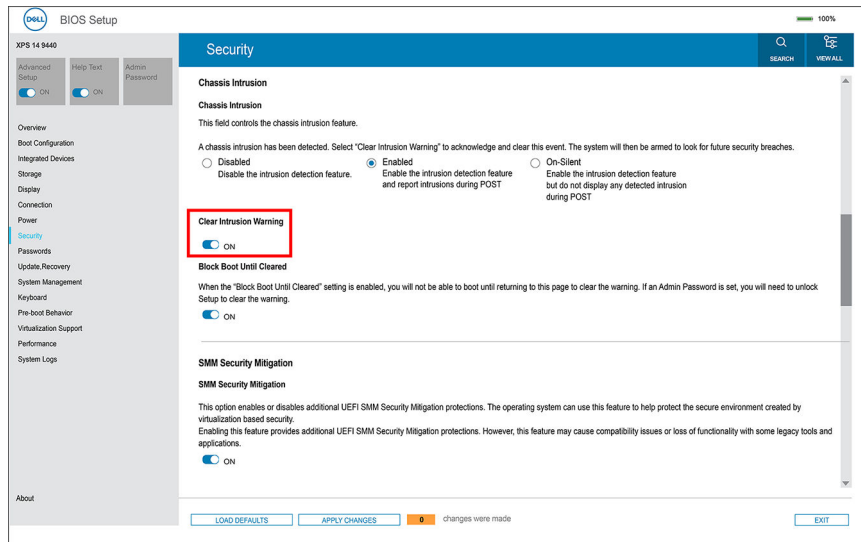

Figure 50. Clearing the intrusion warning

F12 One Time Boot menu

To enter the One Time Boot menu, turn on your computer, and then press F12 immediately.

NOTE: It is recommended to shut down the computer, if it is on.

The F12 One Time Boot menu displays the devices that you can boot from including the diagnostic option. The boot menu options are:

- Removable Drive (if available)
- STXXXX Drive (if available)
 - NOTE:** XXX denotes the SATA drive number.
- Optical Drive (if available)
- SATA Hard Drive (if available)
- Diagnostics

The boot sequence screen also displays the option to access System Setup.

Navigation keys

NOTE: For most of the System Setup options, changes that you make are recorded but do not take effect until you restart the computer.

Table 25. Navigation keys

Keys	Navigation
Up arrow	Moves to the previous field.
Down arrow	Moves to the next field.
Enter	Selects a value in the selected field (if applicable) or follows the link in the field.
Spacebar	Expands or collapses a drop-down list, if applicable.
Tab	Moves to the next focus area. NOTE: For the standard graphical user interface only.
Esc	Moves to the previous page until you view the main screen. Pressing Esc in the main screen displays a message that

Table 25. Navigation keys (continued)

Keys	Navigation
	prompts you to save any unsaved changes and restart the computer.

System setup options

NOTE: Depending on the computer and its installed devices, the items that are listed in this following table may or may not be displayed.

Table 26. System setup options—Overview menu

Overview	
XPS 14 9440	
BIOS Version	Displays the BIOS version number.
Service Tag	Displays the Service Tag of the computer.
Asset Tag	Displays the Asset Tag of the computer.
Manufacture Date	Displays the manufacture date of the computer.
Ownership Date	Displays the ownership date of the computer.
Express Service Code	Displays the express service code of the computer.
Ownership Tag	Displays the ownership tag of the computer.
Signed Firmware Update	Displays whether the Signed Firmware Update is enabled on your computer. By default, the Signed Firmware Update option is enabled.
BATTERY	
Primary	Displays the primary battery of the computer.
Battery Level	Displays the battery level of the computer.
Battery State	Displays the battery state of the computer.
Health	Displays the battery health of the computer.
AC Adapter	Displays whether an AC adapter is connected. If connected, displays the type of AC adapter that is connected.
PROCESSOR	
Processor Type	Displays the processor type.
Maximum Clock Speed	Displays the maximum processor clock speed.
Minimum Clock Speed	Displays the minimum processor clock speed.
Current Clock Speed	Displays the current processor clock speed.
Core Count	Displays the number of cores on the processor.
Processor ID	Displays the processor identification code.
Processor L2 Cache	Displays the processor L2 Cache size.
Processor L3 Cache	Displays the processor L3 Cache size.
Microcode Version	Displays the microcode version.
Intel Hyper-Threading Capable	Displays whether the processor is Hyper-Threading (HT) capable.
64-Bit Technology	Displays whether 64-bit technology is used.

Table 26. System setup options—Overview menu (continued)

Overview	
MEMORY	
Memory Installed	Displays the total computer memory installed.
Memory Available	Displays the total computer memory available.
Memory Speed	Displays the memory speed.
Memory Channel Mode	Displays single or dual channel mode.
Memory Technology	Displays the technology that is used for the memory.
DEVICES	
Panel Type	Displays the Panel Type of the computer.
Panel Revision	Displays the Panel revision of the computer.
Video Controller	Displays the video controller type of the computer.
Video Memory	Displays the video memory information of the computer.
Wi-Fi Device	Displays the wireless device information of the computer.
Native Resolution	Displays the native resolution of the computer.
Video BIOS Version	Displays the video BIOS version of the computer.
Audio Controller	Displays the audio controller information of the computer.
Bluetooth Device	Displays the Bluetooth device information of the computer.
Pass Through MAC Address	Displays the MAC address of the video pass-through.

Table 27. System setup options—Boot Configuration menu

Boot Configuration	
Boot Mode: UEFI only	Displays the boot mode of the computer.
Boot Sequence	Displays the boot sequence.
Enable PXE Boot Priority	Enables or disables PXE Boot Priority.
Secure Digital (SD) Card Boot	Enables or disables read-only boot from Secure Digital (SD) card. By default, the Secure Digital (SD) Card Boot option is enabled.
Secure Boot	Secure Boot is a method of guaranteeing the integrity of the boot path by performing additional validation of the operating system and PCI add-in cards. The computer stops booting to the operating system when a component is not authenticated during the boot process. Secure Boot can be enabled in BIOS setup or using management interfaces like Dell Command Configure, but can only be disabled from BIOS setup.
Enable Secure Boot	Enables the computer to boot using only validated boot software. By default, the Enable Secure Boot option is enabled. For additional security, Dell Technologies recommends keeping the Secure Boot option enabled to ensure that the UEFI firmware validates the operating system during the boot process.  NOTE: For Secure Boot to be enabled, the computer is required to be in UEFI boot mode and the Enable Legacy Option ROMs option is required to be turned off.
Enable Microsoft UEFI CA	When disabled, the UEFI CA is removed from the BIOS UEFI Secure Boot database.

Table 27. System setup options—Boot Configuration menu (continued)

Boot Configuration	
	<p>i NOTE: When disabled, the Microsoft UEFI CA could render your computer unable to boot, computer graphics may not function, some devices may not function properly, and the computer could become unrecoverable.</p> <p>By default, the Enable Microsoft UEFI CA option is enabled.</p> <p>For additional security, Dell Technologies recommends keeping the Microsoft UEFI CA option enabled to ensure the broadest compatibility with devices and operating systems.</p>
Secure Boot Mode	<p>Enables or disables the Secure Boot operation mode.</p> <p>By default, the Deployed Mode is selected.</p> <p>i NOTE: Deployed Mode should be selected for normal operation of Secure Boot.</p>
Expert Key Management	
Enable Custom Mode	<p>Enables or disables the keys in the PK, KEK, db, and dbx security key databases to be modified.</p> <p>By default, the Enable Custom Mode option is disabled.</p>
Custom Mode Key Management	<p>Selects the custom values for expert key management.</p> <p>By default, the PK option is selected.</p>

Table 28. System setup options—Integrated Devices menu

Integrated Devices	
Date/Time	
Date	Sets the computer date in MM/DD/YYYY format. Changes to the date format take effect immediately.
Time	Sets the computer time in HH/MM/SS 24-hour format. You can switch between a 12-hour and 24-hour clock. Changes to the time format take effect immediately.
Camera	
Enable Camera	<p>Enables the camera.</p> <p>By default, the Enable Camera option is enabled.</p> <p>i NOTE: Depending on the configuration ordered, the camera setup option may not be available.</p>
Audio	
Enable Audio	<p>Enables all integrated audio controller.</p> <p>By default, all the options are enabled.</p>
Enable Microphone	<p>Enables the microphone.</p> <p>By default, the Enable Microphone option is enabled.</p> <p>i NOTE: Depending on the configuration ordered, the microphone setup option may not be available.</p>
Enable Internal Speaker	<p>Enables the internal speaker.</p> <p>By default, the Enable Internal Speaker option is enabled.</p>
USB/Thunderbolt Configuration	
Enable External USB Ports	<p>Enables the external USB ports.</p> <p>By default, the Enable External USB Ports option is enabled.</p>

Table 28. System setup options—Integrated Devices menu (continued)

Integrated Devices	
Enable USB Boot Support	Enables booting from USB mass storage devices that are connected to external USB ports. By default, the Enable USB Boot Support option is enabled.
Enable Thunderbolt Technology Support	
Enable Thunderbolt Technology Support	Enables the associated ports and adapters for Thunderbolt Technology support. By default, the Enable Thunderbolt Technology Support option is enabled.
Enable Thunderbolt Boot Support	
Enable Thunderbolt Boot Support	Enables the Thunderbolt adapter-peripheral device and USB devices that are connected to the Thunderbolt adapter to be used during BIOS Preboot. By default, the Enable Thunderbolt Boot Support option is disabled.
Enable Thunderbolt (and PCIe behind TBT) pre-boot modules	
Enable Thunderbolt (and PCIe behind TBT) pre-boot modules	Enables the PCIe devices that are connected through a Thunderbolt adapter to run the PCIe devices UEFI Option ROM (if present) during preboot. By default, the Enable Thunderbolt (and PCIe behind TBT) pre-boot modules option is disabled.
Disable USB4 PCIE Tunneling	Disables the USB4 PCIE Tunneling option. By default, the Disable USB4 PCIE Tunneling option is disabled.
Video/Power only on Type-C Ports	Enables or disables the Type-C port functionality to video or only power. By default, the Video/Power only on Type-C Ports option is disabled.
Type-C Dock	
Type-C Dock Override	Enables or disables to use connected Type-C Dell Dock to provide data stream with external USB ports disabled. When Type-C Dock override is enabled, the Video/Audio/LAN submenu is activated. By default, the Type-C Dock Override option is enabled.
Type-C Dock Audio	Enables or disables the usage of audio inputs and outputs from the connected Type-C Dell docking station. By default, the Type-C Dock Audio option is enabled.
Type-C Dock LAN	Enables or disables the usage of LAN on the external ports of the connected Type-C Dell docking station. By default, the Type-C Dock LAN option is enabled.
Miscellaneous Devices	
Enable Fingerprint Reader Device	Enables the Fingerprint Reader Device option. By default, the Enable Fingerprint Reader Device option is enabled.

Table 29. System setup options—Storage menu

Storage	
SATA/NVMe Operation	
SATA/NVMe Operation	Sets the operating mode of the integrated SATA hard drive controller. By default, the AHCI/NVMe option is selected. The storage device is configured for AHCI/NVMe mode.

Table 29. System setup options—Storage menu (continued)

Storage	
SMART Reporting	Displays the information of various onboard drives.
Enable SMART Reporting	When enabled, the BIOS can receive analytical information from integrated drives and send notifications during startup about possible future failure of the hard drive. Default: OFF
Drive Information	Displays the information of onboard drives.
Enable MediaCard	Enables to switch all media cards On/Off or set the media card to a read-only state. By default, Secure Digital (SD) Card is selected.

Table 30. System setup options—Display menu

Display	
Display Brightness	
Brightness on battery power	Enables to set the screen brightness when the computer is running on battery power. By default, the screen brightness is set to 50 when the computer is running on battery power.
Brightness on AC power	Enables to set the screen brightness when the computer is running on AC power. By default, the screen brightness is set to 100 when the computer is running on AC power.
Touchscreen	
Touchscreen	Enables or disables the touch screen option. By default, the Touchscreen option is enabled.
Full Screen Logo	
Full Screen Logo	Enables or disables the computer to display a full-screen logo, if the image matches screen resolution. By default, the Full Screen Logo option is disabled.

Table 31. System setup options—Connection menu

Connection	
Wireless Device Enable	
WLAN	Enables or disables the internal WLAN device. By default, the WLAN option enabled.
Bluetooth	Enables or disables the internal Bluetooth device. By default, the Bluetooth option enabled.
Enable UEFI Network Stack	Enables or disables the UEFI Network Stack and controls the onboard LAN Controller. By default, the Enable UEFI Network Stack option is enabled.
Wireless Radio Control	
Control WLAN Radio	Enables to sense the connection of the computer to a wired network and then disables the selected wireless radios (WLAN and/or WWAN). Upon disconnection from the wired network, the selected wireless radios are reenabled.

Table 31. System setup options—Connection menu (continued)

Connection	
	By default, the Control WLAN Radio option is disabled.
Enable UEFI Bluetooth Stack	
Enable UEFI Bluetooth Stack	Enables or disables the UEFI Bluetooth Stack. Default: Enabled
HTTP(s) Boot Feature	
HTTP(s) Boot	Enables the HTTP(s) boot capabilities. Default: ON
HTTP(s) Boot Modes	
Auto Mode	HTTP(s) Boot automatically extracts Boot URL from the Dynamic Host Configuration Protocol (DHCP). By default, Auto Mode is selected.
Manual Mode	HTTP(s) Boot reads the Boot URL provided by the user.

Table 32. System setup options—Power menu

Power	
Battery Configuration	Enables or disables the computer to run on battery during peak power usage hours. Use the table Custom Charge Start and Custom Charge Stop , to prevent AC power usage between certain times of each day. By default, the Adaptive option is selected. Battery settings are adaptively optimized based on your typical battery usage pattern.
Advanced Configuration	
Enable Advanced Battery Charge Configuration	Enables Advanced Battery Charge Configuration from the beginning of the day to a specified work period. When enabled, Advanced Battery Charged maximizes battery health while still supporting heavy use during the work day. By default, the Enable Advanced Battery Charge Configuration option is disabled.
Peak Shift	
Enable Peak Shift	Enables the computer to run on battery during peak power usage hours. By default, the Enable Peak Shift option is disabled.
Thermal Management	
	Enables or disables cooling of fan and manages processor heat to adjust the computer performance, noise, and temperature. By default, the Optimized option is selected. Standard setting for balanced performance, noise, and temperature.
USB Wake Support	
Wake on Dell USB-C Dock	When enabled, connecting a Dell USB-C Dock wakes the computer from Standby, Hibernate, and Power Off. By default, the Wake on Dell USB-C Dock option is enabled.
Block Sleep	
	Enables or disables the computer from entering Sleep (S3) mode in the operating system. By default, the Block Sleep option is disabled. i NOTE: When enabled, the computer does not go to Sleep, Intel Rapid Start is disabled automatically, and the operating system power option is blank if it was set to Sleep.
Lid Switch	

Table 32. System setup options—Power menu (continued)

Power	
Enable Lid Switch	Enables or disables the Lid Switch. By default, the Enable Lid Switch option is enabled.
Power On Lid Open	When enabled, it allows the computer to turn on from the off state whenever the lid is opened. By default, the Power On Lid Open option is enabled.
Intel Speed Shift Technology	Enables or disables the Intel Speed Shift Technology support. When enabled, the operating system selects the appropriate processor performance automatically. By default, the Intel Speed Shift Technology option is enabled.

Table 33. System setup options—Security menu

Security	
TPM 2.0 Security	The Trusted Platform Module (TPM) provides various cryptographic services which serve as the cornerstone for many platform security technologies. Trusted Platform Module (TPM) is a security device that stores computer-generated keys for encryption and features such as BitLocker, Virtual Secure Mode, remote Attestation. By default, the Trusted Platform Module (TPM) option is enabled. For additional security, Dell Technologies recommends keeping Trusted Platform Module (TPM) enabled to allow these security technologies to fully function. i NOTE: The options that are listed apply to computers with a discrete Trusted Platform Module (TPM) chip.
TPM 2.0 Security On	Allows you to enable or disable TPM. By default, the TPM On option is enabled. For additional security, Dell Technologies recommends keeping TPM On enabled to allow these security technologies to fully function.
Attestation Enable	The Attestation Enable option controls the endorsement hierarchy of TPM. Disabling the Attestation Enable option prevents TPM from being used to digitally sign certificates. By default, the Attestation Enable option is enabled. For additional security, Dell Technologies recommends keeping the Attestation Enable option enabled. i NOTE: When disabled, this feature may cause compatibility issues or loss of functionality in some operating systems.
Key Storage Enable	The Key Storage Enable option controls the storage hierarchy of TPM, which is used to store digital keys. Disabling the Key Storage Enable option restricts the ability of TPM to store owner's data. By default, the Key Storage Enable option is enabled. For additional security, Dell Technologies recommends keeping the Key Storage Enable option enabled. i NOTE: When disabled, this feature may cause compatibility issues or loss of functionality in some operating systems.
SHA-256	Allows you to control the hashing algorithm that is used by the TPM. When enabled, the TPM uses the SHA-256 hashing algorithm. When disabled, the TPM uses the SHA-1 hash algorithm. By default, the SHA-256 option is enabled.

Table 33. System setup options—Security menu (continued)



Security	
	For additional security, Dell Technologies recommends keeping the SHA-256 option enabled.
Clear	<p>When enabled, the Clear option clears information that is stored in the TPM after exiting the computer's BIOS. This option returns to the disabled state when the computer restarts.</p> <p>By default, the Clear option is disabled.</p> <p>Dell Technologies recommends enabling the Clear option only when TPM data is required to be cleared.</p>
PPI Bypass for Clear Commands	<p>The PPI Bypass for Clear Commands option allows the operating system to manage certain aspects of PTT. When enabled, you are not prompted to confirm changes to the PTT configuration.</p> <p>By default, the PPI Bypass for Clear Commands option is disabled.</p> <p>For additional security, Dell Technologies recommends keeping the PPI Bypass for Clear Commands option disabled.</p>
Intel Total Memory Encryption	
Multi-Key Total Memory Encryption (Up to 16 keys)	<p>Total Memory Encryption is used to protect memory from physical attacks including freeze spray, probing DDR to read the cycles, and others.</p> <p>Default: OFF</p>
Chassis Intrusion	<p>Controls the chassis intrusion feature.</p> <p>Default: Disabled</p>
SMM Security Mitigation	
SMM Security Mitigation	<p>Enables or disables additional UEFI SMM Security Mitigation protections.</p> <p>Default: ON</p> <p> NOTE: This feature may cause compatibility issues or loss of functionality with some legacy tools and applications.</p>
Data Wipe on Next Boot	
Start Data Wipe	<p>Data Wipe is a secure wipe operation that deletes information from a storage device.</p> <p> CAUTION: The secure Data Wipe operation deletes information in a way that it cannot be reconstructed.</p> <p>Commands such as delete and format in the operating system may remove files from showing up in the file system. However, they can be reconstructed through forensic means as they are still represented on the physical media. Data Wipe prevents this reconstruction and is not recoverable.</p> <p>When enabled, the data wipe option will prompt to wipe any storage devices that are connected to the computer on the next boot.</p> <p>By default, the Start Data Wipe option is disabled.</p>
Absolute	
Absolute	<p>Absolute Software provides various cyber security solutions, some requiring software preloaded on Dell computers and integrated into the BIOS. To use these features, you must enable the Absolute BIOS setting and contact Absolute for configuration and activation.</p> <p>By default, the Absolute option is enabled.</p> <p>For additional security, Dell Technologies recommends keeping the Absolute option enabled.</p>

Table 33. System setup options—Security menu (continued)

Security	
<p> NOTE: When the Absolute features are activated, the Absolute integration cannot be disabled from the BIOS setup screen.</p>	
UEFI Boot Path Security	
UEFI Boot Path Security	<p>Enables or disables the computer to prompt the user to enter the Administrator password (if set) when booting to a UEFI boot path device from the F12 boot menu.</p> <p>By default, the Always Except Internal HDD option is enabled.</p>
Firmware Device Tamper Detection	
Firmware Device Tamper Detection	<p>Allows you to control the firmware device tamper detection feature. This feature notifies the user when the firmware device is tampered. When enabled, a screen warning messages is displayed on the computer and a tamper detection event is logged in the BIOS Events log. The computer fails to reboot until the event is cleared.</p> <p>By default, the Firmware Device Tamper Detection option is enabled.</p> <p>For additional security, Dell Technologies recommends keeping the Firmware Device Tamper Detection option enabled.</p>
Clear Firmware Device Tamper Detection	<p>Clears the event and enables booting.</p> <p>Default: OFF</p>

Table 34. System setup options—Passwords menu

Passwords	
Admin Password	<p>The Administrator Password prevents unauthorized access to the BIOS Setup options. Once the administrator password is set, the BIOS setup options can only be modified after providing the correct password.</p> <p>The following rules and dependencies apply to the Administrator Password -</p> <ul style="list-style-type: none"> • The administrator password cannot be set if computer and/or internal hard drive passwords are previously set. • The administrator password can be used in place of the computer and/or internal hard drive passwords. • When set, the administrator password must be provided during a firmware update. • Clearing the administrator password also clears the computer password (if set). <p>Dell Technologies recommends using an administrator password to prevent unauthorized changes to BIOS setup options.</p>
System Password	<p>The System Password prevents the computer from booting to an operating system without entering the correct password.</p> <p>The following rules and dependencies apply when the System Password is used -</p> <ul style="list-style-type: none"> • The computer shuts down when idle for approximately 10 minutes at the computer password prompt. • The computer shuts down after three incorrect attempts to enter the computer password. • The computer shuts down when the Esc key is pressed at the System Password prompt. • The computer password is not prompted when the computer resumes from standby mode. <p>Dell Technologies recommends using the computer password in situations where it is likely that a computer may be lost or stolen.</p>

Table 34. System setup options—Passwords menu (continued)

Passwords	
M.2 PCIe SSD-0	Sets, Changes, or deletes the SSD password.
Password Configuration	<p>The Password configuration page includes several options for changing the requirements of BIOS passwords. You can modify the minimum and maximum length of the passwords and require passwords to contain certain character classes (upper case, lower case, digit, special character).</p> <p>Dell Technologies recommends setting the minimum password length to at least eight characters.</p>
Upper Case Letter	<p>Enables or disables the requirement for at least one upper case letter.</p> <p>Default: OFF</p>
Lower Case Letter	<p>Enables or disables the requirement for at least one lower case letter.</p> <p>Default: OFF</p>
Digit	<p>Enables or disables the requirement for at least one-digit number.</p> <p>Default: OFF</p>
Special Character	<p>Enables or disables the requirement for at least one special character.</p> <p>Default: OFF</p>
Minimum Characters	<p>Specify the minimum number of characters allowed for the password.</p> <p>Default: 4</p>
Password Bypass	<p>The Password Bypass option allows the computer to reboot from the operating system without entering the computer or hard drive password. If the computer has already booted to the operating system, it is presumed that the user has already entered the correct computer or hard drive password.</p> <p>i NOTE: This option does not remove the requirement to enter the password after shutting down.</p> <p>By default, the Password Bypass option is enabled.</p> <p>For additional security, Dell Technologies recommends keeping the Password Bypass option enabled.</p>
Password Changes	
Enable Non-Admin Password Changes	<p>The Allow Non-Admin Password Changes option in BIOS setup allows an end user to set or change the computer or hard drive passwords without entering the administrator password. This gives an administrator control over the BIOS settings but enables an end user to provide their own password.</p> <p>By default, the Allow Non-Admin Password Changes option is disabled.</p> <p>For additional security, Dell Technologies recommends keeping the Allow Non-Admin Password Changes option disabled.</p>
Admin Setup Lockout	
Enable Admin Setup Lockout	<p>The Admin Setup Lockout option prevents an end user from even viewing the BIOS setup configuration without first entering the administrator password (if set).</p> <p>By default, the Enable Admin Setup Lockout option is disabled.</p> <p>For additional security, Dell Technologies recommends keeping the Admin Setup Lockout option disabled.</p>
Master Password Lockout	

Table 34. System setup options—Passwords menu (continued)

Passwords	
Enable Master Password Lockout	<p>The Master Password Lockout setting allows you to disable the Recovery Password feature. If the computer, administrator, or hard drive password is forgotten, the computer becomes unusable.</p> <p>NOTE: When the owner password is set, the Master Password Lockout option is not available.</p> <p>NOTE: When an internal hard drive password is set, it must first be cleared before Master Password Lockout can be changed.</p> <p>By default, the Enable Master Password Lockout option is disabled.</p> <p>Dell does not recommend enabling the Master Password Lockout unless you have implemented your own password recovery computer.</p>
Allow Non-Admin PSID Revert	
Enable Allow Non-Admin PSID Revert	<p>Controls access to Physical Security ID (PSID) revert of NVMe hard drives from the Dell Security Manager prompt.</p> <p>Default: OFF</p>

Table 35. System setup options—Update, Recovery menu

Update, Recovery	
UEFI Capsule Firmware Updates	
Enable UEFI Capsule Firmware Updates	<p>Enables or disables BIOS updates through UEFI capsule update packages.</p> <p>NOTE: Disabling this option blocks the BIOS updates from services such as Microsoft Windows Update and Linux Vendor Firmware Service (LVFS).</p> <p>By default, the Enable UEFI Capsule Firmware Updates option is enabled.</p>
BIOS Recovery from Hard Drive	
	<p>Enables or disables the user to recover from certain corrupted BIOS conditions from a recovery file on the user primary hard drive or an external USB drive.</p> <p>By default, the BIOS Recovery from Hard Drive option is enabled.</p> <p>NOTE: BIOS Recovery from Hard Drive is not available for self-encrypting drives (SED).</p> <p>NOTE: BIOS recovery is designed to fix the main BIOS block and cannot work if the Boot Block is damaged. In addition, this feature cannot work in the event of EC corruption, ME corruption, or a hardware issue. The recovery image must exist on an unencrypted partition on the drive.</p>
BIOS Downgrade	
Allow BIOS Downgrade	<p>Controls flashing of the computer firmware to previous revisions.</p> <p>By default, the Allow BIOS Downgrade option is enabled.</p>
SupportAssist OS Recovery	
	<p>Enables or disables the boot flow for SupportAssist OS Recovery tool in the event of certain computer errors.</p> <p>By default, the SupportAssist OS Recovery option is enabled.</p>
BIOSConnect	
	<p>Enables or disables cloud Service operating system recovery if the main operating system fails to boot with the number of failures equal to or greater than the value specified by the Auto operating system Recovery Threshold setup option and local Service operating system does not boot or is not installed.</p> <p>By default, the BIOSConnect option is enabled.</p>
Dell Auto OS Recovery Threshold	
	<p>Allows you to control the automatic boot flow for SupportAssist System Resolution Console and for Dell operating system Recovery Tool.</p> <p>By default, the Dell Auto OS Recovery Threshold value is set to 2.</p>

Table 36. System setup options—System Management menu

System Management	
Service Tag	Displays the Service Tag of the computer.
Asset Tag	Creates a computer Asset Tag that can be used by an IT administrator to uniquely identify a particular computer.  NOTE: Once set in BIOS, the Asset Tag cannot be changed.
AC Behavior	
Wake on AC	Enables or disables the computer to turn on and go to boot when AC power is supplied to the computer. By default, the Wake on AC option is disabled.
Wake on LAN	Enables or disables the computer to turn on by a special LAN signal. By default, the Wake on LAN option is disabled.
Auto On Time	Enable to set the computer to turn on automatically every day or on a preselected date and time. This option can be configured only if the Auto On Time is set to Everyday, Weekdays, or Selected Days. By default, the Auto On Time option is disabled.
Intel AMT Capability	
Enable Intel AMT Capability	When enabled, MEBx is available through F12 menu and users can provision AMT. Default: Restrict Preboot Access
First Power On Date	
Set Ownership Date	Enables you to set the ownership date. Default: Disabled
Diagnostics	
OS Agent Requests	When enabled, Dell OS agents are capable of scheduling onboard diagnostics on a subsequent boot which can help in the prevention and resolution of hardware-related issues. Default: ON
Power-on-Self-Test Automatic Recovery	
Power-on-Self-Test Automatic Recovery	When enabled, if the computer becomes unresponsive before completing the BIOS Power-On-Self-Test (POST), the BIOS attempts to automatically recover the computer. Default: ON

Table 37. System setup options—Keyboard menu

Keyboard	
Fn Lock Options	Enables or disables the Fn Lock option. By default, the Fn Lock option is enabled.
Lock Mode	By default, the Lock Mode Secondary option is enabled. With this option, the F1-F12 keys scan the code for their secondary functions.
Keyboard Illumination	Configures the operating mode of the keyboard illumination feature. By default, the Bright option is selected. Enables the keyboard illumination feature at 100% brightness level.

Table 37. System setup options—Keyboard menu (continued)

Keyboard	
Keyboard Backlight Timeout on AC	<p>Sets the timeout value for the keyboard backlight when an AC adapter is connected to the computer.</p> <p>By default, the 5 minute option is selected.</p>
Keyboard Backlight Timeout on Battery	<p>Sets the timeout value for the keyboard backlight when the computer is running only on the battery power. The keyboard backlight timeout value is only effective when the backlight is enabled.</p> <p>By default, the 5 minute option is selected.</p>
Device Configuration HotKey Access	<p>Allows you to control whether you can access device configuration screens through hotkeys during computer startup.</p> <p>By default, the Device Configuration HotKey Access option is enabled.</p> <p>NOTE: This setting controls only the Intel RAID (CTRL+I), MEBX (CTRL+P), and LSI RAID (CTRL+C) Option ROMs. Other preboot Option ROMs, which support entry using a key sequence, are not affected by this setting.</p>

Table 38. System setup options—Pre-boot Behavior menu

Pre-boot Behavior	
Adapter Warnings	
Enable Adapter Warnings	<p>Enables the warning messages during boot when the adapters with less power capacity are detected.</p> <p>By default, the Enable Adapter Warnings option is enabled.</p>
Warnings and Errors	<p>Enables or disables the action to be taken when a warning or error is encountered.</p> <p>By default, the Prompt on Warnings and Errors option is selected. Stop, prompt, and wait for user input when warnings or errors are detected.</p> <p>NOTE: Errors deemed critical to the operation of the computer hardware stop the functioning of the computer.</p>
Extend BIOS POST Time	<p>Sets the BIOS POST (Power-On Self-Test) load time.</p> <p>By default, the 0 seconds option is selected.</p>
MAC Address Pass-Through	<p>Replaces the external NIC MAC address (in a supported dock or dongle) with the selected MAC address from the computer.</p> <p>By default, the System Unique MAC Address option is selected.</p>
Sign of Life	
Early Logo Display	<p>Display Logo Sign of Life.</p> <p>By default, the Early Logo Display option is enabled.</p>
Early Keyboard Backlight	<p>Keyboard Backlight Sign of Life.</p> <p>By default, the Early Keyboard Backlight option is enabled.</p>

Table 39. System setup options—Virtualization Support menu

Virtualization Support	
Intel Virtualization Technology	
Enable Intel Virtualization Technology (VT)	<p>When enabled, the computer can run a Virtual Machine Monitor (VMM).</p> <p>By default, the Enable Intel Virtualization Technology (VT) option is enabled.</p>
VT for Direct I/O	

Table 39. System setup options—Virtualization Support menu (continued)

Virtualization Support	
Enable Intel VT for Direct I/O	<p>When enabled, the computer can perform Virtualization Technology for Direct I/O (VT-d). VT-d is an Intel method that provides virtualization for memory map I/O.</p> <p>By default, the Enable Intel VT for Direct I/O option is enabled.</p>
Intel Trusted Execution Technology (TXT)	<p>Intel Trusted Execution Technology (TXT) is a set of hardware extensions to Intel processors and chipsets. It provides a hardware-based root of trust to ensure that a platform boots with a known good configuration of firmware, BIOS, virtual machine monitor, and operating system. The following must be enabled in order to enable Intel TXT -</p> <ul style="list-style-type: none"> • Intel Virtualization Technology - X • Intel Virtualization Technology - Direct <p>By default, the Intel Trusted Execution Technology (TXT) option is enabled.</p> <p>For additional security, Dell Technologies recommends keeping the Intel Trusted Execution Technology (TXT) option enabled.</p>
DMA Protection	
Enable Pre-Boot DMA Support	<p>Allows you to control the Pre-Boot DMA protection for both internal and external ports. This option does not directly enable DMA protection in the operating system.</p> <p>i NOTE: This option is not available when the virtualization setting for IOMMU is disabled (VT-d/AMD Vi).</p> <p>By default, the Enable Pre-Boot DMA Support option is enabled.</p> <p>For additional security, Dell Technologies recommends keeping the Enable Pre-Boot DMA Support option enabled.</p> <p>i NOTE: This option is provided only for compatibility purposes, since some older hardware is not DMA capable.</p>
Enable OS Kernel DMA Support	<p>Allows you to control the Kernel DMA protection for both internal and external ports. This option does not directly enable DMA protection in the operating system. For operating systems that support DMA protection, this setting indicates to the operating system that the BIOS supports the feature.</p> <p>i NOTE: This option is not available when the virtualization setting for IOMMU is disabled (VT-d/AMD Vi).</p> <p>By default, the Enable OS Kernel DMA Support option is enabled.</p> <p>i NOTE: This option is provided only for compatibility purposes, since some older hardware is not DMA capable.</p>

Table 40. System setup options—Performance menu

Performance	
Multi-Core Support	
Multiple Atom Cores	<p>Enables to change the number of Atom cores available to the operating system. The default value is set to the maximum number of cores.</p> <p>By default, the All Active option is selected.</p>
Active Multiple Performance Cores (P-Cores)	<p>Enables to enter the number of active multiple performance cores.</p> <p>Default: 03</p>
Active Efficient Cores (E-Cores) Select	<p>Enables you to change the number of processor E-Cores available to the operating system.</p> <p>Default: All Active</p>

Table 40. System setup options—Performance menu (continued)

Performance	
Active Efficient Cores (E-Cores) Number	Enables to enter the number of active efficient cores. Default: 07
Intel SpeedStep	
Enable Intel SpeedStep Technology	Enables the computer to dynamically adjust processor voltage and core frequency, decreasing average power consumption and heat production. By default, the Enable Intel SpeedStep Technology option is enabled.
C-State Control	
Enable C-State Control	Enables or disables the ability of the CPU to enter and exit low-power state. When disabled, it disables all C-states. When enabled, it enables all C-states that the chipset or platform allows. By default, the Enable C-State Control option is enabled.
Intel Turbo Boost Technology	
Enable Intel Turbo Boost Technology	Enables the Intel TurboBoost mode of the processor. When enabled, the Intel TurboBoost driver increases the performance of the CPU or graphics processor. By default, the Enable Intel Turbo Boost Technology option is enabled.
Intel Hyper-Threading Technology	
Enable Intel Hyper-Threading Technology	Enables the Intel Hyper-Threading mode of the processor. When enabled, the Intel Hyper-Threading increases the efficiency of the processor resources when multiple threads run on each core. By default, the Intel Hyper-Threading Technology option is enabled.

Table 41. System setup options—System Logs menu

System Logs	
BIOS Event Log	
Clear BIOS Event Log	Allows you to select option to keep or clear BIOS events logs. By default, the Keep Log option is selected.
Thermal Event Log	
Clear Thermal Event Log	Allows you to select option to keep or clear Thermal events logs. By default, the Keep Log option is selected.
Power Event Log	
Clear Power Event Log	Allows you to select option to keep or clear Power events logs. By default, the Keep Log option is selected.

Updating the BIOS

Updating the BIOS in Windows

Steps

1. Go to www.dell.com/support.
2. Click **Product support**. In the **Search support** box, enter the Service Tag of your computer, and then click **Search**.

 **NOTE:** If you do not have the Service Tag, use the SupportAssist feature to automatically identify your computer. You can also use the product ID or manually browse for your computer model.

3. Click **Drivers & Downloads**. Expand **Find drivers**.
4. Select the operating system installed on your computer.
5. In the **Category** drop-down list, select **BIOS**.
6. Select the latest version of BIOS, and click **Download** to download the BIOS file for your computer.
7. After the download is complete, browse the folder where you saved the BIOS update file.
8. Double-click the BIOS update file icon and follow the on-screen instructions.

For more information about how to update the system BIOS, search in the Knowledge Base Resource at www.dell.com/support.

Updating the BIOS using the USB drive in Windows

Steps

1. Follow the procedure from step 1 to step 6 in [Updating the BIOS in Windows](#) to download the latest BIOS setup program file.
2. Create a bootable USB drive. For more information, search the Knowledge Base Resource at www.dell.com/support.
3. Copy the BIOS setup program file to the bootable USB drive.
4. Connect the bootable USB drive to the computer that needs the BIOS update.
5. Restart the computer and press **F12**.
6. Select the USB drive from the **One Time Boot Menu**.
7. Type the BIOS setup program filename and press **Enter**.
The **BIOS Update Utility** appears.
8. Follow the on-screen instructions to complete the BIOS update.

Updating the BIOS from the F12 One Time Boot menu

Update your computer BIOS using the BIOS update.exe file that is copied to a FAT32 USB drive and booting from the F12 **One Time Boot** menu.

About this task

BIOS Update

You can run the BIOS update file from Windows using a bootable USB drive or you can also update the BIOS from the F12 **One Time Boot** menu on the computer.

Most of the Dell computers built after 2012 have this capability, and you can confirm by booting your computer to the F12 **One Time Boot** Menu to see if BIOS FLASH UPDATE is listed as a boot option for your computer. If the option is listed, then the BIOS supports this BIOS update option.

 **NOTE:** Only computers with the BIOS Flash Update option in the F12 **One Time Boot** menu can use this function.

Updating from the One Time Boot menu

To update your BIOS from the F12 **One Time Boot** menu, you need the following:

- USB drive formatted to the FAT32 file system (key does not have to be bootable)
- BIOS executable file that you downloaded from the Dell Support website and copied to the root of the USB drive
- AC power adapter that is connected to the computer
- Functional computer battery to flash the BIOS

Perform the following steps to perform the BIOS update flash process from the F12 menu:

 **CAUTION:** Do not turn off the computer during the BIOS update process. The computer may not boot if you turn off your computer.

Steps

1. From a turn off state, insert the USB drive where you copied the flash into a USB port of the computer.

2. Turn on the computer and press F12 to access the **One Time Boot** Menu, select BIOS Update using the mouse or arrow keys then press Enter.
The flash BIOS menu is displayed.
3. Click **Flash from file**.
4. Select an external USB device.
5. Select the file and double-click the flash target file, and then click **Submit**.
6. Click **Update BIOS**. The computer restarts to flash the BIOS.
7. The computer will restart after the BIOS update is completed.

System and setup password

Table 42. System and setup password

Password type	Description
System password	Password that you must enter to log in to your system.
Setup password	Password that you must enter to access and make changes to the BIOS settings of your computer.

You can create a system password and a setup password to secure your computer.

 **CAUTION:** The password features provide a basic level of security for the data on your computer.

 **CAUTION:** Anyone can access the data that is stored on your computer, when not locked and left unattended.

 **NOTE:** System and setup password feature is disabled.

Assigning a System Setup password

Prerequisites

You can assign a new System or Admin Password only when the status is in **Not Set**.

About this task

To enter BIOS System Setup, press F2 immediately after a power-on or reboot.

Steps

1. In the **System BIOS** or **System Setup** screen, select **Security** and press Enter.
The **Security** screen is visible.
2. Select **System/Admin Password** and create a password in the **Enter the new password** field.
Use the following guidelines to assign the system password:
 - A password can have up to 32 characters.
 - At least one special character: "(! " # \$ % & ' * + , - . / : ; < = > ? @ [\] ^ _ ` { | })"
 - Numbers 0 to 9.
 - Upper case letters from A to Z.
 - Lower case letters from a to z.
3. Type the system password that you entered earlier in the **Confirm new password** field and click **OK**.
4. Press Esc and save the changes as prompted by the message.
5. Press Y to save the changes.
The computer restarts.

Deleting or changing an existing system setup password

Prerequisites

Ensure that the **Password Status** is Unlocked (in the System Setup) before attempting to delete or change the existing System and/or Setup password. You cannot delete or change an existing System or Setup password, if the **Password Status** is Locked.

About this task

To enter the System Setup, press F2 immediately after a power-on or reboot.

Steps

1. In the **System BIOS** or **System Setup** screen, select **System Security** and press Enter.
The **System Security** screen is displayed.
2. In the **System Security** screen, verify that the Password Status is **Unlocked**.
3. Select **System Password**, update, or delete the existing system password, and press Enter or Tab.
4. Select **Setup Password**, update, or delete the existing setup password, and press Enter or Tab.
 **NOTE:** If you change the System and/or Setup password, reenter the new password when prompted. If you delete the System and/or Setup password, confirm the deletion when prompted.
5. Press Esc. A message prompts you to save the changes.
6. Press Y to save the changes and exit from System Setup.
The computer restarts.

Clearing BIOS (System Setup) and System passwords

About this task

To clear the system or BIOS passwords, contact Dell technical support as described at www.dell.com/contactdell.

-  **NOTE:** For information about how to reset Windows or application passwords, see the documentation accompanying Windows or your application.

Troubleshooting

Handling swollen rechargeable Li-ion batteries

Like most laptops, Dell laptops use Lithium-ion batteries. One type of Lithium-ion battery is the rechargeable Li-ion battery. Rechargeable Li-ion batteries have increased in popularity in recent years and have become standard in the electronics industry due to customer preferences for a slim form factor (especially with newer ultra-thin laptops) and long battery life. Inherent to rechargeable Li-ion battery technology is the potential for swelling of the battery cells.

A swollen battery may impact the performance of the laptop. To prevent possible further damage to the device enclosure or internal components leading to malfunction, discontinue the use of the laptop and discharge it by disconnecting the AC adapter and letting the battery drain.

Swollen batteries should not be used and should be replaced and disposed of properly. We recommend contacting Dell product support for options to replace a swollen battery under the terms of the applicable warranty or service contract, including options for replacement by a Dell authorized service technician.

The guidelines for handling and replacing rechargeable Li-ion batteries are as follows:

- Exercise caution when handling rechargeable Li-ion batteries.
- Discharge the battery before removing it from the system. To discharge the battery, unplug the AC adapter from the system and operate the system only on battery power. When the system will no longer turn on when the power button is pressed, the battery is fully discharged.
- Do not crush, drop, mutilate, or penetrate the battery with foreign objects.
- Do not expose the battery to high temperatures, or disassemble battery packs and cells.
- Do not apply pressure to the surface of the battery.
- Do not bend the battery.
- Do not use tools of any type to pry on or against the battery.
- If a battery gets stuck in a device as a result of swelling, do not try to free it as puncturing, bending, or crushing a battery can be dangerous.
- Do not attempt to reassemble a damaged or swollen battery into a laptop.
- Swollen batteries that are covered under warranty should be returned to Dell in an approved shipping container (provided by Dell)—this is to comply with transportation regulations. Swollen batteries that are not covered under warranty should be disposed of at an approved recycling center. Contact Dell product support at <https://www.dell.com/support> for assistance and further instructions.
- Using a non-Dell or incompatible battery may increase the risk of fire or explosion. Replace the battery only with a compatible battery purchased from Dell that is designed to work with your Dell computer. Do not use a battery from other computers with your computer. Always purchase genuine batteries from <https://www.dell.com> or otherwise directly from Dell.

Rechargeable Li-ion batteries can swell for various reasons such as age, number of charge cycles, or exposure to high heat. For more information about how to improve the performance and lifespan of the laptop battery and to minimize the possibility of occurrence of the issue, search Dell Laptop Battery in the Knowledge Base Resource at www.dell.com/support.

Locate the Service Tag or Express Service Code of your Dell computer

Your Dell computer is uniquely identified with a Service Tag or Express Service Code. To view relevant support resources for your Dell computer, we recommend entering the Service Tag or Express Service Code at www.dell.com/support.

For more information about how to find the Service Tag for your computer, see [Locate the Service Tag on your computer](#).

Dell SupportAssist Pre-boot System Performance Check diagnostics

About this task

SupportAssist diagnostics (also known as system diagnostics) performs a complete check of your hardware. The Dell SupportAssist Pre-boot System Performance Check diagnostics is embedded with the BIOS and launched by the BIOS internally. The embedded system diagnostics provides options for particular devices or device groups allowing you to:

- Run tests automatically or in an interactive mode.
- Repeat the tests.
- Display or save test results.
- Run thorough tests to introduce additional test options to provide extra information about one or more failed devices.
- View status messages that inform you the tests are completed successfully.
- View error messages that inform you of problems encountered during testing.

 **NOTE:** Some tests for specific devices require user interaction. Always ensure that you are present at the computer terminal when the diagnostic tests are performed.

For more information, see the knowledge base article [000180971](#).

Running the SupportAssist Pre-Boot System Performance Check

Steps

1. Turn on your computer.
2. As the computer boots, press the F12 key as the Dell logo appears.
3. On the boot menu screen, select the **Diagnostics** option.
4. Click the arrow at the bottom left corner.
Diagnostics front page is displayed.
5. Click the arrow in the lower-right corner to go to the page listing.
The items that are detected are listed.
6. To run a diagnostic test on a specific device, press Esc and click **Yes** to stop the diagnostic test.
7. Select the device from the left pane and click **Run Tests**.
8. If there are any issues, error codes are displayed.
Note the error code and validation number and contact Dell.

Built-in self-test (BIST)

M-BIST

M-BIST (Built In Self-Test) is the system board built-in self-test diagnostics tool that improves the diagnostics accuracy of system board Embedded Controller (EC) failures.

 **NOTE:** M-BIST can be manually initiated before Power On Self-Test (POST).

How to run M-BIST

 **NOTE:** M-BIST must be initiated on the computer from a power-off state that is either connected to AC power or with a battery only.

1. Press and hold both the **M** key on the keyboard and the **power button** to initiate M-BIST.
2. The battery indicator LED may exhibit two states:
 - a. OFF: No fault was detected with the system board.
 - b. AMBER: Amber indicates a problem with the system board.

- If there is a failure with the system board, the battery status LED flashes one of the following error codes for 30 seconds:

Table 43. LED error codes

Blinking Pattern		Possible Problem
Amber	White	
2	1	CPU Failure
2	8	LCD Power Rail Failure
1	1	TPM Detection Failure
2	4	Memory/RAM failure

- If there is no failure with the system board, the LCD cycles through the solid color screens that are described in the LCD-BIST section for 30 seconds and then turn off.

LCD Power rail test (L-BIST)

L-BIST is an enhancement to the single LED error code diagnostics and is automatically initiated during POST. L-BIST will check the LCD power rail. If there is no power being supplied to the LCD (that is if the L-BIST circuit fails), the battery status LED flashes either an error code [2,8] or an error code [2,7].

NOTE: If L-BIST fails, LCD-BIST cannot function as no power will be supplied to the LCD.

How to invoke the L-BIST Test:

- Press the power button to start the computer.
- If the computer does not start up normally, look at the battery status LED:
 - If the battery status LED flashes an error code [2,7], the display cable may not be connected properly.
 - If the battery status LED flashes an error code [2,8], there is a failure on the LCD power rail of the system board, hence there is no power that is supplied to the LCD.
- For cases, when a [2,7] error code is shown, check to see if the display cable is properly connected.
- For cases when a [2,8] error code is shown, replace the system board.

LCD Built-in Self-Test (BIST)

Dell laptops have a built-in diagnostic tool that helps you determine if the screen abnormality you are experiencing is an inherent problem with the LCD (screen) of the Dell laptop or with the video card (GPU) and computer settings.

When you notice screen abnormalities like flickering, distortion, clarity issues, fuzzy or blurry image, horizontal or vertical lines, color fade and so on, it is always a good practice to isolate the LCD (screen) by running the Built-In Self-Test (BIST).

How to invoke the LCD BIST Test

- Power off the Dell laptop.
- Disconnect any peripherals that are connected to the laptop. Connect only the AC adapter (charger) to the laptop.
- Ensure that the LCD (screen) is clean (no dust particles on the surface of the screen).
- Press and hold the **D** key and **Power on** the laptop to enter LCD built-in self-test (BIST) mode. Continue to hold the D key until the computer boots up.
- The screen displays solid colors and change colors on the entire screen to white, black, red, green, and blue twice.
- Then it displays the colors white, black, and red.
- Carefully inspect the screen for abnormalities (any lines, fuzzy color, or distortion on the screen).
- At the end of the last solid color (red), the computer shuts down.

NOTE: Dell SupportAssist Preboot diagnostics upon launch initiates an LCD BIST first, expecting a user intervention to confirm functionality of the LCD.

Diagnostic error codes

The Service LED is used for computer diagnostics, and it emits amber or white light. A Dell service representative uses the LED light patterns to troubleshoot your device.

 **NOTE:** An error code of **35** indicates an EC power-rail error. This error may occur during Power-On Self-Test (POST). Contact [Dell Support](#) for assistance.

Recovering the operating system

When your computer is unable to boot to the operating system even after repeated attempts, it automatically starts Dell SupportAssist OS Recovery.

Dell SupportAssist OS Recovery is a stand-alone tool that is preinstalled in all Dell computers that are installed with the Windows operating system. It consists of tools to diagnose and troubleshoot issues that may occur before your computer boots to the operating system. It enables you to diagnose hardware issues, repair your computer, back up your files, or restore your computer to its factory state.

You can also download it from the Dell Support website to troubleshoot and fix your computer when it fails to boot into their primary operating system due to software or hardware failures.

For more information about the Dell SupportAssist OS Recovery, see *Dell SupportAssist OS Recovery User's Guide* at www.dell.com/serviceabilitytools. Click **SupportAssist** and then, click **SupportAssist OS Recovery**.

Real-Time Clock (RTC Reset)

The Real Time Clock (RTC) reset function allows you or the service technician to recover Dell computers from No POST/No Power/No Boot situations. The legacy jumper enabled RTC reset has been retired on these models.

Start the RTC reset with the computer powered off and connected to AC power. Press and hold the power button for thirty (30) seconds. The computer RTC Reset occurs after you release the power button.

Backup media and recovery options

It is recommended to create a recovery drive to troubleshoot and fix problems that may occur with Windows. Dell proposes multiple options for recovering the Windows operating system on your Dell computer. For more information, see [Dell Windows Backup Media and Recovery Options](#).

Wi-Fi power cycle

About this task

If your computer is unable to access the Internet due to Wi-Fi connectivity issues a Wi-Fi power cycle procedure may be performed. The following procedure provides the instructions on how to conduct a Wi-Fi power cycle:

 **NOTE:** Some Internet Service Providers (ISPs) provide a modem or router combo device.

Steps

1. Turn off your computer.
2. Turn off the modem.
3. Turn off the wireless router.
4. Wait for 30 seconds.
5. Turn on the wireless router.
6. Turn on the modem.
7. Turn on your computer.

Drain residual flea power (perform hard reset)

About this task

Flea power is the residual static electricity that remains in the computer even after it has been powered off and the battery is removed.

For your safety, and to protect the sensitive electronic components in your computer, you are requested to drain residual flea power before removing or replacing any components in your computer.

Draining residual flea power, also known as a performing a "hard reset", is also a common troubleshooting step if your computer does not turn on or boot into the operating system.

Procedure to drain residual flea power (perform a hard reset)

Steps

1. Turn off your computer.
2. Disconnect the power adapter from your computer.
3. Remove the base cover.
4. Remove the battery.
5. Press and hold the power button for 20 seconds to drain the flea power.
6. Install the battery.
7. Install the base cover.
8. Connect the power adapter to your computer.
9. Turn on your computer.



 **NOTE:** For more information about performing a hard reset, search in the Knowledge Base Resource at www.dell.com/support.

Getting help and contacting Dell

Self-help resources

You can get information and help on Dell products and services using these self-help resources:

Table 44. Self-help resources

Self-help resources	Resource location
Information about Dell products and services	www.dell.com
My Dell app	
Tips	
Contact Support	In Windows search, type <code>Contact Support</code> , and press Enter.
Online help for operating system	www.dell.com/support/windows
Access top solutions, diagnostics, drivers and downloads, and learn more about your computer through videos, manuals, and documents.	Your Dell computer is uniquely identified by a Service Tag or Express Service Code. To view relevant support resources for your Dell computer, enter the Service Tag or Express Service Code at www.dell.com/support . For more information about how to find the Service Tag for your computer, see Locate the Service Tag on your computer .
Dell knowledge base articles	<ol style="list-style-type: none"> 1. Go to www.dell.com/support. 2. On the menu bar at the top of the Support page, select Support > Knowledge Base. 3. In the Search field on the Knowledge Base page, type the keyword, topic, or model number, and then click or tap the search icon to view the related articles.

Contacting Dell

To contact Dell for sales, technical support, or customer service issues, see www.dell.com/contactdell.

 **NOTE:** Availability varies by country/region and product, and some services may not be available in your country/region.

 **NOTE:** If you do not have an active Internet connection, you can find contact information about your purchase invoice, packing slip, bill, or Dell product catalog.