

Vostro 3030 Small Desktop

Owner's Manual

Notes, cautions, and warnings

 **NOTE:** A NOTE indicates important information that helps you make better use of your product.

 **CAUTION:** A CAUTION indicates either potential damage to hardware or loss of data and tells you how to avoid the problem.

 **WARNING:** A WARNING indicates a potential for property damage, personal injury, or death.

Chapter 1: Views of Vostro 3030 Small Desktop.....	6
Front.....	6
Back.....	7
Service Tag.....	8
Chapter 2: Set up your Vostro 3030 Small Desktop.....	10
Chapter 3: Specifications of Vostro 3030 Small Desktop.....	14
Dimensions and weight.....	14
Processor.....	14
Chipset.....	15
Operating system.....	15
Memory.....	15
Memory matrix.....	16
External ports and slots.....	16
Internal slots.....	17
Ethernet.....	17
Wireless module.....	18
Audio.....	18
Storage.....	19
Media-card reader.....	19
Power ratings.....	19
Power supply connector.....	20
GPU—Integrated.....	20
Multiple display support matrix.....	21
Hardware security.....	21
Environmental.....	22
Regulatory compliance.....	22
Operating and storage environment.....	22
Dell support policy.....	23
Chapter 4: Working inside your computer.....	24
Safety instructions.....	24
Before working inside your computer.....	24
Safety precautions.....	25
Electrostatic discharge—ESD protection.....	25
ESD Field Service kit	26
Transporting sensitive components.....	27
After working inside your computer.....	27
BitLocker.....	27
Recommended tools.....	27
Screw list.....	28
Major components of Vostro 3030 Small Desktop.....	29

Chapter 5: Removing and installing Customer Replaceable Units (CRUs)	31
Left-side cover.....	31
Removing the left-side cover.....	31
Installing the left-side cover.....	32
Front cover.....	32
Removing the front cover.....	32
Installing the front cover.....	33
Hard drive.....	34
Removing the 3.5-inch hard drive.....	34
Installing the 3.5-inch hard drive.....	35
Hard-drive and optical-drive cage.....	37
Removing the hard-drive and optical-drive cage.....	37
Installing the hard-drive and optical-drive cage.....	38
Optical drive (optional).....	40
Removing the optical drive.....	40
Installing the optical drive.....	41
Power button.....	42
Removing the power button.....	42
Installing the power button.....	43
Memory.....	44
Removing the memory.....	44
Installing the memory.....	44
Solid-state drive.....	45
Removing the M.2 2230 solid-state drive.....	45
Installing the M.2 2230 solid-state drive.....	46
Removing the M.2 2280 solid-state drive.....	47
Installing the M.2 2280 solid-state drive.....	48
Wireless card.....	49
Removing the wireless card.....	49
Installing the wireless card.....	50
Coin-cell battery.....	51
Removing the coin-cell battery.....	51
Installing the coin-cell battery.....	52
Media-card reader (optional).....	53
Removing the media-card reader.....	53
Installing the media-card reader.....	54
External antenna.....	55
Removing the external antenna.....	55
Installing the external antenna.....	56
Chapter 6: Removing and installing Field Replaceable Units (FRUs)	58
Power supply unit.....	58
Removing the power supply unit.....	58
Installing the power supply unit.....	60
Antenna modules.....	61
Removing the antenna module.....	61
Installing the antenna module.....	62
SMA antenna kit	63

Removing the SMA antenna kit.....	63
Installing the SMA antenna kit.....	64
Fan shroud.....	66
Removing the fan shroud.....	66
Installing the fan shroud.....	66
Processor fan and heat-sink assembly.....	67
Removing the processor fan and heat-sink assembly.....	67
Installing the processor fan and heat-sink assembly.....	68
Processor.....	69
Removing the processor.....	69
Installing the processor.....	70
System board.....	71
Removing the system board.....	71
Installing the system board.....	75
Chapter 7: Software.....	80
Operating system.....	80
Drivers and downloads.....	80
Chapter 8: BIOS Setup.....	81
Entering BIOS Setup program.....	81
Navigation keys.....	81
One time boot menu.....	81
F12 One Time Boot menu.....	82
System setup options.....	82
Updating the BIOS.....	95
Updating the BIOS in Windows.....	95
Updating the BIOS in Linux and Ubuntu.....	95
Updating the BIOS using the USB drive in Windows.....	95
Updating the BIOS from the One-Time boot menu.....	96
System and setup password.....	96
Assigning a System Setup password.....	97
Deleting or changing an existing system password or setup password.....	97
Clearing CMOS settings.....	98
Clearing BIOS (System Setup) and System passwords.....	98
Chapter 9: Troubleshooting.....	99
Dell SupportAssist Pre-boot System Performance Check diagnostics.....	99
Running the SupportAssist Pre-Boot System Performance Check.....	99
Power-Supply Unit Built-in Self-Test	99
System-diagnostic lights.....	100
Recovering the operating system.....	100
Real Time Clock—RTC reset.....	101
Backup media and recovery options.....	101
Wi-Fi power cycle.....	101
Chapter 10: Getting help and contacting Dell.....	102

Views of Vostro 3030 Small Desktop

Front

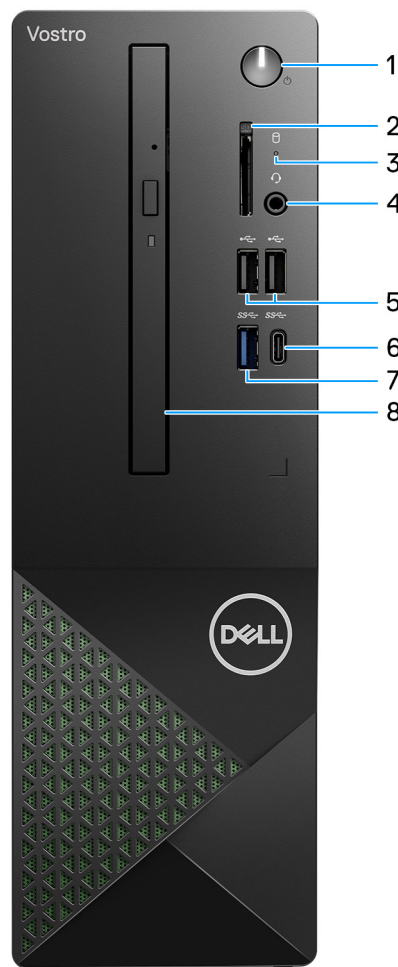

Figure 1. Front view

1. Power button

Press to turn on the computer if it is turned off, in sleep state, or in hibernate state.

Press to put the computer in sleep state if it is turned on.

Press and hold to force shut-down the computer.

NOTE: You can customize the power-button behavior in Windows.

2. SD-card slot (optional)

Reads from and writes to the SD card. The computer supports the following card types:

- Secure Digital (SD)
- Secure Digital High Capacity (SDHC)
- Secure Digital Extended Capacity (SDXC)

3. Hard-drive activity light

The activity light turns on when the computer reads from or writes to the hard drive.

4. One global headset (headphone and microphone combo) jack

Connect headphones or a headset (headphone and microphone combo).

5. Two USB 2.0 ports

Connect devices such as external storage devices and printers. Provides data transfer speeds up to 480 Mbps.

6. One USB 3.2 Type-C Gen 1 port

Connect devices such as external storage devices and printers. Provides data transfer speeds up to 5 Gbps.

7. One USB 3.2 Gen 1 port

Connect devices such as external storage devices and printers. Provides data transfer speeds up to 5 Gbps.

8. Slim optical drive (optional)

The optical drive reads from and writes to CDs and DVDs.

Back

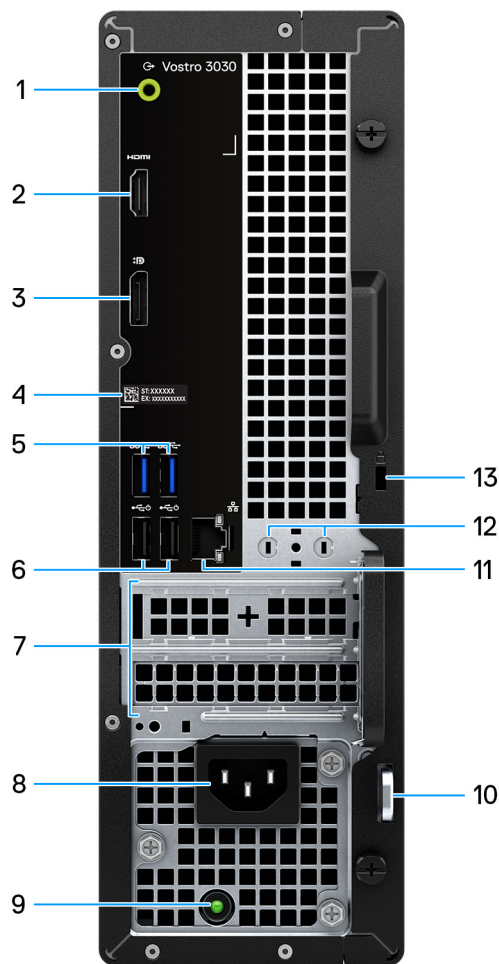



Figure 2. Back view

1. Line-out port

Connect speakers.

2. HDMI 1.4b port

Connect to a TV, external display, or another HDMI-in enabled device. Provides video and audio output.

 **NOTE:** The maximum resolution that is supported by the HDMI 1.4b port is 1920 x 1200.

3. DisplayPort 1.4 port

Connect an external display or a projector.

4. Service Tag label

The Service Tag is a unique alphanumeric identifier that enables Dell service technicians to identify the hardware components in your computer and access warranty information.

5. Two USB 3.2 Gen 1 ports

Connect devices such as external storage devices and printers. Provides data transfer speeds up to 5 Gbps.

6. Two USB 2.0 ports with SmartPower on

Connect devices such as external storage devices and printers. Provides data transfer speeds up to 480 Mbps. Wake from standby with the keyboard or mouse that is connected to this port.

7. PCI-Express x1 slot (half-height) and PCI-Express X16 slot (half-height)

Connect a PCI-express card such as an audio or network card to enhance the capabilities of your computer.

8. Power cable connector

Connect a power cable to provide power to your computer.

9. Power-supply diagnostics light

Indicates the power-supply state.

10. Padlock ring

Attach a standard padlock to prevent unauthorized access to the interior of your computer.

11. Network port

Connect an Ethernet (RJ-45) cable from a router or a broadband modem for network or Internet access.

12. External antenna connector (optional)

Connect an external antenna module.

13. Security-cable slot

Connect a security cable to prevent unauthorized movement of your computer.

Service Tag

The service tag is a unique alphanumeric identifier that allows Dell service technicians to identify the hardware components in your computer and access warranty information.



Figure 3. Service Tag location

Set up your Vostro 3030 Small Desktop

Steps

1. Connect the keyboard and mouse.

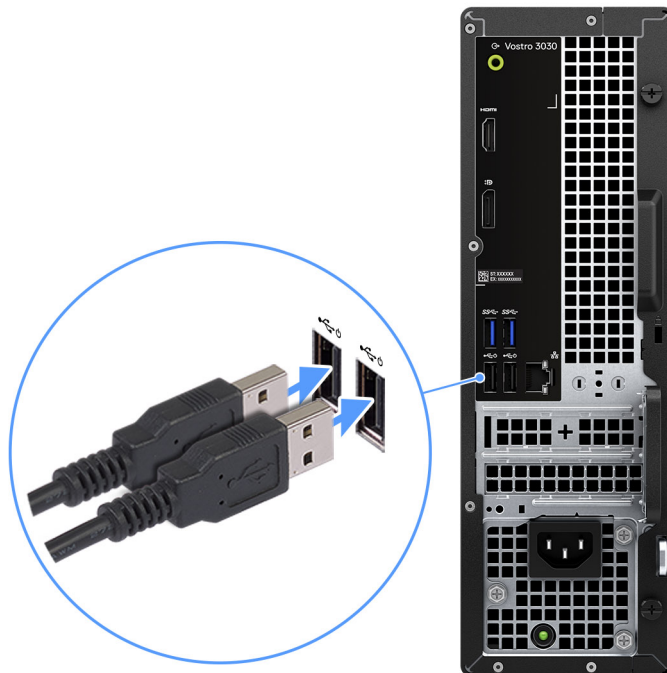

Figure 4. Connect the keyboard and mouse

2. Connect to your network using a cable, or connect to a wireless network.

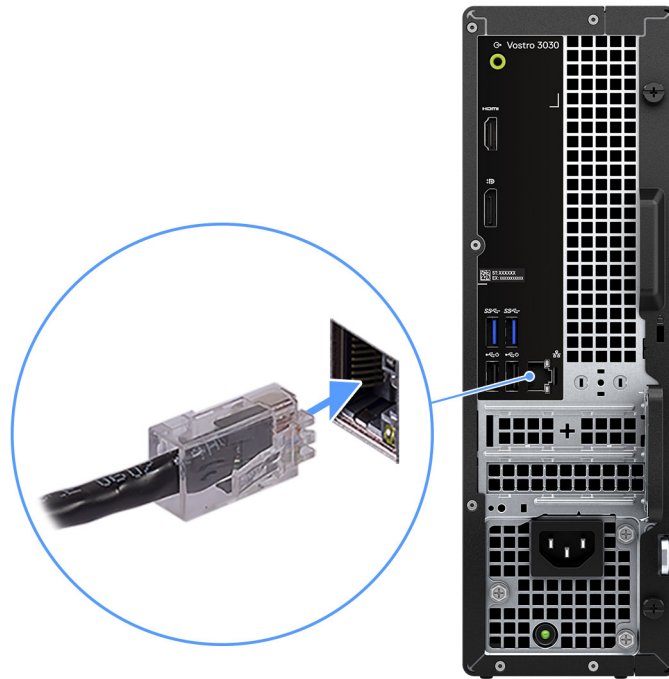

Figure 5. Connect to your network

3. Connect the display.



Figure 6. Connect the display

4. Connect the power cable.



Figure 7. Connect the power cable

5. Press the power button.



Figure 8. Press the power button

6. Finish the operating system setup.

For Ubuntu:

Follow the on-screen instructions to complete the setup. For more information about installing and configuring Ubuntu, search in the Knowledge Base Resource at [Dell Support Site](#).





For Windows:

Follow the on-screen instructions to complete the setup. When setting up, Dell recommends that you:

- Connect to a network for Windows updates.
 - **NOTE:** If connecting to a secured wireless network, enter the password for the wireless network access when prompted.
- If connected to the Internet, sign-in with or create a Microsoft account. If not connected to the Internet, create an offline account.
- On the **Support and Protection** screen, enter your contact details.

7. Locate and use Dell apps from the Windows Start menu—Recommended

Table 1. Locate Dell apps

Resources	Description
	<p>MyDell</p> <p>MyDell is a software application that offers you a single streamlined engagement platform including account access, device information, and hardware settings. This software delivers intelligent features that automatically fine-tune your computer for the best possible audio, power, and performance. Get the most out of your Dell device with intelligent, personalized technology from MyDell. Following are the key features of MyDell:</p> <ul style="list-style-type: none"> • Application • Audio • Power • Color and Display • Presence detection <p>For more information about how to use MyDell, see product guides at Dell Support Site.</p>
	<p>SupportAssist</p> <p>SupportAssist proactively and predictively identifies hardware and software issues on your computer and automates the engagement process with Dell Technical support. It addresses performance and stabilization issues, prevents security threats, monitors, and detects hardware failures. For more information, see SupportAssist for Home PCs User's Guide.</p> <p>NOTE: In SupportAssist, click the warranty expiry date to renew or upgrade your warranty.</p>
	<p>Dell Update</p> <p>Updates your computer with critical fixes and latest device drivers as they become available. For more information about using Dell Update, see the product guides and third-party license documents at Dell Support Site.</p>
	<p>Dell Digital Delivery</p> <p>Download software applications, which are purchased but not preinstalled on your computer. For more information about using Dell Digital Delivery, search in the Knowledge Base Resource at Dell Support Site.</p>

Specifications of Vostro 3030 Small Desktop

Dimensions and weight

The following table lists the height, width, depth, and weight of your Vostro 3030 Small Desktop.

Table 2. Dimensions and weight

Description	Values
Height	11.41 in. (290.00 mm)
Width	3.64 in. (92.60 mm)
Depth	11.52 in. (292.80 mm)
Weight  NOTE: The weight of your computer depends on the configuration ordered and manufacturing variability.	<ul style="list-style-type: none"> 8.86 lb (4.02 kg), minimum 10.41 lb (4.72 kg), maximum

Processor

The following table lists the details of the processors that are supported by your Vostro 3030 Small Desktop.

Table 3. Processor

Description	Option one	Option two	Option three	Option four
Processor type	14th Gen Intel Core i3-14100	14th Gen Intel Core i5-14400	14th Gen Intel Core i7-14700	Intel 300
Processor wattage	60 W	65 W	65 W	46 W
Processor total core count	4	10	20	2
Performance-cores	4	6	8	2
Efficient-cores	Not applicable	4	12	Not applicable
Processor total thread counts  NOTE: Intel Hyper-Threading Technology is only available on Performance-cores.	8	16	28	4
Processor speed	Up to 4.70 GHz	Up to 4.70 GHz	Up to 5.40 GHz	Up to 3.90 GHz
Performance-cores frequency				

Table 3. Processor (continued)

Description		Option one	Option two	Option three	Option four
	Processor base frequency	3.50 GHz	2.50 GHz	2.10 GHz	3.90 GHz
	Maximum turbo frequency	4.70 GHz	4.70 GHz	5.40 GHz	Not applicable
Efficient-cores frequency					
	Processor base frequency	Not applicable	1.80 GHz	1.50 GHz	Not applicable
	Maximum turbo frequency	Not applicable	3.50 GHz	4.20 GHz	Not applicable
Processor cache		12 MB	20 MB	33 MB	6 MB
Integrated graphics		Intel UHD Graphics 730	Intel UHD Graphics 730	Intel UHD Graphics 770	Intel UHD Graphics 710

Chipset

The following table lists the details of the chipset that is supported in your Vostro 3030 Small Desktop.

Table 4. Chipset

Description	Values
Chipset	Intel B660
Processor	<ul style="list-style-type: none"> 14th Gen Intel Core i3/i5/i7 Intel 300
DRAM bus width	64-bit, dual-channel
Flash EPROM	32 MB + 16 MB
PCIe bus	Up to Gen3

Operating system

Your Vostro 3030 Small Desktop supports the following operating systems:

- Windows 11 Home
- Windows 11 Pro
- Windows 11 Home National Education
- Windows 11 Pro National Education
- Ubuntu Linux 22.04 LTS, 64-bit

Memory

The following table lists the memory specifications that are supported by your Vostro 3030 Small Desktop.

Table 5. Memory specifications

Description	Values
Memory slots	Two UDIMM slots

Table 5. Memory specifications (continued)

Description	Values
Memory type	DDR5
Memory speed	4400 MT/s
Maximum memory configuration	64 GB
Minimum memory configuration	8 GB
Memory size per slot	8 GB, 16 GB, and 32 GB
Memory configurations supported	<ul style="list-style-type: none"> • 8 GB, 1 x 8 GB, DDR5, 4400 MT/s, UDIMM • 16 GB, 2 x 8 GB, DDR5, 4400 MT/s, UDIMM, dual-channel • 16 GB, 1 x 16 GB, DDR5, 4400 MT/s, UDIMM • 32 GB, 2 x 16 GB, DDR5, 4400 MT/s, UDIMM, dual-channel • 32 GB, 1 x 32 GB, DDR5, 4400 MT/s, UDIMM • 64 GB, 2 x 32 GB, DDR5, 4400 MT/s, UDIMM, dual-channel

Memory matrix

The following table lists the memory configurations supported on your Vostro 3030 Small Desktop.

Table 6. Memory matrix

Configuration	Slot	
	DIMM1	DIMM2
8 GB DDR5	8 GB	Not applicable
16 GB DDR5	8 GB	8 GB
16 GB DDR5	16 GB	Not applicable
32 GB DDR5	16 GB	16 GB
32 GB DDR5	32 GB	Not applicable
64 GB DDR5	32 GB	32 GB

External ports and slots

The following table lists the external ports of your Vostro 3030 Small Desktop.

Table 7. External ports and slots

Description	Values
Network port	One RJ-45 Ethernet port
USB ports	<ul style="list-style-type: none"> • Three USB 3.2 Gen 1 ports • Two USB 2.0 ports • Two USB 2.0 ports with Power on/Wake support • One USB 3.2 Type-C Gen 1 port

Table 7. External ports and slots (continued)

Description	Values
Audio port	<ul style="list-style-type: none"> One global headset (headphone and microphone combo) jack One audio line-out port
Video port(s)	<ul style="list-style-type: none"> One DisplayPort 1.4 port <i>i</i> NOTE: The maximum resolution supported by DisplayPort 1.4 port is 4096 x 2034 @ 60 Hz. One HDMI 1.4b port <i>i</i> NOTE: The maximum resolution supported by the HDMI 1.4b port is 1920 x 1080 @ 60 Hz .
Media-card reader	One SD-card slot (optional)
Power-adaptor port	One AC power-supply port
Security-cable slot	<ul style="list-style-type: none"> Kensington security-cable slot One padlock ring slot Firmware Trusted Platform Module (TPM) 2.0

Internal slots

The following table lists the internal slots on your Vostro 3030 Small Desktop.

Table 8. Internal slots

Description	Values
M.2	<ul style="list-style-type: none"> One M.2 2230 slot for WiFi and Bluetooth combo card, Gen3 One M.2 2230/2280 slot for solid-state drive, Gen3 <i>i</i> NOTE: To learn more about the features of different types of M.2 cards, search in the Knowledge Base Resource at Dell Support Site.
SATA	<ul style="list-style-type: none"> One SATA 2.0 slot for slim optical drive One SATA 3.0 slot for 3.5-inch hard drive

Ethernet

The following table lists the wired Ethernet Local Area Network (LAN) specifications of your Vostro 3030 Small Desktop.

Table 9. Ethernet specifications

Description	Values
Model number	Realtek RTL8111KD
Transfer rate	10/100/1000 Mbps

Wireless module

The following table lists the Wireless Local Area Network (WLAN) modules that are supported on your Vostro 3030 Small Desktop.

Table 10. Wireless module specifications

Description	Option one	Option two
Model number	Realtek RTL8852BE	Realtek RTL8851BE
Transfer rate	Up to 1201 Mbps	Up to 600 Mbps
Frequency bands supported	2.4 GHz/5 GHz	2.4 GHz/5 GHz
Wireless standards	<ul style="list-style-type: none"> • Wi-Fi 802.11 a/b/g • Wi-Fi 4 (WiFi 802.11n) • Wi-Fi 5 (WiFi 802.11ac) 	<ul style="list-style-type: none"> • Wi-Fi 802.11 a/b/g • Wi-Fi 4 (WiFi 802.11n) • Wi-Fi 5 (WiFi 802.11ac) • Wi-Fi 6 (WiFi 802.11ax)
Encryption	<ul style="list-style-type: none"> • 64-bit/128-bit WEP • AES-CCMP • TKIP 	<ul style="list-style-type: none"> • 64-bit/128-bit WEP • AES-CCMP • TKIP
Bluetooth wireless card	Bluetooth 5.3	Bluetooth 5.3
	 NOTE: The version of the Bluetooth wireless card may vary depending on the operating system that is installed on your computer.	

Audio

The following table lists the audio specifications of your Vostro 3030 Small Desktop.

Table 11. Audio specifications

Description	Values
Audio type	Cirrus Logic
Audio controller	CS8409, CS42L42 (headphone codec)
Internal audio interface	High definition audio interface
External audio interface	<ul style="list-style-type: none"> • One global headset (headphone and microphone combo) jack • One Line-out port (rear)  NOTE: 3.5 mm global headset jack functionality varies by model configuration. For best results, use Dell recommended audio accessories.

Storage

This section lists the storage options on your Vostro 3030 Small Desktop.

Table 12. Storage matrix

Storage	3.5-inch hard drive	M.2 2230/2280 socket
M.2 solid-state drive	No	Yes
M.2 solid-state drive	3.5-inch hard drive	Yes (Primary M.2 PCIe boot function)

Table 13. Storage specifications

Storage type	Interface type	Capacity
3.5-inch hard-disk drive, 7200 RPM	SATA AHCI, up to 6 Gbps	Up to 2 TB
M.2 2230 solid-state drive	PCIe NVMe, up to 32 Gbps	Up to 1 TB
M.2 2280 solid-state drive	PCIe NVMe, up to 32 Gbps	Up to 1 TB
M.2 2230 solid-state drive, QLC	PCIe NVMe, up to 32 Gbps, QLC	Up to 1 TB
9.5 mm 16x slimline DVD-RW drive (optional)	SATA AHCI, up to 1.5 Gbps	Not applicable

Media-card reader

The following table lists the media cards that are supported in your Vostro 3030 Small Desktop.

Table 14. Media-card reader specifications

Description	Values
Media-card type	One SD card slot
Media-cards supported	<ul style="list-style-type: none"> Secure Digital (SD) Secure Digital High Capacity (SDHC) Secure Digital Extended Capacity (SDXC)
<p>NOTE: The maximum capacity that is supported by the media-card reader varies depending on the standard of the media card that is installed on your computer.</p>	

Power ratings

The following table lists the power rating specifications of Vostro 3030 Small Desktop.

Table 15. Power ratings

Description	Values
Type	180 W Bronze internal Power Supply Unit (PSU)
Input voltage	90 VAC to 264 VAC
Input frequency	47 Hz to 63 Hz

Table 15. Power ratings (continued)

Description		Values
Input current (maximum)		3 A
Output current (continuous)		Operating <ul style="list-style-type: none"> • 12 VA-15 A • 12 VB-14 A Standby mode: <ul style="list-style-type: none"> • 12 VA-1.5 A • 12 VB-3.3 A
Rated output voltage		<ul style="list-style-type: none"> • +12 VA • +12 VB
Temperature range		
	Operating	5°C to 45°C (41°F to 113°F)
	Storage	-40°C to 70°C (-40°F to 158°F)

Power supply connector

The following table lists the Power supply connector specifications of your Vostro 3030 Small Desktop.

Table 16. Power supply connector

Connector	Pin
180 W (80 PLUS Bronze)	<ul style="list-style-type: none"> • One 4 pin connector for processor • One 8 pin connector for system board

GPU—Integrated

The following table lists the specifications of the integrated Graphics Processing Unit (GPU) supported by your Vostro 3030 Small Desktop.

Table 17. GPU—Integrated

Controller	External display support	Memory size	Processor
Intel UHD Graphics 710	<ul style="list-style-type: none"> • One DisplayPort 1.4 port <ul style="list-style-type: none"> NOTE: The maximum resolution supported by DisplayPort 1.4 port is 4096 x 2034 @ 60 Hz. • One HDMI 1.4b port <ul style="list-style-type: none"> NOTE: The maximum resolution supported by the HDMI 1.4b port is 1920 x 1200. 	Shared system memory	Intel 300
Intel UHD Graphics 730	<ul style="list-style-type: none"> • One DisplayPort 1.4 port <ul style="list-style-type: none"> NOTE: The maximum resolution supported by DisplayPort 1.4 port 	Shared system memory	<ul style="list-style-type: none"> • 14th Gen Intel Core i3-14100 • 14th Gen Intel Core i5-14400

Table 17. GPU—Integrated (continued)

Controller	External display support	Memory size	Processor
	<p>is 4096 x 2034 @ 60 Hz.</p> <ul style="list-style-type: none"> One HDMI 1.4b port <p>NOTE: The maximum resolution supported by the HDMI 1.4b port is 1920 x 1200.</p>		
Intel UHD Graphics 770	<ul style="list-style-type: none"> One DisplayPort 1.4 port <p>NOTE: The maximum resolution supported by DisplayPort 1.4 port is 4096 x 2034 @ 60 Hz.</p> <ul style="list-style-type: none"> One HDMI 1.4b port <p>NOTE: The maximum resolution supported by the HDMI 1.4b port is 1920 x 1200.</p>	Shared system memory	14th Gen Intel Core i7-14700

Multiple display support matrix

The following table lists the multiple display support matrix for your Vostro 3030 Small Desktop.

Table 18. Integrated graphics card

Graphics Card	Intel UHD Graphics
Video ports on Integrated Graphics Card	<ul style="list-style-type: none"> One DisplayPort 1.4 port One HDMI 1.4b port <p>NOTE: HDMI port resolution is up to 1920 x 1200.</p>
Number of displays supported	2

Hardware security

The following table lists the hardware security of your Vostro 3030 Small Desktop.

Table 19. Hardware security

Hardware security
Kensington security-cable slot
One padlock ring slot
Firmware Trusted Platform Module (TPM) 2.0

Environmental

The following table lists the environmental specifications of your Vostro 3030 Small Desktop.

Table 20. Environmental

Feature	Values
Recyclable packaging	Yes
Vertical orientation packaging support	No
Multi-Pack packaging	Yes

NOTE: Wood-based fiber packaging contains a minimum of 35% recycled content by total weight of wood-based fiber. Packaging that contains without wood-based fiber can be claimed as Not Applicable. The anticipated required criteria for EPEAT 2018.

Regulatory compliance

The following table lists the regulatory compliance of your Vostro 3030 Small Desktop.

Table 21. Regulatory compliance

Regulatory compliance
Product Safety, EMC and Environmental Datasheets
Dell Regulatory Compliance Home Page
Responsible Business Alliance Policy

Operating and storage environment

This table lists the operating and storage specifications of your Vostro 3030 Small Desktop.

Airborne contaminant level: G1 as defined by ISA-S71.04-1985

Table 22. Computer environment

Description	Operating	Storage
Temperature range	10°C – 35°C (32°F – 95°F)	-40°C - 65°C (-40°F - 149°F)
Relative humidity (maximum)	20% to 80% (non-condensing, Max dew point temperature = 26°C)	5% to 95% (non-condensing, Max dew point temperature = 33°C)
Vibration (maximum)*	0.26 GRMS random at 5 Hz to 350 Hz	1.37 GRMS random at 5 Hz to 350 Hz
Shock (maximum)	40 G†	105 G†
Altitude range	-15.2 m - 3048 m (-49.86 ft -10,000 ft)	-15.2 m - 10,668 m (-49.86 ft - 35,000 ft)

CAUTION: Operating and storage temperature ranges may differ among components, so operating or storing the device outside these ranges may impact the performance of specific components.

* Measured using a random vibration spectrum that simulates the user environment.

† Measured using a 2 ms half-sine pulse.











Dell support policy

For information about Dell support policy, search in the Knowledge Base Resource at [Dell Support Site](#).

Working inside your computer

Safety instructions

Use the following safety guidelines to protect your computer from potential damage and to ensure your personal safety. Unless otherwise noted, each procedure in this document assumes that you have read the safety information that shipped with your computer.



-  **WARNING:** Before working inside your computer, read the safety information that is shipped with your computer. For more safety best practices, see [Dell Regulatory Compliance Home Page](#).
-  **WARNING:** Disconnect your computer from all power sources before opening the computer cover or panels. After you finish working inside the computer, replace all covers, panels, and screws before connecting your computer to an electrical outlet.
-  **CAUTION:** To avoid damaging the computer, ensure that the work surface is flat, dry, and clean.
-  **CAUTION:** To avoid damaging the components and cards, handle them by their edges, and avoid touching the pins and the contacts.
-  **CAUTION:** You should only perform troubleshooting and repairs as authorized or directed by the Dell technical support team. Damage due to servicing that is not authorized by Dell is not covered by your warranty. See the safety instructions that is shipped with the product or at [Dell Regulatory Compliance Home Page](#).
-  **CAUTION:** Before touching anything inside your computer, ground yourself by touching an unpainted metal surface, such as the metal at the back of the computer. While you work, periodically touch an unpainted metal surface to dissipate static electricity which could harm internal components.
-  **CAUTION:** When you disconnect a cable, pull it by its connector or its pull tab, not the cable itself. Some cables have connectors with locking tabs or thumbscrews that you must disengage before disconnecting the cable. When disconnecting cables, keep them evenly aligned to avoid bending the connector pins. When connecting cables, ensure that the connector on the cable is correctly oriented and aligned with the port.
-  **CAUTION:** Press and eject any installed card from the media-card reader.
-  **CAUTION:** Exercise caution when handling rechargeable Li-ion batteries in laptops. Swollen batteries should not be used and should be replaced and disposed properly.
-  **NOTE:** The color of your computer and certain components may differ from what is shown in this document.

Before working inside your computer

About this task

-  **NOTE:** The images in this document may differ from your computer depending on the configuration you ordered.

Steps

1. Save and close all open files and exit all open applications.
2. Shut down your computer. For Windows operating system, click **Start** >  **Power** > **Shut down**.
 -  **NOTE:** If you are using a different operating system, see the documentation of your operating system for shut-down instructions.

3. Disconnect your computer and all attached devices from their electrical outlets.
4. Disconnect all attached network devices and peripherals, such as keyboard, mouse, and monitor from your computer.

 **CAUTION: To disconnect a network cable, first unplug the cable from your computer and then unplug the cable from the network device.**

5. Remove any media card and optical disc from your computer, if applicable.

Safety precautions

The safety precautions section details the primary steps to be taken before performing any disassembly instructions.

Observe the following safety precautions before you perform any installation or break-fix procedures involving disassembly or reassembly:

- Turn off the computer and all attached peripherals.
- Disconnect the computer from AC power.
- Disconnect all network cables and peripherals from the computer.
- Use an ESD field service kit when working inside any desktop to avoid electrostatic discharge (ESD) damage.
- After removing a computer component, carefully place the removed component on an anti-static mat.
- Wear shoes with non-conductive rubber soles to reduce the chance of getting electrocuted.
- Unplugging, pressing, and holding the power button for 15 seconds should discharge residual power in the system board.

Standby power

Dell products with standby power must be unplugged before you open the case. Systems equipped with standby power are powered while turned off. The internal power enables the computer to be remotely turned on (Wake-on-LAN) and suspended into a sleep mode and has other advanced power management features.

Bonding

Bonding is a method for connecting two or more grounding conductors to the same electrical potential. This is done by using a field service electrostatic discharge (ESD) kit. When connecting a bonding wire, ensure that it is connected to bare metal and never to a painted or nonmetal surface. Ensure that the wrist strap is secure and in full contact with your skin. Remove all jewelry such as watches, bracelets, or rings before to grounding yourself and the equipment.

Electrostatic discharge—ESD protection

ESD is a major concern when you handle electronic components, especially sensitive components such as expansion cards, processors, memory modules, and system boards. A slight charge can damage circuits in ways that may not be obvious, such as intermittent problems or a shortened product life span. As the industry pushes for lower power requirements and increased density, ESD protection is an increasing concern.

Due to the increased density of semiconductors used in recent Dell products, the sensitivity to static damage is now higher than in previous Dell products. For this reason, some previously approved methods of handling parts are no longer applicable.

Two recognized types of ESD damage are catastrophic and intermittent failures.

- **Catastrophic** – Catastrophic failures represent approximately 20 percent of ESD-related failures. The damage causes an immediate and complete loss of device functionality. An example of catastrophic failure is a memory module that has received a static shock and immediately generates a "No POST/No Video" symptom with a beep code that is emitted for missing or non-functional memory.
- **Intermittent** – Intermittent failures represent approximately 80 percent of ESD-related failures. The high rate of intermittent failures means that most of the time when damage occurs, it is not immediately recognizable. The memory module receives a static shock, but the tracing is merely weakened and does not immediately produce outward symptoms that are related to the damage. The weakened trace may take weeks or months to melt, and in the meantime may cause degradation of memory integrity, intermittent memory errors, and so on.

Intermittent failures also called latent or "walking wounded" are difficult to detect and troubleshoot.

Perform the following steps to prevent ESD damage:

- Use a wired ESD wrist strap that is properly grounded. Wireless anti-static straps do not provide adequate protection. Touching the chassis before handling parts does not ensure adequate ESD protection on parts with increased sensitivity to ESD damage.
- Handle all static-sensitive components in a static-safe area. If possible, use anti-static floor pads and workbench pads.
- When unpacking a static-sensitive component from its shipping carton, do not remove the component from the anti-static packing material until you are ready to install the component. Before unwrapping the anti-static packaging, use the anti-static wrist strap to discharge the static electricity from your body.
- Before transporting a static-sensitive component, place it in an anti-static container or packaging.

ESD Field Service kit

The unmonitored Field Service kit is the most commonly used service kit. Each Field Service kit includes three main components: anti-static mat, wrist strap, and bonding wire.

 **CAUTION: It is critical to keep ESD-sensitive devices away from internal parts that are insulators and often highly charged, such as plastic heat sink casings.**

Working Environment

Before deploying the ESD Field Service kit, assess the situation at the customer location. For example, deploying the kit for a server environment is different than for a desktop or laptop environment. Servers are typically installed in a rack within a data center; desktops or laptops are typically placed on office desks or cubicles. Always look for a large open flat work area that is free of clutter and large enough to deploy the ESD kit with additional space to accommodate the type of computer that is being repaired. The workspace should also be free of insulators that can cause an ESD event. On the work area, insulators such as Styrofoam and other plastics should always be moved at least 12 inches or 30 centimeters away from sensitive parts before physically handling any hardware components.

ESD Packaging

All ESD-sensitive devices must be shipped and received in static-safe packaging. Metal, static-shielded bags are preferred. However, you should always return the damaged part using the same ESD bag and packaging that the new part arrived in. The ESD bag should be folded over and taped shut and all the same foam packing material should be used in the original box that the new part arrived in. ESD-sensitive devices should be removed from packaging only at an ESD-protected work surface, and parts should never be placed on top of the ESD bag because only the inside of the bag is shielded. Always place parts in your hand, on the ESD mat, in the computer, or inside an anti-static bag.

Components of an ESD Field Service kit

The components of an ESD Field Service kit are:

- **Anti-Static Mat** – The anti-static mat is dissipative and parts can be placed on it during service procedures. When using an anti-static mat, your wrist strap should be snug and the bonding wire should be connected to the anti-static mat and to any bare metal on the computer being worked on. Once deployed properly, service parts can be removed from the ESD bag and placed directly on the anti-static mat. ESD-sensitive items are safe in your hand, on the anti-static mat, in the computer, or inside an ESD bag.
- **Wrist Strap and Bonding Wire** – The wrist strap and bonding wire can be either directly connected between your wrist and bare metal on the hardware if the ESD mat is not required, or connected to the anti-static mat to protect hardware that is temporarily placed on the mat. The physical connection of the wrist strap and bonding wire between your skin, the ESD mat, and the hardware is known as bonding. Use only Field Service kits with a wrist strap, anti-static mat, and bonding wire. Never use wireless wrist straps. Always be aware that the internal wires of a wrist strap are prone to damage from normal wear and tear, and must be checked regularly with a wrist strap tester in order to avoid accidental ESD hardware damage. It is recommended to test the wrist strap and bonding wire at least once per week.
- **ESD Wrist Strap Tester** – The wires inside an ESD strap are prone to damage over time. When using an unmonitored kit, it is a best practice to regularly test the strap prior to each service call, and at a minimum, test once per week. A wrist strap tester is the best method for doing this test. If you do not have your own wrist strap tester, check with your regional office to find out if they have one. To perform the test, plug the bonding-wire of the wrist-strap into the tester while it is strapped to your wrist and push the button to test. A green LED is lit if the test is successful; a red LED is lit and an alarm sounds if the test fails.

 **NOTE:** It is recommended to always use the traditional wired ESD grounding wrist strap and protective anti-static mat when servicing Dell products. In addition, it is critical to keep sensitive parts separate from all insulator parts while servicing the computer, and use anti-static bags for transporting sensitive components.

Transporting sensitive components

When transporting ESD sensitive components such as replacement parts or parts to be returned to Dell, it is critical to place these parts in anti-static bags for safe transport.

Lifting equipment

Adhere to the following guidelines when lifting heavy equipment:

 **CAUTION: Do not lift greater than 50 pounds. Always obtain additional resources or use a mechanical lifting device.**

1. Get a firm balanced footing. Keep your feet apart for a stable base, and point your toes out.
2. Tighten stomach muscles. Abdominal muscles support your spine when you lift, offsetting the force of the load.
3. Lift with your legs, not your back.
4. Keep the load close. The closer it is to your spine, the less force it exerts on your back.
5. Keep your back upright, whether lifting or setting down the load. Do not add the weight of your body to the load. Avoid twisting your body and back.
6. Follow the same technique in reverse to set the load down.

After working inside your computer

About this task

 **CAUTION: Leaving stray or loose screws inside your computer may severely damage your computer.**

Steps

1. Replace all screws and ensure that no stray screws remain inside your computer.
2. Connect any external devices, peripherals, or cables you removed before working on your computer.
3. Replace any media cards, discs, or any other parts that you removed before working on your computer.
4. Connect your computer and all attached devices to their electrical outlets.
5. Turn on your computer.

BitLocker

 **CAUTION: If BitLocker is not suspended before updating the BIOS, the BitLocker key is not recognized the next time you reboot the computer. You will then be prompted to enter the recovery key to progress, and the system displays a prompt for the recovery key on each reboot. If the recovery key is not known, this can result in data loss or an operating system reinstall. For more information, see Knowledge Article: [updating the BIOS on Dell systems with BitLocker enabled](#).**

The installation of the following components triggers BitLocker:

- Hard disk drive or solid-state drive
- System board

Recommended tools













The procedures in this document may require the following tools:

- Phillips screwdriver #1 and #2

Screw list

- NOTE:** When removing screws from a component, it is recommended to note the screw type and the quantity of screws, and then place them in a screw storage box. This is to ensure that the correct number of screws and correct screw type is restored when the component is replaced.
- NOTE:** Some computers have magnetic surfaces. Ensure that the screws are not left attached to such surfaces when replacing a component.
- NOTE:** Screw color may vary depending on the configuration ordered.

Table 23. Screw list

Component	Screw type	Quantity	Screw image
Left-side cover	#6-32	2	
2230 solid-state drive	M2x3	1	
2280 solid-state drive	M2x3	1	
Wireless card	M2x3	1	
Hard-drive and optical-drive cage	#6-32, hex head	1	
3.5-inch hard drive	#6-32, hex head	2	
Power supply unit	#6-32, hex head	3	
Optical drive (optional)	M2x2	2	
Media-card reader (optional)	M3x5	2	
Processor fan and heat-sink assembly	Captive	4	
System board	#6-32, hex head	8	
I/O board	#6-32x3.8	1	
Antenna modules	M2x3	2	

Major components of Vostro 3030 Small Desktop

The following image shows the major components of Vostro 3030 Small Desktop.

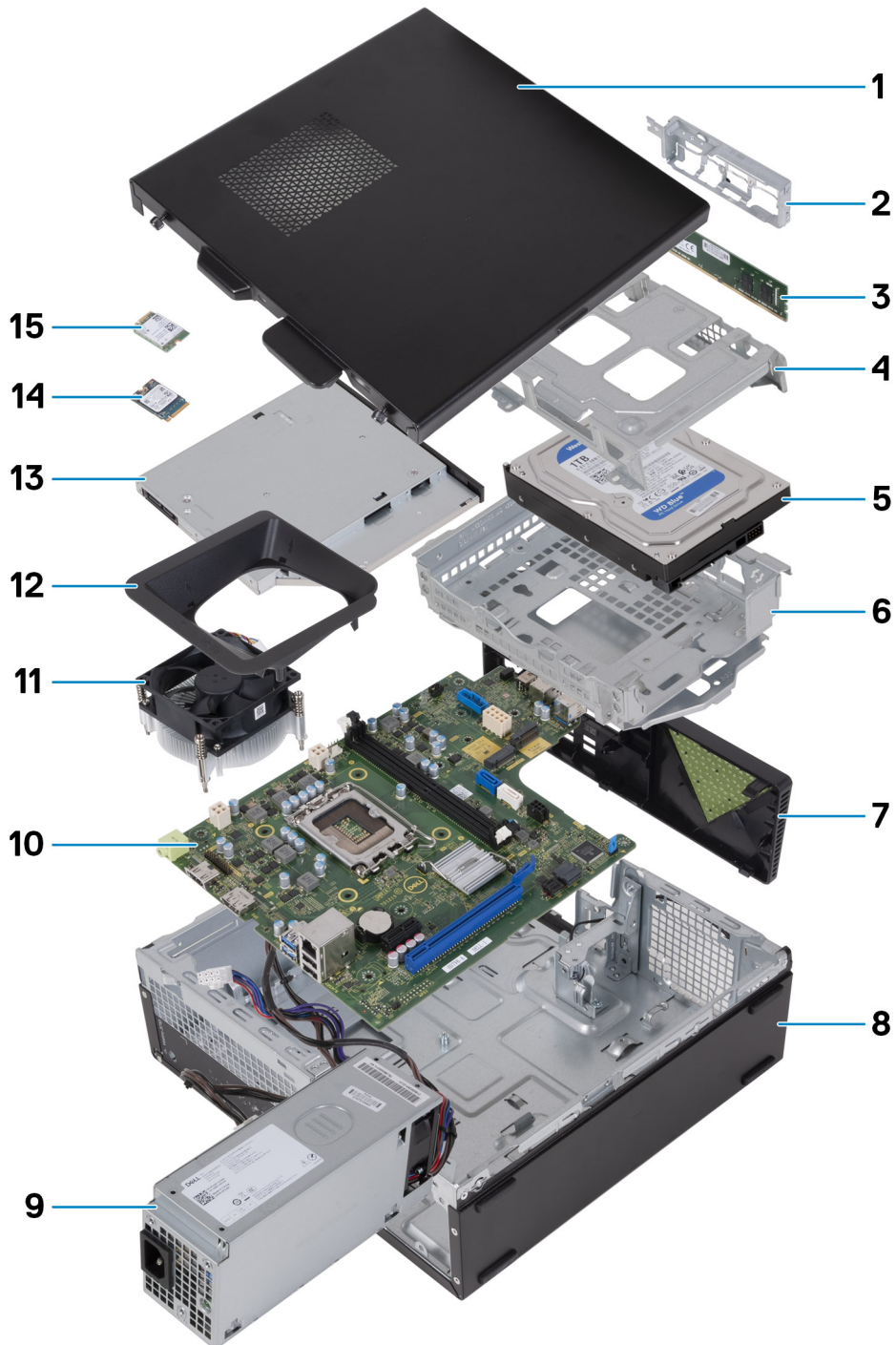



Figure 9. Major components of your computer

1. Left-side cover
2. Front-I/O bracket
3. Memory module
4. Hard-drive cage
5. Hard drive
6. Hard-drive and optical-drive cage

7. Front cover
8. Chassis
9. Power-supply unit
10. System board
11. Processor fan and heat-sink assembly
12. Fan shroud
13. Optical drive (optional)
14. M.2 2230 solid-state drive
15. Wireless card

 **NOTE:** Dell provides a list of components and their part numbers for the original system configuration purchased. These parts are available according to warranty coverages purchased by the customer. Contact your Dell sales representative for purchase options.

Removing and installing Customer Replaceable Units (CRUs)

The replaceable components in this chapter are Customer Replaceable Units (CRUs).

CAUTION: Customers can replace only the Customer Replaceable Units (CRUs) following the safety precautions and replacement procedures.

NOTE: The images in this document may differ from your computer depending on the configuration you ordered.

Left-side cover

Removing the left-side cover

Prerequisites

1. Follow the procedure in [Before working inside your computer](#).

About this task

The following images indicate the location of the left-side cover and provide a visual representation of the removal procedure.

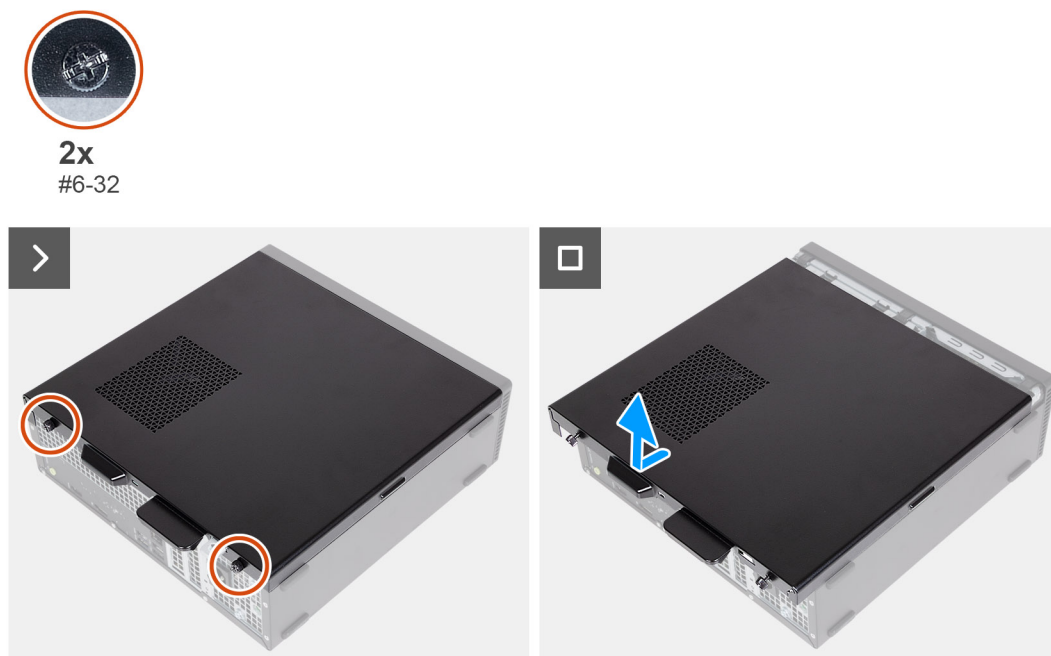

Figure 10. Removing the left-side cover

Steps

1. Remove the two screws (#6-32) that secure the left-side cover to the chassis.
2. Holding the tab on the left-side cover firmly, slide and remove the left-side cover from the chassis.

Installing the left-side cover

Prerequisites

If you are replacing a component, remove the existing component before performing the installation process.

About this task

The following images indicate the location of the left-side cover and provide a visual representation of the installation procedure.

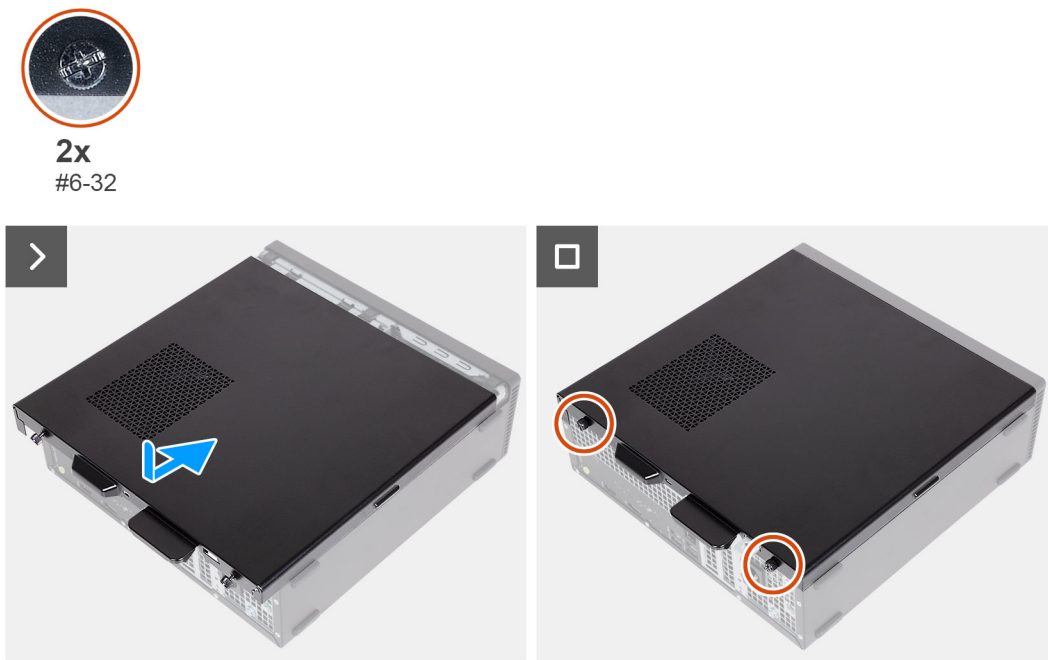

Figure 11. Installing the left-side cover

Steps

1. Holding the left-side cover firmly on both sides, slide it into the chassis towards the front of the computer.
2. Replace the two screws (#6-32) that secure the left-side cover to the chassis.

Next steps

1. Follow the procedure in [After working inside your computer](#).

Front cover

Removing the front cover

Prerequisites

1. Follow the procedure in [Before working inside your computer](#).
2. Remove the [left-side cover](#).

About this task

The following images indicate the location of the front cover and provide a visual representation of the removal procedure.

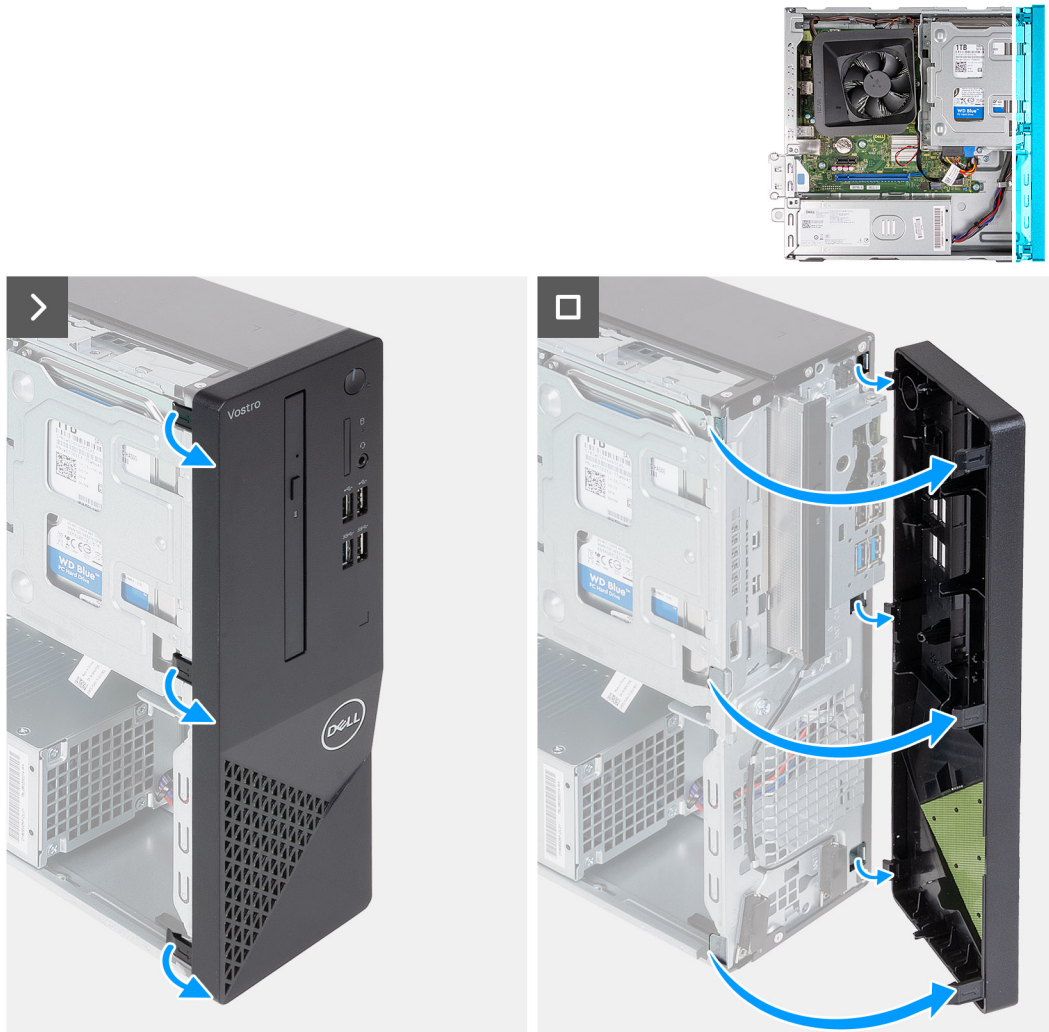

Figure 12. Removing the front cover

Steps

1. Gently pry and release the tabs that secure the front cover to the chassis.
2. Lift the front cover away from the chassis.

Installing the front cover

Prerequisites

If you are replacing a component, remove the existing component before performing the installation process.

About this task

The following images indicate the location of the front cover and provide a visual representation of the installation procedure.

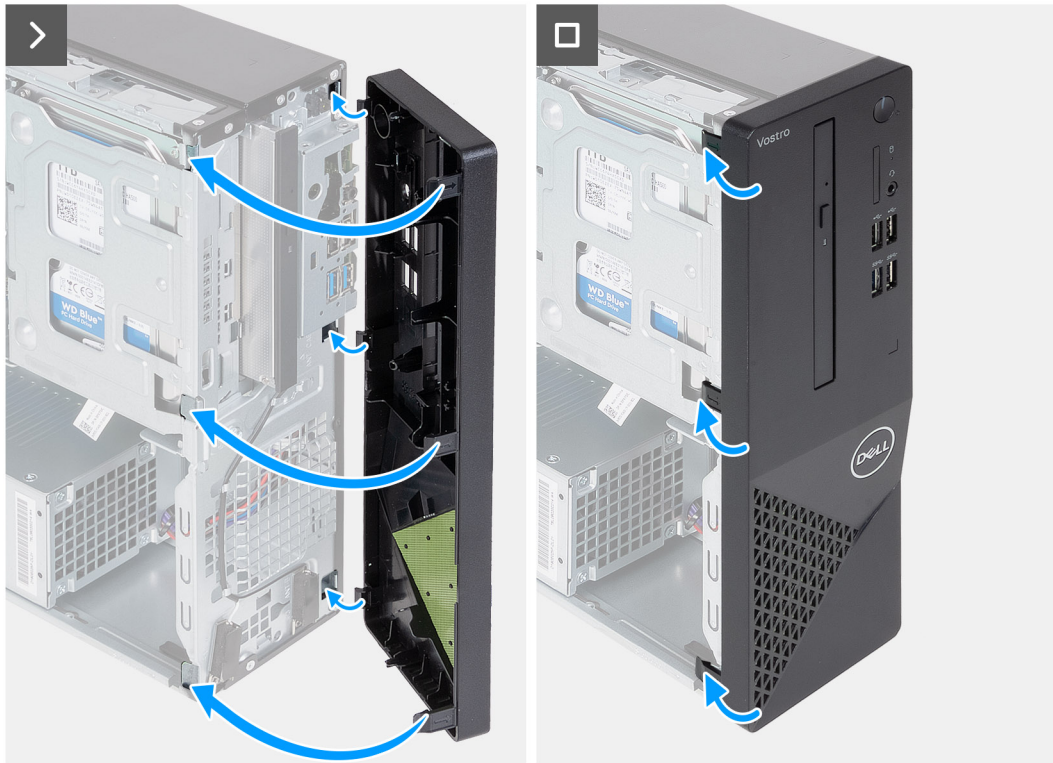
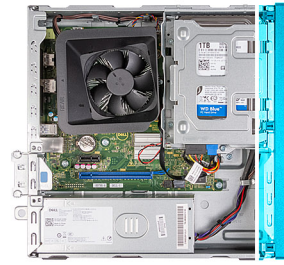

Figure 13. Installing the front cover

Steps

1. Align and insert the tabs on the front cover into the slots on the right side of the chassis.
2. Rotate the front cover towards the chassis and snap the tabs on the front cover into place.

Next steps

1. Install the [left-side cover](#).
2. Follow the procedure in [After working inside your computer](#).

Hard drive

Removing the 3.5-inch hard drive

Prerequisites

1. Follow the procedure in [Before working inside your computer](#).
2. Remove the [left-side cover](#).
3. Remove the [front cover](#).

About this task

The following images indicate the location of the 3.5-inch hard drive and provide a visual representation of the removal procedure.

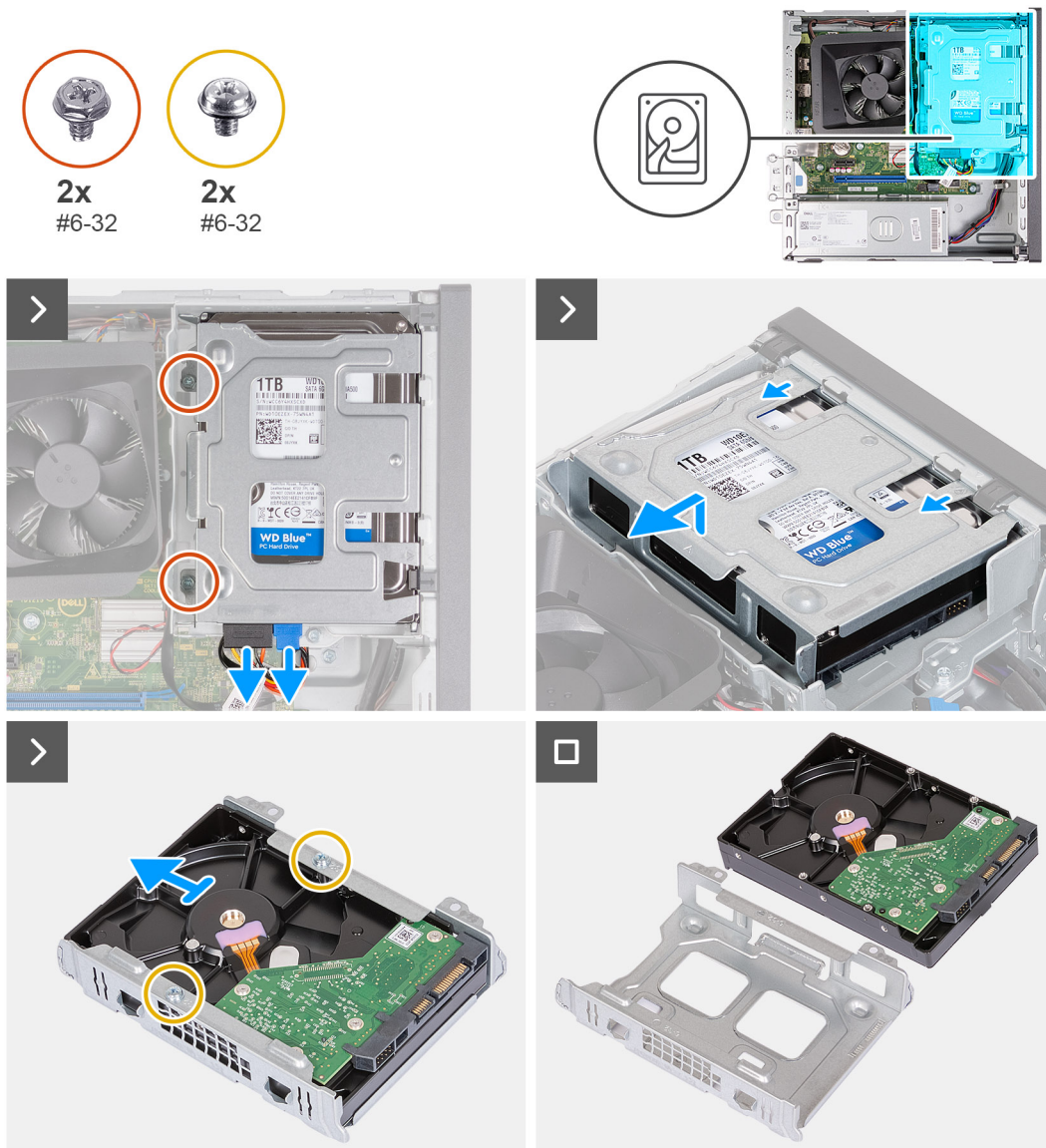

Figure 14. Removing the 3.5-inch hard drive

Steps

1. Disconnect the data and power cable from the connectors on the 3.5-inch hard drive.
2. Remove the two (#6-32) screws that secure the 3.5-inch hard-drive assembly to the hard-drive and optical-drive cage.
3. Lift and slide the 3.5-inch hard-drive assembly away from the hard-drive and optical-drive cage.
4. Turn over and place the 3.5-inch hard-drive assembly on a flat surface.
5. Remove the two (#6-32) screws that secure the 3.5-inch hard drive to the hard-drive bracket.
6. Slide and remove the 3.5-inch hard drive from the hard-drive bracket.

Installing the 3.5-inch hard drive

Prerequisites

If you are replacing a component, remove the existing component before performing the installation process.

About this task

The following images indicate the location of the 3.5-inch hard drive and provide a visual representation of the installation procedure.

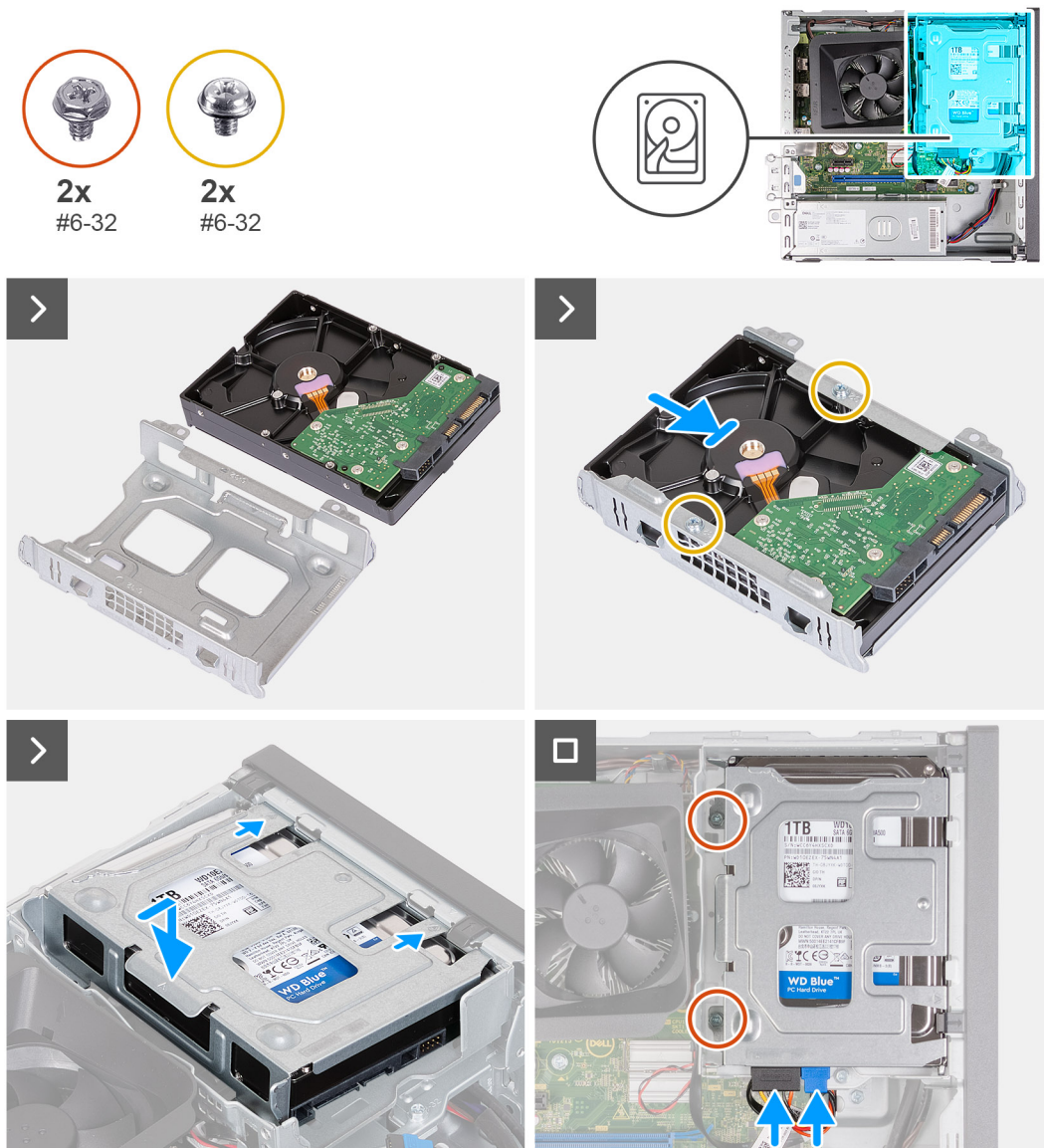

Figure 15. Installing the 3.5-inch hard drive

Steps

1. Align and slide the 3.5-inch hard drive into the hard-drive cage.
2. Replace the two (#6-32) screws to secure the 3.5-inch hard drive to the hard-drive bracket.
3. Align and slide the hard-drive assembly into the hard-drive and optical-drive cage.
4. Replace the two (#6-32) screws to secure the 3.5-inch hard drive assembly to the hard-drive and optical-drive cage.
5. Connect the power cable and data cable to connectors on the 3.5-inch hard drive.

Next steps

1. Install the [front cover](#).
2. Install the [left-side cover](#).
3. Follow the procedure in [After working inside your computer](#).

Hard-drive and optical-drive cage

Removing the hard-drive and optical-drive cage

Prerequisites

1. Follow the procedure in [Before working inside your computer](#).
2. Remove the [left-side cover](#).
3. Remove the [front cover](#).
4. Remove the [3.5-inch hard drive](#).

About this task

The following images indicate the location of the hard-drive and optical-drive cage and provide a visual representation of the removal procedure.

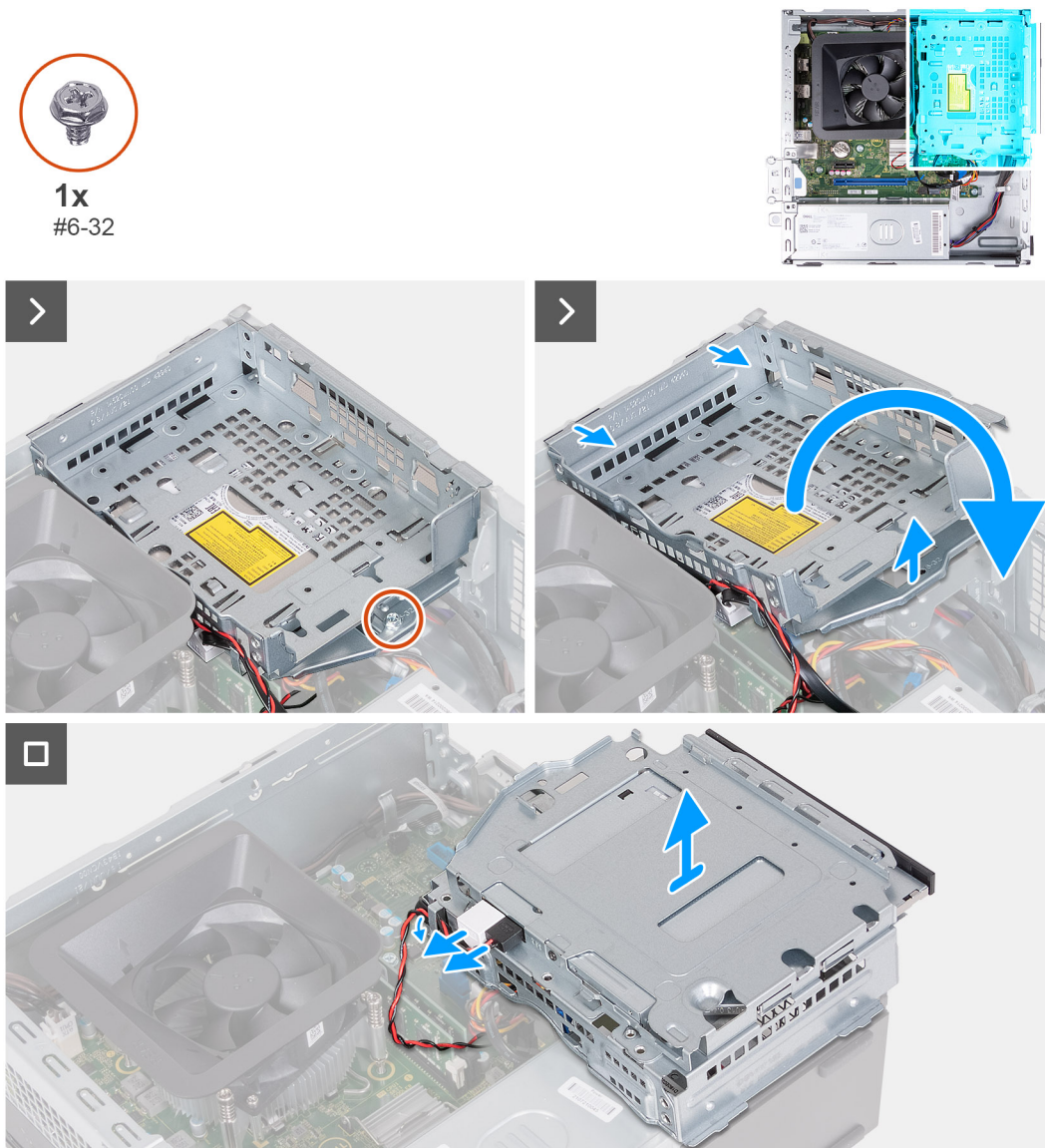



Figure 16. Removing the hard-drive and optical-drive cage

Steps

1. Remove the (#6-32) screw that secures the hard-drive and optical-drive cage to the chassis.

2. Lift and slide the hard-drive and optical-drive bracket away from the chassis

 **NOTE:** The data and power cables are still connected to the optical drive. Carefully slide out the hard-drive and optical-drive cage.

3. Turn over the hard-drive and optical-drive cage.
4. Remove the data and power cables from the routing guides on the hard-drive and optical-drive cage.
5. Disconnect the data and power cable from the optical drive.

 **NOTE:** This step is only applicable to computers shipped with an optical drive.

6. Lift the hard-drive and optical-drive cage away from the chassis.

Installing the hard-drive and optical-drive cage

Prerequisites

If you are replacing a component, remove the existing component before performing the installation process.

About this task

The following images indicate the location of the hard-drive and optical-drive cage and provide a visual representation of the installation procedure.



1x
#6-32

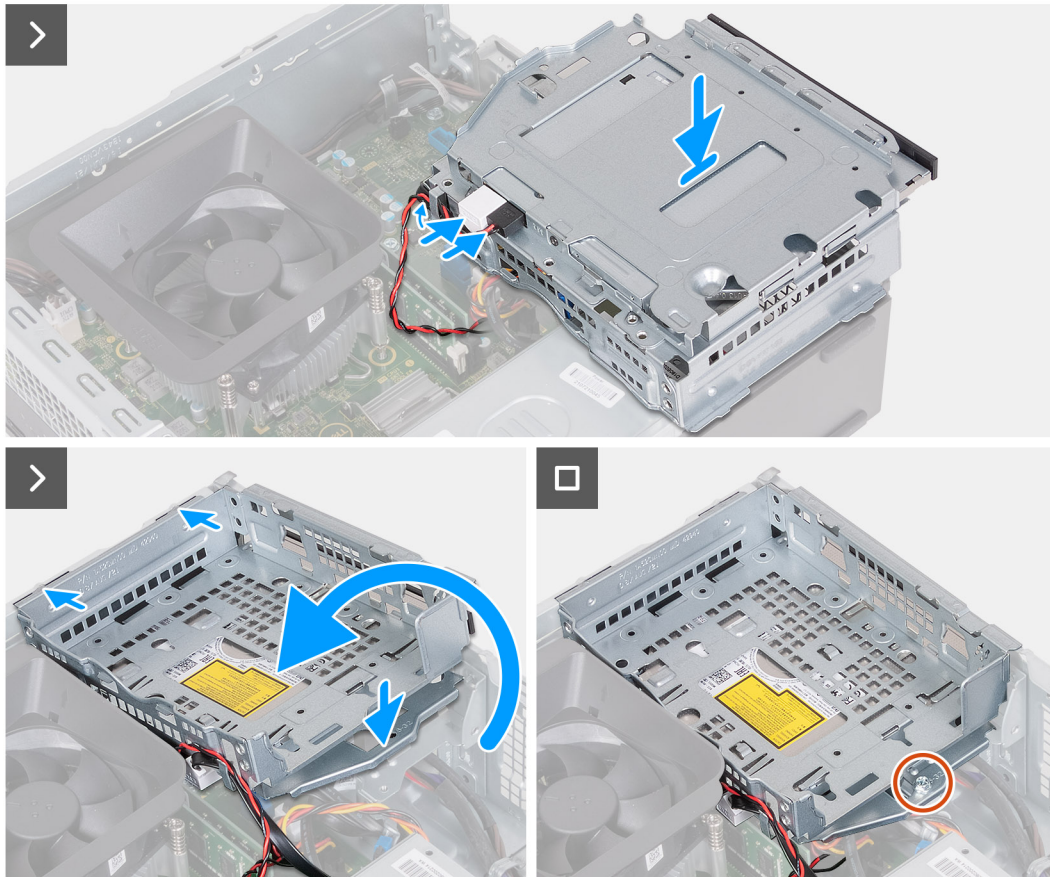

Figure 17. Installing the hard-drive and optical-drive cage

Steps

1. Connect the data and power cable to the optical drive.
i **NOTE:** This step is only applicable to computers shipped with an optical drive.
2. Route the data and power cable through the routing guides on the hard-drive and optical-drive cage.
3. Turn over and align the hard-drive and optical-drive cage to the chassis.
4. Slide and insert the cage at an angle and place it down on the chassis.
5. Replace the (#6-32) screw to secure the hard-drive and optical-drive cage to the chassis.

Next steps

1. Install the [front cover](#).
2. Install the [left-side cover](#).
3. Follow the procedure in [After working inside your computer](#).

Optical drive (optional)

Removing the optical drive

Prerequisites

1. Follow the procedure in [Before working inside your computer](#).
2. Remove the [left-side cover](#).
3. Remove the [front cover](#).
4. Remove the [3.5-inch hard drive](#).
5. Remove the [hard-drive and optical-drive cage](#).

About this task

The following images indicate the location of the optical drive and provide a visual representation of the removal procedure.



Figure 18. Removing the optical drive

Steps

1. Place the hard-drive and optical-drive bracket on a flat surface.

2. Remove the (M2x3) screw that secures the optical drive to the hard-drive and optical-drive bracket.
3. Slide the optical drive out from the hard-drive and optical-drive bracket.
4. Turn over and place the optical drive on a flat surface.
5. Use a pin or a tool with a pointed end and insert the pointed end into the optical-drive emergency eject pinhole to eject the optical drive tray.
6. Use the end of a plastic scribe to push out and unlock the first securing tab of the optical drive bezel.
7. Gently pull the optical drive bezel to release the two remaining securing tabs of the optical bezel.

Installing the optical drive

Prerequisites

If you are replacing a component, remove the existing component before performing the installation process.

About this task

The following images indicate the location of the optical drive and provide a visual representation of the installation procedure.



Figure 19. Installing the optical drive

Steps

1. Align the optical drive bezel to the optical drive and snap the bezel onto the optical drive.
2. Slide the optical drive into the hard-drive and optical-drive bracket.
3. Replace the (M2x3) screw to secure the optical drive to the hard-drive and optical-drive bracket.

Next steps

1. Install the [hard-drive and optical-drive cage](#).
2. Install the [3.5-inch hard drive](#).
3. Install the [front cover](#).
4. Install the [left-side cover](#).
5. Follow the procedure in [After working inside your computer](#).

Power button

Removing the power button

Prerequisites

1. Follow the procedure in [Before working inside your computer](#).
2. Remove the [left-side cover](#).
3. Remove the [front cover](#).
4. Remove the [3.5-inch hard drive](#).
5. Remove the [hard-drive and optical-drive cage](#).

About this task

The following images indicate the location of the power button and provide a visual representation of the removal procedure.



Figure 20. Removing the power button

Steps

1. Disconnect the power-button cable from the connector on the system board.

2. Press the release tabs on the power button to release the power button from the slot on the chassis.
3. Remove the power button and the cable through the slot on the front of the chassis.

Installing the power button

Prerequisites

If you are replacing a component, remove the existing component before performing the installation process.

About this task

The following images indicate the location of the power button and provide a visual representation of the installation procedure.

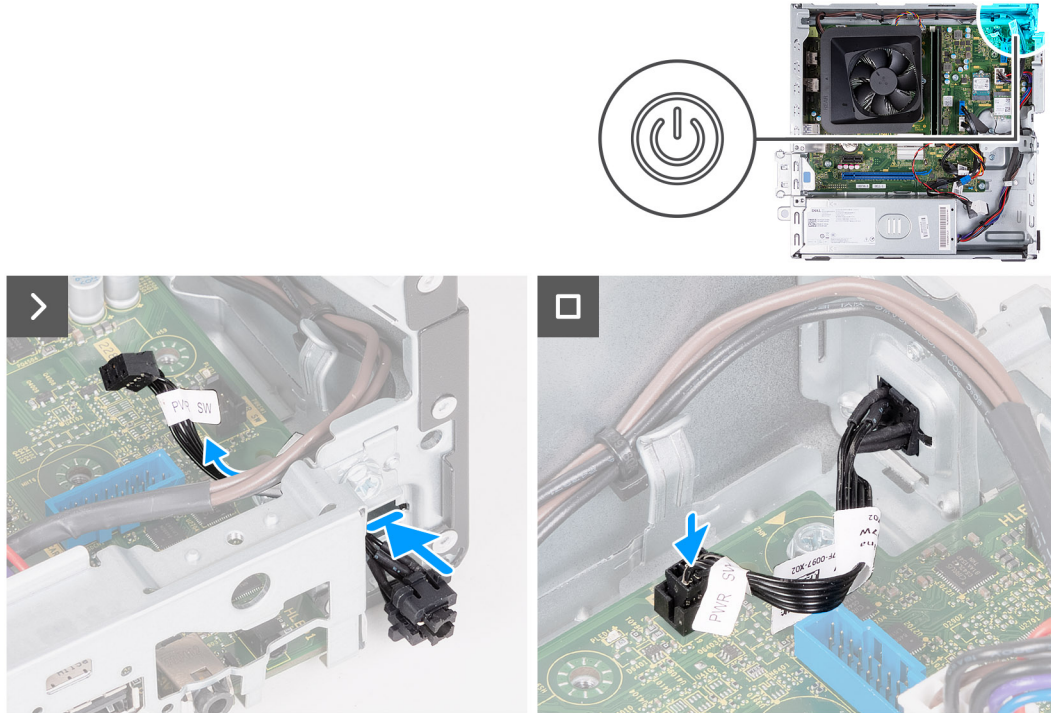

Figure 21. Installing the power button

Steps

1. Slide the power-button cable through the slot on the front of the chassis.
2. Align the tabs on the side of the power button with the cutouts on the slot in the chassis.
3. Press the tabs on the power button to insert it through the front slot and release the tabs to secure it in place.
4. Connect the power-button cable to the connector on the system board.

Next steps

1. Install the [hard-drive and optical-drive cage](#).
2. Install the [3.5-inch hard drive](#).
3. Install the [front cover](#).
4. Install the [left-side cover](#).
5. Follow the procedure in [After working inside your computer](#).

Memory

Removing the memory

CAUTION: To prevent damage to the memory module, hold it by the edges. Do not touch the components or metallic contacts on the memory module as Electrostatic Discharge (ESD) may inflict severe damage on the components. To read more about ESD protection, see [ESD protection](#).

Prerequisites

1. Follow the procedure in [Before working inside your computer](#).
2. Remove the [left-side cover](#).
3. Remove the [front cover](#).
4. Remove the [3.5-inch hard drive](#).
5. Remove the [hard-drive and optical-drive cage](#).

About this task

The following images indicate the location of the memory and provide a visual representation of the removal procedure.

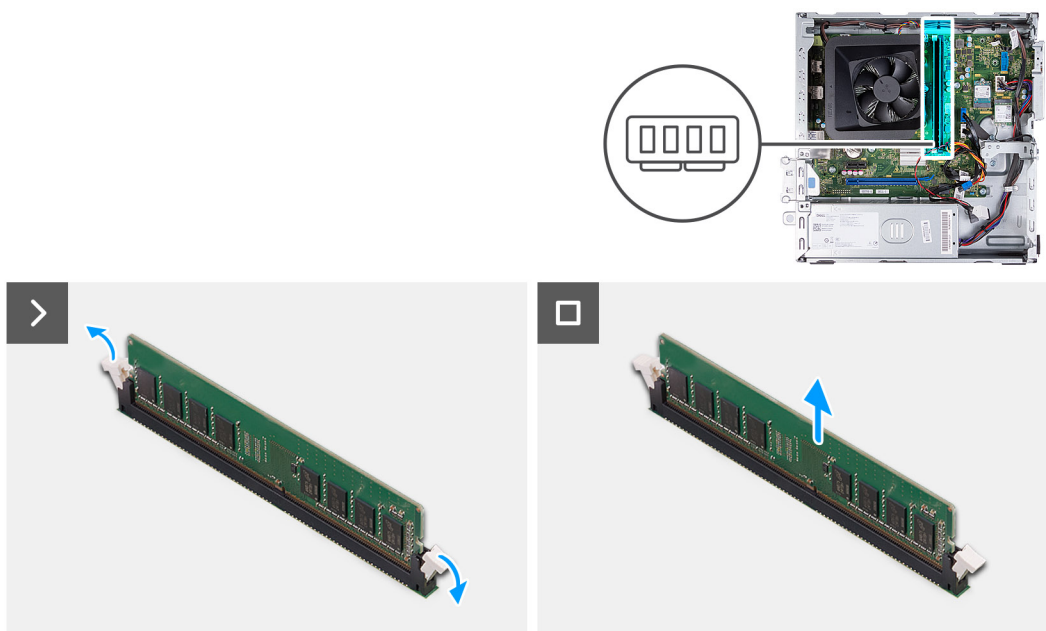

Figure 22. Removing the memory

Steps

1. Pull the securing clips on each end of the memory-module slot down to release the memory module.
2. Grasp the memory module from the middle and remove the memory module from the memory-module slot.

NOTE: Repeat Steps 1 and 2 to remove any other memory modules installed in your computer.

Installing the memory

CAUTION: To prevent damage to the memory module, hold it by the edges. Do not touch the components or metallic contacts on the memory module as Electrostatic Discharge (ESD) may inflict severe damage on the components. To read more about ESD protection, see [ESD protection](#).

Prerequisites

If you are replacing a component, remove the existing component before performing the installation process.

About this task

The following images indicate the location of the memory and provide a visual representation of the installation procedure.

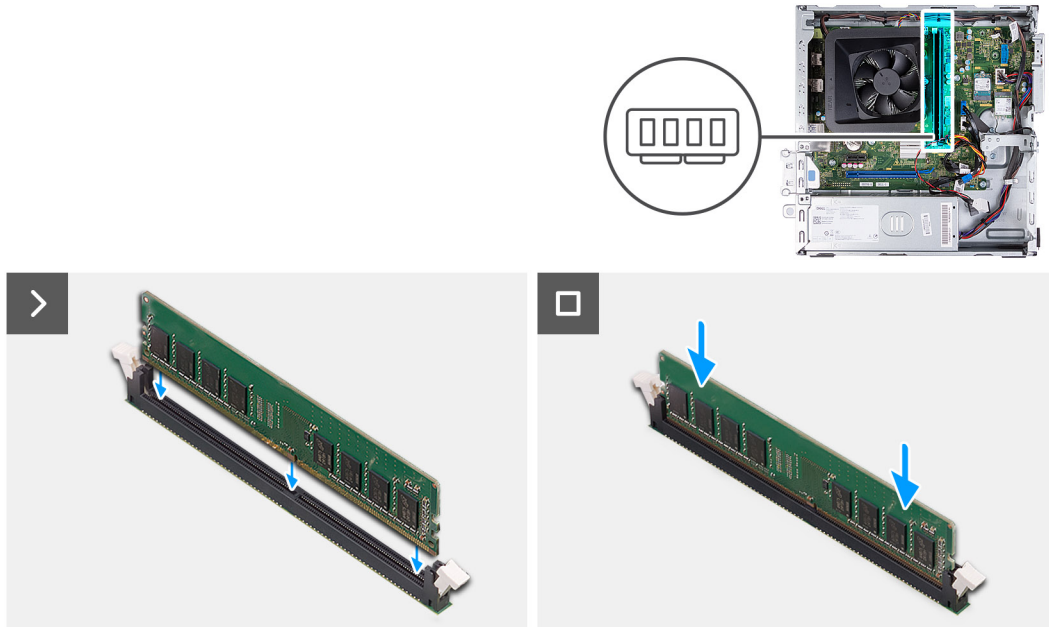

Figure 23. Installing the memory

Steps

1. Align the notch on the memory module with the tab on the memory-module slot.
2. Press the memory module down until the memory module snaps into place and the securing clips lock in place.

NOTE: Repeat Steps 1 and 2 to install any other memory modules on your computer.

Next steps

1. Install the [hard-drive and optical-drive cage](#).
2. Install the [3.5-inch hard drive](#).
3. Install the [front cover](#).
4. Install the [left-side cover](#).
5. Follow the procedure in [After working inside your computer](#).

Solid-state drive

Removing the M.2 2230 solid-state drive

Prerequisites

1. Follow the procedure in [Before working inside your computer](#).
2. Remove the [left-side cover](#).
3. Remove the [front cover](#).
4. Remove the [3.5-inch hard drive](#).
5. Remove the [hard-drive and optical-drive cage](#).

About this task

The following images indicate the location of the M.2 2230 solid-state drive and provide a visual representation of the removal procedure.

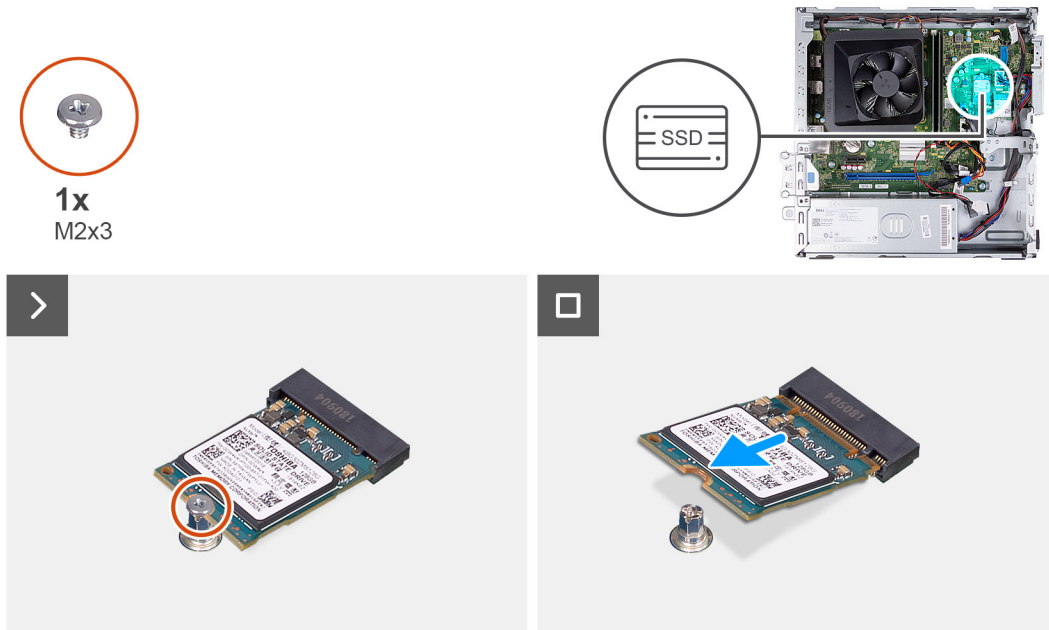

Figure 24. Removing the M.2 2230 solid-state drive

Steps

1. Remove the screw (M2x3) that secures the M.2 2230 solid-state drive to the system board.
2. Slide and lift the M.2 2230 solid-state drive from the M.2 card slot on the system board.

Installing the M.2 2230 solid-state drive

Prerequisites

If you are replacing a component, remove the existing component before performing the installation process.

About this task

i **NOTE:** If you are replacing a M.2 2230 solid-state drive with a M.2 2280 solid-state drive, ensure the M.2 2280 solid-state drive is removed first. See [M.2 2280 solid-state drive](#).

i **NOTE:** The following image indicates the location to install the solid-state drive screw mount based on form factor.

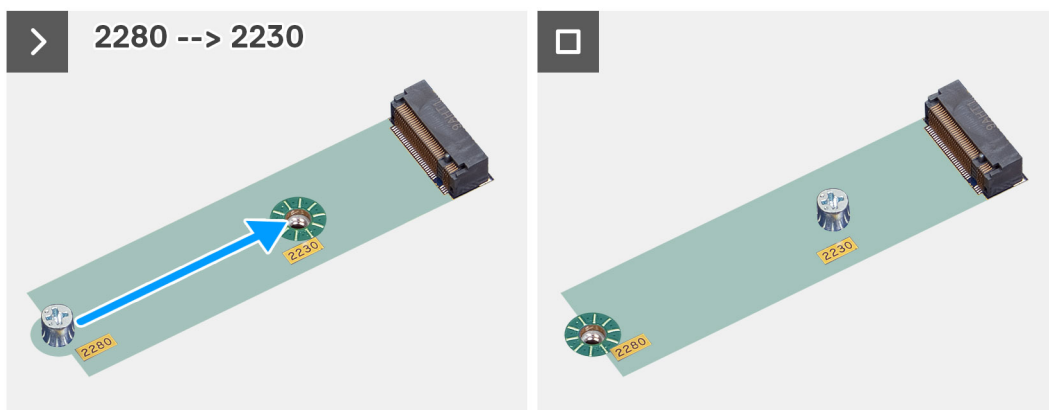

Figure 25. Fixing screw mount 2280 to 2230

The following images indicate the location of the M.2 2230 solid-state drive and provide a visual representation of the installation procedure.

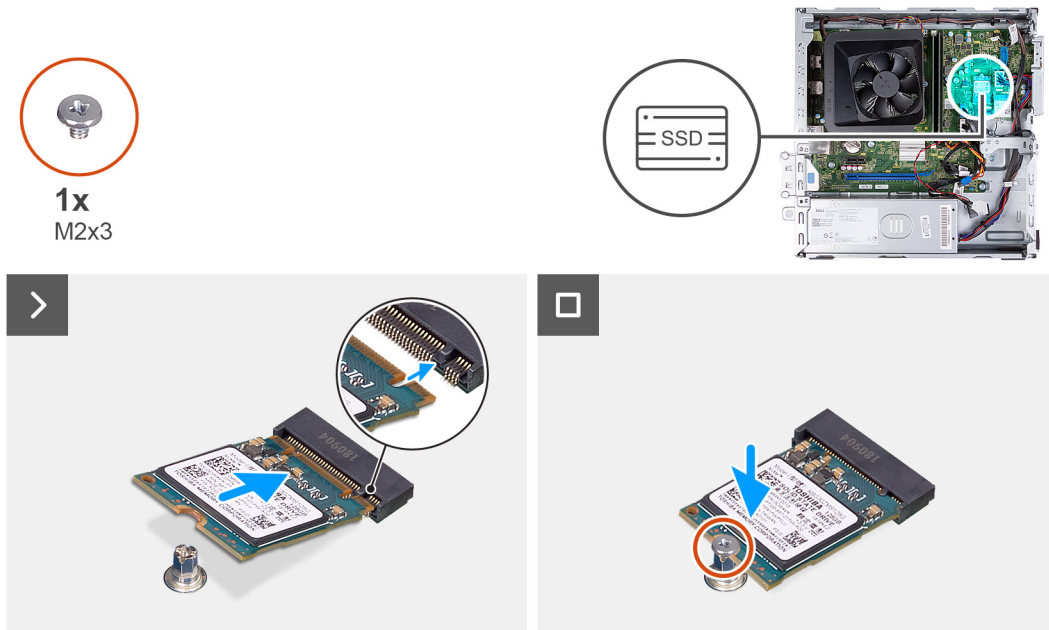

Figure 26. Installing the M.2 2230 solid-state drive

Steps

1. Align the notch on the M.2 2230 solid-state drive with the tab on the M.2 card slot.
2. Slide the M.2 2230 solid-state drive at an angle into the M.2 card slot on the system board.
3. Replace the screw (M2x3) to secure the M.2 2230 solid-state drive to the system board.

Next steps

1. Install the [hard-drive and optical-drive cage](#).
2. Install the [3.5-inch hard drive](#).
3. Install the [front cover](#).
4. Install the [left-side cover](#).
5. Follow the procedure in [After working inside your computer](#).

Removing the M.2 2280 solid-state drive

Prerequisites

1. Follow the procedure in [Before working inside your computer](#).
2. Remove the [left-side cover](#).
3. Remove the [front cover](#).
4. Remove the [3.5-inch hard drive](#).
5. Remove the [hard-drive and optical-drive cage](#).

About this task

The following images indicate the location of the M.2 2280 solid-state drive and provide a visual representation of the removal procedure.

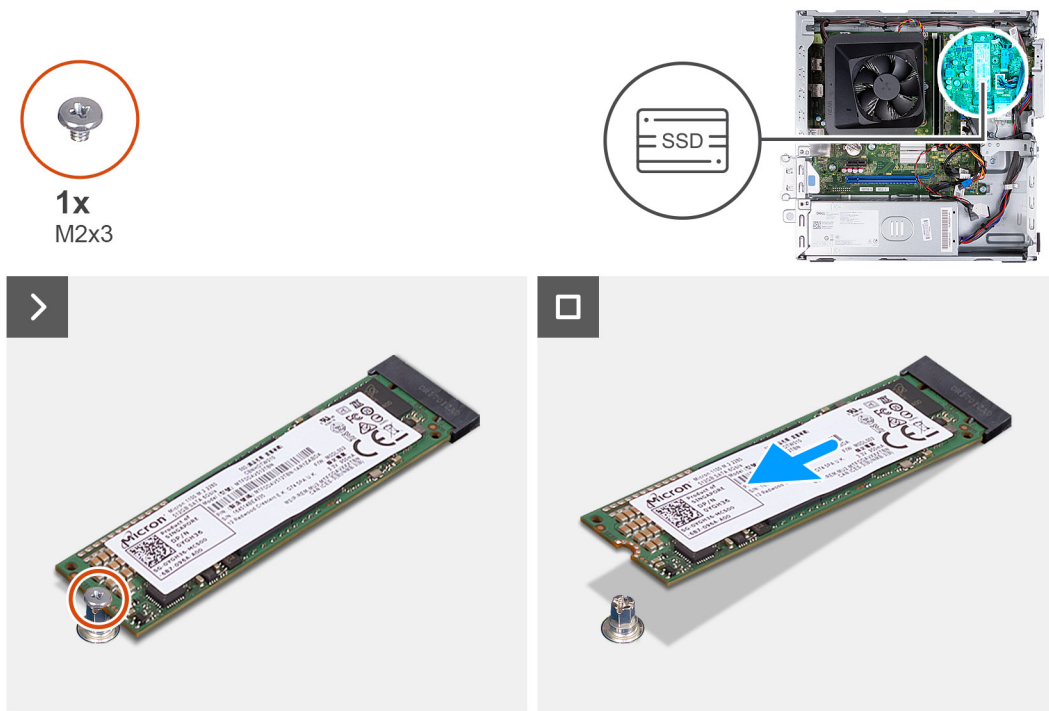

Figure 27. Removing the M.2 2280 solid-state drive

Steps

1. Remove the screw (M2x3) that secures the M.2 2280 solid-state drive to the system board.
2. Slide and lift the M.2 2280 solid-state drive from the M.2 card slot on the system board.

Installing the M.2 2280 solid-state drive

Prerequisites

If you are replacing a component, remove the existing component before performing the installation process.

About this task

NOTE: If you are replacing a M.2 2280 solid-state drive with a M.2 2230 solid-state drive, ensure the M.2 2230 solid-state drive is removed first. See [Removing the M.2 2230 solid-state drive](#)

NOTE: The following image indicates the location to install the solid-state drive screw mount based on form factor.

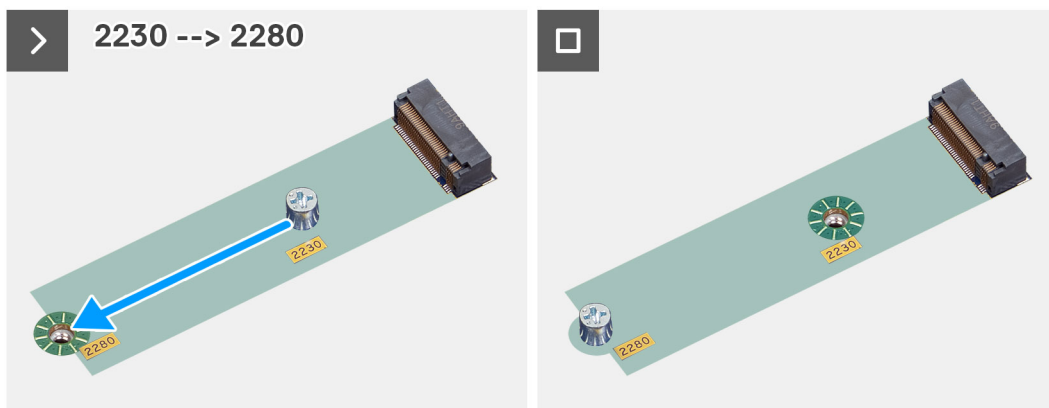

Figure 28. Fixing screw mount 2230 to 2280

The following images indicate the location of the M.2 2280 solid-state drive and provide a visual representation of the installation procedure.

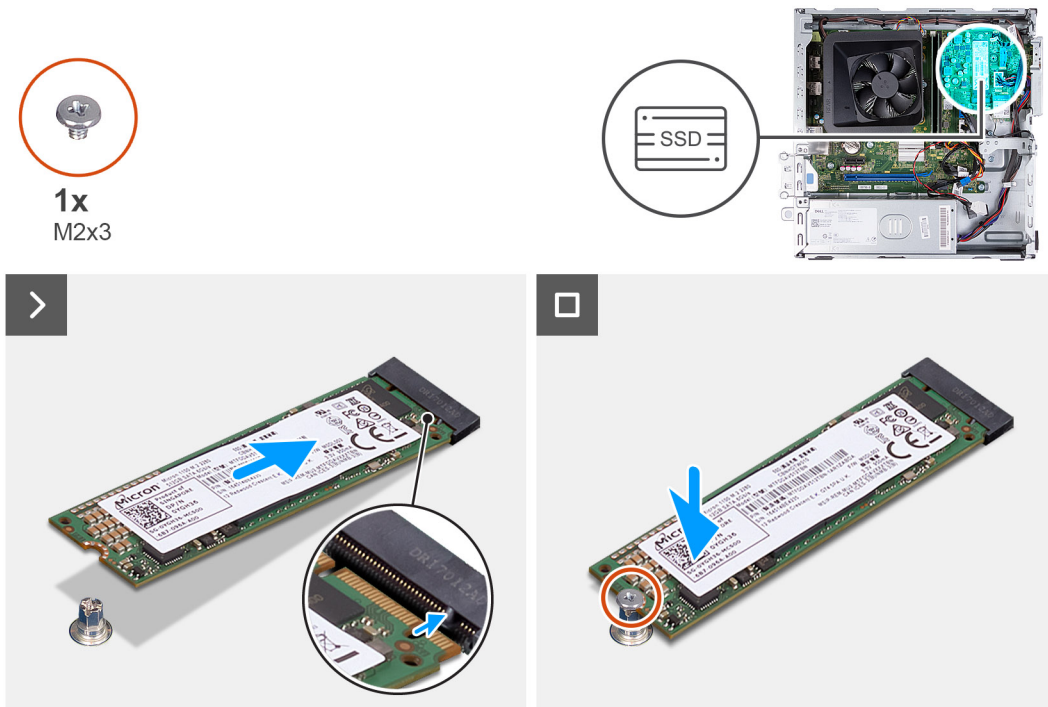

Figure 29. Installing the M.2 2280 solid-state drive

Steps

1. Align the notch on the M.2 2280 solid-state drive with the tab on the M.2 card slot.
2. Slide the M.2 2280 solid-state drive at an angle into the M.2 card slot on the system board.
3. Replace the screw (M2x3) to secure the M.2 2280 solid-state drive to the system board.

Next steps

1. Install the [hard-drive and optical-drive cage](#).
2. Install the [3.5-inch hard drive](#).
3. Install the [front cover](#).
4. Install the [left-side cover](#).
5. Follow the procedure in [After working inside your computer](#).

Wireless card

Removing the wireless card

Prerequisites

1. Follow the procedure in [Before working inside your computer](#).
2. Remove the [left-side cover](#).
3. Remove the [front cover](#).
4. Remove the [3.5-inch hard drive](#).
5. Remove the [hard-drive and optical-drive cage](#).

About this task

The following images indicate the location of the wireless card and provide a visual representation of the removal procedure.

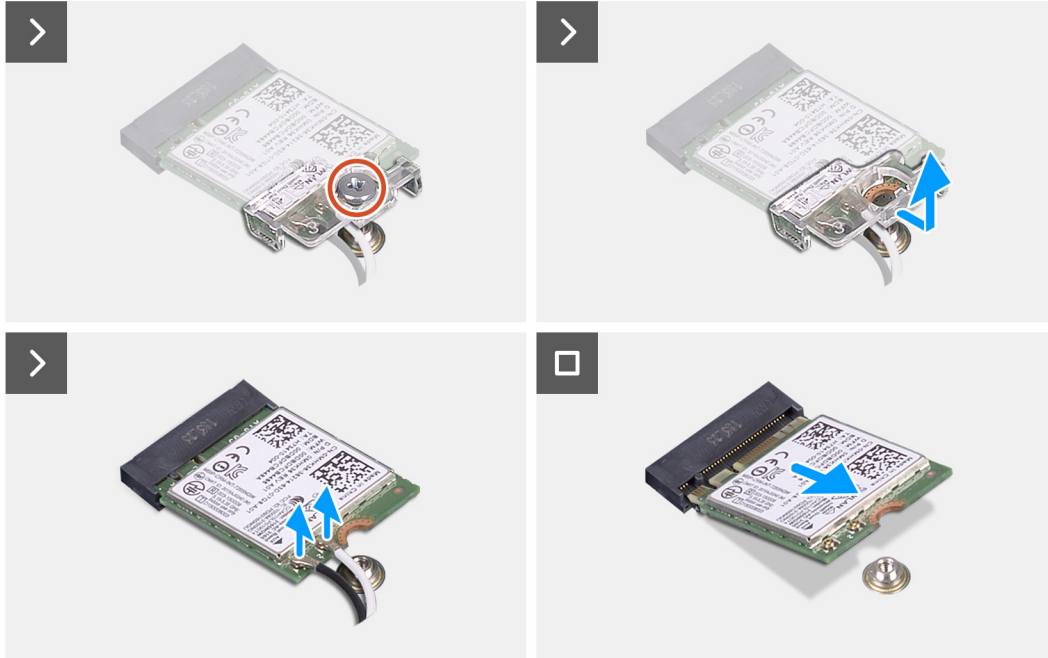
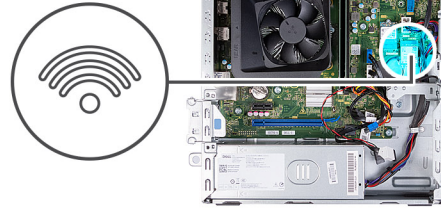

Figure 30. Removing the wireless card

Steps

1. Remove the screw (M2x3) that secures the wireless card on the system board.
2. Slide and lift the wireless-card bracket off the wireless card.
3. Disconnect the antenna cables from the connectors on the wireless card.
4. Slide and remove the wireless card at an angle from the wireless-card slot.

Installing the wireless card

Prerequisites

If you are replacing a component, remove the existing component before performing the installation process.

About this task

The following images indicate the location of the wireless card and provide a visual representation of the installation procedure.

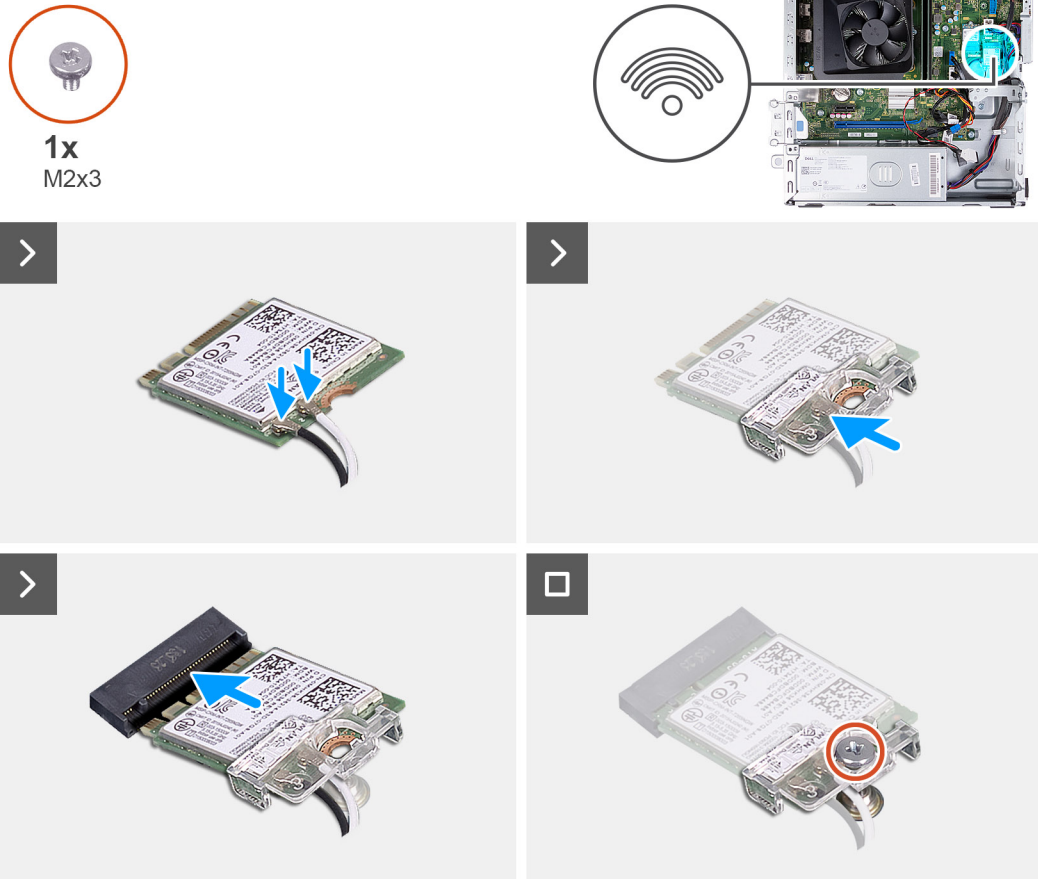

Figure 31. Installing the wireless card

Steps

1. Connect the antenna cables to connectors on the wireless card.
2. Align and place the wireless-card bracket on the wireless card.
3. Align the notch on the wireless card with the tab on the wireless-card slot.
4. Slide the wireless card at an angle into the wireless-card slot.
5. Replace the screw (M2x3) to secure the wireless card on the system board.

Next steps

1. Install the [hard-drive and optical-drive cage](#).
2. Install the [3.5-inch hard drive](#).
3. Install the [front cover](#).
4. Install the [left-side cover](#).
5. Follow the procedure in [After working inside your computer](#).

Coin-cell battery

Removing the coin-cell battery

⚠ CAUTION: Removing the coin-cell battery clears the CMOS and resets the BIOS settings.

Prerequisites

1. Follow the procedure in [Before working inside your computer](#).
2. Remove the [left-side cover](#).

About this task

The following images indicate the location of the coin-cell battery and provide a visual representation of the removal procedure.

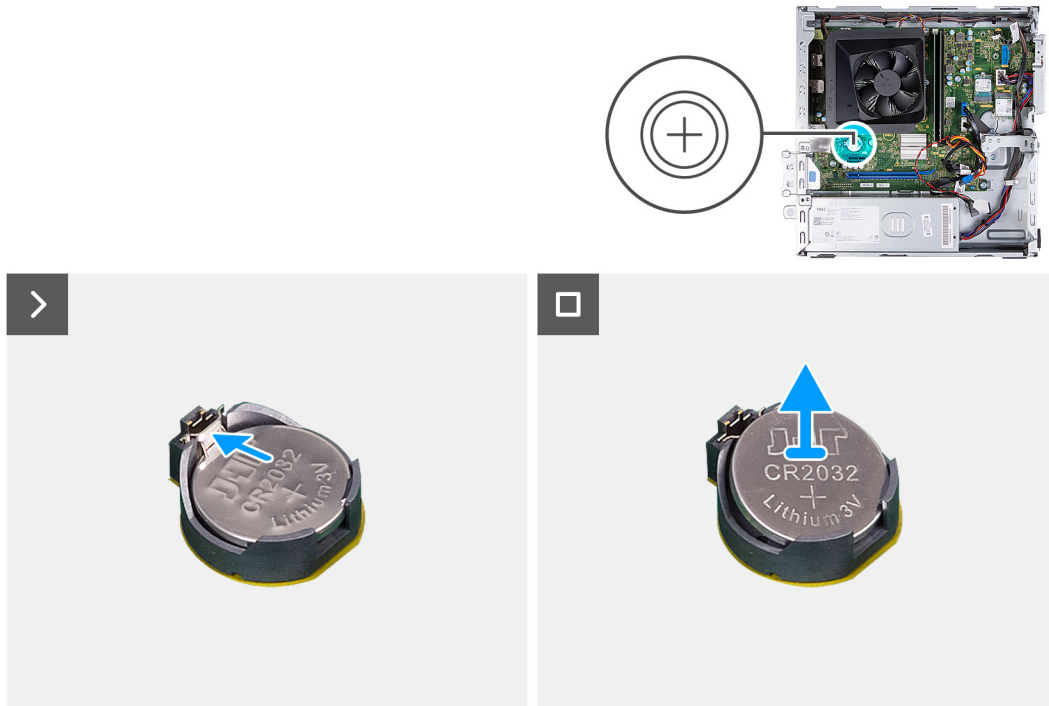

Figure 32. Removing the coin-cell battery

Steps

Push the coin-cell battery securing-clip on the coin-cell battery socket to release the coin-cell battery.

Installing the coin-cell battery

⚠ CAUTION: Removing the coin-cell battery clears the CMOS and resets the BIOS settings.

Prerequisites

If you are replacing a component, remove the existing component before performing the installation process.

About this task

The following images indicate the location of the coin-cell battery and provide a visual representation of the installation procedure.

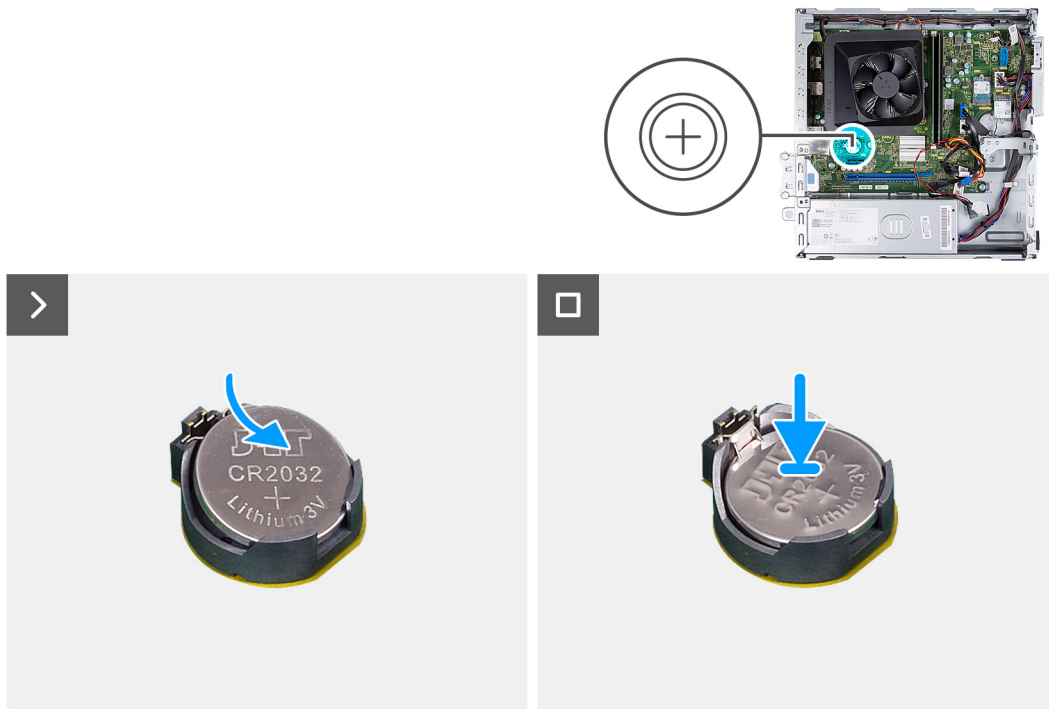

Figure 33. Installing the coin-cell battery

Steps

Insert the coin-cell battery into the battery socket with the positive side (+) label facing up, and snap the battery into place.

Next steps

1. Install the [left-side cover](#).
2. Follow the procedure in [After working inside your computer](#).

Media-card reader (optional)

Removing the media-card reader

Prerequisites

1. Follow the procedure in [Before working inside your computer](#).
2. Remove the [left-side cover](#).
3. Remove the [front cover](#).
4. Remove the [3.5-inch hard drive](#).
5. Remove the [hard-drive and optical-drive cage](#).

About this task

The following images indicate the location of the media-card reader and provide a visual representation of the removal procedure.

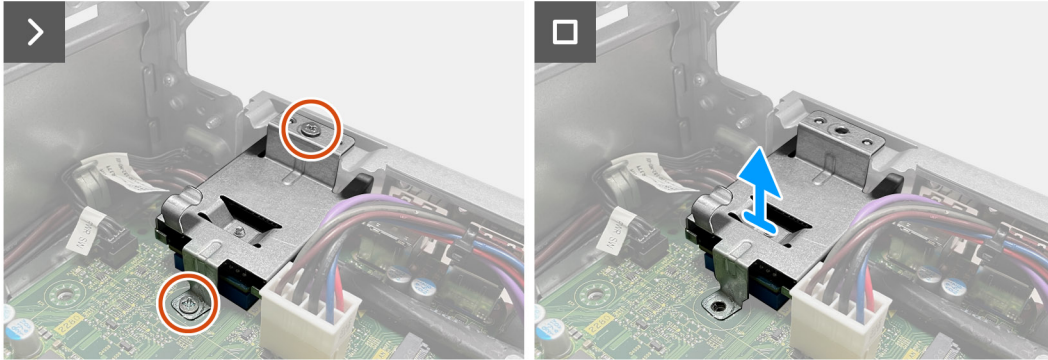

Figure 34. Removing the media-card reader

Steps

1. Remove the two screws (M3x5) that secure the media-card reader bracket to the system board and the chassis.
2. Push the media-card reader bracket to release it from the chassis.
3. Slide and lift the media-card reader and the bracket off the system board.

Installing the media-card reader

Prerequisites

If you are replacing a component, remove the existing component before performing the installation process.

About this task

The following images indicate the location of the media-card reader and provide a visual representation of the installation procedure.



2x
M3x5

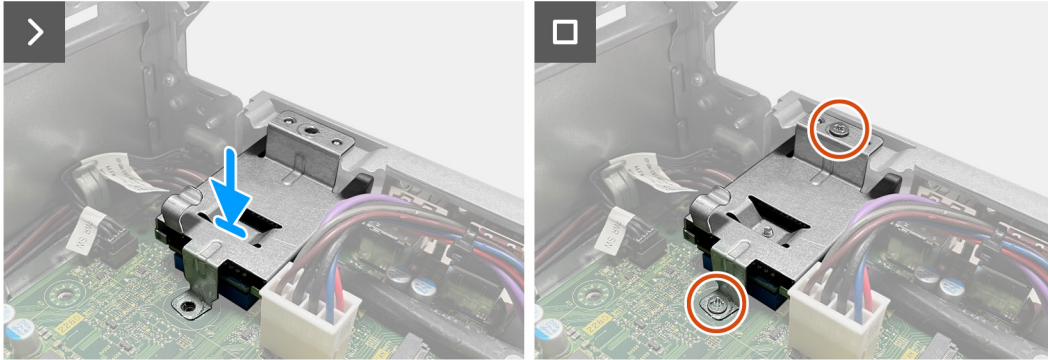

Figure 35. Installing the media-card reader

Steps

1. Align the screw hole on the media-card reader bracket with the screw holes on the system board and the chassis.
2. Align and slide the media-card reader and the bracket into the slot on the system board.
3. Replace the two screws (M3x5) to secure the media-card reader bracket on the system board and the chassis.

Next steps

1. Install the [hard-drive and optical-drive cage](#).
2. Install the [3.5-inch hard drive](#).
3. Install the [front cover](#).
4. Install the [left-side cover](#).
5. Follow the procedure in [After working inside your computer](#).

External antenna

Removing the external antenna

Prerequisites

If you are replacing a component, remove the existing component before performing the installation process.

1. Follow the instructions in [Before working inside your computer](#).

About this task

The following images indicate the location of the external antenna and provide a visual representation of the removal procedure.



Figure 36. Removing the external antenna

Steps

1. Loosen the bolts that secure the external-antenna cables to the SMA connectors on the chassis.
2. Remove the external-antenna cables from the SMA connectors on the chassis.

Installing the external antenna

Prerequisites

If you are replacing a component, remove the existing component before performing the installation process.

About this task

The following images indicate the location of the external antenna and provide a visual representation of the installation procedure.

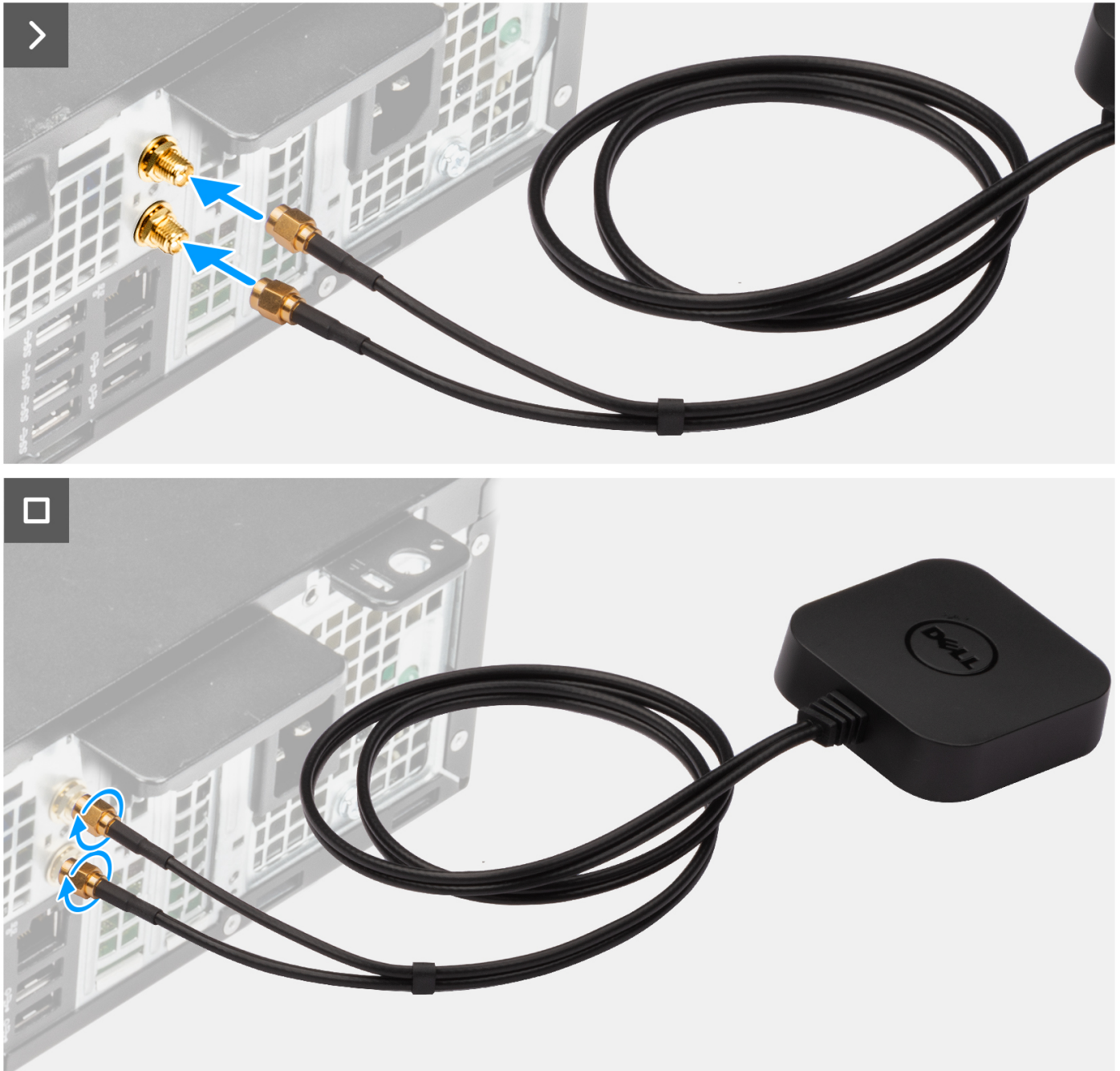

Figure 37. Installing the external antenna

Steps

1. Align and connect the external-antenna cables to the SMA connectors on the chassis.
2. Tighten the bolts to secure the external-antenna cables to the SMA connectors on the chassis.

Next steps

1. Follow the procedure in [After working inside your computer](#).

Removing and installing Field Replaceable Units (FRUs)

The replaceable components in this chapter are Field Replaceable Units (FRUs).

CAUTION: The information in this removing and installing FRU's section is intended for authorized service technicians only.

CAUTION: To avoid any potential damage to the component or loss of data, ensure that an authorized service technician replaces the Field Replaceable Units (FRUs).

CAUTION: Dell Technologies recommends that this set of repairs, if needed, to be conducted by trained technical repair specialists.

CAUTION: As a reminder, your warranty does not cover damages that may occur during FRU repairs that are not authorized by Dell Technologies.

NOTE: The images in this document may differ from your computer depending on the configuration you ordered.

Power supply unit

Removing the power supply unit

CAUTION: The information in this section is intended for authorized service technicians only.

Prerequisites

1. Follow the procedure in [Before working inside your computer](#).
2. Remove the [left-side cover](#).
3. Remove the [front cover](#).
4. Remove the [3.5-inch hard drive](#).
5. Remove the [hard-drive and optical-drive cage](#).

About this task

The following images indicate the location of the power supply unit and provide a visual representation of the removal procedure.



3x
#6-32

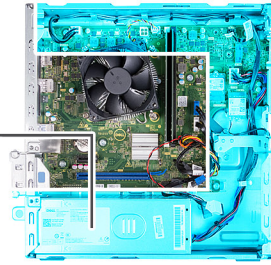
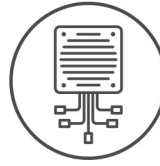

Figure 38. Removing the cables from the routing guides



Figure 39. Removing the power supply unit

Steps

1. Press the securing clips and disconnect the processor-power cable and the system-board power cable from the connectors on the system board.
2. Remove the power supply unit cables from the routing guides on the chassis.
3. In a reverse sequential order (3>2>1), remove the three screws (#6-32) that secure the power supply unit on the chassis.
4. Slide and lift the power supply unit off the chassis.

Installing the power supply unit

CAUTION: The information in this section is intended for authorized service technicians only.

Prerequisites

If you are replacing a component, remove the existing component before performing the installation process.

About this task

The following images indicate the location of the power supply unit and provide a visual representation of the installation procedure.

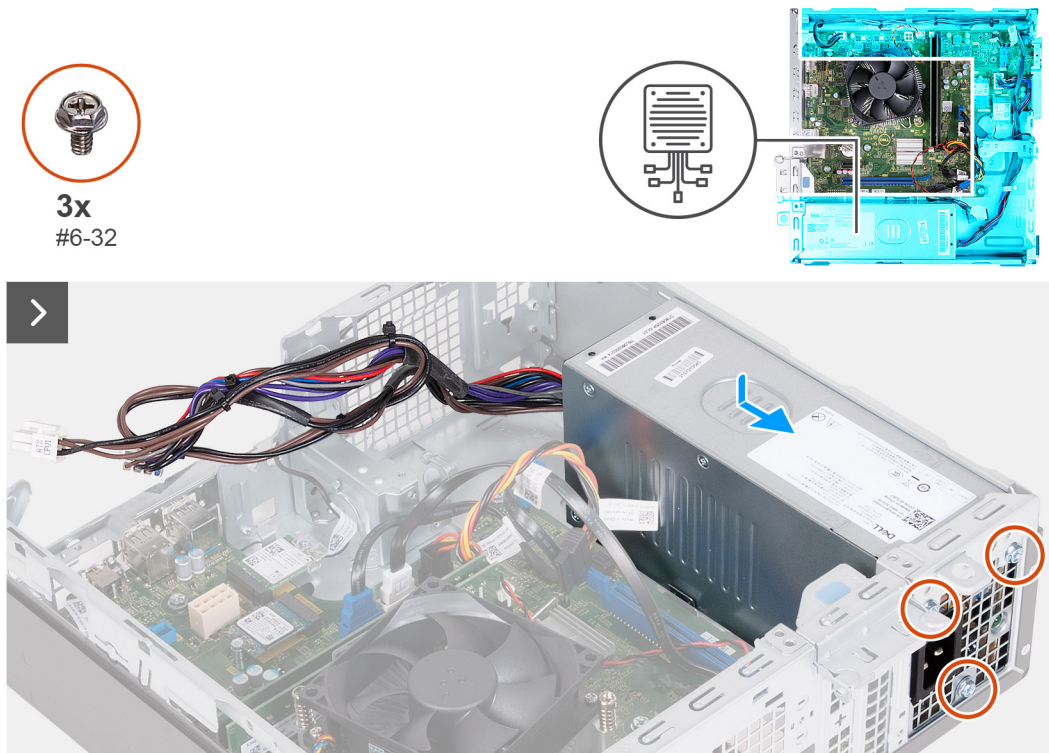

Figure 40. Installing the power supply unit



Figure 41. Routing the cables through the routing guides

Steps

1. Align and slide the tabs on the power supply unit into the latches on the chassis.
2. Align the screw holes on the power supply unit with the screw holes on the chassis.
3. In a sequential order (1>2>3), replace the three screws (#6-32) to secure the power supply unit on the chassis.
4. Route the power supply unit cables through the routing guides on the chassis.
5. Connect the system-board power cable and the processor-power cable to the connectors on the system board.

Next steps

1. Install the [hard-drive and optical-drive cage](#).
2. Install the [3.5-inch hard drive](#).
3. Install the [front cover](#).
4. Install the [left-side cover](#).
5. Follow the procedure in [After working inside your computer](#).

Antenna modules

Removing the antenna module

CAUTION: The information in this section is intended for authorized service technicians only.

Prerequisites

1. Follow the procedure in [Before working inside your computer](#).
2. Remove the [left-side cover](#).

3. Remove the [front cover](#).
4. Remove the [3.5-inch hard drive](#).
5. Remove the [hard-drive and optical-drive cage](#).
6. Remove the [wireless card](#).

About this task

The following images indicate the location of the antenna module and provide a visual representation of the removal procedure.

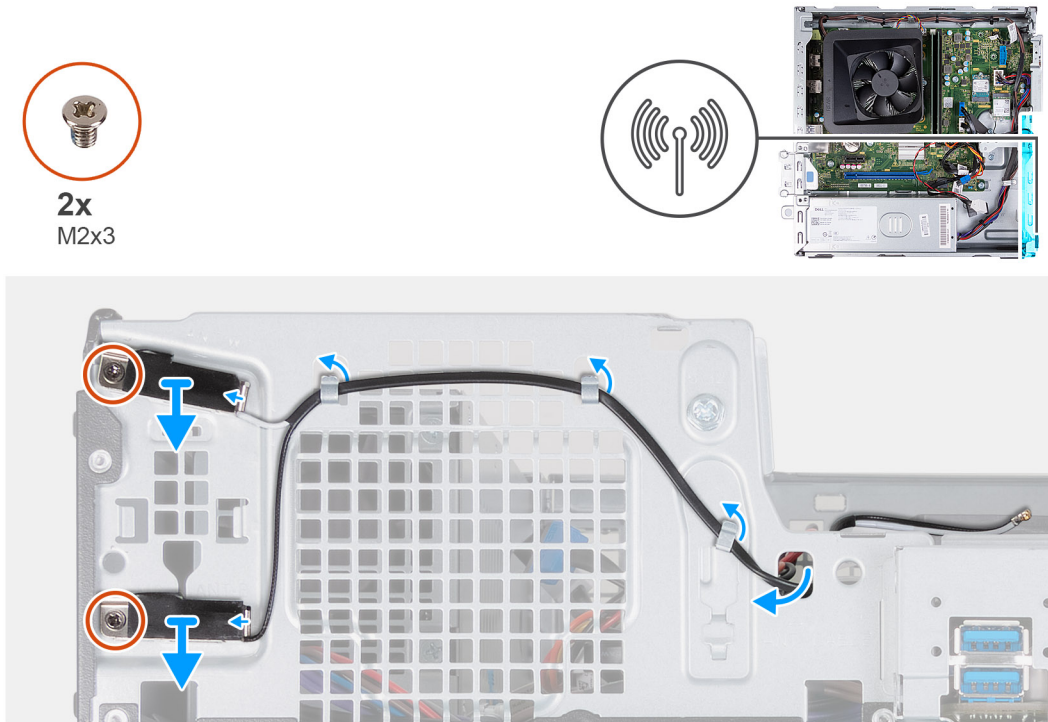

Figure 42. Removing the antenna module

Steps

1. Remove the two screws (M2x3) that secure the antenna modules to the chassis.
2. Remove the antenna cables from the routing guide on the chassis.
3. Remove the antenna cables from the slot on the chassis.
4. Lift the antenna modules along with the cables off the chassis.

Installing the antenna module

CAUTION: The information in this section is intended for authorized service technicians only.

Prerequisites

If you are replacing a component, remove the existing component before performing the installation process.

About this task

The following images indicate the location of the antenna module and provide a visual representation of the installation procedure.

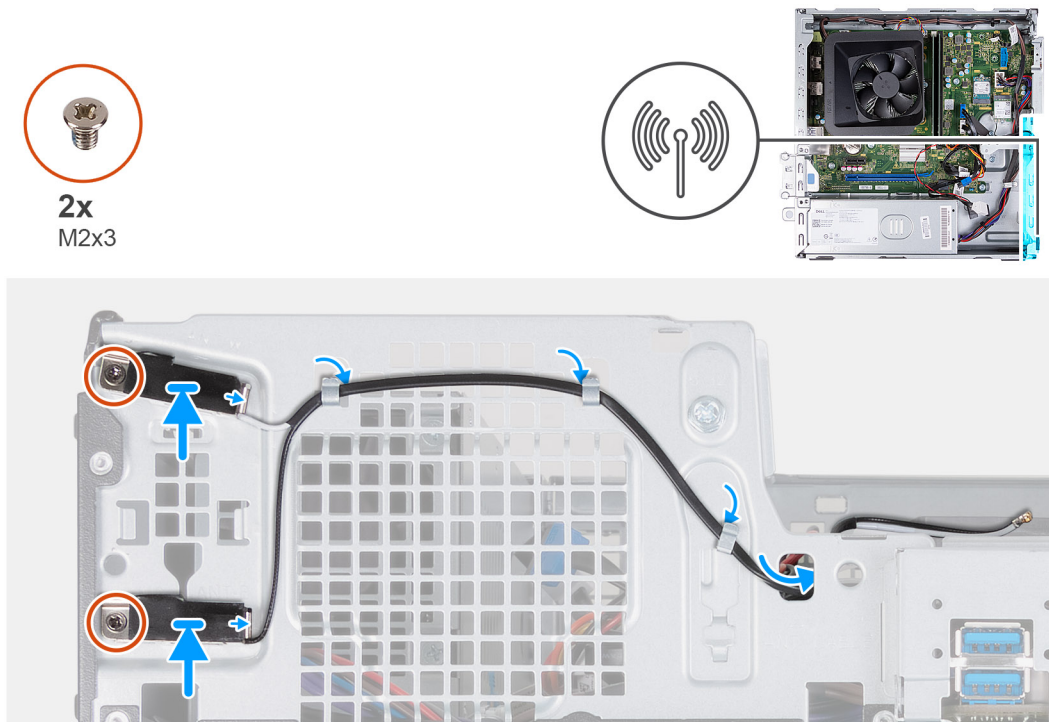

Figure 43. Installing the antenna module

Steps

1. Align the screws on the antenna modules with the screw holes on the chassis.
2. Replace the two screws (M2x3) to secure the antenna modules on the chassis.
3. Route the antenna cables through the routing guides on the chassis.
4. Insert the antenna cables through the slot on the chassis.

Next steps

1. Install the [wireless card](#).
2. Install the [hard-drive and optical-drive cage](#).
3. Install the [3.5-inch hard drive](#).
4. Install the [front cover](#).
5. Install the [left-side cover](#).
6. Follow the procedure in [After working inside your computer](#).

SMA antenna kit

Removing the SMA antenna kit

CAUTION: The information in this section is intended for authorized service technicians only.

Prerequisites

NOTE: This component is shipped only with specific computer configurations.

1. Follow the procedure in [Before working inside your computer](#).
2. Remove the [left-side cover](#).
3. Remove the [front cover](#).
4. Remove the [3.5-inch hard drive](#).
5. Remove the [hard-drive and optical-drive cage](#).

6. Remove the [wireless card](#).

About this task

The following image indicates the location of the SMA antenna kit and provides a visual representation of the removal procedure.

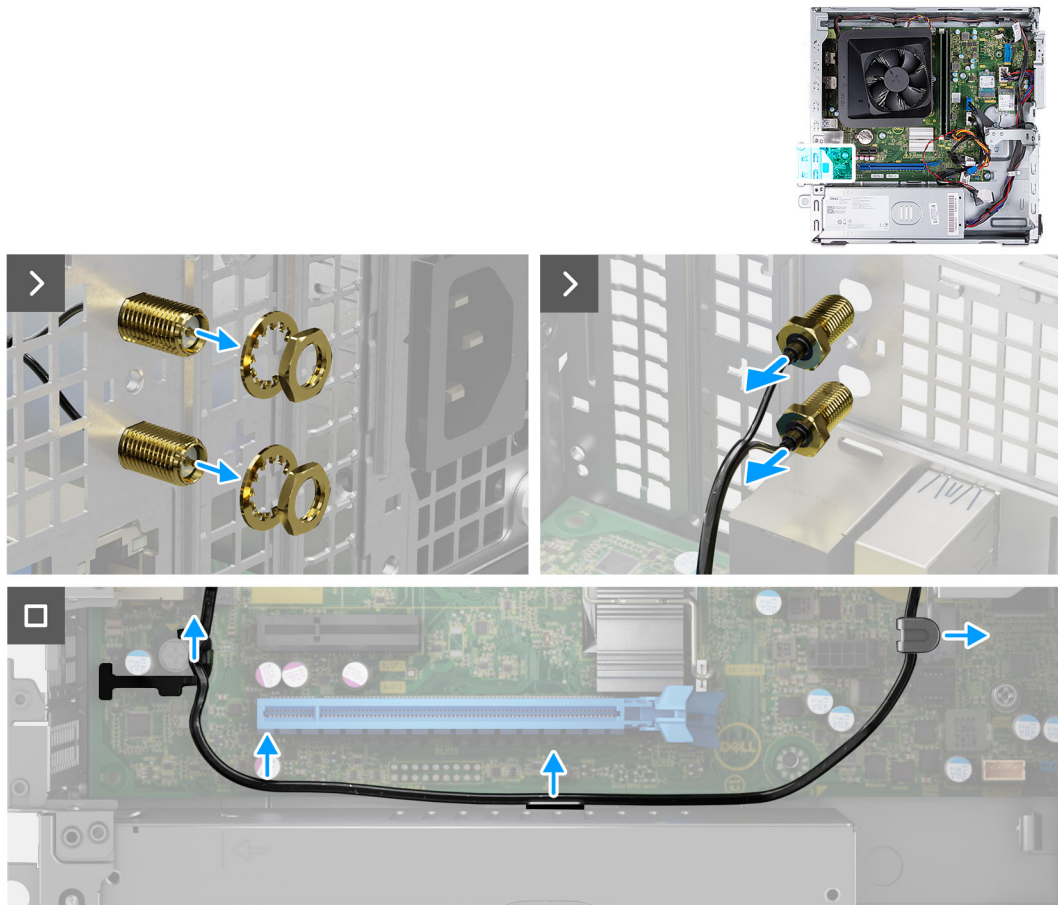

Figure 44. Removing the SMA Antenna kit

Steps

1. Remove the nut and washer from the two antenna heads.
2. Gently pry and remove the antenna heads from the chassis.
3. Remove the antenna cables from routing guides on the system board.
4. Remove the SMA antenna kit off the system board.

Installing the SMA antenna kit

CAUTION: The information in this section is intended for authorized service technicians only.

Prerequisites

If you are replacing a component, remove the existing component before performing the installation procedure.

NOTE: This component is shipped only with specific computer configurations.

About this task

The following image indicates the location of the SMA antenna kit and provides a visual representation of the installation procedure.

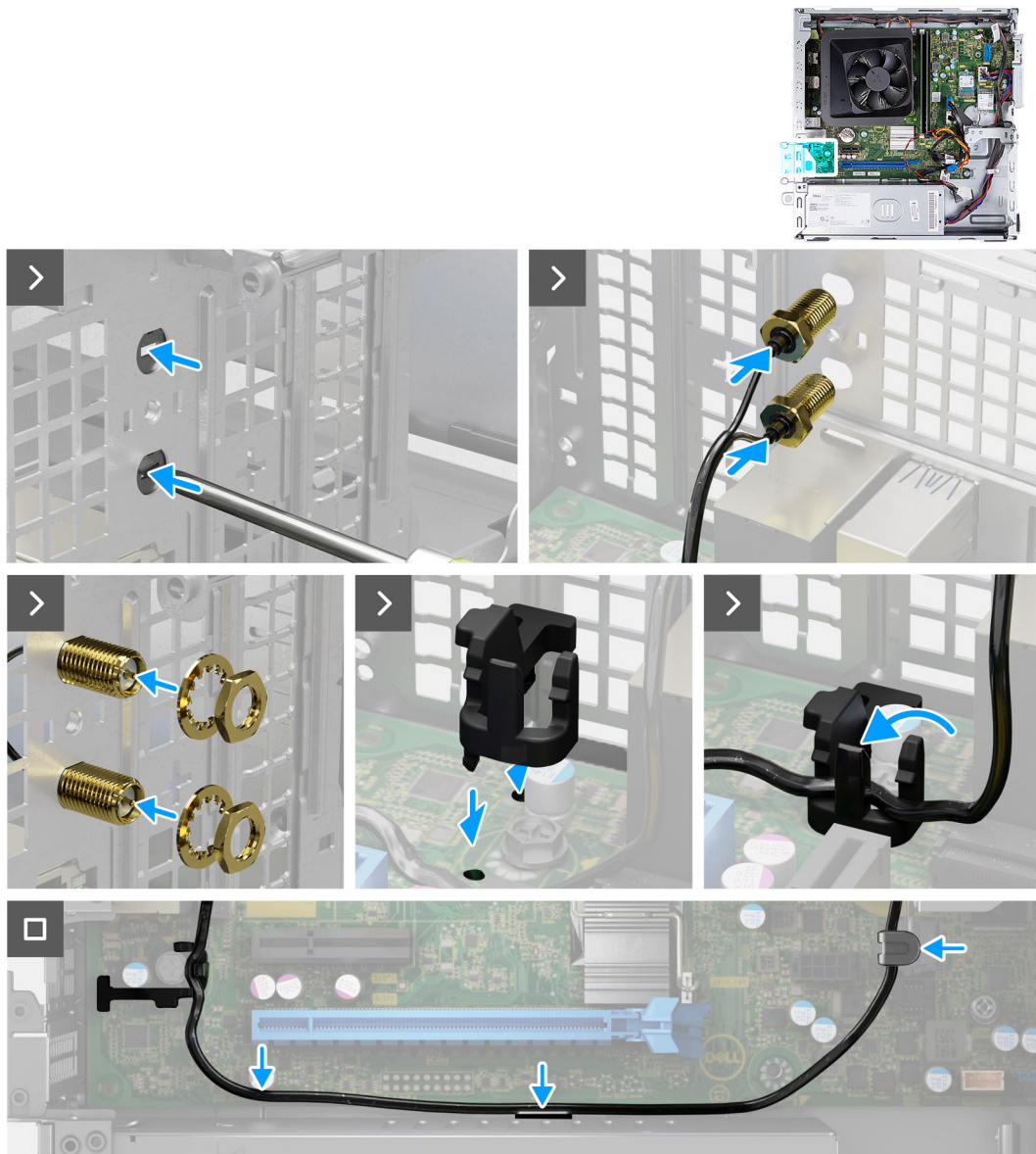

Figure 45. Installing the SMA antenna kit

Steps

1. **i** **NOTE:** Steps 1, 2, and 3 are required when installing the SMA antenna kit for the first time.

Using a screw driver, push and remove the antenna cover from the chassis.

2. Remove the antenna cover from the screw driver and dispose the antenna cover.
3. Align the pins on the clip with the holes on the system board and press the clip to secure the clip to the system board.
4. Push the antennas into the slots on the back of the chassis.
5. Install the nut and washer to secure the antennas to the chassis.
6. Route the antenna cables through the routing guides on the system board.
7. Press the antenna cable into the clip on the system board.

Next steps

1. Install the [wireless card](#).
2. Install the [hard-drive and optical-drive cage](#).
3. Install the [3.5-inch hard drive](#).
4. Install the [front cover](#).

5. Install the [left-side cover](#).
6. Follow the procedure in [After working inside your computer](#).

Fan shroud

Removing the fan shroud

Prerequisites

1. Follow the procedure in [Before working inside your computer](#).
2. Remove the [left-side cover](#).

About this task

The following images indicate the location of the fan shroud and provide a visual representation of the removal procedure.

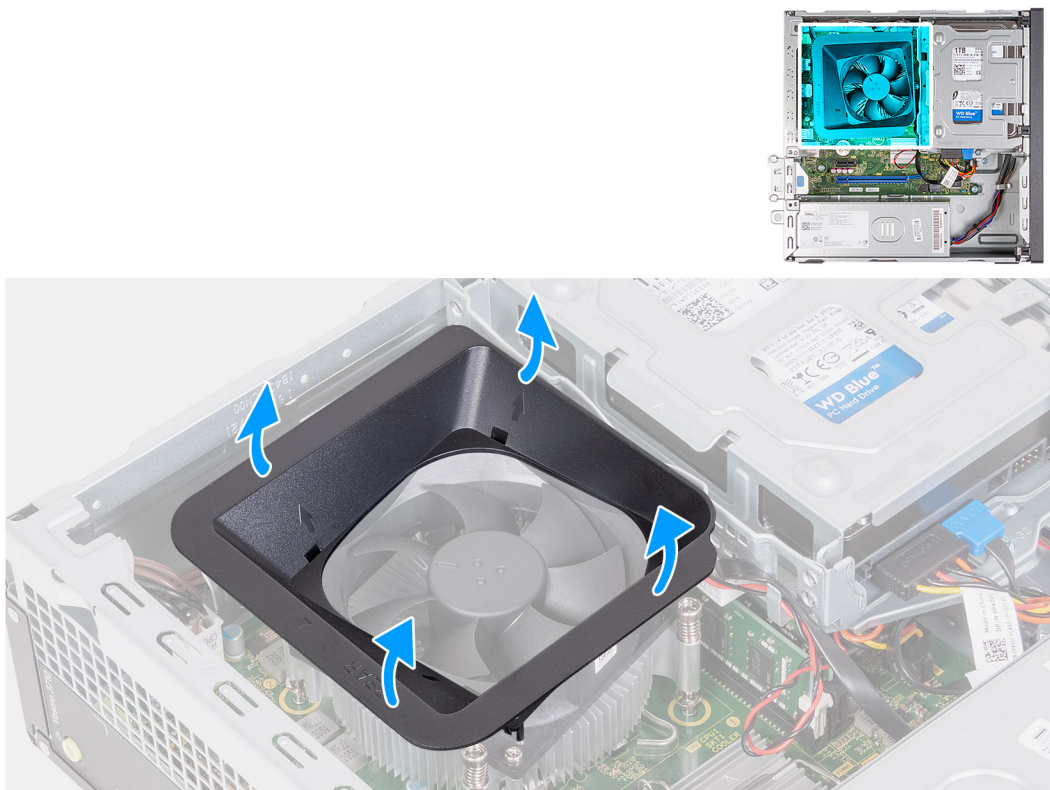

Figure 46. Removing the fan shroud

Steps

1. Pull the securing tabs of the fan shroud to release the fan shroud from the processor fan.
2. Lift the fan shroud off the processor fan.

Installing the fan shroud

Prerequisites

If you are replacing a component, remove the existing component before performing the installation process.

About this task

The following image indicates the location of the fan shroud and provides a visual representation of the installation procedure.

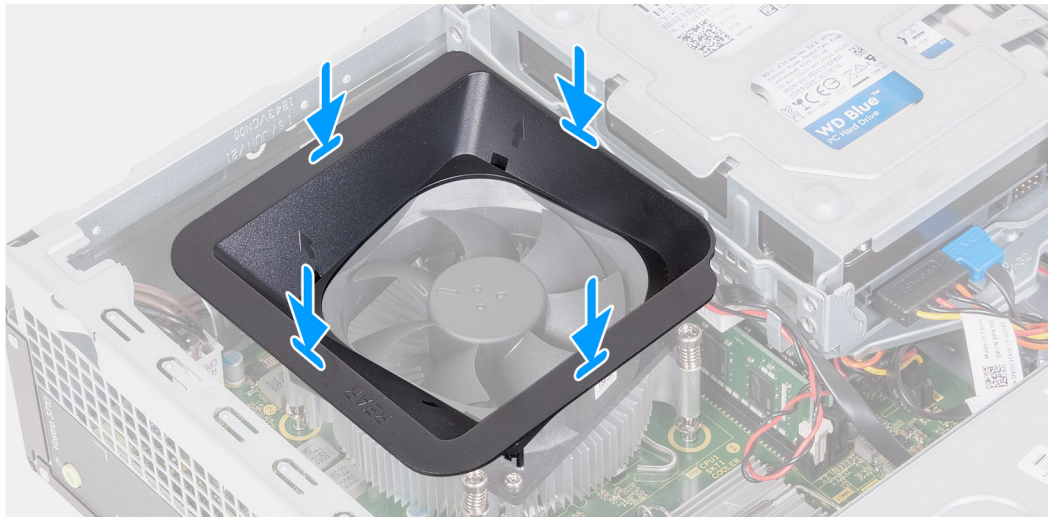

Figure 47. Installing the fan shroud

Steps

1. Align the fan shroud over the processor fan.
 - i** **NOTE:** The side of the fan with the word 'REAR' written must face the rear of the chassis.
 - i** **NOTE:** The stubs on the fan shroud must align to the corresponding stub holes on the processor fan.
2. Press down on the fan shroud until all the securing tabs snap into position.

Next steps

1. Install the [left-side cover](#).
2. Follow the procedure in [After working inside your computer](#).

Processor fan and heat-sink assembly

Removing the processor fan and heat-sink assembly

⚠ CAUTION: The information in this section is intended for authorized service technicians only.

Prerequisites

1. Follow the procedure in [Before working inside your computer](#).
2. Remove the [left-side cover](#).
3. Remove the [fan shroud](#).
4. Remove the [hard-drive and optical-drive cage](#).

About this task

The following images indicate the location of the fan and heat-sink assembly and provide a visual representation of the removal procedure.

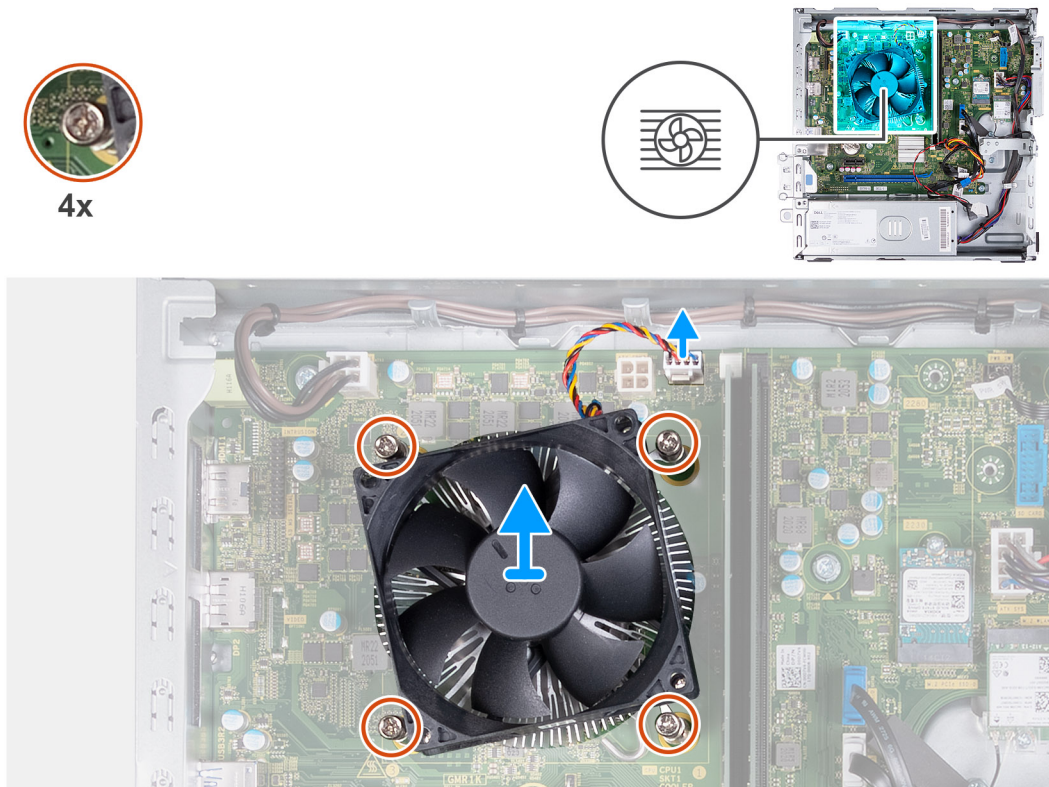

Figure 48. Removing the processor fan and heat-sink assembly

Steps

1. Disconnect the fan and heat-sink assembly cable from the connector on the system board.
2. In a reverse sequential order (4>3>2>1), loosen the four captive screws that secure the processor fan and heat-sink assembly to the system board.
3. Lift the processor fan and heat-sink assembly from the system board.

Installing the processor fan and heat-sink assembly

CAUTION: The information in this section is intended for authorized service technicians only.

Prerequisites

If you are replacing a component, remove the existing component before performing the installation process.

About this task

The following images indicate the location of the fan and heat-sink assembly and provide a visual representation of the installation procedure.

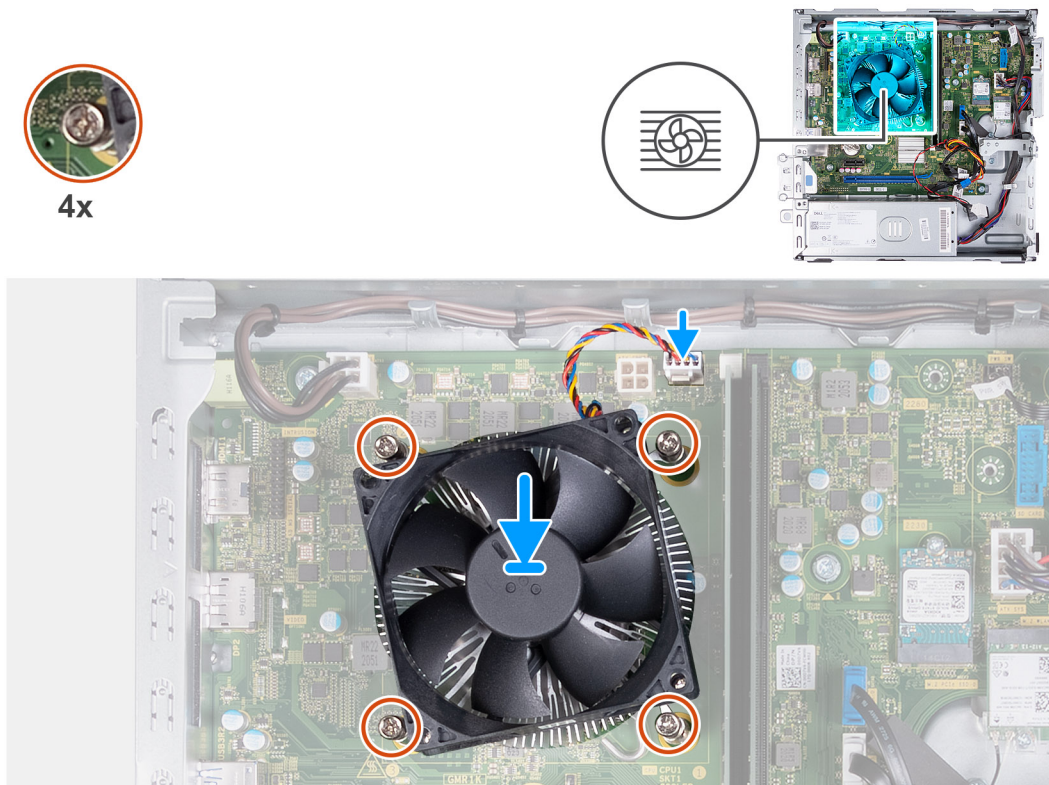

Figure 49. Installing the processor fan and heat-sink assembly

Steps

1. Gently align and place the processor fan and heat-sink assembly on the processor.
 - NOTE:** The side of the fan with the word 'REAR' written must face the rear of the chassis.
 - NOTE:** The stubs on the fan shroud must align to the corresponding stub holes on the processor fan.
2. Align the screw holes on the processor fan and heat-sink assembly with the screw holes on the system board.
3. In a sequential order (1>2>3>4), tighten the four captive screws to secure the processor fan and heat-sink assembly on the system board.
4. Connect the fan and heat-sink assembly cable to the connector on the system board.

Next steps

1. Install the [hard-drive and optical-drive cage](#).
2. Install the [fan shroud](#).
3. Install the [left-side cover](#).
4. Follow the procedure in [After working inside your computer](#).

Processor

Removing the processor

CAUTION: The information in this section is intended for authorized service technicians only.

Prerequisites

1. Follow the procedure in [Before working inside your computer](#).
2. Remove the [left-side cover](#).

3. Remove the fan shroud.
4. Remove the processor fan and heat-sink assembly.

About this task

The following images indicate the location of the processor and provide a visual representation of the removal procedure.

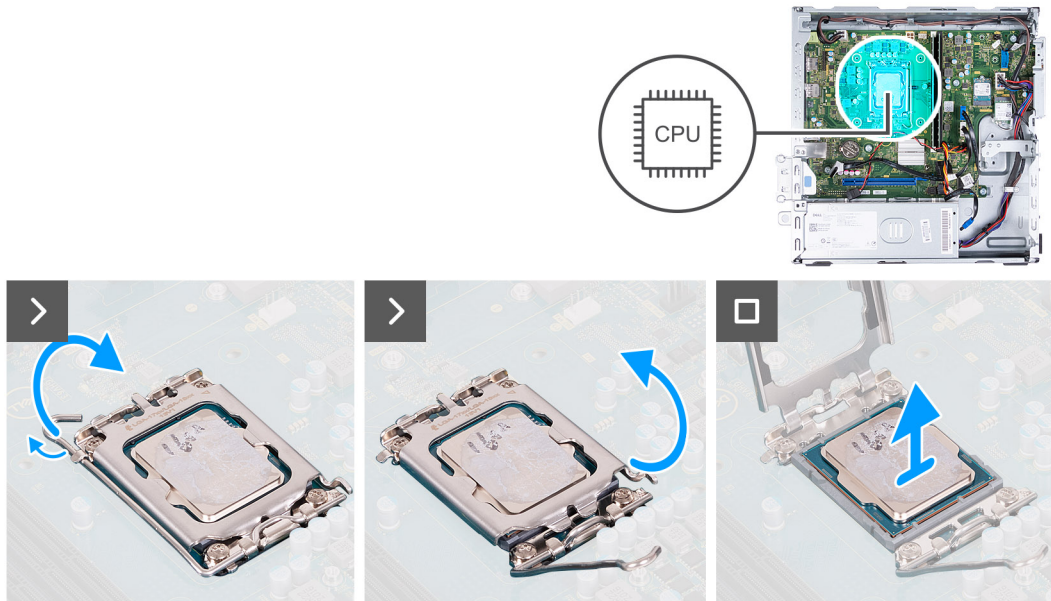

Figure 50. Removing the processor

Steps

1. Press the release lever down and push the lever away from the processor to release the lever from the securing tab.
2. Extend the release lever completely and open the processor cover.
3. Gently lift and remove the processor from the processor socket.

Installing the processor

CAUTION: The information in this section is intended for authorized service technicians only.

Prerequisites

If you are replacing a component, remove the existing component before performing the installation process.

About this task

The following images indicate the location of the processor and provide a visual representation of the installation procedure.

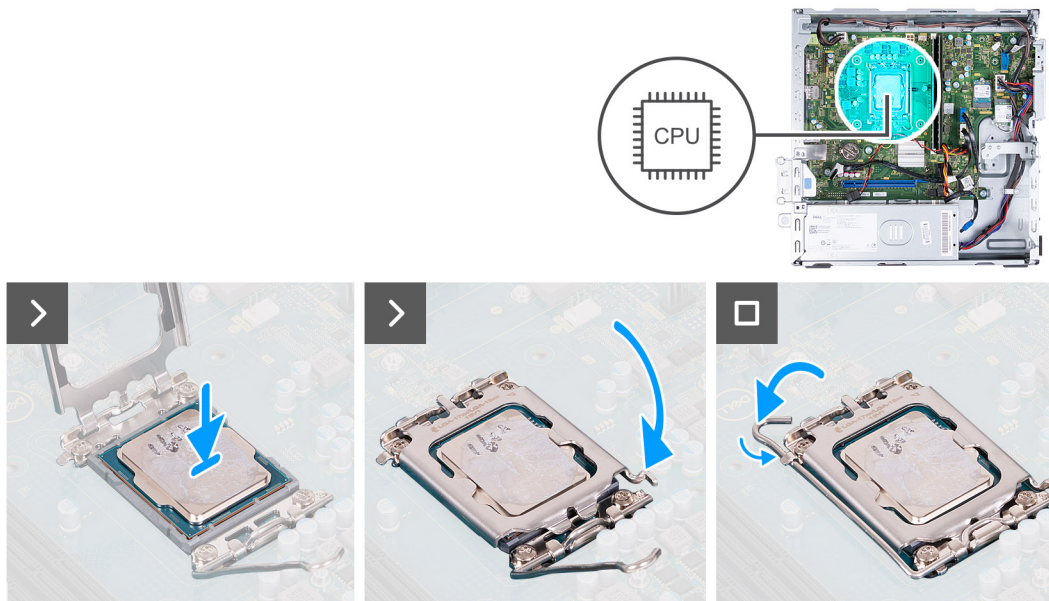

Figure 51. Installing the processor

Steps

1. Extend the release lever and the processor cover completely in an open position.
 - NOTE:** The side of the fan with the word 'REAR' written must face the rear of the chassis.
 - NOTE:** The stubs on the fan shroud must align to the corresponding stub holes on the processor fan.
2. Align the notches on the processor with the tabs on the processor socket.
3. Place the processor in the processor socket.
4. Close the processor cover.
5. Pivot the release lever down and place it under the tab on the processor socket.

Next steps

1. Install the [processor fan and heat-sink assembly](#).
2. Install the [fan shroud](#).
3. Install the [left-side cover](#).
4. Follow the procedure in [After working inside your computer](#).

System board

Removing the system board

CAUTION: The information in this section is intended for authorized service technicians only.

Prerequisites

1. Follow the procedure in [Before working inside your computer](#).
2. Remove the [left-side cover](#).
3. Remove the [front cover](#).
4. Remove the [3.5-inch hard drive](#).
5. Remove the [hard-drive and optical-drive cage](#).
6. Remove the [memory](#).
7. Remove the [M.2 2230 solid-state drive](#) or the [M.2 2280 solid-state drive](#), whichever is applicable.

8. Remove the [wireless card](#).
9. Remove the [coin-cell battery](#).
10. Remove the [media-card reader](#), if applicable.
11. Remove the [fan shroud](#).
12. Remove the [processor fan and heat-sink assembly](#).
13. Remove the [processor](#).

About this task

- NOTE:** The Service Tag information of your computer is stored in the system board. You must enter the Service Tag in the BIOS setup program after you replace the system board.
- NOTE:** Replacing the system board removes any changes that you have made to the BIOS using the BIOS setup program. You must make the appropriate changes again after you replace the system board.
- NOTE:** Before disconnecting the cables from the system board, take a note of the connector locations to reconnect the cables correctly.

The following image indicates the location of the connectors and slots of the system board.

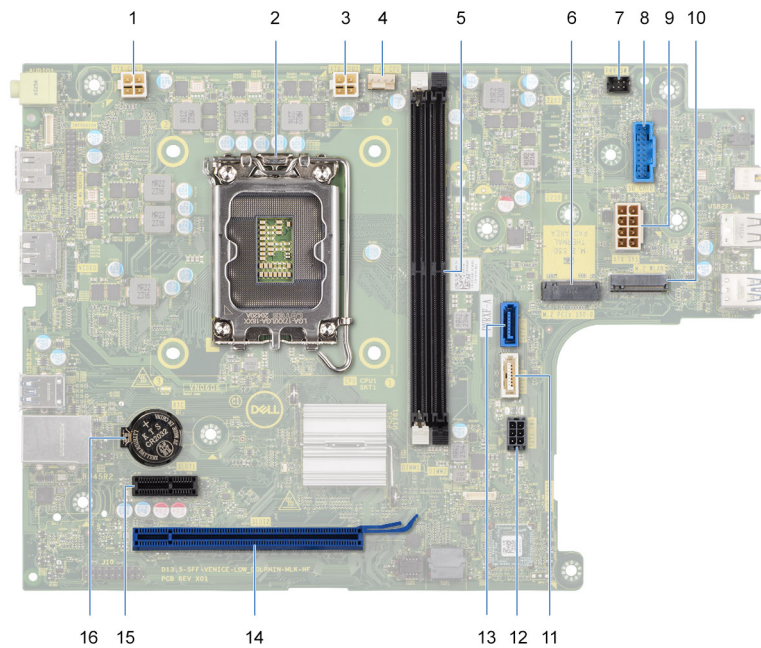

Figure 52. System-board connectors

1. Processor-power cable connector (ATX CPU1)
2. Processor socket
3. Processor-power cable connector (ATX CPU2)
4. Processor-fan cable connector
5. Memory module slots
6. M.2 2230/2280 solid-state drive slot
7. Power-button cable connector
8. Media-card reader cable connector
9. System-board power cable connector (ATX SYS)
10. M.2 wireless-card slot
11. Optical-drive data cable connector (SATA-3)
12. Hard-drive and optical-drive power cable connector (SATA PWR)
13. Hard-drive data cable connector (SATA-0, boot drive)

- 14. PCIe x16 slot (SLOT2)
- 15. PCIe x1 slot (SLOT1)
- 16. Coin-cell battery socket

The following images indicate the location of the system board and provide a visual representation of the removal procedure.

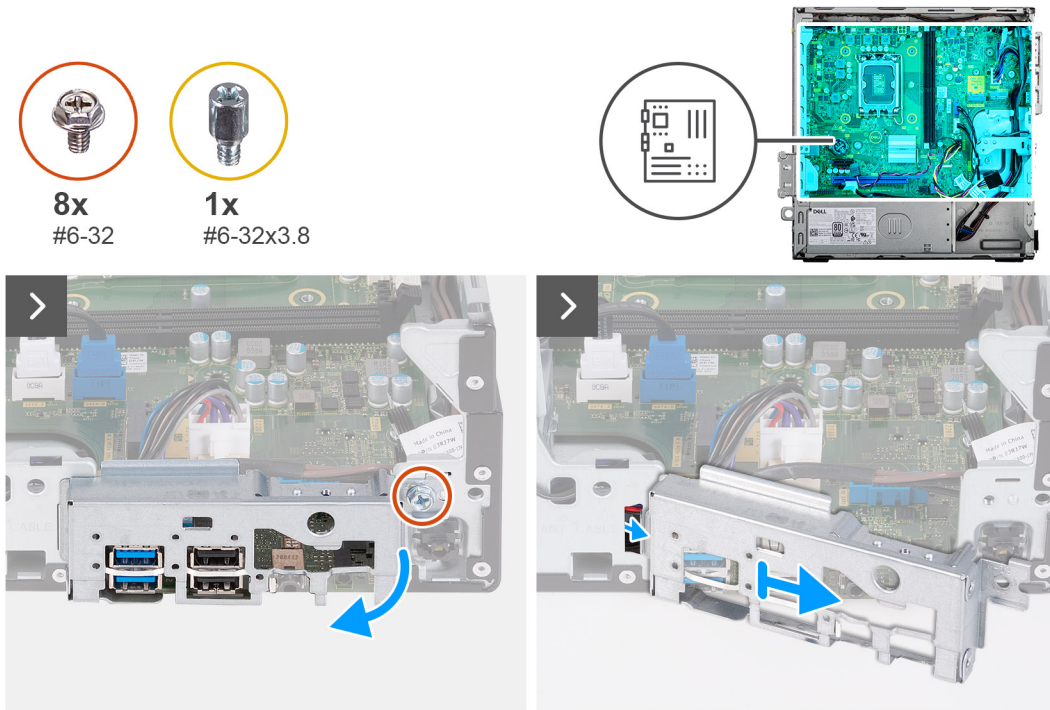

Figure 53. Removing the I/O bracket

Steps

1. Remove the screw (#6-32) that secures the front I/O bracket to the chassis.
2. Lift and remove the front I/O bracket off the chassis.

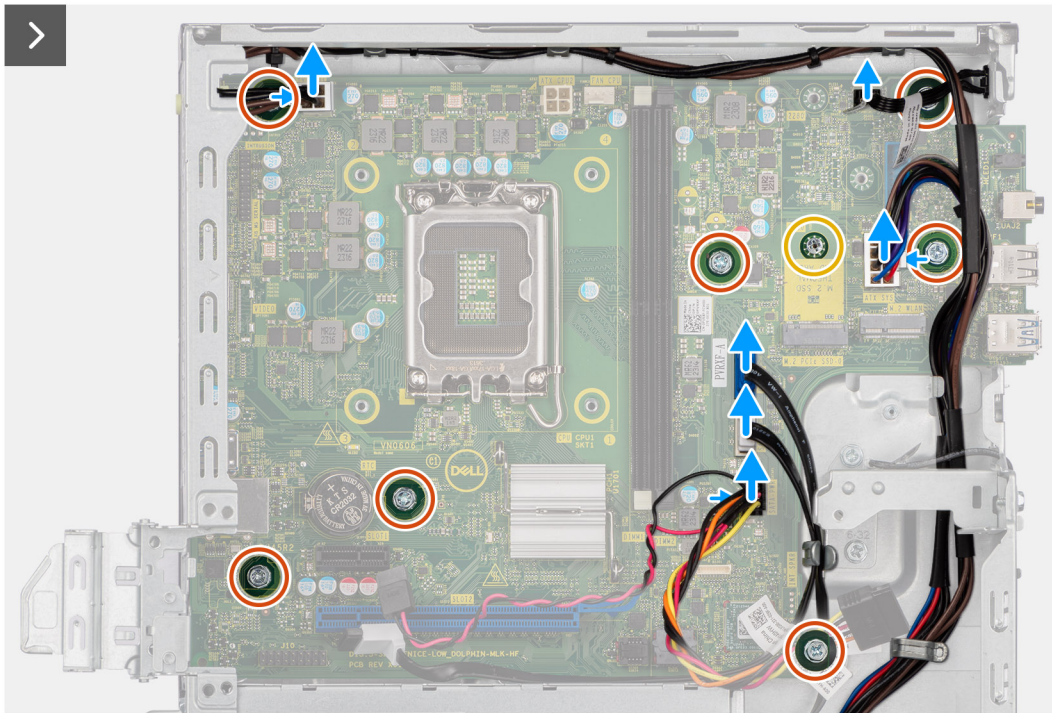

Figure 54. Disconnecting the cables and removing the screws

3. Disconnect the following cables from the system board.
 - hard-drive and optical-drive power cable
 - optical-drive data cable
 - hard-drive data cable
 - system-board power cable
 - power-button cable
 - power-button cable
 - processor-power cable
4. Remove the seven screws (#6-32) and the screw (#6-32x3.8) that secure the system board to the chassis.

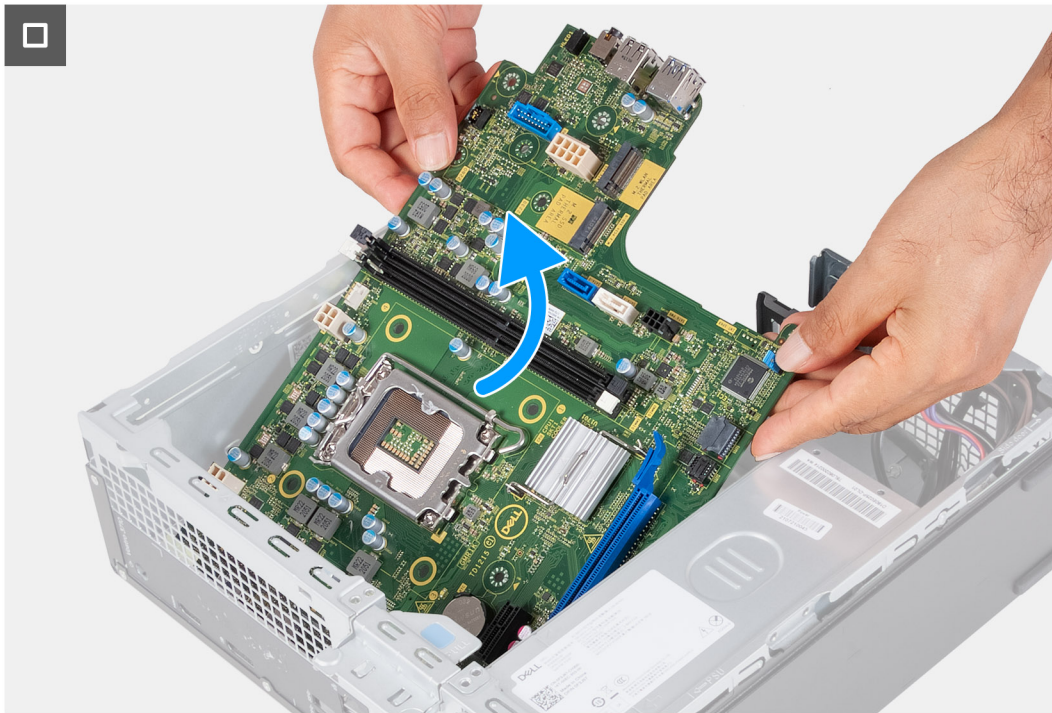

Figure 55. Lifting the system board off the chassis

5. Lift the system board at an angle and remove it from the chassis.

Installing the system board

CAUTION: The information in this section is intended for authorized service technicians only.

Prerequisites

If you are replacing a component, remove the existing component before performing the installation process.

About this task

- NOTE:** The Service Tag information of your computer is stored in the system board. You must enter the Service Tag in the BIOS setup program after you replace the system board.
- NOTE:** Replacing the system board removes any changes that you have made to the BIOS using the BIOS setup program. You must make the appropriate changes again after you replace the system board.
- NOTE:** Before disconnecting the cables from the system board, take a note of the connector locations to reconnect the cables correctly.

The following image indicates the location of the connectors and slots of the system board.

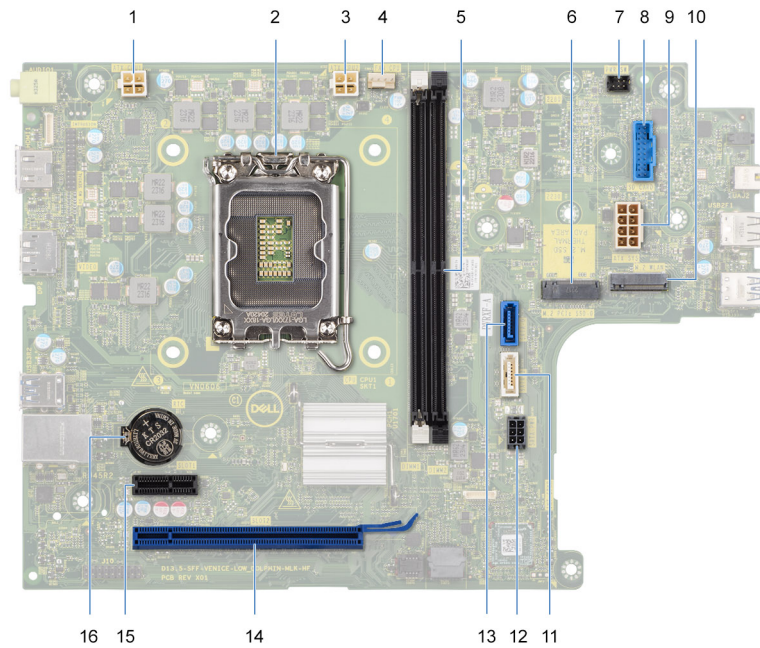

Figure 56. System-board connectors

1. Processor-power cable connector (ATX CPU1)
2. Processor socket
3. Processor-power cable connector (ATX CPU2)
4. Processor-fan cable connector
5. Memory module slots
6. M.2 2230/2280 solid-state drive slot
7. Power-button cable connector
8. Media-card reader cable connector
9. System-board power cable connector (ATX SYS)
10. M.2 wireless-card slot
11. Optical-drive data cable connector (SATA-3)
12. Hard-drive and optical-drive power cable connector (SATA PWR)
13. Hard-drive data cable connector (SATA-0, boot drive)
14. PCIe x16 slot (SLOT2)
15. PCIe x1 slot (SLOT1)
16. Coin-cell battery socket

The following images indicate the location of the system board and provide a visual representation of the installation procedure.

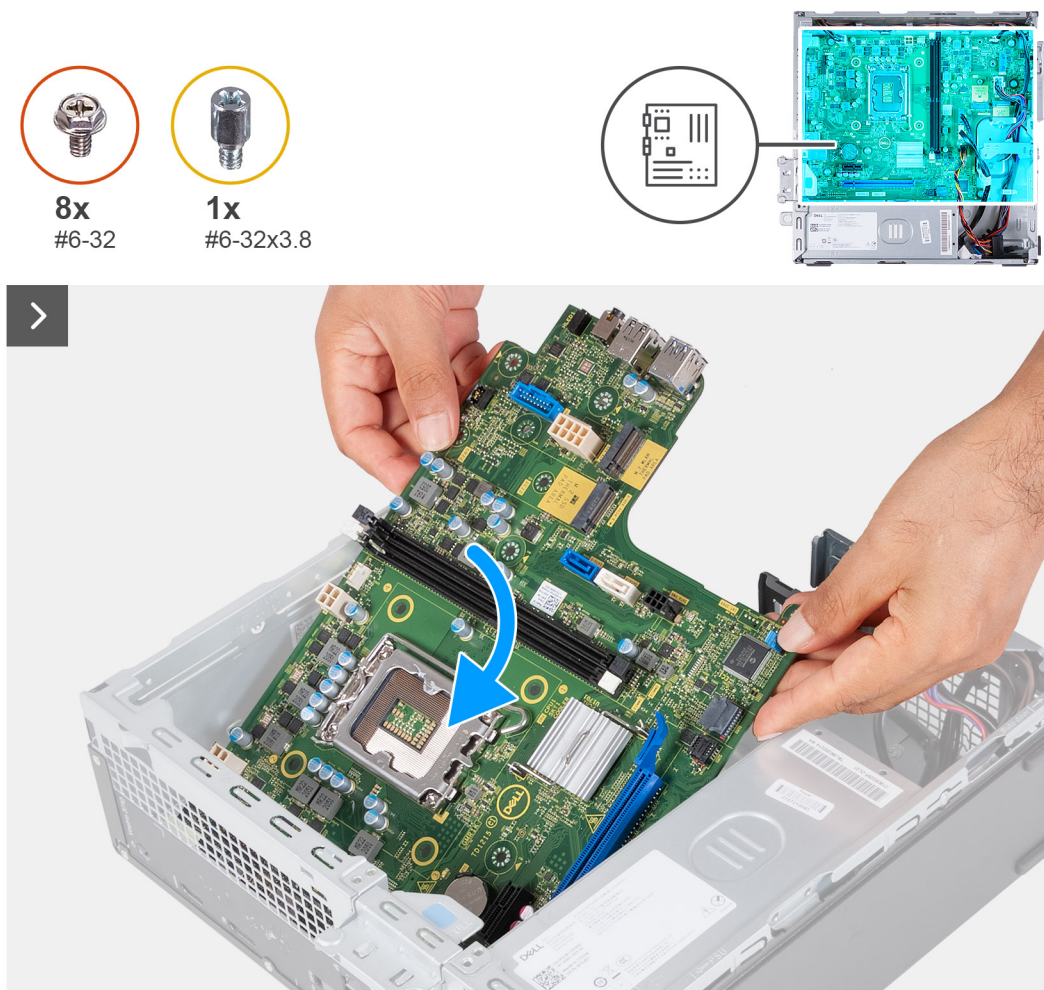

Figure 57. Placing the system board in the chassis

Steps

1. Slide the system board at an angle and align the rear external ports to their respective openings on the chassis.
 - i** **NOTE:** The side of the fan with the word 'REAR' written must face the rear of the chassis.
 - i** **NOTE:** The stubs on the fan shroud must align to the corresponding stub holes on the processor fan.
2. Place the system board onto the chassis.

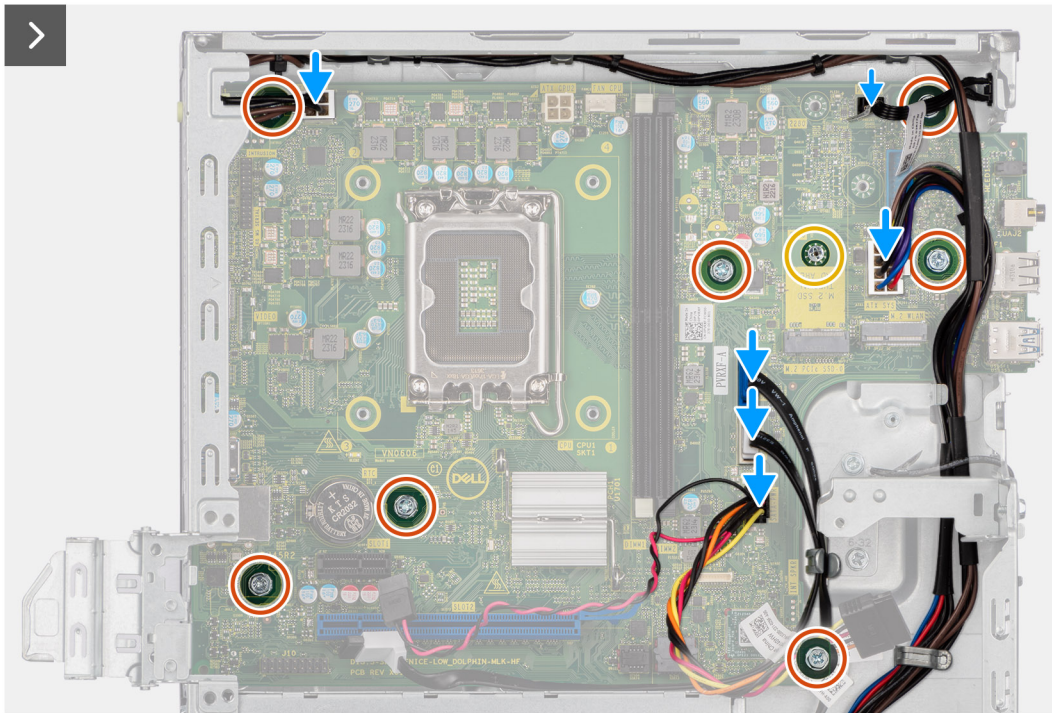

Figure 58. Replacing the screws and connecting the cables

3. Replace the seven screws (#6-32) and the screw (#6-32x3.8) to secure the system board on the chassis.
4. Route and connect the following cables to the system board.
 - hard-drive and optical-drive power cable
 - optical-drive data cable
 - hard-drive data cable
 - system-board power cable
 - power-button cable
 - power-button cable
 - processor-power cable

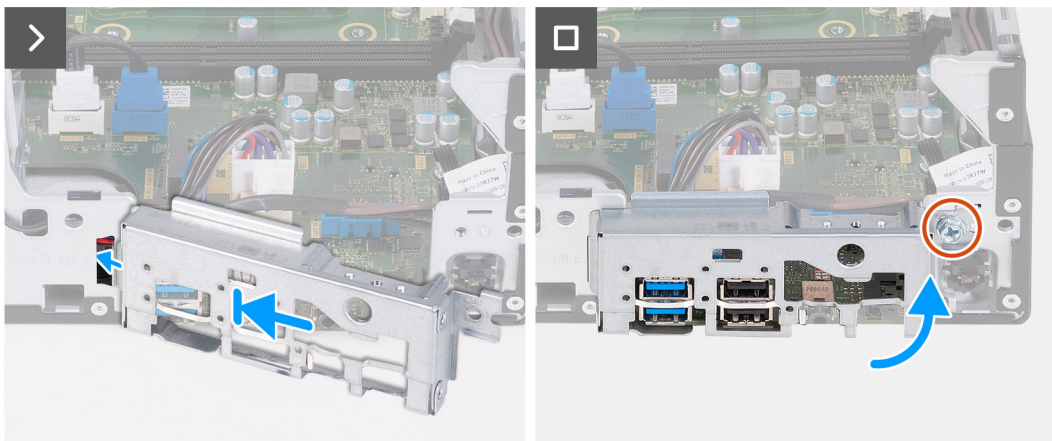

Figure 59. Installing the I/O bracket

5. Align and place the front I/O bracket with I/O slot on the chassis.
6. Replace the screw (#6-32) to secure the front I/O bracket on the chassis.

Next steps

1. Install the [processor](#).

2. Install the [processor fan and heat-sink assembly](#).
3. Install the [fan shroud](#).
4. Install the [media-card reader](#), if applicable.
5. Install the [coin-cell battery](#).
6. Install the [wireless card](#).
7. Install the [M.2 2230 solid-state drive](#) or the [M.2 2280 solid-state drive](#), as applicable.
8. Install the [memory](#).
9. Install the [hard-drive and optical-drive cage](#).
10. Install the [3.5-inch hard drive](#).
11. Install the [front cover](#).
12. Install the [left-side cover](#).
13. Follow the procedure in [After working inside your computer](#).

Software

This chapter details the supported operating systems along with instructions on how to install the drivers.

Operating system

Your Vostro 3030 Small Desktop supports the following operating systems:

- Windows 11 Home
- Windows 11 Pro
- Windows 11 Home National Education
- Windows 11 Pro National Education
- Ubuntu Linux 22.04 LTS, 64-bit

Drivers and downloads

When troubleshooting, downloading, or installing drivers, it is recommended that you read the Dell Knowledge Base article [Drivers and Downloads FAQs 000123347](#).

BIOS Setup

CAUTION: Unless you are an expert computer user, do not change the settings in the BIOS Setup. Certain changes can make your computer work incorrectly.

NOTE: Depending on the computer and the installed devices, the options that are listed in this section may or may not be displayed.

NOTE: Before you change the settings in BIOS Setup, it is recommended that you note down the original settings for future reference.

Use BIOS Setup for the following purposes:

- Get information about the hardware installed in your computer, such as the amount of RAM and the size of the storage device.
- Change the system configuration information.
- Set or change a user-selectable option, such as the user password, type of hard drive installed, and enable or disable base devices.

Entering BIOS Setup program

About this task

Turn on (or restart) your computer and press F2 immediately.

Navigation keys

NOTE: For most of the BIOS Setup options, changes that you make are recorded but do not take effect until you restart the computer.

Table 24. Navigation keys

Keys	Navigation
Up arrow	Moves to the previous field.
Down arrow	Moves to the next field.
Enter	Selects a value in the selected field (if applicable) or follows the link in the field.
Spacebar	Expands or collapses a drop-down list, if applicable.
Tab	Moves to the next focus area.
Esc	Moves to the previous page until you view the main screen. Pressing Esc in the main screen displays a message that prompts you to save any unsaved changes and restart the computer.

One time boot menu

To access the **one time boot menu**, turn on your computer, and then press F2 immediately.

NOTE: If your computer fails to enter the boot menu, restart the computer and press F2 immediately.

The one-time boot menu displays the devices that you can boot from, and also displays the option to start diagnostics. The boot menu options are:

- Removable Drive (if available)
- STXXXX Drive (if available)
- **i** **NOTE:** XXX denotes the SATA drive number.
- Optical Drive (if available)
- SATA Hard Drive (if available)
- Diagnostics
- **i** **NOTE:** Choosing **Diagnostics**, will display the **ePSA diagnostics** screen.

The **one time boot menu** also displays the option to access the System Setup screen.

F12 One Time Boot menu

To enter the One Time Boot menu, turn on your computer, and then press F12 immediately.

i **NOTE:** If you are unable to enter the One Time Boot menu, repeat the above action.

The One Time Boot menu displays the devices that you can boot from and also display the options to start diagnostics. The boot menu options are:

- Removable Drive (if available)
- STXXXX Drive (if available)
- **i** **NOTE:** XXX denotes the SATA drive number.
- Optical Drive (if available)
- SATA Hard Drive (if available)
- Diagnostics

The One Time Boot menu screen also displays the option to access BIOS Setup.

System setup options

i **NOTE:** Depending on your computer and its installed devices, the items that are listed in this section may or may not be displayed.

Table 25. System setup options—Overview menu

Overview	
Vostro 3030 Small Desktop System Information	
BIOS Version	Displays the BIOS version number.
Service Tag	Displays the Service Tag of the computer.
Asset Tag	Displays the Asset Tag of the computer.
Manufacture Date	Displays the manufacture date of the computer.
Ownership Date	Displays the ownership date of the computer.
Express Service Code	Displays the Express Service Code of the computer.
Ownership Tag	Displays the Ownership Tag of the computer.
Signed Firmware Update	Displays whether the Signed Firmware Update is enabled on your computer. By default, the Signed Firmware Update option is enabled.
Processor Information	
Processor Type	Displays the processor type.

Table 25. System setup options—Overview menu (continued)

Overview	
Maximum Clock Speed	Displays the maximum processor clock speed.
Minimum Clock Speed	Displays the minimum processor clock speed.
Current Clock Speed	Displays the current processor clock speed.
Core Count	Displays the number of cores on the processor.
Processor ID	Displays the processor identification code.
Processor L2 Cache	Displays the processor L2 Cache size.
Processor L3 Cache	Displays the processor L3 Cache size.
Microcode Version	Displays the microcode version.
Intel Hyper-Threading Capable	Displays whether the processor is Hyper-Threading (HT) capable.
64-Bit Technology	Displays whether 64-bit technology is used.
Memory Information	
Memory Installed	Displays the total computer memory installed.
Memory Available	Displays the total computer memory available.
Memory Speed	Displays the memory speed.
Memory Channel Mode	Displays single or dual channel mode.
Memory Technology	Displays the technology that is used for the memory.
Devices Information	
Panel Type	Displays the Panel Type of the computer.
Video Controller	Displays the video controller type of the computer.
Video Memory	Displays the video memory information of the computer.
Wi-Fi Device	Displays the wireless device information of the computer.
Native Resolution	Displays the native resolution of the computer.
Video BIOS Version	Displays the video BIOS version of the computer.
Audio Controller	Displays the audio controller information of the computer.
Bluetooth Device	Displays the Bluetooth device information of the computer.
Pass Through MAC Address	Displays the MAC address of the video pass-through.

Table 26. System setup options—Boot Configuration menu

Boot Configuration	
Boot Sequence	
Boot Mode: UEFI only	Displays the boot mode of the computer.
Boot Sequence	Displays the boot sequence.
Secure Digital (SD) Card Boot	<p>Specifies the order that the BIOS searches the list of devices to find an operating system to boot.</p> <p>By default, UEFI Hard Drive 2 is selected.</p> <p>By default, Windows Boot Manager is selected.</p> <p>By default, UEFI Hard Drive is selected.</p> <p>By default, ONBOARD NIC (IPV4) is selected.</p> <p>By default, ONBOARD NIC (IPV6) is selected.</p>

Table 26. System setup options—Boot Configuration menu (continued)

Boot Configuration	
	By default, UEFI HTTPS Boost is selected.
Secure Boot	Secure Boot is a method of guaranteeing the integrity of the boot path by performing additional validation of the operating system and PCI add-in cards. The computer stops booting to the operating system when a component is not authenticated during the boot process. Secure Boot can be enabled in BIOS setup or using management interfaces like Dell Command Configure, but can only be disabled from BIOS setup.
Enable Secure Boot	<p>Enables the computer to boot using only validated boot software.</p> <p>By default, the Enable Secure Boot option is disabled.</p> <p>For additional security, Dell Technologies recommends keeping the Secure Boot option enabled to ensure that the UEFI firmware validates the operating system during the boot process.</p> <p>i NOTE: For Secure Boot to be enabled, the computer is required to be in UEFI boot mode.</p>
Enable Microsoft UEFI CA	<p>When disabled, the UEFI CA is removed from the BIOS UEFI Secure Boot database.</p> <p>i NOTE: When disabled, the Microsoft UEFI CA could render your computer unable to boot, computer graphics may not function, some devices may not function properly, and the computer could become unrecoverable.</p> <p>By default, the Enable Microsoft UEFI CA option is enabled.</p> <p>For additional security, Dell Technologies recommends keeping the Microsoft UEFI CA option enabled to ensure the broadest compatibility with devices and operating systems.</p>
Secure Boot Mode	<p>Enables or disables the Secure Boot operation mode.</p> <p>By default, the Deployed Mode is selected.</p> <p>i NOTE: Deployed Mode should be selected for normal operation of Secure Boot.</p>
Expert Key Management	
Enable Custom Mode	<p>Enables or disables the keys in the PK, KEK, db, and dbx security key databases to be modified.</p> <p>By default, the Enable Custom Mode option is disabled.</p>
Custom Mode Key Management	<p>Selects the custom values for expert key management.</p> <p>By default, the PK option is selected.</p>

Table 27. System setup options—Integrated Devices menu

Integrated Devices	
Date/Time	
Date	Sets the computer date in MM/DD/YYYY format. Changes to the date format take effect immediately.
Time	Sets the computer time in HH/MM/SS 24-hour format. You can switch between a 12-hour and 24-hour clock. Changes to the time format take effect immediately.
Audio	
Enable Microphone	<p>Enables the microphone.</p> <p>By default, the Enable Microphone option is enabled.</p>

Table 27. System setup options—Integrated Devices menu (continued)



Integrated Devices	
	<p> NOTE: Depending on the configuration ordered, the microphone setup option may not be available.</p>
USB Configuration	
Enable USB Boot Support	<p>Enables booting from USB mass storage devices that are connected to external USB ports.</p> <p>By default Front USB Ports is selected.</p> <p>By default, Enable Rear USB Ports is selected.</p> <p>By default, Enable USB Boot Support is selected.</p>
Front USB Configuration	<p>Enables or disables individual USB ports.</p> <p>If a USB port is enabled, devices attached to this port and enabled for the OS.</p> <p>If the USB port is disabled, the OS can't see any devices attached to this port.</p> <p>By default, Front Port 1 (Bottom Left)* is selected.</p> <p>By default, Front Port 2 (Bottom Right)* is selected.</p> <p>By default, Front Port 3 (Top Left) is selected.</p> <p>By default, Front Port 4 (Top Right) is selected.</p> <p>* Denotes a USB 3.0-capable port</p> <p> NOTE: USB keyboard and mouse always work in the BIOS setup irrespective of this setting.</p>
Rear USB Configuration	<p>Enables or disables individual USB ports.</p> <p>If a USB port is enabled, devices attached to this port and enabled for the OS.</p> <p>If the USB port is disabled, the OS can't see any devices attached to this port.</p> <p>By default, Front Port 1 (Bottom Left) is selected.</p> <p>By default, Front Port 2 (Bottom Right) is selected.</p> <p>By default, Front Port 3 (Top Left)* is selected.</p> <p>By default, Front Port 4 (Top Right)* is selected.</p> <p>* Denotes a USB 3.0-capable port</p> <p> NOTE: USB keyboard and mouse always work in the BIOS setup irrespective of this setting.</p>

Table 28. System setup options—Storage menu

Storage	
SATA/NVMe Operation	
SATA/NVMe Operation	<p>Sets the operating mode of the integrated SATA hard drive controller.</p> <p>By default, the RAID On option is selected. The storage device is configured to support RAID functions with VMD Controller.</p>
Storage Interface	
Port Enablement	<p>Enables or disables the on board drives.</p> <p>By default, SATA-0 is selected.</p> <p>By default, SATA-3 is selected.</p> <p>By default, M.2 PCIe SSD-0 is selected.</p>

Table 28. System setup options—Storage menu (continued)

Storage	
Drive Information	Displays the information of onboard drives.
Enable MediaCard	
Secure Digital (SD) Card	Enables or disables the SD card. By default, the Secure Digital (SD) Card option is enabled.
Secure Digital (SD) Card Read-Only Mode	Enables or disables the SD card read-only mode. By default, the Secure Digital (SD) Card Read-Only Mode option is disabled.

Table 29. System setup options—Display menu

Display	
Primary Display	
Primary Display	Set or change the primary video controller when multiple controllers are available in the system. By default, Auto is selected.  NOTE: When Auto is not selected, the on board graphics will be present and enabled.
Full Screen Logo	Enables or disables the computer to display a full-screen logo, if the image matches screen resolution. By default, the Full Screen Logo option is disabled.

Table 30. System setup options—Connection menu

Connection	
Network Controller Configuration	
Integrated NIC	Controls the onboard LAN controller. By default, PXE is selected.
Wireless Device Enable	
WLAN	Enables or disables the internal WLAN device. By default, the WLAN option is selected.
Bluetooth	Enables or disables the internal Bluetooth device. By default, the Bluetooth option is selected.
Enable UEFI Network Stack	Enables or disables the UEFI Network Stack and controls the onboard LAN Controller. By default, the Auto Enabled option is selected.
HTTP(s) Boot Feature	
HTTP(s) Boot	Enables or disables HTTP(s) Boot Feature. By default, this option is enabled.
HTTP(s) Boot Modes	Configure the HTTP(s) Boot Mode. Auto Mode will extract Boot URL from the Dynamic Host Configuration Protocol (DHCP). Manual mode reads user-provided Boot URL. By default, Auto Mode option is selected.

Table 31. System setup options—Power menu

Power	
Thermal Management	<p>Enables or disables cooling of fan and manages processor heat to adjust the computer performance, noise, and temperature.</p> <p>By default, the Optimized option is selected. Standard setting for balanced performance, noise, and temperature.</p>
USB Wake Support	
Wake on Dell USB-C Dock	<p>When enabled, connecting a Dell USB-C Dock wakes the computer from Standby, Hibernate, and Power Off.</p> <p>By default, this option is enabled.</p>
AC Behavior	
AC Recovery	<p>Configures the system response when power is restored after an unexpected loss of power.</p> <p>By default, the Power OFF option is selected. System stays off after AC power is restored.</p>
Active State Power Management	
ASPM	<p>Configures the Active State Power Management (ASPM) level.</p> <p>Auto: There is handshaking between the device and PCI Express hub to determine the best ASPM mode supported by the device.</p> <p>Disabled: ASPM power management is turned off at all times.</p> <p>L1 only: ASPM power management is set to use L1.</p> <p>By default, the Auto option is selected.</p>
Block Sleep	<p>Enables or disables the computer from entering Sleep (S3) mode in the operating system.</p> <p>By default, the Block Sleep option is disabled.</p> <p>i NOTE: When enabled, the computer does not go to Sleep, Intel Rapid Start is disabled automatically, and the operating system power option is blank if it was set to Sleep.</p>
Deep Sleep Control	
Deep Sleep Control	<p>Configures how aggressive the system is at conserving power while in Shutdown (S5) or Hibernate (S4) mode.</p> <p>When this option is enabled, more power is conserved</p> <p>i NOTE: Deep Sleep Control must be disabled in order for the "Wake from USB keyboard and mouse" feature to work in the Shutdown (S5) or in Hibernation Mode (S4).</p> <p>By default, the Enabled in S4 and S5 option is selected.</p>
Intel Speed Shift Technology	<p>Enables or disables the Intel Speed Shift Technology support. When enabled, the operating system selects the appropriate processor performance automatically.</p> <p>By default, the Intel Speed Shift Technology option is enabled.</p>

Table 32. System setup options—Security menu

Security	
TPM 2.0 Security	
TPM 2.0 Security on	<p>The Trusted Platform Module (TPM) provides various cryptographic services which serve as the cornerstone for many platform security technologies. Trusted Platform Module (TPM) is a security device that stores computer-generated</p>

Table 32. System setup options—Security menu (continued)

Security	
	<p>keys for encryption and features such as BitLocker, Virtual Secure Mode, remote Attestation.</p> <p>By default, the Trusted Platform Module (TPM) option is enabled.</p> <p>For additional security, Dell Technologies recommends keeping Trusted Platform Module (TPM) enabled to allow these security technologies to fully function.</p> <p>NOTE: The options that are listed apply to computers with a discrete Trusted Platform Module (TPM) chip.</p>
Attestation Enable	<p>The Attestation Enable option controls the endorsement hierarchy of TPM. Disabling the Attestation Enable option prevents TPM from being used to digitally sign certificates.</p> <p>By default, the Attestation Enable option is enabled.</p> <p>For additional security, Dell Technologies recommends keeping the Attestation Enable option enabled.</p> <p>NOTE: When disabled, this feature may cause compatibility issues or loss of functionality in some operating systems.</p>
Key Storage Enable	<p>The Key Storage Enable option controls the storage hierarchy of TPM, which is used to store digital keys. Disabling the Key Storage Enable option restricts the ability of TPM to store owner's data.</p> <p>By default, the Key Storage Enable option is enabled.</p> <p>For additional security, Dell Technologies recommends keeping the Key Storage Enable option enabled.</p> <p>NOTE: When disabled, this feature may cause compatibility issues or loss of functionality in some operating systems.</p>
SHA-256	<p>Allows you to control the hashing algorithm that is used by the TPM. When enabled, the TPM uses the SHA-256 hashing algorithm. When disabled, the TPM uses the SHA-1 hash algorithm.</p> <p>By default, the SHA-256 option is enabled.</p> <p>For additional security, Dell Technologies recommends keeping the SHA-256 option enabled.</p>
Clear	<p>When enabled, the Clear option clears information that is stored in the TPM after exiting the computer's BIOS. This option returns to the disabled state when the computer restarts.</p> <p>By default, the Clear option is disabled.</p> <p>Dell Technologies recommends enabling the Clear option only when TPM data is required to be cleared.</p>
Physical Presence Interface (PPI) Bypass for Clear Commands	<p>The PPI Bypass for Clear Commands option allows the operating system to manage certain aspects of PTT. When enabled, you are not prompted to confirm changes to the PTT configuration.</p> <p>By default, the PPI Bypass for Clear Commands option is disabled.</p> <p>For additional security, Dell Technologies recommends keeping the PPI Bypass for Clear Commands option disabled.</p>
SMM Security Mitigation	<p>Enables or disables additional UEFI SMM Security Mitigation protections. This option uses the Windows SMM Security Mitigations Table (WSMT) to confirm to the operating system that security best practices have been implemented by the UEFI firmware.</p> <p>By default, the SMM Security Mitigation option is enabled.</p>

Table 32. System setup options—Security menu (continued)



Security	
	<p>For additional security, Dell Technologies recommends keeping the SMM Security Mitigation option enabled unless you have a specific application which is not compatible.</p> <p> NOTE: This feature may cause compatibility issues or loss of functionality with some legacy tools and applications.</p>
Data Wipe on Next Boot	
Start Data Wipe	<p>Data Wipe is a secure wipe operation that deletes information from a storage device.</p> <p> CAUTION: The secure Data Wipe operation deletes information in a way that it cannot be reconstructed.</p> <p>Commands such as delete and format in the operating system may remove files from showing up in the file system. However, they can be reconstructed through forensic means as they are still represented on the physical media. Data Wipe prevents this reconstruction and is not recoverable.</p> <p>When enabled, the data wipe option will prompt to wipe any storage devices that are connected to the computer on the next boot.</p> <p>By default, the Start Data Wipe option is disabled.</p>
Absolute	<p>Absolute Software provides various cyber security solutions, some requiring software preloaded on Dell computers and integrated into the BIOS. To use these features, you must enable the Absolute BIOS setting and contact Absolute for configuration and activation.</p> <p>By default, the Enable Absolute option is enabled.</p> <p>For additional security, Dell Technologies recommends keeping the Absolute option selected.</p> <p> NOTE: When the Absolute features are activated, the Absolute integration cannot be disabled from the BIOS setup screen.</p>
UEFI Boot Path Security	<p>Enables or disables the computer to prompt the user to enter the Administrator password (if set) when booting to a UEFI boot path device from the F12 boot menu.</p> <p>By default, the Always Except Internal HDD option is selected.</p>

Table 33. System setup options—Passwords menu

Passwords	
Administrator Password	<p>The Administrator Password prevents unauthorized access to the BIOS Setup options. Once the administrator password is set, the BIOS setup options can only be modified after providing the correct password.</p> <p>The following rules and dependencies apply to the Administrator Password -</p> <ul style="list-style-type: none"> • The administrator password cannot be set if computer and/or internal hard drive passwords are previously set. • The administrator password can be used in place of the computer and/or internal hard drive passwords. • When set, the administrator password must be provided during a firmware update. • Clearing the administrator password also clears the computer password (if set). <p>Dell Technologies recommends using an administrator password to prevent unauthorized changes to BIOS setup options.</p>
System Password	<p>The System Password prevents the computer from booting to an operating system without entering the correct password.</p>

Table 33. System setup options—Passwords menu (continued)

<p>Passwords</p>	<p>The following rules and dependencies apply when the System Password is used -</p> <ul style="list-style-type: none"> • The computer shuts down when idle for approximately 10 minutes at the computer password prompt. • The computer shuts down after three incorrect attempts to enter the computer password. • The computer shuts down when the Esc key is pressed at the System Password prompt. • The computer password is not prompted when the computer resumes from standby mode. <p>Dell Technologies recommends using the computer password in situations where it is likely that a computer may be lost or stolen.</p>
<p>M.2 PCIe SSD-0</p>	<p>The M.2 PCIe SSD-0 password can be set to prevent unauthorized access of the data stored on the hard drive. The computer prompts for the SSD password during boot in order to unlock the drive. A password-secured SSD stays locked even when removed from the computer or placed into another computer. It prevents an attacker from accessing data on the drive without authorization.</p> <p>The following rules and dependencies apply when the M.2 PCIe SSD-0 Password is used -</p> <ul style="list-style-type: none"> • The SSD password option cannot be accessed when a hard drive is disabled in the BIOS setup. • The computer shuts down when idle for approximately 10 minutes at the SSD password prompt. • The computer shuts down after three incorrect attempts to enter the SSD password and treats the SSD as not available. • The SSD does not accept password unlock attempts after five incorrect attempts to enter the hard drive password from the BIOS Setup. The SSD password must be reset for the new password unlock attempts. • The computer treats the hard drive as not available when the Esc key is pressed at the SSD password prompt. • The SSD password is not prompted when the computer resumes from standby mode. When the SSD is unlocked by the user before the computer goes into standby mode, it remains unlocked after the computer resumes from standby mode. • If the computer and SSD passwords are set to the same value, the SSD unlocks after the correct computer password is entered. <p>Dell Technologies recommends using a SSD password to protect unauthorized data access.</p>
<p>Password Configuration</p>	<p>The Password configuration page includes several options for changing the requirements of BIOS passwords. You can modify the minimum and maximum length of the passwords and require passwords to contain certain character classes (upper case, lower case, digit, special character).</p> <p>Dell Technologies recommends setting the minimum password length to at least eight characters.</p>
<p>Password Bypass</p>	<p>The Password Bypass option allows the computer to reboot from the operating system without entering the computer or hard drive password. If the computer has already booted to the operating system, it is presumed that the user has already entered the correct computer or hard drive password.</p> <p>NOTE: This option does not remove the requirement to enter the password after shutting down.</p> <p>By default, the Disabled option is selected.</p> <p>For additional security, Dell Technologies recommends keeping the Password Bypass option enabled.</p>

Table 33. System setup options—Passwords menu (continued)

Passwords	
Password Changes	
Allow Non-Admin Password Changes	<p>The Allow Non-Admin Password Changes option in BIOS setup allows an end user to set or change the computer or hard drive passwords without entering the administrator password. This gives an administrator control over the BIOS settings but enables an end user to provide their own password.</p> <p>By default, the option is enabled.</p> <p>For additional security, Dell Technologies recommends keeping the Allow Non-Admin Password Changes option disabled.</p>
Admin Setup Lockout	<p>The Admin Setup Lockout option prevents an end user from even viewing the BIOS setup configuration without first entering the administrator password (if set).</p> <p>By default, the Admin Setup Lockout option is disabled.</p> <p>For additional security, Dell Technologies recommends keeping the Admin Setup Lockout option disabled.</p>
Master Password Lockout	
Enable Master Password Lockout	<p>The Master Password Lockout setting allows you to disable the Recovery Password feature. If the computer, administrator, or hard drive password is forgotten, the computer becomes unusable.</p> <p>NOTE: When the owner password is set, the Master Password Lockout option is not available.</p> <p>NOTE: When an internal hard drive password is set, it must first be cleared before Master Password Lockout can be changed.</p> <p>By default, the Enable Master Password Lockout option is disabled.</p>
Master Password Lockout	<p>Enables or disables master password support. Hard disk passwords need to be cleared before the setting can be changed.</p> <p>By default, this option is disabled.</p> <p>Dell does not recommend enabling the Master Password Lockout unless you have implemented your own password recovery computer.</p>
Allow Non-Admin PSID Revert	<p>This option controls access to the Physical Security ID (PSID) revert of NVMe storage drives from the Dell Security Manager prompt.</p> <p>When disabled: If a BIOS Admin password is set, PSID revert is protected by the BIOS Admin password and the user will be prompted to enter the BIOS Admin password before performing the revert.</p> <p>When enabled: PSID revert is allowed to proceed without providing the BIOS admin password.</p> <p>By default, the option is disabled.</p>

Table 34. System setup options—Update, Recovery menu

Update, Recovery	
UEFI Capsule Firmware Updates	
Enable UEFI Capsule Firmware Updates	<p>Enables or disables BIOS updates through UEFI capsule update packages.</p> <p>NOTE: Disabling this option blocks the BIOS updates from services such as Microsoft Windows Update and Linux Vendor Firmware Service (LVFS).</p> <p>By default, the Enable UEFI Capsule Firmware Updates option is enabled.</p>
BIOS Recovery from Hard Drive	<p>Enables or disables the user to recover from certain corrupted BIOS conditions from a recovery file on the user primary hard drive or an external USB key.</p>

Table 34. System setup options—Update, Recovery menu (continued)

Update, Recovery	
	<p>By default, the BIOS Recovery from Hard Drive option is enabled.</p> <p>i NOTE: BIOS Recovery from Hard Drive is not available for self-encrypting drives (SED).</p> <p>i NOTE: BIOS recovery is designed to fix the main BIOS block and cannot work if the Boot Block is damaged. In addition, this feature cannot work in the event of EC corruption, ME corruption, or a hardware issue. The recovery image must exist on an unencrypted partition on the drive.</p>
BIOS Downgrade	
Allow BIOS Downgrade	<p>Controls flashing of the computer firmware to previous revisions.</p> <p>By default, the Allow BIOS Downgrade option is enabled.</p>
SupportAssist OS Recovery	<p>Enables or disables the boot flow for SupportAssist OS Recovery tool in the event of certain computer errors.</p> <p>By default, the SupportAssist OS Recovery option is enabled.</p>
Dell Auto OS Recovery Threshold	<p>Allows you to control the automatic boot flow for SupportAssist System Resolution Console and for Dell operating system Recovery Tool.</p> <p>By default, the Dell Auto OS Recovery Threshold value is set to 2.</p>

Table 35. System setup options—System Management menu

System Management	
Service Tag	Displays the Service Tag of the computer.
Asset Tag	<p>Creates a computer Asset Tag that can be used by an IT administrator to uniquely identify a particular computer.</p> <p>i NOTE: Once set in BIOS, the Asset Tag cannot be changed.</p>
Wake on LAN	<p>Enables or disables the computer to turn on by a special LAN signal.</p> <p>By default, the Wake on LAN option is disabled.</p>
Auto On Time	<p>Enable to set the computer to turn on automatically every day or on a preselected date and time. This option can be configured only if the Auto On Time is set to Everyday, Weekdays, or Selected Days.</p> <p>By default, the Auto On Time option is disabled.</p>
SERR Messages	
Enables SERR Messages	<p>This option controls the SERR message mechanism.</p> <p>By default, this option is enabled.</p>
First Power on Date	
Set Ownership Date	<p>This option lets you set the ownership date of your computer.</p> <p>By default, this option is enabled.</p>
Diagnostics	
OS agent Requests	<p>This option enables or disables Dell OS Agent(s) to schedule onboard diagnostics.</p> <p>By default, this option is enabled.</p>
Power-on-Self-Test Automatic Recovery	
Power-on-Self-Test Automatic Recovery	This option enables or disables the BIOS to attempt an automatic recovery of the computer- such as reverting BIOS Setup configuration settings to BIOS.

Table 35. System setup options—System Management menu (continued)

System Management	
	By default, this option is enabled.

Table 36. System setup options—Keyboard menu

Keyboard	
Keyboard Errors	
Enable Keyboard Error Detection	Enables or disables report of keyboard-related errors when the computer boots. By default, this option is enabled.
Numlock LED	
Enable Numlock LED	Enables or disables Numlock when the computer boots. By default, this option is enabled.

Table 37. System setup options—Preboot Behavior menu

Preboot Behavior	
Warnings and Errors	Enables or disables the action to be taken when a warning or error is encountered. By default, the Prompt on Warnings and Errors option is selected. Stop, prompt, and wait for user input when warnings or errors are detected. i NOTE: Errors deemed critical to the operation of the computer hardware stop the functioning of the computer.
Extend BIOS POST Time	Sets the BIOS POST (Power-On Self-Test) load time. By default, the 0 seconds option is selected.

Table 38. System setup options—Virtualization menu

Virtualization Support	
Intel Virtualization Technology	
Enable Intel Virtualization Technology (VT)	When enabled, the computer can run a Virtual Machine Monitor (VMM). By default, the Enable Intel Virtualization Technology (VT) option is enabled.
VT for Direct I/O	
Enable Intel VT for Direct I/O	When enabled, the computer can perform Virtualization Technology for Direct I/O (VT-d). VT-d is an Intel method that provides virtualization for memory map I/O. By default, the Enable Intel VT for Direct I/O option is enabled.
DMA Protection	
Enable Pre-Boot DMA Support	Allows you to control the Pre-Boot DMA protection for both internal and external ports. This option does not directly enable DMA protection in the operating system. i NOTE: This option is not available when the virtualization setting for IOMMU is disabled (VT-d/AMD Vi). By default, the Enable Pre-Boot DMA Support option is enabled. For additional security, Dell Technologies recommends keeping the Enable Pre-Boot DMA Support option enabled. i NOTE: This option is provided only for compatibility purposes, since some older hardware is not DMA capable.

Table 38. System setup options—Virtualization menu (continued)

Virtualization Support	
Enable OS Kernel DMA Support	<p>Allows you to control the Kernel DMA protection for both internal and external ports. This option does not directly enable DMA protection in the operating system. For operating systems that support DMA protection, this setting indicates to the operating system that the BIOS supports the feature.</p> <p>i NOTE: This option is not available when the virtualization setting for IOMMU is disabled (VT-d/AMD Vi).</p> <p>By default, the Enable OS Kernel DMA Support option is enabled.</p> <p>i NOTE: This option is provided only for compatibility purposes, since some older hardware is not DMA capable.</p>

Table 39. System setup options—Performance menu

Performance	
Multi-Core Support	
Multiple Atom Cores	<p>Enables to change the number of Atom cores available to the operating system. The default value is set to the maximum number of cores.</p> <p>By default, the All Cores option is selected.</p>
Intel SpeedStep	
Enable Intel SpeedStep Technology	<p>Enables the computer to dynamically adjust processor voltage and core frequency, decreasing average power consumption and heat production.</p> <p>By default, the Enable Intel SpeedStep Technology option is enabled.</p>
C-State Control	
Enable C-State Control	<p>Enables or disables the ability of the CPU to enter and exit low-power state. When disabled, it disables all C-states. When enabled, it enables all C-states that the chipset or platform allows.</p> <p>By default, the Enable C-State Control option is enabled.</p>
Intel Turbo Boost Technology	
Enable Intel Turbo Boost Technology	<p>Enables the Intel TurboBoost mode of the processor. When enabled, the Intel TurboBoost driver increases the performance of the CPU or graphics processor.</p> <p>By default, the Enable Intel Turbo Boost Technology option is enabled.</p>
Intel Hyper-Threading Technology	
Enable Intel Hyper-Threading Technology	<p>Enables the Intel Hyper-Threading mode of the processor. When enabled, the Intel Hyper-Threading increases the efficiency of the processor resources when multiple threads run on each core.</p> <p>By default, the Intel Hyper-Threading Technology option is enabled.</p>
PCIe Resizable Base Address Register (BAR)	<p>Enables or disables PCIe Resizable Base Address Register (BAR) support.</p> <p>By default, the option is disabled.</p>

Table 40. System setup options—System Logs menu

System Logs	
BIOS Event Log	
Clear BIOS Event Log	<p>Allows you to select option to keep or clear BIOS events logs.</p> <p>By default, the Keep Log option is selected.</p>

Updating the BIOS

Updating the BIOS in Windows

About this task

 **CAUTION:** If BitLocker is not suspended before updating the BIOS, the next time you reboot the computer it will not recognize the BitLocker key. You will then be prompted to enter the recovery key to progress, and the computer will ask for this on each reboot. If the recovery key is not known this can result in data loss or an unnecessary operating system reinstall. For more information about this subject, search in the Knowledge Base Resource at [Dell Support Site](#).

Steps

1. Go to [Dell Support Site](#).
2. Click **Product support**. In the **Search support** box, enter the Service Tag of your computer, and then click **Search**.
 **NOTE:** If you do not have the Service Tag, use the SupportAssist to automatically identify your computer. You can also use the product ID or manually browse for your computer model.
3. Click **Drivers & Downloads**. Expand **Find drivers**.
4. Select the operating system installed on your computer.
5. In the **Category** drop-down list, select **BIOS**.
6. Select the latest version of BIOS, and click **Download** to download the BIOS file for your computer.
7. After the download is complete, browse the folder where you saved the BIOS update file.
8. Double-click the BIOS update file icon and follow the on-screen instructions.
For more information, search in the Knowledge Base Resource at [Dell Support Site](#).

Updating the BIOS in Linux and Ubuntu

To update the system BIOS on a computer that is installed with Linux or Ubuntu, see the knowledge base article [000131486](#) at [Dell Support Site](#).

Updating the BIOS using the USB drive in Windows

About this task

 **CAUTION:** If BitLocker is not suspended before updating the BIOS, the next time you reboot the computer it will not recognize the BitLocker key. You will then be prompted to enter the recovery key to progress, and the computer will ask for this on each reboot. If the recovery key is not known this can result in data loss or an unnecessary operating system reinstall. For more information about this subject, search in the Knowledge Base Resource at [Dell Support Site](#).

Steps

1. Follow the procedure from step 1 to step 6 in [Updating the BIOS in Windows](#) to download the latest BIOS setup program file.
2. Create a bootable USB drive. For more information, search in the Knowledge Base Resource at [Dell Support Site](#).
3. Copy the BIOS setup program file to the bootable USB drive.
4. Connect the bootable USB drive to the computer that needs the BIOS update.
5. Restart the computer and press **F12**.
6. Select the USB drive from the **One Time Boot Menu**.
7. Type the BIOS setup program filename and press **Enter**.
The **BIOS Update Utility** appears.
8. Follow the on-screen instructions to complete the BIOS update.

Updating the BIOS from the One-Time boot menu

Update your computer BIOS using the BIOS XXXX.exe file that is copied to a FAT32 USB drive and booting from the One-Time boot menu.

About this task

CAUTION: If BitLocker is not suspended before updating the BIOS, the next time you reboot the computer it will not recognize the BitLocker key. You will then be prompted to enter the recovery key to progress, and the computer will ask for this on each reboot. If the recovery key is not known this can result in data loss or an unnecessary operating system reinstall. For more information about this subject, search in the Knowledge Base Resource at [Dell Support Site](#).

BIOS Update

You can run the BIOS flash update file from Windows using a bootable USB drive or you can also update the BIOS from the One-Time boot menu on the computer.

You can confirm by booting your computer to the **One Time Boot** Menu to see if BIOS FLASH UPDATE is listed as a boot option . If the option is listed, then the BIOS can be updated using this method..

Updating from the One-Time boot menu

To update your BIOS from the One-Time boot menu, you need the following:

- USB drive formatted to the FAT32 file system (the drive does not have to be bootable)
- BIOS executable file that you downloaded from the Dell Support website and copied to the root of the USB drive
- AC power adapter must be connected to the computer
- Functional computer battery to flash the BIOS

Perform the following steps to perform the BIOS flash update process from the One-Time boot menu:

CAUTION: Do not turn off the computer during the BIOS flash update process. The computer may not boot if you turn off your computer.

Steps

1. Turn off your computer, insert the USB drive where you copied the BIOS flash update file into a USB port of the computer.
2. Turn on the computer and press to access the **One Time Boot** Menu. Select BIOS Update using the mouse or arrow keys then press Enter.
The flash BIOS menu is displayed.
3. Click **Flash from file**.
4. Select the external USB device.
5. Select the file and double-click the flash target file, and then click **Submit**.
6. Click **Update BIOS**. The computer restarts to flash the BIOS.
7. The computer will restart after the BIOS flash update is completed.

System and setup password

Table 41. System and setup password

Password type	Description
System password	Password that you must enter to log in to your system.
Setup password	Password that you must enter to access and make changes to the BIOS settings of your computer.

You can create a system password and a setup password to secure your computer.

CAUTION: The password features provide a basic level of security for the data on your computer.

CAUTION: Anyone can access the data that is stored on your computer, when left unattended.

 **NOTE:** System and setup password feature is disabled.

Assigning a System Setup password

Prerequisites

You can assign a new System or Admin Password only when the status is in **Not Set**.

About this task

To enter BIOS System Setup, press F2 immediately after a power-on or reboot.

Steps

1. In the **System BIOS** or **System Setup** screen, select **Security** and press Enter.
The **Security** screen is displayed.
2. Select **System/Admin Password** and create a password in the **Enter the new password** field.
Use the following guidelines to assign the system password:
 - A password can have up to 32 characters.
 - At least one special character: "(! " # \$ % & ' * + , - . / : ; < = > ? @ [\] ^ _ ` { | })"
 - Numbers 0 to 9.
 - Upper case letters from A to Z.
 - Lower case letters from a to z.
3. **Confirm new password** type the system password that you entered earlier in the field and click **OK**.
4. Press Esc and save the changes as prompted by the message.
5. Press Y to save the changes.
The computer restarts.

Deleting or changing an existing system password or setup password

Prerequisites

Ensure that the **Password Status** is Unlocked (in the System Setup) before attempting to delete or change the existing system password and/or setup password. You cannot delete or change an existing system password or setup password if the **Password Status** is Locked.

About this task

To enter the System Setup, press F2 immediately after a power-on or reboot.

Steps

1. In the **System BIOS** or **System Setup** screen, select **System Security** and press Enter.
The **System Security** screen is displayed.
2. In the **System Security** screen, verify that the **Password Status** is Unlocked.
3. Select **System Password**. Update or delete the existing system password, and press Enter or Tab.
4. Select **Setup Password**. Update or delete the existing setup password, and press Enter or Tab.
 **NOTE:** If you change the system password and/or setup password, reenter the new password when prompted. If you delete the system password and/or setup password, confirm the deletion when prompted.
5. Press Esc. A message prompts you to save the changes.
6. Press Y to save the changes and exit from **System Setup**.
The computer restarts.

Clearing CMOS settings

About this task

 **CAUTION:** Clearing CMOS settings will reset the BIOS settings on your computer.

Steps

1. Remove the [left-side cover](#).
2. Disconnect the battery cable from the system board.
3. Remove the [coin-cell battery](#).
4. Wait for one minute.
5. Replace the [coin-cell battery](#).
6. Connect the battery cable to the system board.
7. Replace the [left-side cover](#).

Clearing BIOS (System Setup) and System passwords

About this task

To clear the computer or BIOS passwords, contact Dell technical support as described at [Contact Support](#). For more information, go to [Dell Support Site](#).

 **NOTE:** For information about how to reset Windows or application passwords, see the documentation accompanying Windows or your application.

Troubleshooting

Dell SupportAssist Pre-boot System Performance Check diagnostics

About this task

SupportAssist diagnostics (also known as system diagnostics) performs a complete check of your hardware. The Dell SupportAssist Pre-boot System Performance Check diagnostics is embedded with the BIOS and launched by the BIOS internally. The embedded system diagnostics provides options for particular devices or device groups allowing you to:

- Run tests automatically or in an interactive mode.
- Repeat the tests.
- Display or save test results.
- Run thorough tests to introduce additional test options to provide extra information about one or more failed devices.
- View status messages that inform you the tests are completed successfully.
- View error messages that inform you of problems encountered during testing.

 **NOTE:** Some tests for specific devices require user interaction. Always ensure that you are present at the computer when the diagnostic tests are performed.

For more information, see the knowledge base article [000180971](#).

Running the SupportAssist Pre-Boot System Performance Check

Steps

1. Turn on your computer.
2. As the computer boots, press the F12 key as the Dell logo appears.
3. On the boot menu screen, select the **Diagnostics** option.
4. Click the arrow at the bottom left corner.
Diagnostics page is displayed.
5. Click the arrow in the lower-right corner to go to the page listing.
The items that are detected are listed.
6. To run a diagnostic test on a specific device, press Esc and click **Yes** to stop the diagnostic test.
7. Select the device from the left pane and click **Run Tests**.
8. If there are any issues, error codes are displayed.
Note the error code and validation number and contact Dell.

Power-Supply Unit Built-in Self-Test

Built-in Self-Test (BIST) helps determine if the power-supply unit is working. To run self-test diagnostics on the power-supply unit of a desktop or all-in-one computer, search in the Knowledge Base Resource at [Dell Support Site](#).

System-diagnostic lights

This section lists the system-diagnostic lights of your Vostro 3030 Small Desktop.

Table 42. System-diagnostic lights

Blinking pattern		Problem description
Amber	White	
1	1	TPM detection failure
1	2	Unrecoverable SPI Flash Failure
1	5	EC unable to program i-Fuse
1	6	Generic catch-all for ungraceful EC code flow errors
2	1	CPU failure
2	2	System board failure (included BIOS corruption or ROM error)
2	3	No memory/RAM detected
2	4	Memory/RAM failure
2	5	Invalid memory installed
2	6	System board/Chipset Error
3	1	CMOS battery failure
3	2	PCI or Video card/chip failure
3	3	BIOS Recovery image not found
3	4	BIOS Recovery image found but invalid
3	5	Power rail failure
3	6	Flash corruption is detected by SBIOS.
3	7	Timeout waiting on ME to reply to HECI message.
4	1	Memory DIMM power rail failure
		CPU power cable connection issue

NOTE: Blinking pattern 3-3-3 on Lock LED (Caps-Lock or Num-Lock), Power button LED (without Fingerprint reader), and Diagnostic LED indicates failure to provide input during LCD panel test on the "Dell SupportAssist Pre-boot System Performance Check" diagnostics.

Recovering the operating system

When your computer is unable to boot to the operating system even after repeated attempts, it automatically starts Dell SupportAssist OS Recovery.

Dell SupportAssist OS Recovery is a stand-alone tool that is preinstalled in Dell computers running Windows operating system. It consists of tools to diagnose and troubleshoot issues that may occur before your computer boots to the operating system. It enables you to diagnose hardware issues, repair your computer, back up your files, or restore your computer to its factory state.

You can also download it from the Dell Support website to troubleshoot and fix your computer when it fails to boot into the primary operating system due to software or hardware failures.

For more information about the Dell SupportAssist OS Recovery, see *Dell SupportAssist OS Recovery User's Guide at Serviceability Tools at the Dell Support Site*. Click **SupportAssist** and then, click **SupportAssist OS Recovery**.

Real Time Clock—RTC reset

The Real Time Clock (RTC) reset function allows you or the service technician to recover the recently launched model Dell Latitude and Precision systems from **No POST/No Boot/No Power** situations. You can initiate the RTC reset on the system from a power-off state only if it is connected to AC power. Press and hold the power button for 25 seconds. The system RTC reset occurs after you release the power button.

 **NOTE:** If AC power is disconnected from the system during the process or the power button is held longer than 40 seconds, the RTC reset process gets aborted.

The RTC reset will reset the BIOS to Defaults, un-provision Intel vPro and reset the system date and time. The following items are unaffected by the RTC reset:

- Service Tag
- Asset Tag
- Ownership Tag
- Admin Password
- System Password
- HDD Password
- Key Databases
- System Logs

 **NOTE:** The IT administrator's vPro account and password on the system will be un-provisioned. The system needs to go through the setup and configuration process again to reconnect it to the vPro server.

The below items may or may not reset based on your custom BIOS setting selections:

- Boot List
- Enable Legacy Option ROMs
- Secure Boot Enable
- Allow BIOS Downgrade

Backup media and recovery options

It is recommended to create a recovery drive to troubleshoot and fix problems that may occur with Windows. Dell provides multiple options for recovering the Windows operating system on your Dell computer. For more information, see [Dell Windows Backup Media and Recovery Options](#).

Wi-Fi power cycle

About this task

If your computer is unable to access the Internet due to Wi-Fi connectivity issues, reset your Wi-Fi device by performing the following steps:

Steps



1. Turn off the computer.
2. Turn off the modem.
 **NOTE:** Some Internet service providers (ISPs) provide a modem and router combo device.
3. Turn off the wireless router.
4. Wait for 30 seconds.
5. Turn on the wireless router.
6. Turn on the modem.
7. Turn on the computer.

Getting help and contacting Dell

Self-help resources

You can get information and help on Dell products and services using these self-help resources:

Table 43. Self-help resources

Self-help resources	Resource location
Information about Dell products and services	Dell Site
My Dell app	
Tips	
Contact Support	In Windows search, type <code>Contact Support</code> , and press Enter.
Online help for operating system	Windows Support Site Linux Support Site
Access top solutions, diagnostics, drivers and downloads, and learn more about your computer through videos, manuals, and documents.	Your Dell computer is uniquely identified using a Service Tag or Express Service Code. To view relevant support resources for your Dell computer, enter the Service Tag or Express Service Code at Dell Support Site . For more information about how to find the Service Tag for your computer, see Locate the Service Tag on your computer .
Dell knowledge base articles	<ol style="list-style-type: none"> 1. Go to Dell Support Site. 2. On the menu bar at the top of the Support page, select Support > Support Library. 3. In the Search field on the Support Library page, type the keyword, topic, or model number, and then click or tap the search icon to view the related articles.

Contacting Dell

To contact Dell for sales, technical support, or customer service issues, see [Contact Support at Dell Support Site](#).

 **NOTE:** Availability of the services may vary depending on the country or region, and product.

 **NOTE:** If you do not have an active Internet connection, you can find contact information about your purchase invoice, packing slip, bill, or Dell product catalog.