

TH585P

BenQ DLP Projector



Features

- Watch Content & Play Games in Bright Environments with 3500 ANSI Lumens Brightness
- Color Space Coverage of 95% Rec.709 with optimized Color Wheel
- Console Gaming Projector with Full HD 1080p Resolution
- Low Input Lag with 16ms Response Time for Smooth Gameplay
- Exclusive Game Mode for Enhanced Details and Visual Effects
- Immersive 10W Built-in Speaker
- Lamp Life up to 15000 Hours in Lamp Save Mode



Product Specifications

Projection System	DLP
DMD type	0.48"
Native Resolution	1920 x 1080 pixels, 16 : 9
Brightness	3,500 ANSI Lumens
Contrast Ratio*	10,000 : 1
Display Color	30 Bits (1.07 billion colors)
Aspect Ratio	Native 16 : 9 (3 aspect ratios selectable)
Light Source	Lamp
Light Source life**	Normal: 4,000 hours / Economic: 10,000 hours / Smart Eco: 8,000 hours / Lamp save: 15,000 hours
Throw Ratio	1.50 - 1.65 (100" @ 3.32 m)
Zoom Ratio	1.1X
Keystone Correction	1D, Vertical ± 30 degrees
Projection Offset	105%
Digital Lens Shift	Vertical +/- 5%
Projection Size (Clear Focus / Maximum)	60" ~ 200" / 30" ~ 300"
Built-in Speaker	10W x 1
Picture Mode	Bright / Living Room / Cinema / Sports / Game / (3D)* / User 1 / User 2
Color Wheel Segment	6 segment (RGBWYC)
Color Wheel Speed	2X (2D/3D, 50Hz/60Hz), 3D max 144Hz
Security	Security Bar, Kensington lock
Feature	Low Input Lag, Game Picture Mode, 95% Rec.709
Resolution Support	VGA (640 x 480) to WUXGA (1920 x 1200)
Horizontal Frequency	15K-102KHz
Vertical Scan Rate	23-120Hz
HDTV Compatibility	720p 50/60Hz, 1080i 50/60Hz, 1080p 24/25/30/50/60Hz
Power Consumption (Max / Normal / Eco)	340W / 297W / 206W
Standby Power Consumption	0.5W Max. at 100 ~ 240VAC
Power Supply	VAC 100 ~ 240 (50/60Hz)
Product Dimensions (W x H x D)	312 x 110 x 225 mm
Product Weight	2.79 kg
Noise Level (Normal / Eco)	35 / 29 dBA
Operating Temperature	0~40 degrees (Celsius)
Accessories (Standard)	Remote Control - RCV013 w/ AAA Battery x 2 (5JJGY06.001) Power Cord (by region) x 1 Quick Start Guide (21L) (4JJLS01.001) Warranty Card (by region)
Accessories (Optional)	Spare Lamp Kit (5JJHH05.001) 3D Glasses (Supported 3D Modes: Top Bottom, Frame Sequential, Frame Packing, Side by Side)
On Screen Display Language	Arabic / Bulgarian / Croatian / Czech / Danish / Dutch / English / Finnish / French / German / Greek / Hindi / Hungarian / Italian / Indonesian / Japanese / Korean / Norwegian / Persian / Polish / Portuguese / Romanian / Russian / Simplified Chinese / Spanish / Swedish / Turkish / Thai / Traditional Chinese / Vietnamese (30 Languages)

*The contrast is measured by Full On Full Off standard.

**Lamp life results will vary depending on environmental conditions and usage. Actual product's features and specifications are subject to change without notice.

Input and Output Terminals

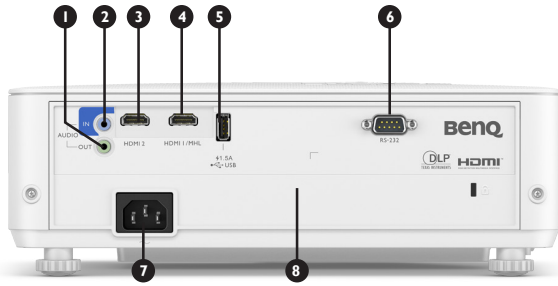

- 1 Audio output (mini jack)
- 2 Audio input (mini jack)
- 3 HDMI-2
- 4 HDMI-1 / MHL
- 5 USB Type A (1.5A power)
- 6 RS232 input (D-sub 9pin, male)
- 7 AC Power cable inlet
- 8 IR Receiver (Front+Rear)

Dimensions

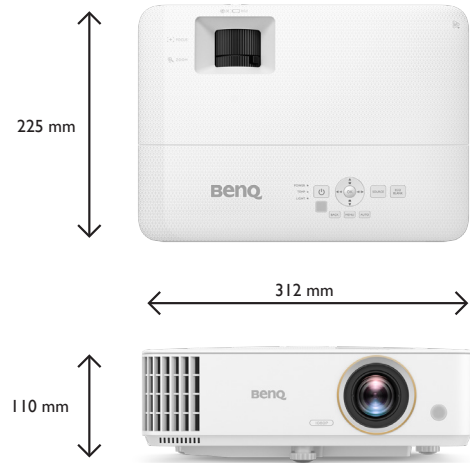

Distance Chart

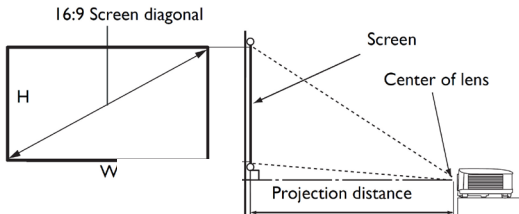

Screen Size				Distance from Screen			Offset (mm)
Diagonal	Height	Width	Min length (max zoom)	Average	Max length (min zoom)		
30	762	374	664	996	1046	1096	19
40	1016	498	886	1328	1395	1461	25
50	1270	623	1107	1660	1743	1826	31
60	1524	747	1328	1992	2092	2192	37
70	1778	872	1550	2324	2441	2557	44
80	2032	996	1771	2657	2789	2922	50
90	2286	1121	1992	2989	3138	3287	56
100	2540	1245	2214	3321	3487	3653	62
110	2794	1370	2435	3653	3835	4018	68
120	3048	1494	2657	3985	4184	4383	75
130	3302	1619	2878	4317	4533	4749	81
140	3556	1743	3099	4649	4881	5114	87
150	3810	1868	3321	4981	5230	5479	93
160	4064	1992	3542	5313	5579	5844	100
170	4318	2117	3763	5645	5927	6210	106
180	4572	2241	3985	5977	6276	6575	112
190	4826	2366	4206	6309	6625	6940	118
200	5080	2491	4428	6641	6973	7306	125
210	5334	2615	4649	6973	7322	7671	131
220	5588	2740	4870	7306	7671	8036	137
230	5842	2864	5092	7638	8019	8401	143
240	6096	2989	5313	7970	8368	8767	149
250	6350	3113	5535	8302	8717	9132	156
260	6604	3238	5756	8634	9066	9497	162
270	6858	3361	5977	8966	9414	9862	168
280	7112	3487	6199	9298	9763	10228	174
290	7366	3611	6420	9630	10112	10593	181
300	7620	3736	6641	9962	10460	10958	187

* The screen aspect ratio and projected picture are in 16:9

Ceiling Mount Chart

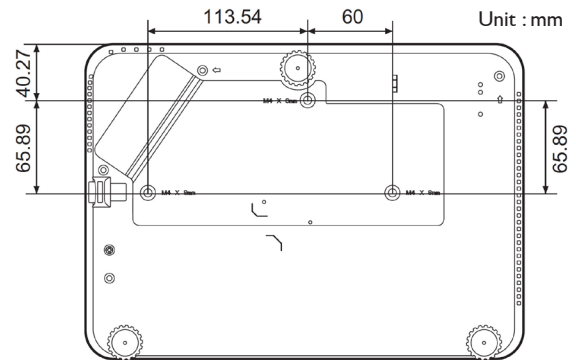

Ceiling/Wall mount screw:
M4 (Max L = 25 mm; Min L = 20 mm)

BenQ Europe B.V.

Meerenakkerweg 1-17
5652 AR Eindhoven
The Netherlands
Tel: +31 88 8889200
Fax: +31 88 8889299

BenQ.eu

© 2022 BenQ Corp. Specifications may vary by region, please visit your local stores for details. Actual product's features and specifications are subject to change without notice. This material may include corporate names and trademarks of third parties which are the properties of the third parties respectively.



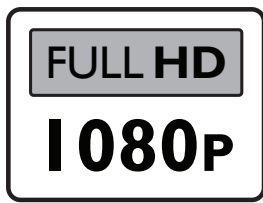

Full HD 1080P Resolution

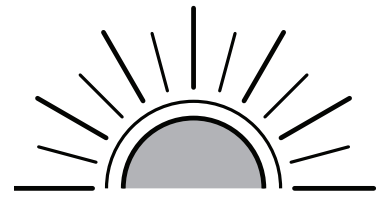

3500 ANSI Lumens



CinematicColor™

95% Rec.709 CinematicColor

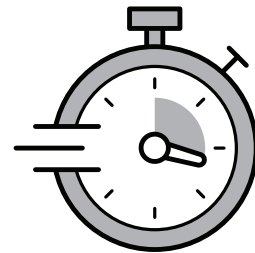

16ms Low Input Lag

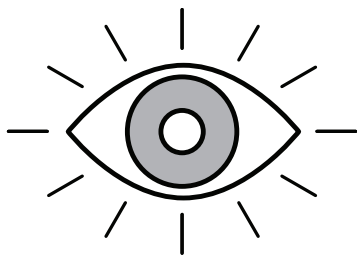

Enhanced Game Mode



15,000 Hours Lamp Life



BenQ Europe B.V.

Meerenakkerweg 1-17
5652 AR Eindhoven
The Netherlands
Tel: +31 88 8889200
Fax: +31 88 8889299

BenQ.eu

© 2022 BenQ Corp. Specifications may vary by region, please visit your local stores for details. Actual product's features and specifications are subject to change without notice. This material may include corporate names and trademarks of third parties which are the properties of the third parties respectively.

BenQ