

PRODUCT DATASHEET

SPOT ADJUST 8 W 4000 K WT

SPOT ADJUST | Recessed mounted spotlight, adjustable, round shape



Areas of application

- Replacement of halogen lamp spotlights
- General illumination
- Hotel rooms
- Bars, restaurants
- Accent lighting
- Galleries, museums
- Residential interiors

Product benefits

- High luminous efficacy
- Design matches the LEDVANCE DOWNLIGHT luminaire family
- Energy savings of up to 90 % compared to halogen lamp spotlights
- Functional and minimalistic design
- Easy and quick installation
- External driver for extended flexibility (compatible with selected DALI drivers)
- 5 years guarantee

Product features

- Initial color consistency: ≤ 4 SDCM
- Housing material: aluminum
- Lens material: PMMA



TECHNICAL DATA

Electrical data

Nominal wattage	8.00 W
Nominal voltage	220...240 V
Mains frequency	50...60 Hz
Nominal current	35 mA
Max. no. of lum. on circuit break. B16 A	31
Max. no. of lum. on circuit break. C10 A	25
Max. no. of lum. on circuit break. C16 A	40
Power factor λ	> 0.90
Total harmonic distortion	< 15 %
Protection class	II
Operating mode	Electronic control gear (ECG)

Photometrical data

Luminous flux	720 lm
Luminous efficacy	90 lm/W
Color temperature	4000 K
Light color (designation)	Cool White
Color rendering index Ra	> 80
Standard deviation of color matching	≤ 4 sdcn
Flickering metric (Pst LM)	-
Stroboscope effect metric (SVM)	-
Photobiological safety group acc. to EN62778	RG0
Photobiological safety group acc. to EN62471	RG0
Beam angle	36 °

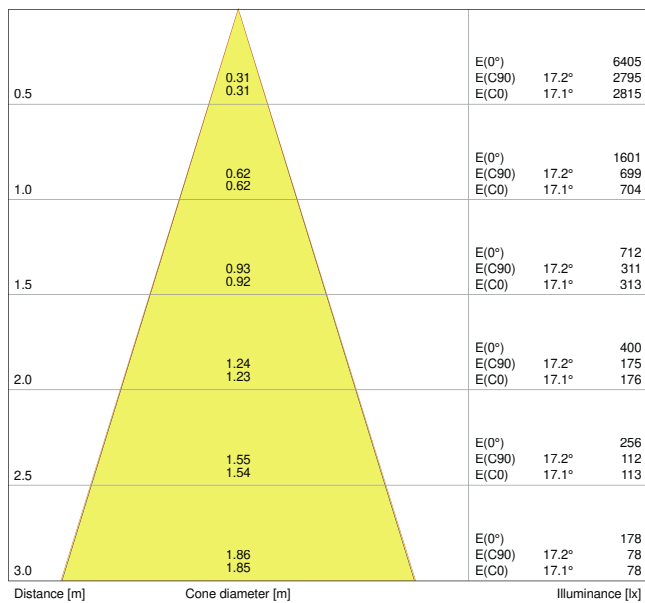

LDC typ cone

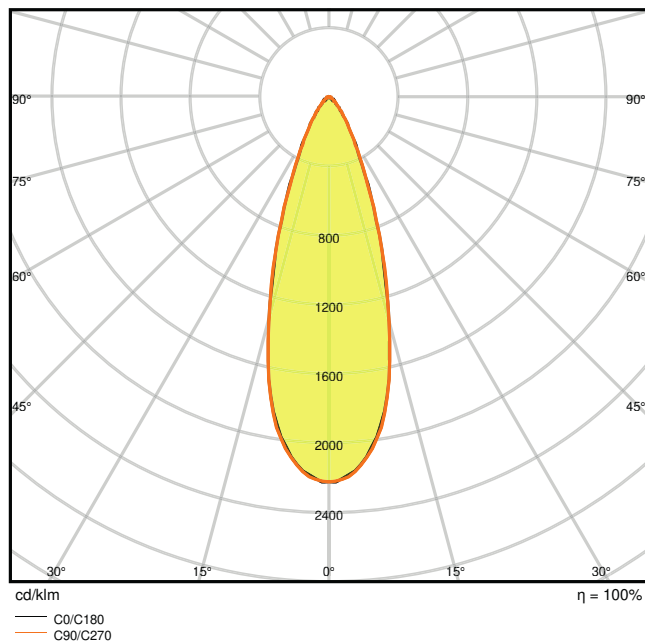

LDC typ polar

Dimensions & Weight

Diameter	90.00 mm
Height	47.00 mm
Product weight	224.00 g

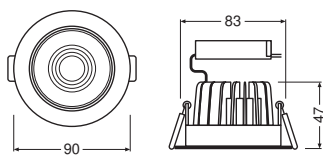

Materials & Colors

Product color	White
Housing color	White
Body material	Aluminum
Light emitting surface material	PMMA

Glow Wire Test according to IEC 60695-2-12	650 °C
Mercury content	0.0 mg

Application & Mounting

Ambient temperature range	-20...+45 °C
Type of connection	Screw terminal, 2-Pole (L,N)
Type of protection	IP20
Protection class IK (shock resistance)	IK06
Dimmable	No
Mounting type	Recessed
Mounting location	Ceiling
Application environment	Indoor
Mounting diameter	83 mm
Mounting depth	90 mm
Adjustable	Yes
LED module replaceable	Not replaceable
With light source	Yes



Lifespan









Lifespan L70/B50 at 25 °C	50000 h
Lifespan L80/B10 at 25 °C	40000 h
Lifespan L90/B10 at 25 °C	20000 h
Number of switching cycles	100000

Certificates & Standards

Standards	CE / CB / TÜV SÜD / EAC / RoHS
Luminaire with limited surface temperature, "D sign"	No
Ball shot safe	No

DOWNLOAD DATA

DOWNLOAD DATA	
	User instruction
	Addon Technical Information

DOWNLOAD DATA	
	Tender documents
	Declarations of conformity
	On-Pack-Info
	IES file (IES)
	LDT file (Eulumdat)
	M3D file (3D Model)
	ULD file (DIALux)
	UGR file (UGR table)

LOGISTICAL DATA

Product code	Packaging unit (Pieces/Unit)	Dimensions (length x width x height)	Gross weight	Volume
4058075126879	Shipping box 20	550 mm x 220 mm x 200 mm	6225.00 g	24.20 dm ³

The mentioned product code describes the smallest quantity unit which can be ordered. One shipping unit can contain one or more single products. When placing an order, for the quantity please enter single or multiples of a shipping unit.

ADDITIONAL CATALOG INFORMATION

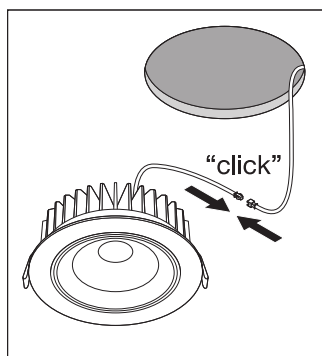
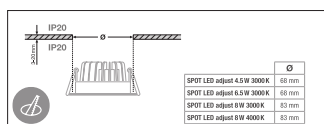

References / Links

- For Guarantee see www.ledvance.com/guarantee

DISCLAIMER

Subject to change without notice. Errors and omission excepted. Always make sure to use the most recent release.