

PRODUCT DATASHEET

DP HOUSING 1500 P 1XLAMP IP65

DAMP PROOF HOUSING GEN 3 | Damp-proof luminaire for T8 LED lamps with tool-free luminaire connector

Areas of application

- Parking lots, warehouses, production areas
- Car parks and underpasses
- Garages



Product benefits

- Easy and quick installation
- Prewired for easy installation of tubular AC LED lamps
- Toolless installation
- Robust housing
- Sustainable solution thanks to exchangeable light sources
- 5 years guarantee

Product features

- Luminaire housing, available for 1 or 2 T8 LED tubes
- Suitable for LED TUBE T8 EM and LED TUBE T8 CONNECTED
- Type of protection: IP65
- Integrated electrical fuse



TECHNICAL DATA

Electrical data

Nominal voltage	220...240 V
Mains frequency	50...60 Hz
Protection class	II

Dimensions & Weight

Length	1585.00 mm
Width	65.00 mm
Height	70.00 mm
Product weight	889.00 g

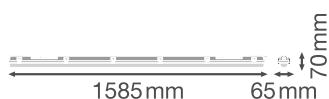

Materials & Colors

Product color	Gray
Housing color	Gray
Body material	Polycarbonate (PC)
Cover material	Polycarbonate (PC)
Light emitting surface material	Polycarbonate (PC)
Glow Wire Test according to IEC 60695-2-12	850 °C
Mercury content	0.0 mg

Application & Mounting

Ambient temperature range	-30...+40 °C
Temperature range at storage	-20...+80 °C
Type of connection	Screwless terminal, 3-Pole (N, E, L)

Type of protection	IP65
Protection class IK (shock resistance)	IK08
Dimmable	No
Mounting type	Surface
Mounting location	Ceiling
Application environment	Indoor
With light source	No
Holder designation	G13

Certificates & Standards

Standards	CE / TÜV Rheinland / EAC / UKCA
Luminaire with limited surface temperature, "D sign"	No
Ball shot safe	No





Additional product data

Product remark	Available from September 2023
----------------	-------------------------------

EQUIPMENT / ACCESSORIES

- All required accessories included
- Through-wiring cable kit available

DOWNLOAD DATA

Documents and certificates	
	User instruction
	Packaging insert
	Declarations Of Conformity CE
	Declarations Of Conformity UKCA
CAD/BIM files	
	CAD_STEP_3D

LOGISTICAL DATA

Product code	Packaging unit (Pieces/Unit)	Dimensions (length x width x height)	Gross weight	Volume
4099854118159	Folding box 1	68 mm x 1,577 mm x 75 mm	1059.00 g	8.04 dm ³
4099854118166	Shipping box 9	1,592 mm x 216 mm x 237 mm	10181.00 g	81.50 dm ³

The mentioned product code describes the smallest quantity unit which can be ordered. One shipping unit can contain one or more single products. When placing an order, for the quantity please enter single or multiples of a shipping unit.

ADDITIONAL CATALOG INFORMATION

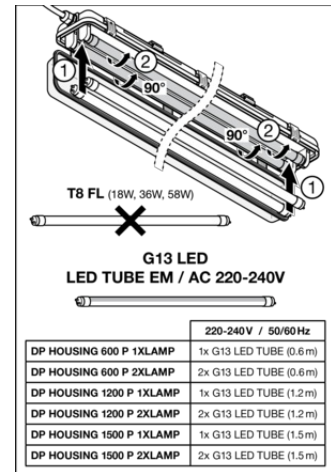
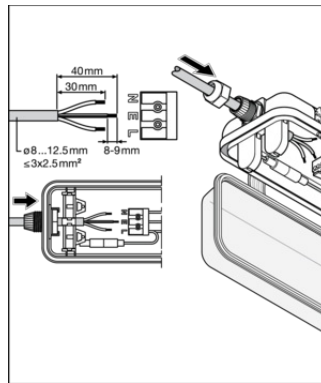
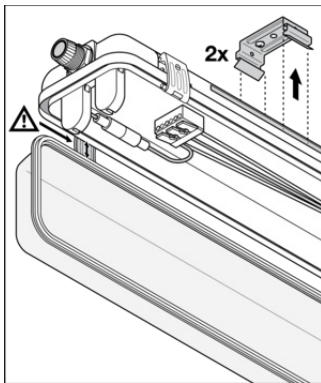

References / Links

- For Guarantee see www.ledvance.com/guarantee

DISCLAIMER

Subject to change without notice. Errors and omission excepted. Always make sure to use the most recent release.