

PRODUCT DATASHEET

DL SLIM DN 155 12 W 4000 K WT

DOWNLIGHT SLIM ROUND | Flat downlights with integrated driver, round shape



Areas of application

- Direct replacement for luminaires with compact fluorescent lamps
- General illumination
- Public areas
- Stairways
- Corridors
- Foyers
- Shops

Product benefits

- Very slim housing
- Low installation depth
- High luminous efficacy
- Energy savings up to 60 % (compared to luminaires that use CFL lamps)
- Very homogenous light
- Functional design
- Easy installation with fast connection
- Simple installation thanks to integrated driver

Product features

- Small visible bezel
- Connector box with push wire terminal for tool-free connection



- Light guide made of non-yellowing PMMA for long lifetime



TECHNICAL DATA

Electrical data

Nominal wattage	12.00 W
Nominal voltage	220...240 V
Mains frequency	50...60 Hz
Nominal current	71.7 mA
Inrush current	15.6 A
Inrush current time T_{h50}	50 μ s
Max. no. of lum. on circuit break. B16 A	48
Max. no. of lum. on circuit break. C10 A	38
Max. no. of lum. on circuit break. C16 A	61
Power factor λ	0.50
Total harmonic distortion	< 20 %
Protection class	II
Operating mode	Integrated LED driver

Photometrical data

Luminous flux	1020 lm
Luminous efficacy	85 lm/W
Color temperature	4000 K
Light color (designation)	Cool White
Color rendering index Ra	> 80
Standard deviation of color matching	< 6 sdc _m
Flickering metric (Pst LM)	-
Stroboscope effect metric (SVM)	-
Photobiological safety group acc. to EN62778	RG0
Photobiological safety group acc. to EN62471	RG0
Beam angle	120 °

0.5	1.32 1.32	E(0°) 1528 E(C90) 52.8° 172 E(C0) 52.9° 168
1.0	2.63 2.64	E(0°) 382 E(C90) 52.8° 43 E(C0) 52.9° 42
1.5	3.95 3.97	E(0°) 170 E(C90) 52.8° 19 E(C0) 52.9° 19
2.0	5.27 5.29	E(0°) 95 E(C90) 52.8° 11 E(C0) 52.9° 11
2.5	6.59 6.61	E(0°) 61 E(C90) 52.8° 7 E(C0) 52.9° 7
3.0	7.90 7.93	E(0°) 42 E(C90) 52.8° 5 E(C0) 52.9° 5

Distance [m] Cone diameter [m] Illuminance [lx]

— C0/C180 (Half beam angle [°]: 105.8°)
— C90/C270 (Half beam angle [°]: 105.6°)

LDC typ cone

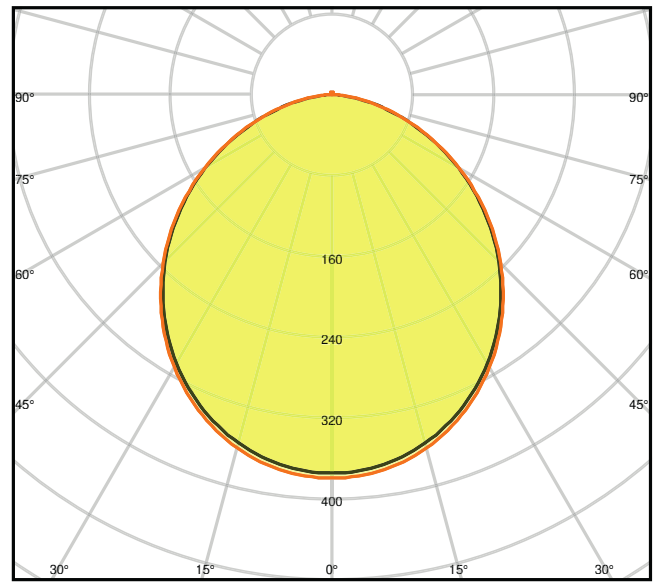

LDC typ polar

Dimensions & Weight

Diameter	169.00 mm
Height	30.00 mm
Product weight	272.00 g

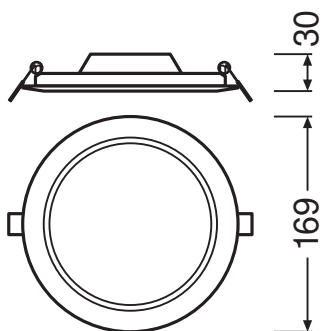

Materials & Colors



Product color	White
Housing color	White
Body material	Polycarbonate (PC)
Cover material	Polycarbonate (PC)
Light emitting surface material	Polycarbonate (PC)
Glow Wire Test according to IEC 60695-2-12	650 °C
Mercury content	0.0 mg

Application & Mounting

Ambient temperature range	-20...+50 °C
Temperature range at storage	-30...+70 °C
Type of connection	Screwless terminal, 2-Pole
Type of protection	IP20
Protection class IK (shock resistance)	IK03
Dimmable	No
Mounting type	Recessed
Mounting location	Ceiling
Application environment	Indoor
Mounting diameter	155,0 mm
Mounting depth	50,0 mm
LED module replaceable	Not replaceable
With light source	Yes

Lifespan

Lifespan L70/B50 at 25 °C	30000 h
Lifespan L80/B10 at 25 °C	20000 h
Lifespan L90/B10 at 25 °C	12000 h
Number of switching cycles	50000

Control gear

Output current	180 mA
ECG - Output ripple current	< 6.5 %

Certificates & Standards











Standards	CE / CB / EAC
Luminaire with limited surface temperature, "D sign"	No
Ball shot safe	No



EQUIPMENT / ACCESSORIES

- Surface mounting frames available as accessories

DOWNLOAD DATA

DOWNLOAD DATA	
	Addon Technical Information
	Tender documents
	Declarations of conformity
	Installation guide
	On-Pack-Info
	IES file (IES)
	LDT file (Eulumdat)
	M3D file (3D Model)
	ULD file (DIALux)
	UGR file (UGR table)

LOGISTICAL DATA

Product code	Packaging unit (Pieces/Unit)	Dimensions (length x width x height)	Gross weight	Volume
4058075079069	Shipping box 6	290 mm x 205 mm x 195 mm	2158.00 g	11.59 dm ³

The mentioned product code describes the smallest quantity unit which can be ordered. One shipping unit can contain one or more single products. When placing an order, for the quantity please enter single or multiples of a shipping unit.

ADDITIONAL CATALOG INFORMATION



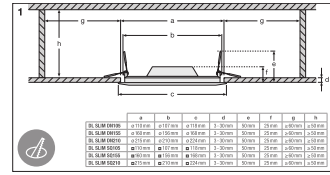
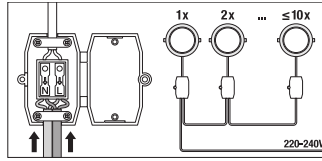
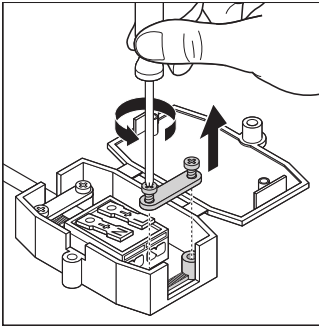

References / Links

- For Guarantee see www.ledvance.com/guarantee

DISCLAIMER

Subject to change without notice. Errors and omission excepted. Always make sure to use the most recent release.

