

PRODUCT DATASHEET

DL SLIM ALU DN 205 22 W 4000 K WT

DOWNLIGHT SLIM ALU | Flat downlights with external driver and aluminum housing



Areas of application

- Direct replacement for luminaires with compact fluorescent lamps
- General illumination
- Public areas
- Stairways
- Corridors
- Foyers
- Shops

Product benefits

- Very slim housing
- Low installation depth
- High luminous efficacy
- Energy savings up to 60 % (compared to luminaires that use CFL lamps)
- Very homogenous light
- Functional design
- External driver for easy replacement
- 5 years guarantee

Product features

- Solid aluminum housing in white
- Small visible bezel



- Light guide made of non-yellowing PMMA for long lifetime

TECHNICAL DATA

Electrical data

Nominal wattage	22.00 W
Nominal voltage	220...240 V
Mains frequency	50...60 Hz
Nominal current	190 mA
Inrush current	11 A
Inrush current time T_{h50}	533 μ s
Max. no. of lum. on circuit break. B16 A	11
Max. no. of lum. on circuit break. C10 A	11
Max. no. of lum. on circuit break. C16 A	18
Power factor λ	> 0.5
Total harmonic distortion	< 20 %
Protection class	II
Operating mode	Electronic control gear (ECG)

Photometrical data

Luminous flux	1920 lm
Luminous efficacy	90 lm/W
Color temperature	4000 K
Light color (designation)	Cool White
Color rendering index Ra	> 80
Standard deviation of color matching	< 6 sdc _m
Flickering metric (Pst LM)	-
Stroboscope effect metric (SVM)	-
Photobiological safety group acc. to EN62778	RG0
Photobiological safety group acc. to EN62471	RG0
Beam angle	120 °

0.5	1.49 1.52	E(0°) 2668 E(C90) 56.1° 232 E(C0) 56.6° 223
1.0	2.98 3.03	E(0°) 667 E(C90) 56.1° 58 E(C0) 56.6° 56
1.5	4.46 4.55	E(0°) 296 E(C90) 56.1° 26 E(C0) 56.6° 25
2.0	5.95 6.07	E(0°) 167 E(C90) 56.1° 14 E(C0) 56.6° 14
2.5	7.44 7.58	E(0°) 107 E(C90) 56.1° 9 E(C0) 56.6° 9
3.0	8.93 9.10	E(0°) 74 E(C90) 56.1° 6 E(C0) 56.6° 6
Distance [m]	Cone diameter [m]	Illuminance [lx]
— C0/C180 (Half beam angle [°]: 113.2°) — C90/C270 (Half beam angle [°]: 112.2°)		

LDC typ cone

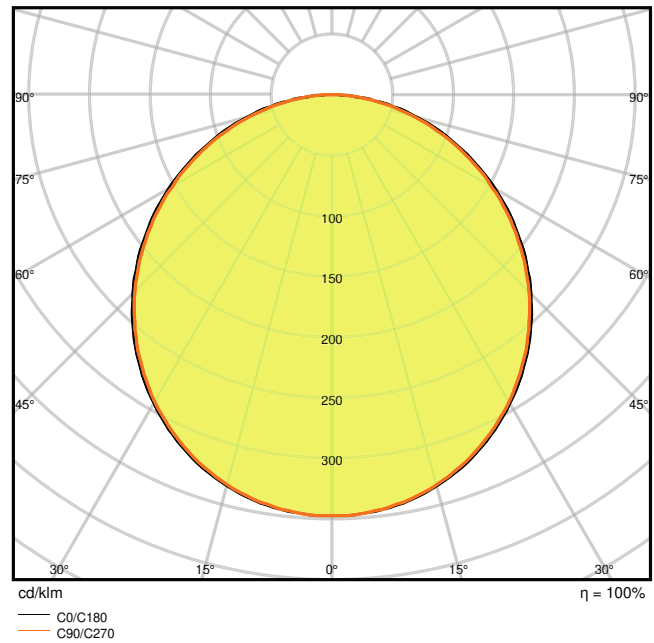

LDC typ polar

Dimensions & Weight

Diameter	225.00 mm
Height	23.00 mm
Product weight	350.00 g

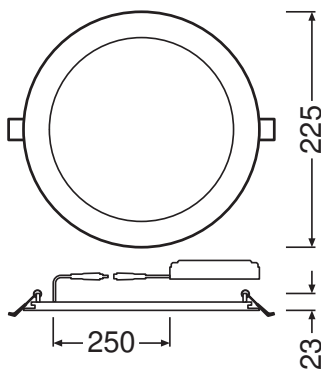

Materials & Colors

Product color	White
Housing color	White
Body material	Aluminum
Cover material	Polymethylmethacrylate (PMMA)
Light emitting surface material	PMMA
Glow Wire Test according to IEC 60695-2-12	650 °C
Mercury content	0.0 mg

Application & Mounting

Ambient temperature range	-20...+40 °C
Temperature range at storage	-30...+70 °C
Type of connection	Screwless terminal, 2-Pole
Type of protection	IP20
Protection class IK (shock resistance)	IK03
Dimmable	No
Mounting type	Recessed
Mounting location	Ceiling / Wall
Application environment	Indoor
Mounting diameter	205 mm
Mounting depth	40 mm
LED module replaceable	Not replaceable
With light source	Yes

Lifespan

Lifespan L70/B50 at 25 °C	50000 h
Lifespan L80/B10 at 25 °C	30000 h
Lifespan L90/B10 at 25 °C	15000 h
Number of switching cycles	50000













Control gear

Output current	360 mA
ECG - Output ripple current	≤ 10 %
ECG - Length	120 mm
ECG - Width	42 mm
ECG - Height	28 mm

Certificates & Standards

Standards	CE / CB
Luminaire with limited surface temperature, "D sign"	No
Ball shot safe	No

DOWNLOAD DATA

DOWNLOAD DATA	
	User instruction
	Addon Technical Information
	Tender documents
	Declarations of conformity
	Declarations of conformity
	On-Pack-Info
	IES file (IES)
	LDT file (Eulumdat)
	R3D file (Relux 3D Model)
	M3D file (3D Model)
	ULD file (DIALux)
	UGR file (UGR table)

LOGISTICAL DATA

Product code	Packaging unit (Pieces/Unit)	Dimensions (length x width x height)	Gross weight	Volume
4058075064034	Shipping box 10	495 mm x 245 mm x 245 mm	4766.00 g	29.71 dm ³

The mentioned product code describes the smallest quantity unit which can be ordered. One shipping unit can contain one or more single products.

When placing an order, for the quantity please enter single or multiples of a shipping unit.

References / Links

- For Guarantee see www.ledvance.com/guarantee

DISCLAIMER

Subject to change without notice. Errors and omission excepted. Always make sure to use the most recent release.