

gembird® **ТВ стойка за стена** **Gembird WM-80F-01** **37" – 80"**

Характеристики

- ТВ стойка от високоякостна стомана
- Поддържа повечето 37"-80" LCD телевизори
- VESA съвместим максимално 600x400 мм
- Разстояние от стената 29мм
- Съдържа всички необходими материали за монтаж

Спецификации















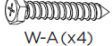

- Материал: стомана
- Обработка на повърността: прахово боядисване
- Цвят: черен с фина текстура
- Поема екрани с размер 37" – 80"
- Vesa съвместим: 200x200 мм; 300x200мм; 400x200 мм; 400x300мм; 300x300 мм; 400x400 мм; 600 x 400мм.
- Издържа до: 70кг
- Профил: 29мм
- Ъгъл на наклон: не се накланя
- Завъртане: няма
- Монтаж: върху солидна стена (406мм/450мм/600мм)
- Собствено тегло: 1.93кг

За да осигурите безопасна работа на устройствата, следвайте съветите за безопасност на: www.gmb.nl/safety

В документа за покупка трябва ясно да са посочени датата на закупуване и номерът на частта. Запазете документа за покупка през целия гаранционен период, тъй като тя е необходима за всички гаранционни рекламации. По време на гаранционния срок дефектните артикули ще бъдат кредитирани, ремонтирани или заменени за сметка на производителя. Работата, извършена в рамките на гаранцията, нито удължава гаранционния срок, нито започва нов гаранционен период.

Производителят си запазва правото да анулира всякакви гаранционни претенции за повреди или дефекти, дължащи се на неправилна употреба, злоупотреба или външен удар (падане, удар, проникване на вода, прах, замърсяване или счупване). Износващите се части са изключени от гаранцията. При получаване на рекламационна стока, Gembird Europe B.V. си запазва правото да избира между замяна на дефектни стоки или издаване на кредитно известие. Сумата на кредитното известие винаги ще се изчислява на базата на покупна стойност на дефектните продукти.

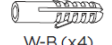
Материали за монтаж

 A(x1)	 B(x1)	 C(x8)	 M5x14 (x4) M-A	 M6x14 (x4) M-B	 M6x30 (x4) M-C	 M8x30 (x4) M-D	 W-A (x4)
 D(x2)	 E(x4)	 F(x1)	 M8x50 (x4) M-E	 D5 (x4) M-F	 D8 (x4) M-G	 M-H (x8)	 M-I (x8)
							 W-B (x4)
							 W-C (x4)

Нужни инструменти

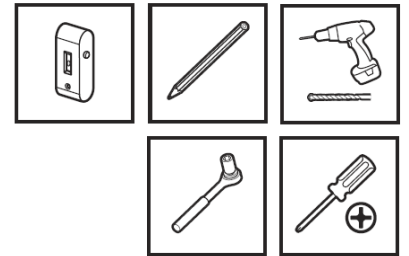

Стъпка 1

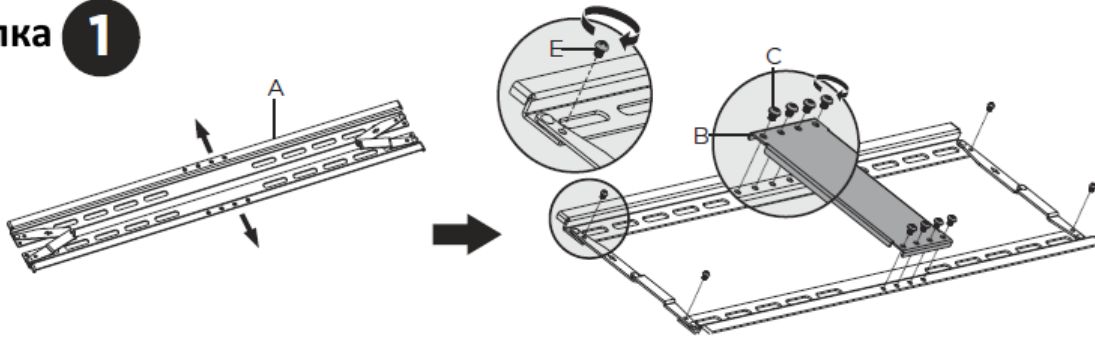

Стъпка 2a

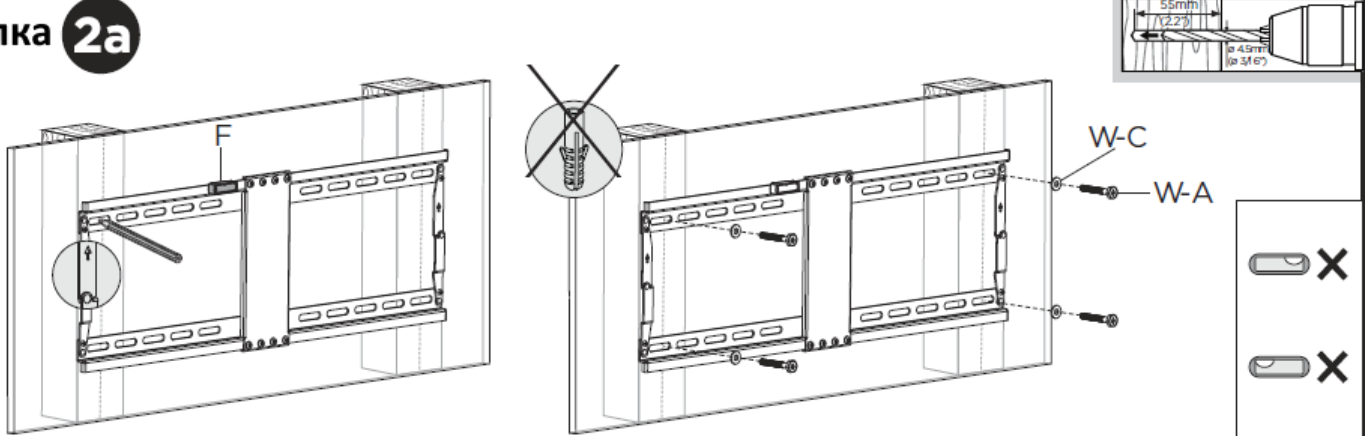

Стъпка 2b

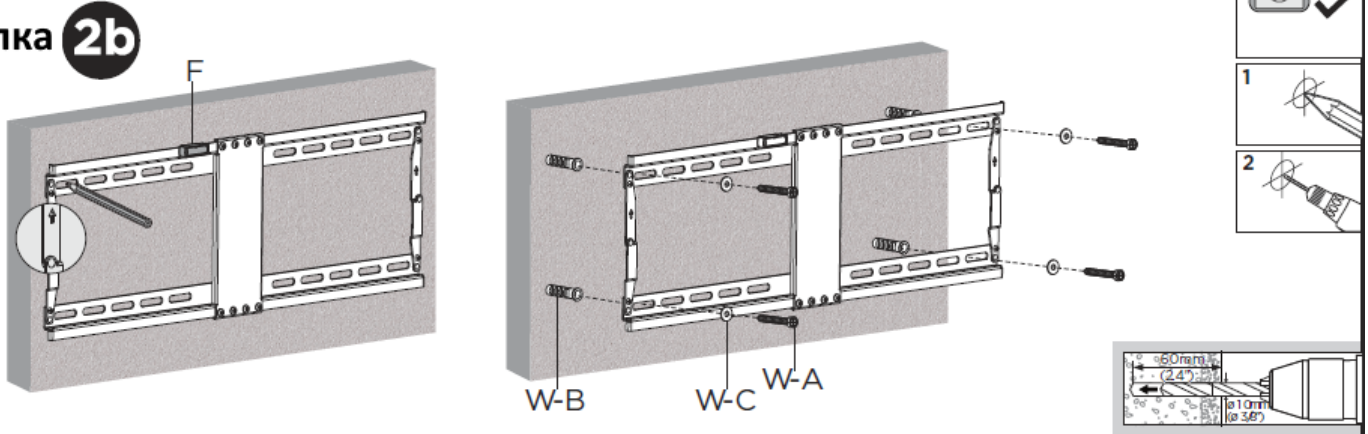

Стъпка 3а

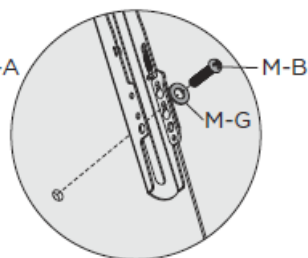
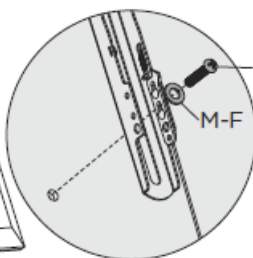
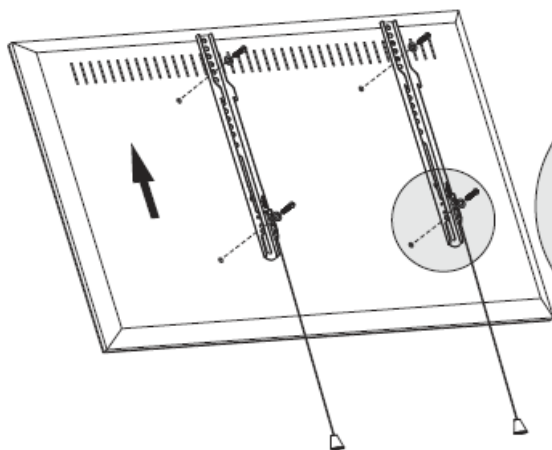

Стъпка 3b

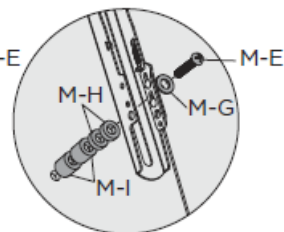
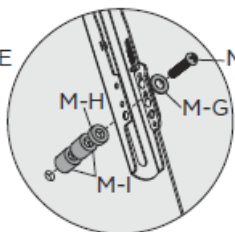
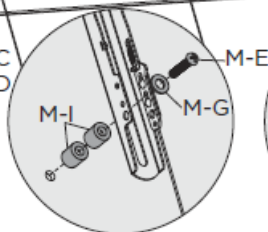
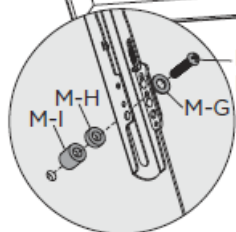
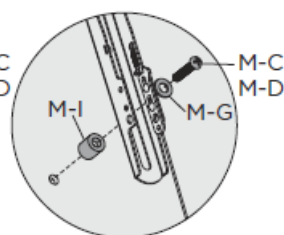
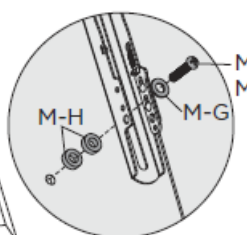
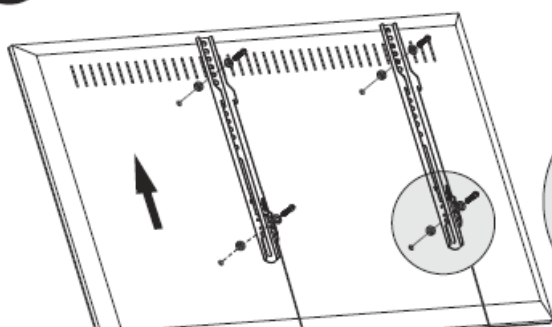
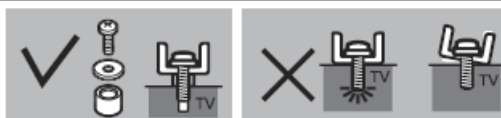

Стъпка 4

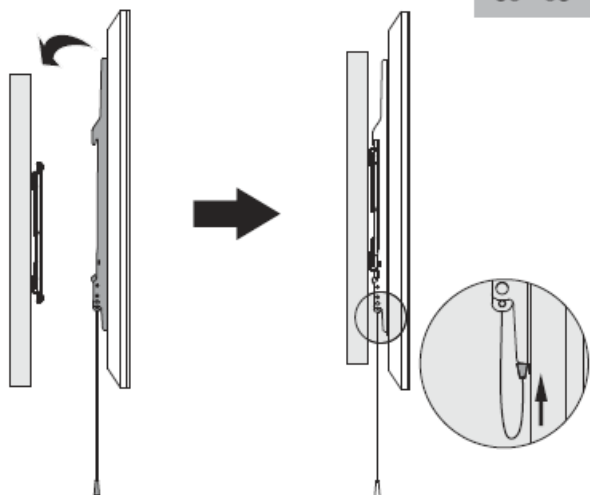

Стъпка 5

