

РЪКОВОДСТВО ЗА УПОТРЕБА WM-65RT-03

Стойка за телевизор
(ротация-наклон), 32"-65"/40 кг

Характеристика

- Тежка стоманена стойка за стена с двойно рамо, въртяща се/наклоняща се за телевизор
- Поддържа повечето 32" - 65" LCD/LED телевизори
- VESA съвместим, макс. 600 mm x 400 mm
- Разстояние до стената 72 - 420 mm
- Позволява до 120 градуса завъртане и 12 градуса наклоняне
- Включва всички необходими монтажни материали

Спецификации

- Материал: стомана
- Макс. натоварване: 40 кг (32"-65")
- Разстояние до стената: 72 ... 420 mm
- Наклон +12°
- Завъртане 120°
- Тегло нето: 3,5 кг

1

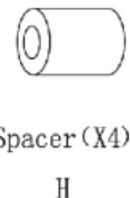
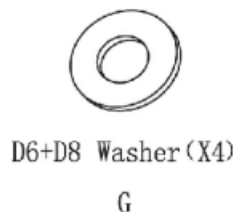
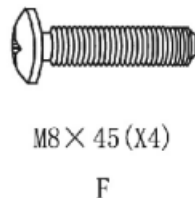
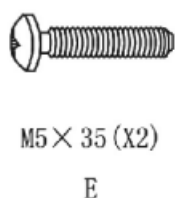
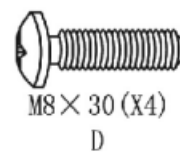
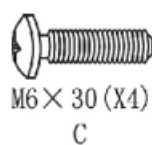
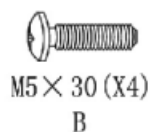
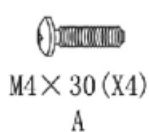
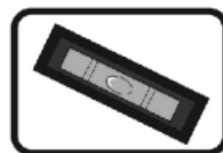
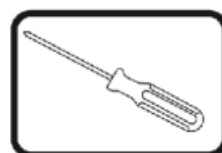
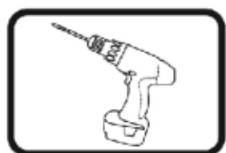
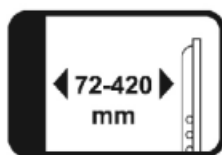

Package W

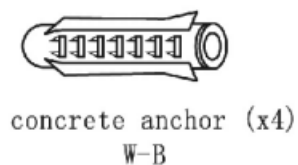
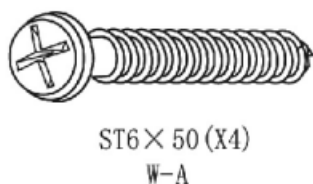

2

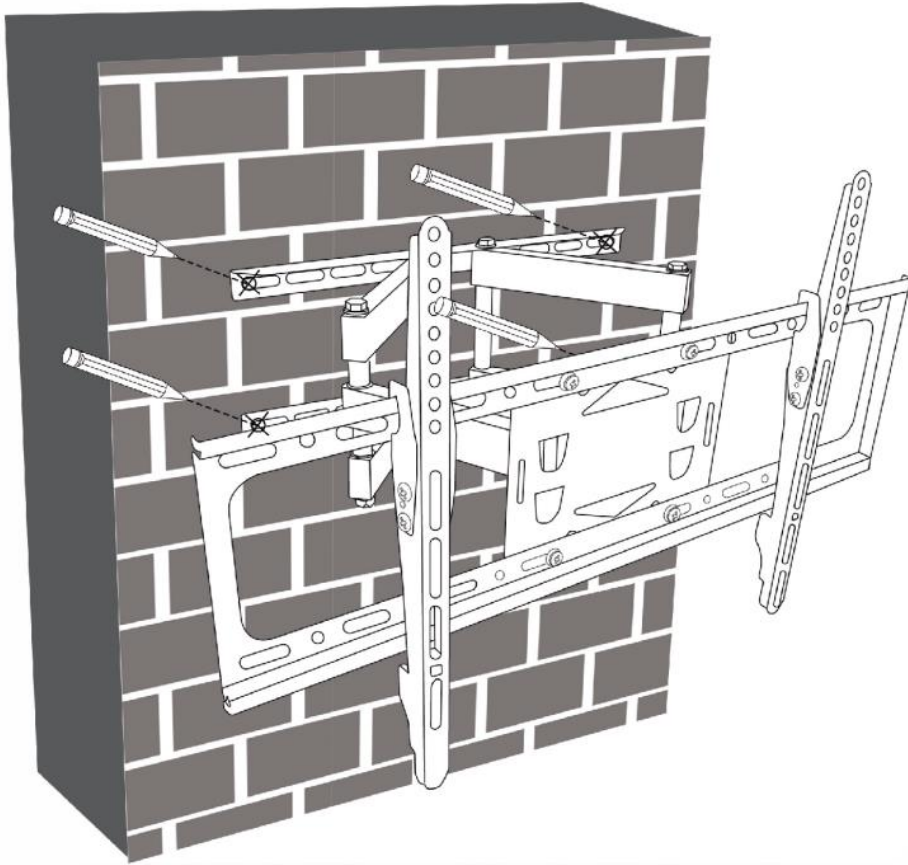

3

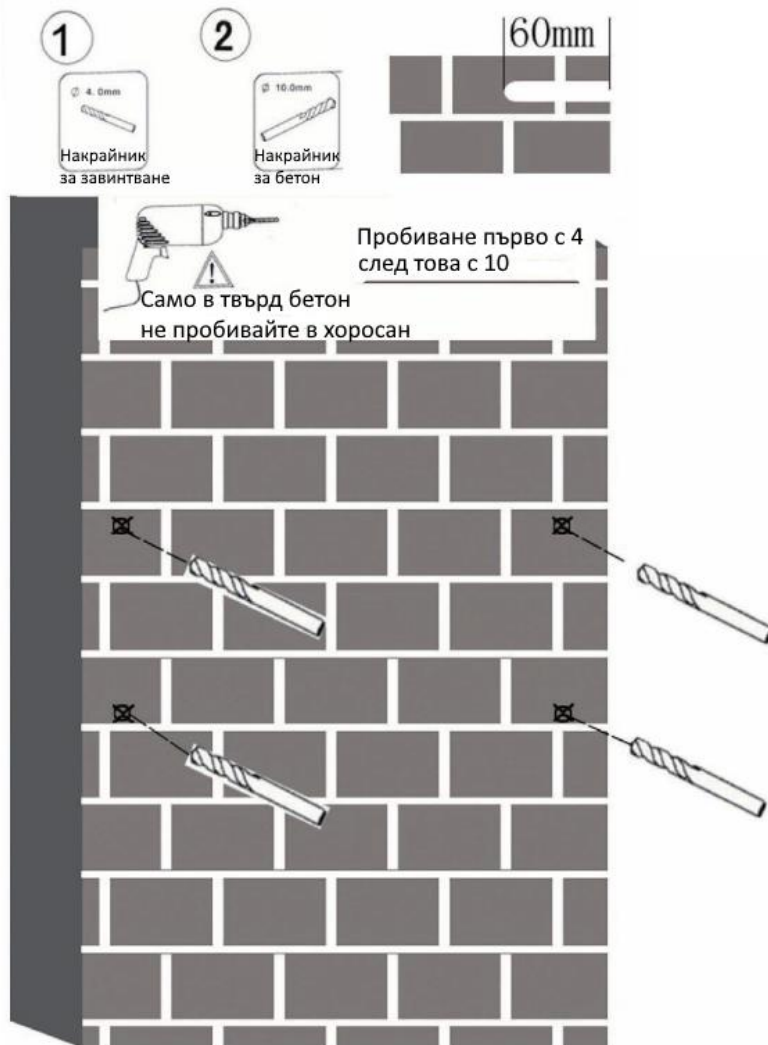

4

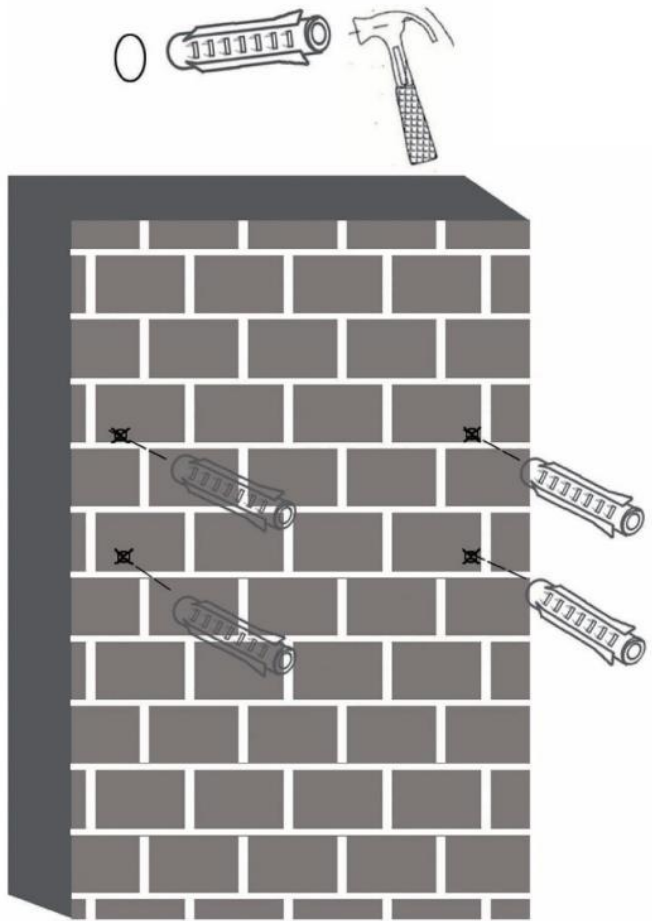

5

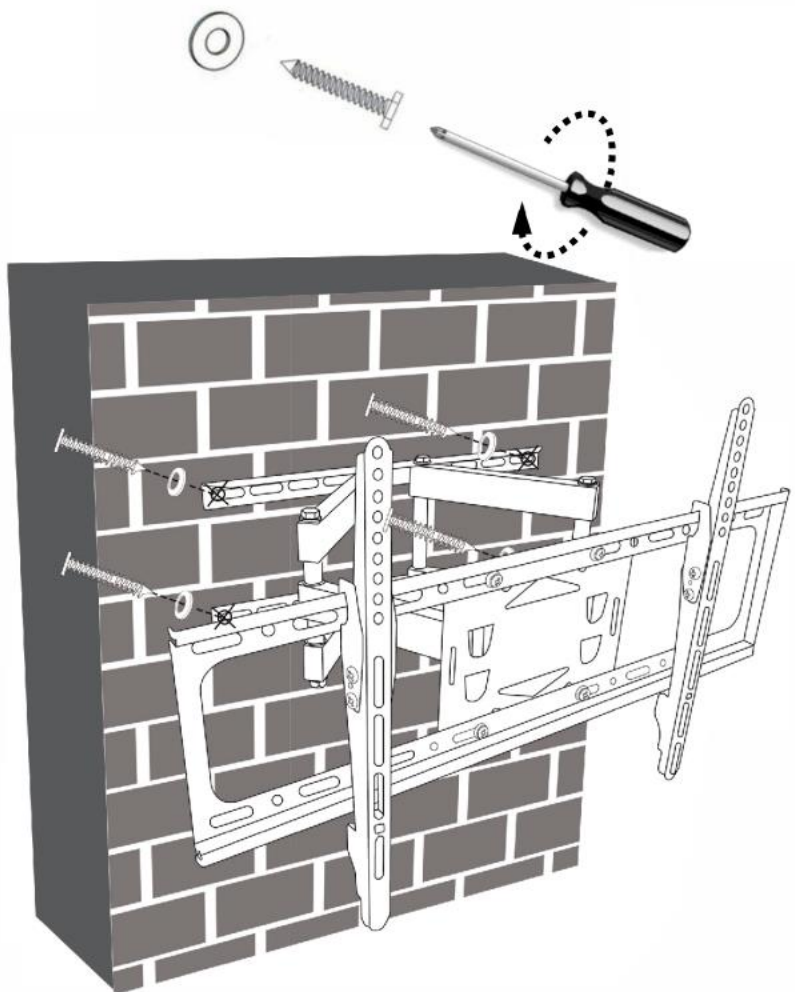

6

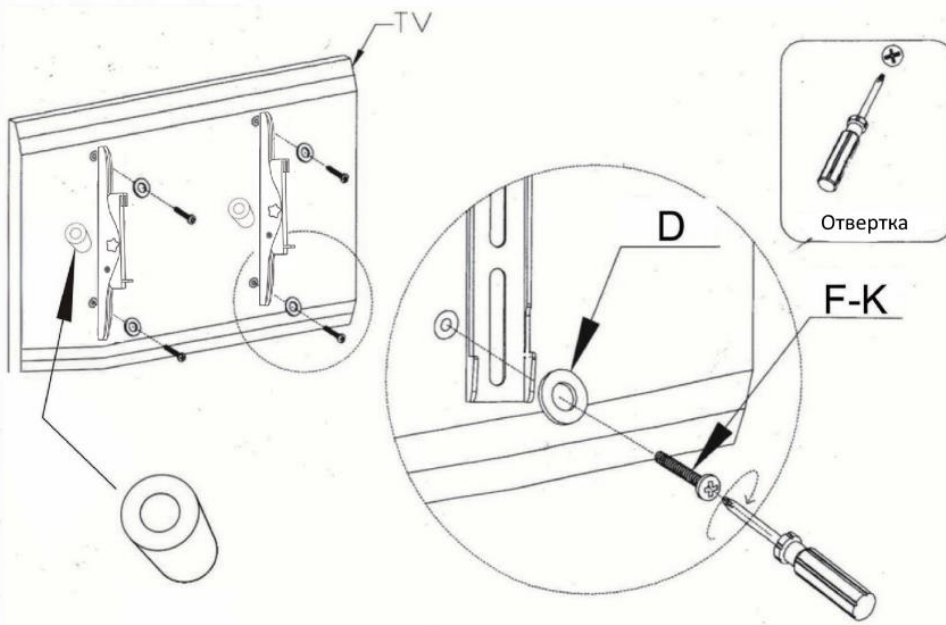

7

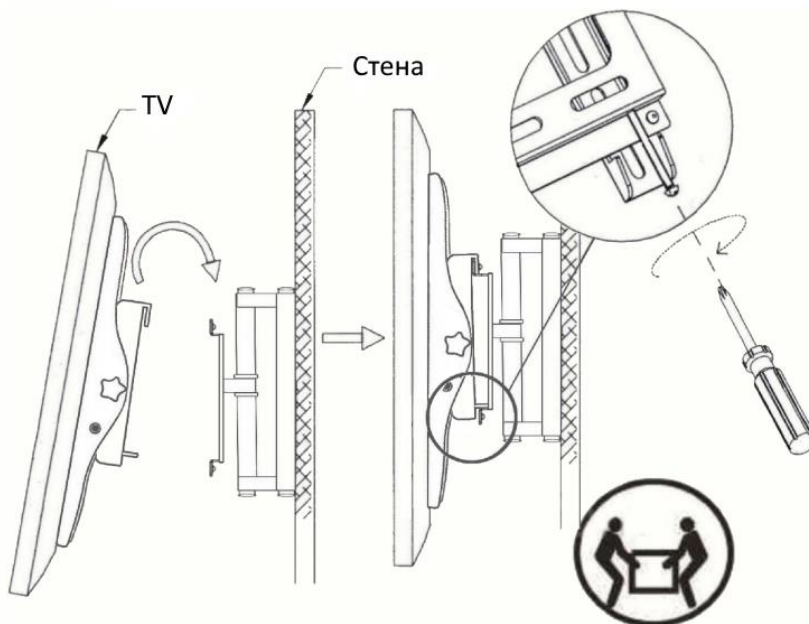

Производителят и вносителят си запазват правото да анулират всяка гаранционна претенция за повреди или дефекти, дължащи се на неправилна употреба, злоупотреба или външно въздействие (падане, удар, проникване на вода, прах, замърсяване или счупване). Износащите се части (напр. акумулаторни батерии) са изключени от гаранцията.

Gembird Europe B.V. Wittevrouwen 56, 1358CD Almere,
Холандия www.gembird.nl/service support@gmb.nl