

Precision 3680 Tower

Owner's Manual

Notes, cautions, and warnings

 **NOTE:** A NOTE indicates important information that helps you make better use of your product.

 **CAUTION:** A CAUTION indicates either potential damage to hardware or loss of data and tells you how to avoid the problem.

 **WARNING:** A WARNING indicates a potential for property damage, personal injury, or death.

Chapter 1: Views of Precision 3680 Tower	7
Front.....	7
Back.....	9
Chapter 2: Set up your Precision 3680 Tower	11
Chapter 3: Specifications of Precision 3680 Tower	15
Dimensions and weight.....	15
Processor.....	15
Chipset.....	16
Operating system.....	16
Memory.....	16
Memory matrix.....	17
External ports and slots.....	18
Internal slots.....	18
Ethernet.....	19
Wireless module.....	19
Audio.....	20
Storage.....	20
Storage matrix.....	21
RAID (Redundant Array of Independent Disks).....	22
Media-card reader.....	23
Power ratings.....	23
Power supply connector.....	24
GPU—Integrated.....	24
Multiple display support matrix.....	25
GPU—Discrete.....	25
Video port resolution.....	26
Hardware security.....	27
Environmental.....	28
Regulatory compliance.....	28
Operating and storage environment.....	28
Dell support policy.....	29
Dell Optimizer.....	29
Chapter 4: Working inside your computer	30
Safety instructions.....	30
Before working inside your computer.....	30
Safety precautions.....	31
Electrostatic discharge—ESD protection.....	31
ESD Field Service kit	32
Transporting sensitive components.....	33
After working inside your computer.....	33
BitLocker.....	33

Recommended tools.....	33
Screw list.....	34
Major components of Precision 3680 Tower.....	35

Chapter 5: Removing and installing Customer Replaceable Units (CRUs)..... 36

Side cover.....	36
Removing the side cover.....	36
Installing the side cover.....	38
Front bezel	40
Removing the front bezel.....	40
Installing the front bezel.....	41
Air shroud.....	42
Removing the air shroud (1000W PSU).....	42
Installing the air shroud (1000W PSU).....	43
3.5-inch hard-drive assembly.....	44
Removing the 3.5-inch hard drive assembly (Bay-1).....	44
Removing the 3.5-inch hard drive assembly (Bay-2).....	45
Removing the 3.5-inch hard drive bracket.....	46
Installing the 3.5-inch hard drive bracket.....	47
Installing the 3.5-inch hard drive assembly (Bay-2).....	48
Installing the 3.5-inch hard drive assembly (Bay-1).....	49
Solid state drive.....	51
Removing the M.2 2230 PCIe solid state drive.....	51
Installing the M.2 2230 PCIe solid state drive.....	51
Removing the M.2 2280 PCIe solid state drive.....	52
Installing the M.2 2280 PCIe solid state drive.....	53
WLAN card.....	54
Removing the WLAN card.....	54
Installing the WLAN card.....	55
Removing the WLAN internal antenna.....	57
Installing the WLAN internal antenna.....	58
Coin-cell battery.....	59
Removing the coin-cell battery.....	59
Installing the coin-cell battery.....	60
Memory module.....	60
Removing the memory module.....	60
Installing the memory module.....	61
GPU end holder.....	62
Removing GPU end holder.....	62
Installing the GPU end holder.....	63
Expansion card.....	64
Removing the PCIe external antenna.....	64
Installing the PCIe external antenna.....	65
Removing the graphics card.....	66
Installing the graphics card.....	67
Removing the powered GPU.....	68
Installing the powered GPU.....	71
Power-supply unit.....	73
Removing the power-supply unit cover.....	73
Installing the power-supply unit cover.....	74

Removing the 1000W power-supply unit.....	75
Installing the 1000W power-supply unit.....	77
Chapter 6: Removing and installing Field Replaceable Units (FRUs).....	79
Processor fan and heat-sink assembly.....	79
Removing the processor fan and 125 W heat-sink assembly.....	79
Installing the processor fan and 125 W heat-sink assembly.....	80
Removing the processor fan and 65 W heat-sink assembly.....	81
Installing the processor fan and 65 W heat-sink assembly.....	82
Processor.....	83
Removing the processor.....	83
Installing the processor.....	84
Voltage-regulator (VR) heat sink.....	85
Removing the VR heat sink.....	85
Installing the VR heat sink.....	86
Chassis fan.....	88
Removing the front fan.....	88
Installing the front fan.....	89
Removing the rear fan for 300W PSU systems.....	91
Installing the rear fan for 300W PSU systems.....	92
Removing the rear fan (1000W PSU).....	93
Installing the rear fan (1000W PSU).....	94
Power button.....	95
Removing the power button.....	95
Installing the power button.....	96
Intrusion switch.....	98
Removing the intrusion switch.....	98
Installing the intrusion switch.....	98
Internal speaker.....	99
Removing the internal speaker.....	99
Installing the internal speaker.....	100
System board.....	101
Removing the system board.....	101
Installing the system board.....	106
Chapter 7: Software.....	113
Operating system.....	113
Drivers and downloads.....	113
Chapter 8: Technology and components.....	114
System management features.....	114
Dell Client Command Suite for in-band systems management	114
Out-of-band systems management.....	114
Chapter 9: BIOS Setup.....	115
Entering BIOS Setup program.....	115
Navigation keys.....	115
One time boot menu.....	115
System setup options.....	116

Updating the BIOS.....	125
Updating the BIOS in Windows.....	125
Updating the BIOS in Linux and Ubuntu.....	126
Updating the BIOS using the USB drive in Windows.....	126
Updating the BIOS from the One-Time boot menu.....	127
System and setup password.....	127
Assigning a System Setup password.....	128
Deleting or changing an existing system password or setup password.....	128
Clearing CMOS settings.....	129
Clearing BIOS (System Setup) and System passwords.....	129
Chapter 10: Troubleshooting.....	130
Dell SupportAssist Pre-boot System Performance Check diagnostics.....	130
Running the SupportAssist Pre-Boot System Performance Check.....	130
Power-Supply Unit Built-in Self-Test	130
System-diagnostic lights.....	131
Recovering the operating system.....	131
Real Time Clock—RTC reset.....	131
Backup media and recovery options.....	132
Wi-Fi power cycle.....	132
Chapter 11: Getting help and contacting Dell.....	133

Views of Precision 3680 Tower

Front

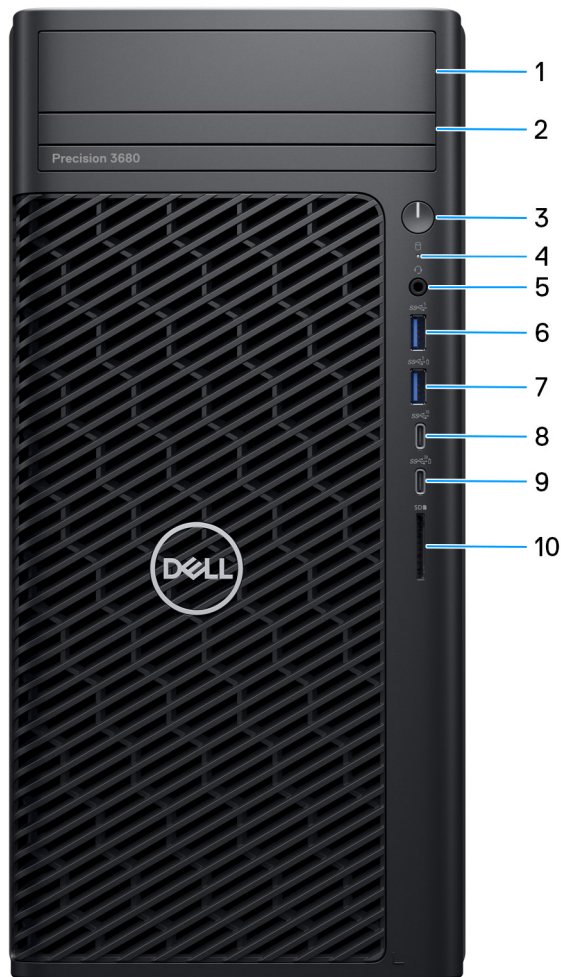

Figure 1. Image: Front view

1. Front 3.5-inch hard drive bay (optional)

Slot to install the 3.5-inch hard drive

2. Slim ODD (optional)

Reads from and writes to CDs, DVDs, and Blu ray disks.

3. Power button with diagnostic LED

Press to turn on the computer if it is turned off, in sleep state, or in hibernate state.

4. **Hard-drive activity light**

Turns on when the computer reads from or writes to the hard drive.

 **NOTE:** Hard-drive activity light is supported only on computers that are shipped with hard drive.

5. **Universal audio port**

Connect headphones or a headset (headphone and microphone combo).

6. **USB 3.2 Gen 1 (5 Gbps) port**

Connect devices such as external storage devices and printers.

Provides data transfer speeds up to 5 Gbps.

7. **USB 3.2 Gen 1 (5 Gbps) port with PowerShare**

Connect devices such as external storage devices and printers.

Provides data transfer speeds up to 5 Gbps. PowerShare enables you to charge connected USB devices.

 **NOTE:** Connected USB devices will not charge when the computer is turned off or in a sleep state. To start charging connected devices, turn on the computer.

8. **USB 3.2 Type-C Gen 2 (10 Gbps) port**

Connect devices such as external storage devices and printers. Provides data transfer speeds up to 10 Gbps.

9. **USB 3.2 Type-C Gen 2x2 (20 Gbps) port with PowerShare**

Connect devices such as external storage devices, printers, and external displays. Provides data transfer rate of up to 20 Gbps.

PowerShare enables you to charge connected USB devices.

 **NOTE:** Connected USB devices will not charge when the computer is turned off or in a sleep state. To start charging connected devices, turn on the computer.

10. **SD-card slot**

Reads from and writes to the SD card.

Back

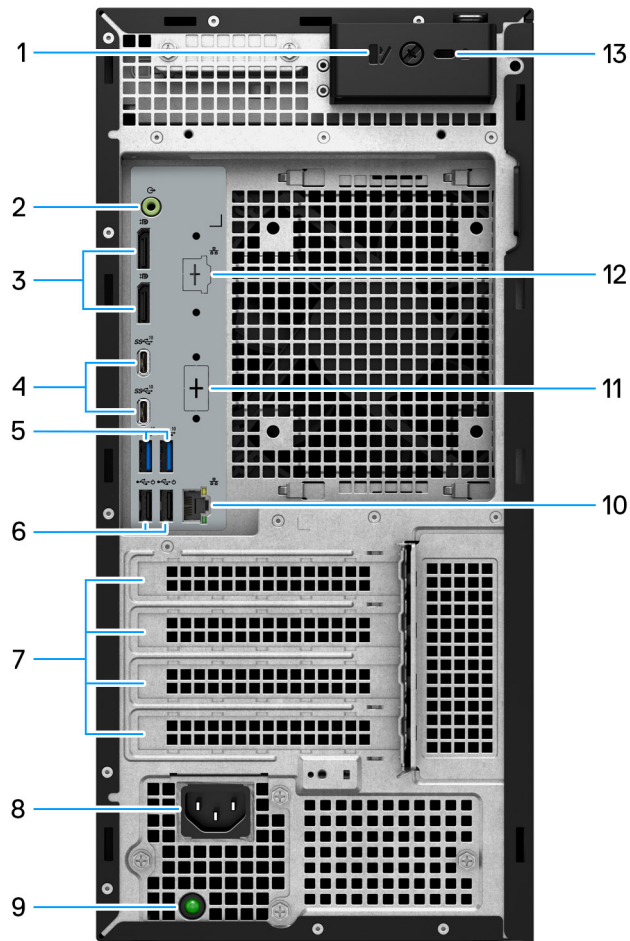

Figure 2. Image: Back view

1. Side cover release latch

Release to allow to open the side cover.

2. Audio line out port

Connect audio-output devices such as speakers and amplifiers. In a 5.1 speaker channel setup, connect the front-left and front-right speakers.

3. Two DisplayPort 1.4 ports

Connect an external display or a projector.

4. Two USB 3.2 Type-C Gen 2 (10 Gbps) ports

Connect devices such as external storage devices and printers. Provides data transfer speeds up to 10 Gbps.

5. Two USB 3.2 Gen 2 (10 Gbps) ports

Connect devices such as external storage devices and printers. Provides data transfer speeds up to 10 Gbps.

6. Two USB 2.0 (480 Mbps) ports with SmartPower

Connect devices such as external storage devices and printers. Provides data transfer speeds up to 480 Mbps. Wake from standby with the keyboard or mouse that is connected to this port.

7. Expansion card slots

Provide access to ports on any installed PCI Express cards.

8. Power cord connector port

Connect a power cable to provide power to your computer.

9. Power supply diagnostic light

Indicates the power-supply state.

10. RJ45 port 10/100/1000 Mbps

Connect an Ethernet (RJ45) cable from a router or a broadband modem for network or Internet access, with a transfer rate of 10/100/1000 Mbps.

11. HDMI 2.0/ DisplayPort 1.4/ VGA/ USB Type-C with DisplayPort Alt mode (optional)

The port available at this location may vary depending on the optional I/O card that is installed on your computer.

- **HDMI 2.0 port**

Connect to a TV, external display, or another HDMI-in enabled device. Maximum resolution that is supported up to 4096 x 2160 @60 Hz.

- **DisplayPort 1.4**

Connect an external display or a projector. Maximum resolution that is supported up to 5120 x 3200 @60 Hz.

- **VGA port**

Connect an external display or a projector. Maximum resolution that is supported up to 1920 x 1200 @60 Hz.

- **USB Type-C with DisplayPort port**

Connect devices such as external storage devices and printers. Provides data transfer speeds of up to 10 Gbps. Maximum resolution supported up to 5120x3200 @60Hz with a Type-C to DisplayPort adapter.

12. 2.5 GbE RJ45 port (optional)

Connect an Ethernet (RJ45) cable from a router or a broadband modem for network or Internet access.

13. Kensington security-cable slot

Connect a security cable to prevent unauthorized movement of your computer.

Set up your Precision 3680 Tower

About this task

NOTE: The images in this document may differ from your system depending on the configuration you ordered.

Steps

1. Connect the keyboard and mouse.

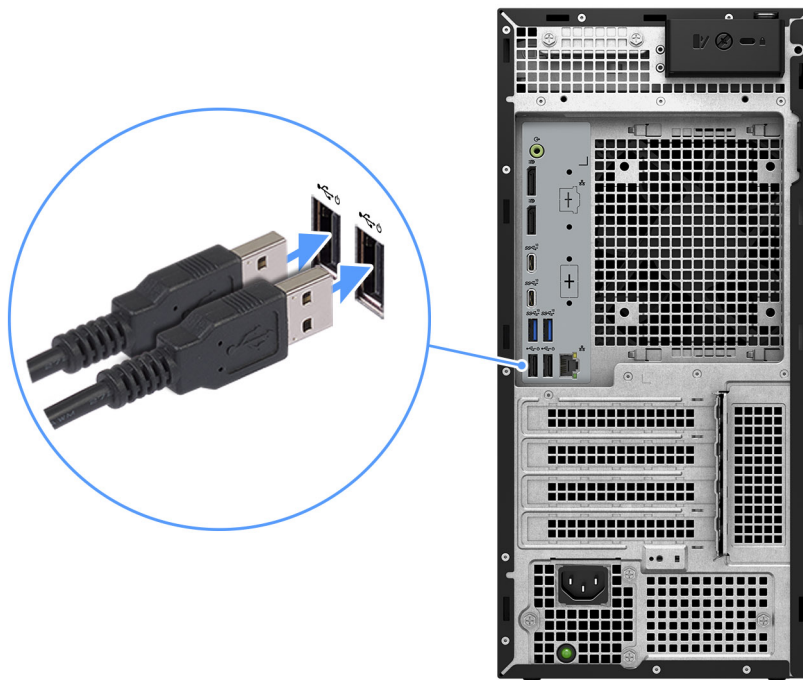

Figure 3. Connect the keyboard and mouse

2. Connect to your network using a cable, or connect to a wireless network.

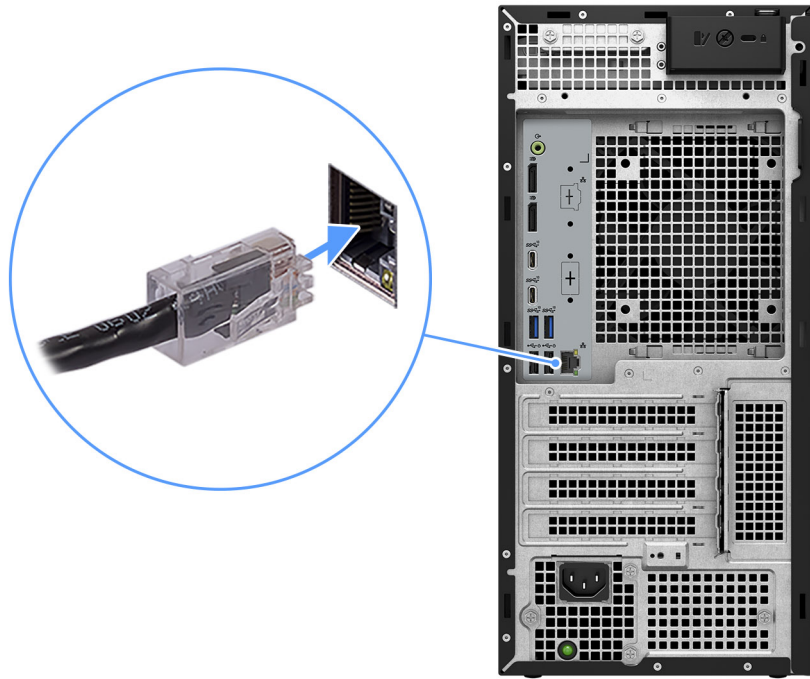

Figure 4. Connect the network cable

3. Connect the display.



Figure 5. Connect the display

4. Connect the power cable.

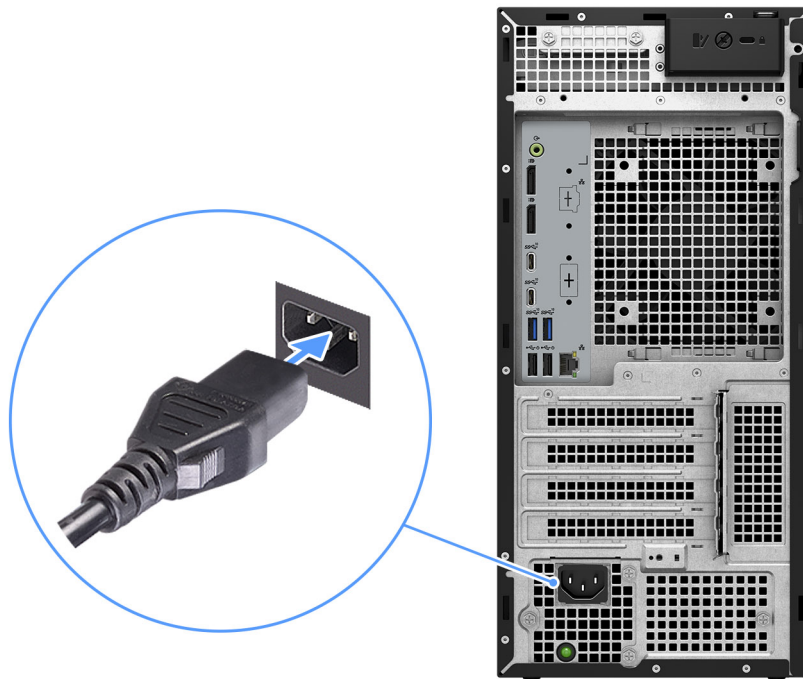

Figure 6. Connect the power cable

5. Press the power button.



Figure 7. Press the power button

6. Finish the operating system setup.

For Ubuntu:

Follow the on-screen instructions to complete the setup. For more information about installing and configuring Ubuntu, search in the Knowledge Base Resource at [Dell Support Site](#).





For Windows:

Follow the on-screen instructions to complete the setup. When setting up, Dell Technologies recommends that you:

- Connect to a network for Windows updates.
 - ① **NOTE:** If connecting to a secured wireless network, enter the password for the wireless network access when prompted.
- If connected to the Internet, sign-in with or create a Microsoft account. If not connected to the Internet, create an offline account.
- On the **Support and Protection** screen, enter your contact details.

7. We recommend looking for Dell apps in the Windows Start menu.

Table 1. Locate Dell apps

Resources	Description
	<p>Dell Product Registration</p> <p>Register your computer with Dell.</p>
	<p>Dell Help & Support</p> <p>Access help and support for your computer.</p>
	<p>SupportAssist</p> <p>SupportAssist is the smart technology that keeps your computer running at its best by optimizing settings, detecting issues, removing viruses and notifies when you must make computer updates. SupportAssist proactively checks the health of your computer hardware and software. When an issue is detected, the necessary system state information is sent to Dell to begin troubleshooting. SupportAssist is preinstalled on most of the Dell devices running the Windows operating system. For more information, see <i>SupportAssist for Business PCs manual</i> at SupportAssist for Home PCs.</p> <p>① NOTE: In SupportAssist, click the warranty expiry date to renew or upgrade your warranty.</p>
	<p>Dell Update</p> <p>Updates your computer with critical fixes and latest device drivers as they become available. For more information about using Dell Update, see the product guides and third-party license documents at Dell Support Site.</p>
	<p>Dell Digital Delivery</p> <p>Download software applications, which are purchased but not preinstalled on your computer. For more information about using Dell Digital Delivery, search in the Knowledge Base Resource at Dell Support Site.</p>

Specifications of Precision 3680 Tower

Dimensions and weight

The following table lists the height, width, depth, and weight of your Precision 3680 Tower.

Table 2. Dimensions and weight

Description	Values
Height	372.90 mm (14.68 in.)
Width	173.00 mm (6.81 in.)
Depth	420.20 mm (16.54 in.)
Weight  NOTE: The weight of your computer depends on the configuration ordered and manufacturing variability.	<ul style="list-style-type: none"> • Minimum - 7.58 kg (16.71 lb) • Maximum - 16.05 kg (35.38 lb)

Processor

The following table lists the details of the processors that are supported for your Precision 3680 Tower.

Table 3. Processor

Description	Option one	Option two	Option three	Option four	Option five	Option six	Option seven	Option eight
Processor type	14 th Gen Intel Core i3-14100	14 th Gen Intel Core i5-14500 vPro	14 th Gen Intel Core i5-14600 vPro	14 th Gen Intel Core i5-14600K vPro	14 th Gen Intel Core i7-14700 vPro	14 th Gen Intel Core i7-14700K vPro	14 th Gen Intel Core i9-14900 vPro	14 th Gen Intel Core i9-14900K vPro
Processor wattage	60 W	65 W	65 W	125 W	65 W	125 W	65 W	125 W
Processor core count	4	14	14	14	20	20	24	24
Processor thread count	8	20	20	20	28	28	32	32
Processor speed	3.5 GHz to 4.7 GHz Turbo	2.6 GHz to 5.0 GHz Turbo	2.7 GHz to 5.2 GHz Turbo	3.5 GHz to 5.3 GHz Turbo	2.1 GHz to 5.4 GHz Turbo	3.4 GHz to 5.6 GHz Turbo	2.0 GHz to 5.8 GHz Turbo	3.2 GHz to 6.0 GHz Turbo
Processor cache	12 MB	24 MB	24 MB	24 MB	33 MB	33 MB	36 MB	36 MB
Integrated graphics	Intel UHD Graphics 730	Intel UHD Graphics 770	Intel UHD Graphics 770	Intel UHD Graphics 770	Intel UHD Graphics 770	Intel UHD Graphics 770	Intel UHD Graphics 770	Intel UHD Graphics 770

 **NOTE:**

1. Precision 3680 Tower supports Unlimited Turbo Duration feature (PL1=PL2) for all K-processor (125W) CPUs. A 1000W power supply and Premium Air Cooling solution are required.
2. Precision 3680 Tower supports Enhanced Performance (PL1=85W) for 65W CPUs. A Premium Air Cooling solution is required.

Chipset

The following table lists the details of the chipset that is supported in your Precision 3680 Tower.

Table 4. Chipset

Description	Values
Chipset	W680
Processor	14 th Gen Intel Core i3/i5/i7/i9
DRAM bus width	64-bit DIMM
Flash EPROM	16 MB + 32 MB
PCIe bus	Up to Gen5

Operating system

Your Precision 3680 Tower supports the following operating systems:

- Windows 11 Home, 64-bit
- Windows 11 Pro, 64-bit
- Windows 11 Pro National Education, 64-bit
- Windows 11 Pro for Workstations
- Ubuntu Linux 22.04 LTS, 64-bit

Memory

The following table lists the memory specifications that are supported by your Precision 3680 Tower.

Table 5. Memory specifications



Description	Values
Memory slots	Four-DIMM slots  NOTE: Up to 128 GB or up to 4400 MT/s ECC and Non-ECC DDR5
Memory type	DDR5
Memory speed	Maximum speed: 4400 MT/s  NOTE: Maximum memory speed varies by the following configuration on each channel. If the two DIMM configuration is not symmetrical, the maximum speed may drop. <ul style="list-style-type: none"> • 4400 MT/s: 1 DIMM-1R/2R • 4000 MT/s: 2 DIMM-1R • 3600 MT/s: 2 DIMM-2R

Table 5. Memory specifications (continued)

Description	Values
Maximum memory configuration	128 GB
Minimum memory configuration	8 GB
Memory size per slot	8 GB, 16 GB, and 32 GB
Memory configurations supported	<ul style="list-style-type: none"> ● 8 GB: 1 x 8 GB, DDR5, 4400 MT/s, Non-ECC ● 16 GB: 2 x 8 GB, DDR5, 4400 MT/s, Non-ECC, dual-channel ● 16 GB: 1 x 16 GB, DDR5, 4400 MT/s, Non-ECC ● 32 GB: 2 x 16 GB, DDR5, 4400 MT/s, Non-ECC, dual-channel ● 32 GB: 4 x 8 GB, DDR5, 4000 MT/s, Non-ECC, dual-channel ● 64 GB: 2 x 32 GB, DDR5, 4400 MT/s, Non-ECC, dual-channel ● 64 GB: 4 x 16 GB, DDR5, 4000 MT/s, Non-ECC, dual-channel ● 128 GB: 4 x 32 GB, DDR5, 3600 MT/s, Non-ECC, dual-channel ● 16 GB: 1 x 16 GB, DDR5, 4400 MT/s, ECC ● 32 GB: 2 x 16 GB, DDR5, 4400 MT/s, ECC, dual-channel ● 64 GB: 2 x 32 GB, DDR5, 4400 MT/s, ECC, dual-channel ● 64 GB: 4 x 16 GB, DDR5, 4000 MT/s, ECC, dual-channel ● 128 GB: 4 x 32 GB, DDR5, 3600 MT/s, ECC, dual-channel <p> NOTE: ECC memory is not supported on the Intel Core i3-14100 processor.</p>

Memory matrix

The following table lists the memory configurations supported on your Precision 3680 Tower.

Table 6. Memory matrix

Configuration	Slot			
	DIMM1	DIMM2	DIMM3	DIMM4
8 GB DDR5	8 GB	N/A	N/A	N/A
16 GB DDR5	16 GB	N/A	N/A	N/A
16 GB DDR5	8 GB	8 GB	N/A	N/A
32 GB DDR5	16 GB	16 GB	N/A	N/A
64 GB DDR5	32 GB	32 GB	N/A	N/A
64 GB DDR5	16 GB	16 GB	16 GB	16 GB
128 GB DDR5	32 GB	32 GB	32 GB	32 GB

 **NOTE:** 8 GB configuration available only for non-ECC memory.

External ports and slots

The following table lists the external ports of your Precision 3680 Tower.

Table 7. External ports and slots

Description	Values
Network port	<ul style="list-style-type: none"> One RJ45 (1 GbE) Ethernet port One RJ45 (2.5 GbE) Ethernet port (optional)
USB ports	<p>Front:</p> <ul style="list-style-type: none"> One USB 3.2 Gen 1 (5 Gbps) port One USB 3.2 Gen 1 (5 Gbps) port with PowerShare One USB 3.2 Gen 2 (10 Gbps) Type-C port One USB 3.2 Gen 2x2 (20 Gbps) Type-C port with PowerShare <p>Rear:</p> <ul style="list-style-type: none"> Two USB 2.0 (480 Mbps) ports with SmartPower Two USB 3.2 Gen 2 (10 Gbps) ports Two USB 3.2 Gen 2 (10 Gbps) Type-C ports
Audio port	<ul style="list-style-type: none"> Front: One Universal Audio port Rear: One Audio line-out
Video port(s)	<ul style="list-style-type: none"> Two DisplayPort 1.4a HBR2 ports One Optional Port (VGA, HDMI 2.0, DP++ 1.4a HBR3, USB 3.2 Gen 2 (10 Gbps) Type-C with DP-Alt mode) <p>NOTE: Download and install the latest Intel Graphics driver from Dell Support Site to enable multiple displays.</p>
Media-card reader	One SD-card slot
Power-adaptor port	N/A
Security-cable slot	One Kensington security-cable slot

Internal slots

The following table lists the internal slots of your Precision 3680 Tower.

Table 8. Internal slots

Description	Values
M.2	<ul style="list-style-type: none"> One M.2 2230 slot for WiFi and Bluetooth card Two M.2 2230/2280 slots (SSD0 and SSD1) for SSD One M.2 2280 slot (SSD2) for SSD <p>NOTE: SSD0 slot supports M.2 2230 and M.2 2280 SSDs by default.</p> <p>NOTE: SSD1 slot supports M.2 2230 and M.2 2280 SSDs by default.</p> <p>NOTE: SSD2 slot supports only M.2 2280 SSDs by default.</p>

Table 8. Internal slots

Description	Values
	i NOTE: To learn more about the features of different types of M.2 cards, search in the Knowledge Base Resource at Dell Support Site .

Ethernet

The following table lists the wired Ethernet Local Area Network (LAN) specifications of your Precision 3680 Tower.

Table 9. Ethernet specifications

Description	Values
Model number	Intel I219-LM
Transfer rate	10/100/1000 Mbps

Wireless module

The following table lists the Wireless Local Area Network (WLAN) modules that are supported on your Precision 3680 Tower.

Table 10. Wireless module specifications

Description	Option one	Option two
Model number	Intel AX211	Qualcomm WCN6856-DBS
Transfer rate	2400 Mbps	Up to 3571 Mbps
Frequency bands supported	2.4 GHz/5 GHz/6 GHz i NOTE: The 6 GHz frequency is supported on computers that are installed with the Windows 11 operating system only.	2.4 GHz/5 GHz/6 GHz i NOTE: The 6 GHz frequency is supported on computers that are installed with the Windows 11 operating system only.
Wireless standards	<ul style="list-style-type: none"> • WiFi 802.11a/b/g • Wi-Fi 4 (WiFi 802.11n) • Wi-Fi 5 (WiFi 802.11ac) • Wi-Fi 6E (WiFi 802.11ax) 	<ul style="list-style-type: none"> • WiFi 802.11a/b/g • Wi-Fi 4 (WiFi 802.11n) • Wi-Fi 5 (WiFi 802.11ac) • Wi-Fi 6E (WiFi 802.11ax)
Encryption	<ul style="list-style-type: none"> • 64-bit/128-bit WEP • AES-CCMP • TKIP 	<ul style="list-style-type: none"> • 64-bit and 128-bit WEP • AES-CCMP • TKIP
Bluetooth wireless card	5.3	5.3
	i NOTE: The version of the Bluetooth wireless card may vary depending on the operating system that is installed on your computer.	

Audio

The following table lists the audio specifications of your Precision 3680 Tower.

Table 11. Audio specifications

Description		Values
Audio controller		Realtek ALC3246-CG
Stereo conversion		24-bit DAC (Digital-to-Analog) and ADC (Analog-to-Digital)
Internal audio interface		Intel HDA (high-definition audio)
External audio interface		<ul style="list-style-type: none"> • Front: One Universal Audio port • Rear: One Audio line-out
Number of speakers		One (optional)
Internal-speaker amplifier		Integrated in ALC3246-CG (Class-D 2 W)
External volume controls		Keyboard shortcut controls
Speaker output:		
	Average speaker output	2 W
	Peak speaker output	2.2 W
Subwoofer output		Not supported
Microphone		Not supported

Storage

This section lists the storage options on your Precision 3680 Tower.

- M.2 SSD Boot + Optional M.2 SSDs – This configuration enables boot on M.2 NVMe SSD with up to three additional NVMe SSDs. No SATA hard drive are configured in this option.
- M.2 SSD Boot + Optional M.2 SSD + 3.5-inch SATA hard drive + Optional 3.5-inch SATA hard drive – This configuration enables boot on M.2 NVMe SSD with up to three additional NVMe SSDs, one 3.5-inch SATA hard drive and one additional 3.5-inch SATA hard drive.
- M.2 SSD Boot + Optional SSDs + Front-accessible 3.5-inch SATA hard drive - This configuration enabled boot on M.2 NVMe SSD with up to three additional NVMe SSDs, one front-accessible 3.5-inch SATA hard drive + Two 3.5-inch SATA hard drive (internal)
- RAID 0/1/5 is available.

i **NOTE:** M.2 NVMe SSD cannot build RAID disk with any SATA drive.

i **NOTE:** Fourth NVMe SSD is supported by UltraSpeed Duo M.2 PCIe card.

i **NOTE:** Precision 3680 Tower motherboard can support up to two M.2 2230 or up to three M.2 2280 NVMe SSDs.

Table 12. Storage specifications

Storage type	Interface type	Capacity
3.5-inch, 5400 RPM, hard drive	SATA 3.0	Up to 4 TB
3.5-inch, 7200 RPM, hard drive	SATA 3.0	Up to 2 TB

Table 12. Storage specifications (continued)

Storage type	Interface type	Capacity
3.5-inch, 7200 RPM, Enterprise hard drive (optional)	SATA 3.0	Up to 8 TB
M.2 2230 SSD	Gen 4 PCIe NVMe, Class 35	256 GB
M.2 2280 SSD	Gen 4 PCIe NVMe, Class 40	Up to 4 TB
M.2 2280 SSD Self-Encrypting	Gen 4 PCIe NVMe	Up to 1 TB

Storage matrix

The following table lists the storage configurations that are supported on your Precision 3680 Tower.

Table 13. Storage matrix

Configuration group	Storage			Bootable Device	1st M.2 PCIe NVMe SSD CPU lane	2nd M.2 PCIe NVMe SSD PCH lane	3rd M.2 PCIe NVMe SSD PCH lane	CFI only 3rd NVMe SSD in QX118 slim line slot	Ultra-Speed NVMe SSD Zoom AIC	3.5-inch hard drive	3.5-inch hard drive	3.5-inch hard drive	3.5-inch hard drive	ODD
								PCH Gen3 Slot 3						
	PCIe lane connection and SSD location	QX118/ODD Physical Location	CPU Gen4 Slot 1					PCH Gen4 Slot 2	PCH Gen3 Slot 3					
C1	Internal M.2 SSD Boot (No SATA hard drive)			M.2 SSD	Y1 (boot)	Y2 (optional)	Y3 (optional)	N/A	Y4 (optional)	N/A	N/A	N/A	N/A	Y (optional)
C1	Internal M.2 SSD Boot (No SATA hard drive)			M.2 SSD	Y (boot) RAID 0 or 1	RAID 0 or 1	N/A	N/A	N/A	N/A	N/A	N/A	N/A	Y (optional)
C1	Internal M.2 SSD Boot (No SATA hard drive)			M.2 SSD	Y (boot) RAID 0 or 5	RAID 0 or 5	RAID 0 or 5	N/A	N/A	N/A	N/A	N/A	N/A	Y (optional)
C1	Internal M.2 SSD Boot (No SATA hard drive)			M.2 SSD	Y (boot) RAID 0 or 5	RAID 0 or 5	RAID 0 or 5	N/A	RAID 0 or 5	N/A	N/A	N/A	N/A	Y (optional)
C1	Internal M.2 SSD Boot (No SATA hard drive)			M.2 SSD	Y1 (boot)	Y2 (optional)	N/A	Y3 (optional)	Y4 (optional)	N/A	N/A	N/A	N/A	Y (optional)
C2	Internal M.2 SSD Boot	Optional SSDs	3.5-inch hard drives	M.2 SSD	Y1 (boot)	Y2 (optional)	Y3 (optional)	N/A	Y4 (optional)	Y1 Bay 1	Y2 (optional) Bay 2	N/A	N/A	Y (optional)

Table 13. Storage matrix (continued)

Configuration group	Storage			Bootable Device	1st M.2 PCIe NVMe SSD CPU lane	2nd M.2 PCIe NVMe SSD PCH lane	3rd M.2 PCIe NVMe SSD PCH lane	CFI only 3rd NVMe SSD in QX118 slim line slot	Ultra-Speed NVMe SSD Zoom AIC	3.5-inch hard drive	3.5-inch hard drive	3.5-inch hard drive	3.5-inch hard drive	ODD
	PCIe lane connection and SSD location							PCH Gen3 Slot 3						
	QX118/ODD Physical Location							CPU Gen4 Slot 1						
C2	Internal M.2 SSD Boot	Optional SSDs	3.5-inch hard drives	M.2 SSD	Y (boot) RAID 0 or 1	RAID 0 or 1	N/A	N/A	N/A	Y1 Bay 1	Y2 (optional) Bay 2	N/A	N/A	Y (optional)
C2	Internal M.2 SSD Boot	Optional SSDs	3.5-inch hard drives	M.2 SSD	Y (boot) RAID 0 or 5	RAID 0 or 5	RAID 0 or 5	N/A	N/A	Y1 Bay 1	Y2 (optional) Bay 2	N/A	N/A	Y (optional)
C2	Internal M.2 SSD Boot	Optional SSDs	3.5-inch hard drives	M.2 SSD	Y1 (boot)	Y2 (optional)	N/A	Y3 (optional)	Y4 (optional)	Y1 Bay 1	Y2 (optional) Bay 2	N/A	N/A	Y (optional)
C2	Internal M.2 SSD Boot	Optional SSDs	3.5-inch hard drives	M.2 SSD	Y1 (boot)	Y2 (optional)	Y3 (optional)	N/A	Y4 (optional)	RAID 0 or 1 Bay 1	RAID 0 or 1 Bay 2	N/A	N/A	Y (optional)
C3	Internal M.2 SSD Boot	Optional SSDs	Front removable 3.5-inch hard drives	M.2 SSD	Y1 (boot)	Y2 (optional)	Y3 (optional)	N/A	Y4 (optional)	Y2 (optional) Bay 1	Y3 (optional) Bay 2	N/A	Y1 Front Bay 3	Y (optional)
C4	No storage drive			None	N/A	N/A	N/A	N/A	N/A	N/A	N/A	N/A	N/A	N/A

RAID (Redundant Array of Independent Disks)

For optimal performance when configuring drives as a RAID volume, Dell Technologies recommends drive models that are identical.

NOTE: RAID is not supported on Intel Optane configurations.

RAID 0 (Striped, Performance) volumes benefit from higher performance when drives are matched because the data is split across multiple drives: any I/O operations with block sizes larger than the stripe size splits the I/O and become constrained by the slowest of the drives. For RAID 0 I/O operations where block sizes are smaller than the stripe size, whichever drive the I/O operation targets determine the performance, which increases variability and results in inconsistent latencies. This variability is particularly pronounced for write operations, and it can be problematic for applications that are latency sensitive. One such example of this is any application that performs thousands of random writes per second in small block sizes.

RAID 1 (Mirrored, Data Protection) volumes benefit from higher performance when drives are matched because the data is mirrored across multiple drives: all I/O operations must be performed identically to both drives, thus variations in drive performance when the models are different, results in the I/O operations completing only as fast as the slowest drive. While this does not suffer the variable latency issue in small random I/O operations as with RAID 0 across heterogeneous drives, the impact is nonetheless large because the higher performing drive becomes limited in all I/O types. One of the worst examples of constrained performance here is when using unbuffered I/O. To ensure that writes are fully committed to nonvolatile regions of the RAID volume, unbuffered I/O bypasses cache (for example by using the Force Unit Access bit in the NVMe protocol) and the I/O operation will not complete until all the drives in the RAID volume have completed the request to commit the data. This kind of I/O operation completely negates any advantage of a higher performing drive in the volume.

RAID 5 provides better performance by using data striping and protection through parity. The disadvantage of RAID 5 is that rebuilding a large RAID 5 volume requires a longer period of time. The following are the key features of RAID 5:

- Requires at least three drives.
- Data is available even if one of the drives present in the volume fails. The failed drive must be replaced, and the volume must be rebuilt for the data to be accessible.
- The total capacity is N-1, where N is the total capacity of the drives in the array. For example, if you use three 1 TB drives in a RAID 5 array, the total volume size is 2 TB.



Care must be taken to match not only the drive vendor, capacity, and class, but also the specific model. Drives from the same vendor, with the same capacity, and even within the same class, can have different performance characteristics for certain types of I/O operations. Thus, matching by model ensures that the RAID volume is comprised of a homogeneous array of drives that deliver all the benefits of a RAID volume without incurring the additional penalties when one or more drives in the volume are lower performing.

Precision 3680 Tower supports RAID with more than one hard drive configuration.

Media-card reader

The following table lists the media cards that are supported in your Precision 3680 Tower.

Table 14. Media-card reader specifications

Description	Values
Media-card type	One SD-card slot  NOTE: The SD-card reader maybe from different manufacturers and will require specific drivers to be installed.
Media-cards supported	<ul style="list-style-type: none"> • Secure Digital (SD) • Secure Digital High Capacity (SDHC) • Secure Digital Extended Capacity (SDXC)
 NOTE: The maximum capacity that is supported by the media-card reader varies depending on the standard of the media card that is installed on your computer.	

Power ratings

The following table lists the power rating specifications of Precision 3680 Tower.

Table 15. Power ratings

Description	Option one	Option two	Option three
Type	300 W Platinum internal power supply unit (80PLUS Platinum Certified)	500 W Platinum internal power supply unit (80PLUS Platinum Certified)	1000 W Platinum internal power supply unit (80PLUS Platinum Certified)
Input voltage	90 VAC–264 VAC	90 VAC–264 VAC	90 VAC–264 VAC
Input frequency	47 Hz–63 Hz	47 Hz–63 Hz	47 Hz–63 Hz

Table 15. Power ratings (continued)

Description	Option one	Option two	Option three
Input current (maximum)	<ul style="list-style-type: none"> 4.2 A 	<ul style="list-style-type: none"> 7 A 	13.6 A
Output current (continuous)	<ul style="list-style-type: none"> 12 VA/18 A 12 VB/18 A Standby mode: <ul style="list-style-type: none"> 12 VA/1.5 A 12 VB/3.3 A 	<ul style="list-style-type: none"> 12 VA/18 A 12 VB/18 A 12 VC/18 A Standby mode: <ul style="list-style-type: none"> 12 VA/1.5 A 12 VB/3.3 A 12 VC/0 A 	<ul style="list-style-type: none"> 12 VA/36 A 12 VB/27 A 12 VC/36 A Standby mode: <ul style="list-style-type: none"> 12 VA/1.5 A 12 VB/5 A 12 VC/0 A
Rated output voltage	<ul style="list-style-type: none"> 12 VA 12 VB 	<ul style="list-style-type: none"> 12 VA 12 VB 12 VC 	<ul style="list-style-type: none"> 12 VA 12 VB 12 VC
Temperature range:			
Operating	5°C to 45°C (41°F to 113°F)	5°C to 45°C (41°F to 113°F)	5°C to 45°C (41°F to 113°F)
Storage	-40°C to 70°C (-40°F to 158°F)	-40°C to 70°C (-40°F to 158°F)	-40°C to 70°C (-40°F to 158°F)

Power supply connector

The following table lists the Power supply connector specifications of your Precision 3680 Tower.

Table 16. Power supply connector

Power supply unit	Connectors
300W (80 PLUS Platinum)	<ul style="list-style-type: none"> Two 4-pin connectors for the processor One 8-pin connector for the system board
500W (80 PLUS Platinum)	<ul style="list-style-type: none"> Two 4-pin connectors for the processor One 8-pin connector for the system board One 6-pin and one 2 + 6-pin connectors for graphic card
1000W (80 PLUS Platinum)	<ul style="list-style-type: none"> Two 4-pin connectors for the processor One 8-pin connector for the system board Two 6-pin and two 2 + 6-pin connectors for the graphic card

NOTE: This workstation uses high wattage power supply unit and it is recommended to use a Power Distribution Unit (PDU) always for protection of equipment.

GPU—Integrated

The following table lists the specifications of the integrated Graphics Processing Unit (GPU) supported by your Precision 3680 Tower.

Table 17. GPU—Integrated

Controller	Memory size	Processor
Intel UHD Graphics 730	Shared system memory	14 th Gen Intel Core i3-14100

Table 17. GPU—Integrated (continued)

Controller	Memory size	Processor
Intel UHD Graphics 770	Shared system memory	14 th Gen Intel Core i5-14500, i5-14600, i5-14600K, i7-14700, i7-14700K, i9-14900, and i9-14900K processors

Multiple display support matrix

The following table lists the multiple display support matrix for your Precision 3680 Tower.

Table 18. Multiple display support matrix

Description	Option one	Option two
Integrated Graphics Card	Intel UHD Graphics 730	Intel UHD Graphics 770
Optional Module	VGA, HDMI 2.0, DP++ 1.4a HBR3, USB 3.2 Gen 2 (10 Gbps) Type-C with DP-Alt mode	VGA, HDMI 2.0, DP++ 1.4a HBR3, USB 3.2 Gen 2 (10 Gbps) Type-C with DP-Alt mode
Supported 4K Displays	DP1.4a HBR2, 4096 x 2304 @60 Hz	DP1.4a HBR2, 4096 x 2304 @60 Hz
Supported 5K Displays	5K tiled resolution (5120 x 2880) support on DP panels. <i>i</i> NOTE: Requires two DP cables that are driven through two separate DDIs from the source, and using DP-SST (Single Stream Transport) mechanism.	5K tiled resolution (5120 x 2880) support on DP panels. <i>i</i> NOTE: Requires two DP cables that are driven through two separate DDIs from the source, and using DP-SST (Single Stream Transport) mechanism.

GPU—Discrete

The following table lists the specifications of the discrete Graphics Processing Unit (GPU) supported by your Precision 3680 Tower.

Table 19. GPU—Discrete

Controller	Memory size	Memory type
NVIDIA RTX 6000 Ada Generation	48 GB	GDDR6
NVIDIA RTX 5000 Ada Generation	24 GB	GDDR6
NVIDIA RTX 4500 Ada Generation	24 GB	GDDR6
NVIDIA RTX 4000 Ada Generation	20 GB	GDDR6
NVIDIA RTX 2000 Ada Generation	16 GB	GDDR6
NVIDIA T1000	8 GB	GDDR6
NVIDIA T1000	4 GB	GDDR6
NVIDIA T400	4 GB	GDDR6
NVIDIA GeForce RTX 4090	24 GB	GDDR6X
NVIDIA GeForce RTX 4090D	24 GB	GDDR6X

Table 19. GPU—Discrete (continued)

Controller	Memory size	Memory type
NVIDIA GeForce RTX 4080 Super	16 GB	GDDR6X
NVIDIA GeForce RTX 4070	12 GB	GDDR6
NVIDIA GeForce RTX 4060	8 GB	GDDR6
AMD Radeon Pro W7900	48 GB	GDDR6
AMD Radeon Pro W7600	8 GB	GDDR6
AMD Radeon Pro W7500	8 GB	GDDR6
AMD Radeon Pro W6400	4 GB	GDDR6
AMD Radeon Pro W6300	2 GB	GDDR6





Video port resolution

The following table lists the video port resolution for your Precision 3680 Tower.

Table 20. Video port resolution

Graphics card	Video ports	Maximum supported resolution
NVIDIA RTX 6000 Ada Generation	Four DP 1.4 ports	7680 x 4320 @24 bpp at 120 Hz <i>i</i> NOTE: Requires two DPs 1.4a and DSC <i>i</i> NOTE: DisplayPort 1.2 Certified, DisplayPort 1.3 and 1.4 ready
NVIDIA RTX 5000 Ada Generation	Four DP 1.4 ports	7680 x 4320 @24 bpp at 120 Hz <i>i</i> NOTE: Requires two DPs 1.4a and DSC <i>i</i> NOTE: DisplayPort 1.2 Certified, DisplayPort 1.3 and 1.4 ready
NVIDIA RTX 4500 Ada Generation	Four DP 1.4 ports	7680 x 4320 @24 bpp at 120 Hz <i>i</i> NOTE: Requires two DPs 1.4a and DSC <i>i</i> NOTE: DisplayPort 1.2 Certified, DisplayPort 1.3 and 1.4 ready
NVIDIA RTX 4000 Ada Generation	Four DP 1.4 ports	7680 x 4320 @24 bpp at 120 Hz <i>i</i> NOTE: Requires two DPs 1.4a and DSC <i>i</i> NOTE: DisplayPort 1.2 Certified, DisplayPort 1.3 and 1.4 ready
NVIDIA RTX 2000 Ada Generation	Four mini-DP 1.4 ports	7680 x 4320 @24 bpp at 120 Hz <i>i</i> NOTE: Requires two DPs 1.4a and DSC <i>i</i> NOTE: DisplayPort 1.2 Certified, DisplayPort 1.3 and 1.4 ready
NVIDIA T1000	Four mini-DP 1.4 ports	7680 x 4320 @24 bpp at 120 Hz <i>i</i> NOTE: Requires three DPs 1.4a and DSC

Table 20. Video port resolution (continued)

Graphics card	Video ports	Maximum supported resolution
		 NOTE: DisplayPort 1.2 Certified, DisplayPort 1.3 and 1.4 ready
NVIDIA T1000	Four mini-DP 1.4 ports	7680 x 4320 @24 bpp at 120 Hz  NOTE: Requires three DPs 1.4a and DSC  NOTE: DisplayPort 1.2 Certified, DisplayPort 1.3 and 1.4 ready
NVIDIA T400	Three mini-DP 1.4 ports	7680 x 4320 @24 bpp at 120 Hz  NOTE: Requires two DPs 1.4a and DSC  NOTE: DisplayPort 1.2 Certified, DisplayPort 1.3 and 1.4 ready
NVIDIA GeForce RTX 4090	<ul style="list-style-type: none"> • Three DisplayPort 1.4a ports • One HDMI 2.1 port 	7680 x 4320 @60 Hz
NVIDIA GeForce RTX 4090D	<ul style="list-style-type: none"> • Three DisplayPort 1.4a ports • One HDMI 2.1 port 	7680 x 4320 @60 Hz
NVIDIA GeForce RTX 4080 Super	<ul style="list-style-type: none"> • Three DisplayPort 1.4a ports • One HDMI 2.1 port 	7680 x 4320 @60 Hz
NVIDIA GeForce RTX 4070	<ul style="list-style-type: none"> • Three DisplayPort 1.4a ports • One HDMI 2.1 port 	7680 x 4320 @60 Hz
NVIDIA GeForce RTX 4060	<ul style="list-style-type: none"> • Three DisplayPort 1.4a ports • One HDMI 2.1 port 	7680 x 4320 @60 Hz
AMD Radeon Pro W7900	<ul style="list-style-type: none"> • Three DisplayPort 2.1 ports • One enhanced mini-DP 2.1 port 	7680 x 4320 @60 Hz
AMD Radeon Pro W7600	Four DP 2.1 ports	7680 x 4320 @60 Hz
AMD Radeon Pro W7500	Four DP 2.1 ports	7680 x 4320 @60 Hz
AMD Radeon Pro W6400	Two DP 1.4 ports	7680 x 4320 @60 Hz
AMD Radeon Pro W6300	Two DP 1.4 ports	7680 x 4320 @60 Hz

Hardware security

The following table lists the hardware security of your Precision 3680 Tower.

Table 21. Hardware security

Hardware security
Kensington security-cable slot
Padlock loop
Lockable cable cover (optional)
Lockable Bezel and Key for Front Accessible SATA hard drive (optional)  NOTE: Included with front-accessible storage configurations

Table 21. Hardware security (continued)

Hardware security
Chassis intrusion switch
Trusted Platform Module TPM 2.0 (FIPs 140-2 certificate)
Intel Integrated TPM

Environmental

The following table lists the environmental specifications of your Precision 3680 Tower.

Table 22. Environmental

Feature	Values
Recyclable packaging	Yes
BFR/PVC—free	No
Vertical orientation packaging support	Yes
MultiPack packaging	Yes (Except Brazil)
Energy-Efficient Power Supply	Standard
ENV0424 compliant	Yes

i **NOTE:** Wood-based fiber packaging contains a minimum of 35% recycled content by total weight of wood-based fiber. Packaging that contains without wood-based fiber can be claimed as Not Applicable. The anticipated required criteria for EPEAT 2018.

Regulatory compliance

The following table lists the regulatory compliance of your Precision 3680 Tower.

Table 23. Regulatory compliance

Regulatory compliance
Product Safety, EMC and Environmental Datasheets
Dell Regulatory Compliance Home page
Responsible Business Alliance Policy

Operating and storage environment

This table lists the operating and storage specifications of your Precision 3680 Tower.

Airborne contaminant level: G1 as defined by ISA-S71.04-1985

Table 24. Computer environment

Description	Operating	Storage
Temperature range	10°C-35°C (50°F-95°F)	-40°C-65°C (-40°F-149°F)

Table 24. Computer environment (continued)

Description	Operating	Storage
Relative humidity (maximum)	20% to 85% (non-condensing) (non-condensing, Max dew point temperature = 26°C)	0% to 95% (non-condensing) 5% to 95% (non-condensing, Max dew point temperature = 33°C)
Vibration (maximum)*	0.52 GRMS random at 5 Hz-350 Hz	2.0 GRMS random at 5 Hz-500 Hz
Shock (maximum)	40G Bottom half-sine pulse (2.5 ms)	105G half-sine pulse (2.5 ms)
Altitude range	-15.2 m to 3048 m (-49.86 ft to 10,000 ft)	-15.2 m to 10,668 m (-49.86 ft to 35,000 ft)
 CAUTION: Operating and storage temperature ranges may differ among components, so operating or storing the device outside these ranges may impact the performance of specific components.		

* Measured using a random vibration spectrum that simulates the user environment.

† Measured using a 2 ms half-sine pulse.

Dell support policy

For information about Dell support policy, search in the Knowledge Base Resource at [Dell Support Site](#).

Dell Optimizer

This section details the Dell Optimizer specifications of your Precision 3680 Tower.

On Precision 3680 Tower with Dell Optimizer, the following features are supported:











- **Express Connect**—Automatically joins the access point with the strongest signal, and directs bandwidth to conferencing applications when in use.
- **ExpressResponse**—Prioritizes the most important applications. Applications open faster and perform better.
- **AudioOptimization**—The audio feature enhances the audio functionality during your online meetings. The audio feature helps filter the background noise, stabilize volume, and prioritize preferred voice streaming during online meetings.

For more information about configuring and using these features, see [Dell Optimizer User Guide](#).

Working inside your computer

Safety instructions

Use the following safety guidelines to protect your computer from potential damage and to ensure your personal safety. Unless otherwise noted, each procedure in this document assumes that you have read the safety information that shipped with your computer.



-  **WARNING:** Before working inside your computer, read the safety information that is shipped with your computer. For more safety best practices, see [Dell Regulatory Compliance Home Page](#).
-  **WARNING:** Disconnect your computer from all power sources before opening the computer cover or panels. After you finish working inside the computer, replace all covers, panels, and screws before connecting your computer to an electrical outlet.
-  **CAUTION:** To avoid damaging the computer, ensure that the work surface is flat, dry, and clean.
-  **CAUTION:** To avoid damaging the components and cards, handle them by their edges, and avoid touching the pins and the contacts.
-  **CAUTION:** You should only perform troubleshooting and repairs as authorized or directed by the Dell technical support team. Damage due to servicing that is not authorized by Dell is not covered by your warranty. See the safety instructions that is shipped with the product or at [Dell Regulatory Compliance Home Page](#).
-  **CAUTION:** Before touching anything inside your computer, ground yourself by touching an unpainted metal surface, such as the metal at the back of the computer. While you work, periodically touch an unpainted metal surface to dissipate static electricity which could harm internal components.
-  **CAUTION:** When you disconnect a cable, pull it by its connector or its pull tab, not the cable itself. Some cables have connectors with locking tabs or thumbscrews that you must disengage before disconnecting the cable. When disconnecting cables, keep them evenly aligned to avoid bending the connector pins. When connecting cables, ensure that the connector on the cable is correctly oriented and aligned with the port.
-  **CAUTION:** Press and eject any installed card from the media-card reader.
-  **CAUTION:** Exercise caution when handling rechargeable Li-ion batteries in laptops. Swollen batteries should not be used and should be replaced and disposed properly.
-  **NOTE:** The color of your computer and certain components may differ from what is shown in this document.

Before working inside your computer

About this task

-  **NOTE:** The images in this document may differ from your computer depending on the configuration you ordered.

Steps

1. Save and close all open files and exit all open applications.
2. Shut down your computer. For Windows operating system, click **Start** >  **Power** > **Shut down**.
 -  **NOTE:** If you are using a different operating system, see the documentation of your operating system for shut-down instructions.

3. Disconnect your computer and all attached devices from their electrical outlets.
4. Disconnect all attached network devices and peripherals, such as keyboard, mouse, and monitor from your computer.

 **CAUTION: To disconnect a network cable, first unplug the cable from your computer and then unplug the cable from the network device.**

5. Remove any media card and optical disc from your computer, if applicable.

Safety precautions

The safety precautions section details the primary steps to be taken before performing any disassembly instructions.

Observe the following safety precautions before you perform any installation or break-fix procedures involving disassembly or reassembly:

- Turn off the computer and all attached peripherals.
- Disconnect the computer from AC power.
- Disconnect all network cables and peripherals from the computer.
- Use an ESD field service kit when working inside any to avoid electrostatic discharge (ESD) damage.
- After removing a computer component, carefully place the removed component on an anti-static mat.
- Wear shoes with non-conductive rubber soles to reduce the chance of getting electrocuted.
- Unplugging, pressing, and holding the power button for 15 seconds should discharge residual power in the system board.

Standby power

Dell products with standby power must be unplugged before you open the case. Systems equipped with standby power are powered while turned off. The internal power enables the computer to be remotely turned on (Wake-on-LAN) and suspended into a sleep mode and has other advanced power management features.

Bonding

Bonding is a method for connecting two or more grounding conductors to the same electrical potential. This is done by using a field service electrostatic discharge (ESD) kit. When connecting a bonding wire, ensure that it is connected to bare metal and never to a painted or nonmetal surface. Ensure that the wrist strap is secure and in full contact with your skin. Remove all jewelry such as watches, bracelets, or rings before to grounding yourself and the equipment.

Electrostatic discharge—ESD protection

ESD is a major concern when you handle electronic components, especially sensitive components such as expansion cards, processors, memory modules, and system boards. A slight charge can damage circuits in ways that may not be obvious, such as intermittent problems or a shortened product life span. As the industry pushes for lower power requirements and increased density, ESD protection is an increasing concern.

Due to the increased density of semiconductors used in recent Dell products, the sensitivity to static damage is now higher than in previous Dell products. For this reason, some previously approved methods of handling parts are no longer applicable.

Two recognized types of ESD damage are catastrophic and intermittent failures.

- **Catastrophic** – Catastrophic failures represent approximately 20 percent of ESD-related failures. The damage causes an immediate and complete loss of device functionality. An example of catastrophic failure is a memory module that has received a static shock and immediately generates a "No POST/No Video" symptom with a beep code that is emitted for missing or non-functional memory.
- **Intermittent** – Intermittent failures represent approximately 80 percent of ESD-related failures. The high rate of intermittent failures means that most of the time when damage occurs, it is not immediately recognizable. The memory module receives a static shock, but the tracing is merely weakened and does not immediately produce outward symptoms that are related to the damage. The weakened trace may take weeks or months to melt, and in the meantime may cause degradation of memory integrity, intermittent memory errors, and so on.

Intermittent failures also called latent or "walking wounded" are difficult to detect and troubleshoot.

Perform the following steps to prevent ESD damage:

- Use a wired ESD wrist strap that is properly grounded. Wireless anti-static straps do not provide adequate protection. Touching the chassis before handling parts does not ensure adequate ESD protection on parts with increased sensitivity to ESD damage.
- Handle all static-sensitive components in a static-safe area. If possible, use anti-static floor pads and workbench pads.
- When unpacking a static-sensitive component from its shipping carton, do not remove the component from the anti-static packing material until you are ready to install the component. Before unwrapping the anti-static packaging, use the anti-static wrist strap to discharge the static electricity from your body.
- Before transporting a static-sensitive component, place it in an anti-static container or packaging.

ESD Field Service kit

The unmonitored Field Service kit is the most commonly used service kit. Each Field Service kit includes three main components: anti-static mat, wrist strap, and bonding wire.

 **CAUTION: It is critical to keep ESD-sensitive devices away from internal parts that are insulators and often highly charged, such as plastic heat sink casings.**

Working Environment

Before deploying the ESD Field Service kit, assess the situation at the customer location. For example, deploying the kit for a server environment is different than for a desktop or laptop environment. Servers are typically installed in a rack within a data center; desktops or laptops are typically placed on office desks or cubicles. Always look for a large open flat work area that is free of clutter and large enough to deploy the ESD kit with additional space to accommodate the type of computer that is being repaired. The workspace should also be free of insulators that can cause an ESD event. On the work area, insulators such as Styrofoam and other plastics should always be moved at least 12 inches or 30 centimeters away from sensitive parts before physically handling any hardware components.

ESD Packaging

All ESD-sensitive devices must be shipped and received in static-safe packaging. Metal, static-shielded bags are preferred. However, you should always return the damaged part using the same ESD bag and packaging that the new part arrived in. The ESD bag should be folded over and taped shut and all the same foam packing material should be used in the original box that the new part arrived in. ESD-sensitive devices should be removed from packaging only at an ESD-protected work surface, and parts should never be placed on top of the ESD bag because only the inside of the bag is shielded. Always place parts in your hand, on the ESD mat, in the computer, or inside an anti-static bag.

Components of an ESD Field Service kit

The components of an ESD Field Service kit are:

- **Anti-Static Mat** – The anti-static mat is dissipative and parts can be placed on it during service procedures. When using an anti-static mat, your wrist strap should be snug and the bonding wire should be connected to the anti-static mat and to any bare metal on the computer being worked on. Once deployed properly, service parts can be removed from the ESD bag and placed directly on the anti-static mat. ESD-sensitive items are safe in your hand, on the anti-static mat, in the computer, or inside an ESD bag.
- **Wrist Strap and Bonding Wire** – The wrist strap and bonding wire can be either directly connected between your wrist and bare metal on the hardware if the ESD mat is not required, or connected to the anti-static mat to protect hardware that is temporarily placed on the mat. The physical connection of the wrist strap and bonding wire between your skin, the ESD mat, and the hardware is known as bonding. Use only Field Service kits with a wrist strap, anti-static mat, and bonding wire. Never use wireless wrist straps. Always be aware that the internal wires of a wrist strap are prone to damage from normal wear and tear, and must be checked regularly with a wrist strap tester in order to avoid accidental ESD hardware damage. It is recommended to test the wrist strap and bonding wire at least once per week.
- **ESD Wrist Strap Tester** – The wires inside an ESD strap are prone to damage over time. When using an unmonitored kit, it is a best practice to regularly test the strap prior to each service call, and at a minimum, test once per week. A wrist strap tester is the best method for doing this test. If you do not have your own wrist strap tester, check with your regional office to find out if they have one. To perform the test, plug the bonding-wire of the wrist-strap into the tester while it is strapped to your wrist and push the button to test. A green LED is lit if the test is successful; a red LED is lit and an alarm sounds if the test fails.

 **NOTE:** It is recommended to always use the traditional wired ESD grounding wrist strap and protective anti-static mat when servicing Dell products. In addition, it is critical to keep sensitive parts separate from all insulator parts while servicing the computer, and use anti-static bags for transporting sensitive components.

Transporting sensitive components

When transporting ESD sensitive components such as replacement parts or parts to be returned to Dell, it is critical to place these parts in anti-static bags for safe transport.

Lifting equipment

Adhere to the following guidelines when lifting heavy equipment:

 **CAUTION:** Do not lift greater than 50 pounds. Always obtain additional resources or use a mechanical lifting device.

1. Get a firm balanced footing. Keep your feet apart for a stable base, and point your toes out.
2. Tighten stomach muscles. Abdominal muscles support your spine when you lift, offsetting the force of the load.
3. Lift with your legs, not your back.
4. Keep the load close. The closer it is to your spine, the less force it exerts on your back.
5. Keep your back upright, whether lifting or setting down the load. Do not add the weight of your body to the load. Avoid twisting your body and back.
6. Follow the same technique in reverse to set the load down.

After working inside your computer

About this task

 **CAUTION:** Leaving stray or loose screws inside your computer may severely damage your computer.

Steps

1. Replace all screws and ensure that no stray screws remain inside your computer.
2. Connect any external devices, peripherals, or cables you removed before working on your computer.
3. Replace any media cards, discs, or any other parts that you removed before working on your computer.
4. Connect your computer and all attached devices to their electrical outlets.
5. Turn on your computer.

BitLocker

 **CAUTION:** If BitLocker is not suspended before updating the BIOS, the BitLocker key is not recognized the next time you reboot the computer. You will then be prompted to enter the recovery key to progress, and the system displays a prompt for the recovery key on each reboot. If the recovery key is not known, this can result in data loss or an operating system reinstall. For more information, see Knowledge Article: [updating the BIOS on Dell systems with BitLocker enabled](#).

The installation of the following components triggers BitLocker:

- Hard disk drive or solid-state drive
- System board

Recommended tools

The procedures in this document may require the following tools:

- Phillips screwdriver #0

- Phillips screwdriver #1
- Plastic scribe











Screw list

NOTE: When removing screws from a component, it is recommended to note the screw type and the quantity of screws, and then place them in a screw storage box. This is to ensure that the correct number of screws and correct screw type is restored when the component is replaced.

NOTE: Some computers have magnetic surfaces. Ensure that the screws are not left attached to such surfaces when replacing a component.

NOTE: Screw color may vary depending on the configuration ordered.

Table 25. Screw list

Component	Screw type	Quantity	Screw image
Side cover	Captive screw	1	
M.2 2230/2280 solid state drive	M2x3.5	1	
WLAN card	M2x3.5	1	
WLAN Internal antenna	M3x3	2	
Power supply unit cover	#6-32	2	
1000W Power supply unit	#6-32	4	
Processor fan and 125W heat-sink assembly	Captive screw	4	
Processor fan and 65W heat-sink assembly	Captive screw	4	
VR heat sink	Captive screw	2	
Front fan 1	M3x5	1	
Rear fan (1000W PSU)	M3x5	1	
System board	#6-32 M2	10 2	  

Major components of Precision 3680 Tower

The following image shows the major components of Precision 3680 Tower.

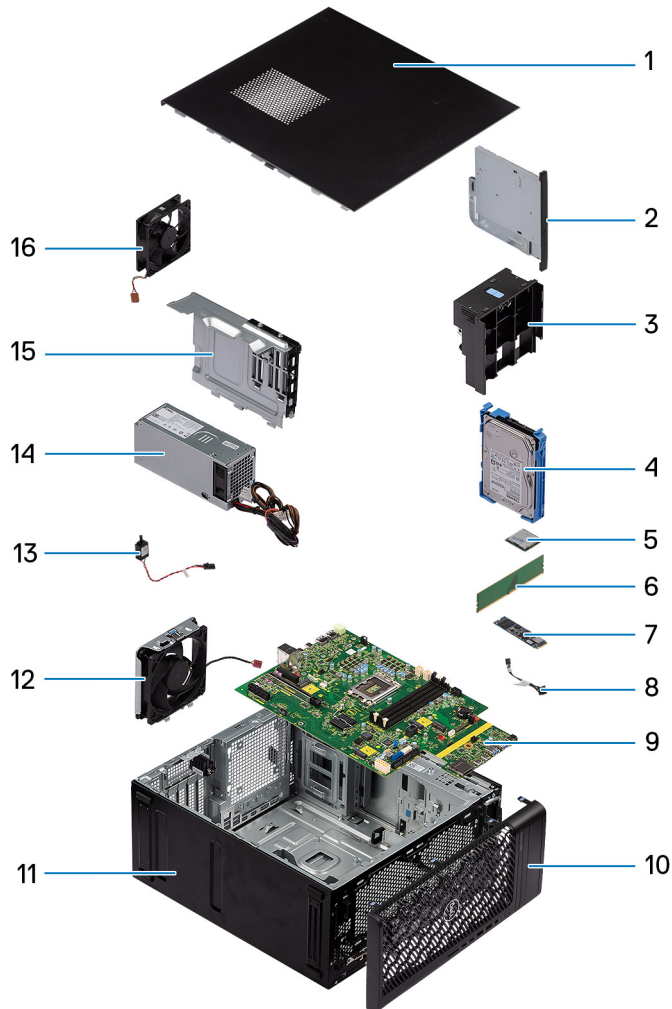

- | | |
|-------------------------------|------------------------|
| 1. Side cover | 2. Slim ODD |
| 3. GPU end holder | 4. 3.5-inch hard drive |
| 5. WLAN card | 6. Memory module |
| 7. M.2 2280 solid state drive | 8. Power button |
| 9. System board | 10. Front bezel |
| 11. System chassis | 12. Front system fan |
| 13. Intrusion switch | 14. Power supply unit |
| 15. Power supply unit cover | 16. Rear system fan |

NOTE: Dell provides a list of components and their part numbers for the original computer configuration purchased. These parts are available according to warranty coverages purchased by the customer. Contact your Dell sales representative for purchase options.

Removing and installing Customer Replaceable Units (CRUs)

The replaceable components in this chapter are Customer Replaceable Units (CRUs).

 **CAUTION:** Customers can replace only the Customer Replaceable Units (CRUs) following the safety precautions and replacement procedures.

 **NOTE:** The images in this document may differ from your computer depending on the configuration you ordered.

Side cover

Removing the side cover

Prerequisites

1. Follow the procedure in [before working inside your computer](#).

 **NOTE:** Ensure that you remove the security cable from the security-cable slot (if applicable).

About this task

The following images indicate the location of the side cover and provide a visual representation of the removal procedure.



1x

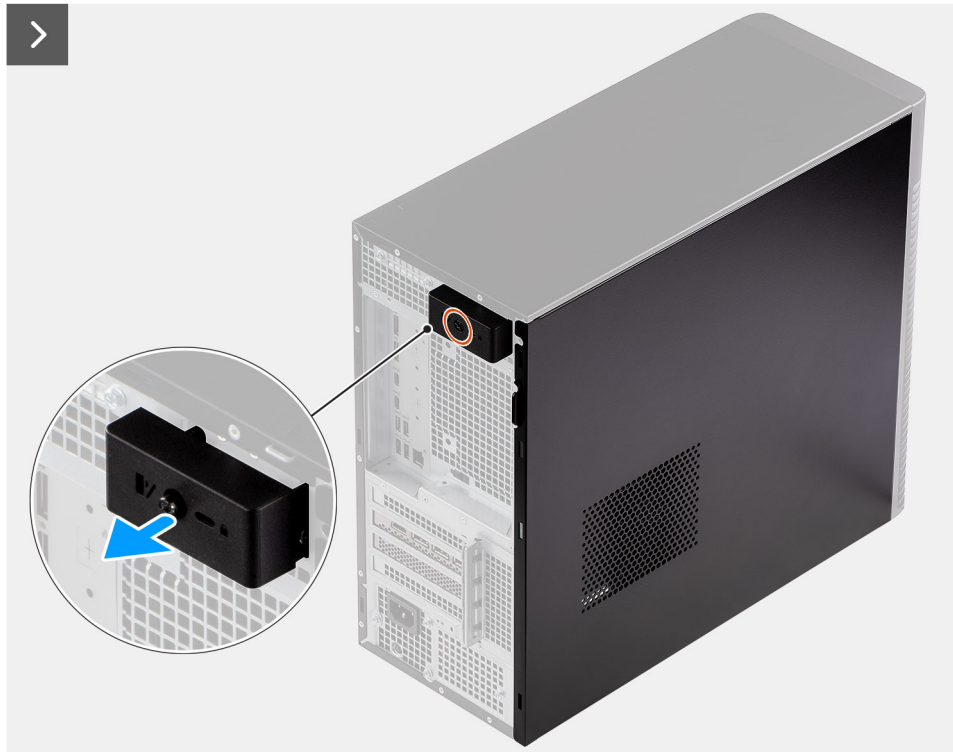

Figure 8. Removing the side cover



Figure 9. Removing the side cover

Steps

1. Loosen the single captive screw that secures the side cover to the computer.
2. Pull the release latch to release the cover from the computer.
3. Open the side cover towards the side of the computer and lift the cover away from the chassis.

Installing the side cover

Prerequisites

If you are replacing a component, remove the existing component before performing the installation procedure.

About this task

The following images indicate the location of the side cover and provide a visual representation of the installation procedure.



1x



Figure 10. Installing the side cover



Figure 11. Installing the side cover

Steps

1. Align the tabs on the side cover with the slots on the chassis.
2. Press the side cover towards the side of the computer to install it.
3. The release latch automatically locks the side cover to the computer.
4. Tighten the single captive screw to secure the side cover to the computer.

Next steps

1. Follow the procedure in [after working inside your computer](#).

Front bezel

Removing the front bezel

Prerequisites

1. Follow the procedure in [before working inside your computer](#).
2. Remove the [side cover](#).

About this task

The following images indicate the location of the front bezel and provide a visual representation of the removal procedure.

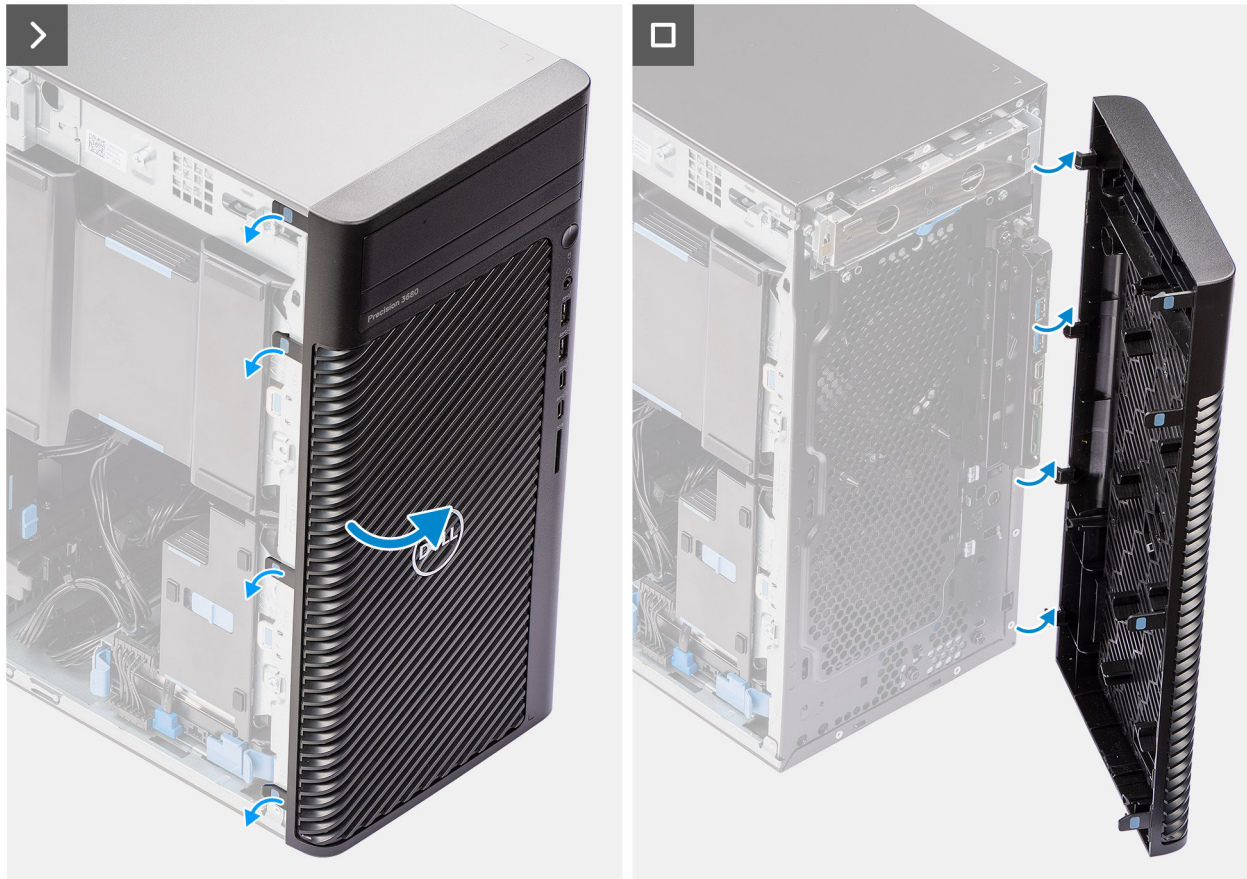
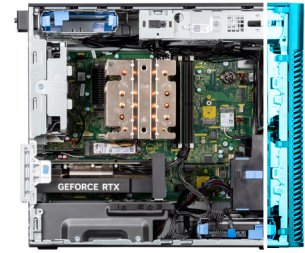

Figure 12. Removing the front bezel

Steps

1. Pry the retention tabs to release the front bezel from the computer.
2. Slightly pull the front bezel and gently rotate it to release the other tabs on the bezel from the slots in the computer chassis.
3. Remove the front bezel from the computer.

Installing the front bezel

Prerequisites

If you are replacing a component, remove the existing component before performing the installation procedure.

About this task

The following images indicate the location of the front bezel and provide a visual representation of the installation procedure.

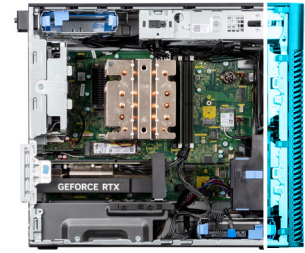

Figure 13. Installing the front bezel

Steps

1. Position the front bezel to align the tabs on the bezel with the slots on the chassis.
2. Press the bezel until the tabs click into place.

Next steps

1. Install the [side cover](#).
2. Follow the procedure in [after working inside your computer](#).

Air shroud

Removing the air shroud (1000W PSU)

Prerequisites

1. Follow the procedure in [before working inside your computer](#).
2. Remove the [side cover](#).

NOTE: Removing the air shroud disconnects the memory fan module as the memory fan module is integrated in the air shroud.

About this task

The following image indicates the location of the air shroud and provides a visual representation of the removal procedure.

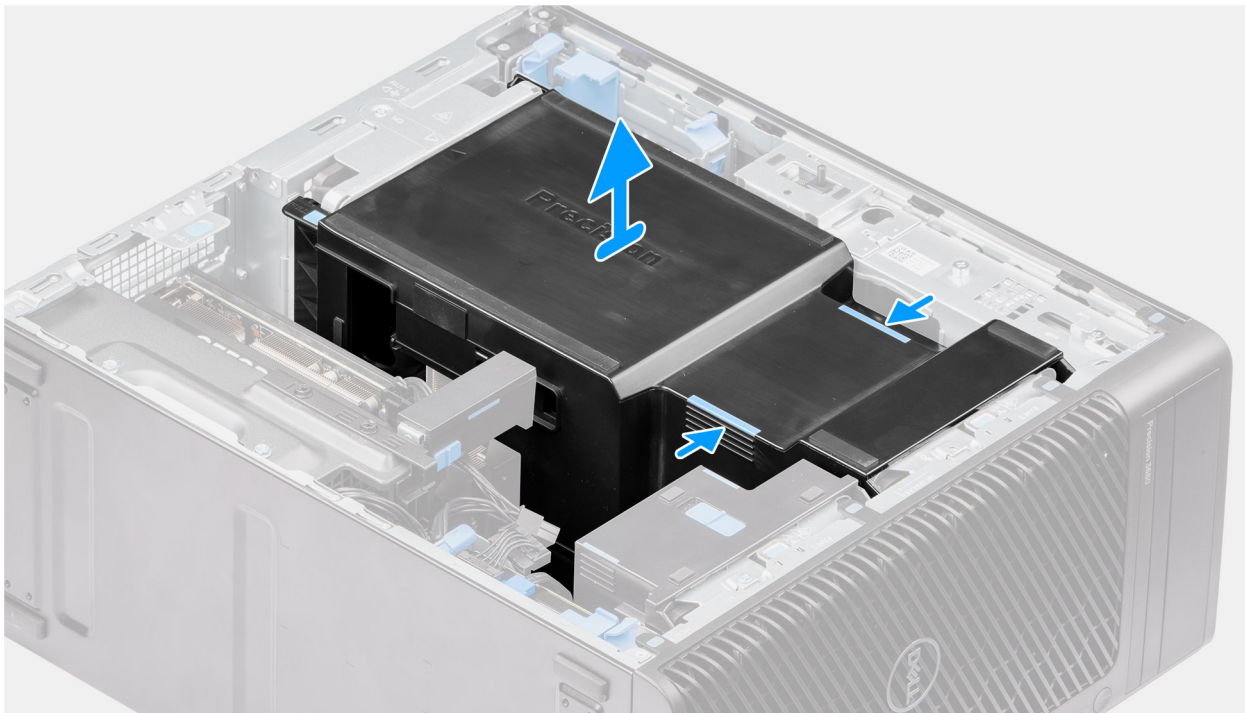

Figure 14. Removing the air shroud

Steps

1. Hold the air shroud at the gripping points.
2. Pull the air shroud upwards and out of the computer.

Installing the air shroud (1000W PSU)

Prerequisites

If you are replacing a component, remove the existing component before performing the installation procedure.

NOTE: Installing the air shroud connects the memory fan module, as the memory fan module is integrated to the air shroud.

NOTE: Route all the power cables through the bottom air shroud cover to prevent the air shroud installation interference.

About this task

The following image indicates the location of the air shroud and provides a visual representation of the installation procedure.

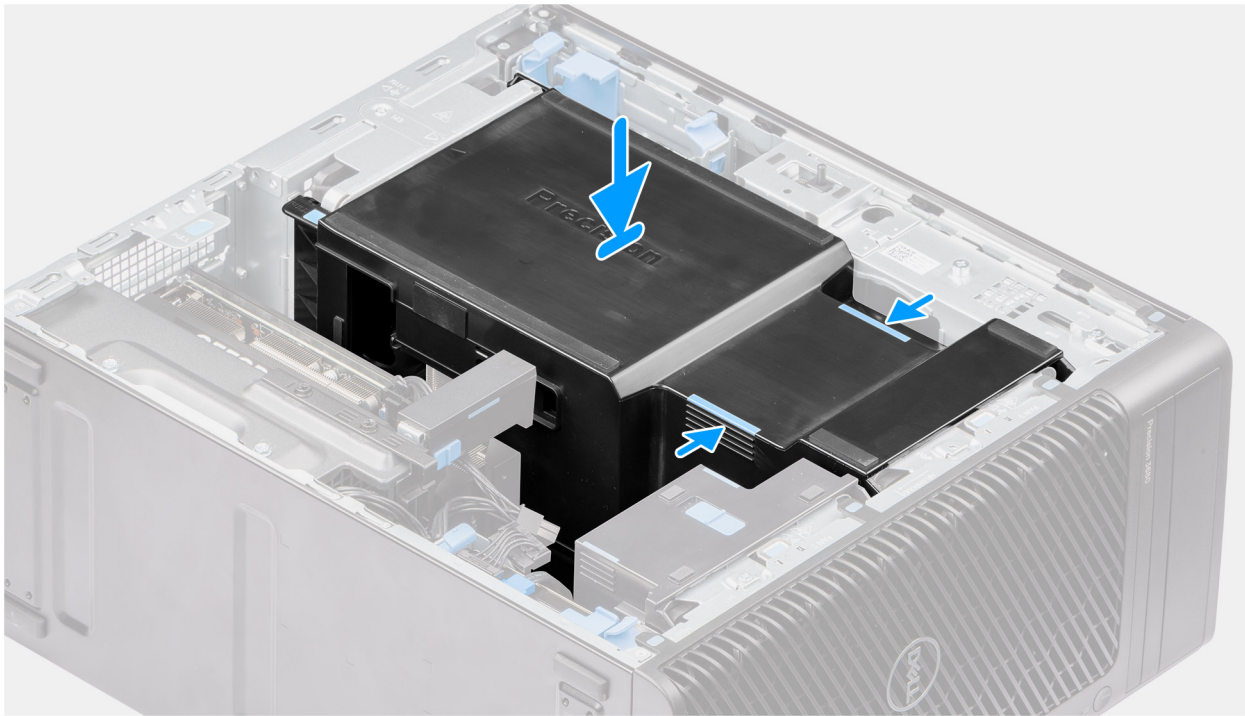

Figure 15. Installing the air shroud

Steps

1. Align the air shroud over the heat-sink and system board holding and place it in the slot.
2. Press the air shroud down until the tabs secure into place.

Next steps

1. Install the [side cover](#).
2. Follow the procedure in [after working inside your computer](#).

3.5-inch hard-drive assembly

Removing the 3.5-inch hard drive assembly (Bay-1)

Prerequisites

1. Follow the procedure in [before working inside your computer](#).
2. Remove the [side cover](#).
3. Remove the [front bezel](#).

About this task

The following images indicate the location of the 3.5-inch hard drive assembly and provide a visual representation of the removal procedure.

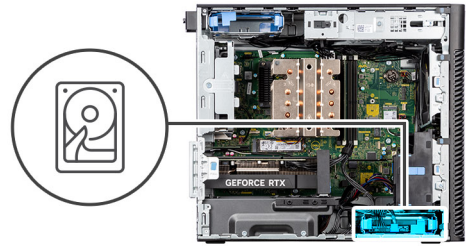

Figure 16. Removing the 3.5-inch hard drive assembly from Bay 1

Steps

1. Disconnect the data and power cables from the 3.5-inch hard drive module.
2. Press the securing tabs to release the hard drive assembly from the chassis.
3. Slide the hard drive assembly away from the chassis.

Removing the 3.5-inch hard drive assembly (Bay-2)

Prerequisites

1. Follow the procedure in [before working inside your computer](#).
2. Remove the [side cover](#).
3. Remove the [front bezel](#).

About this task

The following images indicate the location of the 3.5-inch hard drive assembly (Bay-2) and provide a visual representation of the removal procedure.

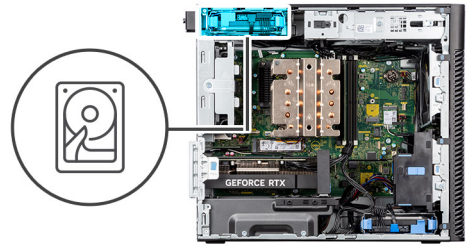

Figure 17. Removing the 3.5-inch hard drive assembly (Bay-2)

Steps

1. Disconnect the data and power cables from the 3.5-inch hard drive module.
2. Press the securing tabs to release the hard drive assembly from the chassis.
3. Slide the hard drive assembly away from the chassis.

Removing the 3.5-inch hard drive bracket

Prerequisites

1. Follow the procedure in [before working inside your computer](#).
2. Remove the [side cover](#).
3. Remove the [3.5-inch hard drive assembly \(Bay-1\)](#).

About this task

The following images indicate the location of the 3.5-inch hard drive bracket and provide a visual representation of the removal procedure.

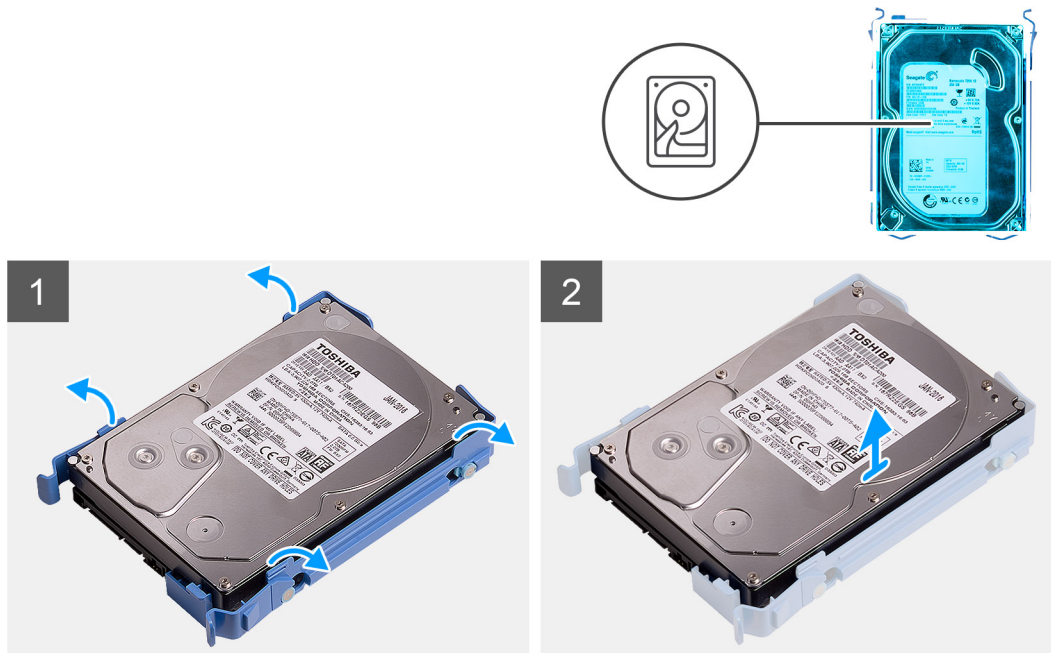

Figure 18. Removing the 3.5-inch hard-disk drive bracket

Steps

1. Pry both sides of the hard drive bracket edge to release the tabs on the bracket from the slots on the hard drive.
2. Lift and remove the hard drive off the hard drive bracket.

Installing the 3.5-inch hard drive bracket

Prerequisites

If you are replacing a component, remove the existing component before performing the installation procedure.

About this task

The following images indicate the location of the 3.5-inch hard drive bracket and provide a visual representation of the installation procedure.

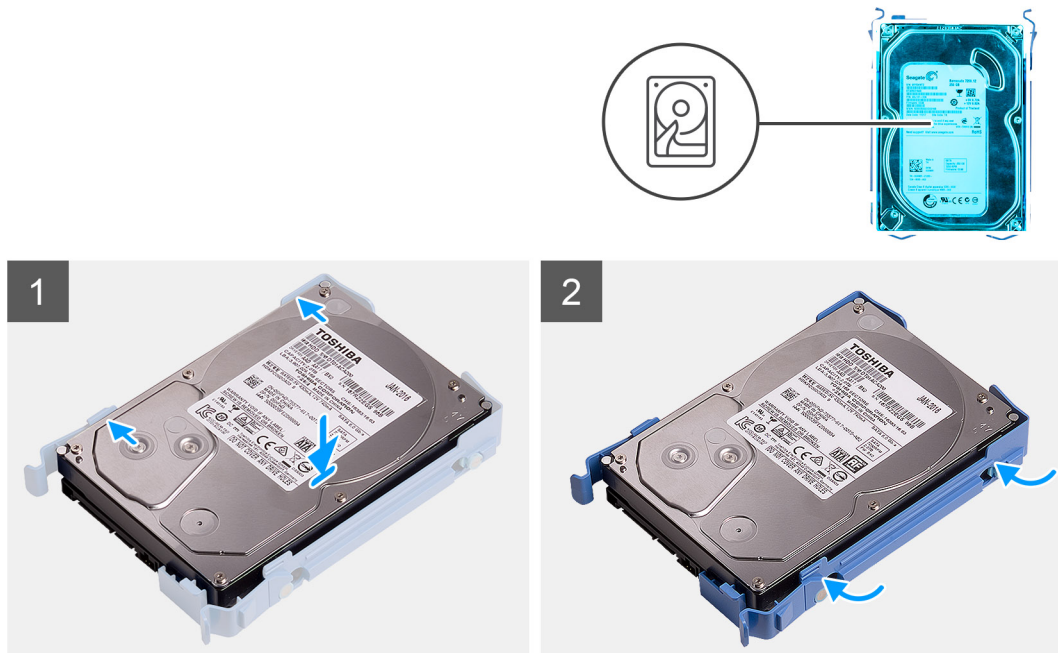

Figure 19. Installing the 3.5-inch hard drive bracket

Steps

1. Place the hard drive into the hard drive bracket and align the tabs on the bracket with the slots on the hard drive.
2. Snap the hard drive into the hard drive bracket.

Next steps

1. Install the [3.5-inch hard drive assembly \(Bay-1\)](#).
2. Install the [side cover](#).
3. Follow the procedure in [after working inside your computer](#).

Installing the 3.5-inch hard drive assembly (Bay-2)

Prerequisites

If you are replacing a component, remove the existing component before performing the installation procedure.

About this task

The following images indicate the location of the 3.5-inch hard drive assembly (Bay-2) and provide a visual representation of the installation procedure.

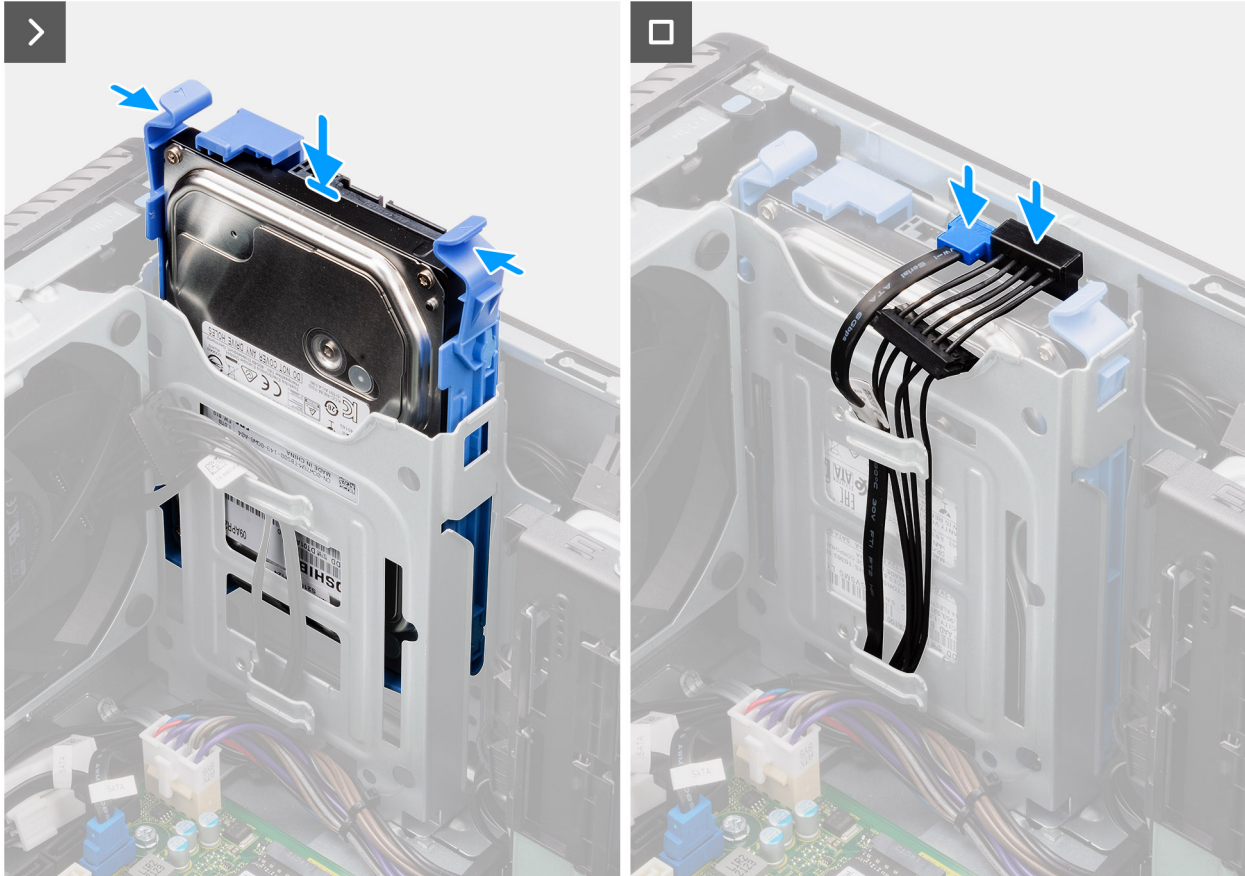
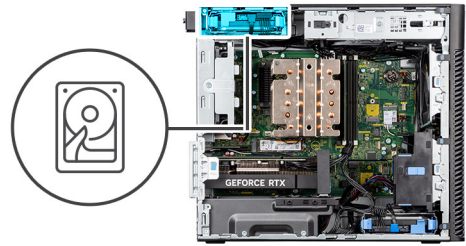

Figure 20. Installing the 3.5-inch hard drive assembly (Bay-2)

Steps

1. Slide and insert the 3.5-inch hard drive assembly into the hard drive slot.
2. Route the power cable and the data cable through the routing guides on the hard drive assembly and connect the cables to the hard drive.

Next steps

1. Install the [front bezel](#).
2. Install the [side cover](#).
3. Follow the procedure in [after working inside your computer](#).

Installing the 3.5-inch hard drive assembly (Bay-1)

Prerequisites

If you are replacing a component, remove the existing component before performing the installation procedure.

About this task

The following images indicate the location of the 3.5-inch hard drive assembly and provide a visual representation of the installation procedure.

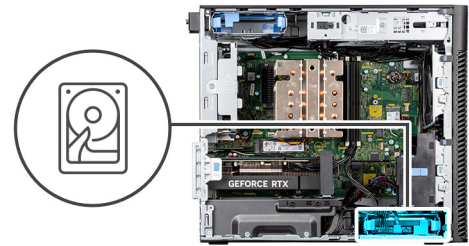

Figure 21. Installing the 3.5-inch hard drive assembly from Bay 1

Steps

1. Slide and insert the 3.5-inch hard drive assembly into the hard drive slot.
2. Route the power cable and the data cable through the routing guides on the hard drive assembly and connect the cables to the hard drive.

Next steps

1. Install the [front bezel](#).
2. Install the [side cover](#).
3. Follow the procedure in [after working inside your computer](#).

Solid state drive

Removing the M.2 2230 PCIe solid state drive

Prerequisites

1. Follow the procedure in [before working inside your computer](#).
2. Remove the [side cover](#).
3. Remove the [air shroud](#).

NOTE: For systems with 1000W PSU only.

About this task

The following images indicate the location of the solid state drive (slot 2) and provide a visual representation of the removal procedure.

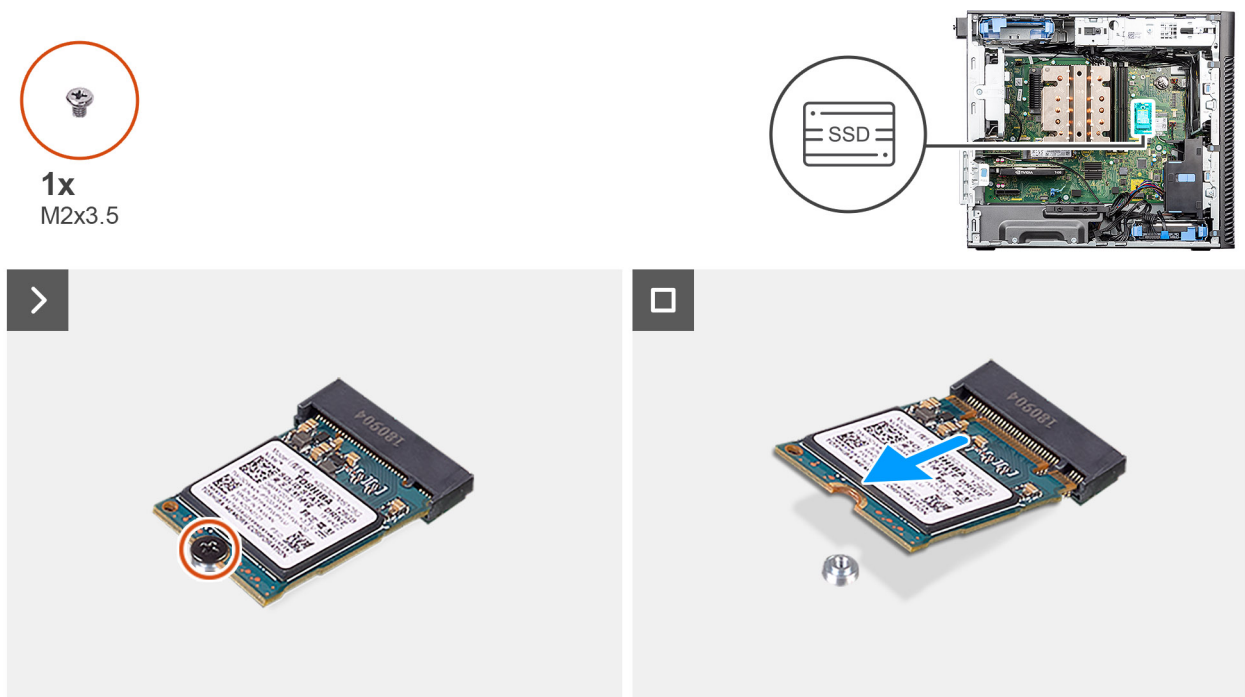

Figure 22. Removing the M.2 2230 PCIe solid state drive

Steps

1. Remove the screw (M2x3.5) that secures the solid state drive to the system board.
2. Slide and lift the solid state drive off the system board.

Installing the M.2 2230 PCIe solid state drive

Prerequisites

If you are replacing a component, remove the existing component before performing the installation procedure.

About this task

The following images indicate the location of the solid state drive (slot 2) and provide a visual representation of the installation procedure.



1x
M2x3.5

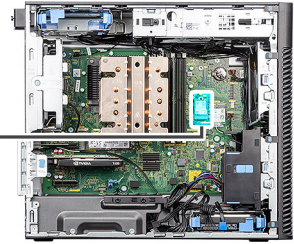

Figure 23. Installing the M.2 2230 PCIe solid state drive

Steps

1. Align the notch on the solid state drive with the tab on the solid state drive connector.
2. Insert the solid state drive at a 45-degree angle into the slot on the system board.
 - i** **NOTE:** When replacing a M.2 2280 solid state drive from a M.2 2230 solid state drive, ensure to move the standoff nut to the M.2 2230 solid state drive slot position.
3. Replace the screw (M2x3.5) to secure the M.2 2230 solid state drive to the system board.

Next steps

1. Install the [air shroud](#).
 - i** **NOTE:** For systems with 1000W PSU only.
2. Install the [side cover](#).
3. Follow the procedure in [after working inside your computer](#).

Removing the M.2 2280 PCIe solid state drive

Prerequisites

1. Follow the procedure in [before working inside your computer](#).
2. Remove the [side cover](#).
3. Remove the [air shroud](#).
 - i** **NOTE:** For systems with 1000W PSU only.

About this task

The following images indicate the location of the solid state drive (Slots 1, 2, and 3) and provide a visual representation of the removal procedure.



1x
M2x3.5

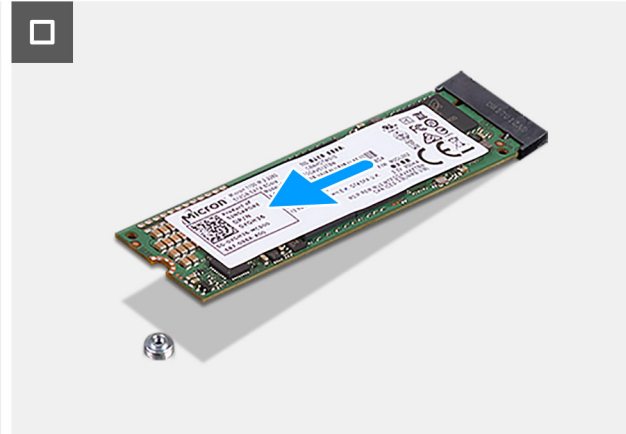
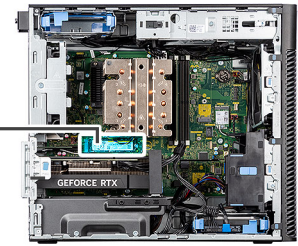

Figure 24. Removing the M.2 2280 PCIe solid state drive

Steps

1. Remove the screw (M2x3.5) that secures the solid state drive to the system board.
2. Slide and lift the solid state drive off the system board.

(i) NOTE: Repeat the above procedure for removing the other solid state drive.

Installing the M.2 2280 PCIe solid state drive

Prerequisites

If you are replacing a component, remove the existing component before performing the installation procedure.

About this task

The following images indicate the location of the solid state drive (Slots 1, 2, and 3) and provide a visual representation of the installation procedure.



1x
M2x3.5

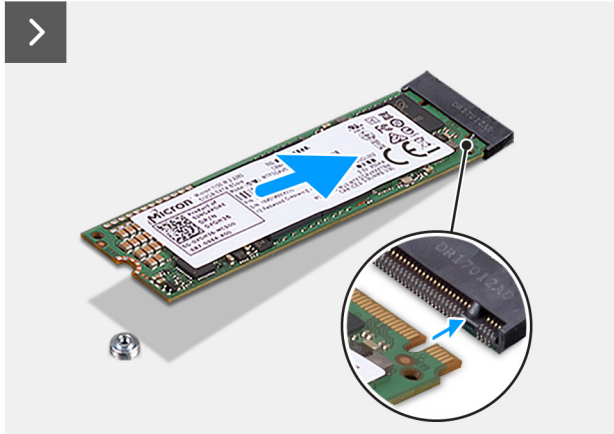
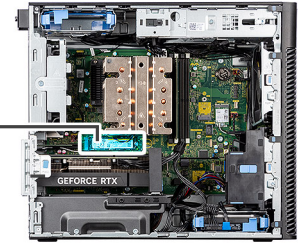

Figure 25. Installing the M.2 2280 PCIe solid state drive

Steps

1. Align the notch on the solid state drive with the tab on the solid state drive connector.
2. Insert the solid state drive at a 45-degree angle into the slot on the system board.
i **NOTE:** When replacing a M.2 2230 solid state drive with a M.2 2280 solid state drive, ensure to move the standoff nut to the M.2 2280 solid state drive slot position.
3. Replace the screw (M2x3.5) to secure the M.2 2280 solid state drive to the system board.
i **NOTE:** Repeat the above procedure for installing the other solid state drive.

Next steps

1. Install the [air shroud](#)
i **NOTE:** For systems with 1000W PSU only.
2. Install the [side cover](#).
3. Follow the procedure in [after working inside your computer](#).

WLAN card

Removing the WLAN card

Prerequisites

1. Follow the procedure in [before working inside your computer](#).
2. Remove the [side cover](#).
3. Remove the [air shroud](#).
i **NOTE:** For systems with 1000W PSU only.

About this task

The following images indicate the location of the wireless card and provide a visual representation of the removal procedure.

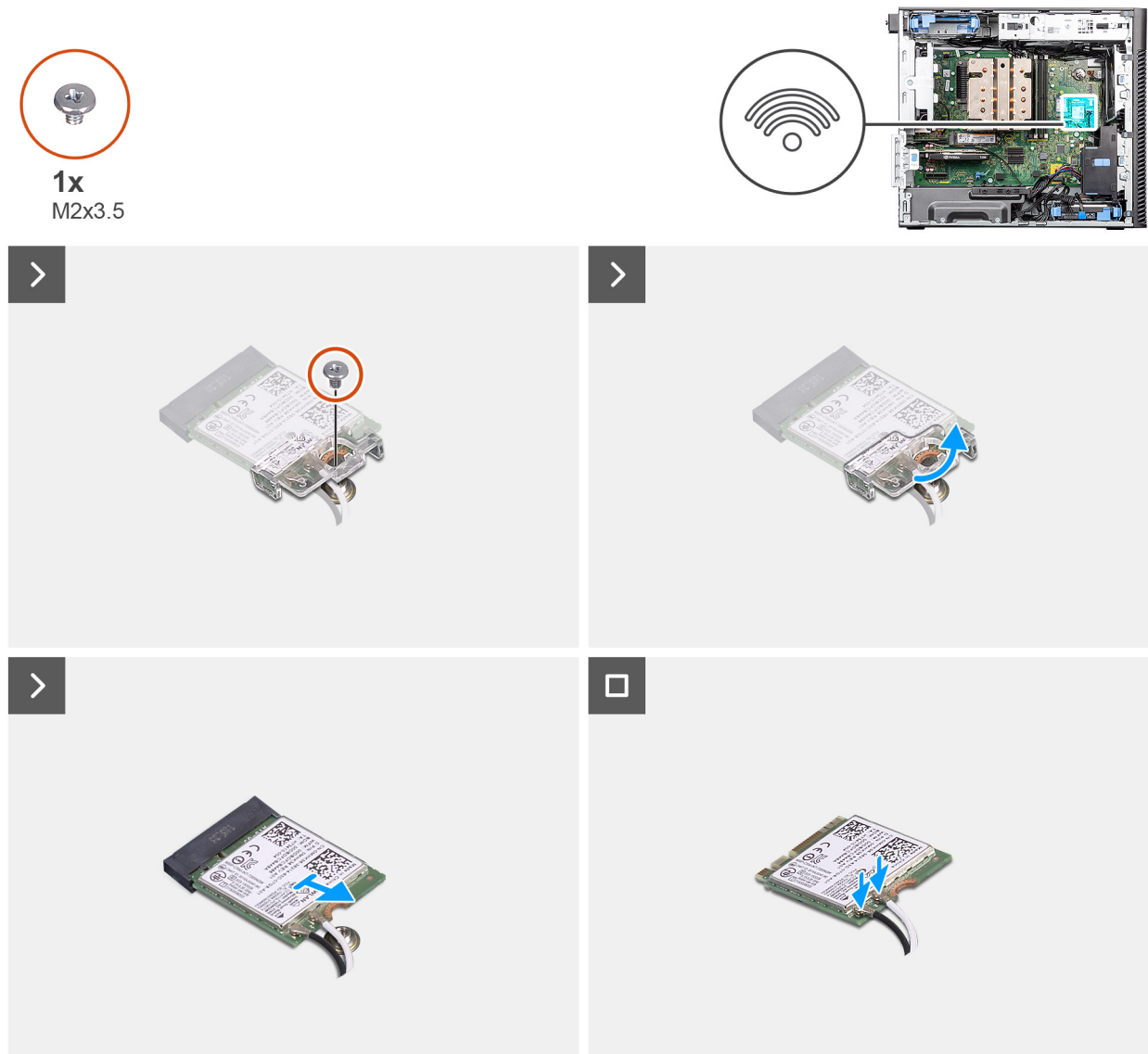

Figure 26. Removing the WLAN card

Steps

1. Remove the (M2x3.5) screw that secures the WLAN card to the system board.
2. Lift the WLAN card bracket away from the WLAN card.
3. Slide and remove the WLAN card from the connector on the system board.
4. Disconnect the antenna cables from the WLAN card.

Installing the WLAN card

Prerequisites

If you are replacing a component, remove the existing component before performing the installation procedure.

About this task

The following images indicate the location of the wireless card and provide a visual representation of the installation procedure.



1x
M2x3.5

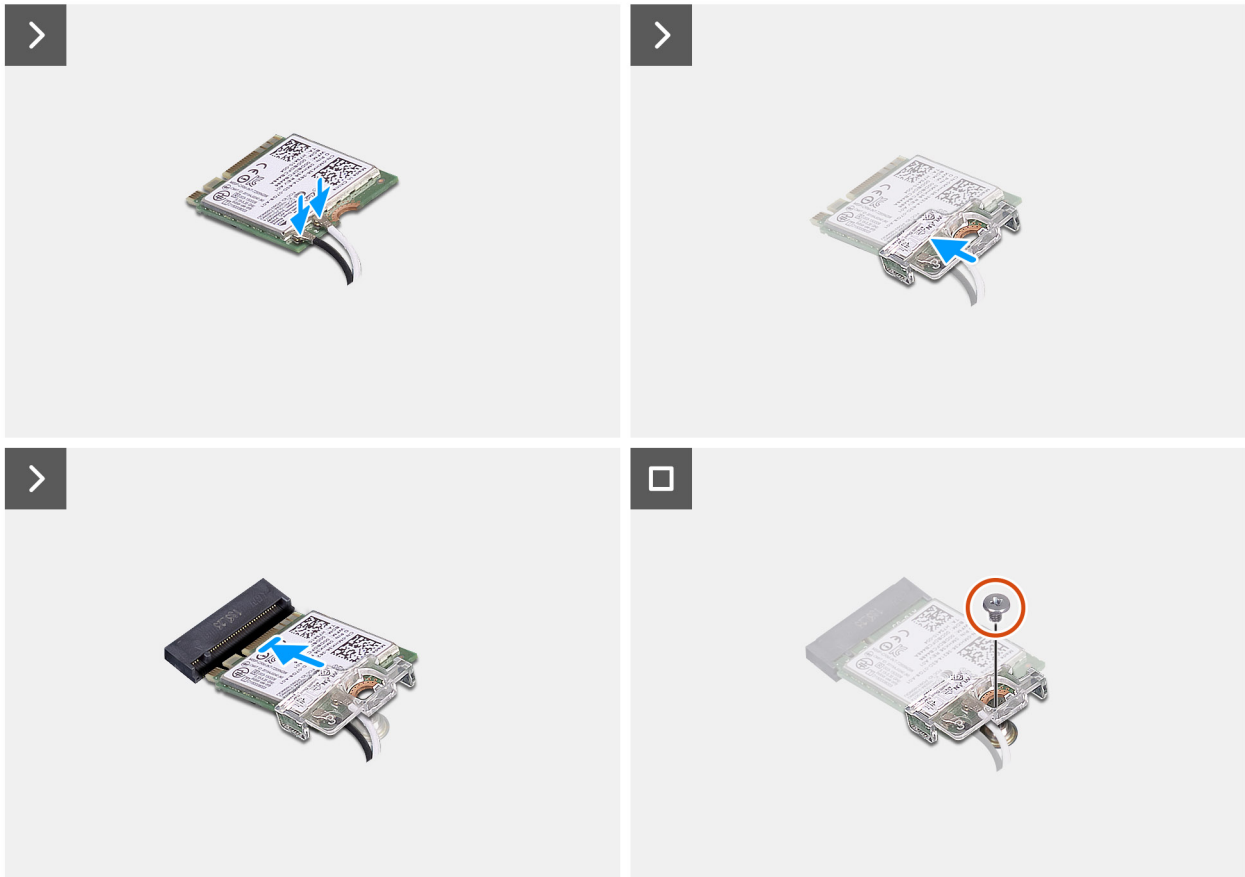
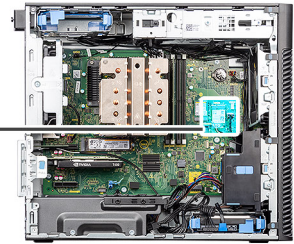

Figure 27. Installing the WLAN card

Steps

1. Connect the antenna cables to the WLAN card.
The following table provides the antenna-cable color scheme for the WLAN card of your computer.

Table 26. Antenna-cable color scheme

Connectors on the wireless card	Antenna-cable color
Main (white triangle)	White
Auxiliary (black triangle)	Black

2. Place the WLAN card bracket to secure the WLAN antenna cables.
3. Insert the WLAN card into the connector on the system board.
4. Replace the (M2x3.5) screw to secure the plastic tab to the WLAN card.

Next steps

1. Install the [air shroud](#).
 **NOTE:** For systems with 1000W PSU only.

2. Install the [side cover](#).
3. Follow the procedure in [after working inside your computer](#).

Removing the WLAN internal antenna

Prerequisites

1. Follow the procedure in [before working inside your computer](#).
2. Remove the [side cover](#).
3. Remove the [front bezel](#).
4. Remove the [air shroud](#).

NOTE: For systems with 1000W PSU only.

5. Remove the [WLAN card](#).

About this task

The following images indicate the location of the WLAN antenna module and provide a visual representation of the removal procedure.



2x
M3x3

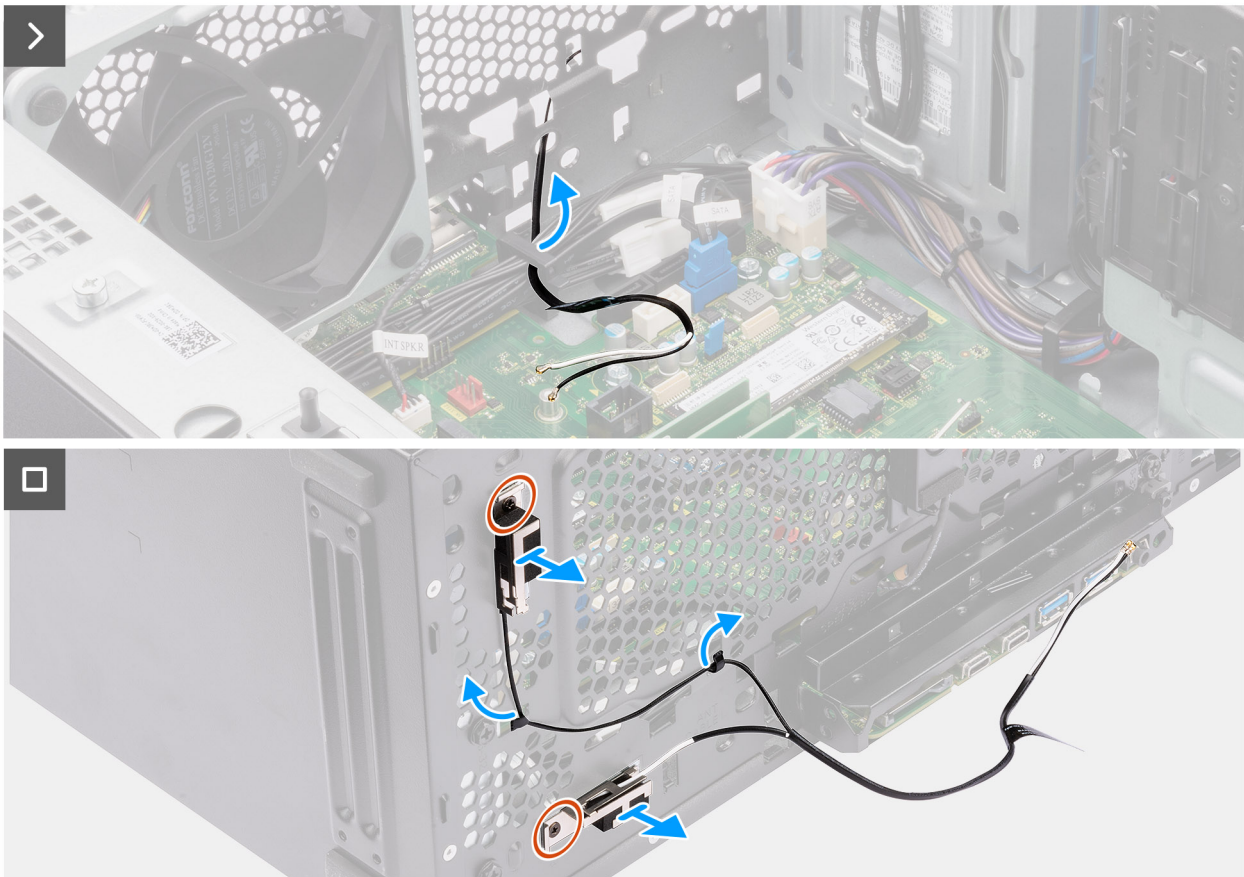

Figure 28. Removing the WLAN internal antenna

Steps

1. Remove the antenna cables from the routing guides on the chassis.
2. Unroute the antenna cables through the recess on the front of the chassis.
3. Remove the two (M3x3) screws that secure the WLAN antenna to the chassis.
4. Lift the WLAN antenna off the chassis.

Installing the WLAN internal antenna

Prerequisites

If you are replacing a component, remove the existing component before performing the installation procedure.

About this task

The following images indicate the location of the WLAN internal antenna and provide a visual representation of the installation procedure.



2x
M3x3

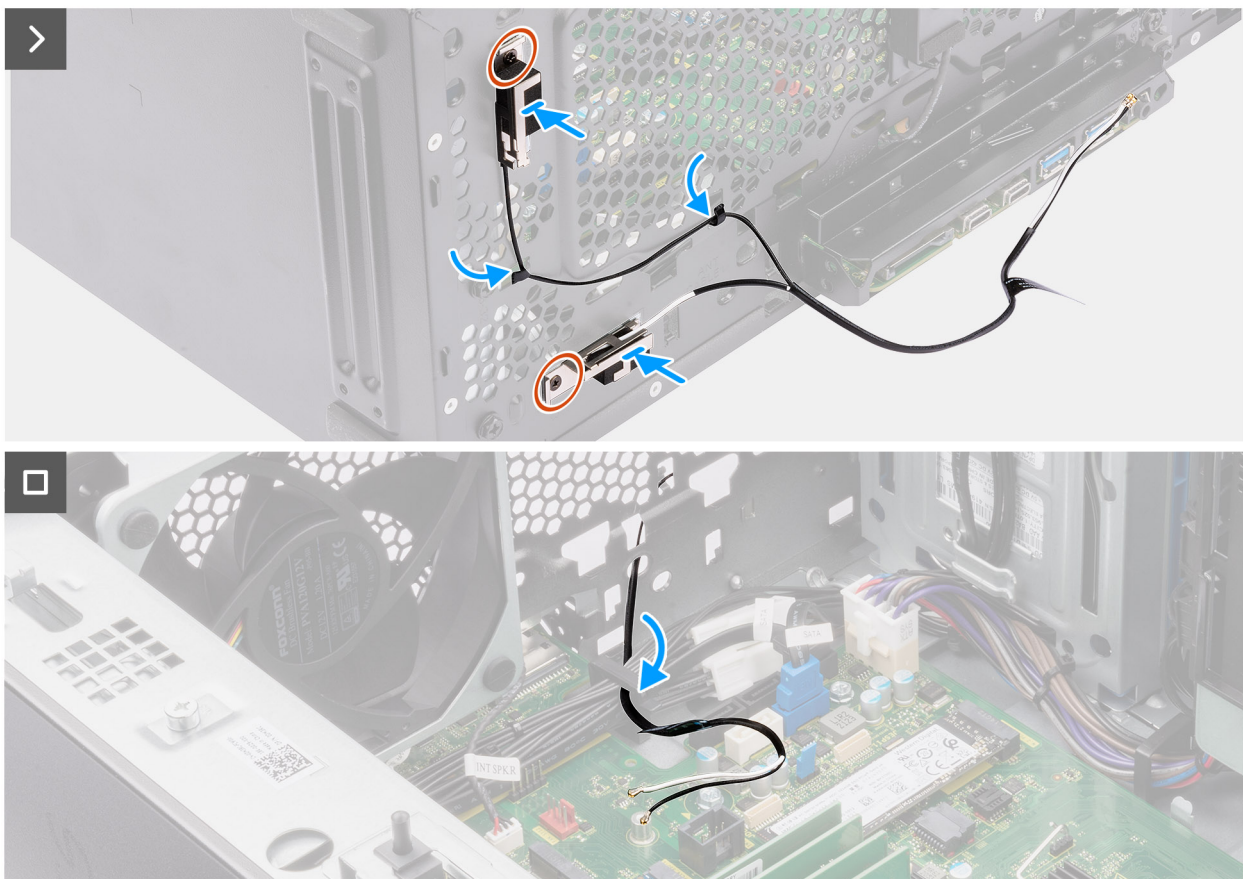

Figure 29. Installing the WLAN internal antenna

Steps

1. Route the antenna cables through the routing guides on the chassis.

2. Align and place the screw holes on the WLAN antenna with the screw holes on the chassis.
i **NOTE:** When replacing the WLAN antenna, ensure to remove the Mylar tape on the WLAN antenna base.
3. Replace the two screws (M3x3) to secure the WLAN antenna to the chassis.

Next steps

1. Install the [WLAN card](#).
2. Install the [air shroud](#).
i **NOTE:** For systems with 1000W PSU only.
3. Install the [front bezel](#).
4. Install the [side cover](#).
5. Follow the procedure in [after working inside your computer](#).

Coin-cell battery

Removing the coin-cell battery

Prerequisites

1. Follow the procedure in [before working inside your computer](#).
2. Remove the [side cover](#).
3. Remove the [air shroud](#).

i **NOTE:** For systems with 1000W PSU only.

About this task

The following images indicate the location of the coin-cell battery and provide a visual representation of the removal procedure.

⚠ CAUTION: Removing the coin-cell battery clears the CMOS and resets BIOS settings.

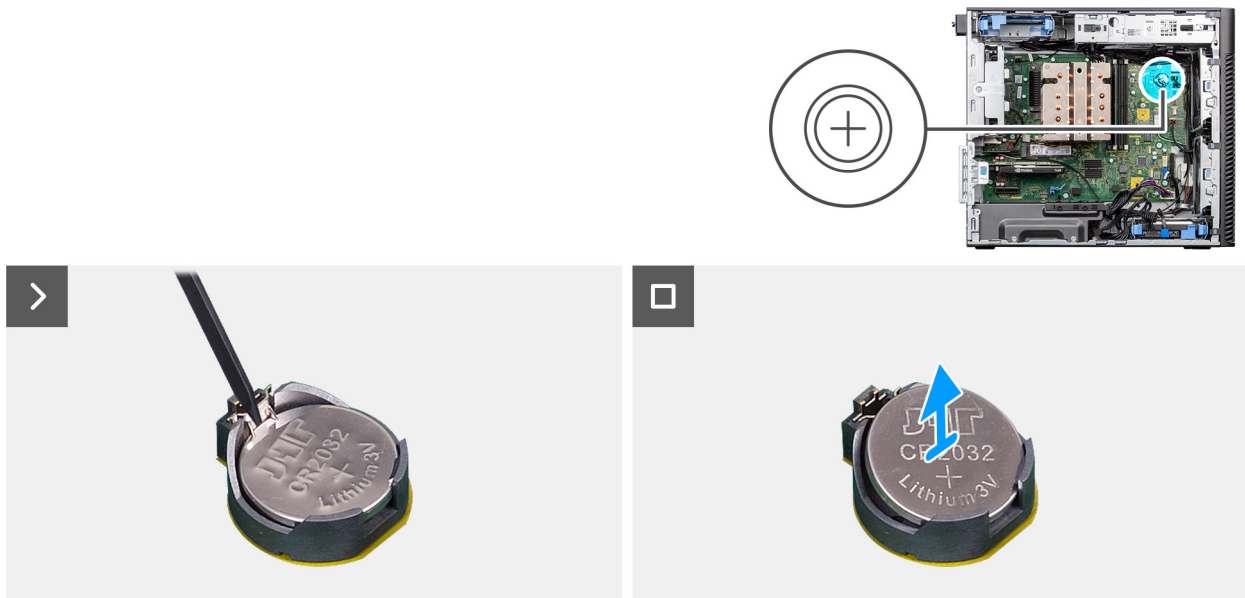

Figure 30. Removing the coin-cell battery

Steps

1. Using a plastic scribe, gently pry the coin-cell battery out of the slot on the system board.
2. Remove the coin-cell battery away from the computer.

Installing the coin-cell battery

Prerequisites

If you are replacing a component, remove the existing component before performing the installation procedure.

About this task

The following images indicate the location of the coin-cell battery and provide a visual representation of the installation procedure.

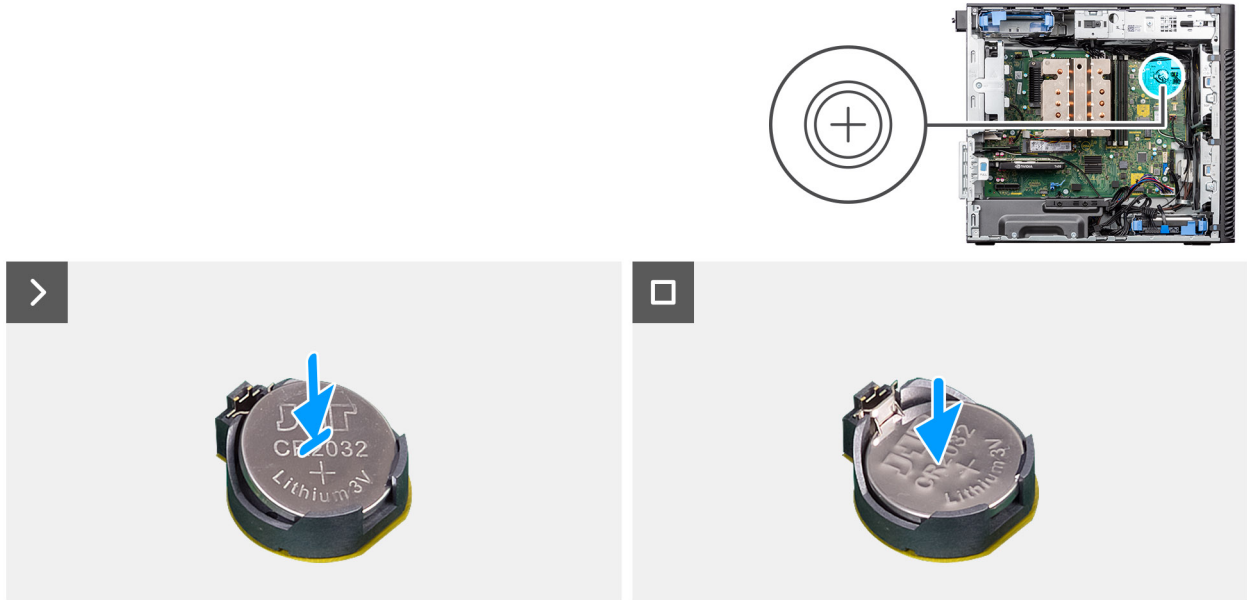

Figure 31. Installing the coin-cell battery

Steps

1. Insert the coin-cell battery with the "+" sign facing up and slide it under the securing tabs at the positive side of the connector.
2. Press the battery into the connector until it locks into place.

Next steps

1. Install the [air shroud](#).
- i** **NOTE:** For systems with 1000W PSU only.
2. Install the [side cover](#).
3. Follow the procedure in [after working inside your computer](#).

Memory module

Removing the memory module

Prerequisites

1. Follow the procedure in [before working inside your computer](#).
2. Remove the [side cover](#).
3. Remove the [air shroud](#).
- i** **NOTE:** For systems with 1000W PSU only.

About this task

The following image indicates the location of the memory module and provides a visual representation of the removal procedure.

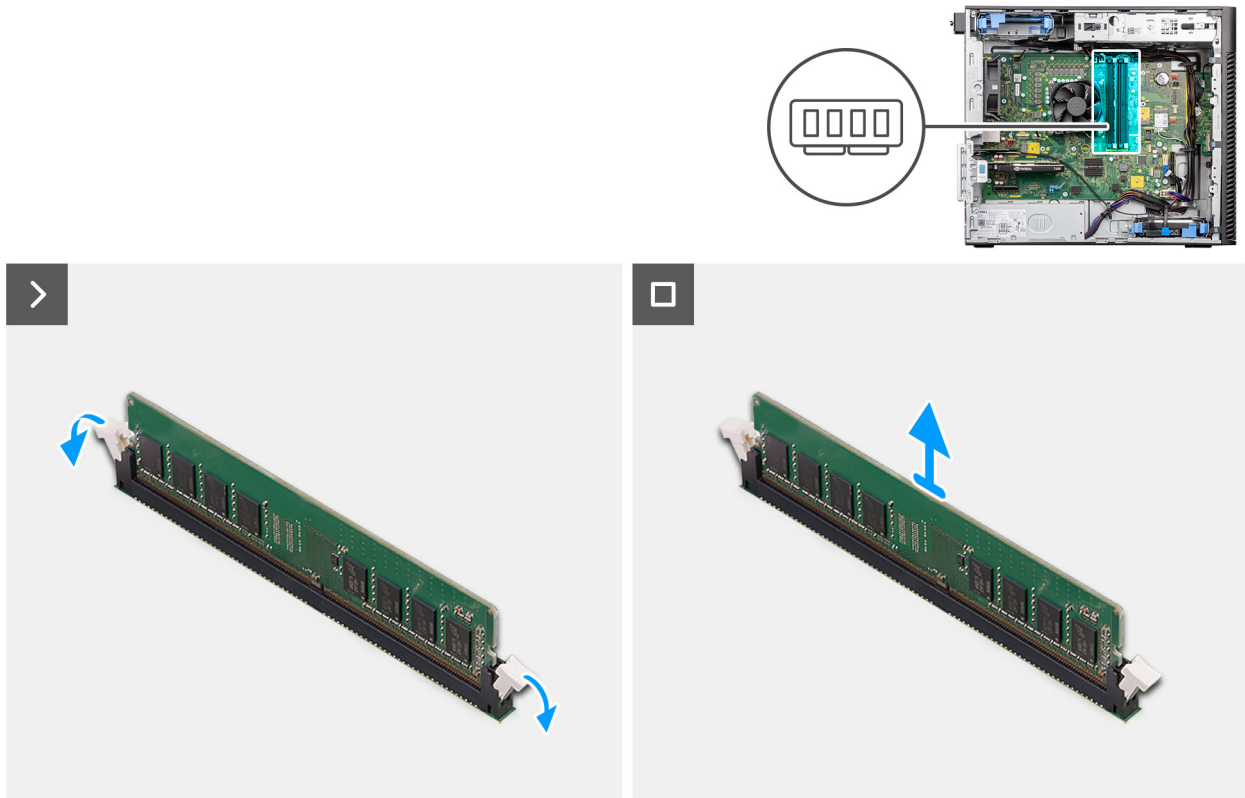

Figure 32. Removing the memory module

Steps

1. Pull the securing clips from both sides of the memory module until the memory module pops up.
2. Slide and remove the memory module from the memory-module slot.

CAUTION: To prevent damage to the memory module, hold the memory module by the edges. Do not touch the components or metallic contacts on the memory module as electrostatic discharge(ESD) can inflict severe damage on the components. To read more about ESD protection, see [ESD protection](#).

Installing the memory module

Prerequisites

If you are replacing a component, remove the existing component before performing the installation procedure.

About this task

The following image indicates the location of the memory module and provides a visual representation of the installation procedure.

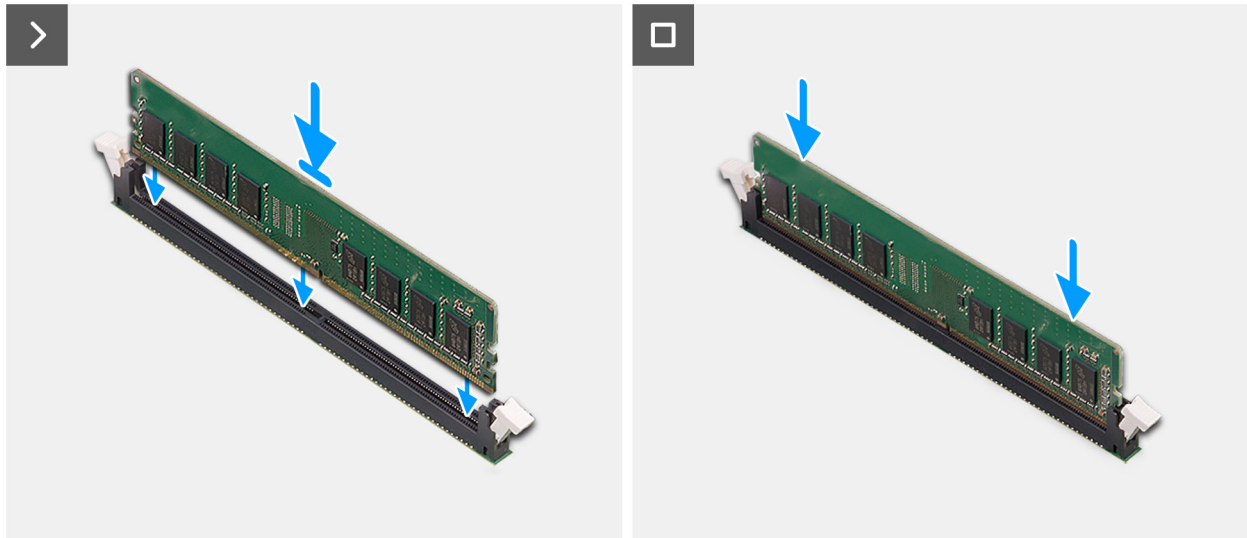
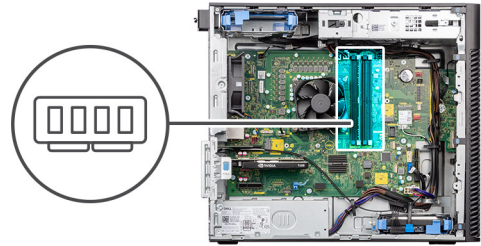

Figure 33. Installing the memory module

Steps

1. Align the notch on the memory module with the tab on the memory-module slot.
2. Slide the memory module firmly into the slot at an angle and press the memory module down until it secures into place.

NOTE: If the memory module is not secure, then remove the memory module and reinstall it.

CAUTION: To prevent damage to the memory module, hold the memory module by the edges. Do not touch the components or metallic contacts on the memory module as electrostatic discharge (ESD) can inflict severe damage on the components. To read more about ESD protection, see [ESD protection](#).

Next steps

1. Install the [air shroud](#).
2. Install the [side cover](#).
3. Follow the procedure in [after working inside your computer](#).

GPU end holder

Removing GPU end holder

Prerequisites

1. Follow the procedure in [before working inside your computer](#).
2. Remove the [side cover](#).

NOTE: The GPU end holder is an optional component that comes with certain discrete GPU configurations. It does not come with integrated GPU configurations.

About this task

The following images indicate the location of the GPU end holder and provide a visual representation of the removal procedure.

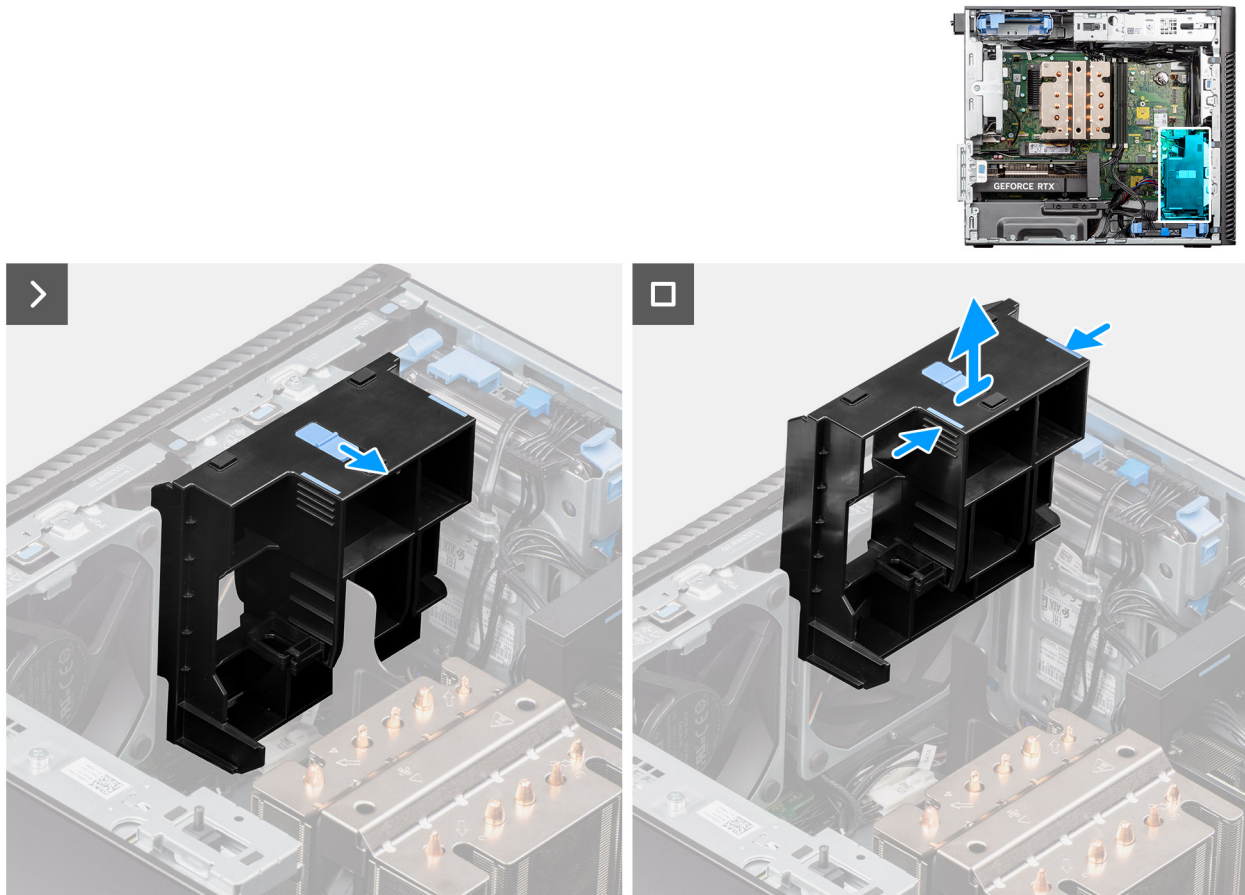

Figure 34. Removing the GPU end holder

Steps

1. Slide the latch to unlock position on the GPU end holder.
2. Press the retention tabs on both sides of the GPU end holder to release it.
3. Lift and remove the GPU end holder from the computer.

Installing the GPU end holder

Prerequisites

If you are replacing a component, remove the existing component before performing the installation procedure.

About this task

The following images indicate the location of the GPU end holder and provide a visual representation of the installation procedure.

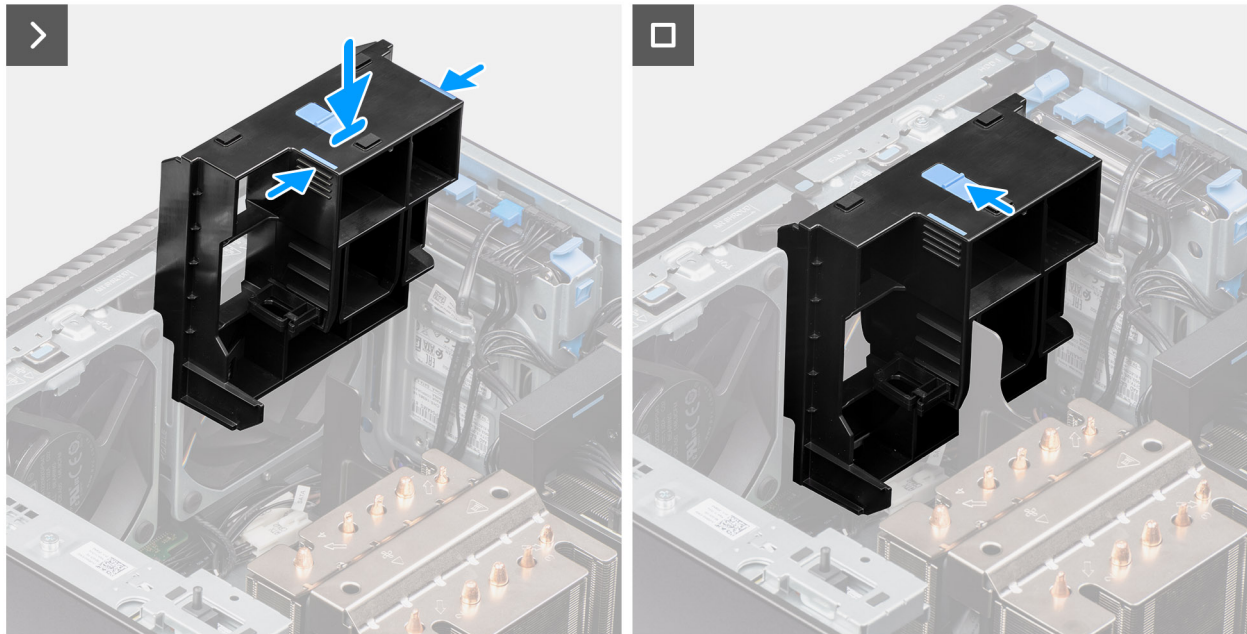
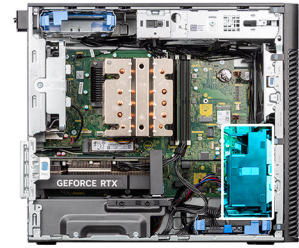

Figure 35. Installing the GPU end holder

Steps

1. Position the GPU end holder to align it with the slots on the computer chassis.
2. Press the GPU end holder down until it secures into place.
3. Slide the latch to lock position on the GPU end holder.

Next steps

1. Install the [side cover](#).
2. Follow the procedure in [after working inside your computer](#).

Expansion card

Removing the PCIe external antenna

Prerequisites

1. Follow the procedure in [before working inside your computer](#).
2. Remove the [side cover](#).

About this task

The following images indicate the location of the PCIe external antenna and provide a visual representation of the removal procedure.

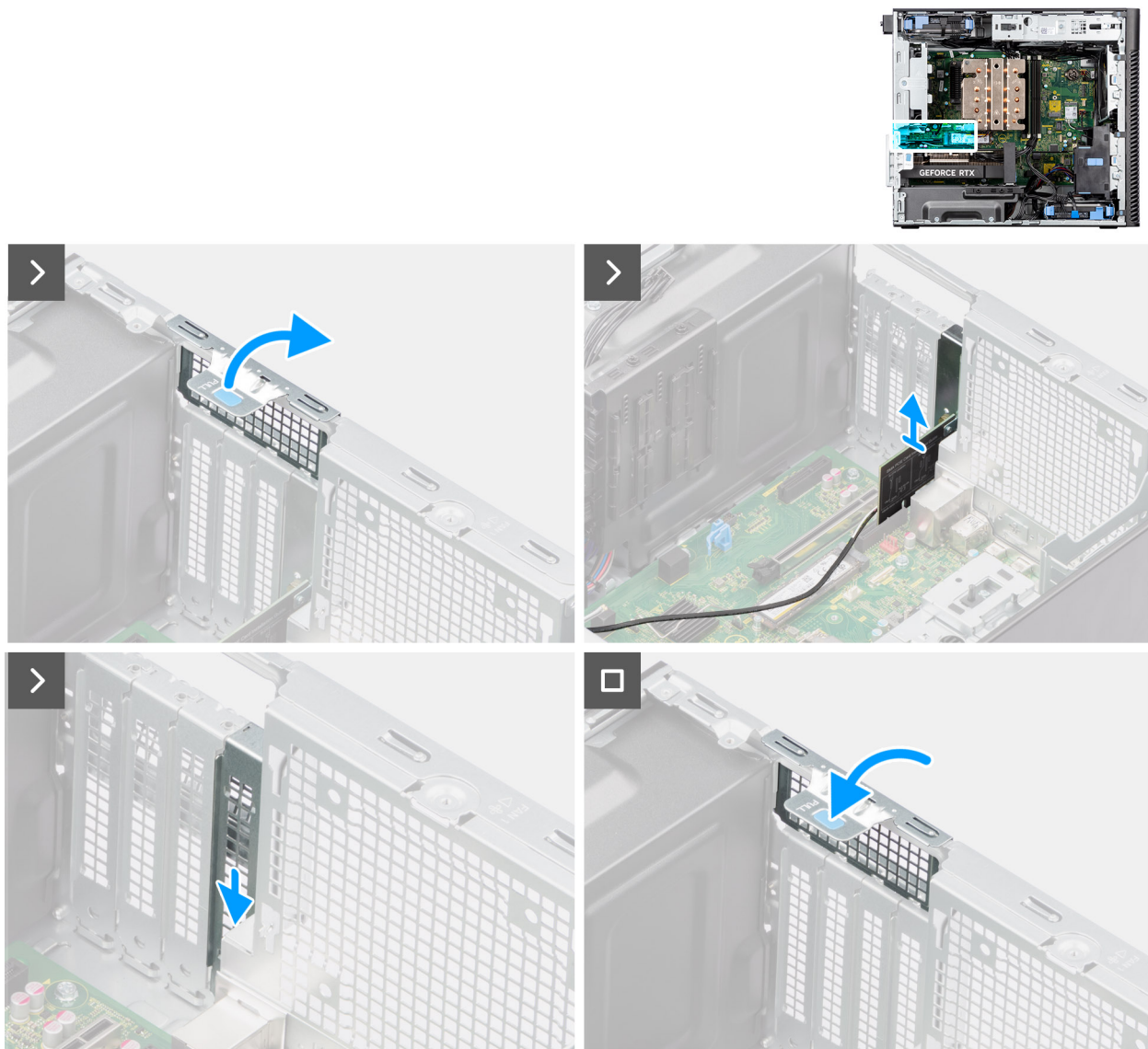

Figure 36. Removing the PCIe external antenna

Steps

1. Lift the pull tab to open the PCIe door.
2. Lift the PCIe card from its slot.
3. Insert the blank filler.
4. Lift the pull tab to close the PCIe door.

Installing the PCIe external antenna

Prerequisites

If you are replacing a component, remove the existing component before performing the installation procedure.

About this task

The following images indicate the location of the PCIe external antenna and provide a visual representation of the installation procedure.

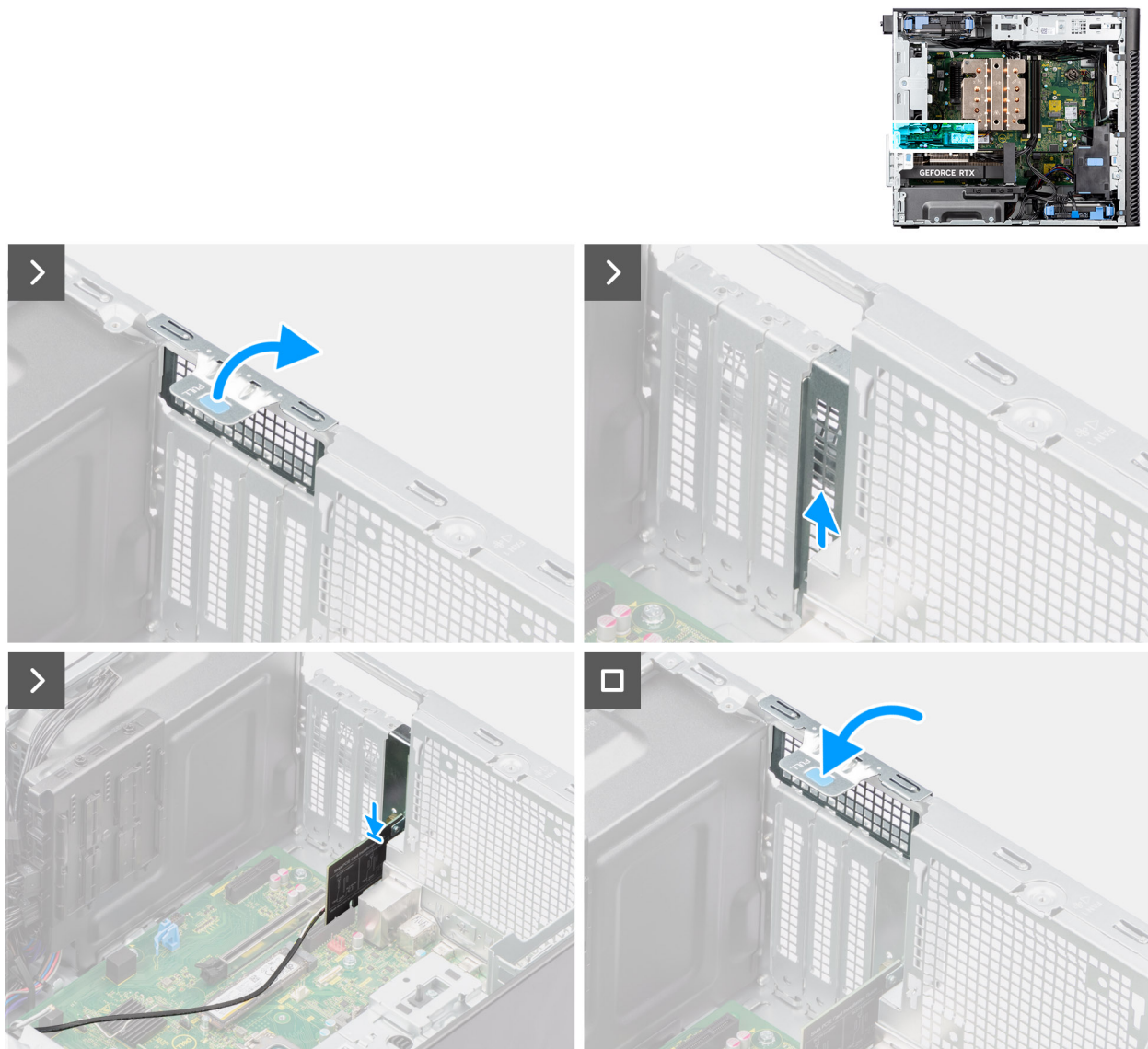

Figure 37. Installing the PCIe external antenna

Steps

1. Remove the blank filler.
2. Align the PCIe external antenna card with the PCI-express card connector on the system board.
3. Using the alignment post, connect the PCIe external antenna card to the connector and press down firmly. Ensure that the card is firmly seated.
4. Lift the pull tab to close the PCIe door.

Next steps

1. Install the [side cover](#).
2. Follow the procedure in [after working inside your computer](#).

Removing the graphics card

Prerequisites

1. Follow the procedure in [before working inside your computer](#).
2. Remove the [side cover](#).

About this task

The following images indicate the location of the graphics card and provide a visual representation of the removal procedure.

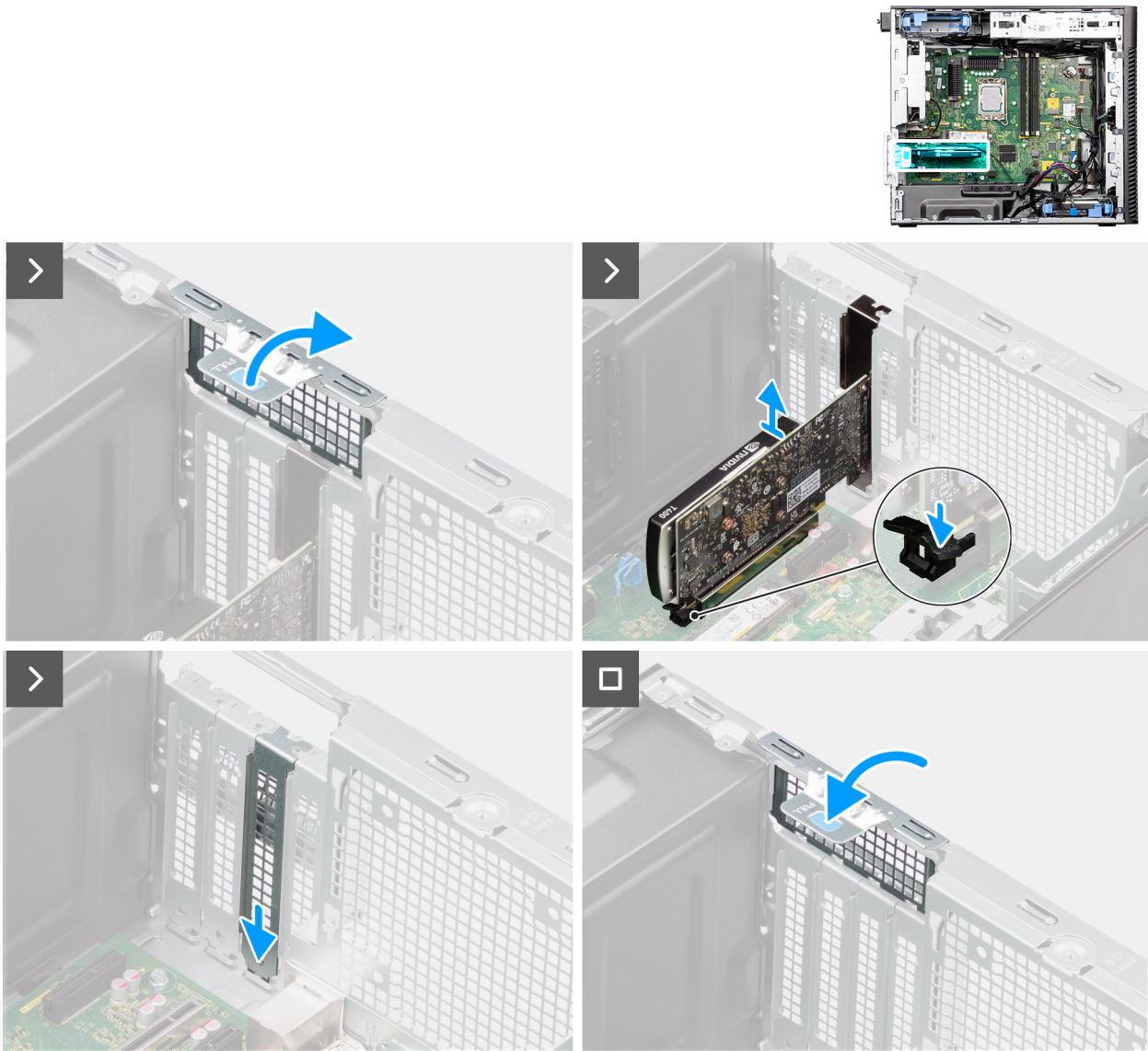

Figure 38. Removing the graphics card

Steps

1. Lift the pull tab to open the PCIe door.
2. Push and hold the securing tab on the graphics-card slot and lift the graphics card from the graphics-card slot.
3. Insert the blank filler.
4. Lift the pull tab to close the PCIe door.

Installing the graphics card

Prerequisites

If you are replacing a component, remove the existing component before performing the installation procedure.

About this task

The following images indicate the location of the graphics card and provide a visual representation of the installation procedure.

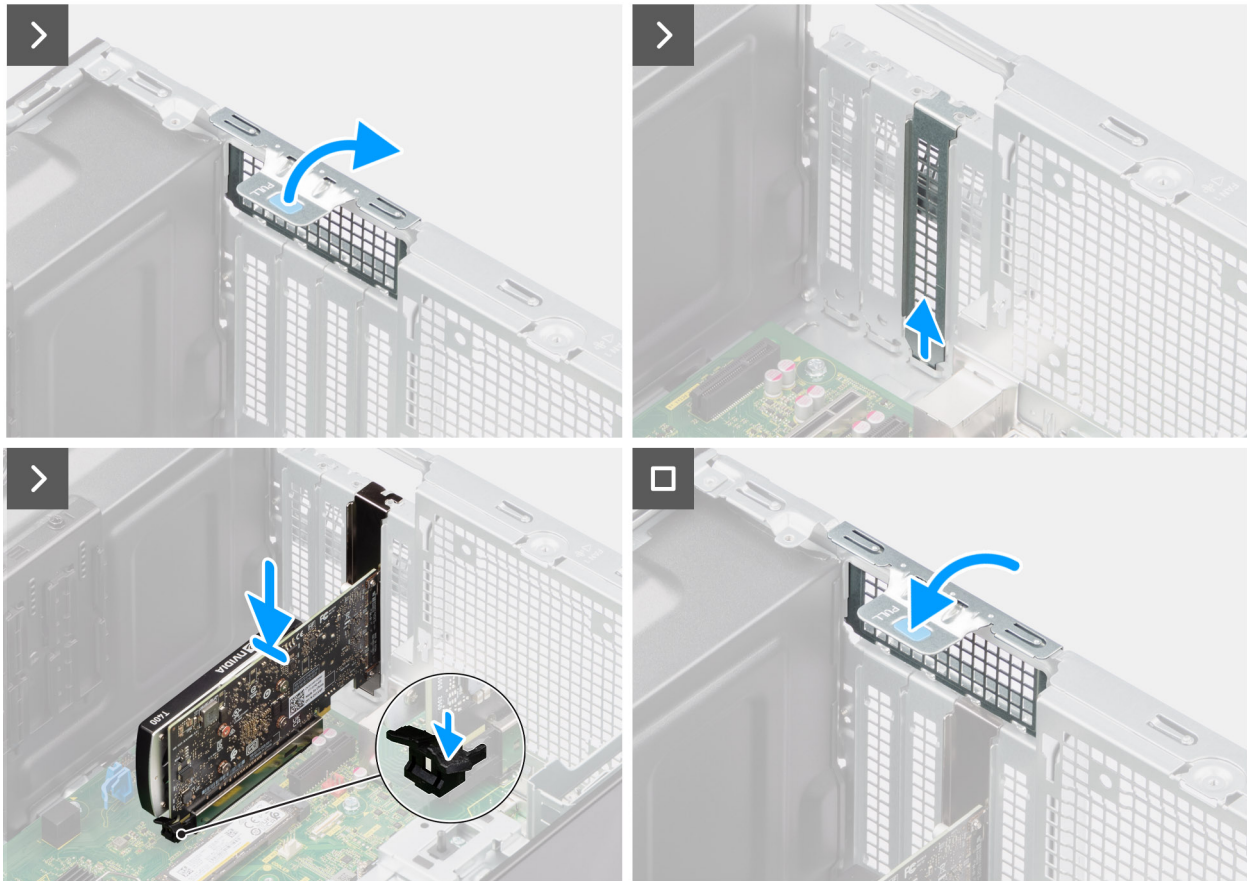

Figure 39. Installing the graphics card

Steps

1. Lift the pull tab to open the PCIe door.
2. Remove the blank filler.
3. Align the graphics card with the PCI-express card connector on the system board.
4. Using the alignment post, connect the graphics card to the connector and press down firmly. Ensure that the card is firmly seated.
5. Lift the pull tab to close the PCIe door.

Next steps

1. Install the [side cover](#).
2. Follow the procedure in [after working inside your computer](#).

Removing the powered GPU

Prerequisites

1. Follow the procedure in [before working inside your computer](#).

2. Remove the [side cover](#).
3. Remove the [GPU end holder](#).

About this task

The following images indicate the location of the powered graphical processing unit and provide a visual representation of the removal procedure.

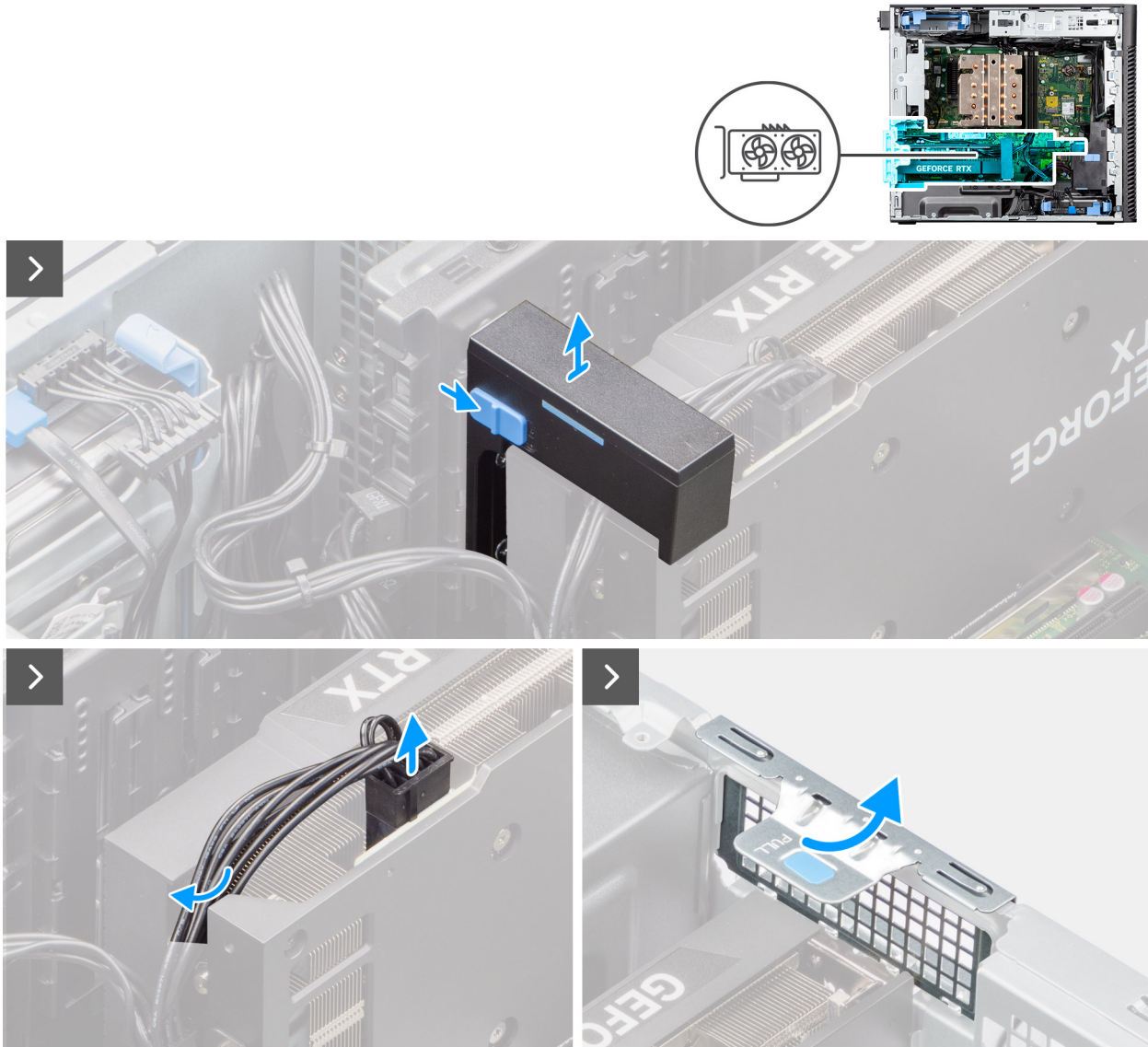

Figure 40. Removing the powered GPU

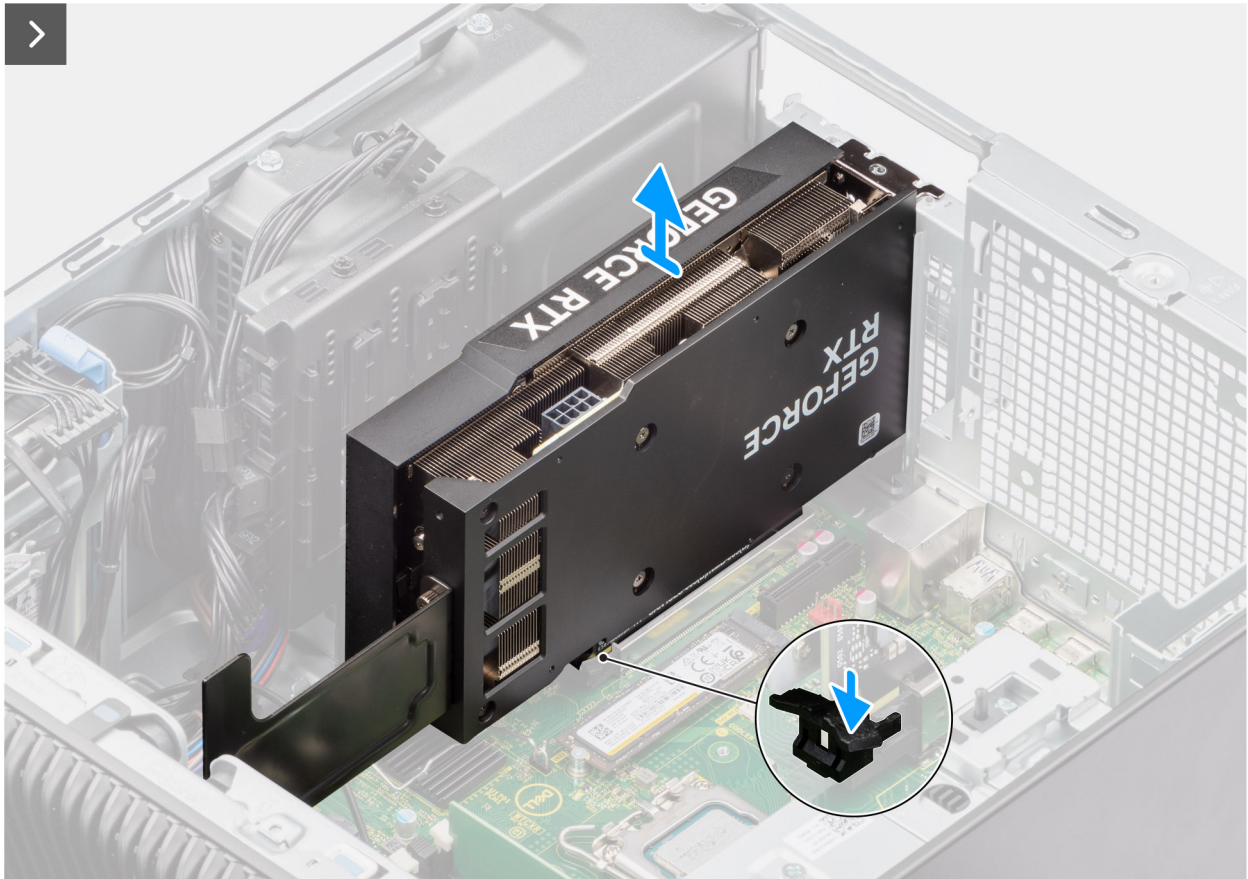

Figure 41. Removing the powered GPU

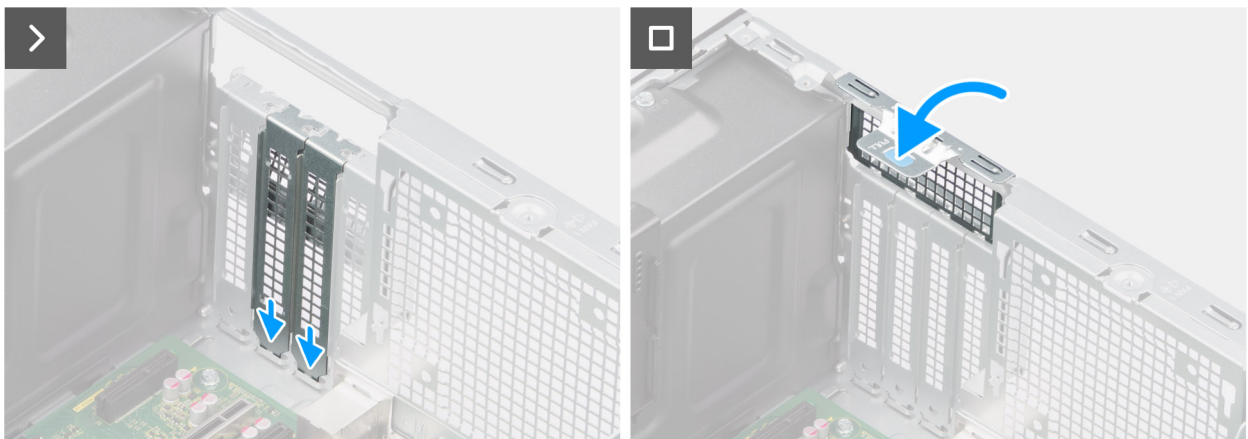

Figure 42. Removing the powered GPU

Steps

1. Slide the release latch on the graphics card holder and lift it out of the computer.
2. Disconnect the two power cables from the connector on the powered GPU and the power supply unit.
3. Lift the pull tab to open the PCIe door.
4. Push and hold the securing tab on the graphics-card slot and lift the powered GPU away from the graphics-card slot.
5. Insert the blank fillers.
6. Lift the pull tab to close the PCIe door.

Installing the powered GPU

Prerequisites

If you are replacing a component, remove the existing component before performing the installation procedure.

About this task

The following images indicate the location of the powered graphical processing unit and provide a visual representation of the installation procedure.

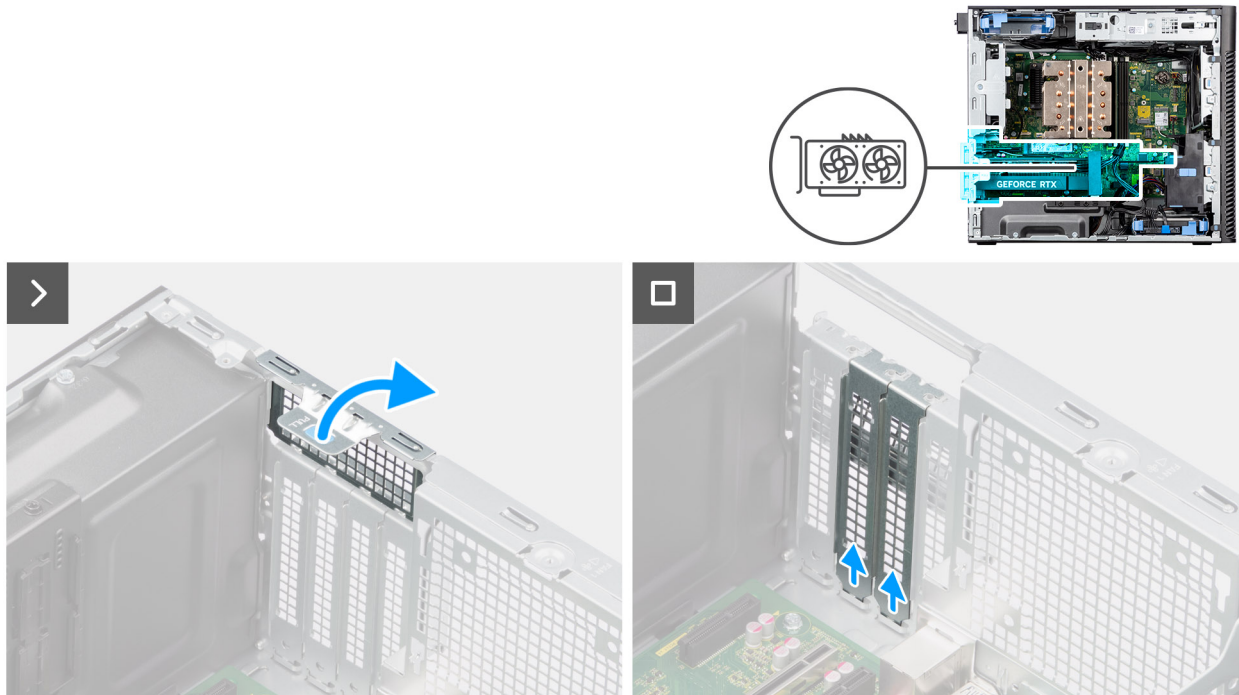

Figure 43. Installing the powered GPU

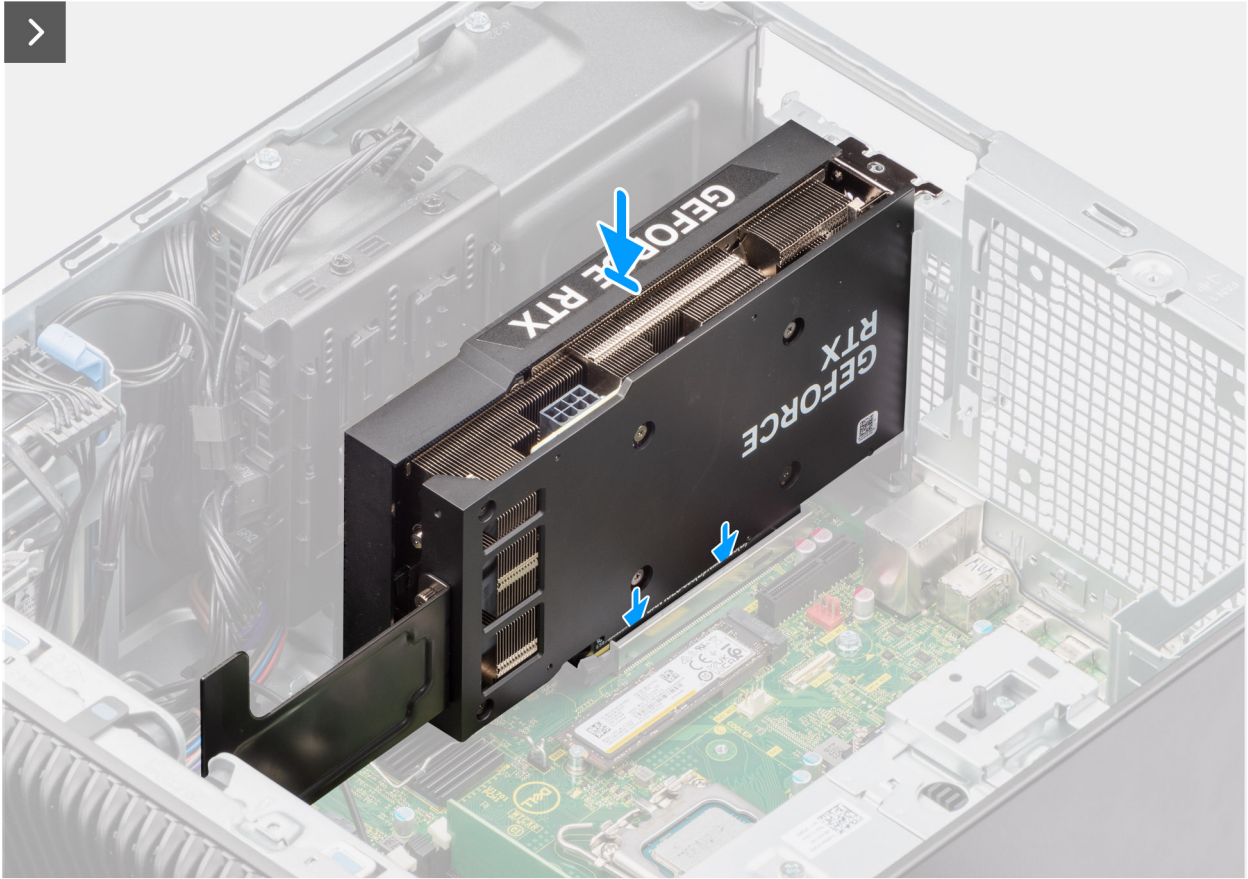

Figure 44. Installing the powered GPU

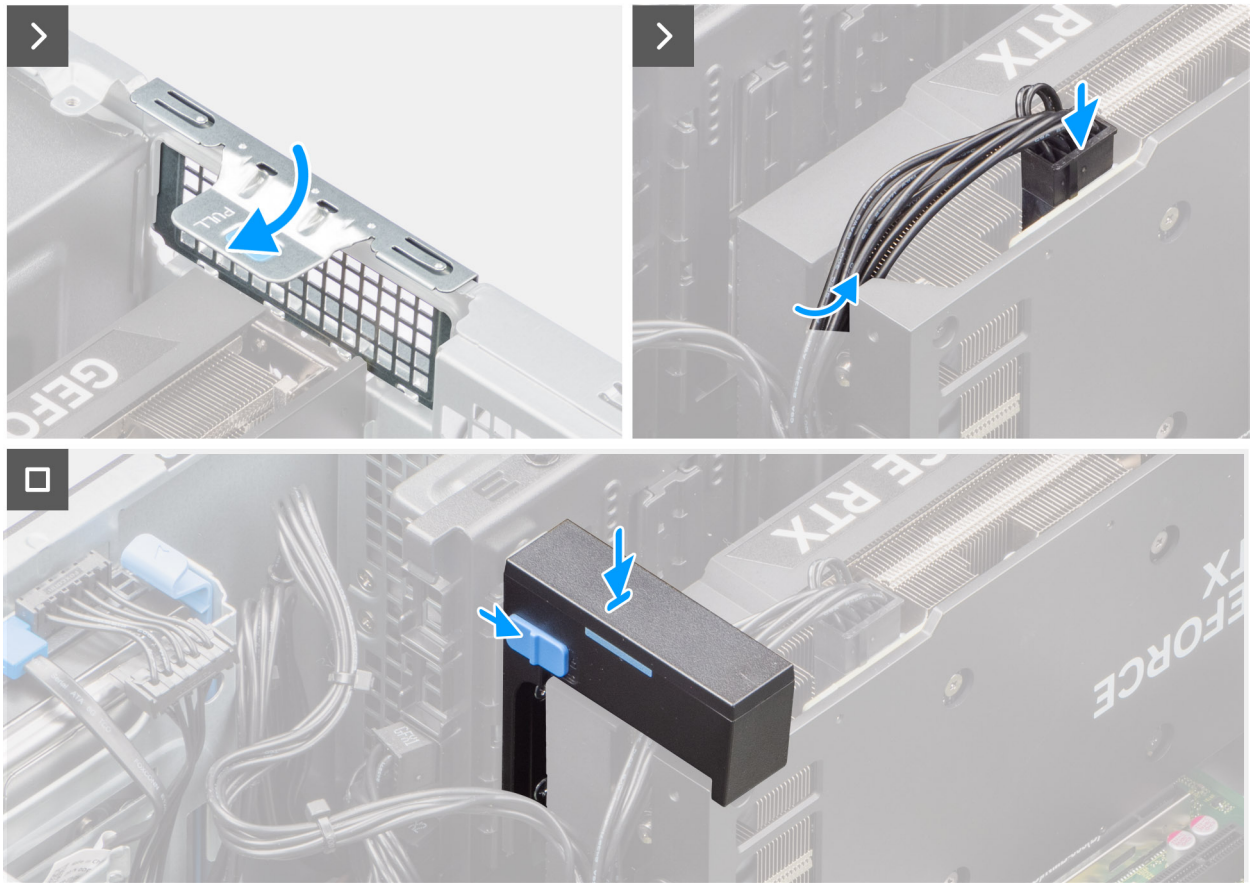

Figure 45. Installing the powered GPU

Steps

1. Lift the pull tab to open the PCIe door.
2. Remove the blank fillers.
3. Align the powered GPU with the PCI-Express card connector on the system board.
4. Using the alignment post, connect the powered GPU to the connector and press down firmly. Ensure that the powered GPU is firmly seated.
5. Lift the pull tab to close the PCIe door.
6. Connect the two power cables to the connectors on the powered GPU and power supply unit.
7. Slide the release latch on the graphics card holder and insert it into the slot until it secures to its place.

Next steps

1. Install the [GPU end holder](#).
2. Install the [side cover](#).
3. Follow the procedure in [after working inside your computer](#).

Power-supply unit

Removing the power-supply unit cover

Prerequisites

1. Follow the procedure in [before working inside your computer](#).
2. Remove the [side cover](#).

NOTE: Note the routing of all cables as you remove them so that you can route them correctly while you are replacing the power-supply unit.

About this task

The following images indicate the location of the power-supply unit and provide a visual representation of the removal procedure.



2x
#6-32

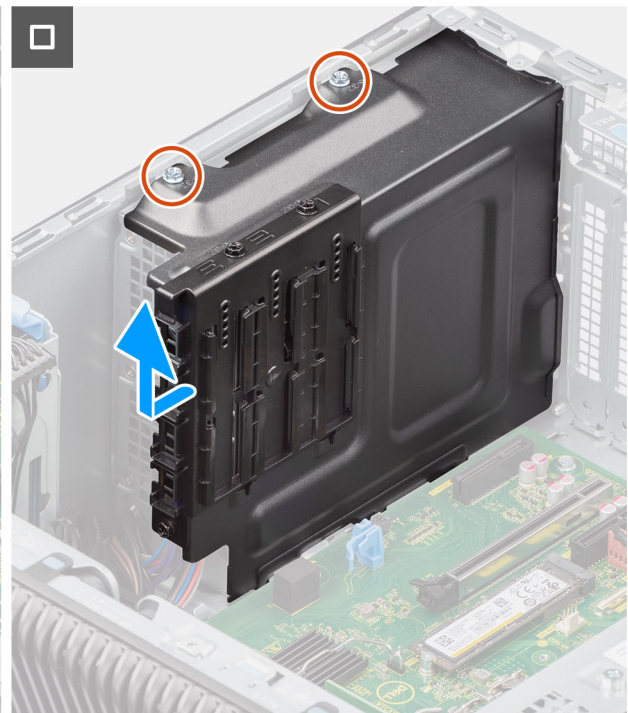

Figure 46. Removing the power-supply unit cover

Steps

1. Lay the system on the right side.
2. Disconnect the power cables from the connectors on the cover.
3. Remove the two (#6x32) screws that secure the cover to the power-supply unit.
4. Slide the cover away from the chassis.
5. Lift the cover off the chassis.

Next steps

1. Remove the [power-supply unit](#).

Installing the power-supply unit cover

Prerequisites

If you are replacing a component, remove the existing component before performing the installation procedure.

1. Install the [power-supply unit](#).

WARNING: The cables and ports on the back of the power-supply unit are color-coded to indicate the different power wattage. Ensure that you plug in the cable to the correct port. Failure to do so may result in damaging the power-supply unit and/or system components.

About this task

The following images indicate the location of the power-supply unit and provide a visual representation of the installation procedure.



2x
#6-32

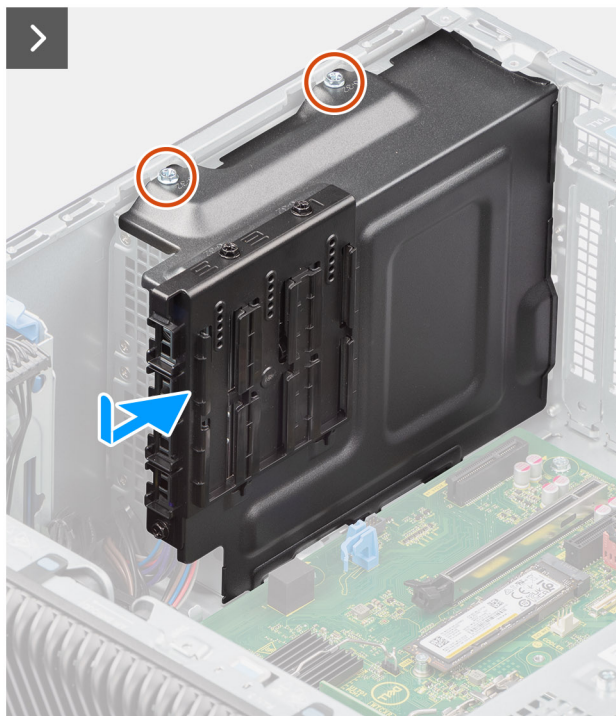

Figure 47. Installing the power-supply unit cover

Steps

1. Slide the cover into the chassis until the securing tab snaps into position.
2. Replace the two (#6x32) screws to secure the cover to the power supply unit.
3. Connect the power cables to the connectors on the cover.

Next steps

1. Install the [side cover](#).
2. Follow the procedure in [after working inside your computer](#).

Removing the 1000W power-supply unit

Prerequisites

1. Follow the procedure in [before working inside your computer](#).

2. Remove the [side cover](#).

NOTE: Note the routing of all cables as you remove them so that you can route them correctly while you are replacing the power-supply unit.

About this task

The following images indicate the location of the power-supply unit and provide a visual representation of the removal procedure.

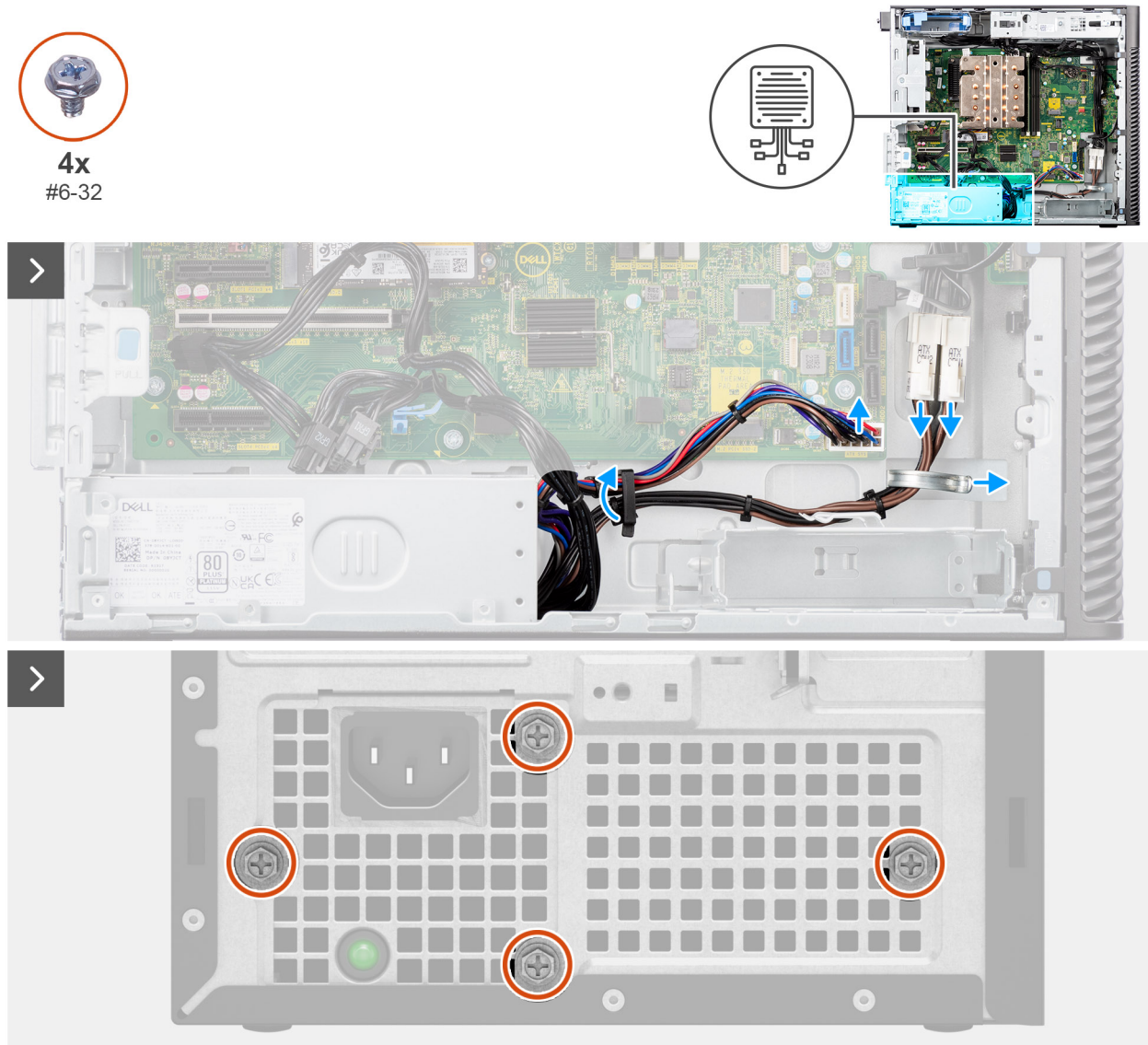

Figure 48. Removing the 1000W power-supply unit

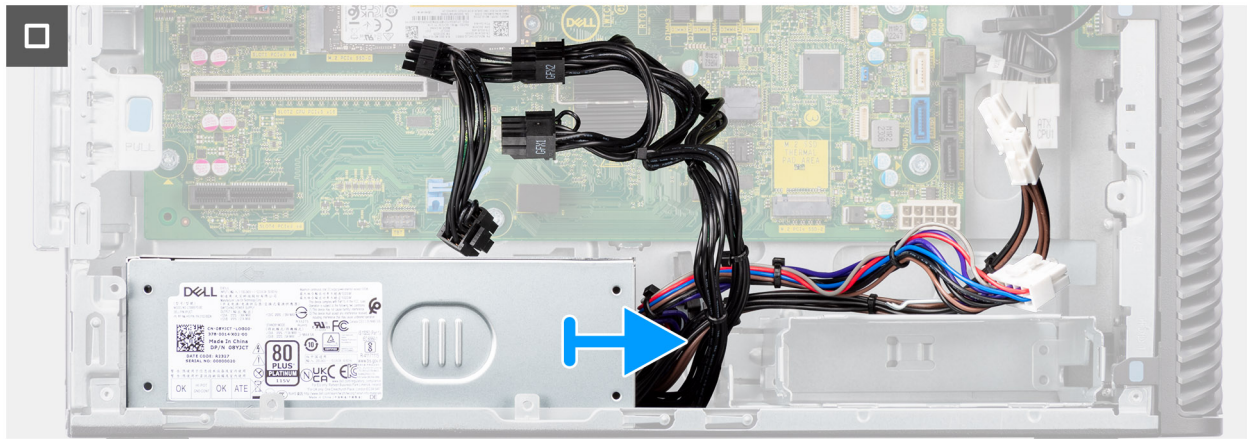

Figure 49. Removing the 1000W power-supply unit

Steps

1. Lay the system on the right side.
2. Disconnect the power cables from the connectors on the system board and unrout them from the routing guides on the chassis.
3. Remove the four (#6x32) screws that secure the power-supply unit to the chassis.
4. Slide the power-supply unit away from the back of the chassis.
5. Lift the power-supply unit off the chassis.

Installing the 1000W power-supply unit

Prerequisites

If you are replacing a component, remove the existing component before performing the installation procedure.

⚠ WARNING: The cables and ports on the back of the power-supply unit are color-coded to indicate the different power wattage. Ensure that you plug in the cable to the correct port. Failure to do so may result in damaging the power-supply unit and/or system components.

About this task

The following images indicate the location of the power-supply unit and provide a visual representation of the installation procedure.

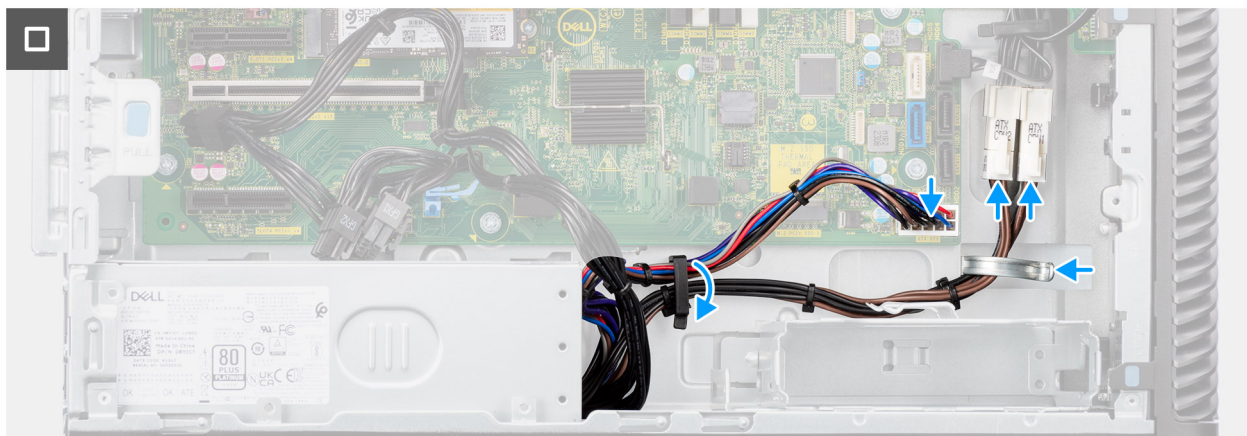

Figure 50. Installing the 1000W power-supply unit



4x
#6-32

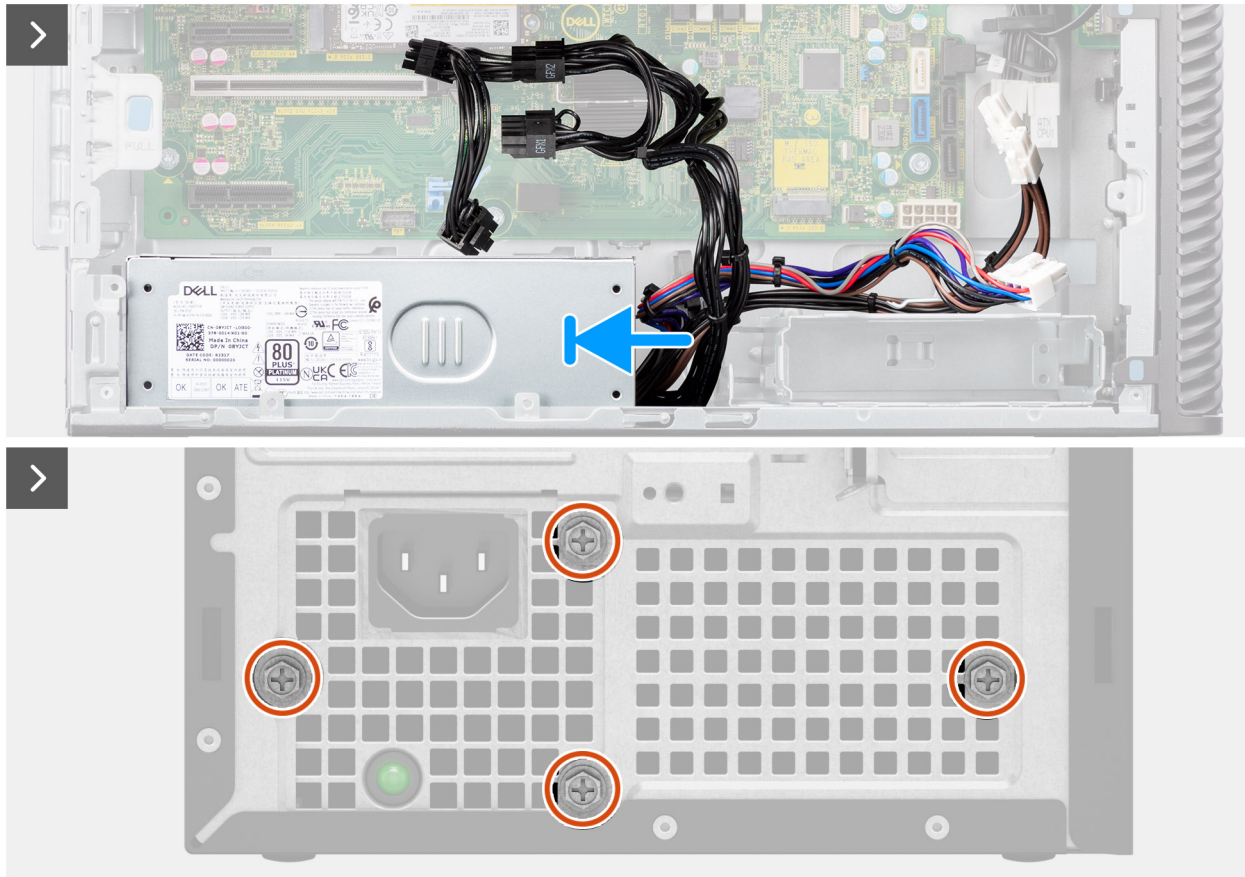
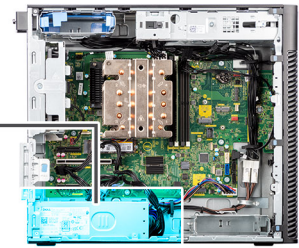
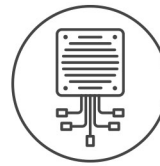

Figure 51. Installing the 1000W power-supply unit

Steps





1. Slide the power-supply unit into the chassis until the securing tab snaps into position.
2. Route the power cable through the routing guides on the chassis and connect the power cables to the connectors on the system board.
3. Replace the four (#6x32) screws to secure the power-supply unit to the chassis.

Next steps

1. Install the [side cover](#).
2. Follow the procedure in [after working inside your computer](#).

Removing and installing Field Replaceable Units (FRUs)

The replaceable components in this chapter are Field Replaceable Units (FRUs).

-  **CAUTION:** The information in this removing and installing FRU's section is intended for authorized service technicians only.
-  **CAUTION:** To avoid any potential damage to the component or loss of data, ensure that an authorized service technician replaces the Field Replaceable Units (FRUs).
-  **CAUTION:** Dell Technologies recommends that this set of repairs, if needed, to be conducted by trained technical repair specialists.
-  **CAUTION:** As a reminder, your warranty does not cover damages that may occur during FRU repairs that are not authorized by Dell Technologies.
-  **NOTE:** The images in this document may differ from your computer depending on the configuration you ordered.

Processor fan and heat-sink assembly

Removing the processor fan and 125 W heat-sink assembly

-  **CAUTION:** The information in this removal section is intended for authorized service technicians only.

Prerequisites

1. Follow the procedure in [before working inside your computer](#).

 **WARNING:** The heat sink may become hot during normal operation. Allow sufficient time for the heat sink to cool before you touch it.

 **CAUTION:** For maximum cooling of the processor, do not touch the heat transfer areas on the heat sink. The oils in your skin can reduce the heat transfer capability of the thermal grease.

2. Remove the [side cover](#).
3. Remove the [air shroud](#).

 **NOTE:** For systems with 1000W PSU only.

About this task

The following images indicate the location of the processor fan and 125 W heat-sink assembly and provide a visual representation of the removal procedure.



4x

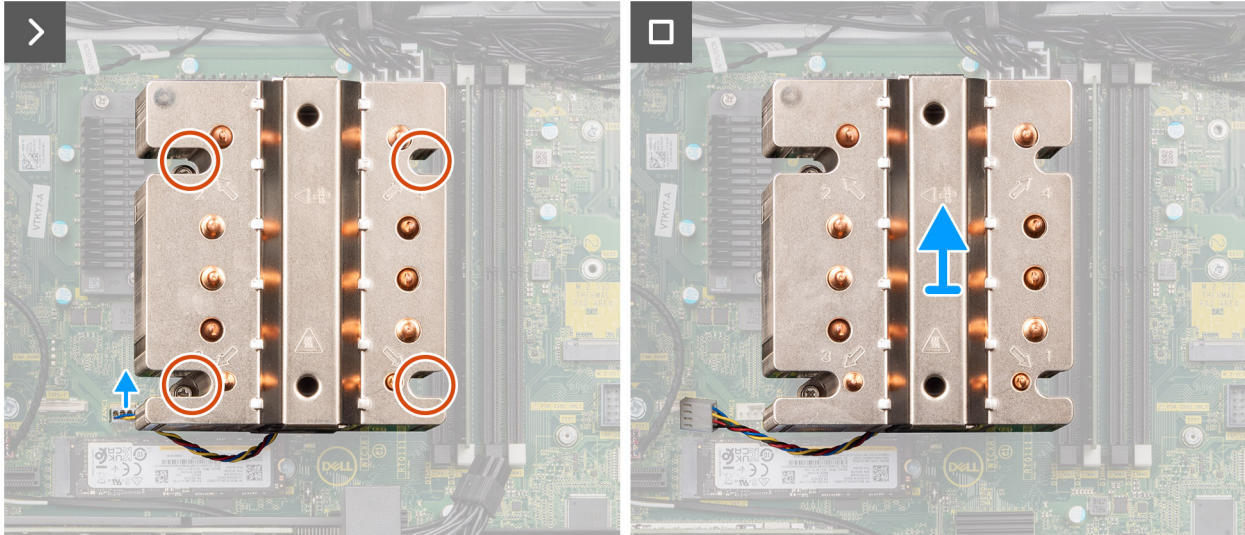
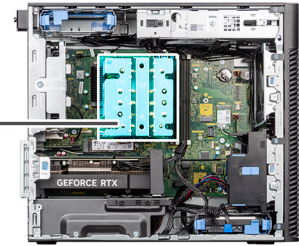
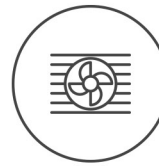

Figure 52. Removing the processor fan and 125 W heat-sink assembly

Steps

1. Disconnect the processor-fan cable from the connector on the system board.
2. In the reverse sequential order (4->3->2->1), loosen the four captive screws that secure the processor fan and heat-sink assembly to the system board.
3. Lift the processor fan and heat-sink assembly from the system board.

Installing the processor fan and 125 W heat-sink assembly

CAUTION: The information in this installation section is intended for authorized service technicians only.

Prerequisites

If you are replacing a component, remove the existing component before performing the installation procedure.

NOTE: If either the processor or the heat sink is replaced, use the thermal grease that is provided in the kit to ensure that thermal conductivity is achieved.

About this task

The following images indicate the location of the processor fan and 125 W heat-sink and provide a visual representation of the installation procedure.

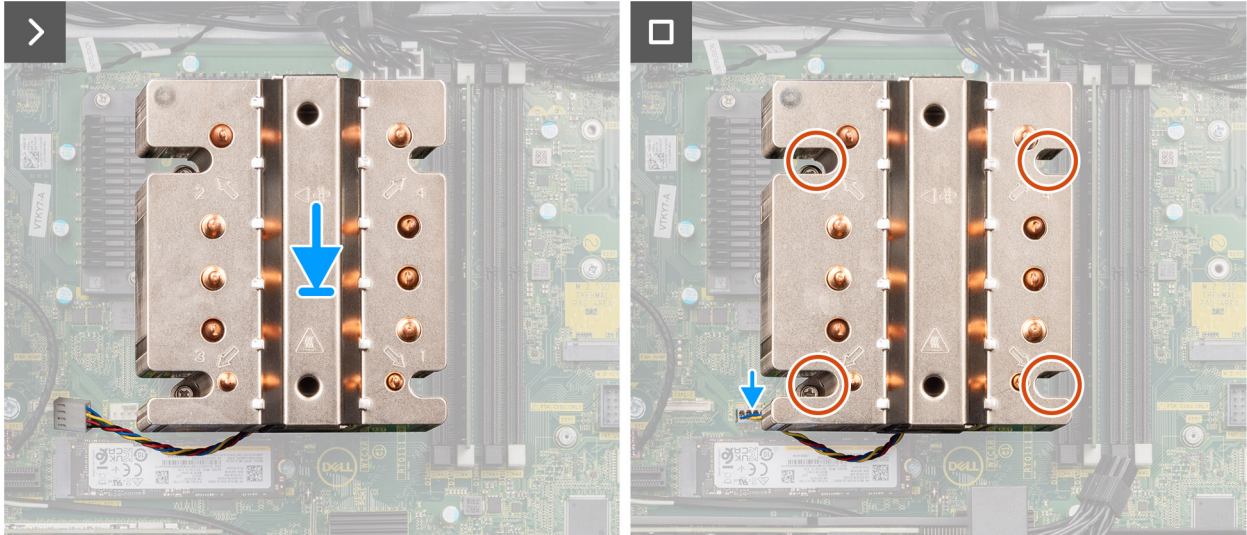
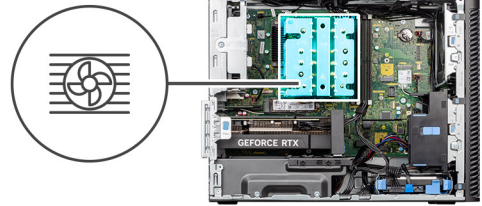

Figure 53. Installing the processor fan and 125 W heat-sink assembly

Steps

1. Align the screws on the processor fan and heat-sink assembly with the screw holders on the system board and place the processor fan and heat-sink assembly on the processor.
(i) NOTE: Ensure that the triangle mark is directed towards the rear side of the computer.
2. In the sequential order (1->2->3->4), tighten the captive screws to secure the processor fan and heat-sink assembly to the system board.
(i) NOTE: Tighten the screws in a sequential order (1,2,3,4) as printed on the system board.
3. Connect the processor-fan cable to the connector on the system board.
(i) NOTE: Ensure to connect the cable to the corresponding connector with the same color on the system board.

Next steps

1. Install the [air shroud](#).
(i) NOTE: For systems with 1000W PSU only.
2. Install the [side cover](#).
3. Follow the procedure in [after working inside your computer](#).

Removing the processor fan and 65 W heat-sink assembly

⚠ CAUTION: The information in this removal section is intended for authorized service technicians only.

Prerequisites

1. Follow the procedure in [before working inside your computer](#).

WARNING: The heat sink might heat up during regular operation. Allow sufficient time for the heat sink to cool before you touch it.

CAUTION: For maximum cooling of the processor, do not touch the heat transfer areas on the heat sink. The oils in your skin can reduce the heat transfer capability of the thermal grease.

2. Remove the [side cover](#).

3. Remove the [air shroud](#).

NOTE: For systems with 1000W PSU only.

About this task

The following images indicate the location of the processor fan and heat-sink and provide a visual representation of the removal procedure.

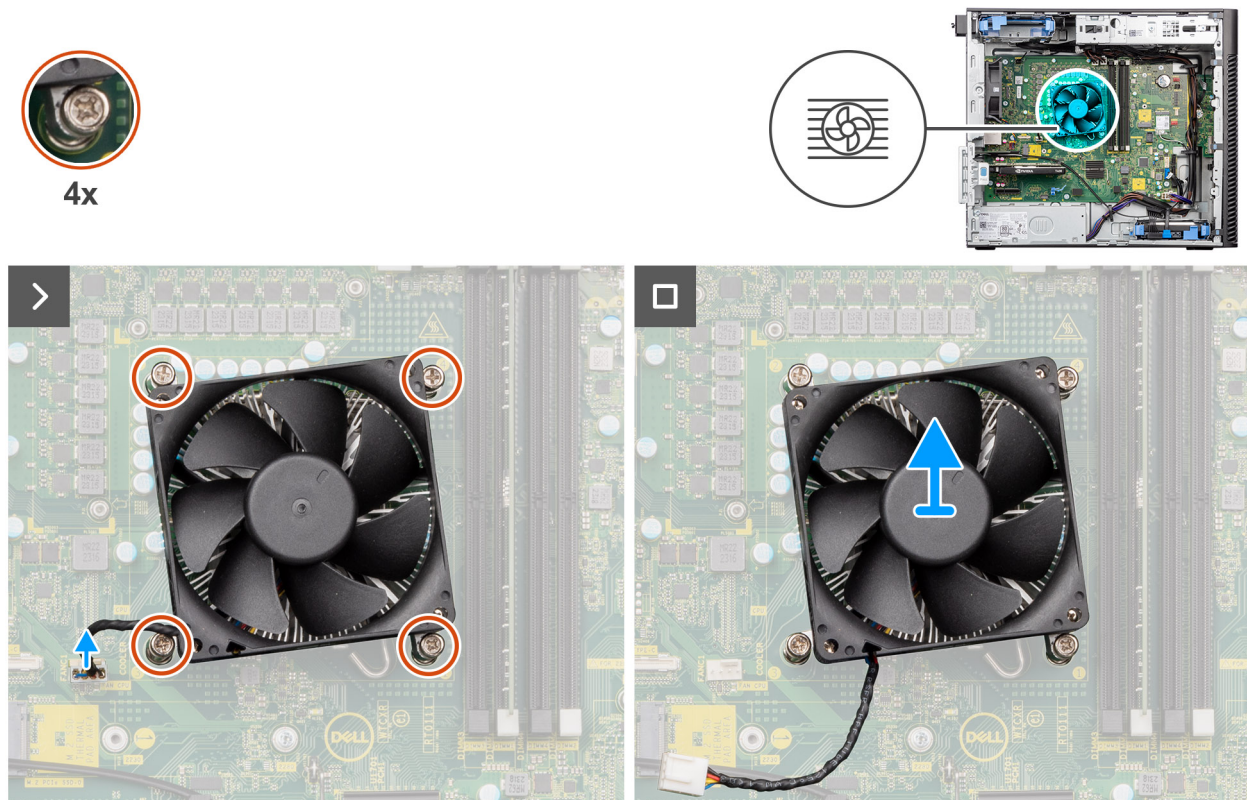

Figure 54. Removing the processor fan and 65 W heat-sink assembly

Steps

1. Disconnect the processor fan cable from the connector on the system board.
2. Loosen the four captive screws that secure the processor fan and heat-sink assembly to the system board.
3. Lift the processor fan and heat-sink assembly off the system board.

Installing the processor fan and 65 W heat-sink assembly

CAUTION: The information in this installation section is intended for authorized service technicians only.

Prerequisites

NOTE: If either the processor or the heat sink is replaced, use the thermal grease that is provided in the kit to ensure that thermal conductivity is achieved.

About this task

The following images indicate the location of the processor fan and heat-sink assembly and provide a visual representation of the installation procedure.

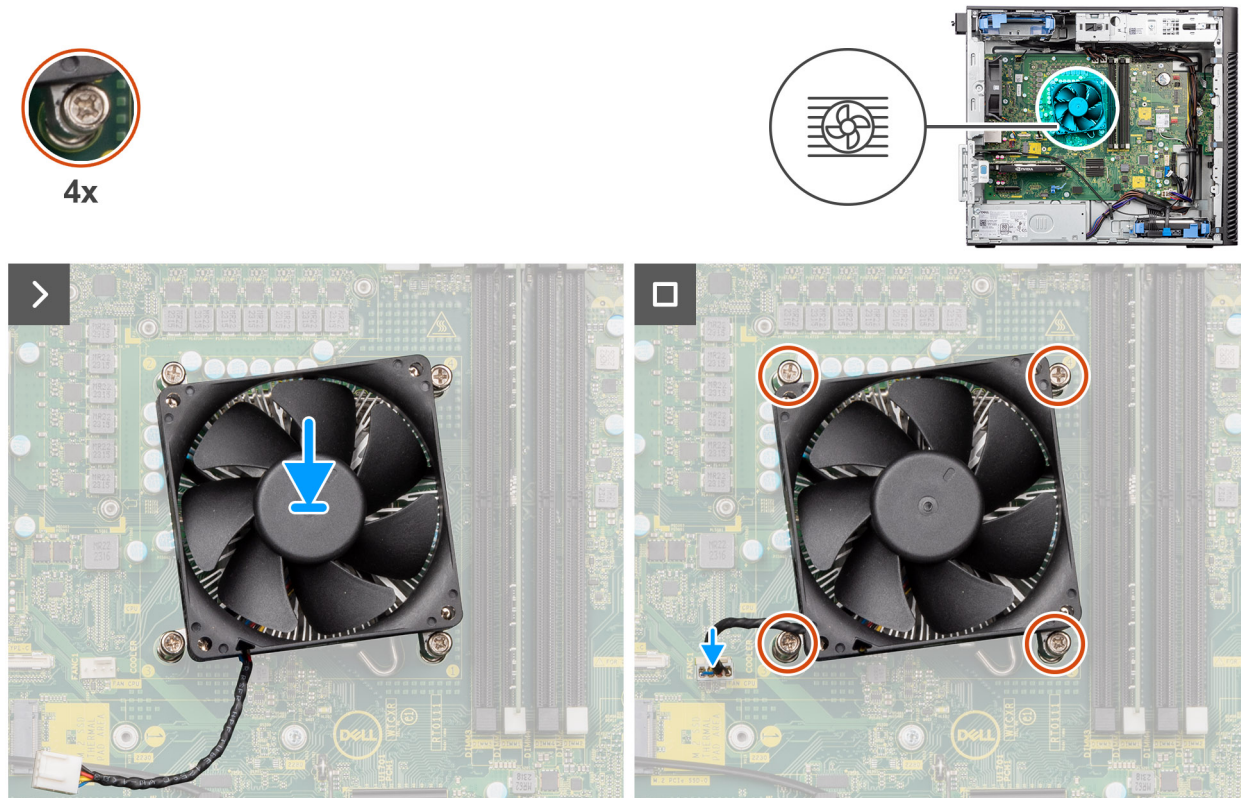

Figure 55. Installing the processor fan and 65 W heat-sink assembly

Steps

1. Align the screw holes on the processor fan and heat-sink assembly with the screw holes on the system board.
2. Tighten the four captive screws that secure the processor fan and heat-sink assembly to the system board.
3. Connect the processor-fan cable to the connector on the system board.

(i) NOTE: Ensure to connect the cable to the corresponding connector with the same color on the system board.

Next steps

1. Install the [air shroud](#).
- (i) NOTE:** For systems with 1000W PSU only.
2. Install the [side cover](#).
3. Follow the procedure in [after working inside your computer](#).

Processor

Removing the processor

(Δ) CAUTION: The information in this removal section is intended for authorized service technicians only.

Prerequisites

1. Follow the procedure in [before working inside your computer](#).

2. Remove the [side cover](#).
3. Remove the [air shroud](#).
4. Remove the [125 W heat-sink assembly](#) or [65 W heat-sink assembly](#).

NOTE: For systems with 1000W PSU only.

NOTE: The processor might still be hot after the computer is shut down. Allow the processor to cool down before removing it.

About this task

The following images indicate the location of the processor and provide a visual representation of the removal procedure.

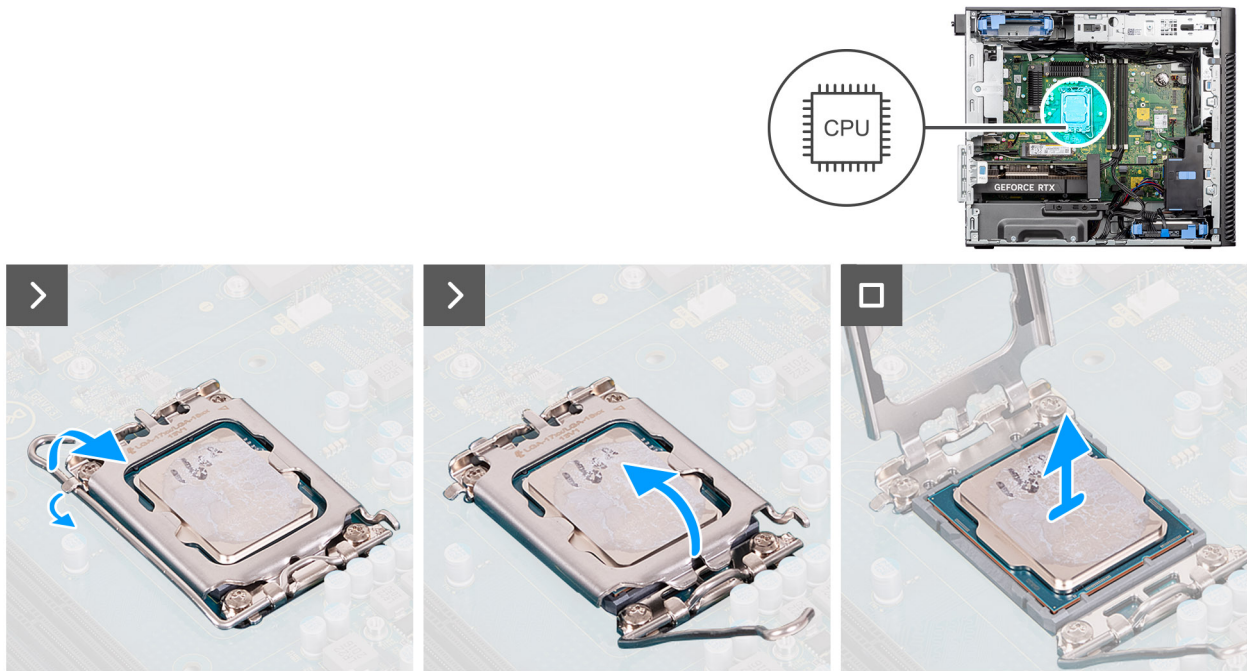

Figure 56. Removing the processor

Steps

1. Press down and push the release lever away from the processor to release it from the securing tab.
2. Lift the lever upward to lift the processor cover.

CAUTION: When removing the processor, do not touch any of the pins inside the socket or allow any objects to fall on the pins in the socket.

3. Gently lift the processor from the processor socket.

Installing the processor

CAUTION: The information in this installation section is intended for authorized service technicians only.

Prerequisites

If you are replacing a component, remove the existing component before performing the installation procedure.

About this task

The following images indicate the location of the processor and provide a visual representation of the installation procedure.

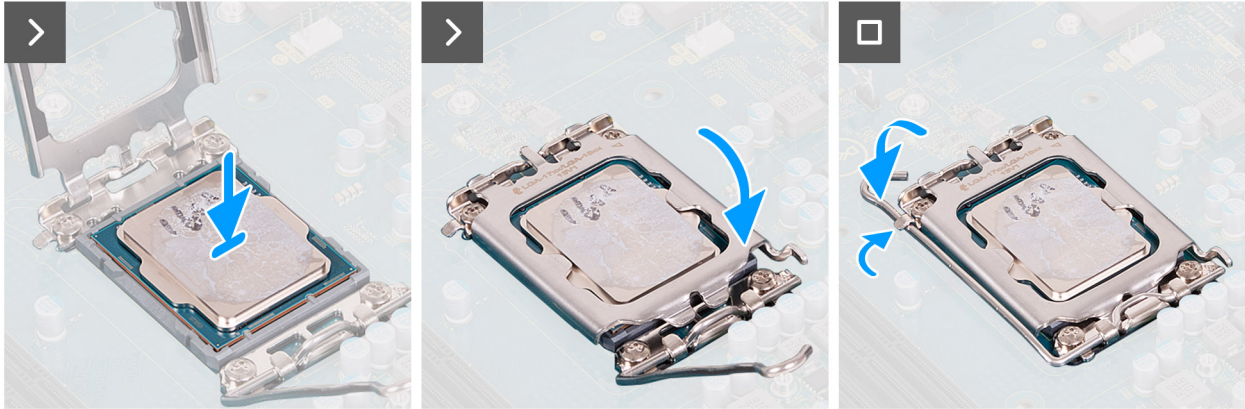
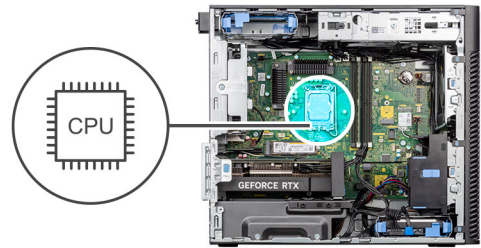

Figure 57. Installing the processor

Steps

1. Ensure that the release lever on the processor socket is fully extended in the open position.
2. Align the notches on the processor with the tabs on the processor socket, and place the processor in the processor socket.
 - i** **NOTE:** The pin-1 corner of the processor has a triangle that aligns with the triangle on the pin-1 corner of the processor socket. When the processor is properly seated, all four corners are aligned at the same height. If one or more corners of the processor are higher than the others, the processor is not secured properly.
3. When the processor is secured in the socket, pivot the release-lever down and place it under the tab on the processor cover.

Next steps

1. Install the [125 W heat-sink assembly](#) or [65 W heat-sink assembly](#).
2. Install the [air shroud](#).
 - i** **NOTE:** For systems with 1000W PSU only.
3. Install the [side cover](#).
4. Follow the procedure in [after working inside your computer](#).

Voltage-regulator (VR) heat sink

Removing the VR heat sink

⚠ CAUTION: The information in this removal section is intended for authorized service technicians only.

Prerequisites

1. Follow the procedure in [before working inside your computer](#).
 - ⚠ WARNING:** The heat sink may become hot during normal operation. Allow sufficient time for the heat sink to cool before you touch it.
 - ⚠ CAUTION:** For maximum cooling of the processor, do not touch the heat transfer areas on the heat sink. The oils in your skin can reduce the heat transfer capability of the thermal grease.

2. Remove the [side cover](#).
3. Remove the [air shroud](#).

NOTE: For systems with 1000W PSU only.

4. Remove the [125 W heat-sink assembly](#) or [65 W heat-sink assembly](#).

NOTE: VR heat sinks are only required for systems with an 8 core 65W CPU, a 6 core 125W CPU or an 8 core 125W CPU.

About this task

The following image indicates the location of the VR heat sink and provide a visual representation of the removal procedure.

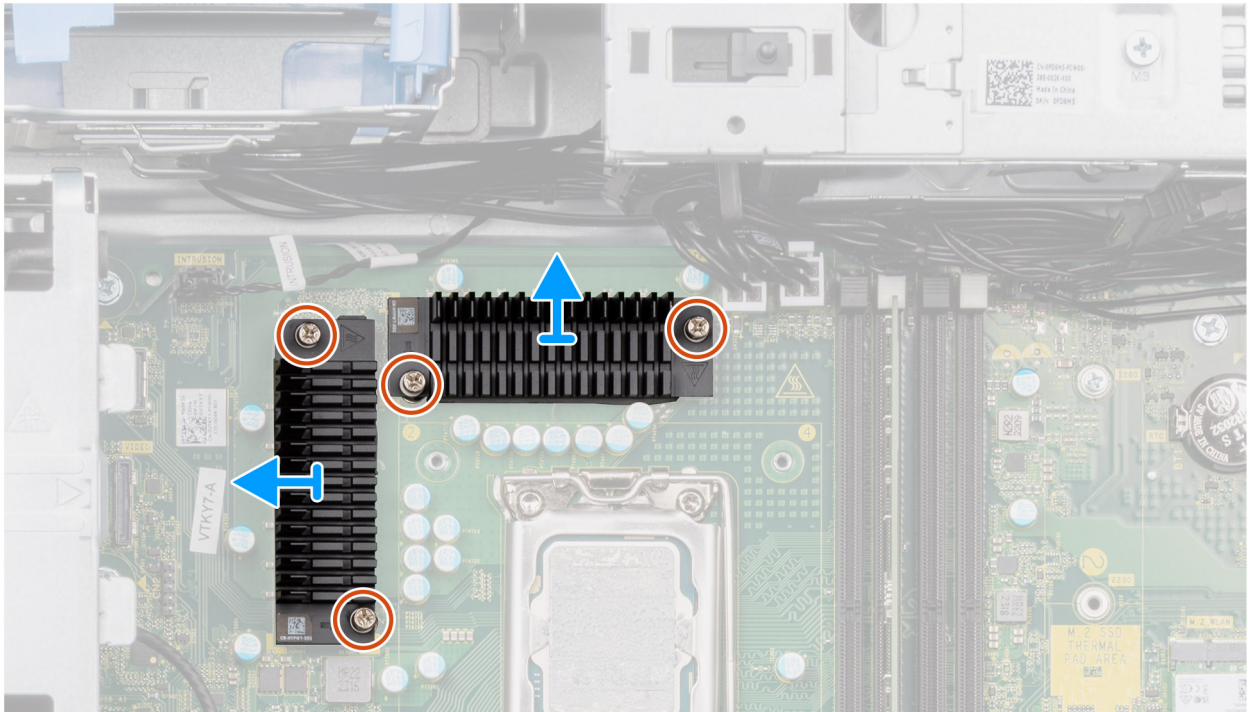
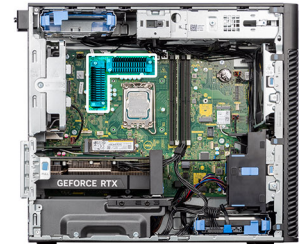

Figure 58. Removing the VR heat sink

Steps

1. Loosen the four captive screws that secure the VR heat sinks to the system board.
2. Lift the VR heat sink off the system board.

Installing the VR heat sink

CAUTION: The information in this installation section is intended for authorized service technicians only.

Prerequisites

If you are replacing a component, remove the existing component before performing the installation procedure.

NOTE: VR heat sinks are only required for systems with an 8 core 65W CPU, a 6 core 125W CPU or an 8 core 125W CPU.

About this task

The following image indicates the location of the VR heat sink and provide a visual representation of the installation procedure.



4x

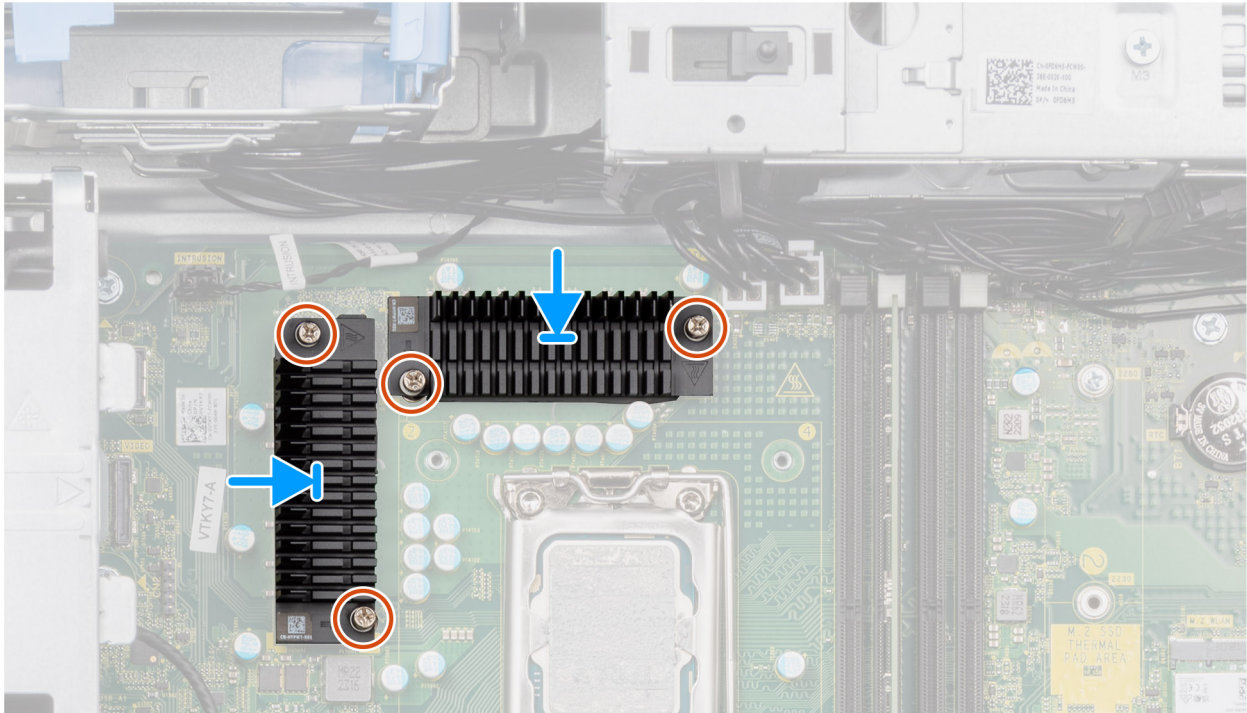
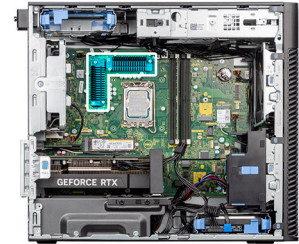

Figure 59. Installing the VR heat sink

Steps

1. Remove the liner behind the VR heat-sink modules.

i **NOTE:** Step one is only applicable for a new installation or an upgrade. For replacing an existing component, follow the procedure from step two.

2. Adhere the VR heatsinks to the system board.
3. Tighten the four captive screws that secure the VR heat sinks to the system board.

Next steps

1. Install the [125 W heat-sink assembly](#) or [65 W heat-sink assembly](#).
2. Install the [air shroud](#).

i **NOTE:** For systems with 1000W PSU only.

3. Install the [side cover](#).
4. Follow the procedure in [after working inside your computer](#).

Chassis fan

Removing the front fan

CAUTION: The information in this removal section is intended for authorized service technicians only.

Prerequisites

1. Follow the procedure in [before working inside your computer](#).
2. Remove the [side cover](#).
3. Remove the [air shroud](#).

NOTE: For systems with 1000W PSU only.

About this task

The following images indicate the location of the chassis fan and provide a visual representation of the removal procedure.

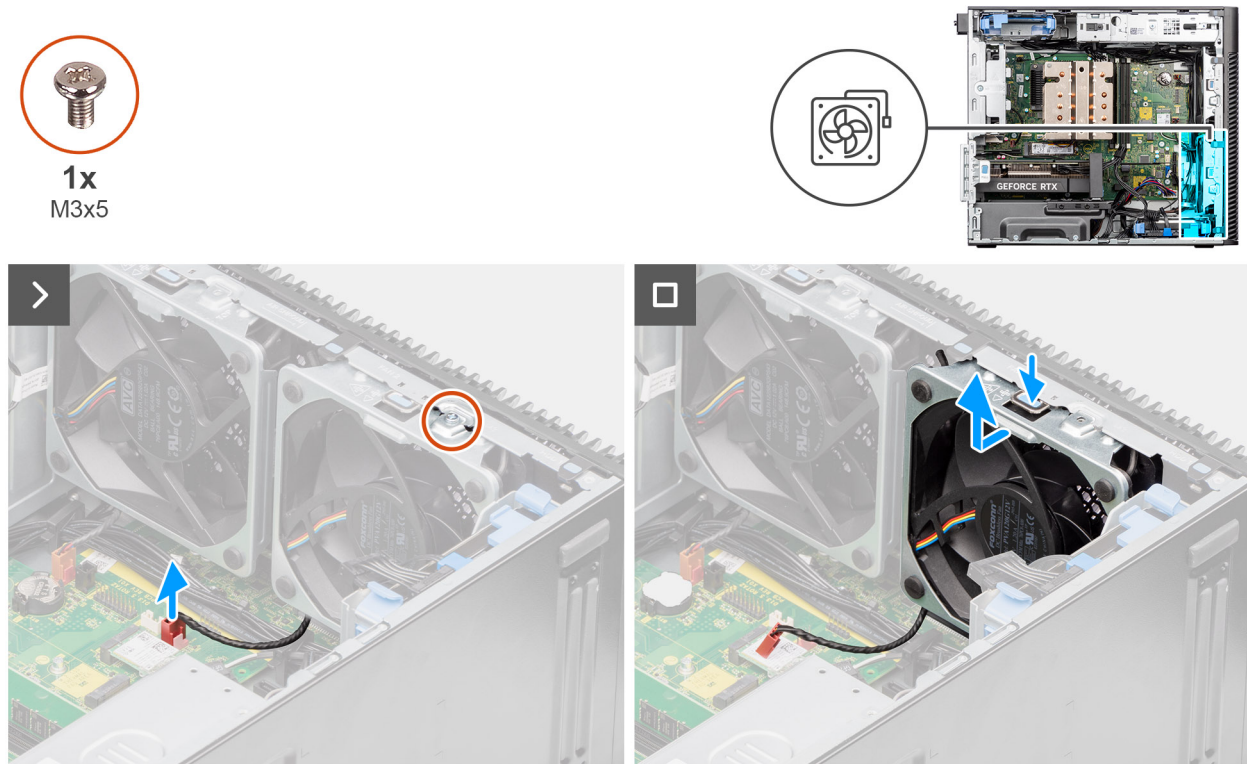

Figure 60. Front fan 1

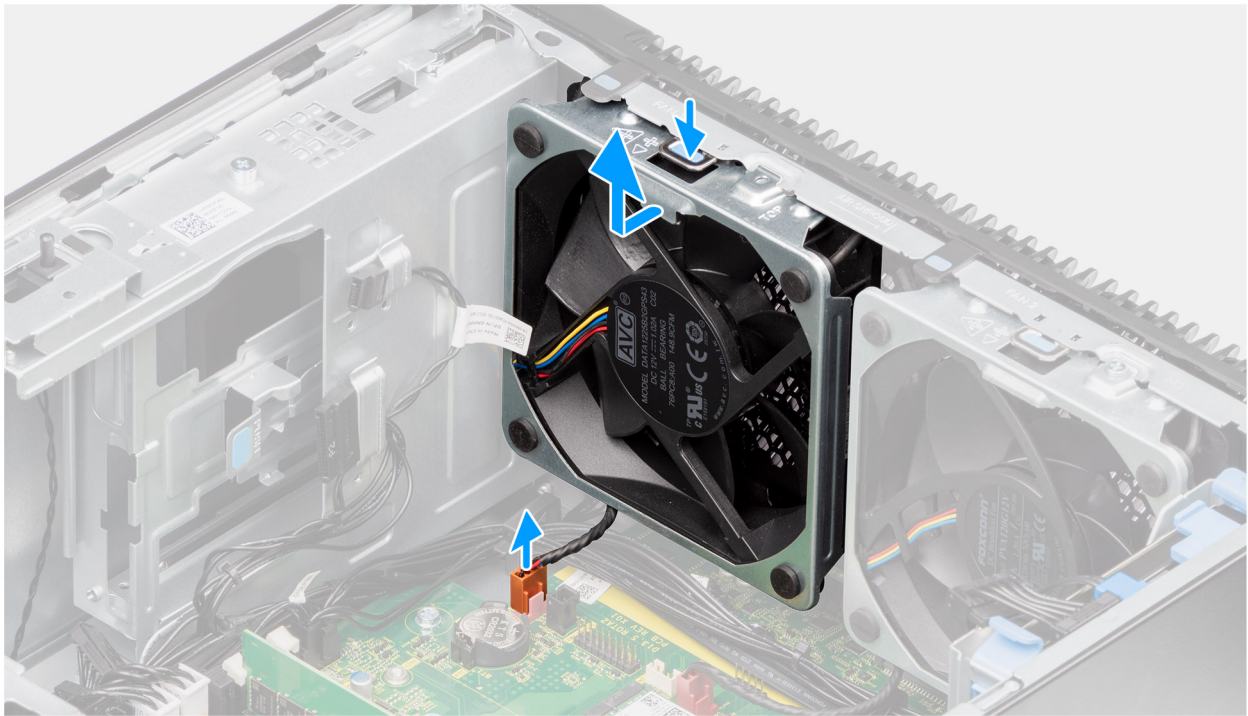
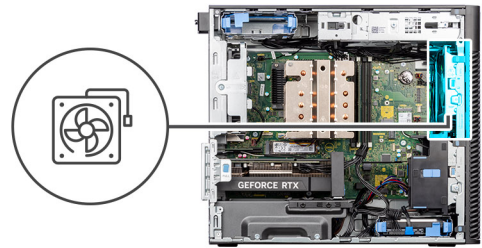

Figure 61. Front fan 2

Steps

1. Remove the M3x5 screw that secures the fan 1 to the chassis.
2. Disconnect the fan cables from the connectors on the system board.
3. Press the tab to release the chassis fan from the slot.
4. At an angle, lift the chassis fan and remove it from the chassis.

NOTE: Follow the procedure from step 2 to 4 for fan 2.

Installing the front fan

CAUTION: The information in this installation section is intended for authorized service technicians only.

Prerequisites

If you are replacing a component, remove the existing component before performing the installation procedure.

About this task

The following images indicate the location of the chassis fan and provide a visual representation of the installation procedure.



1x
M3x5

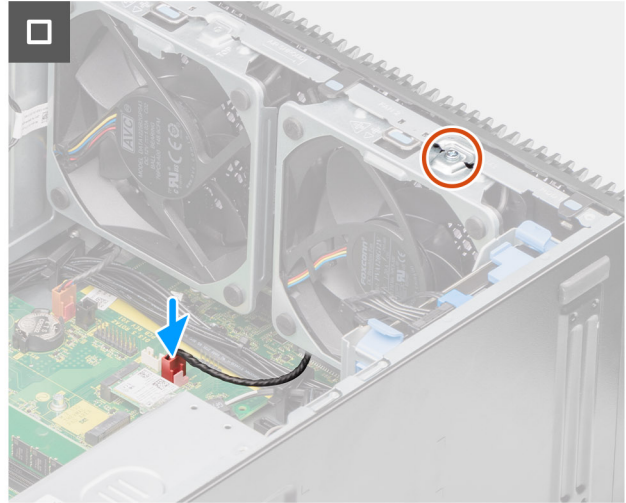
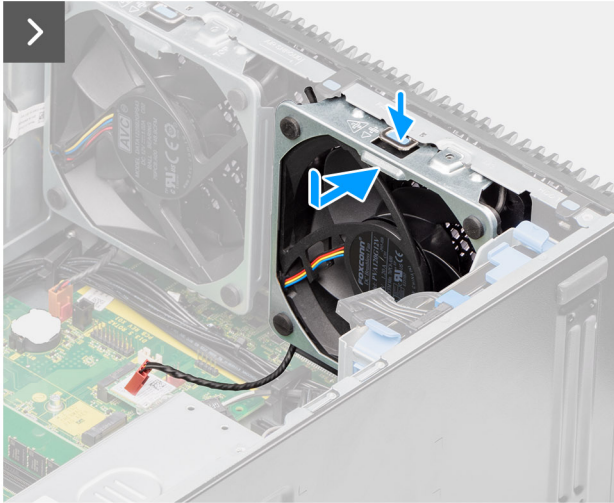
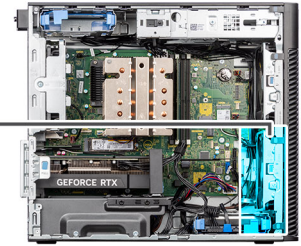
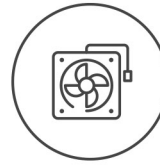

Figure 62. Front fan 1

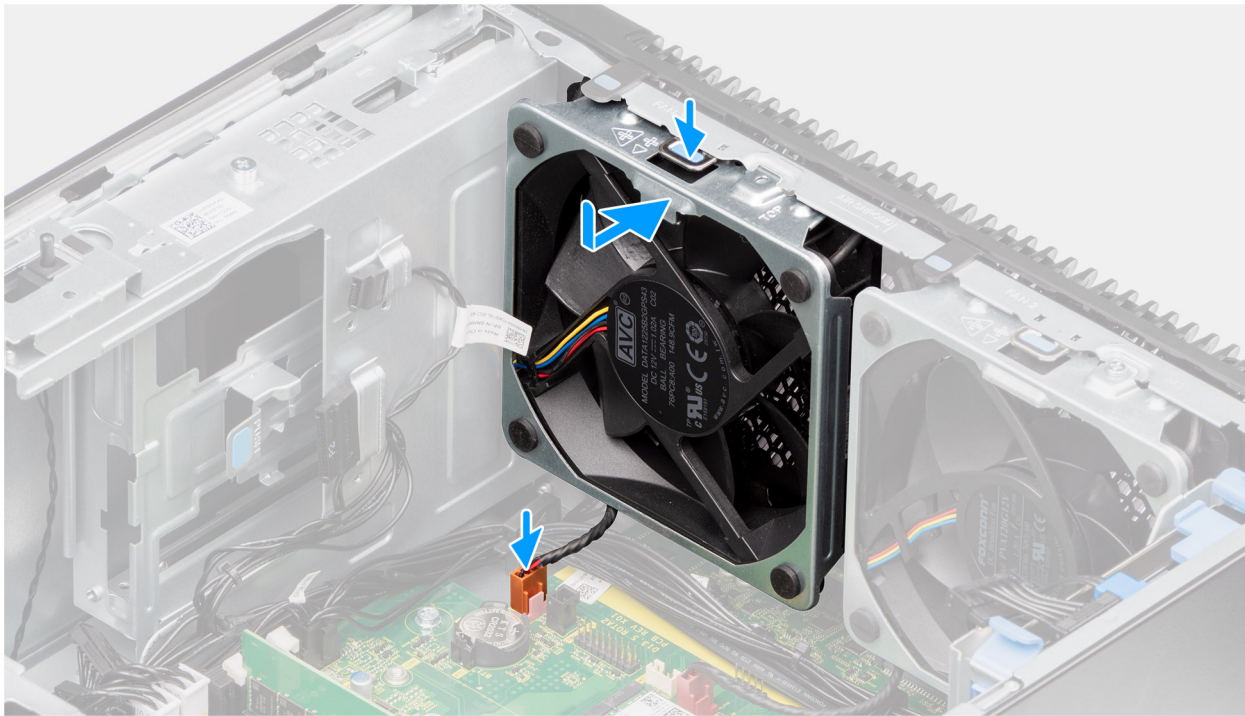
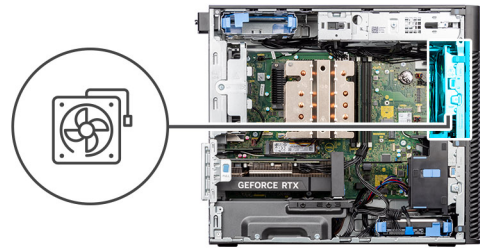

Figure 63. Front fan 2

Steps

1. Align the tabs on the fan with the slots on the chassis.
2. Insert the chassis fan at an angle into the slot in the chassis.
3. Press the chassis fan into the slot until the release tab locks into place.
4. Connect the fan cable to the connector on the system board.

(i) NOTE: Follow the procedure from step 1 to 4 for fan 2.

5. Replace the M3x5 screw to secure the fan 1 to the chassis.

Next steps

1. Install the [air shroud](#).
(i) NOTE: For systems with 1000W PSU only.
2. Install the [side cover](#).
3. Follow the procedure in [after working inside your computer](#).

Removing the rear fan for 300W PSU systems

⚠ CAUTION: The information in this removal section is intended for authorized service technicians only.

Prerequisites

1. Follow the procedure in [before working inside your computer](#).
2. Remove the [side cover](#).
3. Remove the [air shroud](#).

 **NOTE:** For systems with 1000W PSU only.

About this task

The following images indicate the location of the rear fan and provide a visual representation of the removal procedure.

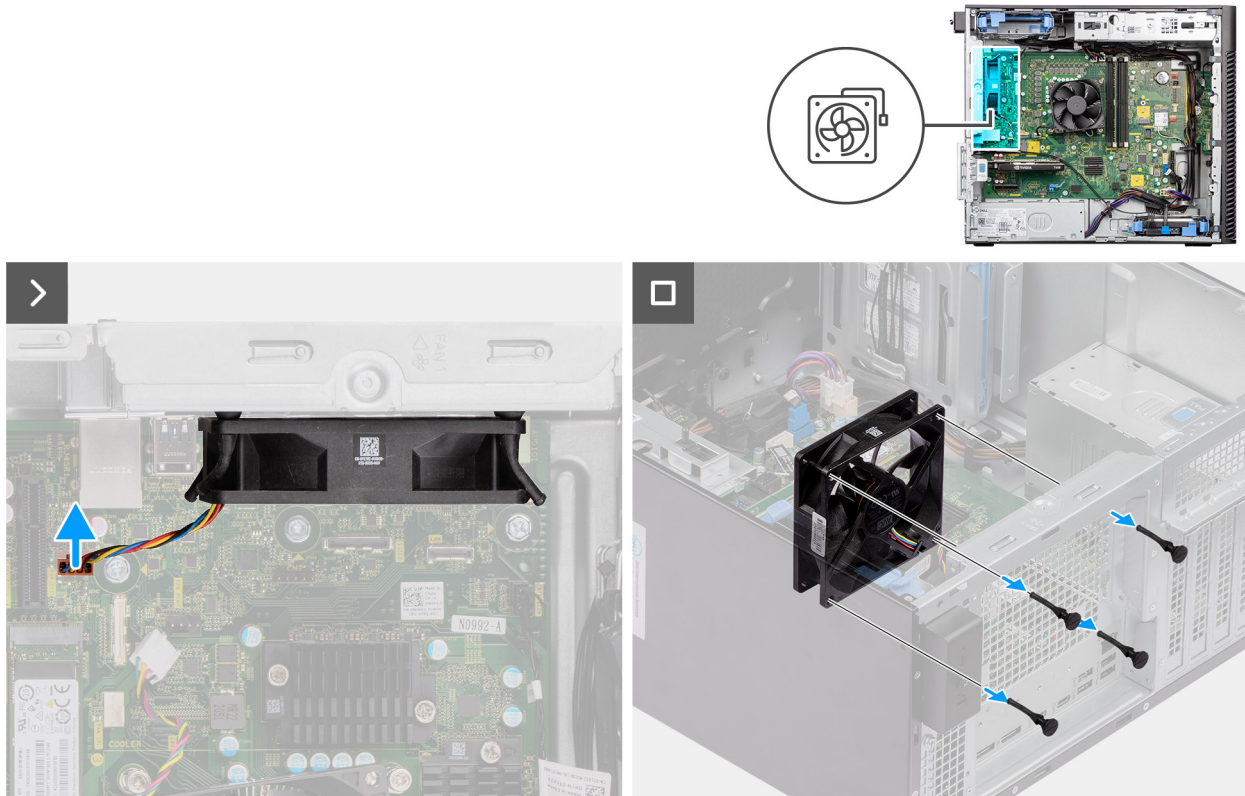

Figure 64. Removing the rear fan for 300W PSU systems

Steps

1. Disconnect the fan cable from the connector on the system board.
2. Locate the position of rubber grommets.
3. Gently pull the rubber grommets to release the fan from the chassis.
4. Remove the fan from the chassis.

Installing the rear fan for 300W PSU systems

 **CAUTION:** The information in this installation section is intended for authorized service technicians only.

Prerequisites

If you are replacing a component, remove the existing component before performing the installation procedure.

About this task

The following images indicate the location of the rear fan and provide a visual representation of the installation procedure.

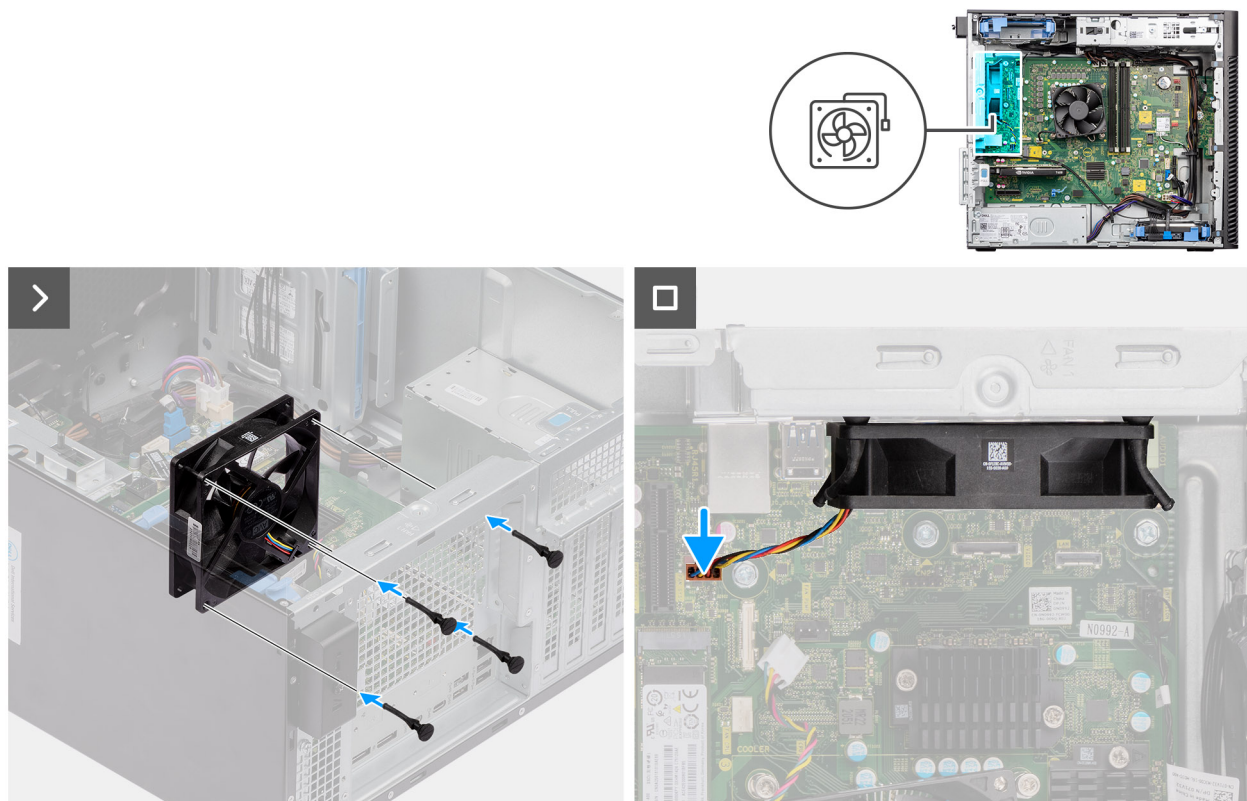

Figure 65. Installing the rear fan for 300W PSU systems

Steps

1. Insert the rubber grommets on the chassis.
2. Align the slots on the fan with the rubber grommets on the chassis.
3. Route the rubber grommets through the slots on the fan and pull the rubber grommets until the fan snaps into position.
4. Connect the fan cable to the connector on the system board.

Next steps

1. Install the [air shroud](#).
i **NOTE:** For systems with 1000W PSU only.
2. Install the [side cover](#).
3. Follow the procedure in [after working inside your computer](#).

Removing the rear fan (1000W PSU)

⚠ **CAUTION:** The information in this removal section is intended for authorized service technicians only.

Prerequisites

1. Follow the procedure in [before working inside your computer](#).
2. Remove the [side cover](#).
3. Remove the [air shroud](#).
i **NOTE:** For systems with 1000W PSU only.

About this task

The following images indicate the location of the chassis fan and provide a visual representation of the removal procedure.



1x
M3x5

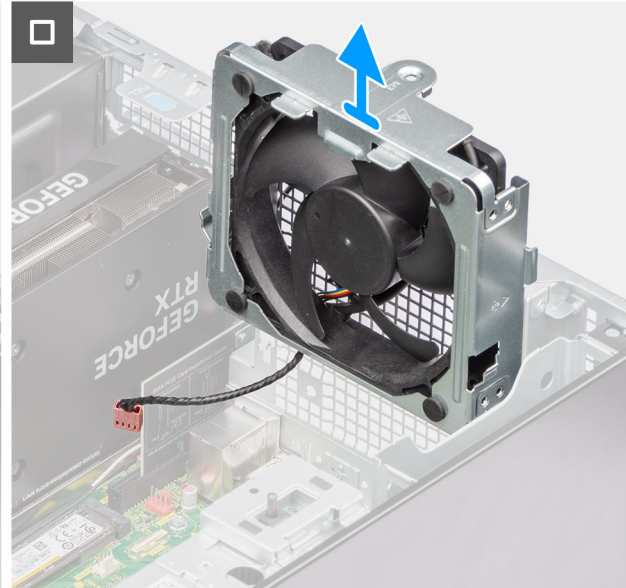
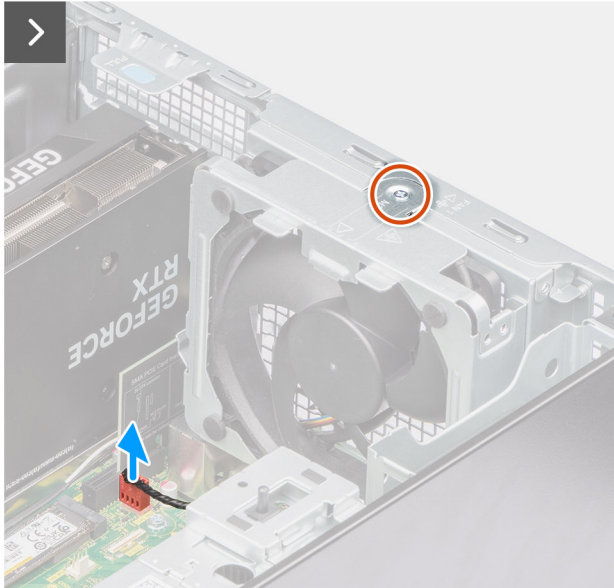
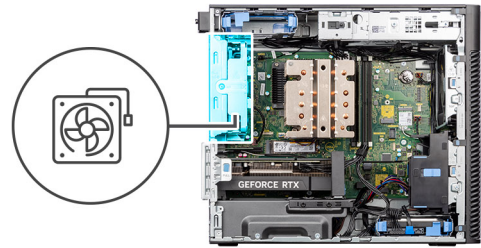

Figure 66. Removing the rear fan (1000W PSU)

Steps

1. Remove the M3x5 screw that secures the system fan to the chassis.
2. Disconnect the fan cable from the connector on the system board.
3. Remove the fan from the chassis.

Installing the rear fan (1000W PSU)

CAUTION: The information in this installation section is intended for authorized service technicians only.

Prerequisites

If you are replacing a component, remove the existing component before performing the installation procedure.

About this task

The following images indicate the location of the chassis fan and provide a visual representation of the installation procedure.



1x
M3x5

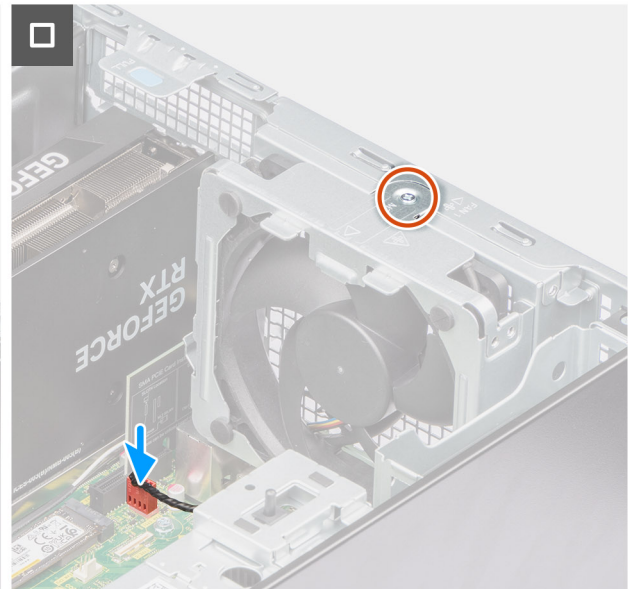
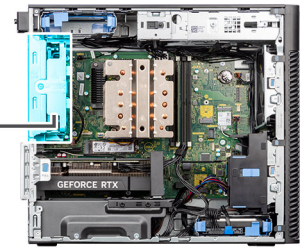
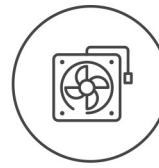



Figure 67. Installing the rear fan (1000W PSU)

Steps

1. Align and place the system fan into the chassis.
2. Connect the fan cable to the connector on the system board.
3. Replace the M3x5 screw to secure the system fan to the chassis.

Next steps

1. Install the [air shroud](#).
-  **NOTE:** For systems with 1000W PSU only.
2. Install the [side cover](#).
3. Follow the procedure in [after working inside your computer](#).

Power button

Removing the power button

 **CAUTION:** The information in this removal section is intended for authorized service technicians only.

Prerequisites

1. Follow the procedure in [before working inside your computer](#).
2. Remove the [side cover](#).
3. Remove the [front bezel](#).
4. Remove the [air shroud](#).
-  **NOTE:** For systems with 1000W PSU only.

About this task

The following images indicate the location of the power button and provide a visual representation of the removal procedure.

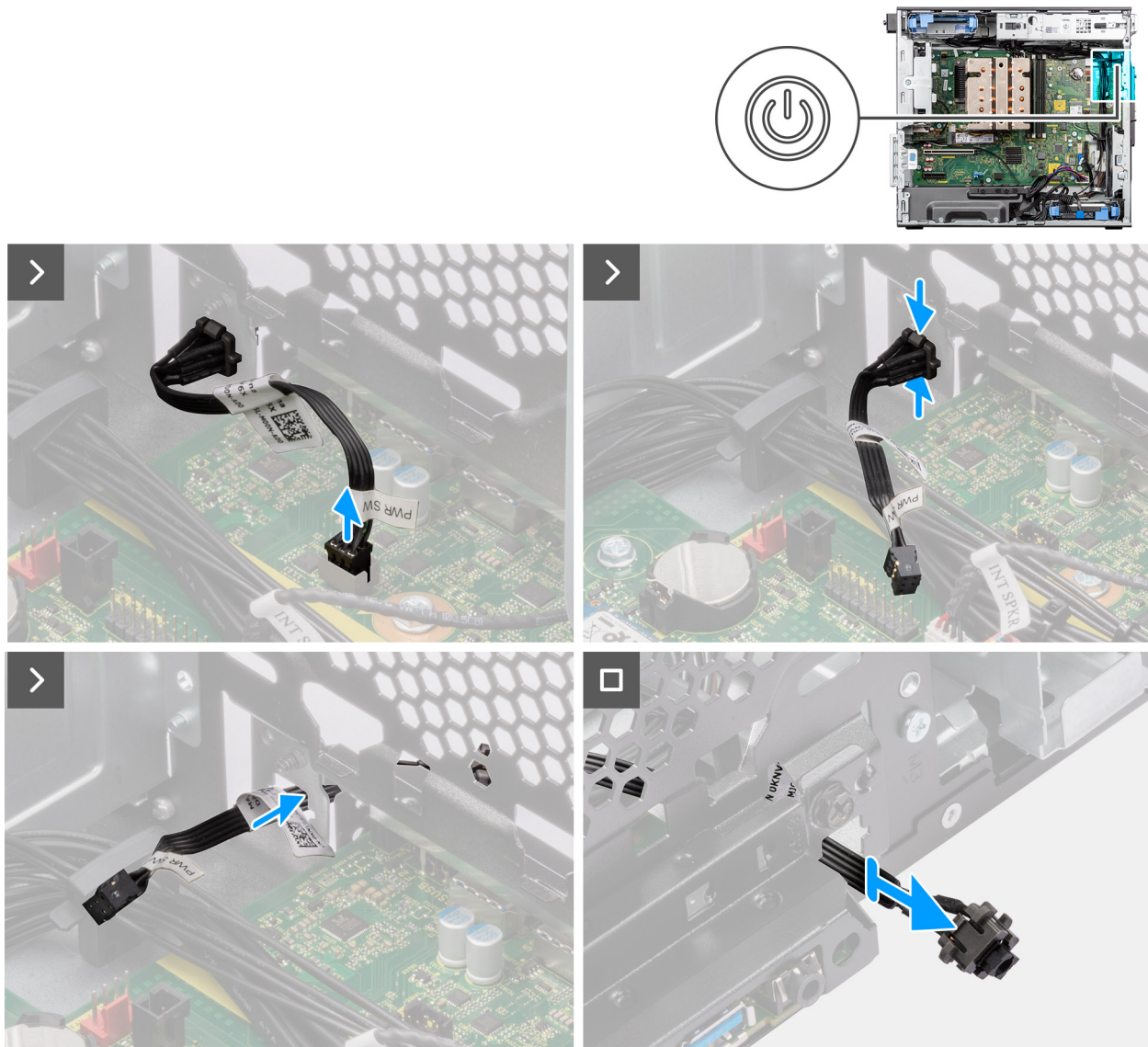

Figure 68. Removing the power button

Steps

1. Disconnect the power-button cable from the connector on the system board.
2. Press the release tabs on the power-button head and slide the power-button cable out from the front-side chassis of the computer.
3. Pull the power-button cable out from the computer.

Installing the power button

CAUTION: The information in this installation section is intended for authorized service technicians only.

Prerequisites

If you are replacing a component, remove the existing component before performing the installation procedure.

About this task

The following images indicate the location of the power button and provide a visual representation of the installation procedure.

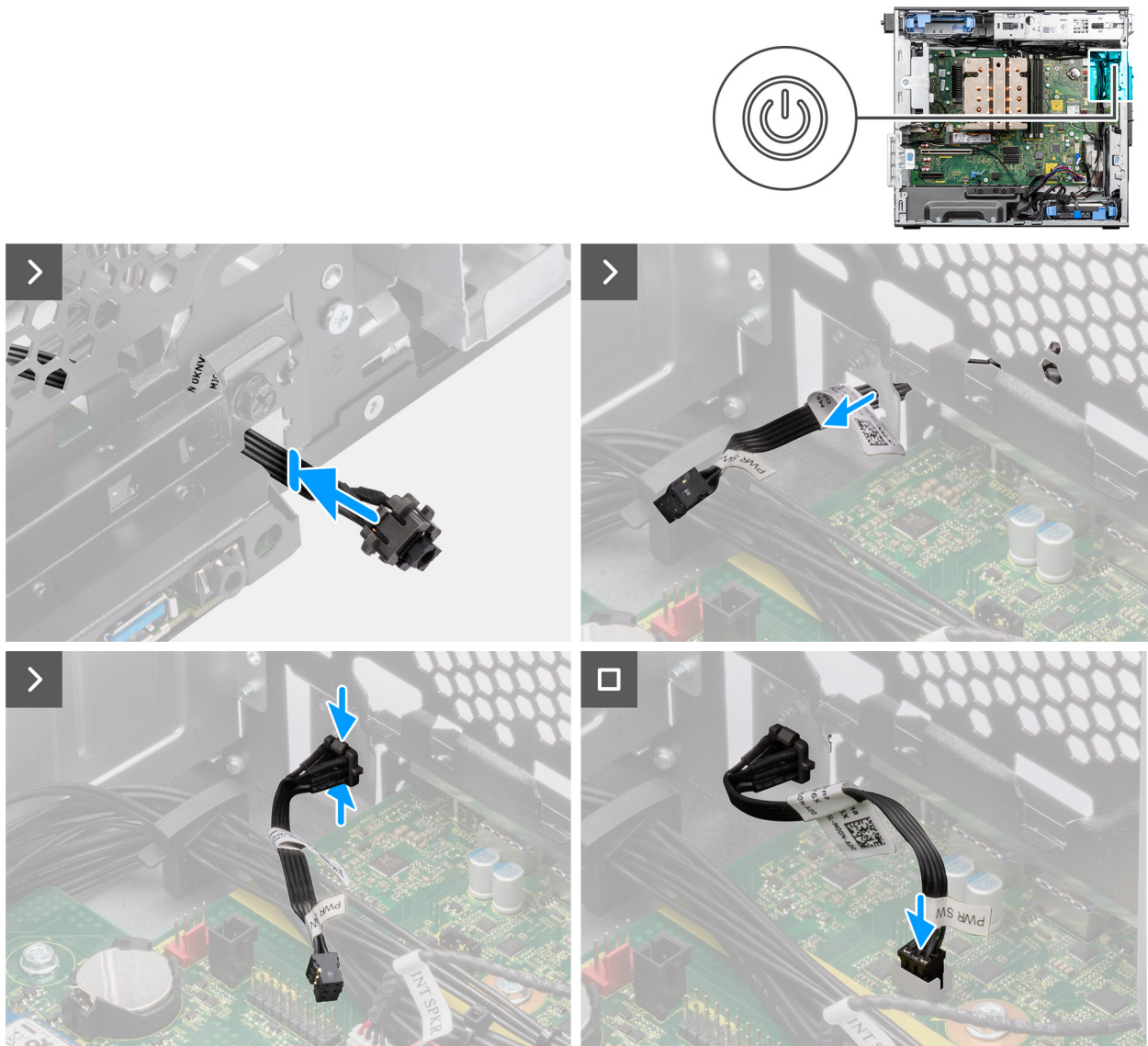

Figure 69. Installing the power button

Steps

1. Insert the power-button cable into the slot from the front-side of the computer, and press the power-button head until it secures into the place in the chassis.
2. Align and connect the power-button cable to the connector on the system board.

Next steps

1. Install the [air shroud](#).
NOTE: For systems with 1000W PSU only.
2. Install the [front bezel](#).
3. Install the [side cover](#).
4. Follow the procedure in [after working inside your computer](#).

Intrusion switch

Removing the intrusion switch

CAUTION: The information in this removal section is intended for authorized service technicians only.

Prerequisites

1. Follow the procedure in [before working inside your computer](#).
2. Remove the [side cover](#).
3. Remove the [air shroud](#).

NOTE: For systems with 1000W PSU only.

About this task

The following images indicate the location of the intrusion switch and provide a visual representation of the removal procedure.

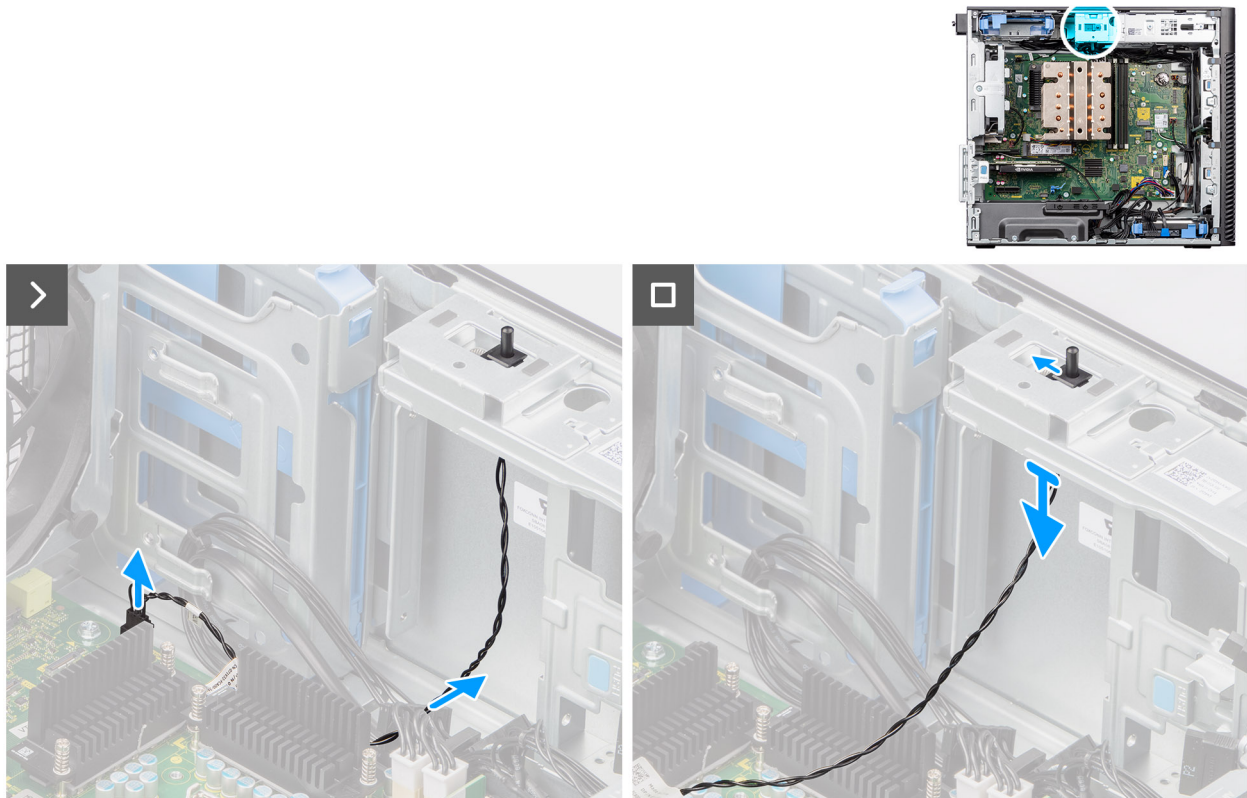

Figure 70. Removing the intrusion switch

Steps

1. Disconnect the intruder switch cable from the connector on the system board and unroute the cable from the routing guide.
2. Slide and remove the intrusion switch from the chassis.

Installing the intrusion switch

CAUTION: The information in this installation section is intended for authorized service technicians only.

Prerequisites

If you are replacing a component, remove the existing component before performing the installation procedure.

About this task

The following image indicates the location of the intrusion switch and provides a visual representation of the installation procedure.

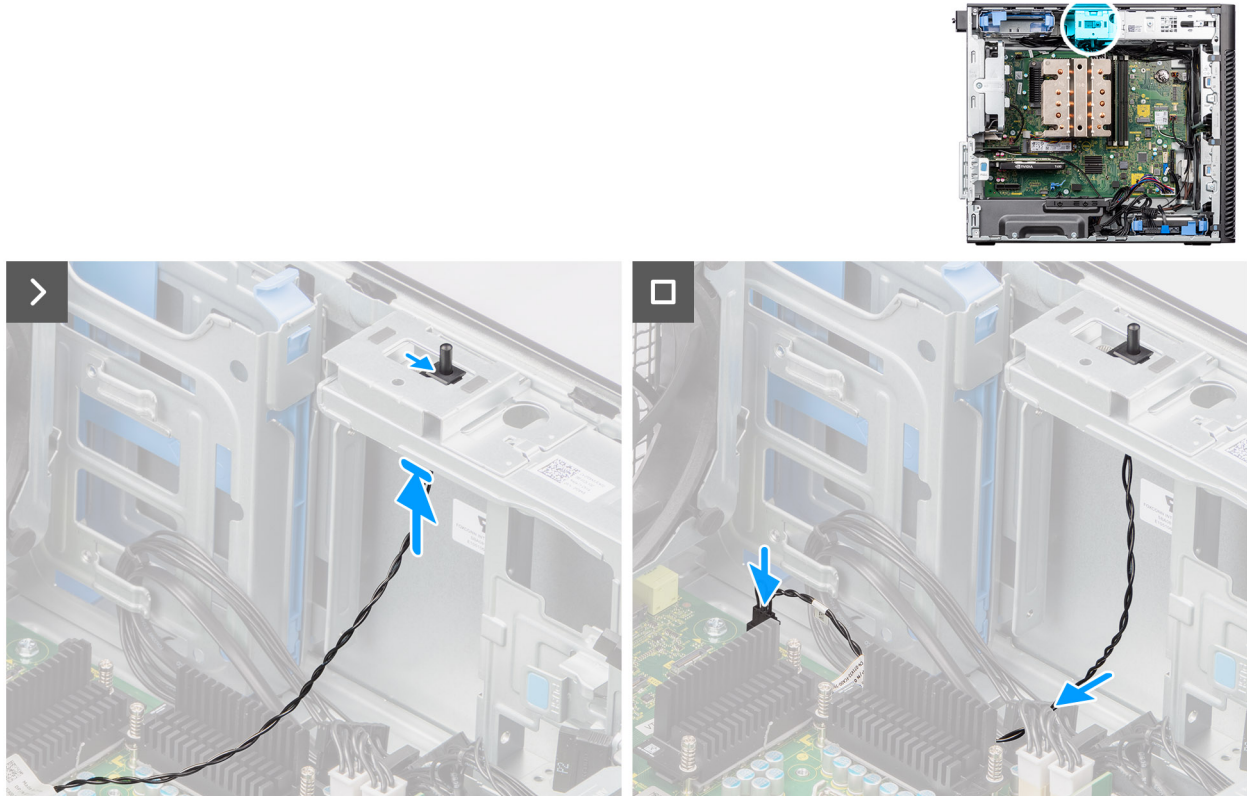

Figure 71. Installing the intrusion switch

Steps

1. Insert the intrusion switch into its slot and slide the switch to secure it into the slot.
2. Route the intruder switch cable through the routing guide and connect the intruder cable to the connector on the system board.

Next steps

1. Install the [air shroud](#).
NOTE: For systems with 1000W PSU only.
2. Install the [side cover](#).
3. Follow the procedure in [after working inside your computer](#).

Internal speaker

Removing the internal speaker

CAUTION: The information in this removal section is intended for authorized service technicians only.

Prerequisites

1. Follow the procedure in [before working inside your computer](#).
2. Remove the [side cover](#).
3. Remove the [air shroud](#).

 **NOTE:** For systems with 1000W PSU only.

About this task

The following images indicate the location of the internal speaker and provide a visual representation of the removal procedure.

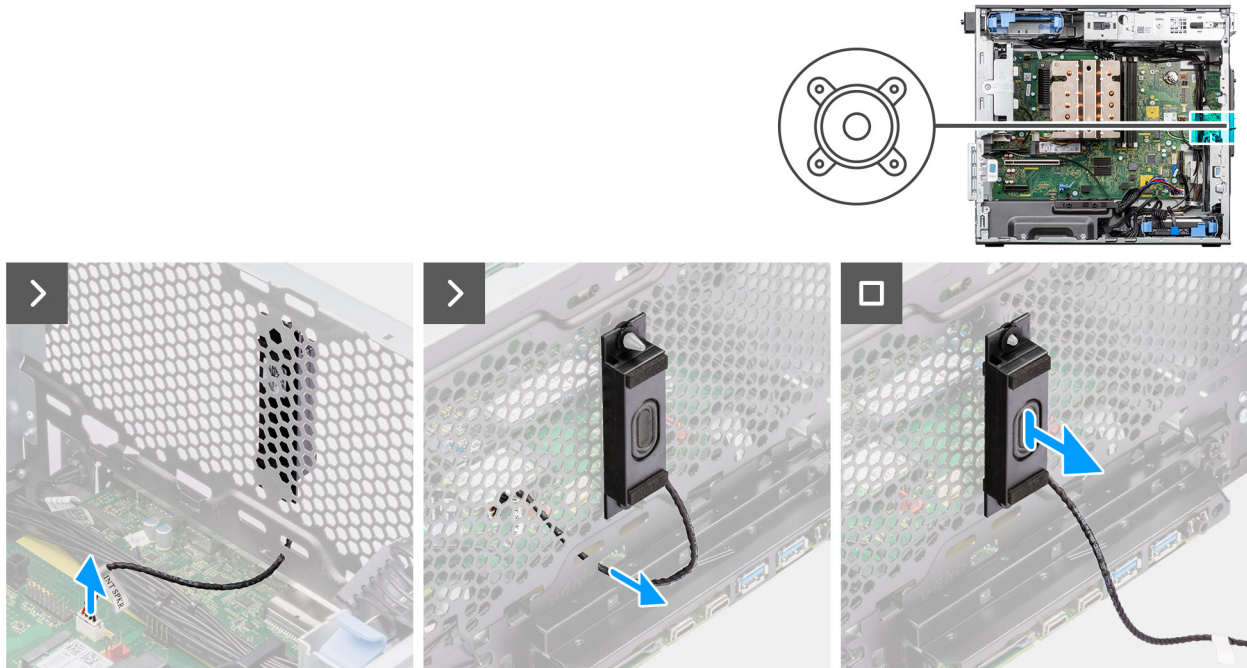

Figure 72. Removing the internal speaker

Steps

1. Disconnect the internal speaker cable from the connector on the system board.
2. Unroute the internal speaker cable through the recess on the chassis.
3. Slide and remove the internal speaker from the chassis.

Installing the internal speaker

 **CAUTION:** The information in this installation section is intended for authorized service technicians only.

Prerequisites

If you are replacing a component, remove the existing component before performing the installation procedure.

About this task

The following images indicate the location of the internal speaker and provide a visual representation of the installation procedure.

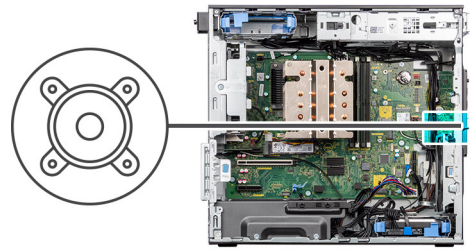

Figure 73. Installing the internal speaker

Steps

1. Align the holes on the internal speaker with the alignment post on the chassis.
2. Insert the internal speaker into its slot.
3. Route the internal speaker cable through the recess on the front of the chassis.
4. Connect the internal speaker cable to the connector on the system board.

Next steps

1. Install the [air shroud](#).
 - NOTE:** For systems with 1000W PSU only.
2. Install the [side cover](#).
3. Follow the procedure in [after working inside your computer](#).

System board

Removing the system board

CAUTION: The information in this removal section is intended for authorized service technicians only.

Prerequisites

1. Follow the procedure in [before working inside your computer](#).
 - NOTE:** Your computer's Service Tag is stored in the system board. You must enter the Service Tag in the BIOS setup program after you replace the system board.
 - NOTE:** Replacing the system board removes any changes that you have made to the BIOS using the BIOS setup program. You must make the appropriate changes again after you replace the system board.
 - NOTE:** Before disconnecting the cables from the system board, note the location of the connectors so that you can reconnect the cables correctly after you replace the system board.
2. Remove the [side cover](#).

3. Remove the [front bezel](#).
4. Remove the [air shroud](#).
 - NOTE:** For systems with 1000W PSU only.
5. Remove the [3.5-inch HDD](#).
6. Remove the [M.2 2230 SSD/M.2 2280 SSD](#).
7. Remove the [WLAN](#).
8. Remove the [coin-cell battery](#).
9. Remove the [memory module](#).
10. Remove the [graphics card](#).
11. Remove the [powered GPU](#).
 - NOTE:** This step is required only if the system is configured with a powered GPU.
12. Remove the [125 W heat-sink assembly](#) or [65 W heat-sink assembly](#).
13. Remove the [processor](#).
14. Remove the [front chassis fan](#) and [rear chassis fan](#).
15. Remove the [intrusion switch](#).
16. Remove the [internal speaker](#).

About this task

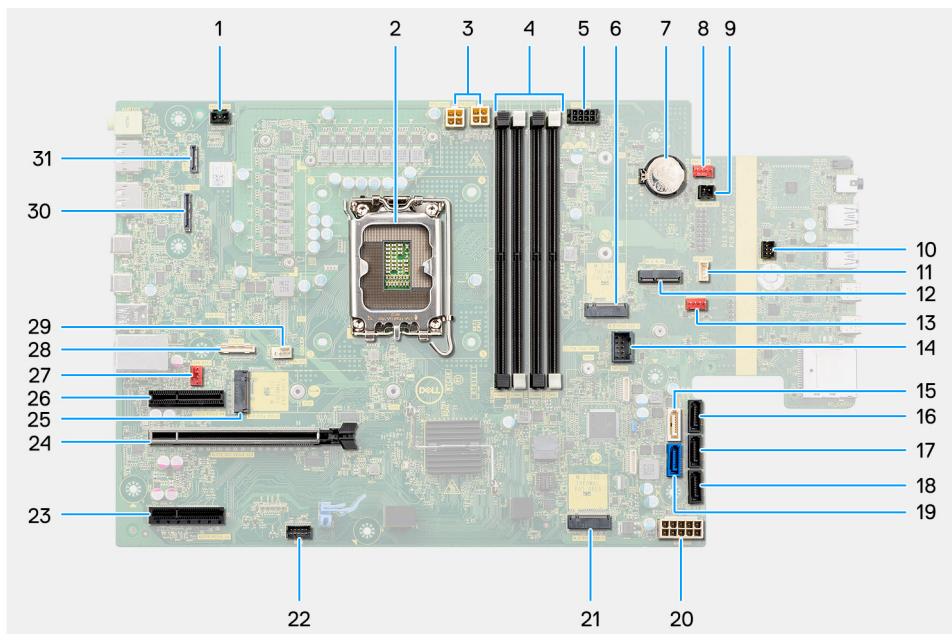

Figure 74. System-board callouts

Table 27. Precision 3680 Tower system board callouts

No	Connector	Description
1	INTRUSION	Intrusion switch connector
2	CPU0_SKT	Processor socket
3	ATX CPU1 and ATX CPU2	4-pin processor power connectors
4	DIMM1 to DIMM4	Memory module connectors
5	SATA PWR1	SATA power connector
6	M.2 PCIe SSD-1	M2 SSD slot
7	RTC	Coin cell battery
8	FAN SYS3	System fan connector 3

Table 27. Precision 3680 Tower system board callouts (continued)

No	Connector	Description
9	PWR REMOTE	Power remote connector
10	PWR_SW	Power switch connector
11	INT SPKR	Internal speaker connector
12	M.2 WLAN	WLAN slot
13	FAN SYS2	System fan connector 2
14	INT USB	Internal USB connector
15	SATA-4	SATA 4 connector
16	SATA-3	SATA 3 connector
17	SATA-2	SATA 2 connector
18	SATA-1	SATA 1 connector
19	SATA-0	SATA 0 connector
20	ATX SYS	ATX system power connector
21	M.2 PCIe SSD-2	M.2 PCIe SSD slot
22	TBT	Thunderbolt connector
23	SLOT4 PCIe4 x4	PCIe x4 connector
24	SLOT2 PCIe5 x16	PCIe x16 connector
25	M.2 PCIe SSD-0	M.2 PCIe SSD slot
26	SLOT1 PCIe3 x4	PCIe x4 connector
27	FAN SYS1	System fan connector 1
28	TYPE-C	Type-C connector
29	FAN CPU	CPU fan connector
30	VIDEO	Video card connector
31	LAN	LAN connector

The following images indicate the location of the system board and provide a visual representation of the removal procedure.



10x
#6-32



2x
M2

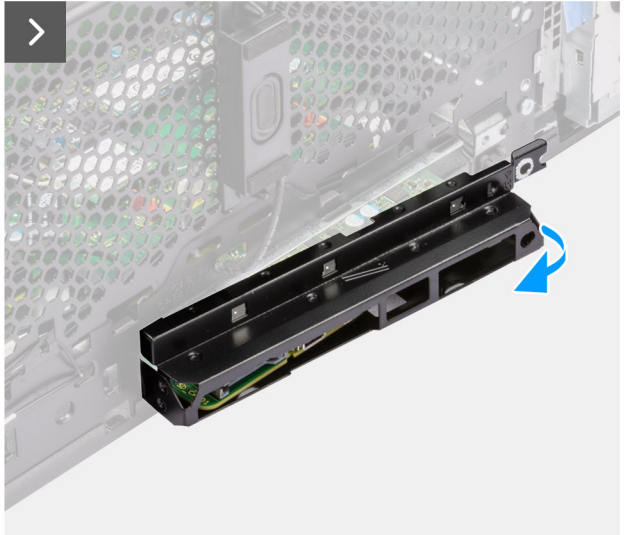
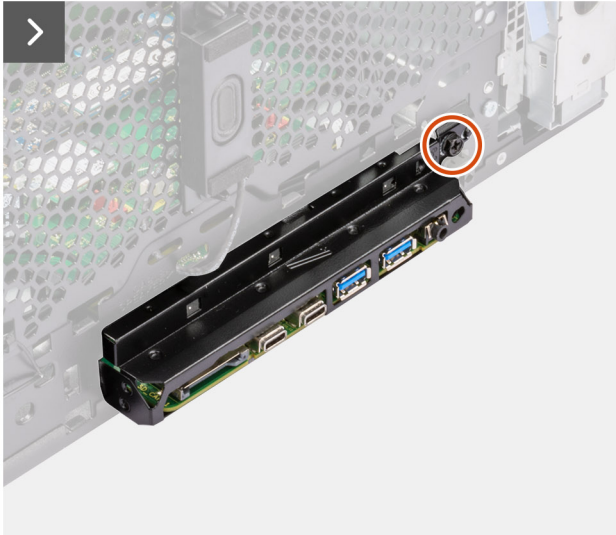
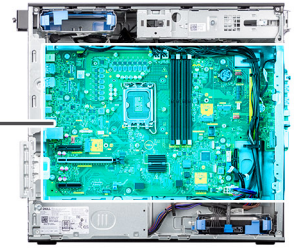
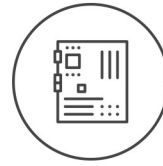

Figure 75. Removing the system board

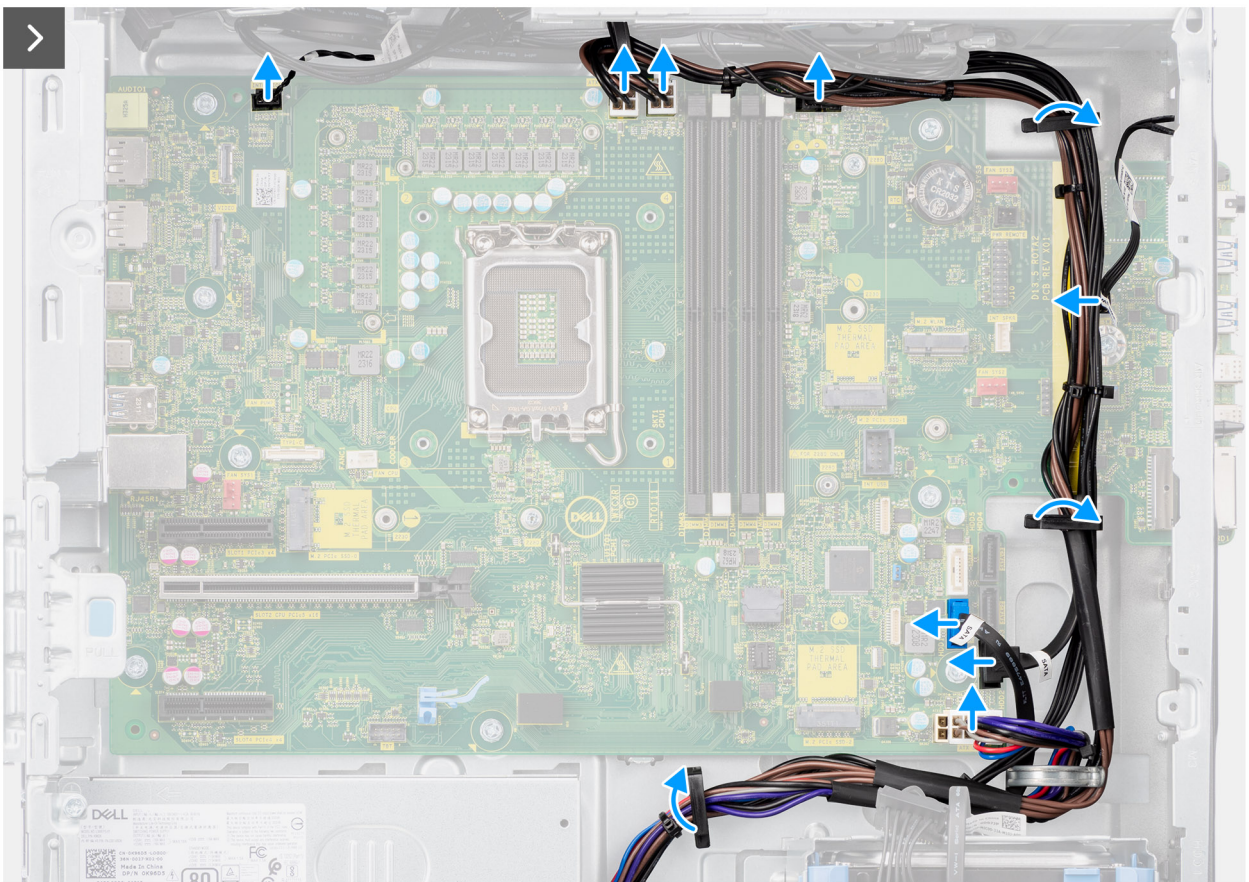

Figure 76. Removing the system board

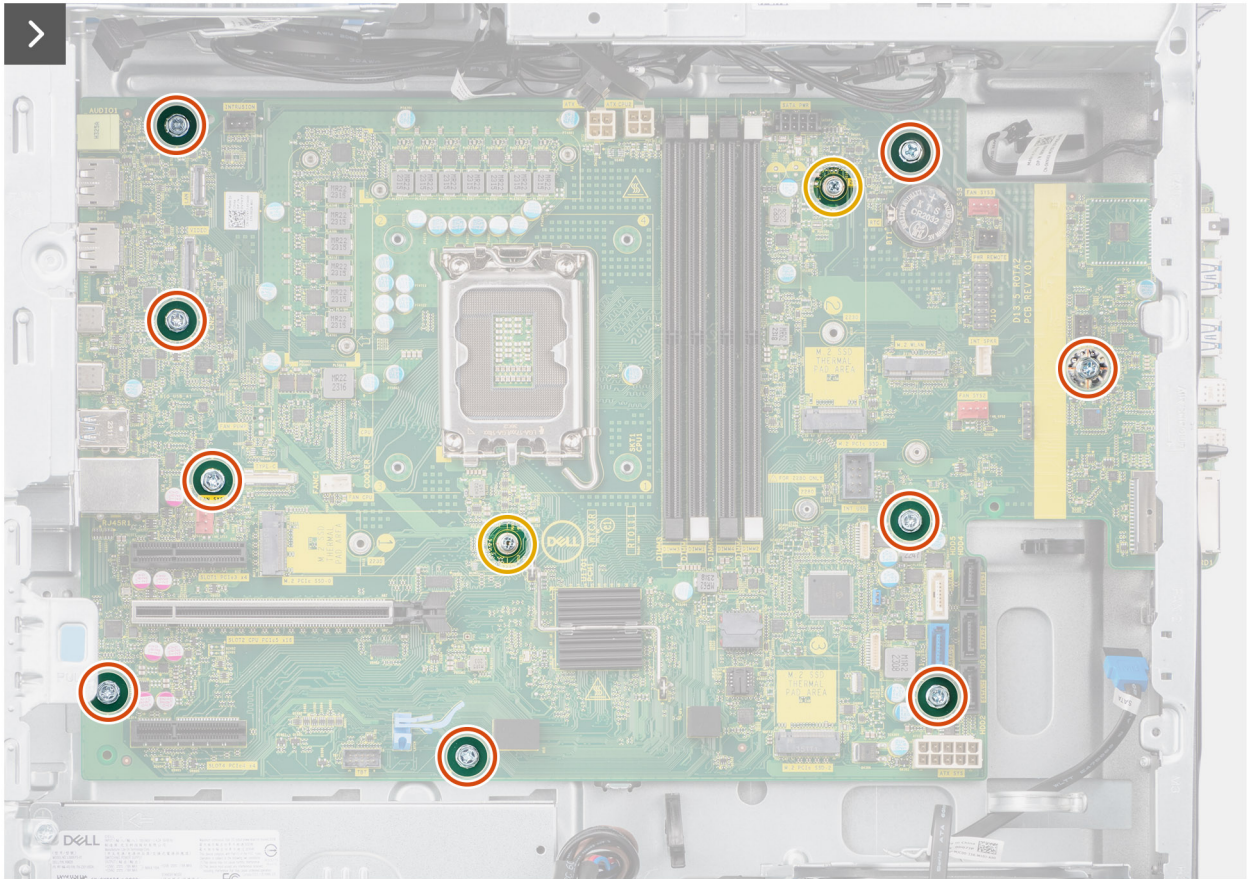

Figure 77. Removing the system board

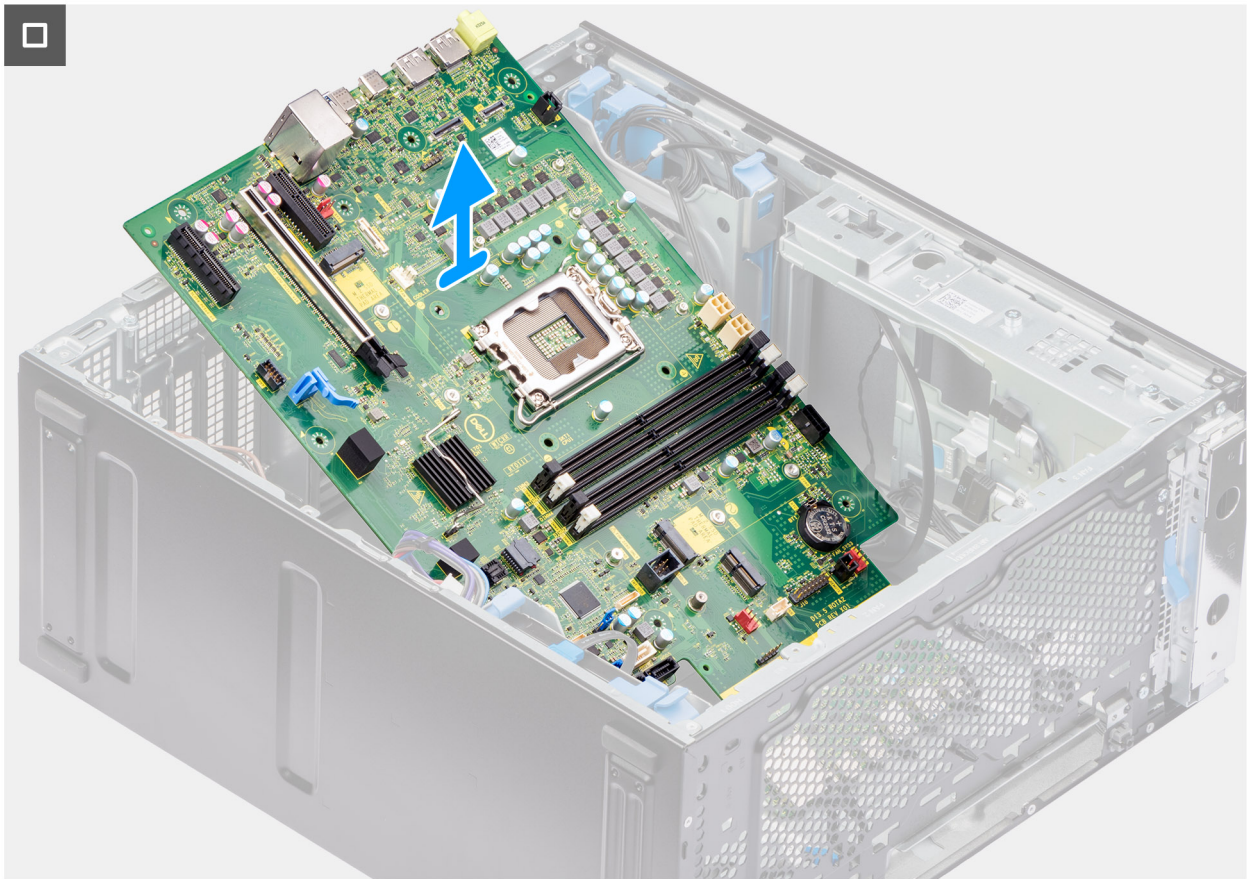

Figure 78. Removing the system board

Steps

1. Remove the (#6-32) screw that secures the front I/O-bracket to the chassis.
2. Slide and remove the front I/O-bracket from the chassis.
3. Disconnect the power and hard drive cables that are connected to the system board and unroute them from the routing guides on the chassis.
4. Remove the nine (#6-32) and two (M2) screws that secure the system board to the chassis.
5. Lift the system board at an angle and remove the system board from the chassis.

Installing the system board

CAUTION: The information in this installation section is intended for authorized service technicians only.

Prerequisites

If you are replacing a component, remove the existing component before performing the installation procedure.

About this task

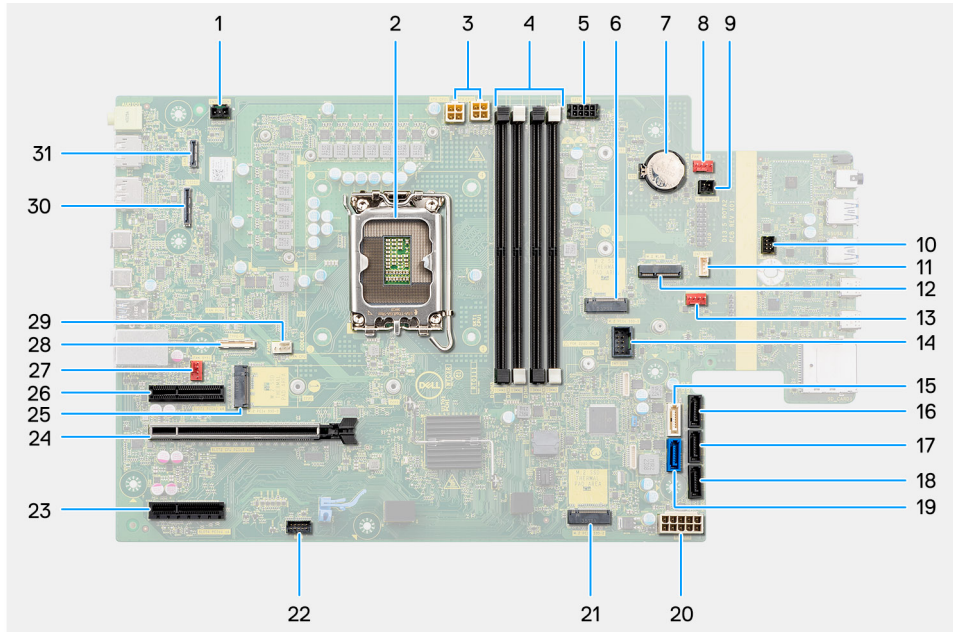

Figure 79. System-board callouts

Table 28. Precision 3680 Tower system board callouts

No	Connector	Description
1	INTRUSION	Intrusion switch connector
2	CPU0_SKT	Processor socket
3	ATX CPU1 and ATX CPU2	4-pin processor power connectors
4	DIMM1 to DIMM4	Memory module connectors
5	SATA PWR1	SATA power connector
6	M.2 PCIe SSD-1	M2 SSD slot
7	RTC	Coin cell battery
8	FAN SYS3	System fan connector 3
9	PWR REMOTE	Power remote connector
10	PWR_SW	Power switch connector
11	INT SPKR	Internal speaker connector
12	M.2 WLAN	WLAN slot
13	FAN SYS2	System fan connector 2
14	INT USB	Internal USB connector
15	SATA-4	SATA 4 connector
16	SATA-3	SATA 3 connector
17	SATA-2	SATA 2 connector
18	SATA-1	SATA 1 connector
19	SATA-0	SATA 0 connector
20	ATX SYS	ATX system power connector

Table 28. Precision 3680 Tower system board callouts (continued)

No	Connector	Description
21	M.2 PCIe SSD-2	M.2 PCIe SSD slot
22	TBT	Thunderbolt connector
23	SLOT4 PCIe4 x4	PCIe x4 connector
24	SLOT2 PCIe5 x16	PCIe x16 connector
25	M.2 PCIe SSD-0	M.2 PCIe SSD slot
26	SLOT1 PCIe3 x4	PCIe x4 connector
27	FAN SYS1	System fan connector 1
28	TYPE-C	Type-C connector
29	FAN CPU	CPU fan connector
30	VIDEO	Video card connector
31	LAN	LAN connector

The following images indicate the location of the system board and provide a visual representation of the installation procedure.



10x
#6-32



2x
M2

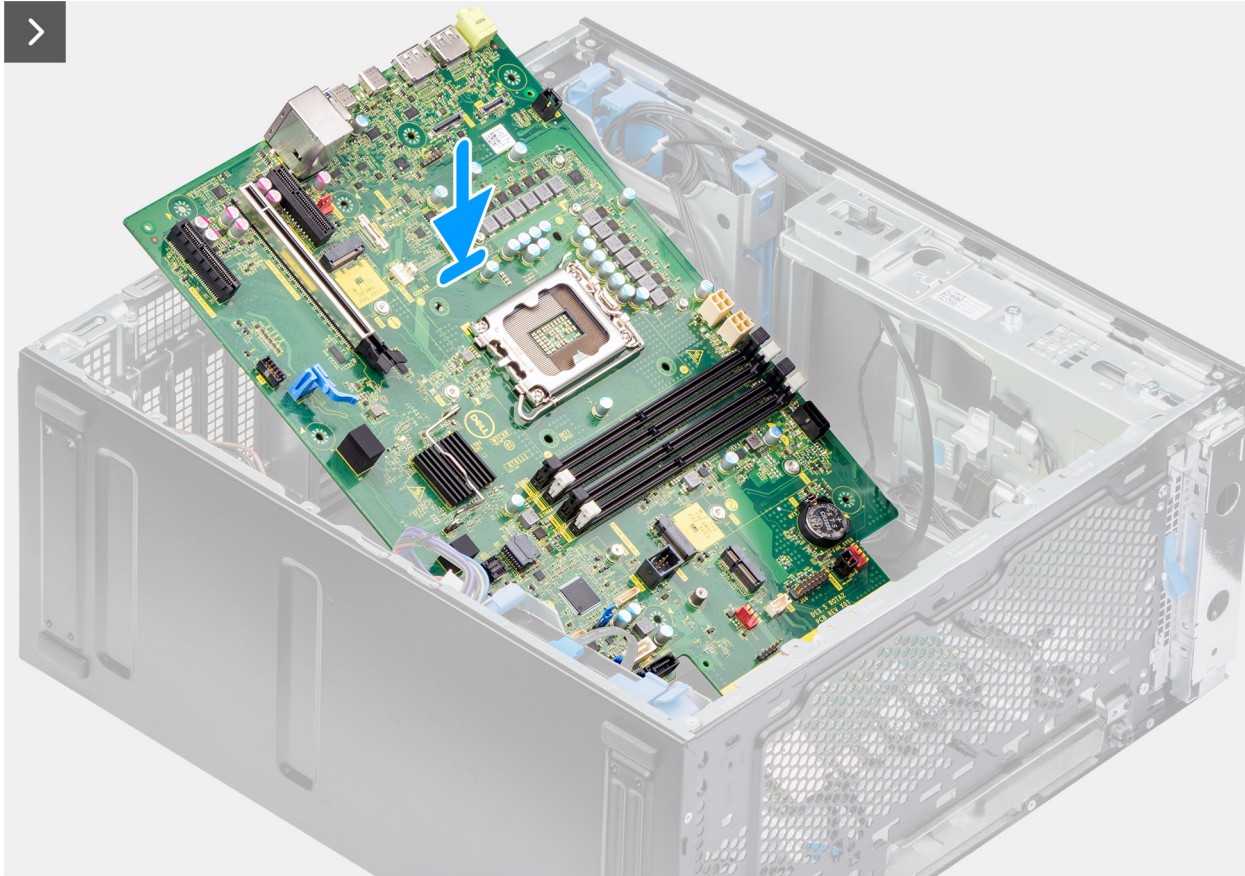

Figure 80. Installing the system board

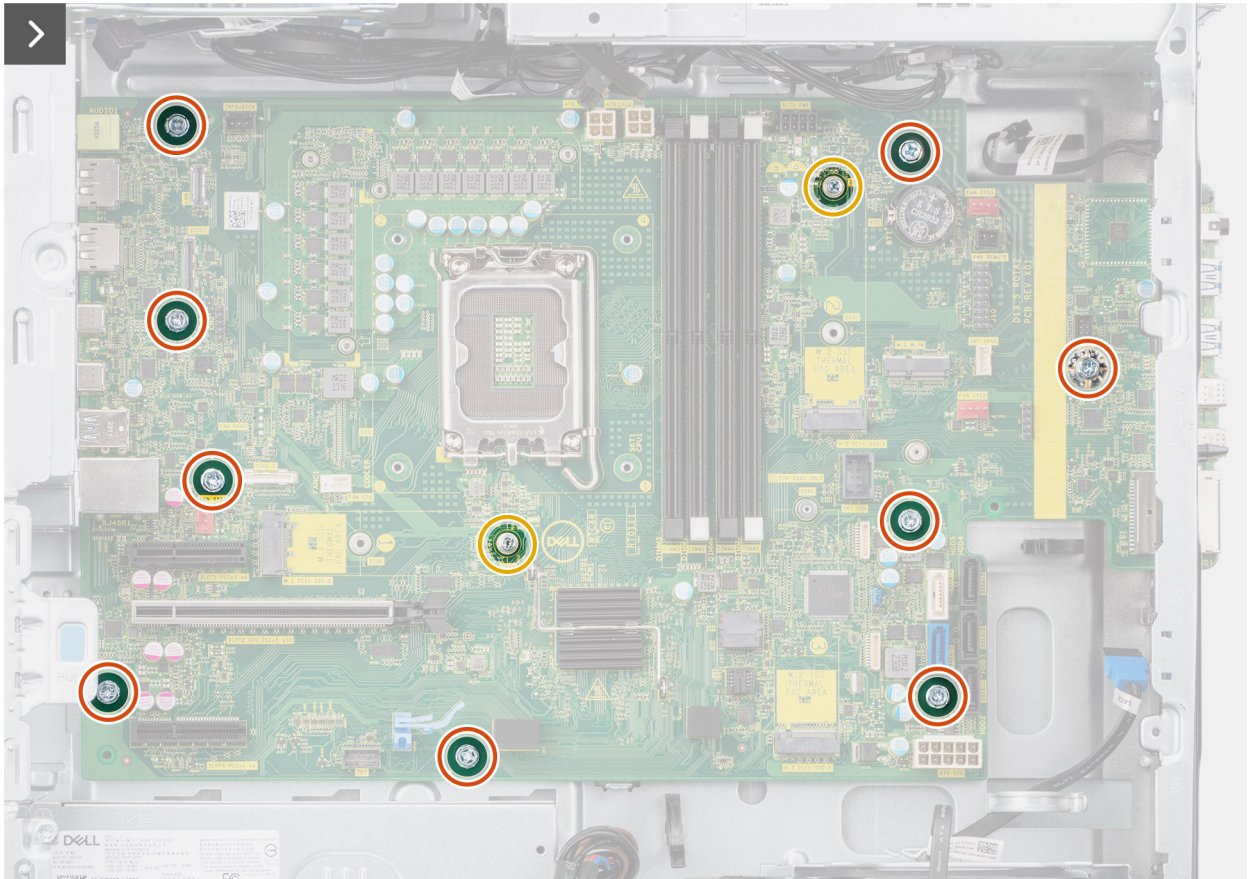

Figure 81. Installing the system board

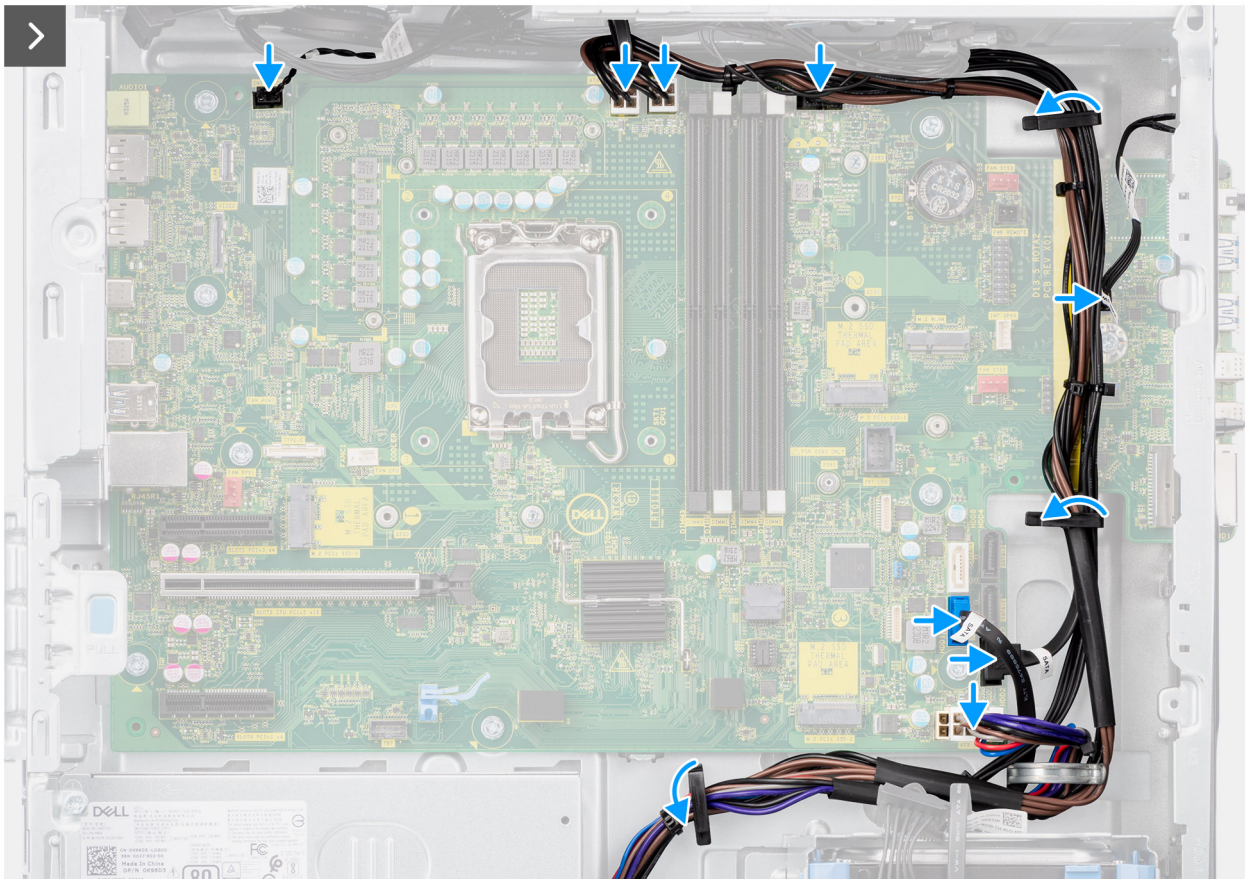

Figure 82. Installing the system board

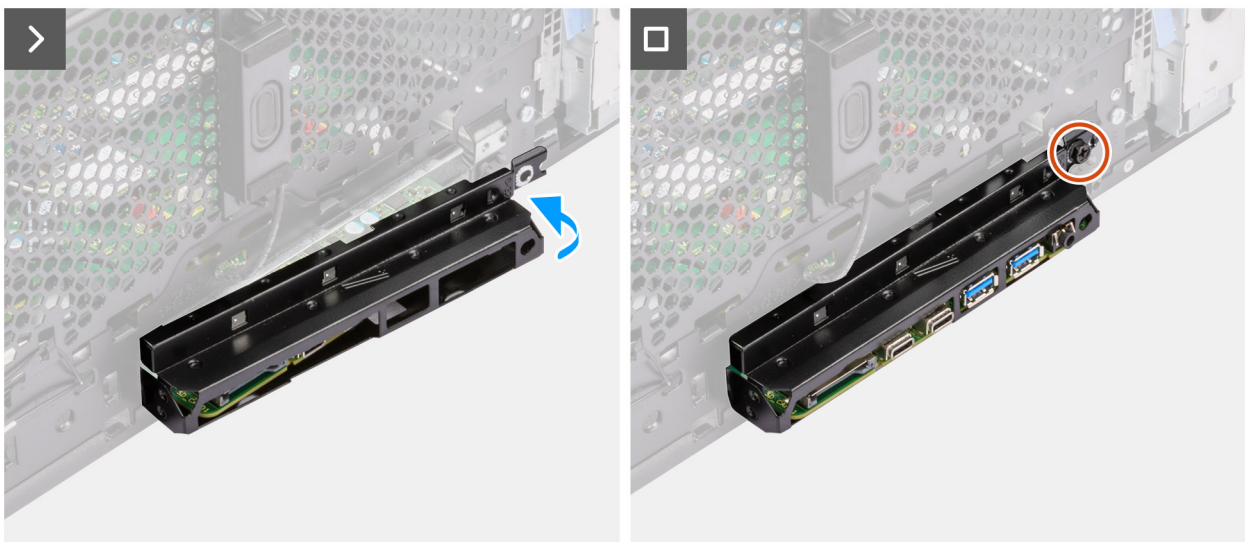

Figure 83. Installing the system board

Steps

1. Slide the front I/O ports on the system board into the front I/O slots on the chassis and align the screw holes on the system board with the screw holes on the chassis.
2. Replace the nine (#6-32) and two (M2) screws that secure the system board to the chassis.
3. Route the cables through the routing guides on the chassis and connect the power and hard drive cables to their respective connectors on the system board.
4. Align the front I/O bracket with the slots on the chassis.

5. Replace the (#6-32) screw that secures the front I/O bracket to the chassis.

Next steps

1. Install the [internal speaker](#).
2. Install the [intrusion switch](#).
3. Install the [front chassis fan](#) and [rear chassis fan](#).
4. Install the [processor](#).
5. Install the [125 W heat-sink assembly](#) or [65 W heat-sink assembly](#).
6. Install the [powered GPU](#).
i **NOTE:** This step is required only if the system is configured with a powered GPU.
7. Install the [graphics card](#).
8. Install the [memory module](#).
9. Install the [coin-cell battery](#).
10. Install the [WLAN](#).
11. Install the [M.2 2230 SSD/M.2 2280 SSD](#).
12. Install the [3.5-inch HDD](#).
13. Install the [air shroud](#).
i **NOTE:** For systems with 1000W PSU only.
14. Install the [front bezel](#).
15. Install the [side cover](#).
16. Follow the procedure in [after working inside your computer](#).
i **NOTE:** Your computer's Service Tag is stored on the system board. You must enter the Service Tag in the BIOS setup program after you replace the system board.
i **NOTE:** Replacing the system board removes any changes that you have made to the BIOS using the BIOS setup program. You must make the appropriate changes again after you replace the system board.

Software

This chapter details the supported operating systems along with instructions on how to install the drivers.

Operating system

Your Precision 3680 Tower supports the following operating systems:

- Windows 11 Home, 64-bit
- Windows 11 Pro, 64-bit
- Windows 11 Pro National Education, 64-bit
- Windows 11 Pro for Workstations
- Ubuntu Linux 22.04 LTS, 64-bit

Drivers and downloads

When troubleshooting, downloading, or installing drivers, it is recommended that you read the Dell Knowledge Base article [Drivers and Downloads FAQs 000123347](#).

Technology and components

NOTE: Instructions that are provided in the following section are applicable on computers that are shipped with the Windows operating system. Windows is factory-installed with this computer.

System management features

Dell commercial systems come with several systems management options that are included by default for In-Band management with our Dell Client Command Suite. In-Band management meaning that the Operating System is functional, and the device is connected to a network so that it can be managed. The Dell Client Command Suite of tools can be leveraged individually or with a systems management console like SCCM, LANDESK, KACE.

We also offer Out-of-Band management as an option. Out-of-band management is when the system does not have a functional operating system or is turned off and you still want to be able to manage the system in that state.

Dell Client Command Suite for in-band systems management

Dell Client Command Suite is a free toolkit available for download, for all Latitude Rugged tablets at dell.com/support, that automates and streamlines systems management tasks, saving time, money, and resources. It consists of the following modules that can be used independently, or with a variety of systems management consoles such as SCCM.

Dell Client Command Suite's integration with VMware Workspace ONE Powered by AirWatch, now allows customers to manage their Dell client hardware from the cloud, using a single Workspace ONE console.

Dell Command | Deploy enables easy operating system (OS) deployment across all major OS deployment methodologies and provides numerous system-specific drivers that have been extracted and reduced to an OS-consumable state.

Dell Command | Configure is a graphical user interface (GUI) admin tool for configuring and deploying hardware settings in a pre-OS or post-OS environment, and it operates seamlessly with SCCM and Airwatch and can be self-integrated into LANDesk and KACE. Simply, this is all about the BIOS. Command | Configure allows you to remotely automate and configure over 150+ BIOS settings for a personalized user experience.

Dell Command | PowerShell Provider can do the same things as Command | Configure, but with a different method. PowerShell is a scripting language that allows customers to create a customized and dynamic configuration process.

Dell Command | Monitor is a Windows Management Instrumentation (WMI) agent that provides IT admins with an extensive inventory of the hardware and health-state data. Admins can also configure hardware remotely by using command line and scripting.

Dell Command | Update (end-user tool) is factory-installed and allows admins to individually manage and automatically present and install Dell updates to the BIOS, drivers, and software. Command | Update eliminates the time-consuming hunting and pecking process of update installation.

Dell Command | Update Catalog provides searchable metadata that allows the management console to retrieve the latest system-specific updates (driver, firmware or BIOS). The updates are then delivered seamlessly to end-users using the customer's systems management infrastructure that is consuming the catalog (like SCCM).

Dell Command | vPro Out of Band console extends hardware management to systems that are offline or have an unreachable OS (Dell exclusive features).

Dell Command | Integration Suite for System Center - This suite integrates all the key components of the Client Command Suite into Microsoft System Center Configuration Manager 2012 and Current Branch versions.

Out-of-band systems management

Intel Standard Manageability option **must be configured in our factory at the time of purchase, as it is NOT field upgradable.** It offers out-of-band management and DASH compliance ([Certification Registry](#)).

BIOS Setup

CAUTION: Unless you are an expert computer user, do not change the settings in the BIOS Setup. Certain changes can make your computer work incorrectly.

NOTE: Depending on the computer and the installed devices, the options that are listed in this section may or may not be displayed.

NOTE: Before you change the settings in BIOS Setup, it is recommended that you note down the original settings for future reference.

Use BIOS Setup for the following purposes:

- Get information about the hardware installed in your computer, such as the amount of RAM and the size of the storage device.
- Change the system configuration information.
- Set or change a user-selectable option, such as the user password, type of hard drive installed, and enable or disable base devices.

Entering BIOS Setup program

About this task

Turn on (or restart) your computer and press F2 immediately.

Navigation keys

NOTE: For most of the BIOS Setup options, changes that you make are recorded but do not take effect until you restart the computer.

Table 29. Navigation keys

Keys	Navigation
Up arrow	Moves to the previous field.
Down arrow	Moves to the next field.
Enter	Selects a value in the selected field (if applicable) or follows the link in the field.
Spacebar	Expands or collapses a drop-down list, if applicable.
Tab	Moves to the next focus area.
Esc	Moves to the previous page until you view the main screen. Pressing Esc in the main screen displays a message that prompts you to save any unsaved changes and restart the computer.

One time boot menu

To access the **one time boot menu**, turn on your computer, and then press F2 immediately.

NOTE: If your computer fails to enter the boot menu, restart the computer and press F2 immediately.

The one-time boot menu displays the devices that you can boot from, and also displays the option to start diagnostics. The boot menu options are:

- Removable Drive (if available)
- STXXXX Drive (if available)
- **i** **NOTE:** XXX denotes the SATA drive number.
- Optical Drive (if available)
- SATA Hard Drive (if available)
- Diagnostics
- **i** **NOTE:** Choosing **Diagnostics**, will display the **ePSA diagnostics** screen.

The **one time boot menu** also displays the option to access the System Setup screen.

System setup options

i **NOTE:** Depending on your computer and its installed devices, the items that are listed in this section may or may not appear.

Table 30. System setup options—System information menu

Overview	
Precision 3680 Tower	
BIOS Version	Displays the BIOS version number.
Service Tag	Displays the Service Tag of the computer.
Asset Tag	Displays the Asset Tag of the computer.
Manufacture Date	Displays the manufacture date of the computer.
Ownership Date	Displays the ownership date of the computer.
Express Service Code	Displays the express service code of the computer.
Ownership Tag	Displays the Ownership Tag of the computer.
Signed Firmware Update	Displays whether the Signed Firmware Update is enabled on your computer.
Processor Information	
Processor Type	Displays the processor type.
Maximum Clock Speed	Displays the maximum processor clock speed.
Minimum Clock Speed	Displays the minimum processor clock speed.
Current Clock Speed	Displays the current processor clock speed.
Core Count	Displays the number of cores on the processor.
Processor ID	Displays the processor identification code.
Processor L2 Cache	Displays the processor L2 Cache size.
Processor L3 Cache	Displays the processor L3 Cache size.
Microcode Version	Displays the microcode version.
Intel Hyper-Threading Capable	Displays whether the processor is Hyper-Threading (HT) capable.
64-Bit Technology	Displays whether 64-bit technology is used.
Memory Information	
Memory Installed	Displays the total computer memory installed.
Memory Available	Displays the total computer memory available.
Memory Speed	Displays the memory speed.
Memory Channel Mode	Displays single or dual channel mode.

Table 30. System setup options—System information menu (continued)

Overview	
Memory Technology	Displays the technology that is used for the memory.
DIMM 1 Size	Displays the DIMM 1 memory size.
DIMM 2 Size	Displays the DIMM 2 memory size.
DIMM 3 Size	Displays the DIMM 3 memory size.
DIMM 4 Size	Displays the DIMM 4 memory size.
Devices Information	
Video Controller	Displays the video controller type of the computer.
Video Memory	Displays the video memory information of the computer.
Wi-Fi Device	Displays the wireless device information of the computer.
Native Resolution	Displays the native resolution of the computer.
Video BIOS Version	Displays the video BIOS version of the computer.
Audio Controller	Displays the audio controller information of the computer.
Bluetooth Device	Displays the Bluetooth device information of the computer.
LOM MAC Address	Displays the LAN On Motherboard (LOM) MAC address of the computer.
dGPU Video Controller	Displays the discrete video controller type of the computer.
LOM 2 MAC Address	Displays the second LAN On Motherboard (LOM) MAC address of the computer.
Slot 1	Displays the SATA hard drive information of the computer.
Slot 2	Displays the SATA hard drive information of the computer.
Slot 4	Displays the SATA hard drive information of the computer.

Table 31. System setup options—Boot Configuration menu

Boot Configuration	
Boot Sequence	
Boot Mode: UEFI only	Displays the boot mode.
Boot Sequence	Displays the boot sequence.
Force PXE On Next Boot	Enable or disable the Force PXE On the next boot. By default, the Force PXE On Next Boot option is not enabled.
Secure Digital (SD) Card Boot	Enable or disable the SD card read-only boot. By default, the Secure Digital (SD) Card Boot option is not enabled.
Secure Boot	
Enable Secure Boot	Enable or disable the secure boot feature. By default, the option is not enabled.
Enable Microsoft UEFI CA	Enable or disable the Enable Microsoft UEFI CA feature. By default, the Enable Microsoft UEFI CA option is enabled.
Secure Boot Mode	Enable or disable to change the secure boot mode options. By default, the Deployed Mode is enabled.
Expert Key Management	
Enable Custom Mode	Enable or disable the custom mode.

Table 31. System setup options—Boot Configuration menu (continued)

Boot Configuration	
	By default, the custom mode option is not enabled.
Custom Mode Key Management	Select the custom values for expert key management.

Table 32. System setup options—Integrated Devices menu

Integrated Devices	
Date/Time	Displays the current date in MM/DD/YYYY format and current time in HH:MM:SS AM/PM format.
Audio	
Enable Audio	Enable or disable the integrated audio controller. By default, all the options are enabled.
USB Configuration	Enable or disable booting from USB mass storage devices through the boot sequence or boot menu. By default, all the options are enabled.
Front USB Configuration	Enable or disable the individual front USB ports. By default, all the options are enabled.
Rear USB Configuration	Enable or disable the individual rear USB ports. By default, all the options are enabled.
Dust Filter Maintenance	Enable or disable the dust filter maintenance. By default, the Disabled option is enabled.
DellCoreService	Enable or disable the Dell core service. By default, the option is not enabled.

Table 33. System setup options—Storage menu

Storage	
SATA/NVMe Operation	Enable or disable the operating mode of the integrated SATA/NVMe controller. By default, the RAID On option is enabled.
Storage Interface	
Port Enablement	Enable or disable the onboard drives. By default, all the options are enabled.
SMART Reporting	
Enable SMART Reporting	Enable or disable Self-Monitoring, Analysis, and Reporting Technology (SMART) during computer startup. By default, the Enable SMART Reporting option is not enabled.
Drive Information	
SATA-0	
Type	Displays the SATA HDD type information of the computer.
Device	Displays the SATA HDD device information of the computer.
SATA-1	
Type	Displays the SATA HDD type information of the computer.
Device	Displays the SATA HDD device information of the computer.

Table 33. System setup options—Storage menu (continued)

Storage	
SATA-2	
Type	Displays the SATA HDD type information of the computer.
Device	Displays the SATA HDD device information of the computer.
SATA-3	
Type	Displays the SATA HDD type information of the computer.
Device	Displays the SATA HDD device information of the computer.
SATA-4	
Type	Displays the SATA HDD type information of the computer.
Device	Displays the SATA HDD device information of the computer.
M.2 PCIe SSD-0	
Type	Displays the M.2 PCIe SSD-0 type information of the computer.
Device	Displays the M.2 PCIe SSD-0 device information of the computer.
M.2 PCIe SSD-1	
Type	Displays the M.2 PCIe SSD-1 type information of the computer.
Device	Displays the M.2 PCIe SSD-1 device information of the computer.
M.2 PCIe SSD-2	
Type	Displays the M.2 PCIe SSD-2 type information of the computer.
Device	Displays the M.2 PCIe SSD-2 device information of the computer.
Enable MediaCard	
Secure Digital (SD) Card	Enable or disable the SD card. By default, the Secure Digital (SD) Card option is enabled.
Secure Digital (SD) Card Read-Only Mode	Enable or disable the SD card read-only mode. By default, the Secure Digital (SD) Card Read-Only Mode option is not enabled.

Table 34. System setup options—Display menu

Display	
Multi-Display	
Enable Multi-Display	Enable or disable the Enable Multi-Display buttons on the computer. By default, the option is enabled.
Primary Display	
Video Primary Display	Determines the primary display when multiple controllers are available on the computer By default, the Auto option is enabled.
Full Screen Logo	
	Enable or disable the full screen logo. By default, the option is not enabled.

Table 35. System setup options—Connection menu

Connection	
Network Controller Configuration	
Integrated NIC	Controls the onboard LAN controller.

Table 35. System setup options—Connection menu (continued)

Connection	
	By default, the Enabled with PXE option is enabled.
Wireless Device Enable	
WLAN	Enable or disable the internal WLAN device By default, the option is enabled.
Bluetooth	Enable or disable the internal Bluetooth device By default, the option is enabled.
Enable UEFI Network Stack	Enable or disable UEFI Network Stack and controls the onboard LAN Controller. By default, the Auto Enabled option is enabled.
HTTPs Boot Feature	
HTTPs Boot	Enable or disable the HTTPs Boot feature. By default, the HTTPs Boot option is enabled.
HTTPs Boot Mode	With Auto Mode, the HTTPs Boot extracts Boot URL from the DHCP. With Manual Mode, the HTTPs Boot reads Boot URL from the user-provided data. By default, the Auto Mode option is enabled.

Table 36. System setup options—Power menu

Power	
USB PowerShare	
Enable USB PowerShare	Enable or disable the USB PowerShare. By default, the Enable USB PowerShare option is enabled
Thermal Management	
Thermal Management	Enable or disable the Thermal management that allows setting the cooling fan and processor heat management. By default, the Optimized option is enabled
USB Wake Support	
Enable USB Wake Support	When enabled, you can use the USB devices like a mouse or keyboard to wake your computer from standby. By default, the option is disabled.
Block Sleep	Enables to block entering sleep (S3) mode in the operating system. By default, the Block Sleep option is disabled.
Deep Sleep Control	Enable or disable the Deep Sleep mode support. By default, the Enabled in S4 and S5 option is enabled.
Fan Control Override	Enable or disable the fan control override feature. By default, the option is disabled.
Intel Speed Shift Technology	Enable or disable the Intel speed shift technology support. By default, the Intel Speed Shift Technology option is enabled.

Table 37. System setup options—Security menu

Security	
TPM 2.0 Security	
TPM 2.0 Security On	Enable or disable TPM 2.0 security options. By default, the TPM 2.0 Security On option is enabled.
Attestation Enable	Enables to control whether the Trusted Platform Module (TPM) Endorsement Hierarchy is available to the operating system. By default, the Attestation Enable option is enabled.
Key Storage Enable	Enables to control whether the Trusted Platform Module (TPM) Storage Hierarchy is available to the operating system. By default, the Key Storage Enable option is enabled.
SHA-256	BIOS and the TPM will use the SHA-256 hash algorithm to extend measurements into the TPM PCRs during BIOS boot. By default, the SHA-256 option is enabled.
Clear	Enables to clear the TPM owner information and returns the TPM to the default state. By default, the Clear option is disabled.
PPI ByPass for Clear Commands	Controls the TPM Physical Presence Interface (PPI). By default, the PPI ByPass for clear Commands option is disabled.
Intel Total Memory Encryption	
Multi-Key Total Memory Encryption (Up to 16 keys)	Enable or disable the Total Memory Encryption (TME). By default, the option is disabled.
Chassis intrusion	
	Controls the chassis intrusion feature. By default, the option is disabled.
Block Boot Until Cleared	Enable or disable the Block Boot Until Cleared setting. By default, the option is disabled.
SMM Security Mitigation	
	Enable or disable SMM Security Mitigation. By default, the option is enabled.
Data Wipe on Next Boot	
Start Data Wipe	Enable or disable the data wipe on the next boot. By default, the option is disabled.
Absolute	Enable or disable or permanently disable the BIOS module interface of the optional Absolute Persistence Module service from Absolute software. By default, the Enable Absolute option is enabled.
UEFI Boot Path Security	Controls whether or not the computer will prompt the user to enter the admin password (if set) when booting to a UEFI boot device from the F12 boot menu. By default, the Always Except Internal HDD option is enabled.

Table 38. System setup options—Passwords menu

Passwords	
Admin Password	Set, change, or delete the administrator password.
System Password	Set, change, or delete the computer password.
Internal HDD-0 Password	Set, change, or delete the Internal HDD-0 password.

Table 38. System setup options—Passwords menu (continued)

Passwords	
NVMe SSD0	Set, change, or delete the NVMe SSD0 password.
Password Configuration	
Upper Case Letter	Reinforces password must have at least one upper case letter. By default, the option is disabled.
Lower Case Letter	Reinforces password must have at least one lower case letter. By default, the option is disabled.
Digit	Reinforces password must have at least one digit. By default, the option is disabled.
Special Character	Reinforces password must have at least one special character. By default, the option is disabled.
Minimum Characters	Set the minimum characters allowed for a password.
Password Bypass	When enabled, this always prompts for computer and internal hard drive passwords when turned on from the off state. By default, the Disabled option is enabled.
Password Changes	
Enable Non-Admin Password Changes	Enable or disable to change the computer and hard drive password without the need for an admin password. By default, the option is enabled.
Admin Setup Lockout	
Enable Admin Setup Lockout	Enables administrators control over how their users can or cannot access BIOS setup. By default, the option is disabled.
Master Password Lockout	
Enable Master Password Lockout	When enabled, this will disable the master password support. By default, the option is disabled.
Allow Non-Admin PSID Revert	
Enable Allow Non-Admin PSID Revert	Controls access to the Physical Security ID (PSID) revert of NVMe hard-drives from the Dell Security Manager prompt. By default, the option is disabled.

Table 39. System setup options—Update, Recovery menu

Update, Recovery	
UEFI Capsule Firmware Updates	Enable or disable BIOS updates through UEFI capsule update packages. By default, the option is enabled.
BIOS Recovery from Hard Drive	Enables the user to recover from certain corrupted BIOS conditions from a recovery file on the user primary hard drive or an external USB key. By default, the option is enabled.
BIOS Downgrade	
Allow BIOS Downgrade	Enable or disable the flashing of the computer firmware to previous revision is blocked.

Table 39. System setup options—Update, Recovery menu (continued)

Update, Recovery	
SupportAssist OS Recovery	<p>By default, the option is enabled.</p> <p>Enable or disable the boot flow for SupportAssist OS Recovery tool in the event of certain computer errors.</p> <p>By default, the option is enabled.</p>
BIOSConnect	<p>Enable or disable cloud Service OS recovery if the main operating system fails to boot with the number of failures equal to or greater than the value specified by the Auto OS Recovery Threshold setup option and local Service OS does not boot or is not installed.</p> <p>By default, the option is enabled.</p>
Dell Auto OS Recovery Threshold	<p>Controls the automatic boot flow for SupportAssist System Resolution Console and for Dell OS Recovery Tool.</p> <p>By default, the threshold value is set to 2.</p>

Table 40. System setup options—System Management menu

System Management	
Service Tag	Display the Service Tag of the computer.
Asset Tag	Create a computer Asset Tag.
Wake on LAN/WLAN	<p>Enable or disable the computer to turn on by special LAN signals when it receives a wakeup signal from the WLAN.</p> <p>By default, the Disabled option is selected.</p>
Auto on Time	<p>Enable to set the computer to turn on automatically every day or on a preselected date and time. This option can be configured only if the Auto On Time is set to Everyday, Weekdays, or Selected Days.</p> <p>By default, the option is disabled.</p>
Intel AMT Capability	<p>Enable Intel AMT Capability</p> <p>Enable or disable the Intel AMT capability.</p> <p>By default, the Restrict Preboot Access option is enabled.</p>
MEBx Hotkey	<p>Enable or disable the MEBx hotkey.</p> <p>By default, the option is disabled.</p>
SERR Messages	<p>Enable or disable SERR messages.</p> <p>By default, the option is enabled.</p>
First Power On Date	<p>Set Ownership Date</p> <p>Enable or disable the Ownership date.</p> <p>By default, the option is disabled.</p>
Diagnostics	<p>OS Agent Requests</p> <p>Enable or disable OS agent requests.</p> <p>By default, the option is enabled.</p>
Power-on-Self-Test Automatic Recovery	<p>Enable or disable Power-on-Self-Test Automatic Recovery.</p> <p>By default, the option is enabled.</p>

Table 41. System setup options—Keyboard menu

Keyboard	
Keyboard Errors	
Enable Keyboard Error Detection	Enable or disable the keyboard error detection. By default, the option is enabled.
Numlock LED	
Enable Numlock LED	Enable or disable the Numlock LED. By default, the option is enabled.
Device Configuration Hotkey Access	
Device Configuration Hotkey Access	Enable or disable users to access device configuration by using hotkeys. By default, the option is enabled.

Table 42. System setup options—Pre-boot Behavior menu

Pre-boot Behavior	
Warning and Errors	Enable or disable the action to be done when a warning or error is encountered. By default, the Prompt on Warnings and Errors option is enabled.
Extend BIOS POST Time	Set the BIOS POST time. By default, the 0 seconds option is enabled.

Table 43. System setup options—Virtualization menu

Virtualization	
Intel Virtualization Technology	
Enable Intel Virtualization Technology (VT)	Specify whether a Virtual Machine Monitor (VMM) can use the additional hardware capabilities that are provided by Intel Virtualization Technology. By default, the option is enabled.
VT for Direct I/O	Specify whether a Virtual Machine Monitor (VMM) can use the additional hardware capabilities that are provided by Intel Virtualization Technology for Direct I/O. By default, the option is enabled.
Intel Trusted Execution Technology (TXT)	
Enable Intel Trusted Execution Technology (TXT)	Specifies whether a measured Virtual Machine Monitor (MVMM) can use the additional hardware capabilities that are provided by Intel Trusted Execution Technology. By default, the option is disabled.
DMA Protection	
Enable Pre-Boot DMA Support	This setting controls Pre-boot DMA protection for both Internal and External ports. By default, the option is enabled.
Enable OS kernel DMA Support	This setting controls Kernel DMA protection for both Internal and External ports. By default, the option is enabled.

Table 44. System setup options—Performance menu

Performance	
Multi Core Support	
Active Cores	Enables to change the number of CPU cores available to the operating system. By default, the All Cores options are enabled.
Intel SpeedStep	
Enable Intel SpeedStep Technology	Enables the computer to dynamically adjust processor voltage and core frequency, decreasing average power consumption and heat production. By default, the option is enabled.
C-States Control	
Enable C-State Control	Enable or disable additional processor sleep states. By default, the option is enabled.
Intel Turbo Boost Technology	
Enable Intel Turbo Boost Technology	Enable or disable the Intel TurboBoost mode of the processor. By default, the option is enabled.
Intel Hyper-Threading Technology	
Enable Intel Hyper-Threading Technology	Enable or disable Hyper-Threading in the processor. By default, the option is enabled.
Cache Prefetch	
Hardware Prefetcher	Enable or disable Hardware Prefetcher. By default, the option is enabled.
Adjacent Cache Prefetch	Enable or disable Adjacent Cache Line Prefetch. By default, the option is enabled.
PCIe Link Speed	
	Allows the user to select the maximum PCIe link speed attainable by devices within the system. By default, the Auto option is enabled.
PCIe Resizable Base Address Register (BAR)	
	Enable or disable PCIe Resizable BAR Support. By default, the option is disabled.

Table 45. System setup options—System Logs menu

System Logs	
BIOS Event Log	
Clear BIOS event log	Display BIOS events. By default, the Keep Log option is enabled.

Updating the BIOS

Updating the BIOS in Windows

About this task

 **CAUTION:** If BitLocker is not suspended before updating the BIOS, the next time you reboot the computer it will not recognize the BitLocker key. You will then be prompted to enter the recovery key to progress, and the

computer will ask for this on each reboot. If the recovery key is not known this can result in data loss or an unnecessary operating system reinstall. For more information about this subject, search in the Knowledge Base Resource at [Dell Support Site](#).

Steps

1. Go to [Dell Support Site](#).
2. Click **Product support**. In the **Search support** box, enter the Service Tag of your computer, and then click **Search**.

 **NOTE:** If you do not have the Service Tag, use the SupportAssist to automatically identify your computer. You can also use the product ID or manually browse for your computer model.

3. Click **Drivers & Downloads**. Expand **Find drivers**.
4. Select the operating system installed on your computer.
5. In the **Category** drop-down list, select **BIOS**.
6. Select the latest version of BIOS, and click **Download** to download the BIOS file for your computer.
7. After the download is complete, browse the folder where you saved the BIOS update file.
8. Double-click the BIOS update file icon and follow the on-screen instructions.

For more information, search in the Knowledge Base Resource at [Dell Support Site](#).

Updating the BIOS in Linux and Ubuntu

To update the system BIOS on a computer that is installed with Linux or Ubuntu, see the knowledge base article [000131486](#) at [Dell Support Site](#).

Updating the BIOS using the USB drive in Windows

About this task

 **CAUTION:** If BitLocker is not suspended before updating the BIOS, the next time you reboot the computer it will not recognize the BitLocker key. You will then be prompted to enter the recovery key to progress, and the computer will ask for this on each reboot. If the recovery key is not known this can result in data loss or an unnecessary operating system reinstall. For more information about this subject, search in the Knowledge Base Resource at [Dell Support Site](#).

Steps

1. Follow the procedure from step 1 to step 6 in [Updating the BIOS in Windows](#) to download the latest BIOS setup program file.
2. Create a bootable USB drive. For more information, search in the Knowledge Base Resource at [Dell Support Site](#).
3. Copy the BIOS setup program file to the bootable USB drive.
4. Connect the bootable USB drive to the computer that needs the BIOS update.
5. Restart the computer and press **F12**.
6. Select the USB drive from the **One Time Boot Menu**.
7. Type the BIOS setup program filename and press **Enter**.
The **BIOS Update Utility** appears.
8. Follow the on-screen instructions to complete the BIOS update.

Updating the BIOS from the One-Time boot menu

Update your computer BIOS using the BIOS XXXX.exe file that is copied to a FAT32 USB drive and booting from the One-Time boot menu.

About this task

CAUTION: If BitLocker is not suspended before updating the BIOS, the next time you reboot the computer it will not recognize the BitLocker key. You will then be prompted to enter the recovery key to progress, and the computer will ask for this on each reboot. If the recovery key is not known this can result in data loss or an unnecessary operating system reinstall. For more information about this subject, search in the Knowledge Base Resource at [Dell Support Site](#).

BIOS Update

You can run the BIOS flash update file from Windows using a bootable USB drive or you can also update the BIOS from the One-Time boot menu on the computer.

You can confirm by booting your computer to the **One Time Boot** Menu to see if BIOS FLASH UPDATE is listed as a boot option. If the option is listed, then the BIOS can be updated using this method.

Updating from the One-Time boot menu

To update your BIOS from the One-Time boot menu, you need the following:

- USB drive formatted to the FAT32 file system (the drive does not have to be bootable)
- BIOS executable file that you downloaded from the Dell Support website and copied to the root of the USB drive
- AC power adapter must be connected to the computer
- Functional computer battery to flash the BIOS

Perform the following steps to perform the BIOS flash update process from the One-Time boot menu:

CAUTION: Do not turn off the computer during the BIOS flash update process. The computer may not boot if you turn off your computer.

Steps

1. Turn off your computer, insert the USB drive where you copied the BIOS flash update file into a USB port of the computer.
2. Turn on the computer and press to access the **One Time Boot** Menu. Select BIOS Update using the mouse or arrow keys then press Enter.
The flash BIOS menu is displayed.
3. Click **Flash from file**.
4. Select the external USB device.
5. Select the file and double-click the flash target file, and then click **Submit**.
6. Click **Update BIOS**. The computer restarts to flash the BIOS.
7. The computer will restart after the BIOS flash update is completed.

System and setup password

Table 46. System and setup password

Password type	Description
System password	Password that you must enter to log in to your system.
Setup password	Password that you must enter to access and make changes to the BIOS settings of your computer.

You can create a system password and a setup password to secure your computer.

CAUTION: The password features provide a basic level of security for the data on your computer.

CAUTION: Anyone can access the data that is stored on your computer, when left unattended.

 **NOTE:** System and setup password feature is disabled.

Assigning a System Setup password

Prerequisites

You can assign a new System or Admin Password only when the status is in **Not Set**.

About this task

To enter BIOS System Setup, press F2 immediately after a power-on or reboot.

Steps

1. In the **System BIOS** or **System Setup** screen, select **Security** and press Enter.
The **Security** screen is displayed.
2. Select **System/Admin Password** and create a password in the **Enter the new password** field.
Use the following guidelines to assign the system password:
 - A password can have up to 32 characters.
 - At least one special character: "(! " # \$ % & ' * + , - . / : ; < = > ? @ [\] ^ _ ` { | })"
 - Numbers 0 to 9.
 - Upper case letters from A to Z.
 - Lower case letters from a to z.
3. **Confirm new password** type the system password that you entered earlier in the field and click **OK**.
4. Press Esc and save the changes as prompted by the message.
5. Press Y to save the changes.
The computer restarts.

Deleting or changing an existing system password or setup password

Prerequisites

Ensure that the **Password Status** is Unlocked (in the System Setup) before attempting to delete or change the existing system password and/or setup password. You cannot delete or change an existing system password or setup password if the **Password Status** is Locked.

About this task

To enter the System Setup, press F2 immediately after a power-on or reboot.

Steps

1. In the **System BIOS** or **System Setup** screen, select **System Security** and press Enter.
The **System Security** screen is displayed.
2. In the **System Security** screen, verify that the **Password Status** is Unlocked.
3. Select **System Password**. Update or delete the existing system password, and press Enter or Tab.
4. Select **Setup Password**. Update or delete the existing setup password, and press Enter or Tab.
 **NOTE:** If you change the system password and/or setup password, reenter the new password when prompted. If you delete the system password and/or setup password, confirm the deletion when prompted.
5. Press Esc. A message prompts you to save the changes.
6. Press Y to save the changes and exit from **System Setup**.
The computer restarts.

Clearing CMOS settings

About this task

 **CAUTION:** Clearing CMOS settings resets the BIOS settings on your computer.

Steps

1. Remove the [side cover](#).
2. Remove the [coin-cell battery](#).
3. Wait for one minute.
4. Replace the [coin-cell battery](#).
5. Replace the [side cover](#).

Clearing BIOS (System Setup) and System passwords

About this task

To clear the computer or BIOS passwords, contact Dell technical support as described at [Contact Support](#). For more information, go to [Dell Support Site](#).

 **NOTE:** For information about how to reset Windows or application passwords, see the documentation accompanying Windows or your application.

Troubleshooting

Dell SupportAssist Pre-boot System Performance Check diagnostics

About this task

SupportAssist diagnostics (also known as system diagnostics) performs a complete check of your hardware. The Dell SupportAssist Pre-boot System Performance Check diagnostics is embedded with the BIOS and launched by the BIOS internally. The embedded system diagnostics provides options for particular devices or device groups allowing you to:

- Run tests automatically or in an interactive mode.
- Repeat the tests.
- Display or save test results.
- Run thorough tests to introduce additional test options to provide extra information about one or more failed devices.
- View status messages that inform you the tests are completed successfully.
- View error messages that inform you of problems encountered during testing.

 **NOTE:** Some tests for specific devices require user interaction. Always ensure that you are present at the computer when the diagnostic tests are performed.

For more information, see the knowledge base article [000180971](#).

Running the SupportAssist Pre-Boot System Performance Check

Steps

1. Turn on your computer.
2. As the computer boots, press the F12 key as the Dell logo appears.
3. On the boot menu screen, select the **Diagnostics** option.
4. Click the arrow at the bottom left corner.
Diagnostics page is displayed.
5. Click the arrow in the lower-right corner to go to the page listing.
The items that are detected are listed.
6. To run a diagnostic test on a specific device, press Esc and click **Yes** to stop the diagnostic test.
7. Select the device from the left pane and click **Run Tests**.
8. If there are any issues, error codes are displayed.
Note the error code and validation number and contact Dell.

Power-Supply Unit Built-in Self-Test

Built-in Self-Test (BIST) helps determine if the power-supply unit is working. To run self-test diagnostics on the power-supply unit of a desktop or all-in-one computer, search in the Knowledge Base Resource at [Dell Support Site](#).

System-diagnostic lights

Table 47. Diagnostic LED behavior

Blinking pattern		Problem description
Amber	White	
1	2	Unrecoverable SPI Flash Failure
2	1	CPU failure
2	2	System board failure (included BIOS corruption or ROM error)
2	3	No memory/RAM detected
2	4	Memory/RAM failure
2	5	Invalid memory installed
2	6	System board / Chipset Error / Clock failure / Gate A20 failure / Super I/O failure / Keyboard controller failure
3	1	CMOS battery failure
3	2	PCI or Video card/chip failure
3	3	BIOS Recovery image not found
3	4	BIOS Recovery image found but invalid
3	5	Power rail failure
3	6	SBIOS Flash corruption
3	7	Intel ME (Management Engine) Error
4	2	CPU Power Cable Connection Issue

Recovering the operating system

When your computer is unable to boot to the operating system even after repeated attempts, it automatically starts Dell SupportAssist OS Recovery.

Dell SupportAssist OS Recovery is a stand-alone tool that is preinstalled in Dell computers running Windows operating system. It consists of tools to diagnose and troubleshoot issues that may occur before your computer boots to the operating system. It enables you to diagnose hardware issues, repair your computer, back up your files, or restore your computer to its factory state.

You can also download it from the Dell Support website to troubleshoot and fix your computer when it fails to boot into the primary operating system due to software or hardware failures.

For more information about the Dell SupportAssist OS Recovery, see *Dell SupportAssist OS Recovery User's Guide* at [Serviceability Tools at the Dell Support Site](#). Click **SupportAssist** and then, click **SupportAssist OS Recovery**.

Real Time Clock—RTC reset

The Real Time Clock (RTC) reset function allows you or the service technician to recover the recently launched model Dell Latitude and Precision systems from **No POST/No Boot/No Power** situations. You can initiate the RTC reset on the system from a power-off state only if it is connected to AC power. Press and hold the power button for 25 seconds. The system RTC reset occurs after you release the power button.

NOTE: If AC power is disconnected from the system during the process or the power button is held longer than 40 seconds, the RTC reset process gets aborted.

The RTC reset will reset the BIOS to Defaults, un-provision Intel vPro and reset the system date and time. The following items are unaffected by the RTC reset:

- Service Tag
- Asset Tag
- Ownership Tag
- Admin Password
- System Password
- HDD Password
- Key Databases
- System Logs

 **NOTE:** The IT administrator's vPro account and password on the system will be un-provisioned. The system needs to go through the setup and configuration process again to reconnect it to the vPro server.

The below items may or may not reset based on your custom BIOS setting selections:

- Boot List
- Enable Legacy Option ROMs
- Secure Boot Enable
- Allow BIOS Downgrade

Backup media and recovery options

It is recommended to create a recovery drive to troubleshoot and fix problems that may occur with Windows. Dell provides multiple options for recovering the Windows operating system on your Dell computer. For more information, see [Dell Windows Backup Media and Recovery Options](#).

Wi-Fi power cycle

About this task

If your computer is unable to access the Internet due to Wi-Fi connectivity issues, reset your Wi-Fi device by performing the following steps:

Steps

1. Turn off the computer.
2. Turn off the modem.

 **NOTE:** Some Internet service providers (ISPs) provide a modem and router combo device.

3. Turn off the wireless router.
4. Wait for 30 seconds.
5. Turn on the wireless router.
6. Turn on the modem.
7. Turn on the computer.

Getting help and contacting Dell

Self-help resources

You can get information and help on Dell products and services using these self-help resources:

Table 48. Self-help resources

Self-help resources	Resource location
Information about Dell products and services	Dell Site
Tips	
Contact Support	In Windows search, type <code>Contact Support</code> , and press Enter.
Online help for operating system	Windows Support Site Linux Support Site
Access top solutions, diagnostics, drivers and downloads, and learn more about your computer through videos, manuals, and documents.	Your Dell computer is uniquely identified using a Service Tag or Express Service Code. To view relevant support resources for your Dell computer, enter the Service Tag or Express Service Code at Dell Support Site . For more information about how to find the Service Tag for your computer, see Locate the Service Tag on your computer .
Dell knowledge base articles	<ol style="list-style-type: none"> 1. Go to Dell Support Site. 2. On the menu bar at the top of the Support page, select Support > Support Library. 3. In the Search field on the Support Library page, type the keyword, topic, or model number, and then click or tap the search icon to view the related articles.

Contacting Dell

To contact Dell for sales, technical support, or customer service issues, see [Dell Support Site](#).

 **NOTE:** Availability of the services may vary depending on the country or region, and product.

 **NOTE:** If you do not have an active Internet connection, you can find contact information about your purchase invoice, packing slip, bill, or Dell product catalog.