

Dell EMC PowerEdge R7515

Technical Specifications Guide

Notes, cautions, and warnings

 **NOTE:** A NOTE indicates important information that helps you make better use of your product.

 **CAUTION:** A CAUTION indicates either potential damage to hardware or loss of data and tells you how to avoid the problem.

 **WARNING:** A WARNING indicates a potential for property damage, personal injury, or death.

© 2019 Dell Inc. or its subsidiaries. All rights reserved. Dell, EMC, and other trademarks are trademarks of Dell Inc. or its subsidiaries. Other trademarks may be trademarks of their respective owners.

1 System overview	5
Front view of the system	5
Left control panel view	8
Right control panel	9
Rear view of the system	9
2 Technical specifications	13
System dimensions	13
Chassis weight	14
Processor specifications	14
PSU specifications	14
Supported operating systems	15
Cooling fans specifications	15
System battery specifications	15
Expansion card riser specifications	15
Memory specifications	16
Storage controller specifications	16
Drive specifications	16
Drives	16
Optical drives	17
Ports and connectors specifications	17
USB ports specifications	17
NIC ports specifications	17
Serial connector specifications	17
VGA ports specifications	18
IDSDM module	18
Video specifications	18
Environmental specifications	19
Thermal restriction matrix	20
Particulate and gaseous contamination specifications	22
3 System diagnostics and indicator codes	24
Status LED indicators	24
System health and system ID indicator codes	25
iDRAC Quick Sync 2 indicator codes	26
iDRAC Direct LED indicator codes	26
LCD panel	27
Viewing Home screen	28
Setup menu	28
View menu	28
NIC indicator codes	29
Power supply unit indicator codes	29
Drive indicator codes	30

4 Getting help.....	32
Recycling or End-of-Life service information.....	32
Contacting Dell.....	32
Accessing system information by using QRL.....	32
Quick Resource Locator for PowerEdge R7515 system.....	33
Receiving automated support with SupportAssist	33

System overview

The PowerEdge R7515 is a 2U rack server that supports:

- One AMD EPYC 7002 series processor
- 16 DIMM slots
- Two redundant power supply units
- Up to 8 x 3.5-inch, 12 x 3.5-inch, 12 x 3.5-inch + 2 x 3.5-inch (rear), or 24 x 2.5-inch up to 12 SAS/SATA/NVMe + 12 NVMe drives / 8 x 2.5-inch (universal drive) + 16 (NVMe drive) / 24 x 2.5-inch (NVMe drive only).

NOTE: For more information about how to hot swap NVMe PCIe SSD U.2 device, see the *Dell Express Flash NVMe PCIe SSD User's Guide* at www.dell.com/support > Browse all Products > Data Center Infrastructure > Storage Adapters & Controllers > Dell PowerEdge Express Flash NVMe PCIe SSD > Documentation > Manuals and Documents.

NOTE: All instances of SAS and SATA drives are seen as drives in this document, unless specified otherwise.

For more information about supported drives, see the [Drive specifications](#).

Topics:

- [Front view of the system](#)
- [Rear view of the system](#)

Front view of the system

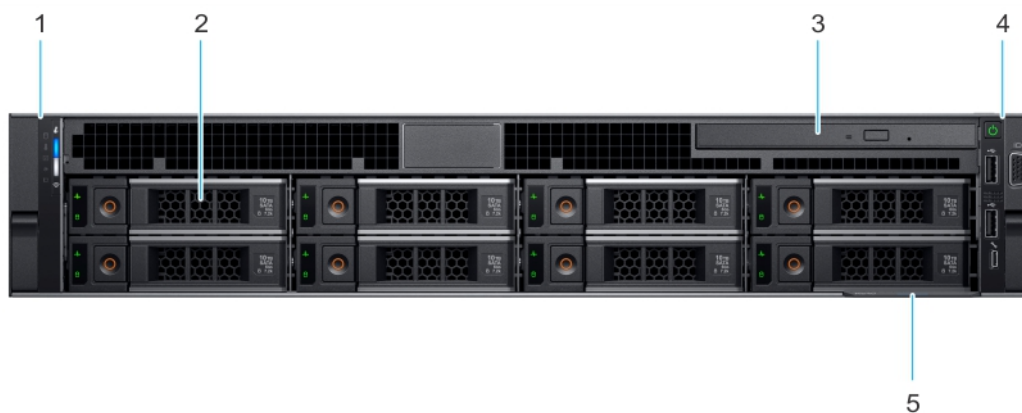

Figure 1. Front view of the 8 x 3.5-inch drive system

Table 1. Features available on the front of the system

Item	Ports, panels, and slots	Icon	Description
1	Left control panel	N/A	<p>Contains the system health, system ID, status LED, and the iDRAC Quick Sync 2 (wireless) indicator.</p> <p>NOTE: The iDRAC Quick Sync 2 indicator is available only on certain configurations.</p> <ul style="list-style-type: none"> • Status LED: Enables you to identify any failed hardware components. There are up to five status LEDs and an overall system health LED (Chassis health and system ID) bar. For more information, see the Status LED indicators section.

Item	Ports, panels, and slots	Icon	Description
			<ul style="list-style-type: none"> Quick Sync 2 (wireless): Indicates a Quick Sync enabled system. The Quick Sync feature is optional. This feature allows management of the system by using mobile devices called as OpenManage Mobile (OMM) feature. Using iDRAC Quick Sync 2 with OpenManage Mobile (OMM) aggregates hardware or firmware inventory and various system level diagnostic and error information that can be used in troubleshooting the system. For more information, see the <i>iDRAC User's Guide</i> available at www.dell.com/idracmanuals
2	Drive (8)	N/A	Enables you to install drives that are supported on your system. For more information about drives, see the Drives section.
3	Optical drive (optional)	N/A	One optional slim SATA DVD-ROM drive or DVD+/-RW drive.
4	Right control panel	N/A	Contains the power button, USB port, iDRAC Direct micro port, and the iDRAC Direct status LED.
5	Information tag		The Information tag is a slide-out label panel that contains system information such as Service Tag, NIC, MAC address, and so on. If you have opted for the secure default access to iDRAC, the Information tag also contains the iDRAC secure default password.



Figure 2. Front view of the 12 x 3.5-inch drive system

Table 2. Features available on the front of the system

Item	Ports, panels, and slots	Icon	Description
1	Left control panel	N/A	<p>Contains the system health, system ID, status LED, and the iDRAC Quick Sync 2 (wireless) indicator.</p> <p>NOTE: The iDRAC Quick Sync 2 indicator is available only on certain configurations.</p> <ul style="list-style-type: none"> Status LED: Enables you to identify any failed hardware components. There are up to five status LEDs and an overall system health LED (Chassis health and system ID) bar. For more information, see the Status LED indicators section. Quick Sync 2 (wireless): Indicates a Quick Sync enabled system. The Quick Sync feature is optional. This feature allows management of the system by using mobile devices called as OpenManage Mobile (OMM) feature. Using iDRAC Quick Sync 2 with OpenManage Mobile (OMM) aggregates hardware or firmware inventory and various system level diagnostic and error information that can be used in troubleshooting the system. For

Item	Ports, panels, and slots	Icon	Description
			more information, see the <i>iDRAC User's Guide</i> available at www.dell.com/idracmanuals
2	Drive (12)	N/A	Enables you to install drives that are supported on your system. For more information about drives, see the Drives section.
3	Right control panel	N/A	Contains the power button, USB port, iDRAC Direct micro port, and the iDRAC Direct status LED.
4	Information tag		The Information tag is a slide-out label panel that contains system information such as Service Tag, NIC, MAC address, and so on. If you have opted for the secure default access to iDRAC, the Information tag also contains the iDRAC secure default password.



Figure 3. Front view of the 24 x 2.5-inch drive system

Table 3. Features available on the front of the system

Item	Ports, panels, and slots	Icon	Description
1	Left control panel	N/A	Contains the system health, system ID, status LED, and the iDRAC Quick Sync 2 (wireless) indicator. i NOTE: The iDRAC Quick Sync 2 indicator is available only on certain configurations. <ul style="list-style-type: none"> Status LED: Enables you to identify any failed hardware components. There are up to five status LEDs and an overall system health LED (Chassis health and system ID) bar. For more information, see the Status LED indicators section. Quick Sync 2 (wireless): Indicates a Quick Sync enabled system. The Quick Sync feature is optional. This feature allows management of the system by using mobile devices called as OpenManage Mobile (OMM) feature. Using iDRAC Quick Sync 2 with OpenManage Mobile (OMM) aggregates hardware or firmware inventory and various system level diagnostic and error information that can be used in troubleshooting the system. For more information, see the <i>iDRAC User's Guide</i> available at www.dell.com/idracmanuals
2	Drive (24)	N/A	Enables you to install drives that are supported on your system. For more information about drives, see the Drives section.
3	Right control panel	N/A	Contains the power button, USB port, iDRAC Direct micro port, and the iDRAC Direct status LED.

Item	Ports, panels, and slots	Icon	Description
4	Information tag		The Information tag is a slide-out label panel that contains system information such as Service Tag, NIC, MAC address, and so on. If you have opted for the secure default access to iDRAC, the Information tag also contains the iDRAC secure default password.

For more information about the ports, see the [Technical Specifications](#) section.

Left control panel view

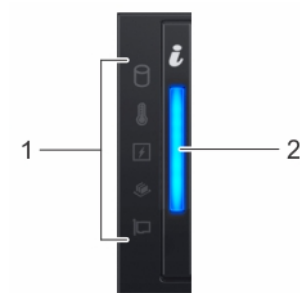

Figure 4. Left control panel without optional iDRAC Quick Sync 2.0 indicator

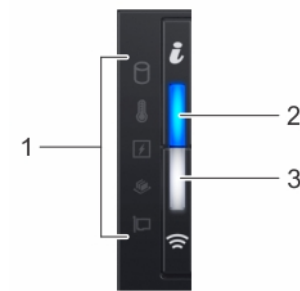

Figure 5. Left control panel with optional iDRAC Quick Sync 2.0 indicator

Table 4. Left control panel

Item	Indicator, button, or connector	Icon	Description
1	Status LED indicators	N/A	Indicates the status of the system. For more information, see the Status LED indicators section.
2	System health and system ID indicator	<i>i</i>	Indicates the system health. For more information, see the System health and system ID indicator codes section.
3	iDRAC Quick Sync 2 wireless indicator (optional)	☰	Indicates if the iDRAC Quick Sync 2 wireless option is activated. The Quick Sync 2 feature allows management of the system using mobile devices. This feature aggregates hardware/firmware inventory and various system level diagnostic/error information that can be used in troubleshooting the system. You can access system inventory, Dell Lifecycle Controller logs or system logs, system health status, and also configure iDRAC, BIOS, and networking parameters. You can also launch the virtual Keyboard, Video, and Mouse (KVM) viewer and virtual Kernel based Virtual Machine (KVM), on a supported mobile device. For more information, see the Integrated Dell Remote Access Controller User's Guide at www.dell.com/poweredge/manuals

NOTE: For more information about the indicator codes, see the [System diagnostics and indicator codes](#) section.

Right control panel

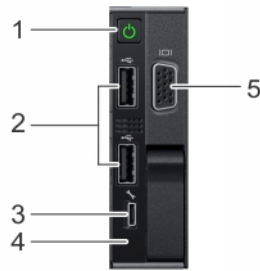

Figure 6. Right control panel view

Table 5. Right control panel

Item	Indicator or button	Icon	Description
1	Power button		Indicates if the system is powered on or off. Press the power button to manually power on or off the system. NOTE: Press the power button to gracefully shut down an ACPI-compliant operating system.
2	USB 2.0-compliant port		The USB port is a 4-pin connector and 2.0-compliant. This port enables you to connect USB devices to the system.
3	iDRAC Direct port (Micro-AB USB)		The iDRAC direct Micro USB port enables you to access the iDRAC Direct Micro USB features. For more information, see the <i>iDRAC User's Guide</i> available at www.dell.com/idracmanuals NOTE: You can configure iDRAC Direct by using a USB to micro USB (type AB) cable, which you can connect to your laptop or tablet. Cable length should not exceed 3 feet (0.91 meters). Performance could be affected by cable quality.
4	iDRAC Direct LED indicator	N/A	The iDRAC Direct LED indicator lights up to indicate that the iDRAC Direct port is actively connected to a device.
5	VGA port		Enables you to connect a display device to the system. For more information, see the Technical specifications section.

NOTE: For more information about the ports, see the [Ports and connectors specifications](#) section.

Rear view of the system

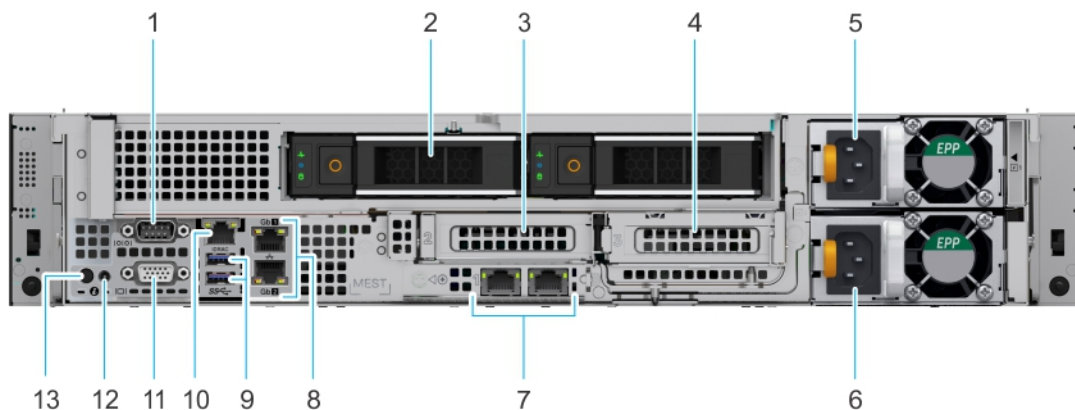







Figure 7. Rear view of the system with two rear drives

Table 6. Rear view of the system with two rear drives

Item	Ports, panels, or slots	Icon	Description
1	Serial port		Enables you to connect a serial device to the system. For more information, see the Technical Specifications section.
2	Drive	N/A	Enables you to install drives that are supported on your system. For more information about drives, see the Drive specifications section.
3	PCIe expansion card riser 1A (slot 2)	N/A	The expansion card riser enables you to connect PCI Express expansion cards. For more information on the expansion cards that are supported on your system, see Technical Specifications section.
4	PCIe expansion card riser 2 (slot 3)	N/A	The expansion card riser enables you to connect PCI Express expansion cards. For more information on the expansion cards that are supported on your system, see Technical Specifications section.
5	Power supply unit (PSU)	N/A	For more information about the PSU configurations, see the Technical Specifications section.
6	Power supply unit (PSU)	N/A	For more information about the PSU configurations, see the Technical Specifications section.
7	LOM Riser Ethernet port (2) (Optional) (slot 1)		The NIC ports that are integrated on the LAN on Motherboard (LOM) riser provide network connectivity. For more information about the supported configurations, see the Technical Specifications section.
8	Ethernet ports (2)		The Ethernet ports that are integrated on the system board provide network connectivity. These NIC ports can also be shared with iDRAC when iDRAC network settings is set to shared mode. For more information about the supported configurations, see the Technical Specifications section.
9	USB 3.0 port (2)		These USB ports support USB 3.0.
10	iDRAC dedicated port		Enables you to remotely access iDRAC. For more information, see the iDRAC User's Guide at www.dell.com/poweredge/manuals .
11	VGA port		Enables you to connect a display device to the system. For more information, see the Technical Specifications section.
12	System status indicator cable port (CMA)	N/A	Enables you to connect the status indicator cable and view system status when the CMA is installed.
13	System identification button		Press the system ID button:

- To locate a particular system within a rack.
- To turn the system ID on or off.

To reset iDRAC, press and hold the button for 16 seconds.

NOTE:

- **To reset iDRAC using system ID, ensure that the system ID button is enabled in the iDRAC setup.**
- **If the system stops responding during POST, press and hold the system ID button (for more than five seconds) to enter the BIOS progress mode.**

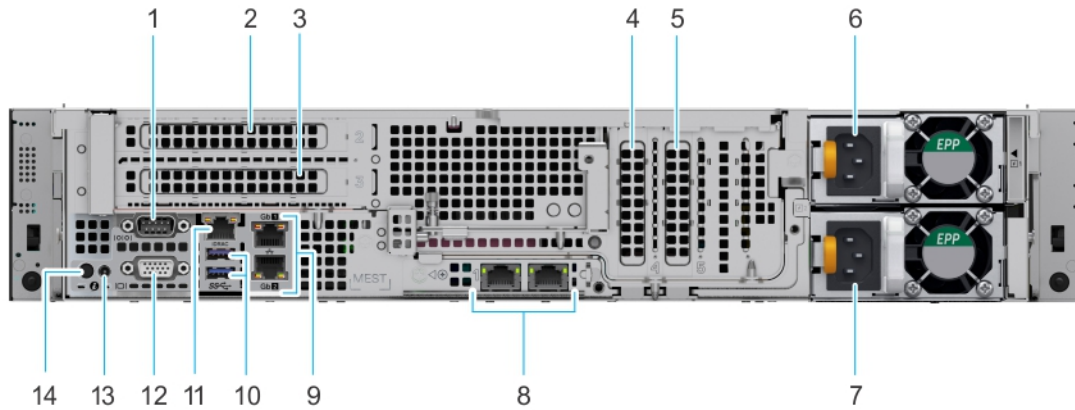







Figure 8. Rear view of the system with no rear drives

Table 7. Rear view of the system with no rear drives

Item	Ports, panels, or slots	Icon	Description
1	Serial port		Enables you to connect a serial device to the system. For more information, see the Technical Specifications section.
2	PCIe expansion card riser 1B (slot 2)	N/A	The expansion card slot enables you to connect PCI Express expansion cards. For more information on the expansion cards that are supported on your system, see Technical Specifications section.
3	PCIe expansion card riser 1B (slot 3)	N/A	The expansion card slot enables you to connect PCI Express expansion cards. For more information on the expansion cards that are supported on your system, see Technical Specifications section.
4	PCIe slot 4	N/A	The expansion card riser enables you to connect PCI Express expansion cards. For more information on the expansion cards that are supported on your system, see Technical Specifications section.
5	PCIe slot 5	N/A	The expansion card riser enables you to connect PCI Express expansion cards. For more information on the expansion cards that are supported on your system, see Technical Specifications section.
6	Power supply unit (PSU)	N/A	For more information about the PSU configurations, see the Technical Specifications section.
7	Power supply unit (PSU)	N/A	For more information about the PSU configurations, see the Technical Specifications section.
8	LOM Riser Ethernet port (2) (Optional) (slot 1)		The NIC ports that are integrated on the LAN on Motherboard (LOM) riser provide network connectivity. For more information about the supported configurations, see the Technical Specifications section.
9	Ethernet ports (2)		The Ethernet ports that are integrated on the system board provide network connectivity. These NIC ports can also be shared with iDRAC when iDRAC network settings is set to shared mode. For more information about the supported configurations, see the Technical Specifications section.
10	USB 3.0 port (2)		These USB ports support USB 3.0.
11	iDRAC dedicated port		Enables you to remotely access iDRAC. For more information, see the iDRAC User's Guide at www.dell.com/poweredge/manuals .
12	VGA port		Enables you to connect a display device to the system. For more information, see the Technical Specifications section.
13	System status indicator cable port (CMA)	N/A	Enables you to connect the status indicator cable and view system status when the CMA is installed.

Item	Ports, panels, or slots	Icon	Description
14	System identification button		<p>Press the system ID button:</p> <ul style="list-style-type: none"> • To locate a particular system within a rack. • To turn the system ID on or off. <p>To reset iDRAC, press and hold the button for 16 seconds.</p> <p>NOTE:</p> <ul style="list-style-type: none"> • To reset iDRAC using system ID, ensure that the system ID button is enabled in the iDRAC setup. • If the system stops responding during POST, press and hold the system ID button (for more than five seconds) to enter the BIOS progress mode.

For more information about the ports and connectors, see the [Technical Specifications](#) section.

Technical specifications

The technical and environmental specifications of your system are outlined in this section.

Topics:

- System dimensions
- Chassis weight
- Processor specifications
- PSU specifications
- Supported operating systems
- Cooling fans specifications
- System battery specifications
- Expansion card riser specifications
- Memory specifications
- Storage controller specifications
- Drive specifications
- Ports and connectors specifications
- Video specifications
- Environmental specifications

System dimensions

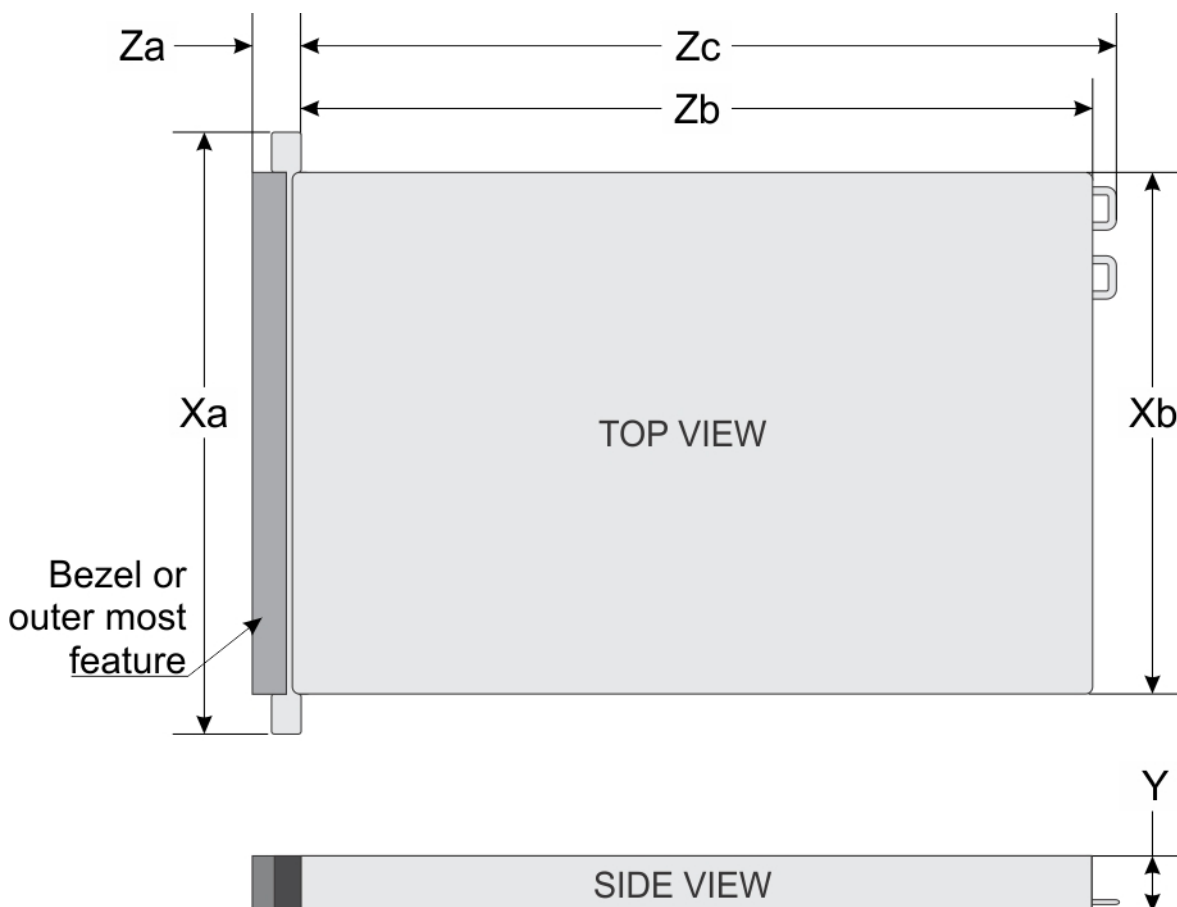

Figure 9. Dimensions of the PowerEdge R7515 system

Table 8. PowerEdge R7515 system dimensions

Xa	Xb	Y	Za (with bezel)	Za (without bezel)	Zb*	Zc
482 mm (18.97 inches)	434 mm (17.08 inches)	86.8 mm (3.41 inches)	35.84 mm (1.41 inches)	22 mm (0.87 inches)	647.07 mm (25.47 inches)	681.755 mm (26.84 inches)

Chassis weight

Table 9. Chassis weight

System	Maximum weight (with all drives)
8 x 3.5-inch	23.78 kg (52.42 lb)
12 x 3.5-inch	25.68 kg (56.61 lb)
12 x 3.5-inch + 2 x 3.5-inch (rear)	27.3 kg (60.18 lb)
24 x 2.5-inch	23.72 kg (52.29 lb)

Processor specifications

Table 10. PowerEdge R7515 processor specifications

Supported processor	Number of processors supported
AMD EPYC 7002 series processor	One

PSU specifications

The PowerEdge R7515 system supports the following AC or DC power supply units (PSU):

Table 11. PSU specifications

PSU	Class	Heat dissipation (maximum)	Frequency	Voltage
1600 W AC	Platinum	6000 BTU/hr	50/60 Hz	100—240 V AC, autoranging
1100 W DC	NA	4416 BTU/hr	NA	-48 — -60 V DC
1100 W AC	Platinum	4100 BTU/hr	50/60 Hz	100—240 V AC, autoranging
1100 W HVDC	Platinum	4100 BTU/hr	50/60 Hz	100—240 V AC, autoranging
	NA	4100 BTU/hr	NA	200—380 V DC, autoranging
750 W AC	Platinum	2891 BTU/hr	50/60 Hz	100—240 V AC, autoranging
750 W HVDC	Platinum	2891 BTU/hr	50/60 Hz	100—240 V AC, autoranging
	Platinum	2891 BTU/hr	NA	240 V DC
750 W AC	Titanium	2843 BTU/hr	50/60 Hz	200—240 V AC, autoranging
495 W AC	Platinum	1908 BTU/hr	50/60 Hz	100—240 V AC, autoranging

NOTE: When selecting or upgrading the system configuration, to ensure optimum power utilization, verify the system power consumption with the Dell Energy Smart Solution Advisor available at Dell.com/ESSA.

NOTE: Heat dissipation is calculated using the PSU wattage rating.

- NOTE:** This system is also designed to connect to the IT power systems with a phase-to-phase voltage not exceeding 230 V.
- NOTE:** If a system with 1600 W AC PSU operates at low line 100-120 V AC, then the power rating per PSU is derated to 800 W.
- NOTE:** If a system with 1100 W AC PSU or 1100 W mixed mode PSU operates at low line 100-120 V AC, and then the power rating per PSU is derated to 1050 W.

Supported operating systems

The PowerEdge R7515 supports the following operating systems:

- Canonical Ubuntu Server LTS
- Microsoft Windows Server with Hyper-V
- Red Hat Enterprise Linux
- SUSE Linux Enterprise Server
- VMware ESXi

For more information about the specific versions and additions, see <https://www.dell.com/support/home/Drivers/SupportedOS/poweredge-r7515>.

Cooling fans specifications

The PowerEdge R7515 system supports both the Standard fan (STD fan) and High Performance fan (HPR fan) and requires all six fans to be installed.

- NOTE:** Mixing of STD and HPR fans is not supported.
- NOTE:** The STD and HPR fans installation depends on the system configuration. For more information about the fan support configuration or matrix, see [Thermal restriction matrix](#).

System battery specifications

The PowerEdge R7515 system supports CR 2032 3.0-V lithium coin cell system battery.

Expansion card riser specifications

The PowerEdge R7515 system supports PCI Express (PCIe) Gen3/Gen4 expansion cards. This system supports low profile, full height, and 1U/2U expansion card risers.

Table 12. Expansion card riser configurations

Expansion card riser	PCIe slots on the riser	Processor connection	Height	Length	Slot width
Riser-1B (2U riser)	Slot 2	Processor 1	Full Height	Full Length	x16 (Gen 3)
Riser-1B (2U riser)	Slot 3	Processor 1	Full Height	Full Length	x16 (Gen 4)
Riser-1A (1U right riser with rear drives configuration)	Slot 2	Processor 1	Low Profile	Half Length	x16 (Gen 3)
Riser- 2 (1U left riser with rear drives configuration)	Slot 3	Processor 1	Low Profile	Half Length	x16 (Gen 4)

- NOTE:** The expansion-card slots are not hot-swappable.

Memory specifications

The PowerEdge R7515 system supports the following memory specifications for optimized operation.

Table 13. Memory specifications

DIMM type	DIMM rank	DIMM capacity	Minimum RAM	Maximum RAM
RDIMM	Single rank	8 GB	8 GB	128 GB
	Dual rank	16 GB	16 GB	256 GB
		32 GB	32 GB	512 GB
		64 GB	64 GB	1 TB
3DS LRDIMM	Octa rank	128 GB	128 GB	2 TB

Table 14. Memory module sockets

Memory module sockets	Speed
Sixteen 288-pin	3200 MT/s, 2933 MT/s, 2666 MT/s

Storage controller specifications

The PowerEdge R7515 system supports the following controller cards:

Table 15. PowerEdge R7515 system controller cards

Internal controllers	External controllers
<ul style="list-style-type: none"> PERC H740P PERC H730P PERC H330 HBA330 S150 Boot Optimized Storage Subsystem (BOSS-S1): HWRAID 2 x M.2 SSDs 	<ul style="list-style-type: none"> 12 Gbps SAS Ext. HBA H840

Drive specifications

Drives

The PowerEdge R7515 system supports:

- Up to 8 x 3.5 inch (SAS, SATA or SSD) front accessible drives in slots 0 to 7
- Up to 12 x 3.5 inch (SAS, SATA or SSD) front accessible drives in slots 0 to 11
- Up to 12 x 3.5 inch (SAS, SATA or SSD) front accessible drives in slots 0 to 11 + up to 2 x 3.5 inch (SAS, SATA or SSD) rear accessible drives in slots 12 to 13
- Up to 24 x 2.5 inch (SAS, SATA or SSD) front accessible drives in slots 0 to 23
- Up to 12 x 2.5 inch (SAS, SATA or SSD) front accessible drives in slots 0 to 11 and up to 12 x 2.5 inch NVMe drives in 12 universal slots 12 to 23
- Up to 24 x 2.5 inch NVMe drives in bay 0 (slot 0 to 11) and bay 1 (slots 0 to 11)
- Up to 8 x 2.5 inch (SAS, SATA or SSD) front accessible drives in Universal slots 0 to 7 (Bay 0) and up to 16 x 2.5 inch NVMe drives in bay 0 (slots 8 to 11) and bay 1 (slots 0 to 11)

NOTE: For more information about how to hot swap NVMe PCIe SSD U.2 device, see the *Dell Express Flash NVMe PCIe SSD User's Guide* at Dell.com/support > Browse all Products > Data Center Infrastructure > Storage Adapters & Controllers > Dell PowerEdge Express Flash NVMe PCIe SSD > Documentation > Manuals and Documents.

Backplane:

- 8 x 3.5-inch SAS, SATA drives
- 24 x 2.5-inch SAS, SATA drives
- 24 x 2.5-inch NVMe drives
- 12 x 3.5-inch SAS, SATA drives and 2 x 3.5-inch SAS, SATA drives
- 12 x 2.5-inch SAS, SATA drives and 12 x 2.5-inch NVMe drives
- 8 x 2.5-inch SAS, SATA drives and 16 x 2.5-inch NVMe drives

Optical drives

The PowerEdge R7515 system supports the following optical drives:

Table 16. Supported optical drive type

Supported drive type	Supported number of drives
Dedicated SATA DVD-ROM drive or DVD +/-RW drive	One

Ports and connectors specifications

USB ports specifications

Table 17. PowerEdge R7515 system USB specifications

Front		Rear		Internal	
USB port type	No. of ports	USB port type	No. of ports	USB port type	No. of ports
USB 2.0-compliant port	Two	USB 3.0-compliant ports	Two	Internal USB 3.0-compliant port	One
Micro USB 2.0-compliant port for iDRAC Direct	One				

NOTE: The micro USB 2.0 compliant port can only be used as an iDRAC Direct or a management port.

NIC ports specifications

The PowerEdge R7515 system supports up to two 10/100/1000 Mbps Network Interface Controller (NIC) ports that are located on the back panel. The system also supports LAN on Motherboard (LOM) on an optional riser card.

You can install one LOM riser card. The supported LOM riser options are:

- 2 x 1 Gb Base-T
- 2 x 10Gb Base-T
- 2 x 10Gb SPF+
- 2 x 25Gb SPF+

NOTE:

- You can install up to two PCIe add-on NIC cards.
- For information about Linux network performance settings, see the *Linux Network Tuning Guide for AMD EPYC Processor Based Servers* at [AMD.com](https://www.amd.com)

Serial connector specifications

The serial connector connects a serial device to the system. The PowerEdge R7515 system supports one serial connector on the back panel, which is a 9-pin connector, Data Terminal Equipment (DTE), 16550-compliant.

VGA ports specifications

The Video Graphic Array (VGA) port enables you to connect the system to a VGA display. The PowerEdge R7515 system supports two 15-pin VGA ports one each on the front and back panels.

IDSDM module

The PowerEdge R7515 system supports optional Internal Dual SD module (IDSDM) module.

The module supports two microSD cards. The supported microSD card storage capacities are mentioned below:

- 16 GB
- 32 GB
- 64 GB

NOTE: There are two dip switches on the IDSDM for write-protection.

NOTE: One IDSDM card slot is dedicated for redundancy.

NOTE: Use Dell EMC branded microSD cards that are associated with the IDSDM configured systems.

Video specifications

The PowerEdge R7515 system supports Matrox G200eR2 graphics card with 16 MB capacity.

NOTE: 1920 x 1080 and 1920 x 1200 resolutions are only supported in reduced blanking mode.

Table 18. Supported front video resolution options

Resolution	Refresh rate (Hz)	Color depth (bits)
1024 x 768	60	8, 16, 32
1280 x 800	60	8, 16, 32
1280 x 1024	60	8, 16, 32
1360 x 768	60	8, 16, 32
1440 x 900	60	8, 16, 32

Table 19. Supported rear video resolution options

Resolution	Refresh rate (Hz)	Color depth (bits)
1024 x 768	60	8, 16, 32
1280 x 800	60	8, 16, 32
1280 x 1024	60	8, 16, 32
1360 x 768	60	8, 16, 32
1440 x 900	60	8, 16, 32
1600 x 900	60	8, 16, 32
1600 x 1200	60	8, 16, 32
1680 x 1050	60	8, 16, 32
1920 x 1080	60	8, 16, 32
1920 x 1200	60	8, 16, 32

Environmental specifications

The following sections contain information about the environmental specifications of the system.

NOTE: For additional information about environmental certifications, please refer to the Product Environmental Datasheet located with the Manuals & Documents on www.dell.com/poweredgemanuals

Operational climatic range category A2

Table 20. Operational climatic range category A2

Allowable continuous operations	
Temperature ranges for altitude ≤ 900 meters ($\leq 2,953$ feet)	10 to 35°C (50 to 95°F) with no direct sunlight on the platform
Humidity percent ranges (Non-condensing at all times)	8% RH with -12°C minimum dew point to 80% RH with 21°C (69.8°F) maximum dew point
Operational altitude de-rating	Maximum temperature is reduced by 1°C/300 meters (1.8°F/984 feet) above 900 meters (2,953 feet)

Operational climatic range category A3

Table 21. Operational climatic range category A3

Allowable continuous operations	
Temperature ranges for altitude ≤ 900 meters ($\leq 2,953$ feet)	5 to 40°C (41 to 104°F) with no direct sunlight on the platform
Humidity percent ranges (Non-condensing at all times)	8% RH with -12°C minimum dew point to 85% RH with 24°C (75.2°F) maximum dew point
Operational altitude de-rating	Maximum temperature is reduced by 1°C/175 meters (1.8°F/574 feet) above 900 meters (2,953 feet)

Thermal restriction for ASHRAE A3/Fresh air environment (UI)

- Redundant power supply configuration is required with both PSUs populated.
- LRDIMM is not supported.
- CPU TDP equal or greater than 180W are not supported.
- 128 GB or greater capacity DIMMs are not supported.
- Non-Dell qualified peripheral cards greater than 25 W are not supported.
- Any type of GPGPU card is not supported.
- PCIe SSD is not supported.
- Rear drive configuration is not supported.

Shared requirements across all categories

Table 22. Shared requirements across all categories

Allowable operations	
Maximum temperature gradient (applies to both operation and non-operation)	20°C in an hour* (36°F in an hour) and 5°C in 15 minutes (9°F in 15 minutes), 5°C in an hour* (9°F in an hour) for tape hardware
Non-operational temperature limits	-40 to 65°C (-40 to 149°F)
Non-operational humidity limits	5% to 95% RH with 27°C (80.6°F) maximum dew point

Allowable operations	
Maximum non-operational altitude	12,000 meters (39,370 feet)
Maximum operational altitude	3,048 meters (10,000 feet)

*: Per ASHRAE thermal guidelines, these are not instantaneous rates of temperature change.

Table 23. Maximum vibration specifications

Maximum vibration	Specifications
Operating	0.26 Grms at 5 Hz to 350 Hz (all operation orientations)
Storage	1.88 Grms at 10 Hz to 500 Hz for 15 minutes (all six sides tested)

Table 24. Maximum shock pulse specifications

Maximum shock pulse	Specifications
Operating	24 executed shock pulses in the positive and negative x, y, and z axis of 6 G for up to 11 ms. (4 pulse on each side of the system)
Storage	Six consecutively executed shock pulses in the positive and negative x, y, and z axis (one pulse on each side of the system) of 71 G for up to 2 ms.

Thermal restriction matrix

Table 25. Label references

Label references	
STD	Standard
HPR	High Performance
HSK	Heat sink
LP	Low Profile (Riser)
FH	Full Height (Riser)
DW	Double Wide (Xilinx FPGA accelerator)

Table 26. Thermal restriction matrix

Drive Configuration type		8x3.5-inch drives	12x3.5-inch drives	12x3.5-inch drives	24x2.5-inch drives		12x2.5-inch drives SAS + 12x2.5-inch drives NVMe		24x2.5-inch drives NVMe	
Rear Configuration		2LP+2FH	2LP+2FH	Rear 2x3.5-inch drives SAS	2LP+2FH	2LP+1DW	2LP+2FH	2LP+1DW	2LP+2FH	2LP+1DW
Ambient temperature		Up to 35°C	Up to 35°C	Up to 35°C	Up to 35°C	Up to 30°C	Up to 35°C	Up to 30°C	Up to 35°C	Up to 30°C
TDP (W)	120	STD Fan 1U HPR HSK	HPR Fan 1U HPR HSK	HPR Fan 2U HPR HSK	STD Fan 1U HPR HSK	HPR Fan 1U HPR HSK	HPR Fan 1U HPR HSK	HPR Fan 1U HPR HSK	HPR Fan 1U HPR HSK	HPR Fan 1U HPR HSK
	155	STD Fan 1U HPR HSK	HPR Fan 1U HPR HSK	HPR Fan 2U HPR HSK	STD Fan 1U HPR HSK	HPR Fan 1U HPR HSK	HPR Fan 1U HPR HSK	HPR Fan 1U HPR HSK	HPR Fan 1U HPR HSK	HPR Fan 1U HPR HSK
	170	STD Fan 1U HPR HSK	HPR Fan 1U HPR HSK	HPR Fan 2U HPR HSK	STD Fan 1U HPR HSK	HPR Fan 1U HPR HSK	HPR Fan 1U HPR HSK	HPR Fan 1U HPR HSK	HPR Fan 1U HPR HSK	HPR Fan 1U HPR HSK

Drive Configuration type		8x3.5-inch drives	12x3.5-inch drives	12x3.5-inch drives	24x2.5-inch drives		12x2.5-inch drives SAS + 12x2.5-inch drives NVMe		24x2.5-inch drives NVMe	
	180	STD Fan 1U HPR HSK	HPR Fan 1U HPR HSK	HPR Fan 2U HPR HSK	STD Fan 1U HPR HSK	HPR Fan 1U HPR HSK	HPR Fan 1U HPR HSK	HPR Fan 1U HPR HSK	HPR Fan 1U HPR HSK	HPR Fan 1U HPR HSK
	200	STD Fan 1U HPR HSK	HPR Fan 1U HPR HSK	HPR Fan 2U HPR HSK	STD Fan 1U HPR HSK	HPR Fan 1U HPR HSK	HPR Fan 1U HPR HSK	HPR Fan 1U HPR HSK	HPR Fan 1U HPR HSK	HPR Fan 1U HPR HSK
	225	HPR Fan 1U HPR HSK	HPR Fan 1U HPR HSK	HPR Fan 2U HPR HSK	HPR Fan 1U HPR HSK	HPR Fan 1U HPR HSK	HPR Fan 1U HPR HSK	HPR Fan 1U HPR HSK	HPR Fan 1U HPR HSK	HPR Fan 1U HPR HSK
	240	HPR Fan 1U HPR HSK	HPR Fan 1U HPR HSK	HPR Fan 2U HPR HSK	HPR Fan 1U HPR HSK	HPR Fan 1U HPR HSK	HPR Fan 1U HPR HSK	HPR Fan 1U HPR HSK	HPR Fan 1U HPR HSK	HPR Fan 1U HPR HSK
Double Wide FPGA		No	No	Not supported	No	Yes	No	Yes	No	Yes

Table 27. Thermal restriction matrix for T4 GPU Card

Drive Configuration type		8x3.5-inch drives	12x3.5-inch drives	12x3.5-inch drives	24x2.5-inch drives	12x2.5-inch drives SAS + 12x2.5-inch drives NVMe	24x2.5-inch drives NVMe
Rear Configuration		2LP+2FH	2LP+2FH	Rear 2x3.5-inch drives SAS	2LP+2FH	2LP+2FH	2LP+2FH
Ambient temperature		Up to 30°C	Up to 30°C	Up to 30°C	Up to 30°C	Up to 30°C	Up to 30°C
Slot Combination	Slot2	HPR Fan 1U HPR HSK	N/A	N/A	HPR Fan 1U HPR HSK	HPR Fan 1U HPR HSK	HPR Fan 1U HPR HSK
	Slot3	HPR Fan 1U HPR HSK	N/A	N/A	HPR Fan 1U HPR HSK	HPR Fan 1U HPR HSK	HPR Fan 1U HPR HSK
	Slot4	HPR Fan 1U HPR HSK	N/A	N/A	HPR Fan 1U HPR HSK	HPR Fan 1U HPR HSK	HPR Fan 1U HPR HSK
	Slot5	HPR Fan 1U HPR HSK	N/A	N/A	HPR Fan 1U HPR HSK	HPR Fan 1U HPR HSK	HPR Fan 1U HPR HSK
	Slot2/Slot3	HPR Fan 1U HPR HSK	N/A	N/A	HPR Fan 1U HPR HSK	HPR Fan 1U HPR HSK	HPR Fan 1U HPR HSK
	Slot4/Slot5	HPR Fan 1U HPR HSK	N/A	N/A	HPR Fan 1U HPR HSK	HPR Fan 1U HPR HSK	HPR Fan 1U HPR HSK
	Slot2/Slot3 Slot4/Slot5	HPR Fan 1U HPR HSK	N/A	N/A	HPR Fan 1U HPR HSK	HPR Fan 1U HPR HSK	HPR Fan 1U HPR HSK

Table 28. CPU support matrix

Processor	TDP (W)	cTDPMax (W)	Cores	Fan type	Fan type (8x3.5-inch/24x2.5-inch)*	HSK Type**	ASHRAE A3 support
7742	225	240	64	HPR Fan	HPR Fan	1U HPR	No
7642	225	240	48	HPR Fan	HPR Fan	1U HPR	No
7542	225	240	32	HPR Fan	HPR Fan	1U HPR	No
7702	200	200	64	HPR Fan	STD Fan	1U HPR	No

Processor	TDP (W)	cTDPMax (W)	Cores	Fan type	Fan type (8x3.5-inch/24x2.5-inch)*	HSK Type**	ASHRAE A3 support
7552	200	200	48	HPR Fan	STD Fan	1U HPR	No
7502	180	200	32	HPR Fan	STD Fan	1U HPR	No
7402	180	200	24	HPR Fan	STD Fan	1U HPR	No
7452	155	180	32	HPR Fan	STD Fan	1U HPR	Yes
7352	155	180	24	HPR Fan	STD Fan	1U HPR	Yes
7302	155	180	16	HPR Fan	STD Fan	1U HPR	Yes
7262	155	180	8	HPR Fan	STD Fan	1U HPR	Yes
7282	120	150	16	HPR Fan	STD Fan	1U HPR	Yes
7272	120	150	12	HPR Fan	STD Fan	1U HPR	Yes
7252	120	150	8	HPR Fan	STD Fan	1U HPR	Yes

*Except for 8x3.5-inch/24x2.5-inch(without NVME), all other configurations have only high performance fan type.

**Only 12X3.5" with rear drives systems use 2U high performance heat sinks.

Other thermal restrictions

- Mellanox CX5 with QSFP28 is restricted to slot4 and slot5 in no rear drive configuration. Non Dell qualified cables are not supported.
- Mellanox CX6 with QSFP56 (Mellanox MFS1S00) is restricted to slot4 and slot5 in no rear drive configuration. Non Dell qualified cables are not supported.
- Solarflare XtremeScale X2522-25G Adapter is restricted to slot4 and slot5 in no rear drive configuration.
- 750GB PCIe SSD Adapter (P4800) by Intel is restricted to slot4 and slot5 in no rear drive configuration.
- Broadcom 57414 is not supported with 128GLRDIMM or higher on 12x3.5-inch drives configuration.

Particulate and gaseous contamination specifications

The following table defines the limitations that help avoid any damages to the IT equipment and/or, or both failure from particulate and gaseous contamination. If the levels of particulate or gaseous pollution exceed the specified limitations and results in equipment damage or failure, you must rectify the environmental conditions. Remediation of environmental conditions is the responsibility of the customer.

Table 29. Particulate contamination specifications

Particulate contamination	Specifications
Air filtration	<p>Data center air filtration as defined by ISO Class 8 per ISO 14644-1 with a 95% upper confidence limit.</p> <p>NOTE: This condition applies to data center environments only. Air filtration requirements do not apply to IT equipment designed to be used outside a data center, in environments such as an office or factory floor.</p> <p>NOTE: Air entering the data center must have MERV11 or MERV13 filtration.</p> <p>NOTE: Air filtering can also be accomplished by filtering room air with MERV8 filter per ANSI/ASHRAE Standard 127</p>
Conductive dust	Air must be free of conductive dust, zinc whiskers, or other conductive particles.

Particulate contamination	Specifications
	<p>i NOTE: This condition applies to data center and non-data center environments.</p> <p>i NOTE: Common sources of conductive dust include manufacturing processes, and zinc whiskers from the plating on the bottom of raised floor tiles</p>
Corrosive dust	<ul style="list-style-type: none"> • Air must be free of corrosive dust. • Residual dust present in the air must have a deliquescent point less than 60% relative humidity. <p>i NOTE: This condition applies to data center and non-data center environments.</p>

Table 30. Gaseous contamination specifications

Gaseous contamination	Specifications
Copper Coupon Corrosion rate	<300 Å/month per Class G1 as defined by ANSI/ISA71.04-2013
Silver Coupon Corrosion rate	<200 Å/month as defined by ANSI/ISA71.04-2013

i NOTE: Maximum corrosive contaminant levels measured at ≤50% relative humidity.

System diagnostics and indicator codes

The diagnostic indicators on the system front panel display system status during system startup.

Topics:

- [Status LED indicators](#)
- [System health and system ID indicator codes](#)
- [iDRAC Quick Sync 2 indicator codes](#)
- [iDRAC Direct LED indicator codes](#)
- [LCD panel](#)
- [NIC indicator codes](#)
- [Power supply unit indicator codes](#)
- [Drive indicator codes](#)

Status LED indicators

NOTE: The indicators display solid amber if any error occurs.

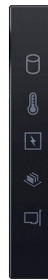



Figure 10. Status LED indicators

Table 31. Status LED indicators and descriptions

Icon	Description	Condition	Corrective action
	Drive indicator	The indicator turns solid amber if there is a drive error.	<ul style="list-style-type: none"> • Check the System Event Log to determine if the drive has an error. • Run the appropriate Online Diagnostics test. Restart the system and run embedded diagnostics (ePSA). • If the drives are configured in a RAID array, restart the system, and enter the host adapter configuration utility program.
	Temperature indicator	The indicator turns solid amber if the system experiences a thermal error (for example, the ambient temperature is out of range or there is a fan failure).	Ensure that none of the following conditions exist: <ul style="list-style-type: none"> • A cooling fan has been removed or has failed. • System cover, air shroud, memory module blank, or back filler bracket is removed. • Ambient temperature is too high. • External airflow is obstructed.
	Electrical indicator	The indicator turns solid amber if the system experiences an electrical error (for example, voltage out of range, or	Check the System Event Log or system messages for the specific issue. If it is due to a problem with the PSU, check the LED on the PSU. Reseat the PSU.

Icon	Description	Condition	Corrective action
		a failed power supply unit (PSU) or voltage regulator).	
	Memory indicator	The indicator turns solid amber if a memory error occurs.	Check the System Event Log or system messages for the location of the failed memory. Reseat the memory module.
	PCIe indicator	The indicator turns solid amber if a PCIe card experiences an error.	Restart the system. Update any required drivers for the PCIe card. Reinstall the card. NOTE: For more information about the supported PCIe cards, see the Expansion card installation guidelines section.

System health and system ID indicator codes

The system health and system ID indicator is located on the left control panel of the system.



Figure 11. System health and system ID indicator



Figure 12. System health and system ID indicator

Table 32. System health and system ID indicator codes

System health and system ID indicator code	Condition
Solid blue	Indicates that the system is powered on, is healthy, and system ID mode is not active. Press the system health and system ID button to switch to system ID mode.

System health and system ID indicator code	Condition
Blinking blue	Indicates that the system ID mode is active. Press the system health and system ID button to switch to system health mode.
Solid amber	Indicates that the system is in fail-safe mode. If the problem persists, see the Getting help section.
Blinking amber	Indicates that the system is experiencing a fault. Check the System Event Log for specific error messages. For information about the event and error messages generated by the system firmware and agents that monitor system components, see the Error Code Lookup page at qrl.dell.com

iDRAC Quick Sync 2 indicator codes

iDRAC Quick Sync 2 module (optional) is located on the left control panel of the system.



Table 33. iDRAC Quick Sync 2 indicators and descriptions

iDRAC Quick Sync 2 indicator code	Condition	Corrective action
Off (default state)	Indicates that the iDRAC Quick Sync 2 feature is powered off. Press the iDRAC Quick Sync 2 button to power on the iDRAC Quick Sync 2 feature.	If the LED fails to power on, reseal the left control panel flex cable and check.
Solid white	Indicates that iDRAC Quick Sync 2 is ready to communicate. Press the iDRAC Quick Sync 2 button to power off.	If the LED fails to power off, restart the system.
Blinks white rapidly	Indicates data transfer activity.	
Blinks white slowly	Indicates that firmware update is in progress.	
Blinks white five times rapidly and then powers off	Indicates that the iDRAC Quick Sync 2 feature is disabled.	Check if iDRAC Quick Sync 2 feature is configured to be disabled by iDRAC. www.dell.com/poweredgemanuals or <i>Dell OpenManage Server Administrator User's Guide</i> at www.dell.com/openmanagemanuals .
Solid amber	Indicates that the system is in fail-safe mode.	Restart the system.
Blinking amber	Indicates that the iDRAC Quick Sync 2 hardware is not responding properly.	Restart the system.

iDRAC Direct LED indicator codes

The iDRAC Direct LED indicator lights up to indicate that the port is connected and is being used as a part of the iDRAC subsystem.

You can configure iDRAC Direct by using a USB to micro USB (type AB) cable, which you can connect to your laptop or tablet. Cable length should not exceed 3 feet (0.91 meters). Performance could be affected by cable quality. The following table describes iDRAC Direct activity when the iDRAC Direct port is active:

Table 34. iDRAC Direct LED indicator codes

iDRAC Direct LED indicator code	Condition
Solid green for two seconds	Indicates that the laptop or tablet is connected.
Blinking green (on for two seconds and off for two seconds)	Indicates that the laptop or tablet connected is recognized.
Powers off	Indicates that the laptop or tablet is unplugged.

LCD panel

The LCD panel provides system information, status, and error messages to indicate if the system is functioning correctly or requires attention. The LCD panel is used to configure or view the iDRAC IP address of the system. For information about the event and error messages generated by the system firmware and agents that monitor system components, see the Error Code Lookup page at qrl.dell.com.

The LCD panel is available only on the optional front bezel. The optional front bezel is hot pluggable.

The status and conditions of the LCD panel are outlined here:

- The LCD backlight is white during normal operating conditions.
- If there is an issue, the LCD backlight turns amber and displays an error code followed by descriptive text.
- **NOTE: If the system is connected to a power source and an error is detected, the LCD turns amber regardless of whether the system is powered on or off.**
- When the system powers off and there are no errors, the LCD enters the standby mode after five minutes of inactivity. Press any button on the LCD to power it on.
- If the LCD panel stops responding, remove the bezel and reinstall it.
- The LCD backlight remains off if LCD messaging is powered off using the iDRAC utility, the LCD panel, or other tools.

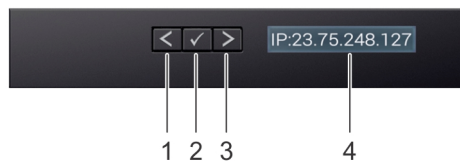

Figure 13. LCD panel features



Table 35. LCD panel features

Item	Button or display	Description
1	Left	Moves the cursor back in one-step increments.
2	Select	Selects the menu item highlighted by the cursor.
3	Right	Moves the cursor forward in one-step increments. During message scrolling: <ul style="list-style-type: none"> • Press and hold the right button to increase scrolling speed. • Release the button to stop. NOTE: The display stops scrolling when the button is released. After 45 seconds of inactivity, the display starts scrolling.
4	LCD display	Displays the system information, status, and error messages or iDRAC IP address.

Viewing Home screen

The **Home** screen displays user-configurable information about the system. This screen is displayed during normal system operation when there are no status messages or errors. When the system turns off and there are no errors, LCD enters the standby mode after five minutes of inactivity. Press any button on the LCD to turn it on.

Steps

1. To view the **Home** screen, press one of the three navigation buttons (Select, Left, or Right).
2. To navigate to the **Home** screen from another menu, complete the following steps:
 - a) Press and hold the navigation button till the up arrow  is displayed.
 - b) Navigate to the **Home** icon  using the up arrow .
 - c) Select the **Home** icon.
 - d) On the **Home** screen, press the **Select** button to enter the main menu.

Setup menu

 **NOTE:** When you select an option in the Setup menu, you must confirm the option before proceeding to the next action.

Table 36. Setup menu

Option	Description
iDRAC	Select DHCP or Static IP to configure the network mode. If Static IP is selected, the available fields are IP , Subnet (Sub) , and Gateway (Gtw) . Select Setup DNS to enable DNS and to view domain addresses. Two separate DNS entries are available.
Set error	Select SEL to view LCD error messages in a format that matches the IPMI description in the SEL. This enables you to match an LCD message with an SEL entry. Select Simple to view LCD error messages in a simplified user-friendly description. For information about the event and error messages generated by the system firmware and agents that monitor system components, see the Error Code Lookup page at qrl.dell.com .
Set home	Select the default information to be displayed on the Home screen. See View menu section for the options and option items that can be set as the default on the Home screen.

View menu

 **NOTE:** When you select an option in the View menu, you must confirm the option before proceeding to the next action.

Table 37. View menu

Option	Description
iDRAC IP	Displays the IPv4 or IPv6 addresses for iDRAC9. Addresses include DNS (Primary and Secondary) , Gateway , IP , and Subnet (IPv6 does not have Subnet).
MAC	Displays the MAC addresses for iDRAC , iSCSI , or Network devices.
Name	Displays the name of the Host , Model , or User String for the system.
Number	Displays the Asset tag or the Service tag for the system.
Power	Displays the power output of the system in BTU/hr or Watts. The display format can be configured in the Set home submenu of the Setup menu.
Temperature	Displays the temperature of the system in Celsius or Fahrenheit. The display format can be configured in the Set home submenu of the Setup menu.

NIC indicator codes

Each NIC on the back of the system has indicators that provide information about the activity and link status. The activity LED indicator indicates if data is flowing through the NIC, and the link LED indicator indicates the speed of the connected network.

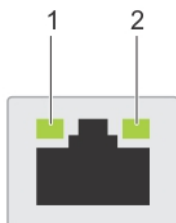

Figure 14. NIC indicator codes

1. Link LED indicator
2. Activity LED indicator

Table 38. NIC indicator codes

NIC indicator codes	Condition
Link and activity indicators are off.	Indicates that the NIC is not connected to the network.
Link indicator is green, and activity indicator is blinking green.	Indicates that the NIC is connected to a valid network at its maximum port speed, and data is being sent or received.
Link indicator is amber, and activity indicator is blinking green.	Indicates that the NIC is connected to a valid network at less than its maximum port speed, and data is being sent or received.
Link indicator is green, and activity indicator is off.	Indicates that the NIC is connected to a valid network at its maximum port speed, and data is not being sent or received.
Link indicator is amber, and activity indicator is off.	Indicates that the NIC is connected to a valid network at less than its maximum port speed, and data is not being sent or received.
Link indicator is blinking green, and activity is off.	Indicates that the NIC identify is enabled through the NIC configuration utility.

Power supply unit indicator codes

AC power supply units (PSUs) have an illuminated translucent handle that serves as an indicator. The indicator shows if power is present or if a power fault has occurred.

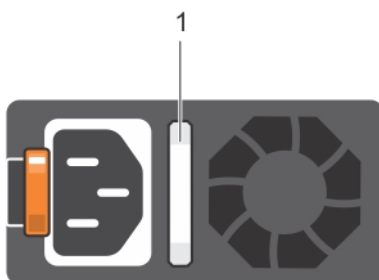

Figure 15. AC PSU status indicator

1. AC PSU status indicator/handle

Table 39. AC PSU status indicator codes

Power indicator codes	Condition
Green	Indicates that a valid power source is connected to the PSU and the PSU is operational.
Blinking amber	Indicates an issue with the PSU.

Power indicator codes	Condition
Not powered on	Indicates that the power is not connected to the PSU.
Blinking green	Indicates that the firmware of the PSU is being updated. CAUTION: Do not disconnect the power cord or unplug the PSU when updating firmware. If firmware update is interrupted, the PSUs do not function.
Blinking green and powers off	When hot-plugging a PSU, it blinks green five times at a rate of 4 Hz and powers off. This indicates a PSU mismatch due to efficiency, feature set, health status, or supported voltage. CAUTION: If two PSUs are installed, both the PSUs must have the same type of label; for example, Extended Power Performance (EPP) label. Mixing PSUs from previous generations of PowerEdge servers is not supported, even if the PSUs have the same power rating. This results in a PSU mismatch condition or failure to power on the system. CAUTION: If two PSUs are used, they must be of the same type and have the same maximum output power. CAUTION: When correcting a PSU mismatch, replace the PSU with the blinking indicator. Swapping the PSU to make a matched pair can result in an error condition and an unexpected system shutdown. To change from a high output configuration to a low output configuration or vice versa, you must power off the system. CAUTION: AC PSUs support both 240 V and 120 V input voltages with the exception of Titanium PSUs, which support only 240 V. When two identical PSUs receive different input voltages, they can output different wattages, and trigger a mismatch.

Drive indicator codes

The LEDs on the drive carrier indicates the state of each drive. Each drive carrier has two LEDs: an activity LED (green) and a status LED (bicolor, green/amber). The activity LED blinks whenever the drive is accessed.



Figure 16. Drive indicators on the drive and the mid drive tray backplane

1. Drive activity LED indicator
2. Drive status LED indicator
3. Drive capacity label

- NOTE:** If the drive is in the Advanced Host Controller Interface (AHCI) mode, the status LED indicator does not power on.
- NOTE:** Drive status indicator behavior is managed by Storage Spaces Direct. Not all drive status indicators may be used.

Table 40. Drive indicator codes

Drive status indicator code	Condition
Blinks green twice per second	Indicates that the drive is being identified or preparing for removal.
Off	Indicates that the drive is ready for removal. i NOTE: The drive status indicator remains off until all drives are initialized after the system is powered on. Drives are not ready for removal during this time.
Blinks green, amber, and then powers off	Indicates that there is an expected drive failure.
Blinks amber four times per second	Indicates that the drive has failed.
Blinks green slowly	Indicates that the drive is rebuilding.
Solid green	Indicates that the drive is online.
Blinks green for three seconds, amber for three seconds, and then powers off after six seconds	Indicates that the rebuild has stopped.

Getting help

Topics:

- [Recycling or End-of-Life service information](#)
- [Contacting Dell](#)
- [Accessing system information by using QRL](#)
- [Receiving automated support with SupportAssist](#)

Recycling or End-of-Life service information

Take back and recycling services are offered for this product in certain countries. If you want to dispose of system components, visit www.dell.com/recyclingworldwide and select the relevant country.

Contacting Dell

Dell provides online and telephone based support and service options. If you do not have an active internet connection, you can find Dell contact information on your purchase invoice, packing slip, bill or Dell product catalog. The availability of services varies depending on the country and product, and some services may not be available in your area. To contact Dell for sales, technical assistance, or customer service issues:

Steps

1. Go to www.dell.com/support/home
2. Select your country from the drop-down menu on the lower right corner of the page.
3. For customized support:
 - a) Enter the system Service Tag in the **Enter a Service Tag, Serial Number, Service Request, Model, or Keyword** field.
 - b) Click **Submit**.
The support page that lists the various support categories is displayed.
4. For general support:
 - a) Select your product category.
 - b) Select your product segment.
 - c) Select your product.
The support page that lists the various support categories is displayed.
5. For contact details of Dell Global Technical Support:
 - a) Click [Global Technical Support](#)
 - b) The **Contact Technical Support** page is displayed with details to call, chat, or e-mail the Dell Global Technical Support team.

Accessing system information by using QRL

The QRL is located on the top of the system cover.

Prerequisites

Ensure that your smartphone or tablet has the QR code scanner installed.

The QRL includes the following information about your system:

- How-to videos
- Reference materials, including the Installation and Service Manual, LCD diagnostics, and mechanical overview
- The system service tag to quickly access the specific hardware configuration and warranty information
- A direct link to Dell to contact technical assistance and sales teams

Steps

1. Go to www.dell.com/qrl and navigate to your specific product or
2. Use your smartphone or tablet to scan the model-specific Quick Resource (QR) code on your system or in the Quick Resource Locator section.

Quick Resource Locator for PowerEdge R7515 system



Figure 17. Quick Resource Locator for PowerEdge R7515 system

Receiving automated support with SupportAssist

Dell EMC SupportAssist is an optional Dell EMC Services offering that automates technical support for your Dell EMC server, storage, and networking devices. By installing and setting up a SupportAssist application in your IT environment, you can receive the following benefits:

- **Automated issue detection** — SupportAssist monitors your Dell EMC devices and automatically detects hardware issues, both proactively and predictively.
- **Automated case creation** — When an issue is detected, SupportAssist automatically opens a support case with Dell EMC Technical Support.
- **Automated diagnostic collection** — SupportAssist automatically collects system state information from your devices and uploads it securely to Dell EMC. This information is used by Dell EMC Technical Support to troubleshoot the issue.
- **Proactive contact** — A Dell EMC Technical Support agent contacts you about the support case and helps you resolve the issue.

The available benefits vary depending on the Dell EMC Service entitlement purchased for your device. For more information about SupportAssist, go to www.dell.com/supportassist.