

# OptiPlex Tower Plus 7020

## Owner's Manual

## Notes, cautions, and warnings

 **NOTE:** A NOTE indicates important information that helps you make better use of your product.

 **CAUTION:** A CAUTION indicates either potential damage to hardware or loss of data and tells you how to avoid the problem.

 **WARNING:** A WARNING indicates a potential for property damage, personal injury, or death.

<b>Chapter 1: Views of OptiPlex Tower Plus 7020</b> .....	<b>7</b>
Front.....	7
Back.....	8
<b>Chapter 2: Set up your OptiPlex Tower Plus 7020</b> .....	<b>11</b>
<b>Chapter 3: Specifications of OptiPlex Tower Plus 7020</b> .....	<b>17</b>
Dimensions and weight.....	17
Processor.....	17
Chipset.....	18
Operating system.....	18
Memory.....	19
Memory matrix.....	19
External ports.....	20
Internal slots.....	21
Ethernet.....	21
Wireless module.....	21
Audio.....	22
Storage.....	22
Storage matrix.....	23
Redundant Array of Independent Disks (RAID).....	23
Media-card reader.....	24
Power ratings.....	24
Power supply connector.....	25
GPU—Integrated.....	25
Video port resolution (GPU—Integrated).....	25
External display support (GPU—Integrated).....	26
GPU—Discrete.....	26
Video port resolution (GPU—Discrete).....	27
External display support (GPU—Discrete).....	27
Hardware security.....	27
Environmental.....	28
Regulatory compliance.....	28
Operating and storage environment.....	29
<b>Chapter 4: Working inside your computer</b> .....	<b>30</b>
Safety instructions.....	30
Before working inside your computer.....	30
Safety precautions.....	31
Electrostatic discharge—ESD protection.....	31
ESD Field Service kit .....	32
Transporting sensitive components.....	33
After working inside your computer.....	33
BitLocker.....	33

Recommended tools.....	33
Screw list.....	34
Major components of OptiPlex Tower Plus 7020.....	35
<b>Chapter 5: Removing and installing side cover.....</b>	<b>37</b>
Removing the side cover.....	37
Installing the side cover.....	38
<b>Chapter 6: Removing and installing coin-cell battery.....</b>	<b>40</b>
Removing the coin-cell battery.....	40
Installing the coin-cell battery.....	40
<b>Chapter 7: Removing and installing Customer Replaceable Units (CRUs).....</b>	<b>42</b>
Front bezel .....	42
Removing the front bezel.....	42
Installing the front bezel.....	43
Memory module.....	44
Removing the memory module.....	44
Installing the memory module.....	45
M.2 solid state drive.....	47
M.2 2230 solid-state drive.....	47
M.2 2280 solid-state drive.....	49
External puck antenna.....	51
Wireless card.....	51
Removing the wireless card.....	51
Installing the wireless card.....	52
Graphics Card.....	54
Removing the graphics card.....	54
Installing the graphics card.....	55
Removing the powered graphics card.....	56
Installing the powered graphics card.....	58
Media-card reader.....	60
Removing the media-card reader.....	60
Installing the media-card reader.....	61
Hard drive.....	63
3.5-inch hard drive.....	63
Optical drive.....	72
Removing the slim optical drive.....	72
Installing the slim optical drive.....	75
Internal speaker.....	79
Removing the internal speaker.....	79
Installing the internal speaker.....	79
Expansion card.....	80
Removing the network card.....	80
Installing the network card.....	81
Removing the serial/parallel port card.....	83
Installing the serial/parallel port card.....	84
Intrusion switch.....	86
Removing the intrusion switch.....	86

Installing the intrusion switch.....	87
<b>Chapter 8: Removing and installing Field Replaceable Units (FRUs).....</b>	<b>88</b>
Power button.....	88
Removing the power button.....	88
Installing the power button.....	89
Wireless antenna kit.....	90
Internal antenna module.....	90
External SMA antenna module.....	94
Processor fan and heat-sink assembly.....	98
Removing the processor fan and heat-sink assembly (for 65 W processors).....	98
Installing the processor fan and heat-sink assembly (for 65 W processors).....	99
Removing the processor fan and heat-sink assembly (for 125 W processors).....	100
Installing the processor fan and heat-sink assembly (for 125 W processors).....	101
Power-supply unit.....	102
Removing the power-supply unit.....	102
Installing the power-supply unit .....	104
System fan.....	106
Removing the system fan.....	106
Installing the system fan.....	107
Processor.....	109
Removing the processor.....	109
Installing the processor.....	109
Voltage-regulator heat sink.....	110
Removing the voltage-regulator heat sink.....	110
Installing the voltage-regulator heat sink.....	111
Optional I/O modules.....	112
Optional serial module.....	112
Optional PS2 and serial module.....	114
Optional HDMI module.....	117
Optional DisplayPort module.....	119
Optional VGA module.....	120
Optional USB Type-C module.....	122
System board.....	124
Removing the system board.....	124
Installing the system board.....	130
<b>Chapter 9: Software.....</b>	<b>135</b>
Operating system.....	135
Drivers and downloads.....	135
<b>Chapter 10: BIOS Setup.....</b>	<b>136</b>
Entering BIOS Setup program.....	136
Navigation keys.....	136
F12 One Time Boot menu.....	136
System setup options.....	137
Updating the BIOS.....	151
Updating the BIOS in Windows.....	151
Updating the BIOS in Linux and Ubuntu.....	151

Updating the BIOS using the USB drive in Windows.....	151
Updating the BIOS from the F12 One-Time boot menu.....	152
System and setup password.....	152
Assigning a System Setup password.....	153
Deleting or changing an existing system setup password.....	153
Clearing CMOS settings.....	154
Clearing BIOS (System Setup) and System passwords.....	154
<b>Chapter 11: Troubleshooting.....</b>	<b>155</b>
Dell SupportAssist Pre-boot System Performance Check diagnostics.....	155
Running the SupportAssist Pre-Boot System Performance Check.....	155
Power-Supply Unit Built-in Self-Test .....	155
System-diagnostic lights.....	155
Recovering the operating system.....	156
Real Time Clock—RTC reset.....	157
Backup media and recovery options.....	157
Wi-Fi power cycle.....	157
<b>Chapter 12: Getting help and contacting Dell.....</b>	<b>159</b>

# Views of OptiPlex Tower Plus 7020

## Front

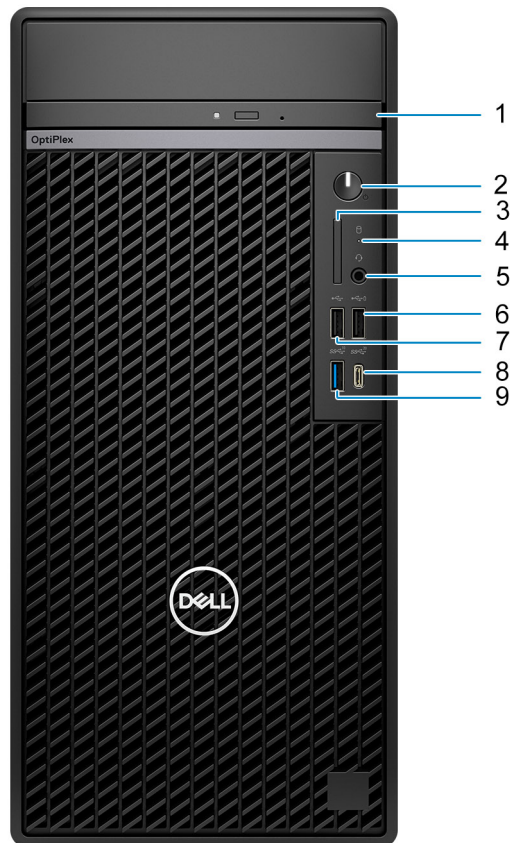

**Figure 1. Front view**

**1. Slim optical drive (optional)**

Reads from and writes to CDs and DVDs.

**2. Power button with diagnostic LED**

Press to turn on the system if it is turned off, in sleep state, or in hibernate state.

When the system is turned on, press the power button to put the system into sleep state; press and hold the power button for four seconds to force shut-down the system.

**NOTE:** You can customize the power-button behavior in Windows.

Indicates the power-supply state.

**3. SD-card slot (optional)**

Reads from and writes to the SD card.

**4. Hard-drive activity light**

The activity light turns on when the system reads from or writes to the hard drive.

**5. Universal Audio port**

Connect headphones or a headset (headphone and microphone combo).

**6. USB 2.0 (480 Mbps) with PowerShare port**

Connect devices such as external storage devices and printers. Provides data transfer speeds of up to 480 Mbps.

**NOTE:** PowerShare enables you to charge your USB devices even when your system is turned off.

**NOTE:** If a USB device is connected to the PowerShare port before the system is turned off or in hibernate state, you must disconnect and connect it again to enable charging.

**7. USB 2.0 (480 Mbps) port**

Connect devices such as external storage devices and printers. Provides data transfer speeds of up to 480 Mbps.

**8. USB 3.2 Gen 2x2 (20 Gbps) Type-C port**

Connect devices such as external storage devices, printers, and external displays. Provides data transfer speeds of up to 20 Gbps.

**NOTE:** This port does not support video/audio streaming.

**9. USB 3.2 Gen 2 (10 Gbps) port**

Connect devices such as external storage devices and printers. Provides data transfer speeds of up to 10 Gbps.

## Back

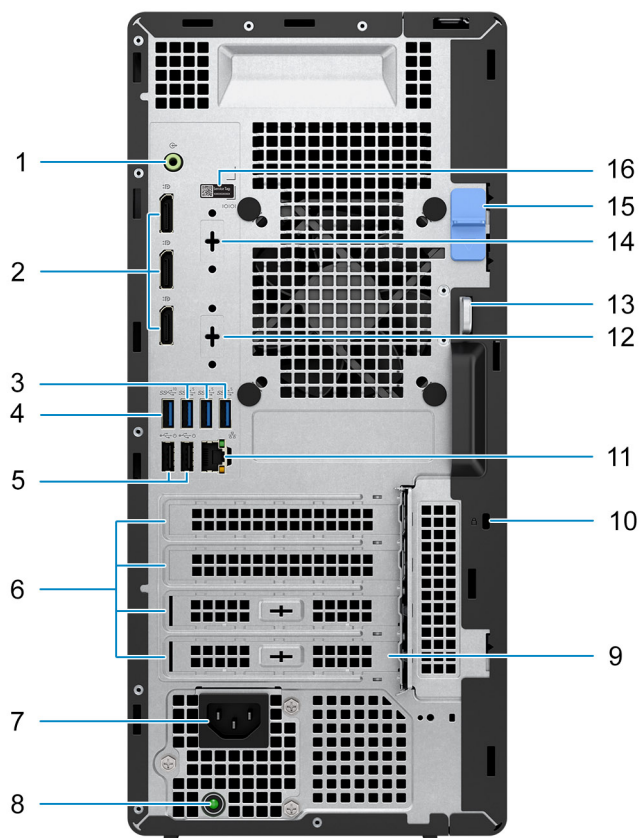

Figure 2. Back view



**1. Retaskable line-out/line-in audio port**

Connect recording or playback devices such as microphone or CD player.  
Connect speakers.

**2. Three DisplayPort 1.4a ports (HBR2 support)**

Connect an external display or a projector.

**i** **NOTE:** The maximum resolution that is supported is up to 4096 x 2304 @ 60 Hz.

**3. Three USB 3.2 Gen 1 (5 Gbps) ports**

Connect devices such as external storage devices and printers. Provides data transfer speeds of up to 5 Gbps.

**4. USB 3.2 Gen 2 (10 Gbps) port**

Connect devices such as external storage devices and printers. Provides data transfer speeds of up to 10 Gbps.

**5. Two USB 2.0 (480 Mbps) with SmartPower On ports**

Connect devices such as external storage devices and printers. Provides data transfer speeds of up to 480 Mbps.

**i** **NOTE:** When USB wake is enabled in the BIOS the system will power on or wake from hibernation when a USB mouse or keyboard that is connected to this port is used.

**6. Four expansion card slots**

Connect a PCI-Express card such as graphics, audio, or network card to enhance the capabilities of your system.

**7. Power-cord connector port**

Connect a power cable to provide power to your system.

**8. Power-supply diagnostic light**

Indicates the power-supply state.

**9. External puck antenna (optional)**

Connect an external puck antenna.

**10. Security-cable slot (for Kensington locks)**

Connect a security cable to prevent unauthorized movement of your system.

**11. Network port**

Connect an Ethernet (RJ45) cable from a router or a broadband modem for network or Internet access.

**12. Optional port (HDMI 2.1/DisplayPort 1.4a (HBR3 support)/VGA/USB 3.2 Gen 2 (10 Gbps) Type-C with DisplayPort port)**

The port available at this location may vary depending on the optional I/O card installed on your computer.

● **HDMI 2.1 port**

Connect to a TV, external display or another HDMI-in enabled device. Maximum resolution supported up to 4096 x 2160 @ 60 Hz.

● **DisplayPort 1.4a (HBR3 support)**

Connect an external display or a projector. Maximum resolution supported up to 5120 x 3200 @ 60 Hz.

● **VGA port**

Connect an external display or a projector. Maximum resolution supported up to 1920 x 1200 @ 60 Hz.

● **USB 3.2 Gen 2 (10 Gbps) Type-C with DisplayPort port**

Connect devices such as external storage devices and printers. Provides data transfer speeds of up to 10 Gbps. Maximum resolution supported up to 5120 x 3200 @ 60 Hz with a Type-C to DisplayPort adapter.

**13. Padlock ring**

Attach a standard padlock to prevent unauthorized access to the interior of your system.

**14. Serial port (optional)**

Connect serial I/O devices.

**15. Release latch**

Lock or unlock the side cover to the system chassis. Slide the latch to the unlock position to release the side cover.

**16. Service Tag label**

The Service Tag is a unique alphanumeric identifier that enables Dell service technicians to identify the hardware components in your system and access warranty information.

# Set up your OptiPlex Tower Plus 7020

## Steps

1. Connect the keyboard and mouse.

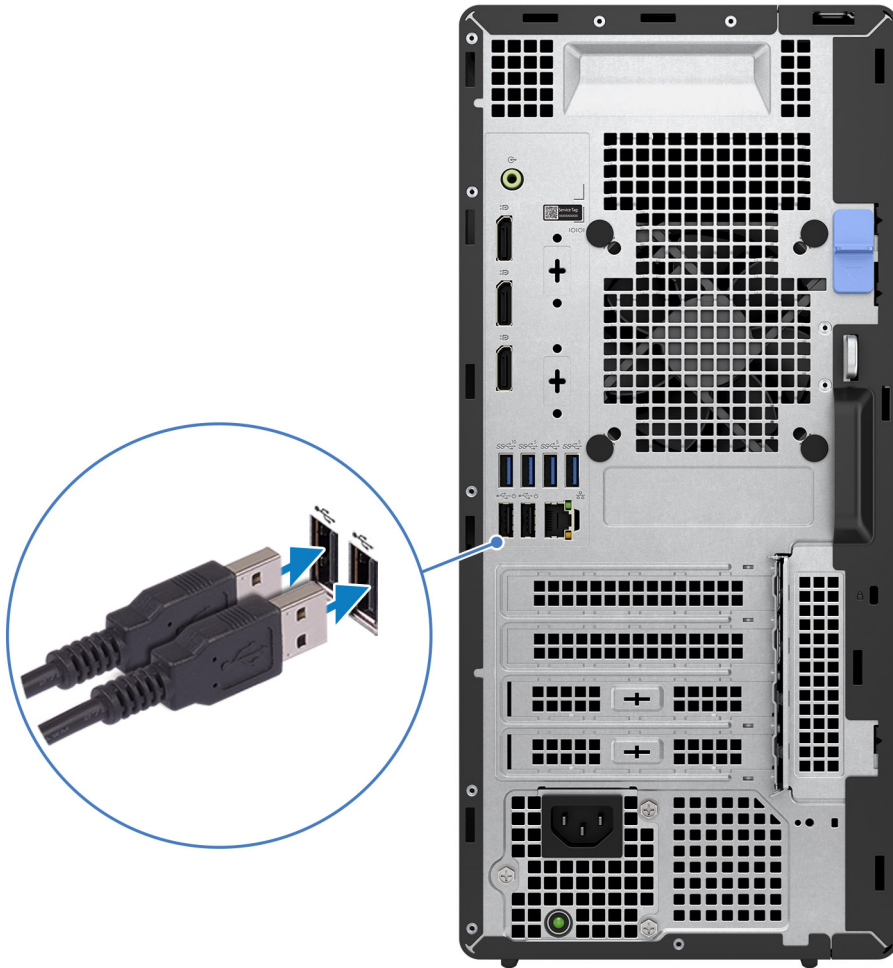

**Figure 3. Connect the keyboard and the mouse**

2. Connect to your network using a cable, or connect to a wireless network.

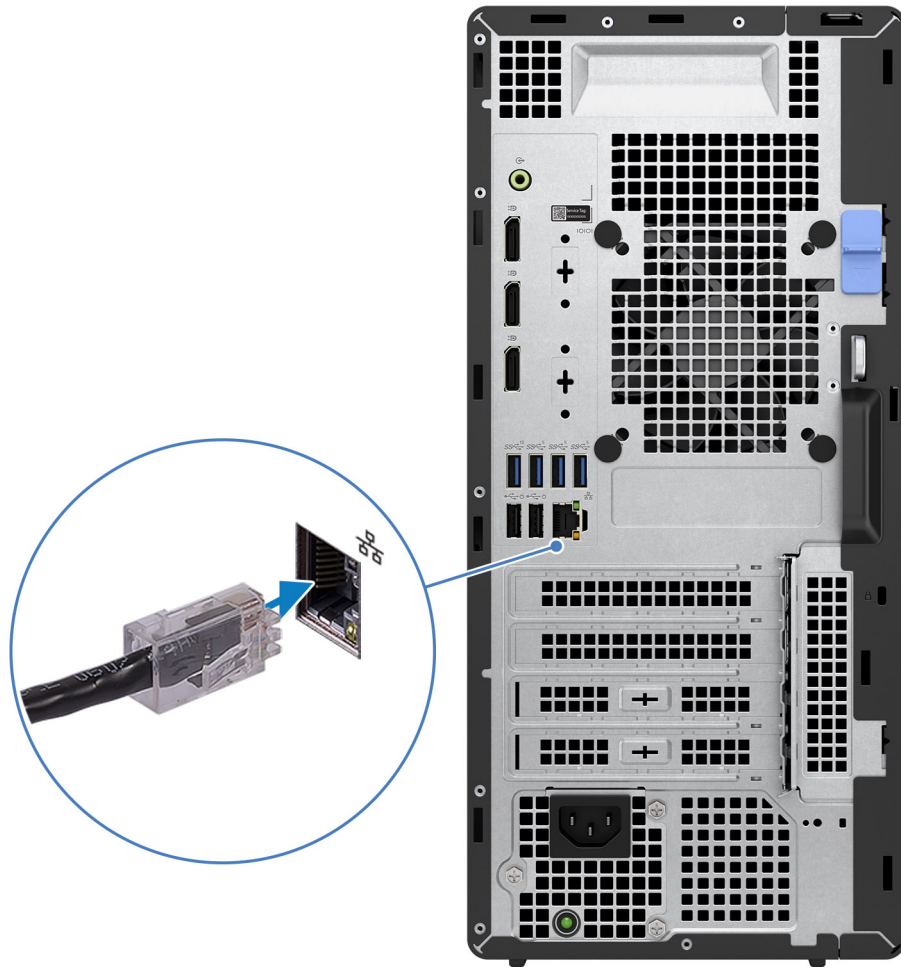

**Figure 4. Connect to your network using a cable, or connect to a wireless network**

3. Connect the display.



**Figure 5. Connect the display**

4. Connect the power cable.

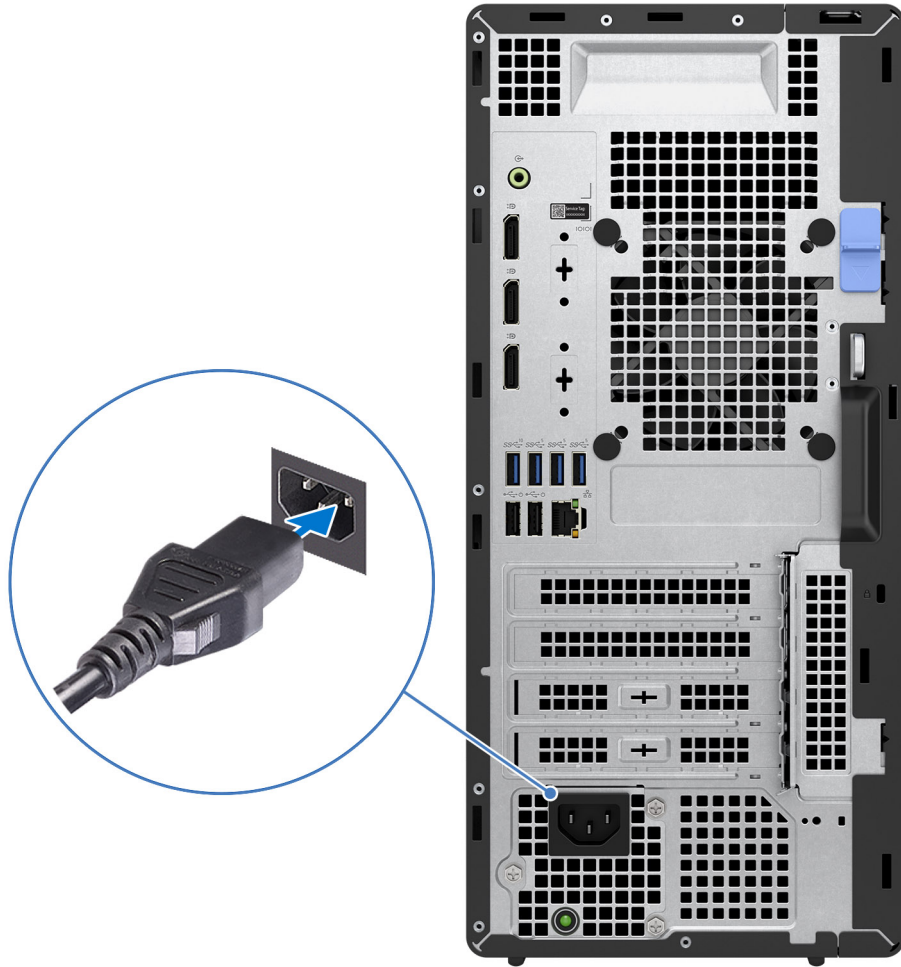

**Figure 6. Connect the power cable**

5. Press the power button.



**Figure 7. Press the power button**

6. Finish the operating system setup.

**For Ubuntu:**

Follow the on-screen instructions to complete the setup. For more information about installing and configuring Ubuntu, search in the Knowledge Base Resource at [Dell Support Site](#).





**For Windows:**

Follow the on-screen instructions to complete the setup. When setting up, Dell Technologies recommends that you:

- Connect to a network for Windows updates.
  - ① **NOTE:** If connecting to a secured wireless network, enter the password for the wireless network access when prompted.
- If connected to the Internet, sign-in with or create a Microsoft account. If not connected to the Internet, create an offline account.
- On the **Support and Protection** screen, enter your contact details.

7. Locate and use Dell apps from the Windows Start menu—Recommended.

**Table 1. Locate Dell apps**

Resources	Description
	<p><b>SupportAssist</b></p> <p>SupportAssist proactively and predictively identifies hardware and software issues on your computer and automates the engagement process with Dell Technical support. It addresses performance and stabilization issues, prevents security threats, monitors, and detects hardware failures. For more information, see <i>SupportAssist for Home PCs User's Guide</i> at <a href="#">SupportAssist for Home PCs</a>.</p> <p> <b>NOTE:</b> In SupportAssist, click the warranty expiry date to renew or upgrade your warranty.</p>
	<p><b>Dell Update</b></p> <p>Updates your computer with critical fixes and latest device drivers as they become available. For more information about using Dell Update, see the product guides and third-party license documents at <a href="#">Dell Support Site</a>.</p>
	<p><b>Dell Digital Delivery</b></p> <p>Download software applications, which are purchased but not preinstalled on your computer. For more information about using Dell Digital Delivery, search in the Knowledge Base Resource at <a href="#">Dell Support Site</a>.</p>



# Specifications of OptiPlex Tower Plus 7020

## Dimensions and weight

The following table lists the height, width, depth, and weight of your OptiPlex Tower Plus 7020.

**Table 2. Dimensions and weight**

Description	Values
Height	367 mm (14.45 in.)
Width	169 mm (6.65 in.)
Depth	300.80 mm (11.84 in.)
Weight  <b>NOTE:</b> The weight of your computer depends on the configuration ordered and manufacturing variability.	<ul style="list-style-type: none"> <li>• Minimum: 5.93 kg (13.07 lb)</li> <li>• Maximum: 9.63 kg (21.24 lb)</li> </ul>

## Processor

The following table lists the details of the processors that are supported by your OptiPlex Tower Plus 7020.

**Table 3. Processor**

Description	Option one	Option two	Option three	Option four	Option five	Option six	Option seven	Option eight
Processor type	Intel Core i3 14100	Intel Core i5 14500 vPro	Intel Core i5 14600 vPro	Intel Core i5 14600K vPro	Intel Core i7 14700 vPro	Intel Core i7 14700K vPro	Intel Core i9 14900 vPro	Intel Core i9 14900K vPro
Processor wattage	60 W	65 W	65 W	125 W	65 W	125 W	65 W	125 W
Processor total core count	4	14	14	14	20	20	24	24
Performance-cores	4	6	6	6	8	8	8	8
Efficient-cores	None	8	8	8	12	12	16	16
 <b>NOTE:</b> Intel Hyper-Threading Technology is only available on Performance-cores.								
Processor total thread counts	8	20	20	20	28	28	32	32
Processor speed	Up to 4.70 GHz	Up to 5 GHz	Up to 5.20 GHz	Up to 5.30 GHz	Up to 5.30 GHz	Up to 5.50 GHz	Up to 5.40 GHz	Up to 5.60 GHz
Performance-cores frequency								

**Table 3. Processor (continued)**

Description	Option one	Option two	Option three	Option four	Option five	Option six	Option seven	Option eight
Processor base frequency	3.50 GHz	2.60 GHz	2.70 GHz	3.50 GHz	2.10 GHz	3.40 GHz	2 GHz	3.20 GHz
Maximum turbo frequency	4.70 GHz	5 GHz	5.20 GHz	5.30 GHz	5.30 GHz	5.50 GHz	5.40 GHz	5.60 GHz
Efficient-cores frequency								
Processor base frequency	Not applicable	1.90 GHz	2 GHz	2.60 GHz	1.50 GHz	2.50 GHz	1.50 GHz	2.50 GHz
Maximum turbo frequency	Not applicable	3.70 GHz	3.90 GHz	4 GHz	4.20 GHz	4.30 GHz	4.30 GHz	4.40 GHz
Processor cache	12 MB	24 MB	24 MB	24 MB	33 MB	33 MB	36 MB	36 MB
Integrated graphics	Intel UHD Graphics 730	Intel UHD Graphics 770	Intel UHD Graphics 770	Intel UHD Graphics 770	Intel UHD Graphics 770	Intel UHD Graphics 770	Intel UHD Graphics 770	Intel UHD Graphics 770

## Chipset

The following table lists the details of the chipset that is supported for your OptiPlex Tower Plus 7020.

**Table 4. Chipset**

Description	Values
Chipset	Intel Q670
Processor	<ul style="list-style-type: none"> <li>• 14th Gen Intel Core i3</li> <li>• 14th Gen Intel Core i5 vPro/i5K vPro</li> <li>• 14th Gen Intel Core i7 vPro/i7K vPro</li> <li>• 14th Gen Intel Core i9 vPro/i9K vPro</li> </ul>
DRAM bus width	64-bit
Flash EPROM	32 MB + 16 MB
PCIe bus	Up to Gen4

## Operating system

Your OptiPlex Tower Plus 7020 supports the following operating systems:

- Windows 11 Home
- Windows 11 Pro
- Windows 11 Pro National Education
- Ubuntu Linux 22.04 LTS

# Memory

The following table lists the memory specifications of your OptiPlex Tower Plus 7020.

**Table 5. Memory specifications**

Description	Values
Memory slots	Four UDIMM slots
Memory type	DDR5
Memory speed	<ul style="list-style-type: none"> <li>• 3600 MT/s</li> <li>• 4000 MT/s</li> <li>• 4400 MT/s</li> </ul>
Maximum memory configuration	128 GB
Minimum memory configuration	8 GB
Memory size per slot	8 GB, 16 GB, or 32 GB
Memory configurations supported	<ul style="list-style-type: none"> <li>• 8 GB: 1 x 8 GB, DDR5, 4400 MT/s, UDIMM, single-channel</li> <li>• 16 GB: 1 x 16 GB, DDR5, 4400 MT/s, UDIMM, single-channel</li> <li>• 16 GB: 2 x 8 GB, DDR5, 4400 MT/s, UDIMM, dual-channel</li> <li>• 32 GB: 1 x 32 GB, DDR5, 4400 MT/s, UDIMM, single-channel</li> <li>• 32 GB: 2 x 16 GB, DDR5, 4400 MT/s, UDIMM, dual-channel</li> <li>• 32 GB: 4 x 8 GB, DDR5, 4000 MT/s, UDIMM, quad-channel</li> <li>• 64 GB: 2 x 32 GB, DDR5, 4400 MT/s, UDIMM, dual-channel</li> <li>• 64 GB: 4 x 16 GB, DDR5, 4000 MT/s, UDIMM, quad-channel</li> <li>• 128 GB: 4 x 32 GB, DDR5, 3600 MT/s, UDIMM, quad-channel</li> </ul>

## Memory matrix

The following table lists the memory configurations supported on your OptiPlex Tower Plus 7020.

**Table 6. Memory matrix**

Configuration	Slot			
	UDIMM1	UDIMM2	UDIMM3	UDIMM4
8 GB DDR5	8 GB			
16 GB DDR5	8 GB	8 GB		
16 GB DDR5	16 GB			
32 GB DDR5	8 GB	8 GB	8 GB	8 GB
32 GB DDR5	16 GB	16 GB		
32 GB DDR5	32 GB			
64 GB DDR5	16 GB	16 GB	16 GB	16 GB

**Table 6. Memory matrix (continued)**

Configuration	Slot			
	UDIMM1	UDIMM2	UDIMM3	UDIMM4
64 GB DDR5	32 GB	32 GB		
128 GB DDR5	32 GB	32 GB	32 GB	32 GB

## External ports

The following table lists the external ports of your OptiPlex Tower Plus 7020.

**Table 7. External ports**

Description	Values
Network port	One RJ45 Ethernet port 10/100/1000 Mbps
USB ports	<ul style="list-style-type: none"> <li>• Three USB 3.2 Gen 1 (5 Gbps) ports</li> <li>• Two USB 2.0 (480 Mbps) with SmartPower On ports</li> <li>• One USB 2.0 (480 Mbps) with PowerShare port</li> <li>• One USB 2.0 (480 Mbps) port</li> <li>• One USB 3.2 Gen 2x2 (20 Gbps) Type-C port</li> <li>• <b>NOTE:</b> This port does not support video/audio streaming.</li> <li>• One USB 3.2 Gen 2 (10 Gbps) port</li> <li>• One USB 3.2 Gen 2 (10 Gbps) port</li> <li>• One optional USB 3.2 Gen 2 (10 Gbps) Type-C with DisplayPort port</li> </ul>
Audio port	<ul style="list-style-type: none"> <li>• One Universal Audio port</li> <li>• One retaskable line-in/line-out audio port</li> </ul>
Video port	<ul style="list-style-type: none"> <li>• Three DisplayPort 1.4a (HBR2 support) ports</li> <li>• <b>NOTE:</b> The maximum resolution supported by DisplayPort 1.4a is up to 4096 x 2304 @ 60 Hz.</li> <li>• One optional port (HDMI 2.1/DisplayPort 1.4a (HBR3 support)/VGA/USB 3.2 Gen 2 (10 Gbps) Type-C with DisplayPort port)</li> <li>• <b>NOTE:</b> The maximum resolution supported by optional port is <ul style="list-style-type: none"> <li>○ <b>HDMI 2.1 port:</b> Up to 4096 x 2160 @ 60 Hz</li> <li>○ <b>DisplayPort 1.4a (HBR3 support) port:</b> Up to 5120 x 3200 @ 60 Hz</li> <li>○ <b>VGA port:</b> Up to 1920 x 1200 @ 60 Hz</li> <li>○ <b>USB 3.2 Gen 2 (10 Gbps) Type-C with DisplayPort port:</b> Up to 5120 x 3200 @ 60 Hz</li> </ul> </li> </ul>
I/O port	One optional serial port
Media-card reader	One optional SD-card 4.0 slot
Power port	One power-cable connector
Security-cable slot	<ul style="list-style-type: none"> <li>• One security-cable slot (for Kensington locks)</li> <li>• One padlock ring</li> </ul>

# Internal slots

The following table lists the internal slots of your OptiPlex Tower Plus 7020.

**Table 8. Internal slots**

Description	Values
M.2	<ul style="list-style-type: none"> <li>• Three M.2 2230/2280 slots for solid-state drive</li> <li>• One M.2 2230 slot for WiFi and Bluetooth combo card</li> </ul> <p><b>NOTE:</b> To learn more about the features of different types of M.2 cards, search in the Knowledge Base Resource at <a href="#">Dell Support Site</a>.</p>
SATA	<p>Four SATA 3.0 slots for 3.5-inch hard-disk drive and slim optical drive.</p> <p><b>NOTE:</b> Installing a slim optical drive causes the SATA 3.0 port to operate as SATA 2.0 port.</p>
Expansion	<ul style="list-style-type: none"> <li>• One full-height Gen4 PCIe x16 slot</li> <li>• One full-height Gen3 PCIe x4 open-end slot</li> <li>• One full-height Gen3 PCIe x1 slot</li> <li>• One full-height PCI slot</li> </ul>

# Ethernet

The following table lists the wired Ethernet Local Area Network (LAN) specifications of your OptiPlex Tower Plus 7020.

**Table 9. Ethernet specifications**

Description	Values
Model number	Intel WGi219LM
Transfer rate	10/100/1000 Mbps

# Wireless module

The following table lists the Wireless Local Area Network (WLAN) modules that are supported on your OptiPlex Tower Plus 7020.

**Table 10. Wireless module specifications**

Description	Option one	Option two
Model number	<p>Intel AX211</p> <p><b>NOTE:</b> Computers shipped with Intel Wi-Fi 6E AX211 wireless card come with an external puck antenna installed.</p>	Realtek RTL8852BE
Transfer rate	Up to 2400 Mbps	Up to 1201 Mbps
Frequency bands supported	2.4 GHz/5 GHz/6 GHz	2.4 GHz/5 GHz
Wireless standards	<ul style="list-style-type: none"> <li>• Wi-Fi 802.11 a/b/g</li> </ul>	<ul style="list-style-type: none"> <li>• Wi-Fi 802.11 a/b/g</li> </ul>

**Table 10. Wireless module specifications (continued)**

Description	Option one	Option two
	<ul style="list-style-type: none"> <li>• Wi-Fi 4 (WiFi 802.11n)</li> <li>• Wi-Fi 5 (WiFi 802.11ac)</li> <li>• Wi-Fi 6E (WiFi 802.11ax)</li> </ul>	<ul style="list-style-type: none"> <li>• Wi-Fi 4 (WiFi 802.11n)</li> <li>• Wi-Fi 5 (WiFi 802.11ac)</li> <li>• Wi-Fi 6 (WiFi 802.11ax)</li> </ul>
Encryption	<ul style="list-style-type: none"> <li>• 64-bit/128-bit WEP</li> <li>• AES-CCMP</li> <li>• TKIP</li> </ul>	<ul style="list-style-type: none"> <li>• 64-bit/128-bit WEP</li> <li>• AES-CCMP</li> <li>• TKIP</li> </ul>
Bluetooth wireless card	Bluetooth 5.3	Bluetooth 5.3
	 <b>NOTE:</b> The version of the Bluetooth wireless card may vary depending on the operating system that is installed on your computer.	

## Audio

The following table lists the audio specifications of your OptiPlex Tower Plus 7020.

**Table 11. Audio specifications**

Description	Values
Audio type	High Definition Audio
Audio controller	Realtek ALC3246-CG
Internal audio interface	High Definition Audio (HDA) interface
External audio interface	<ul style="list-style-type: none"> <li>• One Universal Audio port</li> <li>• One retaskable line-in/line-out audio port</li> </ul>

## Storage

This section lists the storage options on your OptiPlex Tower Plus 7020.

**Table 12. Storage specifications**

Storage type	Interface type	Capacity
3.5-inch, 7200 RPM, hard-disk drive	SATA 3.0	Up to 2 TB
3.5-inch, 5400 RPM, hard-disk drive	SATA 3.0	4 TB
M.2 2230 solid-state drive, Class 25	PCIe Gen4 x4 NVMe	Up to 2 TB
M.2 2230 solid-state drive, Class 35	PCIe Gen4 x4 NVMe	Up to 1 TB
M.2 2230 Opal Self-Encrypting solid-state drive, Class 35	PCIe Gen4 x4 NVMe	256 GB
M.2 2280 solid-state drive, Class 40	PCIe Gen4 x4 NVMe	Up to 2 TB
M.2 2280 Opal Self-Encrypting solid-state drive, Class 40	PCIe Gen4 x4 NVMe	Up to 1 TB

## Storage matrix

The following table lists the storage configurations supported on your OptiPlex Tower Plus 7020.

**Table 13. Storage matrix**

Storage	Slot				
	SSD0 (Primary M.2 PCIe for boot function)	SSD1	SSD2	SATA0	SATA1
One M.2 2230/2280 solid-state drive	Yes				
Two M.2 2230/2280 solid-state drives	Yes	Yes			
Three M.2 2230/2280 solid-state drives	Yes	Yes	Yes		
One M.2 2230/2280 solid-state drive + One 3.5-inch hard-disk drive	Yes			Yes	
One M.2 2230/2280 solid-state drive + Two 3.5-inch hard-disk drives	Yes			Yes	Yes
Two M.2 2230/2280 solid-state drives + One 3.5-inch hard-disk drive	Yes	Yes		Yes	
Two M.2 2230/2280 solid-state drives + Two 3.5-inch hard-disk drives	Yes	Yes		Yes	Yes
Two M.2 2230/2280 solid-state drives + One 3.5-inch hard-disk drive	Yes	Yes		Yes	
Three M.2 2230/2280 solid-state drives + Two 3.5-inch hard-disk drives	Yes	Yes	Yes	Yes	Yes

## Redundant Array of Independent Disks (RAID)

For optimal performance when configuring drives as a RAID volume, Dell Technologies recommends drive models that are identical.

 **NOTE:** RAID is not supported on Intel Optane configurations.

RAID 0 (Striped, Performance) volumes benefit from higher performance when drives are matched because the data is split across multiple drives: any I/O operations with block sizes larger than the stripe size splits the I/O and become constrained by the slowest of the drives. For RAID 0 I/O operations where block sizes are smaller than the stripe size, whichever drive the I/O operation targets, determines the performance, which increases variability and results in inconsistent latencies. This variability is particularly pronounced for write operations, and it can be problematic for applications that are latency sensitive. One such example of this is any application that performs thousands of random writes per second in very small block sizes.

RAID 1 (Mirrored, Data Protection) volumes benefit from higher performance when drives are matched because the data is mirrored across multiple drives all I/O operations must be performed identically to both drives, thus variations in drive performance when the models are different result in the I/O operations completing only as fast as the slowest drive. While this does not suffer from the variable latency issue in small random I/O operations as with RAID 0 across heterogeneous drives, the impact is nonetheless large because the higher performing drive becomes limited in all I/O types. One of the worst examples of constrained performance here is when using unbuffered I/O. To ensure that that writes are fully committed to nonvolatile regions of the RAID volume, unbuffered I/O bypasses cache (for example by using the Force Unit Access bit in the NVMe protocol) and the I/O operation will not complete until all the drives in the RAID volume have completed the request to commit the data. This kind of I/O operation completely negates any advantage of a higher performing drive in the volume.

Care must be taken to match not only the drive vendor, capacity, and class, but also the specific model. Drives from the same vendor, with the same capacity, and even within the same class, can have different performance characteristics for certain types of I/O operations. Thus, matching by model ensures that the RAID volume consists of a homogeneous array of drives that deliver all the benefits of a RAID volume without incurring the additional penalties when one or more drives in the volume are lower performing.

OptiPlex Tower Plus 7020 supports RAID with more than one hard drive configuration.

## Media-card reader

The following table lists the media cards that are supported on your OptiPlex Tower Plus 7020.

**Table 14. Media-card reader specifications**

Description	Values
Media-card type	One optional SD-card 4.0 slot
Media-cards supported	<ul style="list-style-type: none"> <li>Secure Digital (SD)</li> <li>Secure Digital High Capacity (SDHC)</li> <li>Secure Digital Extended Capacity (SDXC)</li> </ul>
<p><b>NOTE:</b> The maximum capacity that is supported by the media-card reader varies depending on the standard of the media card that is installed on your computer.</p>	

## Power ratings

The following table lists the power rating specifications of OptiPlex Tower Plus 7020.

**Table 15. Power ratings**

Description	Option one	Option two
Type	260 W internal power supply unit (PSU), 85% Efficient, 80 Plus Bronze	500 W internal power supply unit (PSU), 92% Efficient, 80 Plus Platinum
Input voltage	90 VAC to 264 VAC	90 VAC to 264 VAC
Input frequency	47 Hz to 63 Hz	47 Hz to 63 Hz
Input current (maximum)	4.20 A	7 A
Output current (continuous)	Operating: <ul style="list-style-type: none"> <li>12 VA: 18 A</li> <li>12 VB: 16 A</li> </ul> Standby: <ul style="list-style-type: none"> <li>12 VA: 1.50 A</li> <li>12 VB: 3.30 A</li> </ul>	Operating: <ul style="list-style-type: none"> <li>12 VA: 18 A</li> <li>12 VB: 18 A</li> <li>12 VC: 18 A</li> </ul> Standby: <ul style="list-style-type: none"> <li>12 VA: 1.50 A</li> <li>12 VB: 3.30 A</li> <li>12 VC: 0 A</li> </ul>



**Table 15. Power ratings (continued)**

Description		Option one	Option two
Rated output voltage		<ul style="list-style-type: none"> <li>12 VA</li> <li>12 VB</li> </ul>	<ul style="list-style-type: none"> <li>12 VA</li> <li>12 VB</li> <li>12 VC</li> </ul>
Temperature range			
Operating		5°C to 45°C (41°F to 113°F)	5°C to 45°C (41°F to 113°F)
Storage		-40°C to 70°C (-40°F to 158°F)	-40°C to 70°C (-40°F to 158°F)

## Power supply connector

The following table lists the Power supply connector specifications of your OptiPlex Tower Plus 7020.

**Table 16. Power supply connector**

Connector type	Description
260 W internal power supply unit (PSU), 85% Efficient, 80 Plus Bronze	<ul style="list-style-type: none"> <li>Two 4-pin connectors for processor</li> <li>One 8-pin connector for system board</li> </ul>
500 W internal power supply unit (PSU), 92% Efficient, 80 Plus Platinum	<ul style="list-style-type: none"> <li>Two 4-pin connectors for processor</li> <li>One 8-pin connector for system board</li> <li>One 6-pin and one 2+6-pin connectors for graphic card</li> </ul>

## GPU—Integrated

The following table lists the specifications of the integrated Graphics Processing Unit (GPU) supported by your OptiPlex Tower Plus 7020.

**Table 17. GPU—Integrated**

Controller	Memory size	Processor
Intel UHD Graphics 730	Shared system memory	Intel Core i3
Intel UHD Graphics 770	Shared system memory	<ul style="list-style-type: none"> <li>Intel Core i5 vPro/i5K vPro</li> <li>Intel Core i7 vPro/i7K vPro</li> <li>Intel Core i9 vPro/i9K vPro</li> </ul>

## Video port resolution (GPU—Integrated)

**Table 18. Video port resolution (GPU—Integrated)**

Graphics card	Video ports	Maximum supported resolution
Intel UHD Graphics 730	<ul style="list-style-type: none"> <li>Three DisplayPort 1.4a (HBR2 support) ports</li> <li>One optional port (HDMI 2.1/DisplayPort 1.4a (HBR3 support)/VGA/USB 3.2 Gen 2 (10 Gbps) Type-C with DisplayPort port)</li> </ul>	<ul style="list-style-type: none"> <li><b>DisplayPort 1.4a (HBR2 support) port:</b> 4096 x 2304 @ 60 Hz</li> <li><b>One optional port -</b> <ul style="list-style-type: none"> <li><b>HDMI 2.1 port:</b> Up to 4096 x 2160 @ 60 Hz</li> <li><b>DisplayPort 1.4a (HBR3 support) port:</b> Up to 5120 x 3200 @ 60 Hz</li> </ul> </li> </ul>

**Table 18. Video port resolution (GPU—Integrated) (continued)**

Graphics card	Video ports	Maximum supported resolution
		<ul style="list-style-type: none"> <li>○ <b>VGA port:</b> Up to 1920 x 1200 @ 60 Hz</li> <li>○ <b>USB 3.2 Gen 2 (10 Gbps) Type-C with DisplayPort port:</b> Up to 5120 x 3200 @ 60 Hz</li> </ul>
Intel UHD Graphics 770	<ul style="list-style-type: none"> <li>● Three DisplayPort 1.4a (HBR2 support) ports</li> <li>● One optional port (HDMI 2.1/DisplayPort 1.4a (HBR3 support)/VGA/USB 3.2 Gen 2 (10 Gbps) Type-C with DisplayPort port)</li> </ul>	<ul style="list-style-type: none"> <li>● <b>DisplayPort 1.4a (HBR2 support) port:</b> 4096 x 2304 @ 60 Hz</li> <li>● <b>One optional port -</b> <ul style="list-style-type: none"> <li>○ <b>HDMI 2.1 port:</b> Up to 4096 x 2160 @ 60 Hz</li> <li>○ <b>DisplayPort 1.4a (HBR3 support) port:</b> Up to 5120 x 3200 @ 60 Hz</li> <li>○ <b>VGA port:</b> Up to 1920 x 1200 @ 60 Hz</li> <li>○ <b>USB 3.2 Gen 2 (10 Gbps) Type-C with DisplayPort port:</b> Up to 5120 x 3200 @ 60 Hz</li> </ul> </li> </ul>

## External display support (GPU—Integrated)

**Table 19. External display support (GPU—Integrated)**

Graphics card	Supported external displays
Intel UHD Graphics 730/770	<ul style="list-style-type: none"> <li>● Without MST - 3</li> <li>● With MST - 4</li> </ul>
Intel UHD Graphics 730/770 + optional module	4

**NOTE:** DisplayPort Multi-Stream Transport (MST) allows you to daisy chain monitors that have DisplayPort 1.2 and above ports and MST support. For more information about using DisplayPort Multi-Stream Transport, see [Dell Support Site](#).

## GPU—Discrete

The following table lists the specifications of the discrete Graphics Processing Unit (GPU) supported by your OptiPlex Tower Plus 7020.

**Table 20. GPU—Discrete**

Controller	Memory size	Memory type
NVIDIA GeForce RTX 4060	8 GB	GDDR6
AMD Radeon RX 6300	2 GB	GDDR6
AMD Radeon RX 6500	4 GB	GDDR6

## Video port resolution (GPU—Discrete)

The following table lists the video port resolution for your OptiPlex Tower Plus 7020.

**Table 21. Video port resolution (GPU—Discrete)**

Graphics card	Video ports	Maximum supported resolution
NVIDIA GeForce RTX 4060	<ul style="list-style-type: none"> <li>Three DisplayPort 1.4a (HBR2 support) ports (Display Port 1.2 Certified. DisplayPort 1.3/1.4 ready.)</li> <li>One HDMI 2.1a port</li> </ul>	<ul style="list-style-type: none"> <li><b>DisplayPort 1.4a port:</b> 7680 x 4320 @ 60 Hz (requires two DisplayPort 1.4a links and DSC compression)</li> <li><b>HDMI 2.1a port:</b> 7680 x 4320 YUV420 or DSC @ 60 Hz</li> </ul>
AMD Radeon RX 6300	Two DisplayPort 1.4a (HBR2 support) ports	For one-port configuration - <ul style="list-style-type: none"> <li>With DSC enabled - 8K @ 60 Hz.</li> <li>Without DSC enabled - 5120 x 2880 @ 60 Hz</li> </ul>
AMD Radeon RX 6500	Two DisplayPort 1.4a (HBR2 support) ports	For one-port configuration - <ul style="list-style-type: none"> <li>With DSC enabled - 8K @ 60 Hz</li> <li>Without DSC enabled - 5120 x 2880 @ 60 Hz</li> </ul>

## External display support (GPU—Discrete)

**Table 22. External display support (GPU—Discrete)**

Graphics Card	Video ports	Number of supported external displays	DisplayPort Multi-Stream Transport (MST) support
NVIDIA GeForce RTX 4060	<ul style="list-style-type: none"> <li>Three DisplayPort 1.4a (HBR2 support) ports (Display Port 1.2 Certified. DisplayPort 1.3/1.4 ready.)</li> <li>One HDMI 2.1a port</li> </ul>	4	Supported
AMD Radeon RX 6300	Two DisplayPort 1.4a (HBR2 support) ports	2	Supported
AMD Radeon RX 6500	Two DisplayPort 1.4a (HBR2 support) ports	2	Supported

**NOTE:** DisplayPort Multi-Stream Transport (MST) allows you to daisy chain monitors that have DisplayPort 1.2 and above ports and MST support. For more information about using DisplayPort Multi-Stream Transport, see [Dell Support Site](#).

## Hardware security

The following table lists the hardware security of your OptiPlex Tower Plus 7020.

**Table 23. Hardware security**

Hardware security
Chassis intrusion switch
Chassis lock slot support
China TPM

**Table 23. Hardware security (continued)**

<b>Hardware security</b>
Intel Authenticate
Intel Secure Boot
Kensington security-cable slot
Local hard drive data wipe through BIOS (Secure Erase)
Lockable cable covers
Microsoft 10 Device Guard and Credential Guard (Enterprise SKU)
Microsoft Windows Bitlocker
Padlock ring
SafeBIOS: includes Dell Off-host BIOS Verification, BIOS Resilience, BIOS Recovery, and additional BIOS Controls
SafelD including Trusted Platform Module (TPM) 2.0
Self-encrypting storage drives (Opal, FIPS)
Smart card keyboard (FIPS)
Supply chain tamper alerts
Trusted Platform Module TPM 2.0

## Environmental

The following table lists the environmental specifications of your OptiPlex Tower Plus 7020.

**Table 24. Environmental**

Feature	Values
Recyclable packaging	Yes
Vertical orientation packaging support	No
Multi-Pack packaging	Yes (optional)

**i** **NOTE:** Wood-based fiber packaging contains a minimum of 35% recycled content by total weight of wood-based fiber. Packaging that contains without wood-based fiber can be claimed as Not Applicable. The anticipated required criteria for EPEAT 2018.

## Regulatory compliance

The following table lists the regulatory compliance of your OptiPlex Tower Plus 7020.

**Table 25. Regulatory compliance**

<b>Regulatory compliance</b>
<a href="#">Product Safety, EMC and Environmental Datasheets</a>
<a href="#">Dell Regulatory Compliance Home Page</a>
<a href="#">Responsible Business Alliance policy</a>

# Operating and storage environment

This table lists the operating and storage specifications of your OptiPlex Tower Plus 7020.

**Airborne contaminant level:** G1 as defined by ISA-S71.04-1985

**Table 26. Computer environment**

Description	Operating	Storage
Temperature range	10°C to 35°C (50°F to 95°F)	-40°C to 70°C (-40°F to 158°F)
Relative humidity (maximum)	20% to 80% (non-condensing)	0% to 95% (non-condensing)
Vibration (maximum)*	0.26 GRMS	1.37 GRMS
Shock (maximum)	40 G†	105 G†
Altitude range	-15.2 m to 3048 m (-49.87 ft to 10000 ft)	-15.2 m to 10668 m (-49.87 ft to 35000 ft)
 <b>CAUTION: Operating and storage temperature ranges may differ among components, so operating or storing the device outside these ranges may impact the performance of specific components.</b>		











\* Measured using a random vibration spectrum that simulates the user environment.

† Measured using a 2 ms half-sine pulse.

# Working inside your computer

## Safety instructions

Use the following safety guidelines to protect your computer from potential damage and to ensure your personal safety. Unless otherwise noted, each procedure in this document assumes that you have read the safety information that shipped with your computer.



-  **WARNING:** Before working inside your computer, read the safety information that is shipped with your computer. For more safety best practices, see [Dell Regulatory Compliance Home Page](#).
-  **WARNING:** Disconnect your computer from all power sources before opening the computer cover or panels. After you finish working inside the computer, replace all covers, panels, and screws before connecting your computer to an electrical outlet.
-  **CAUTION:** To avoid damaging the computer, ensure that the work surface is flat, dry, and clean.
-  **CAUTION:** To avoid damaging the components and cards, handle them by their edges, and avoid touching the pins and the contacts.
-  **CAUTION:** You should only perform troubleshooting and repairs as authorized or directed by the Dell technical assistance team. Damage due to servicing that is not authorized by Dell is not covered by your warranty. See the safety instructions that is shipped with the product or at [Dell Regulatory Compliance Home Page](#).
-  **CAUTION:** Before touching anything inside your computer, ground yourself by touching an unpainted metal surface, such as the metal at the back of the computer. While you work, periodically touch an unpainted metal surface to dissipate static electricity which could harm internal components.
-  **CAUTION:** When you disconnect a cable, pull it by its connector or its pull tab, not the cable itself. Some cables have connectors with locking tabs or thumbscrews that you must disengage before disconnecting the cable. When disconnecting cables, keep them evenly aligned to avoid bending the connector pins. When connecting cables, ensure that the ports and the connectors are correctly oriented and aligned.
-  **CAUTION:** Press and eject any installed card from the media-card reader.
-  **CAUTION:** Exercise caution when handling rechargeable Li-ion batteries in laptops. Swollen batteries should not be used and should be replaced and disposed properly.
-  **NOTE:** The color of your computer and certain components may differ from what is shown in this document.

## Before working inside your computer

### About this task

-  **NOTE:** The images in this document may differ from your computer depending on the configuration you ordered.

### Steps

1. Save and close all open files and exit all open applications.
2. Shut down your computer. For Windows operating system, click **Start** >  **Power** > **Shut down**.
  -  **NOTE:** If you are using a different operating system, see the documentation of your operating system for shut-down instructions.

3. Disconnect your computer and all attached devices from their electrical outlets.
4. Disconnect all attached network devices and peripherals, such as keyboard, mouse, and monitor from your computer.

 **CAUTION: To disconnect a network cable, first unplug the cable from your computer and then unplug the cable from the network device.**

5. Remove any media card and optical disc from your computer, if applicable.

## Safety precautions

The safety precautions chapter details the primary steps to be taken before performing any disassembly instructions.

Observe the following safety precautions before you perform any installation or break-fix procedures involving disassembly or reassembly:

- Turn off the computer and all attached peripherals.
- Disconnect the computer and all attached peripherals from AC power.
- Disconnect all network cables, telephone, and telecommunications lines from the computer.
- Use an ESD field service kit when working inside any desktop to avoid electrostatic discharge (ESD) damage.
- After removing any computer component, carefully place the removed component on an anti-static mat.
- Wear shoes with non-conductive rubber soles to reduce the chance of getting electrocuted.
- Unplugging, pressing, and holding the power button for 15 seconds should discharge residual power in the system board.

## Standby power

Dell products with standby power must be unplugged before you open the case. Systems that incorporate standby power are powered while turned off. The internal power enables the computer to be remotely turned on (Wake-on-LAN) and suspended into a sleep mode and has other advanced power management features.

## Bonding

Bonding is a method for connecting two or more grounding conductors to the same electrical potential. This is done by using a field service electrostatic discharge (ESD) kit. When connecting a bonding wire, ensure that it is connected to bare metal and never to a painted or nonmetal surface. The wrist strap should be secure and in full contact with your skin, and ensure that you remove all jewelry such as watches, bracelets, or rings prior to bonding yourself and the equipment.

## Electrostatic discharge—ESD protection

ESD is a major concern when you handle electronic components, especially sensitive components such as expansion cards, processors, memory modules, and system boards. Slight charges can damage circuits in ways that may not be obvious, such as intermittent problems or a shortened product life span. As the industry pushes for lower power requirements and increased density, ESD protection is an increasing concern.

Due to the increased density of semiconductors used in recent Dell products, the sensitivity to static damage is now higher than in previous Dell products. For this reason, some previously approved methods of handling parts are no longer applicable.

Two recognized types of ESD damage are catastrophic and intermittent failures.

- **Catastrophic** – Catastrophic failures represent approximately 20 percent of ESD-related failures. The damage causes an immediate and complete loss of device functionality. An example of catastrophic failure is a memory DIMM that has received a static shock and immediately generates a "No POST/No Video" symptom with a beep code that is emitted for missing or nonfunctional memory.
- **Intermittent** – Intermittent failures represent approximately 80 percent of ESD-related failures. The high rate of intermittent failures means that most of the time when damage occurs, it is not immediately recognizable. The DIMM receives a static shock, but the tracing is merely weakened and does not immediately produce outward symptoms that are related to the damage. The weakened trace may take weeks or months to melt, and in the meantime may cause degradation of memory integrity, intermittent memory errors, and so on.

The more difficult type of damage to recognize and troubleshoot is the intermittent (also called latent or "walking wounded") failure.

Perform the following steps to prevent ESD damage:

- Use a wired ESD wrist strap that is properly grounded. Wireless anti-static straps do not provide adequate protection. Touching the chassis before handling parts does not ensure adequate ESD protection on parts with increased sensitivity to ESD damage.
- Handle all static-sensitive components in a static-safe area. If possible, use anti-static floor pads and workbench pads.
- When unpacking a static-sensitive component from its shipping carton, do not remove the component from the anti-static packing material until you are ready to install the component. Before unwrapping the anti-static packaging, ensure that you discharge static electricity from your body.
- Before transporting a static-sensitive component, place it in an anti-static container or packaging.

## ESD Field Service kit

The unmonitored Field Service kit is the most commonly used service kit. Each Field Service kit includes three main components: anti-static mat, wrist strap, and bonding wire.

### Components of an ESD field service kit

The components of an ESD field service kit are:

- **Anti-Static Mat** – The anti-static mat is dissipative and parts can be placed on it during service procedures. When using an anti-static mat, your wrist strap should be snug and the bonding wire should be connected to the mat and to any bare metal on the computer being worked on. Once deployed properly, service parts can be removed from the ESD bag and placed directly on the mat. ESD-sensitive items are safe in your hand, on the ESD mat, in the computer, or inside an ESD bag.
- **Wrist Strap and Bonding Wire** – The wrist strap and bonding wire can be either directly connected between your wrist and bare metal on the hardware if the ESD mat is not required, or connected to the anti-static mat to protect hardware that is temporarily placed on the mat. The physical connection of the wrist strap and bonding wire between your skin, the ESD mat, and the hardware is known as bonding. Use only Field Service kits with a wrist strap, mat, and bonding wire. Never use wireless wrist straps. Always be aware that the internal wires of a wrist strap are prone to damage from normal wear and tear, and must be checked regularly with a wrist strap tester in order to avoid accidental ESD hardware damage. It is recommended to test the wrist strap and bonding wire at least once per week.
- **ESD Wrist Strap Tester** – The wires inside an ESD strap are prone to damage over time. When using an unmonitored kit, it is a best practice to regularly test the strap prior to each service call, and at a minimum, test once per week. A wrist strap tester is the best method for doing this test. If you do not have your own wrist strap tester, check with your regional office to find out if they have one. To perform the test, plug the bonding-wire of wrist-strap into the tester while it is strapped to your wrist and push the button to test. A green LED is lit if the test is successful; a red LED is lit and an alarm sounds if the test fails.
- **Insulator Elements** – It is critical to keep ESD sensitive devices, such as plastic heat sink casings, away from internal parts that are insulators and often highly charged.
- **Working Environment** – Before deploying the ESD Field Service kit, assess the situation at the customer location. For example, deploying the kit for a server environment is different than for a desktop or laptop environment. Servers are typically installed in a rack within a data center; desktops or laptops are typically placed on office desks or cubicles. Always look for a large open flat work area that is free of clutter and large enough to deploy the ESD kit with additional space to accommodate the type of computer that is being repaired. The workspace should also be free of insulators that can cause an ESD event. On the work area, insulators such as Styrofoam and other plastics should always be moved at least 12 inches or 30 centimeters away from sensitive parts before physically handling any hardware components.
- **ESD Packaging** – All ESD-sensitive devices must be shipped and received in static-safe packaging. Metal, static-shielded bags are preferred. However, you should always return the damaged part using the same ESD bag and packaging that the new part arrived in. The ESD bag should be folded over and taped shut and all the same foam packing material should be used in the original box that the new part arrived in. ESD-sensitive devices should be removed from packaging only at an ESD-protected work surface, and parts should never be placed on top of the ESD bag because only the inside of the bag is shielded. Always place parts in your hand, on the ESD mat, in the computer, or inside an anti-static bag.
- **Transporting Sensitive Components** – When transporting ESD sensitive components such as replacement parts or parts to be returned to Dell, it is critical to place these parts in anti-static bags for safe transport.

### ESD protection summary

It is recommended to always use the traditional wired ESD grounding wrist strap and protective anti-static mat when servicing Dell products. In addition, it is critical to keep sensitive parts separate from all insulator parts while performing service and use anti-static bags for transporting sensitive components.



## Transporting sensitive components

When transporting ESD sensitive components such as replacement parts or parts to be returned to Dell, it is critical to place these parts in anti-static bags for safe transport.

## Lifting equipment

Adhere to the following guidelines when lifting heavy equipment:

 **CAUTION: Do not lift greater than 50 pounds. Always obtain additional resources or use a mechanical lifting device.**

1. Get a firm balanced footing. Keep your feet apart for a stable base, and point your toes out.
2. Tighten stomach muscles. Abdominal muscles support your spine when you lift, offsetting the force of the load.
3. Lift with your legs, not your back.
4. Keep the load close. The closer it is to your spine, the less force it exerts on your back.
5. Keep your back upright, whether lifting or setting down the load. Do not add the weight of your body to the load. Avoid twisting your body and back.
6. Follow the same technique in reverse to set the load down.

## After working inside your computer

### About this task

 **CAUTION: Leaving stray or loose screws inside your computer may severely damage your computer.**

### Steps

1. Replace all screws and ensure that no stray screws remain inside your computer.
2. Connect any external devices, peripherals, or cables you removed before working on your computer.
3. Replace any media cards, discs, or any other parts that you removed before working on your computer.
4. Connect your computer and all attached devices to their electrical outlets.
5. Turn on your computer.

## BitLocker

 **CAUTION: If BitLocker is not suspended before updating the BIOS, the next time you reboot the system it will not recognize the BitLocker key. You will then be prompted to enter the recovery key to progress, and the system will ask for the recovery key on each reboot. If the recovery key is not known, this can result in data loss or an unnecessary operating system reinstall. For more information about this subject, see Knowledge Article: [updating the BIOS on Dell systems with BitLocker enabled](#).**

The installation of the following components triggers BitLocker:

- Hard disk drive or solid-state drive
- System board

## Recommended tools

The procedures in this document may require the following tools:

- Phillips screwdriver #0
- Phillips screwdriver #1
- Plastic scribe



# Screw list

- NOTE:** When removing screws from a component, it is recommended to note the screw type, and the quantity of screws, and then place them in a screw storage box. This is to ensure that the correct number of screws and correct screw type is restored when the component is replaced.
- NOTE:** Some computers have magnetic surfaces. Ensure that the screws are not left attached to such surfaces when replacing a component.
- NOTE:** Screw color may vary with the configuration ordered.

**Table 27. Screw list**

Component	Screw type	Quantity	Screw image
M.2 2230/2280 solid-state drive	M2x3.5	1	
Wireless card	M2x3.5	1	
Secondary 3.5-inch hard drive	#6-32	5	
Media-card reader door	M3x3	1	
Media-card reader (optional)	M2x3.5	1	
Disk-drive cage	M3	1	
Internal antenna module	M3x3	2	
Processor fan and heat-sink assembly	Captive screw	4	
Power-supply unit	#6-32	3	
Voltage-regulator heat sink	Captive screw	4	
Serial/VGA module (optional)	M3	2	
DisplayPort/HDMI/USB Type-C module (optional)	M3x3	2	
System board	#6-32	1	

**Table 27. Screw list (continued)**

Component	Screw type	Quantity	Screw image
	M2	2	
	#6-32	7	

## Major components of OptiPlex Tower Plus 7020

The following image shows the major components of OptiPlex Tower Plus 7020.

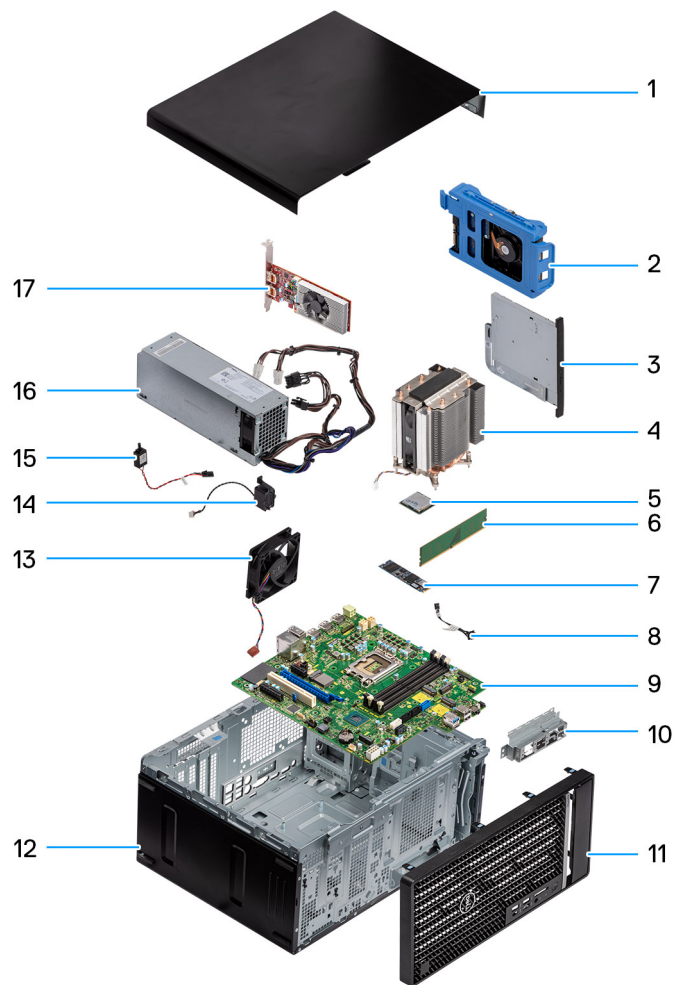

**Figure 8. Major Components of OptiPlex Tower Plus 7020**

1. Side cover
2. 3.5-inch hard drive
3. Slim optical drive
4. Processor fan and heat-sink assembly
5. Processor
6. Memory module

7. M.2 2280 solid-state drive
8. Power button cable
9. System board
10. Front I/O bracket
11. Front bezel
12. Computer chassis
13. System fan
14. Internal speaker
15. Intrusion switch
16. Power-supply unit
17. Graphics card

 **NOTE:** Dell Technologies provides a list of components and their part numbers for the original system configuration purchased. These parts are available according to warranty coverages purchased by the customer. Contact your Dell sales representative for purchase options.

# Removing and installing side cover

## Removing the side cover

### Prerequisites

1. Follow the procedure in [Before working inside your computer](#).

**NOTE:** Ensure that you remove the security cable from the security-cable slot, if applicable.

### About this task

The following images indicate the location of the side cover and provide a visual representation of the removal procedure.



Figure 9. Removing the side cover

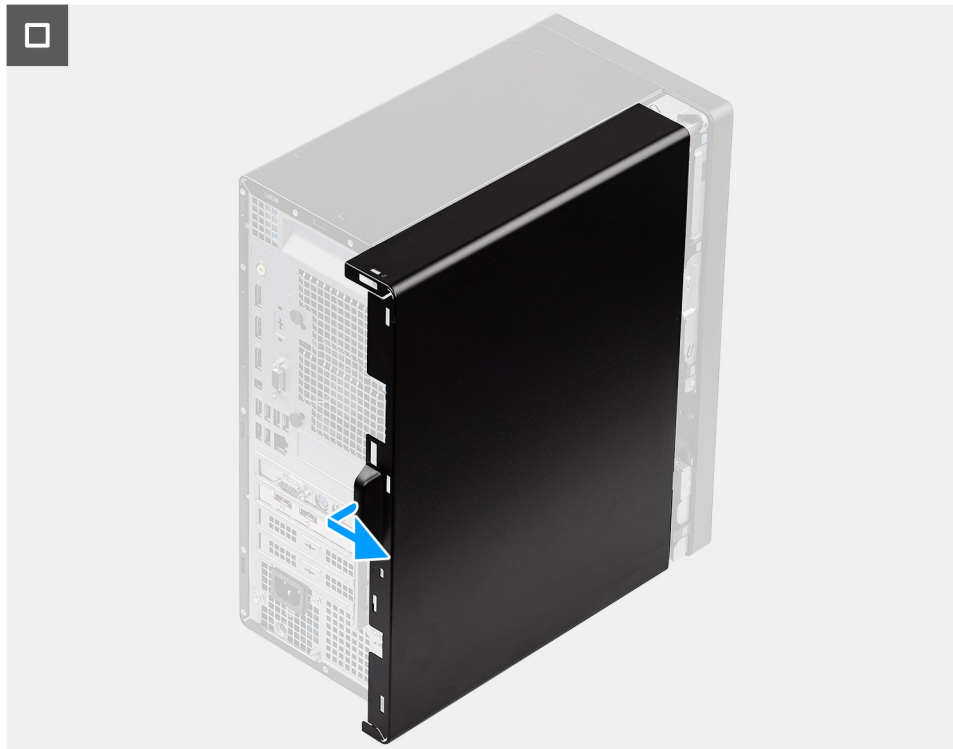

**Figure 10. Removing the side cover**

#### **Steps**

1. Slide the release latch downwards to release the side cover from the chassis.
2. Slide the side cover outwards, towards the rear of the computer, and lift the side cover away from the chassis.
3. Place the computer on its side with the side-cover opening facing up.

**NOTE:** This step applies only if you are replacing any component other than the front bezel.

## **Installing the side cover**

#### **Prerequisites**

If you are replacing a component, remove the existing component before performing the installation procedure.

#### **About this task**

The following image indicates the location of the side cover and provides a visual representation of the installation procedure.



**Figure 11. Installing the side cover**

#### **Steps**

1. Place the computer in the upright position.

**i** **NOTE:** This step applies only if you have installed any component other than the front bezel.

2. Align the tabs on the side cover with the slots on the chassis.
3. Slide the side cover towards the front of the chassis until the release latch clicks in place.

#### **Next steps**

1. Follow the procedure in [After working inside your computer.](#)

# Removing and installing coin-cell battery

## Removing the coin-cell battery

**⚠ WARNING:** This computer contains a coin-cell battery and requires trained technicians for handling guidance.

**⚠ CAUTION:** Removing the coin-cell battery will clear the CMOS and will reset BIOS settings.

### Prerequisites

1. Follow the procedure in [Before working inside your computer](#).
2. Remove the [side cover](#).

### About this task

The following images indicate the location of the coin-cell battery and provide a visual representation of the removal procedure.



Figure 12. Removing the coin-cell battery

### Steps

1. Push the release lever on the coin-cell battery socket (RTC) to release the coin-cell battery from socket.
2. Lift the coin-cell battery from the coin-cell battery socket.

## Installing the coin-cell battery

**⚠ WARNING:** This computer contains a coin-cell battery and requires trained technicians for handling guidance.



## Prerequisites

If you are replacing a component, remove the existing component before performing the installation procedure.

## About this task

The following images indicate the location of the coin-cell battery and provide a visual representation of the installation procedure.

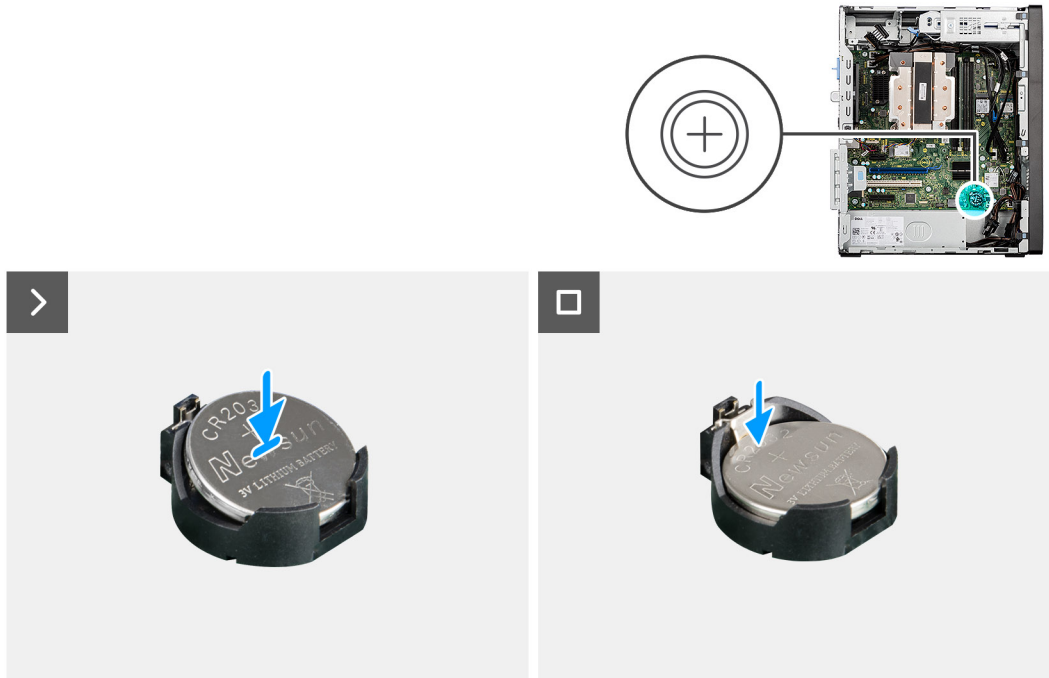

**Figure 13. Installing the coin-cell battery**

## Steps

With the positive side (+) facing up, insert the coin-cell battery into the battery socket (RTC) on the system board and snap the battery in place.

## Next steps

1. Install the [side cover](#).
2. Follow the procedure in [After working inside your computer](#).

# Removing and installing Customer Replaceable Units (CRUs)

The replaceable components in this chapter are Customer Replaceable Units (CRUs).

 **CAUTION:** Customers can replace only the Customer Replaceable Units (CRUs) following the safety precautions and replacement procedures.

 **NOTE:** The images in this document may differ from your computer depending on the configuration you ordered.

## Front bezel

### Removing the front bezel

#### Prerequisites

1. Follow the procedure in [Before working inside your computer](#).
2. Remove the [side cover](#).

#### About this task

The following images indicate the location of the front bezel and provide a visual representation of the removal procedure.



Figure 14. Removing the front bezel

### Steps

1. Using a plastic scribe, gently pry the tabs sequentially from the top and release the tabs on the front bezel.
2. Rotate the front bezel outward from the chassis and remove the front bezel.

## Installing the front bezel

### Prerequisites

If you are replacing a component, remove the existing component before performing the installation procedure.

### About this task

The following images indicate the location of the front bezel and provide a visual representation of the installation procedure.

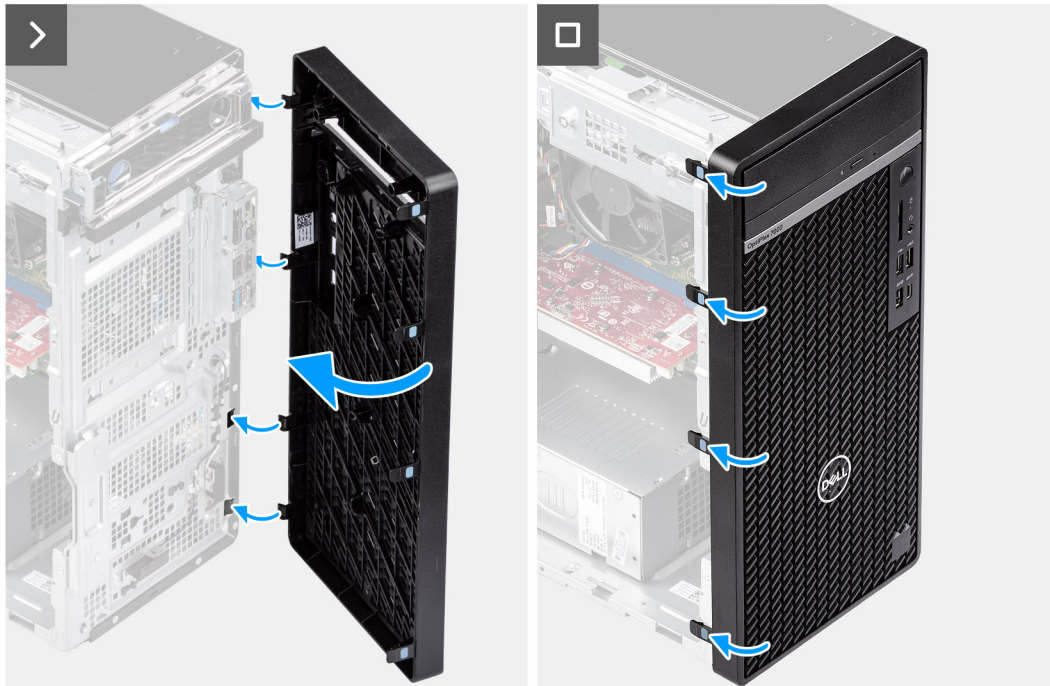
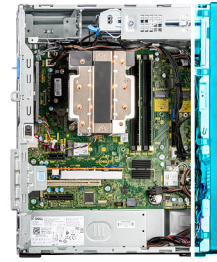

Figure 15. Installing the front bezel

#### Steps

1. Align the tabs on the front bezel with the slots on the chassis.
2. Rotate the front bezel towards the chassis and snap it in place.

#### Next steps

1. Install the [side cover](#).
2. Follow the procedure in [After working inside your computer](#).

## Memory module

### Removing the memory module

#### Prerequisites

1. Follow the procedure in [Before working inside your computer](#).
2. Remove the [side cover](#).

#### About this task

The following image indicates the location of the memory and provides a visual representation of the removal procedure.

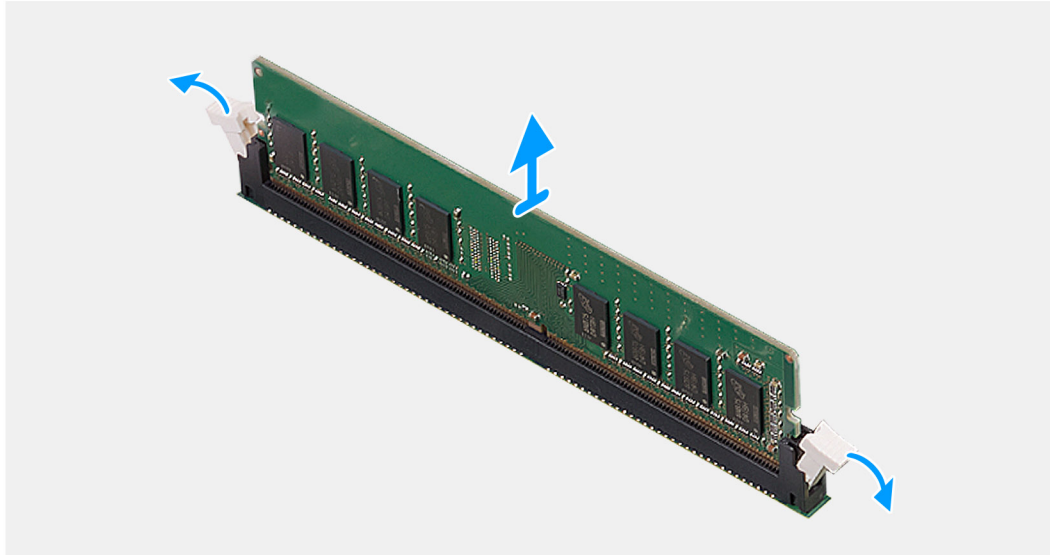
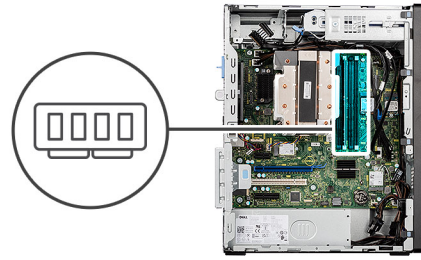

**Figure 16. Removing the memory module**

### Steps

1. Using your fingertips, carefully spread apart the securing-clips on each end of the memory-module slot (DIMM1, DIMM2, DIMM3 or DIMM4, whichever is applicable) .
2. Hold the memory module near the securing clips, and then gently ease the memory module out of the memory-module slot.

**CAUTION:** To prevent damage to the memory module, hold the memory module by the edges. Do not touch the components or metallic contacts on the memory module as electrostatic discharge (ESD) can inflict severe damage on the components. To read more about ESD protection, see [ESD protection](#).

**NOTE:** If the memory module is difficult to remove, gently ease the memory module back and forth to remove it from the slot.

**NOTE:** Note the slot and the orientation of the memory module in order to replace it in the correct slot.

3. Repeat steps 1 and 2 to remove the other memory modules installed in your computer, if applicable.

## Installing the memory module

### Prerequisites

If you are replacing a component, remove the existing component before performing the installation procedure.

### About this task

The following image indicates the location of the memory and provides a visual representation of the installation procedure.

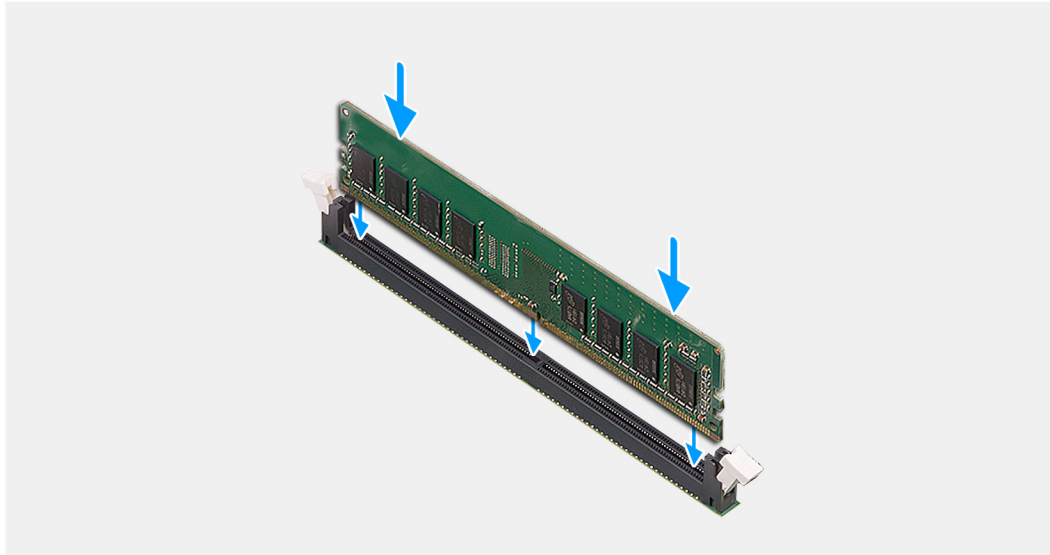
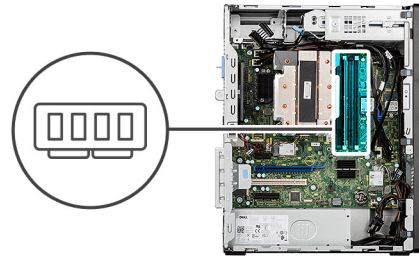

**Figure 17. Installing the memory module**

### Steps

1. Ensure that the memory-module securing clips are in an open position.
2. Align the notch on the memory module with the tab on the memory-module slot (DIMM1, DIMM2, DIMM3 or DIMM4, whichever is applicable) .
3. Press down on the memory module until the memory module snaps in position and the securing clips lock in place.

**CAUTION:** To prevent damage to the memory module, hold the memory module by the edges. Do not touch the components or metallic contacts on the memory module as electrostatic discharge (ESD) can inflict severe damage on the components. To read more about ESD protection, see [ESD protection](#).

**NOTE:** If you do not hear the click, remove the memory module and reinstall it.

4. Repeat steps 1 to 3 to install the other memory modules in your computer, if applicable.

### Next steps

1. Install the [side cover](#).
2. Follow the procedure in [After working inside your computer](#).

# M.2 solid state drive

## M.2 2230 solid-state drive

### Removing the M.2 2230 solid-state drive

#### Prerequisites

1. Follow the procedure in [Before working inside your computer](#).
2. Remove the [side cover](#).

#### About this task

The following images indicate the location of the M.2 2230 solid-state drive and provide a visual representation of the removal procedure.

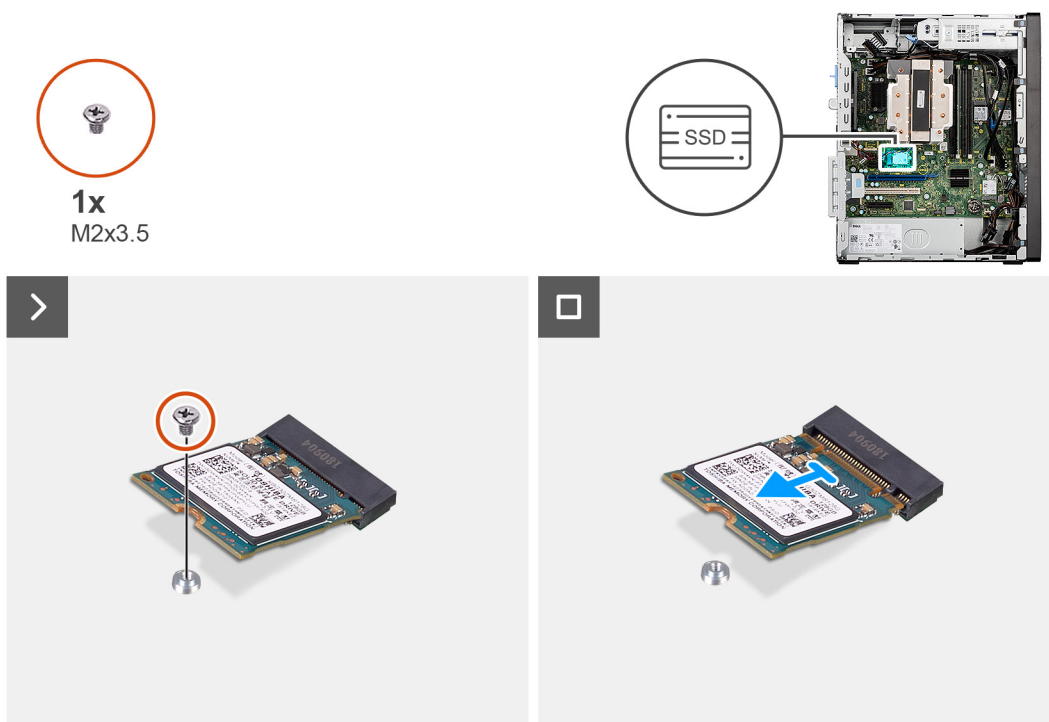

Figure 18. Removing the M.2 2230 solid-state drive

#### Steps

1. Remove the screw (M2x3.5) that secures the M.2 2230 solid-state drive to the M.2 card slot (M.2 PCIe SSD-0, M.2 PCIe SSD-1 or M.2 PCIe SSD-2, whichever is applicable) on the system board.
2. Slide and remove the M.2 2230 solid-state drive from the M.2 card slot on the system board.

### Installing the M.2 2230 solid-state drive

#### Prerequisites

If you are replacing a component, remove the existing component before performing the installation procedure.

#### About this task

The following images indicate the location of the M.2 2230 solid-state drive and provide a visual representation of the installation procedure.



1x  
M2

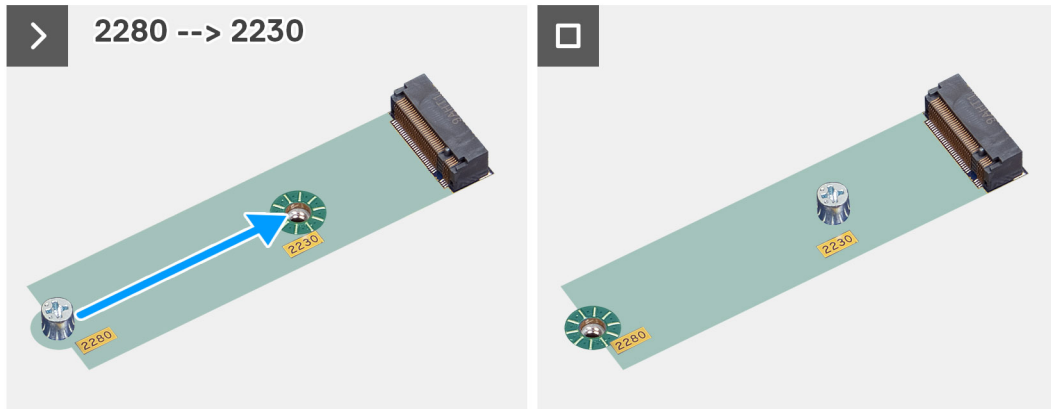

Figure 19. Installing the M.2 2230 solid-state drive



1x  
M2x3.5

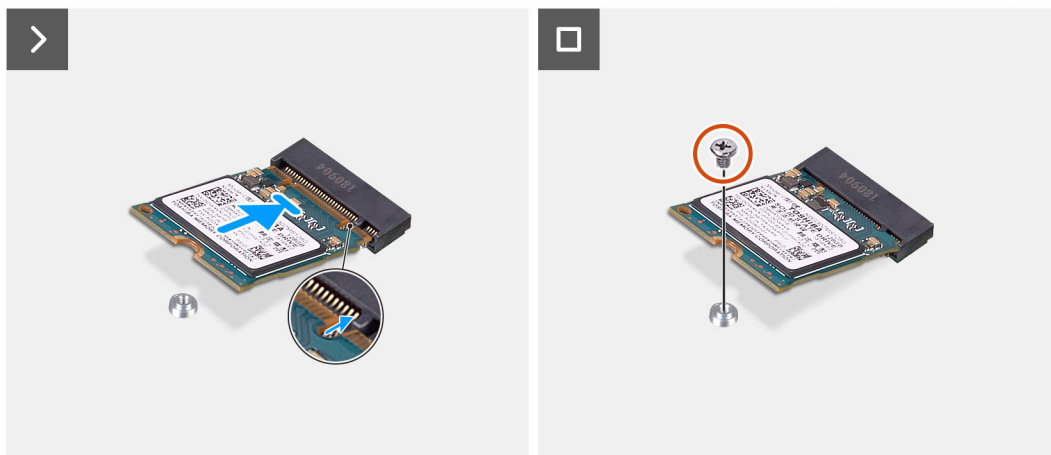
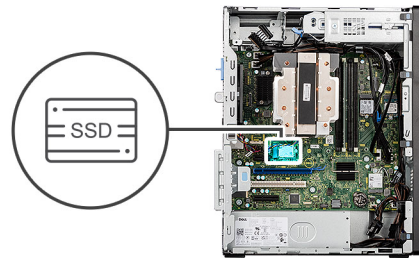

Figure 20. Installing the M.2 2230 solid-state drive

### Steps

1. Remove the standoff nut (M2) from the M.2 slot (2280) and place it on the M.2 slot (2230), at half length, on the system board.  
**i** **NOTE:** This step applies only if you are replacing a M.2 2280 solid-state drive with a M.2 2230 solid-state drive.
2. Align the notch on the M.2 2230 solid-state drive with the tab on the M.2 card slot (M.2 PCIe SSD-0, M.2 PCIe SSD-1 or M.2 PCIe SSD-2, whichever is applicable) on the system board.



3. At an angle, slide and place the M.2 2230 solid-state drive in the M.2 card slot on the system board.
4. Replace the screw (M2x3.5) to secure the M.2 2230 solid-state drive to the system board.

**Next steps**

1. Install the [side cover](#).
2. Follow the procedure in [After working inside your computer](#).

## M.2 2280 solid-state drive

### Removing the M.2 2280 solid-state drive

**Prerequisites**

1. Follow the procedure in [Before working inside your computer](#).
2. Remove the [side cover](#).

**About this task**

The following images indicate the location of the M.2 2280 solid-state drive and provide a visual representation of the removal procedure.

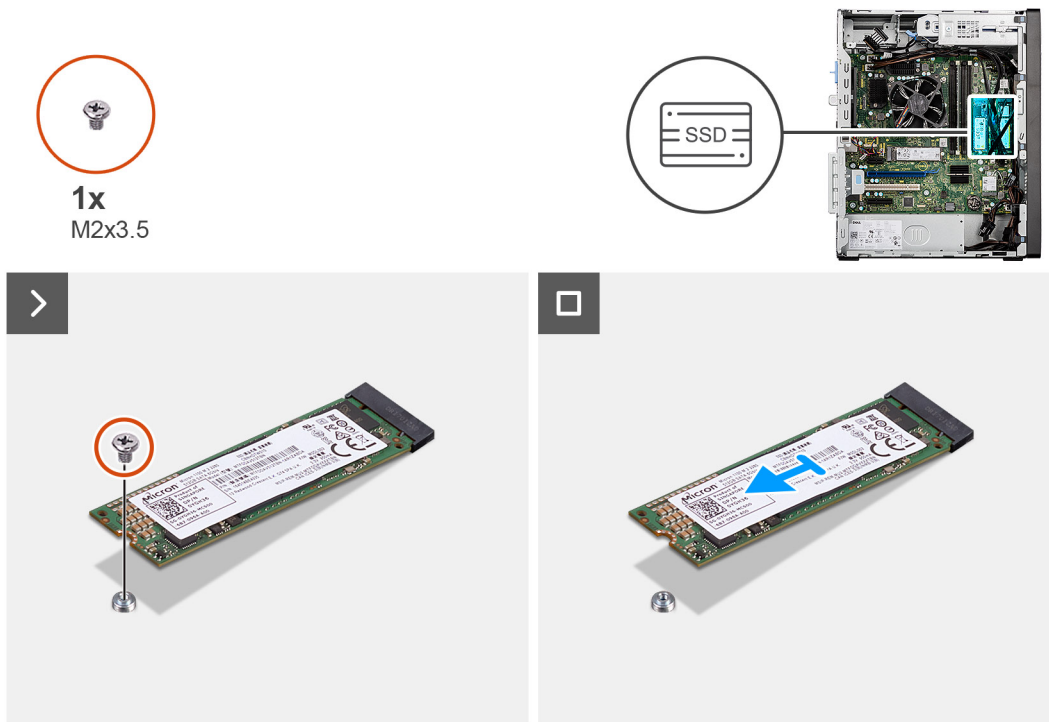

**Figure 21. Removing the M.2 2280 solid-state drive**

**Steps**

1. Remove the screw (M2x3.5) that secures the M.2 2280 solid-state drive to the M.2 card slot (M.2 PCIe SSD-0, M.2 PCIe SSD-1 or M.2 PCIe SSD-2, whichever is applicable) on the system board.
2. Slide and remove the M.2 2280 solid-state drive from the M.2 card slot on the system board.

### Installing the M.2 2280 solid-state drive

**Prerequisites**

If you are replacing a component, remove the existing component before performing the installation procedure.

**About this task**

The following images indicate the location of the M.2 2280 solid-state drive and provide a visual representation of the installation procedure.

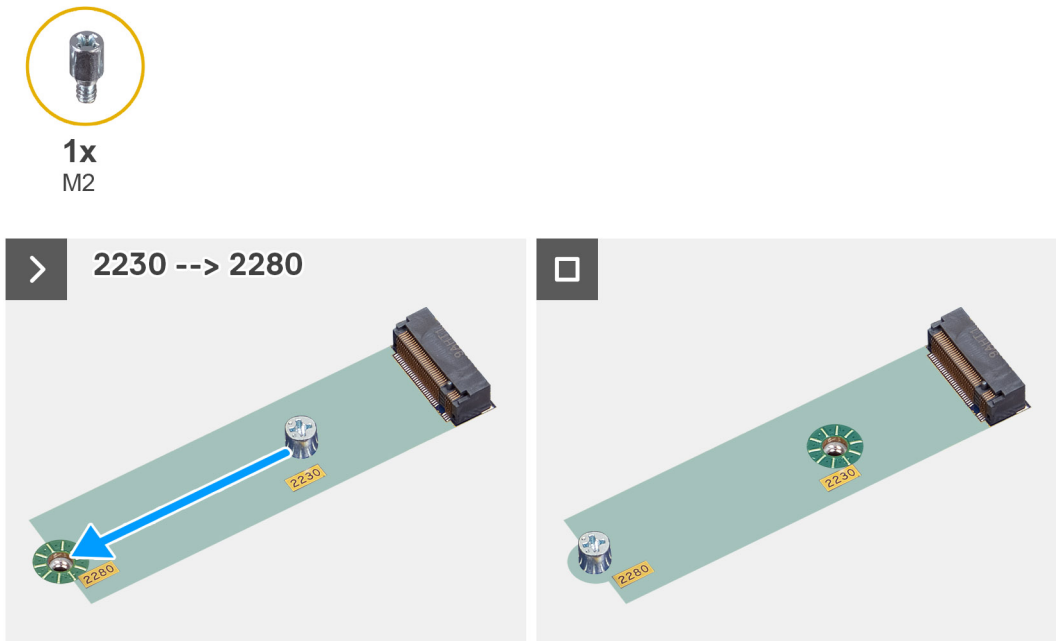

**Figure 22. Installing the M.2 2230 solid-state drive**

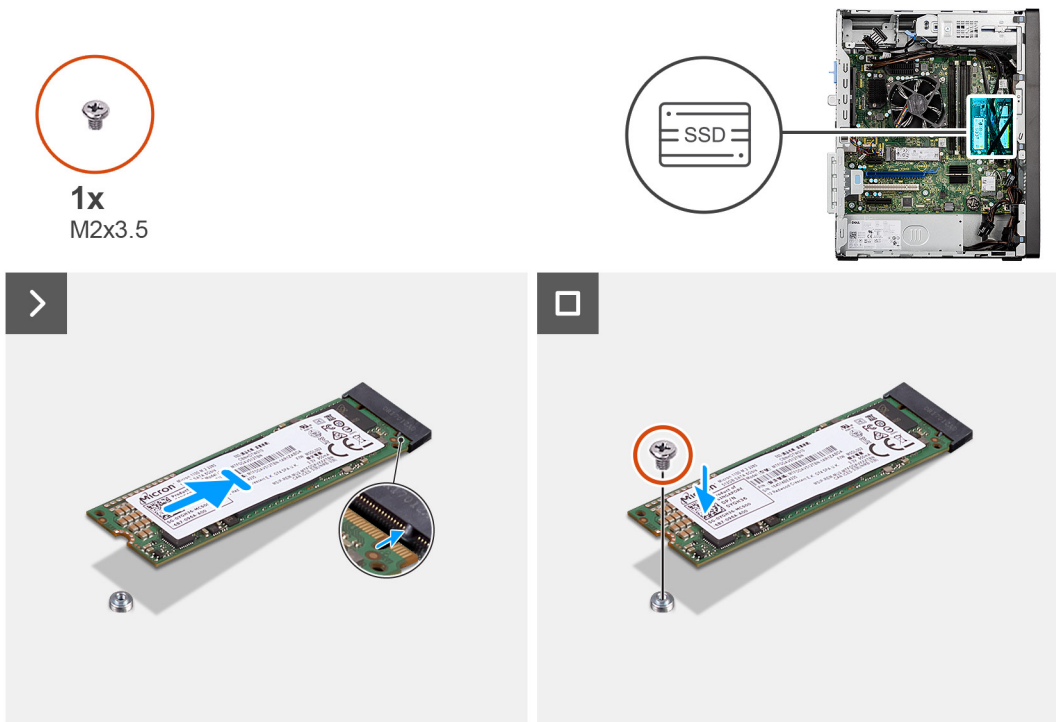

**Figure 23. Installing the M.2 2280 solid-state drive**

**Steps**

1. Remove the standoff nut (M2) from the M.2 slot (2230) and place it on the M.2 slot (2280), at full length, on the system board.

**NOTE:** This step applies only if you are replacing a M.2 2230 solid-state drive with a M.2 2280 solid-state drive.

2. Align the notch on the M.2 2280 solid-state drive with the tab on the M.2 card slot (M.2 PCIe SSD-0, M.2 PCIe SSD-1 or M.2 PCIe SSD-2, whichever is applicable) on the system board.
3. At an angle, slide and place the M.2 2280 solid-state drive in the M.2 card slot on the system board.
4. Replace the screw (M2x3.5) to secure the M.2 2280 solid-state drive to the system board.

#### Next steps

1. Install the [side cover](#).
2. Follow the procedure in [After working inside your computer](#).

## External puck antenna

Computers that are shipped with **Intel Wi-Fi 6E AX211** wireless card come with an external puck antenna installed.

For more information about the installation procedure of external puck antenna for your computer, see *OptiPlex Antenna Installation Guide* on the documentation support page of [OptiPlex Tower Plus 7020](#).

## Wireless card

### Removing the wireless card

#### Prerequisites

1. Follow the procedure in [Before working inside your computer](#).
2. Remove the [side cover](#).

#### About this task

The following images indicate the location of the wireless card and provide a visual representation of the removal procedure.



**Figure 24. Removing the wireless card**

**Steps**

1. Remove the screw (M2x3.5) that secures the wireless-card bracket to the system board.
2. Slide and lift the wireless-card bracket off the wireless card.
3. Disconnect the antenna cables from the connectors on the wireless card.
4. Slide and lift the wireless card off the wireless-card slot (M.2 WLAN) on the system board.

## Installing the wireless card

**Prerequisites**

If you are replacing a component, remove the existing component before performing the installation procedure.

**About this task**

The following images indicate the location of the wireless card and provide a visual representation of the installation procedure.

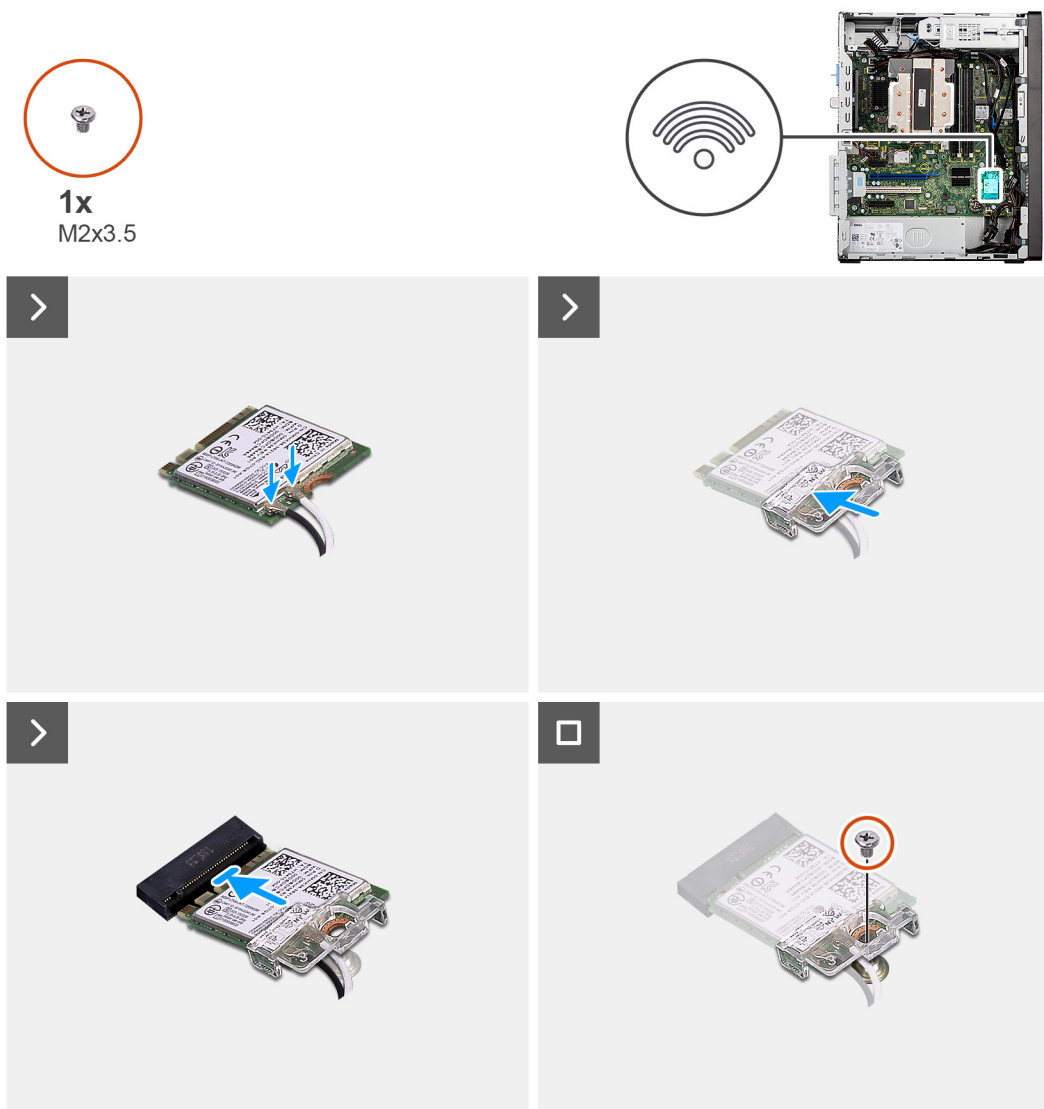

**Figure 25. Installing the wireless card**

### Steps

1. Connect the wireless-antenna cables to the wireless card.

**Table 28. Antenna-cable color scheme**

Connectors on the wireless card	Antenna-cable color	Silkscreen marking	
Main	White	MAIN	△ (white triangle)
Auxiliary	Black	AUX	▲ (black triangle)

2. Align and place the wireless-card bracket over the antenna cables to secure them.
3. Align the notch on the wireless card with the tab on the wireless-card slot (M.2 WLAN) on the system board.
4. Slide the wireless card at an angle into the wireless-card slot on the system board.
5. Replace the screw (M2x3.5) to secure the wireless-card to the system board.

### Next steps

1. Install the [side cover](#).
2. Follow the procedure in [After working inside your computer](#).

# Graphics Card

## Removing the graphics card

### Prerequisites

1. Follow the procedure in [Before working inside your computer](#).
2. Remove the [side cover](#).

### About this task

The following images indicate the location of the graphics card and provide a visual representation of the removal procedure.

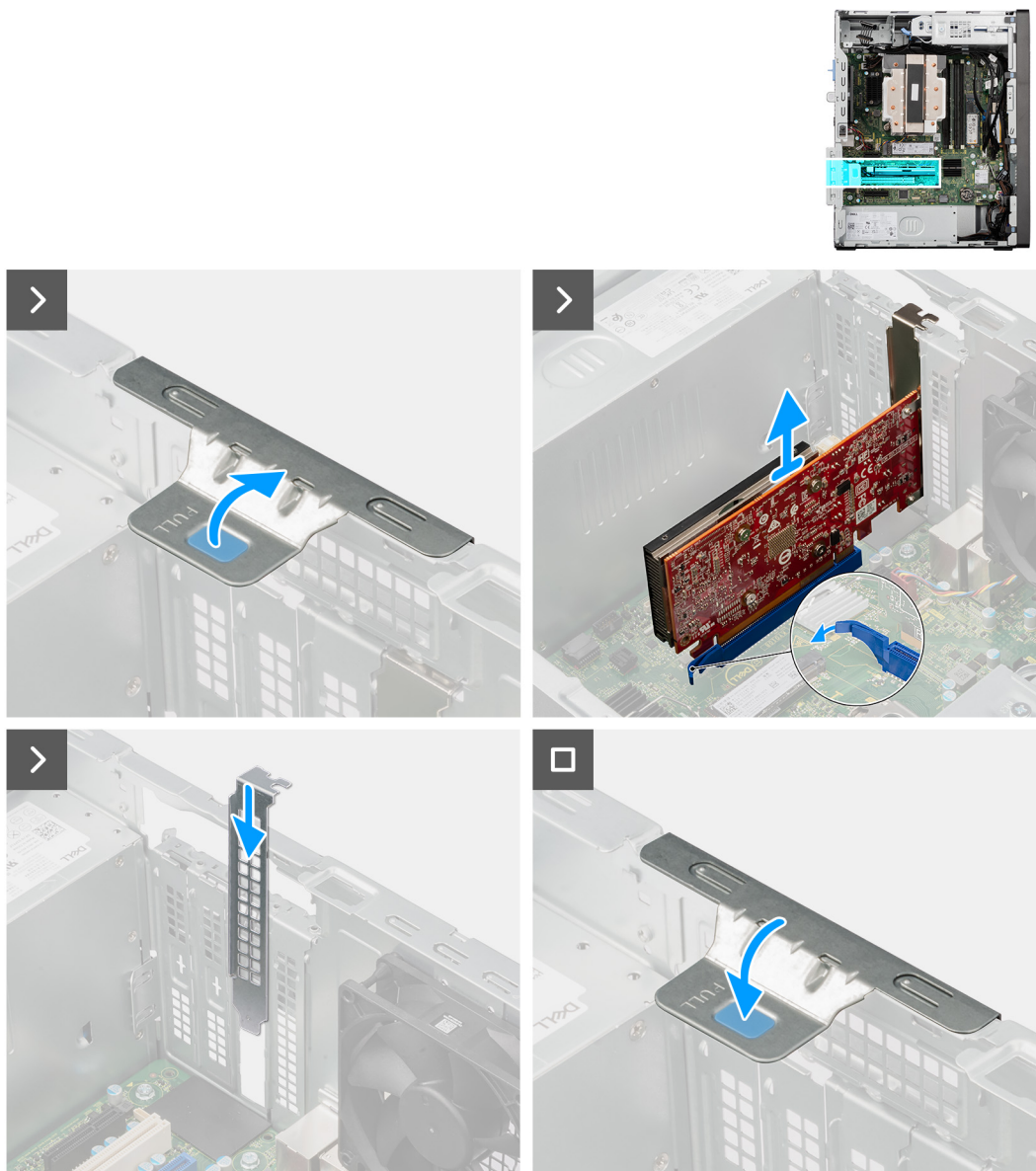

Figure 26. Removing the graphics card

### Steps

1. Lift the pull tab on the PCIe door outwards to open the PCIe door.
2. Push and hold the tab that secures the graphics card to the PCIe card connector (SLOT2) on the system board.
3. Gently lift the graphics card off the PCIe card connector on the system board.

4. Align and slide the PCIe blanking plate in the slot on the chassis.

**NOTE:** Do not perform this step if you are immediately replacing the graphics card with a new PCIe card.

5. Close the PCIe door and press it gently until it clicks in place on the chassis.

**NOTE:** Do not perform this step if you are immediately replacing the graphics card with a new PCIe card.

## Installing the graphics card

### Prerequisites

If you are replacing a component, remove the existing component before performing the installation procedure.

### About this task

The following images indicate the location of the graphics card and provide a visual representation of the installation procedure.

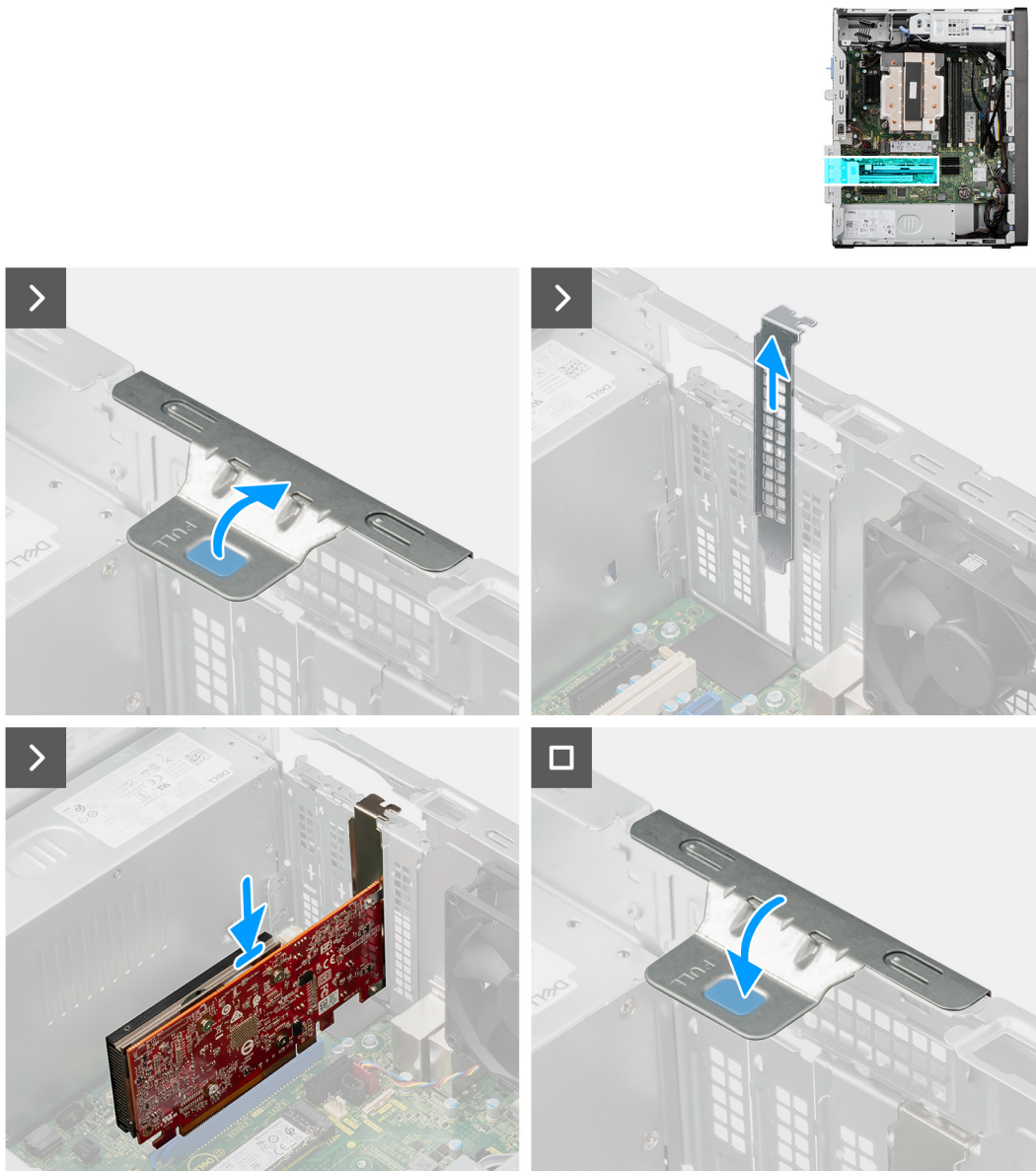

Figure 27. Installing the graphics card

### Steps

1. Lift the pull tab on the PCIe door outwards to open the PCIe door.
2. Remove the PCIe blanking plate from the slot on the chassis.  
**i** **NOTE:** Ensure to keep the PCIe blanking plate safe for future use.
3. Align the notch on the graphics card with the tab on the PCIe card connector (SLOT2) on the system board.
4. Gently press down on the graphics card till the tab on the PCIe connector locks in place.
5. Close the PCIe door and press it gently until it clicks in place on the chassis, to secure the graphics card.

### Next steps

1. Install the [side cover](#).
2. Follow the procedure in [After working inside your computer](#).

## Removing the powered graphics card

### Prerequisites

1. Follow the procedure in [Before working inside your computer](#).
2. Remove the [side cover](#).

### About this task

The following images indicate the location of the powered graphics card and provide a visual representation of the removal procedure.



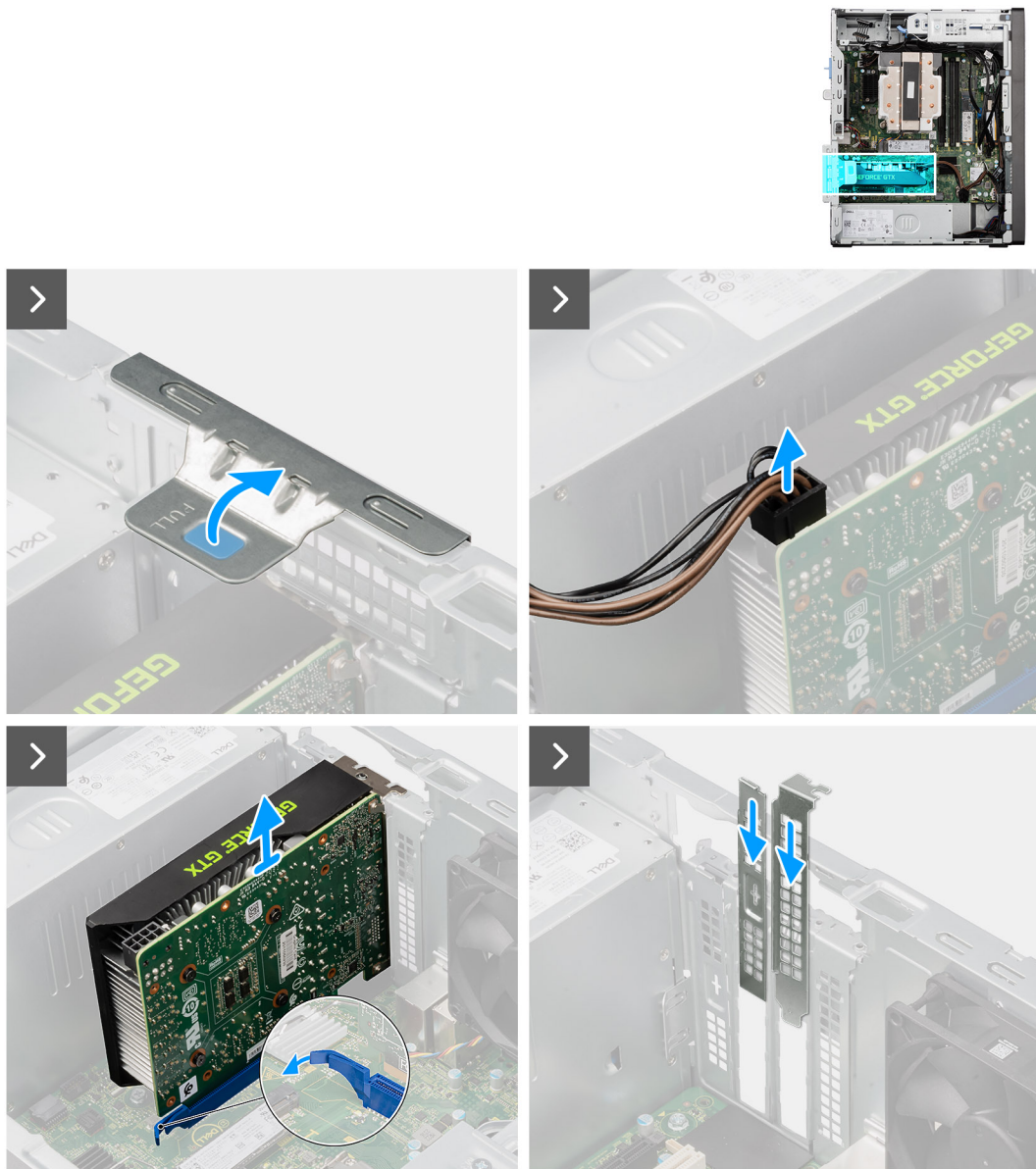
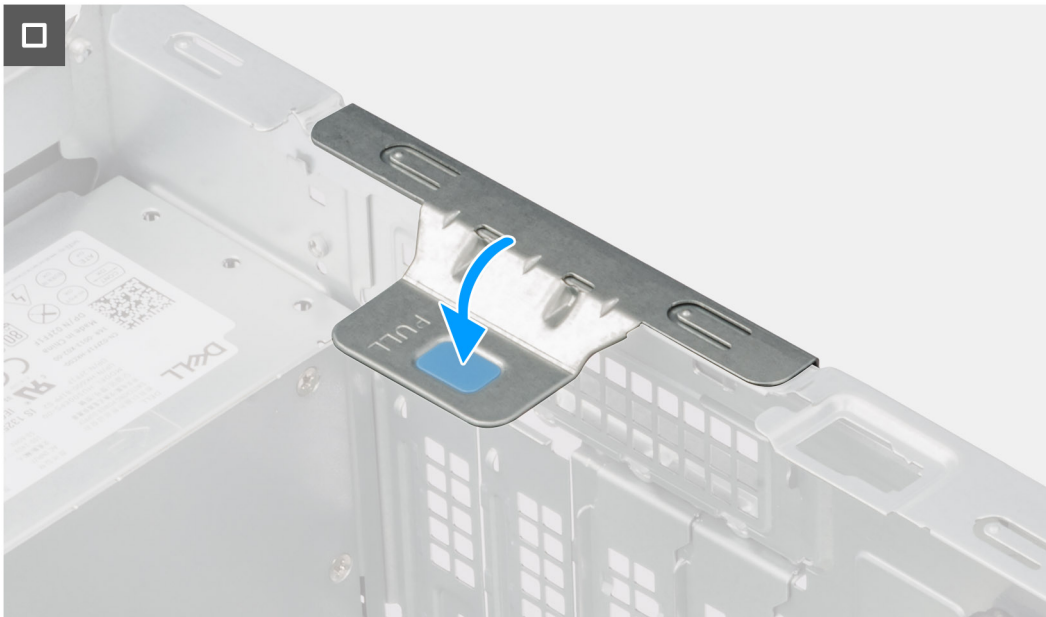

Figure 28. Removing the powered graphics card



**Figure 29. Removing the powered graphics card**

### Steps

1. Lift the pull tab on the PCIe door outwards to open the PCIe door.
2. Disconnect the power cable from the connector on the powered graphics card.
3. Push and hold the tab that secures the powered graphics card to the PCIe card connector (SLOT2) on the system board.
4. Gently lift the powered graphics card off the PCIe card connector on the system board.
5. Align and slide two PCIe blanking plates in the slots on the chassis.
  - i** **NOTE:** Do not perform this step if you are immediately replacing the powered graphics card with a new PCIe card.
6. Close the PCIe door and press it gently until it clicks in place on the chassis.
  - i** **NOTE:** Do not perform this step if you are immediately replacing the powered graphics card with a new PCIe card.

## Installing the powered graphics card

### Prerequisites

If you are replacing a component, remove the existing component before performing the installation procedure.

### About this task

The following images indicate the location of the powered graphics card and provide a visual representation of the installation procedure.



Figure 30. Installing the powered graphics card

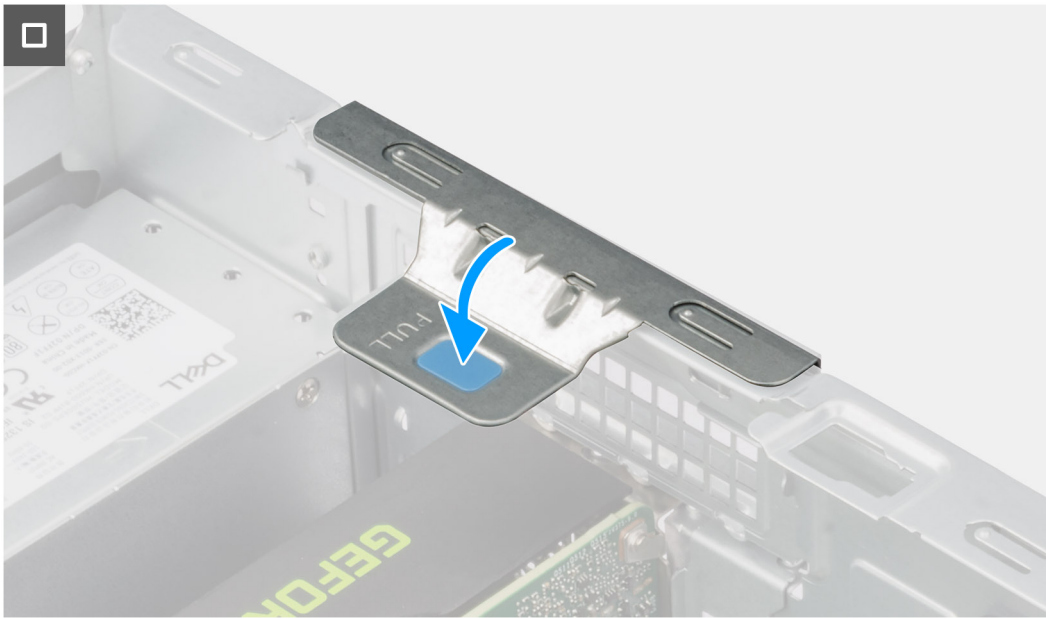

**Figure 31. Installing the powered graphics card**

### Steps

1. Using a screwdriver, remove the fixed PCIe blanking plate from the chassis.
  - i** **NOTE:** This step is applicable only when the powered graphics card is being installed for the first time.
  - i** **NOTE:** To remove the fixed PCIe blanking plate, insert a flat-head screwdriver in the hole of the cover, push the blanking plate to release it, and then lift the blanking plate off the chassis.
  - i** **NOTE:** Ensure to keep the PCIe blanking plate safe for future use.
2. Lift the pull tab on the PCIe door outwards to open the PCIe door.
3. Remove the two PCIe blanking plates from the slots on the chassis.
  - i** **NOTE:** Ensure to keep the PCIe blanking plates safe for future use.
4. Align the notch on the powered graphics card with the tab on the PCIe card connector (SLOT2) on the system board.
5. Gently press down on the powered graphics card till the tab on the PCIe connector locks in place.
6. Connect the power cable to the connector on the powered graphics card.
7. Close the PCIe door and press it gently until it clicks in place on the chassis, to secure the powered graphics card.

### Next steps

1. Install the [side cover](#).
2. Follow the procedure in [After working inside your computer](#).

## Media-card reader

### Removing the media-card reader

**⚠ CAUTION:** The information in this removal section is intended for authorized service technicians only.

#### Prerequisites

1. Follow the procedure in [Before working inside your computer](#).
2. Remove the [side cover](#).

3. Remove the front bezel.

**About this task**

The following images indicate the location of the media-card reader and provide a visual representation of the removal procedure.

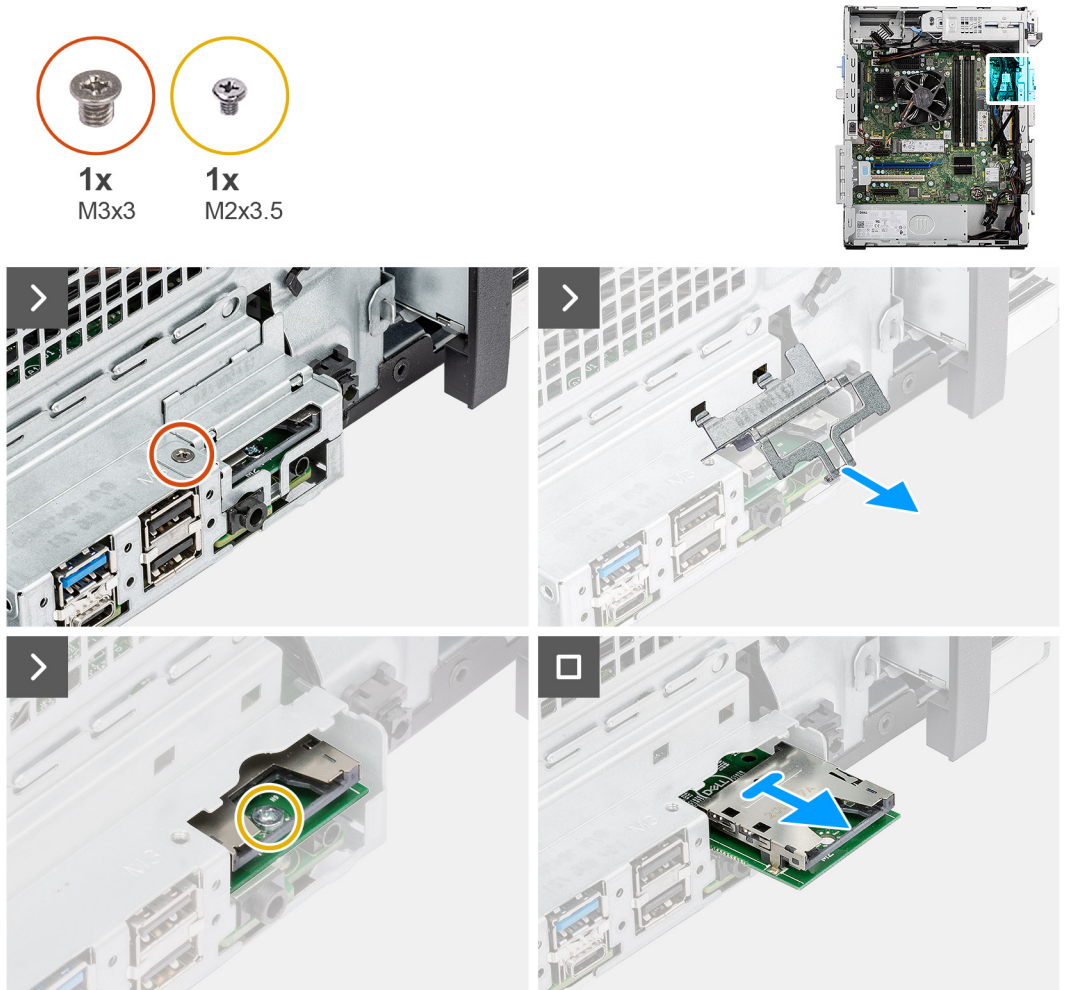

**Figure 32. Removing the media-card reader**

**Steps**

1. Remove the screw (M3x3) that secures the media-card reader door to the chassis.
2. Lift to open the media-card reader door and remove it from the chassis.
3. Remove the screw (M2x3.5) that secures the media-card reader to the system board.
4. Slide and remove the media-card reader from the connector (SD CARD) on the system board.

## Installing the media-card reader

**⚠ CAUTION: The information in this installation section is intended for authorized service technicians only.**

**Prerequisites**

If you are replacing a component, remove the existing component before performing the installation procedure.

### About this task

The following images indicate the location of the media-card reader and provide a visual representation of the installation procedure.

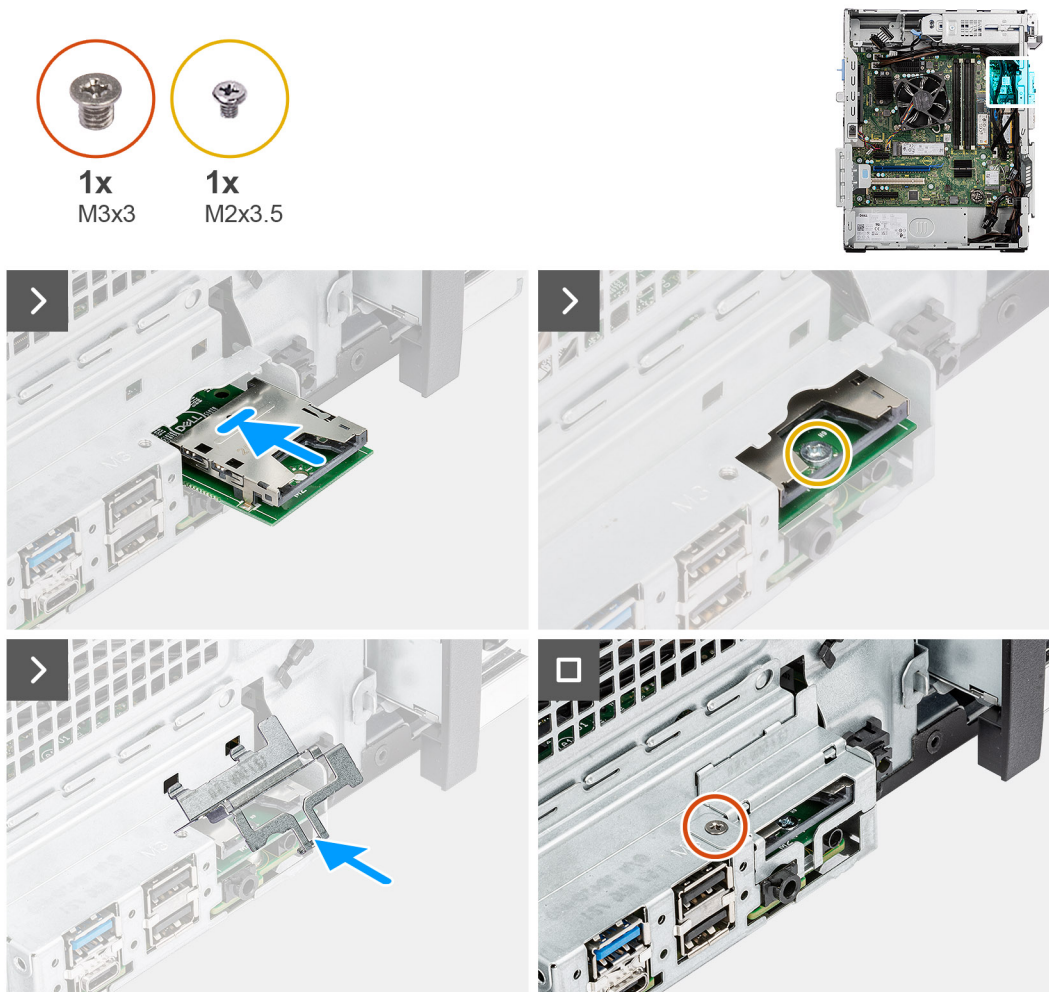

**Figure 33. Installing the media-card reader**

### Steps

1. Connect the media-card reader to the connector (SD CARD) on the system board.
2. Replace the screw (M2x3.5) to secure the media-card reader to the system board.
3. Align and insert the tabs on the media-card reader door in the slots on the chassis.
4. Close the media-card reader door.
5. Replace the screw (M3x3) to secure the media-card door bracket to the chassis.

### Next steps

1. Install the [front bezel](#).
2. Install the [side cover](#).
3. Follow the procedure in [After working inside your computer](#).

# Hard drive

## 3.5-inch hard drive

### Removing the 3.5-inch hard drive

#### Prerequisites

1. Follow the procedure in [Before working inside your computer](#).
2. Remove the [side cover](#).
3. Remove the [front bezel](#).

#### About this task

The following images indicate the location of the 3.5-inch hard drive and provide a visual representation of the removal procedure.



Figure 34. Removing the 3.5-inch hard drive

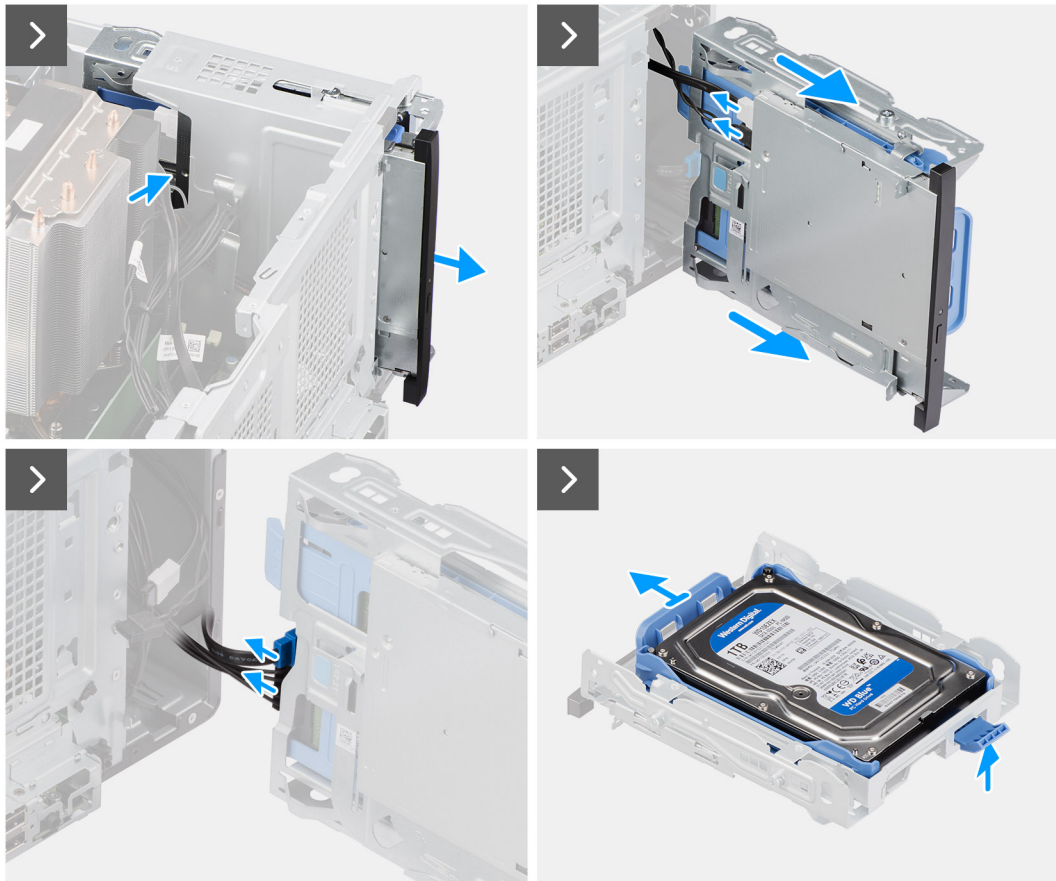
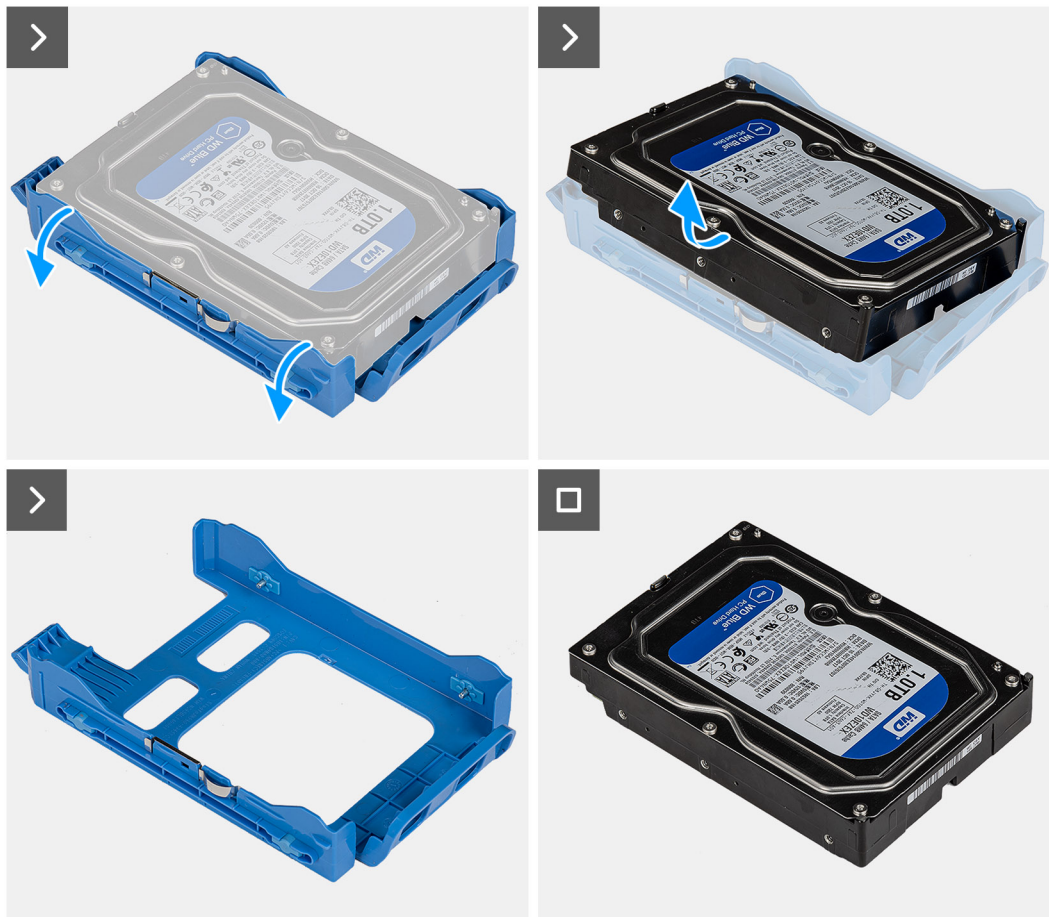

Figure 35. Removing the 3.5-inch hard drive





**Figure 36. Removing the 3.5-inch hard drive**

**Steps**

1. Remove the EMI shield from the front side of the chassis.
2. Remove the data and power cables from the retention clip on the disk-drive cage.
3. Remove the screw (M3) that secures the disk-drive cage to the chassis.
4. Push the securing tab to release the disk-drive cage from the chassis.
5. Gently slide the disk-drive cage away from the slot on the chassis.
6. Disconnect the data and power cables from the respective connectors on the slim optical drive.
7. Disconnect the data and power cables from the respective connectors on the hard drive.
8. Pull the securing tab to release the hard-drive assembly from the disk-drive cage.
9. Slide the 3.5-inch hard-drive assembly away from the slot on the disk-drive cage.
10. Pry one side of the hard-drive bracket edge to release the tabs on the bracket from the slots on the 3.5-inch hard drive.
11. Lift the 3.5-inch hard drive off the hard-drive bracket.

**Installing the 3.5-inch hard drive**

**Prerequisites**

If you are replacing a component, remove the existing component before performing the installation procedure.

**About this task**

The following images indicate the location of the 3.5-inch hard drive and provide a visual representation of the installation procedure.



1x  
M3

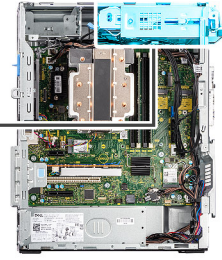
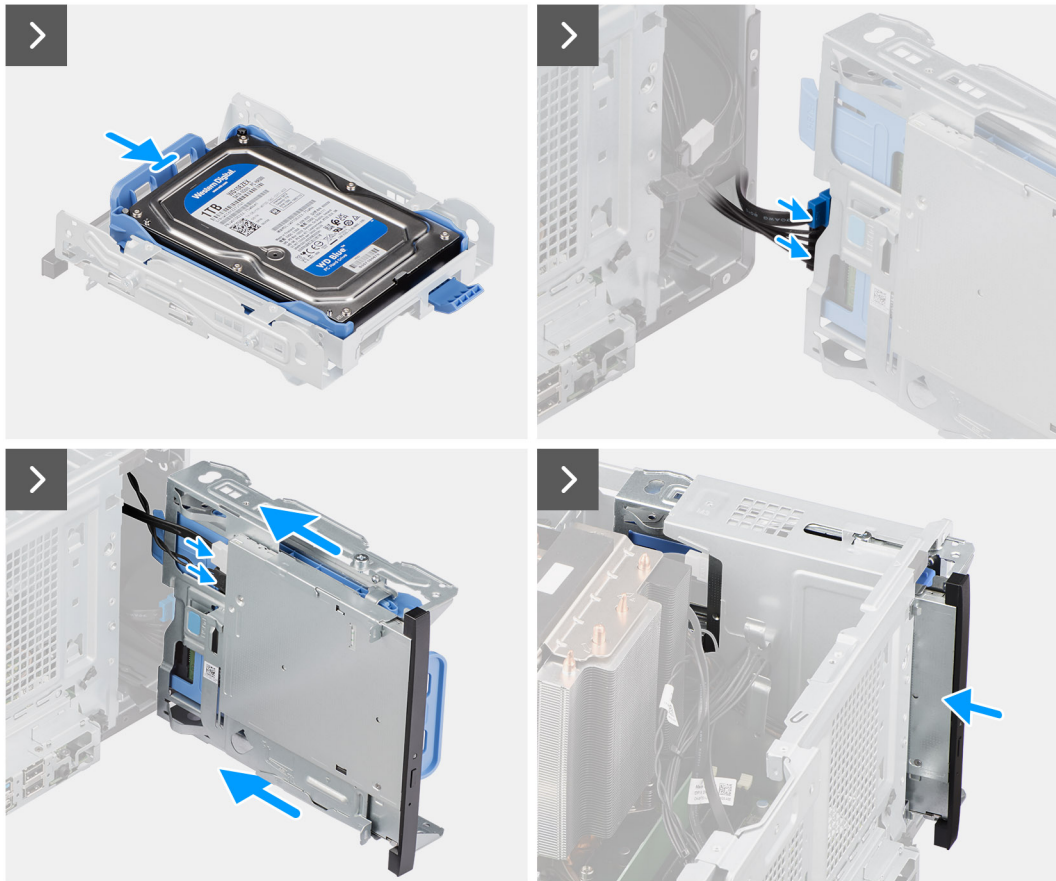
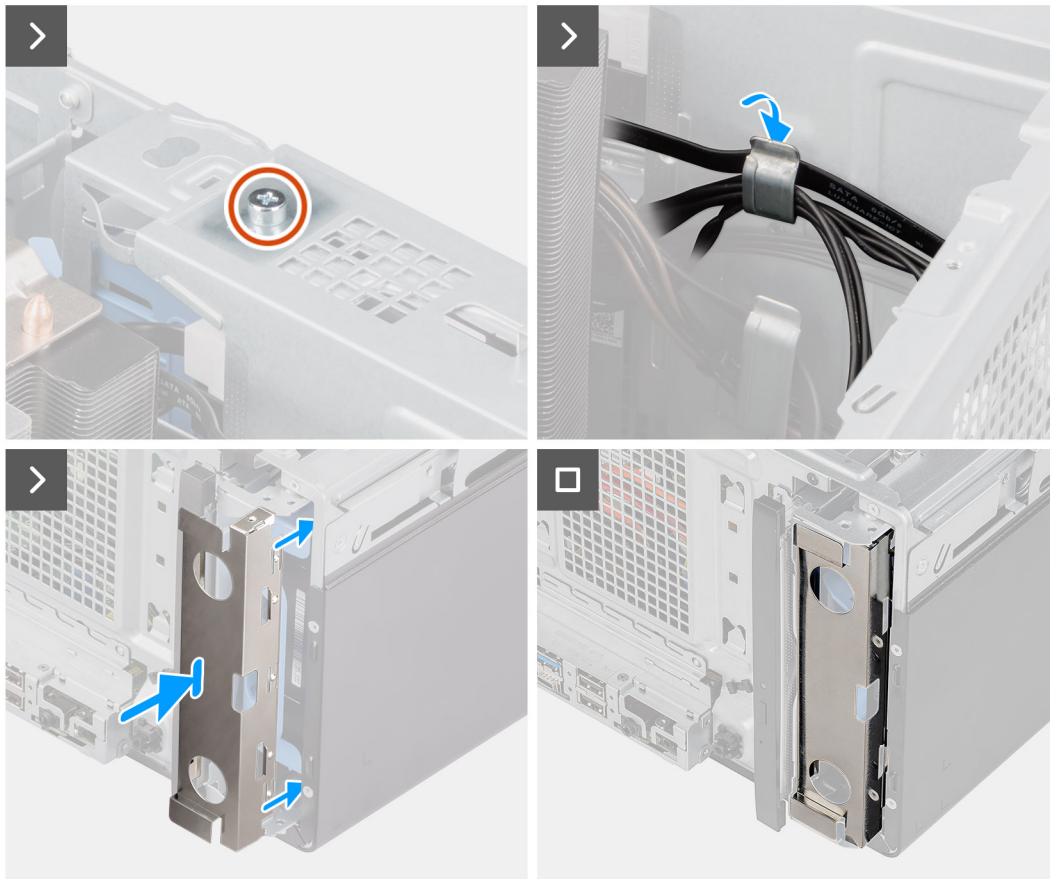

Figure 37. Installing the 3.5-inch hard drive



**Figure 38. Installing the 3.5-inch hard drive**



**Figure 39. Installing the 3.5-inch hard drive**

### Steps

1. Align the tabs on the 3.5-inch hard-drive bracket with the slots on the hard drive and place the hard drive in the hard-drive bracket.
2. Snap the hard-drive bracket onto the 3.5-inch hard drive.
3. Align and slide the 3.5-inch hard-drive assembly in the hard-drive slot on the disk-drive cage.
4. Connect the data and power cables to the respective connectors on the 3.5-inch hard drive.
5. Connect the data and power cables to the respective connectors on the slim optical drive.
6. Align and slide the disk-drive cage in the slot on the chassis.
7. Align the screw hole on the disk-drive cage with the screw hole on the chassis.
8. Replace the screw (M3) to secure the disk-drive cage to the chassis.
9. Route the data and power cables through the retention clip on the disk-drive cage.
10. Align and place the EMI shield in the slot on the chassis.

**i** **NOTE:** When placing the EMI shield, ensure that arrow printed on the front side of the EMI shield faces up.

### Next steps

1. Install the [front bezel](#).
2. Install the [side cover](#).
3. Follow the procedure in [After working inside your computer](#).

## Removing the secondary 3.5-inch hard drive

### Prerequisites

1. Follow the procedure in [Before working inside your computer](#).

2. Remove the [side cover](#).
3. Remove the [front bezel](#).

**About this task**

The following images indicate the location of the secondary 3.5-inch hard drive and provide a visual representation of the removal procedure.

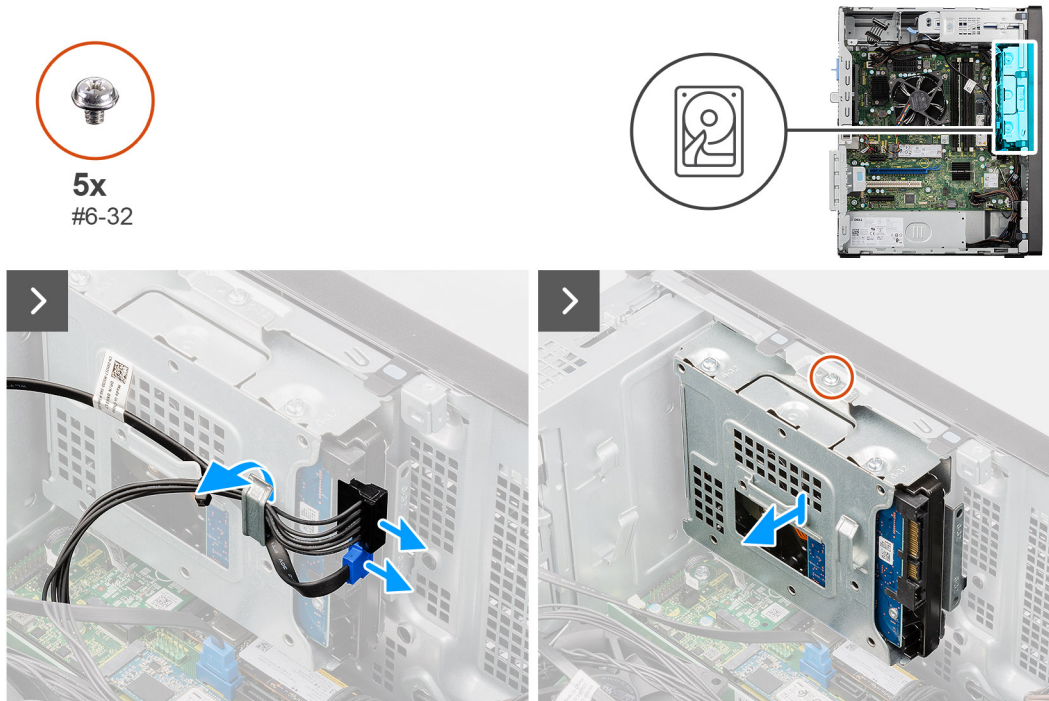

**Figure 40. Removing the secondary 3.5-inch hard drive**

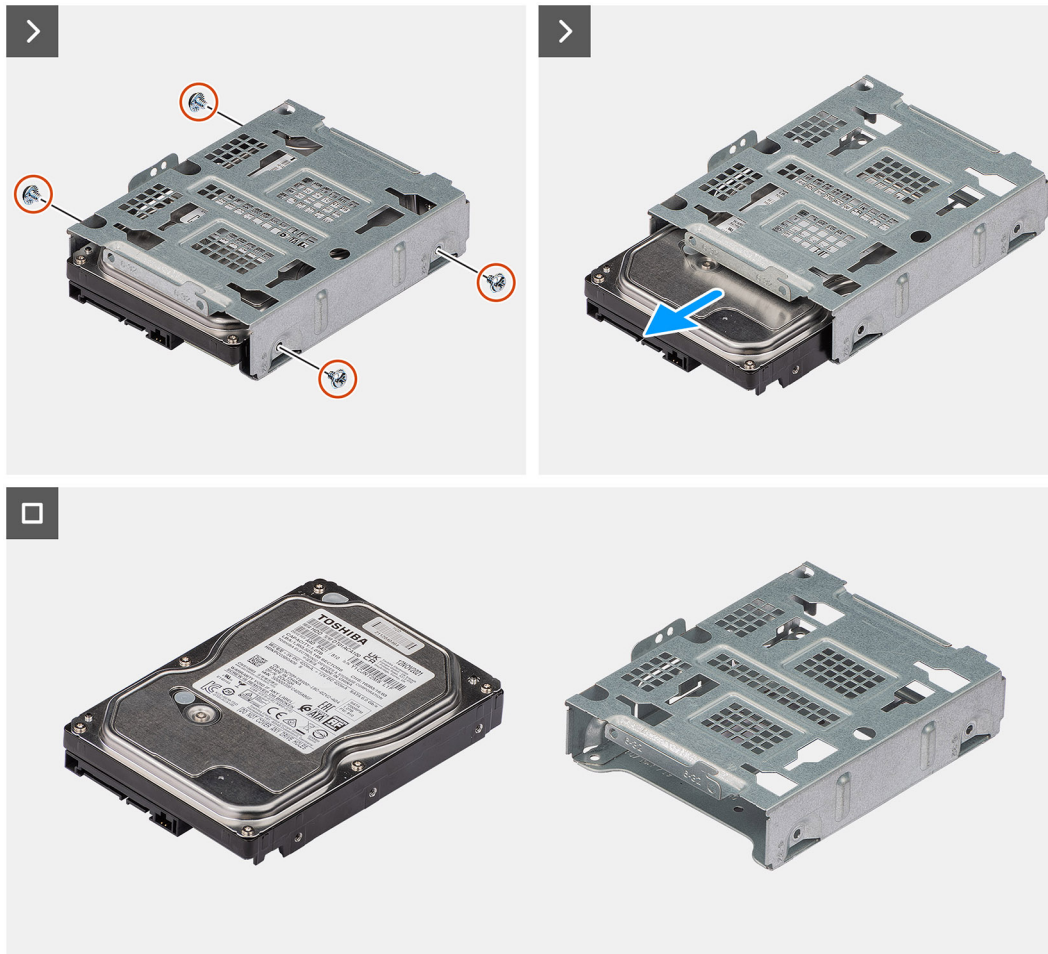

**Figure 41. Removing the secondary 3.5-inch hard drive**

**Steps**

1. Disconnect the data and power cables from the respective connectors on the secondary hard drive.
2. Remove the data and power cables from the retention clips on the secondary hard-drive assembly.
3. Remove the screw (#6-32) that secures the secondary 3.5-inch hard drive to the chassis.
4. Remove the secondary 3.5-inch hard-drive assembly from the chassis.
5. Remove the four screws (#6x32) that secure the secondary 3.5-inch hard drive to the hard-drive bracket.
6. Slide and remove the secondary 3.5-inch hard drive from the hard-drive bracket.

**Installing the secondary 3.5-inch hard drive**

**Prerequisites**

If you are replacing a component, remove the existing component before performing the installation procedure.

**About this task**

The following images indicate the location of the secondary 3.5-inch hard drive and provide a visual representation of the installation procedure.



5x  
#6-32

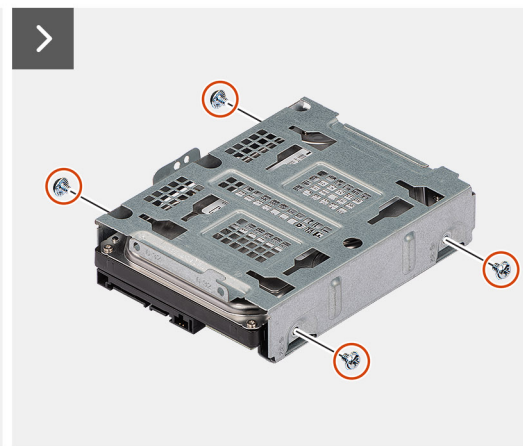
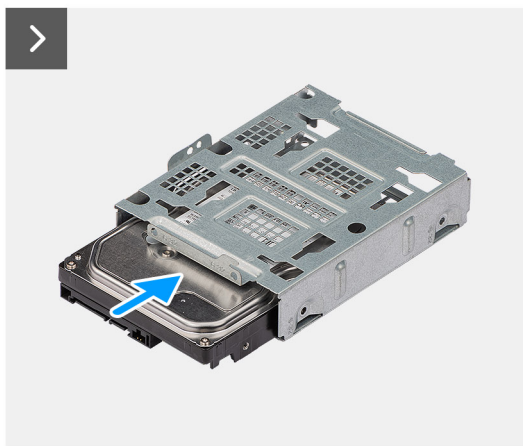
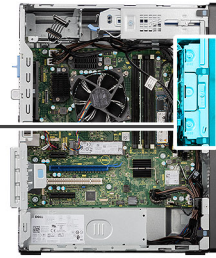

Figure 42. Installing the secondary 3.5-inch hard drive

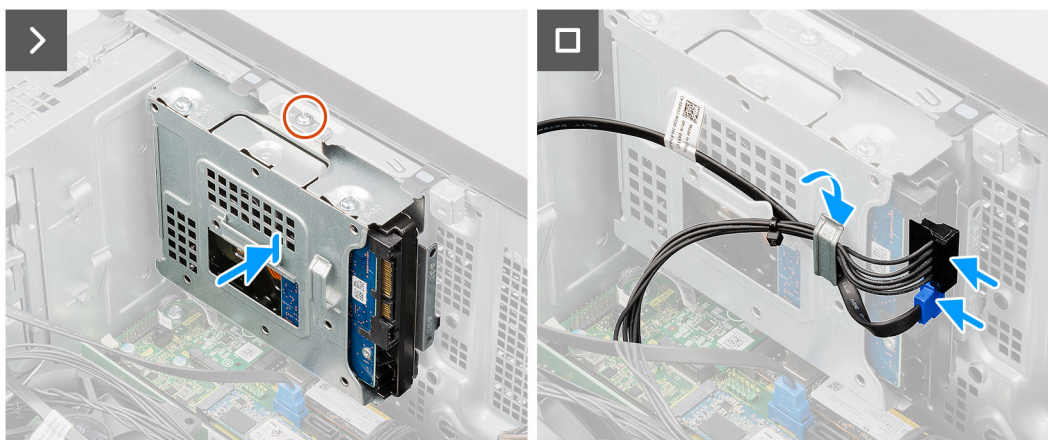

Figure 43. Installing the secondary 3.5-inch hard drive

### Steps

1. Align and insert the secondary 3.5-inch hard drive into the hard-drive bracket.

2. Align the screw holes on the 3.5-inch hard-drive bracket to the holes on the hard drive.
3. Replace the four screws (#6-32) to secure the secondary 3.5-inch hard-drive to the hard-drive bracket.
4. Align and place the secondary 3.5-inch hard-drive assembly in the hard-drive slot on the chassis.
5. Replace the screw (#6-32) to secure the secondary 3.5-inch hard-drive assembly to the chassis.
6. Connect the data and power cables to the respective connectors on the secondary 3.5-inch hard drive.
7. Route the data and power cables through the retention clips on the secondary 3.5-inch hard drive assembly.

#### **Next steps**

1. Install the [front bezel](#).
2. Install the [side cover](#).
3. Follow the procedure in [After working inside your computer](#).

## Optical drive

### Removing the slim optical drive

#### **Prerequisites**

1. Follow the procedure in [Before working inside your computer](#).
2. Remove the [side cover](#).
3. Remove the [front bezel](#).

#### **About this task**

The following images indicate the location of the slim optical drive and provide a visual representation of the removal procedure.





1x  
M3

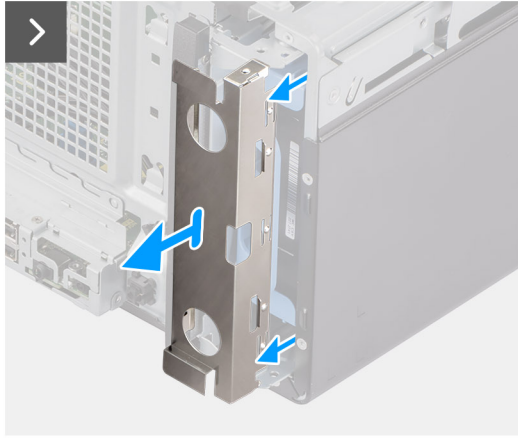
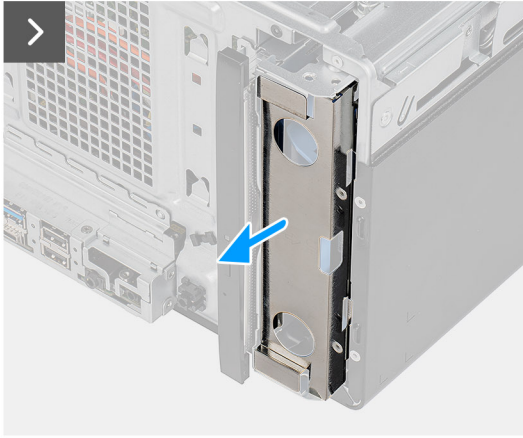
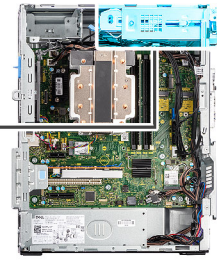

Figure 44. Removing the slim optical drive

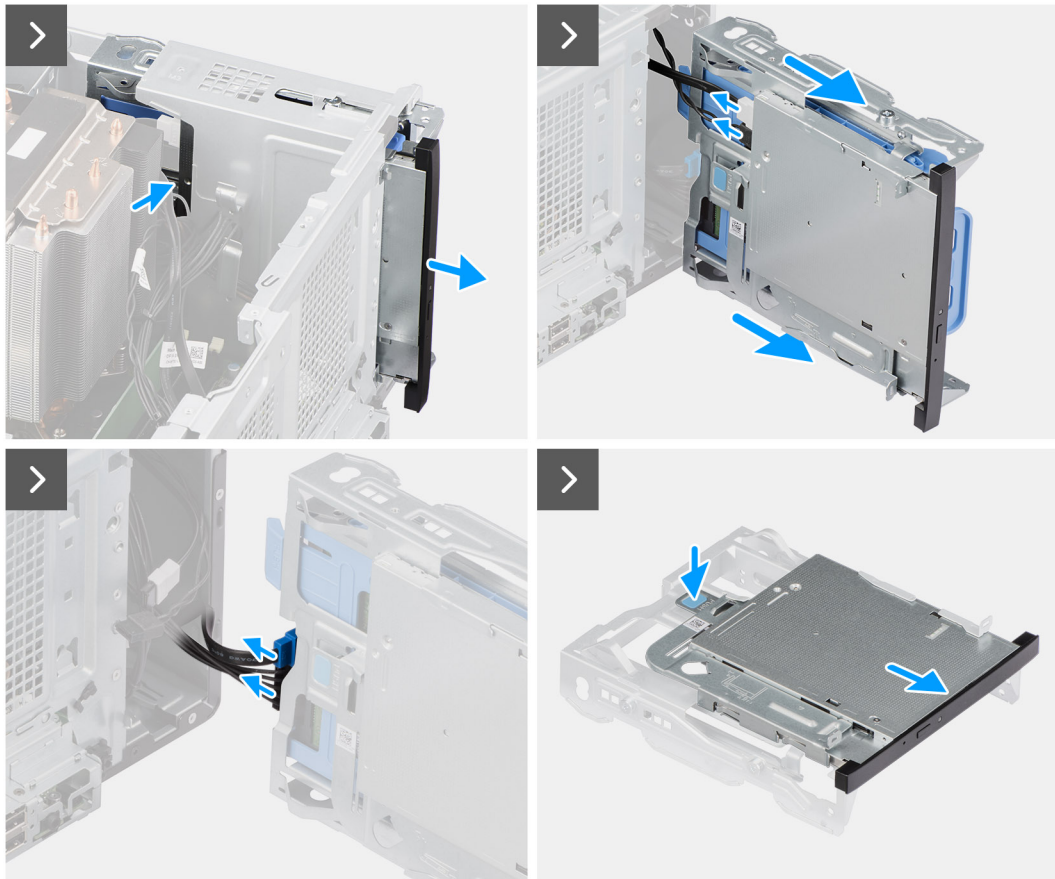
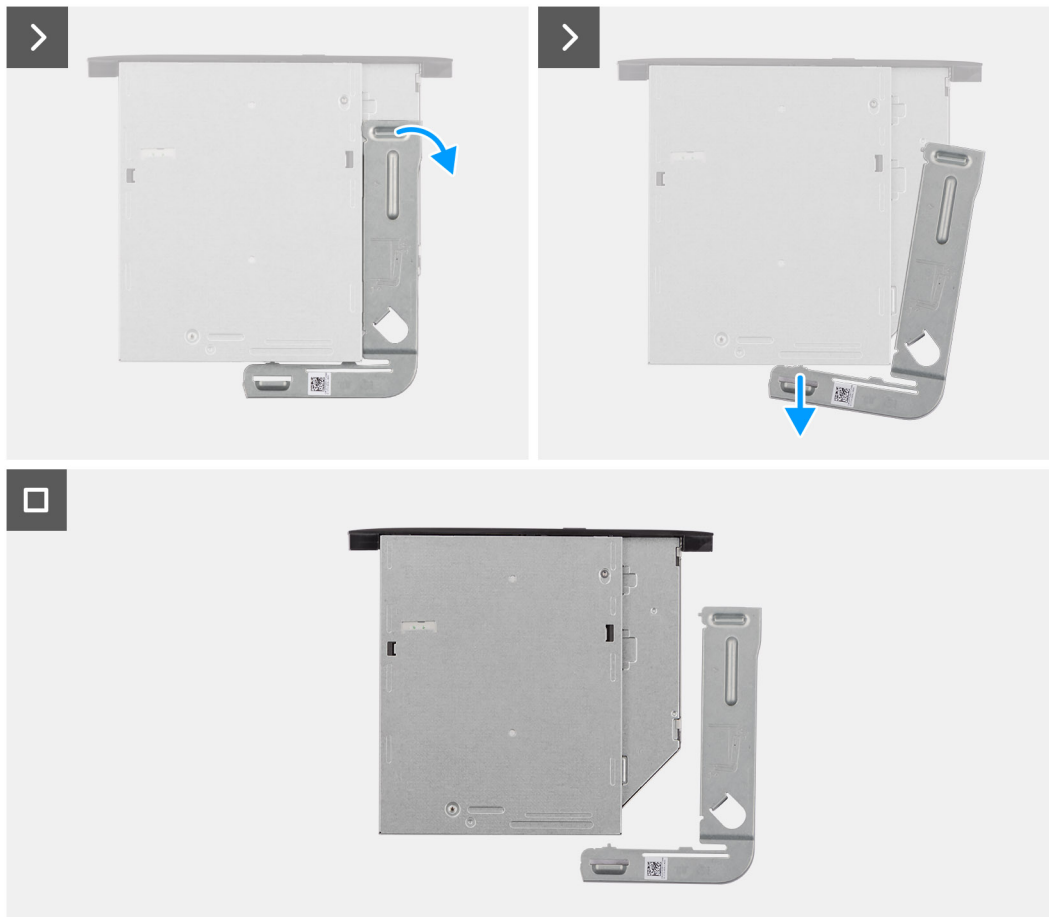

Figure 45. Removing the slim optical drive



**Figure 46. Removing the slim optical drive**

**Steps**

1. Remove the EMI shield from the front side of the chassis.
2. Remove the data and power cables from the retention clip on the disk-drive cage.
3. Remove the screw (M3) that secures the disk-drive cage to the chassis.
4. Push the securing tab to release the disk-drive cage from the chassis.
5. Gently slide the disk-drive cage away from the slot on the chassis.
6. Disconnect the data and power cables from the respective connectors on the slim optical drive.
7. Disconnect the data and power cables from the respective connectors on the hard drive.
8. Push the securing tab to release the slim optical drive from the disk-drive cage.
9. Slide and remove the slim optical drive from the slot on the disk-drive cage.
10. Pry the slim optical-drive bracket to release it from the slot on the slim optical drive.
11. Remove the slim optical-drive bracket from the slim optical drive.

## Installing the slim optical drive

**Prerequisites**

If you are replacing a component, remove the existing component before performing the installation procedure.

**About this task**

The following images indicate the location of the slim optical drive and provide a visual representation of the installation procedure.



1x  
M3

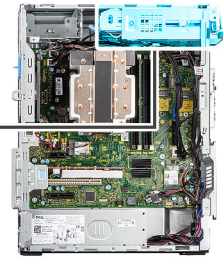

Figure 47. Installing the slim optical drive

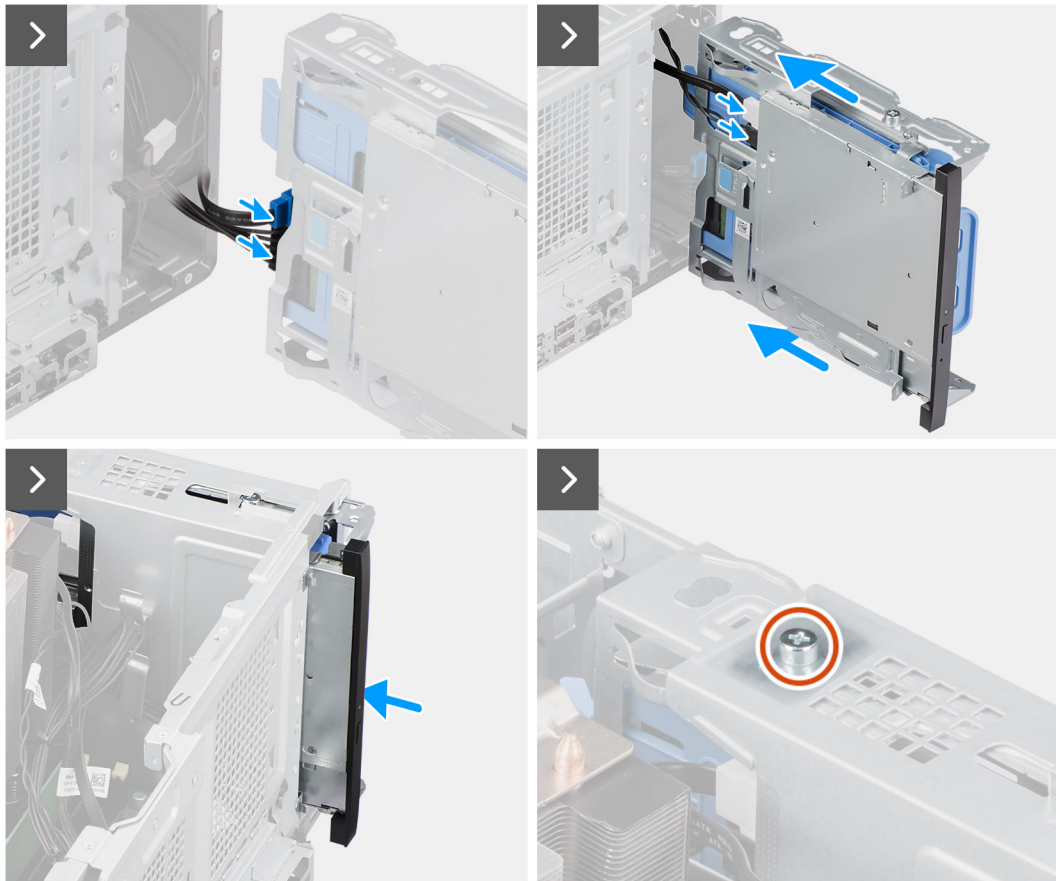
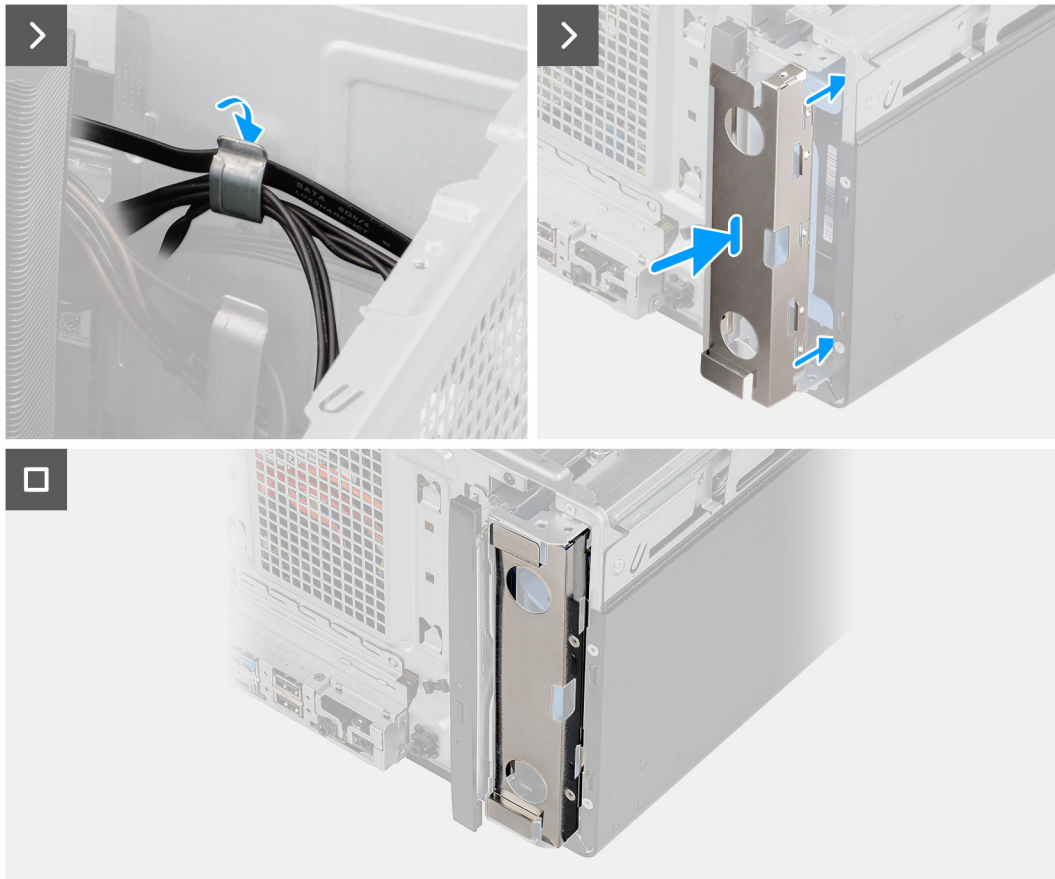

Figure 48. Installing the slim optical drive



**Figure 49. Installing the slim optical drive**

### Steps

1. Insert the alignment pins on the slim optical-drive bracket in the slots on the optical drive.
2. Align and slide the slim optical drive in the optical-drive slot on the disk-drive cage.
3. Connect the data and power cables to the respective connectors on the slim optical drive.
4. Connect the data and power cables to the respective connectors on the 3.5-inch hard drive.
5. Align and slide the disk-drive cage in the slot on the chassis.
6. Align the screw hole on the disk-drive cage with the screw hole on the chassis.
7. Replace the screw (M3) to secure the disk-drive cage to the chassis.
8. Route the data and power cables through the retention clip on the disk-drive cage.
9. Align and place the EMI shield in the slot on the chassis.

**NOTE:** When placing the EMI shield, ensure that arrow printed on the front side of the EMI shield faces up.

### Next steps

1. Install the [front bezel](#).
2. Install the [side cover](#).
3. Follow the procedure in [After working inside your computer](#).

# Internal speaker

## Removing the internal speaker

### Prerequisites

1. Follow the procedure in [Before working inside your computer](#).
2. Remove the [side cover](#).

### About this task

The following images indicate the location of the internal speaker and provide a visual representation of the removal procedure.

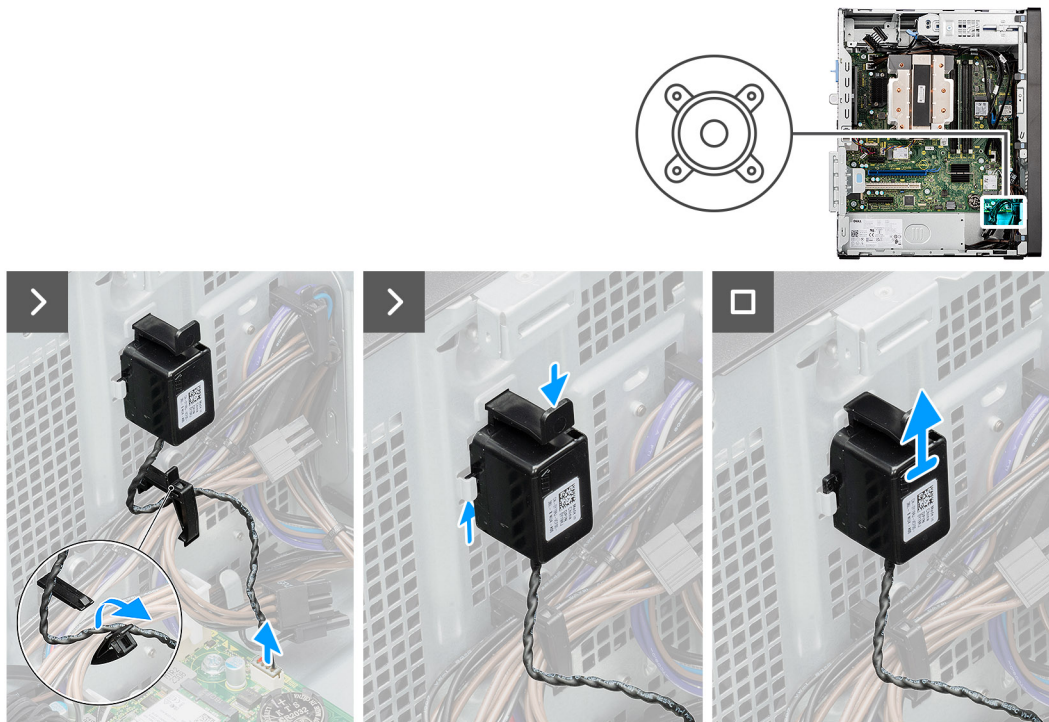

**Figure 50. Removing the internal speaker**

### Steps

1. Gently pull open the retention clip that secures the internal-speaker cable to the chassis.
2. Remove the speaker cable from the retention clip.
3. Disconnect the speaker cable from the connector (INT SPKR) on the system board.
4. Press the tab on the internal speaker, slide the internal speaker upwards, and lift the internal speaker along with the cable from the slot on the chassis.

## Installing the internal speaker

### Prerequisites

If you are replacing a component, remove the existing component before performing the installation procedure.

### About this task

The following images indicate the location of the internal speaker and provide a visual representation of the installation procedure.

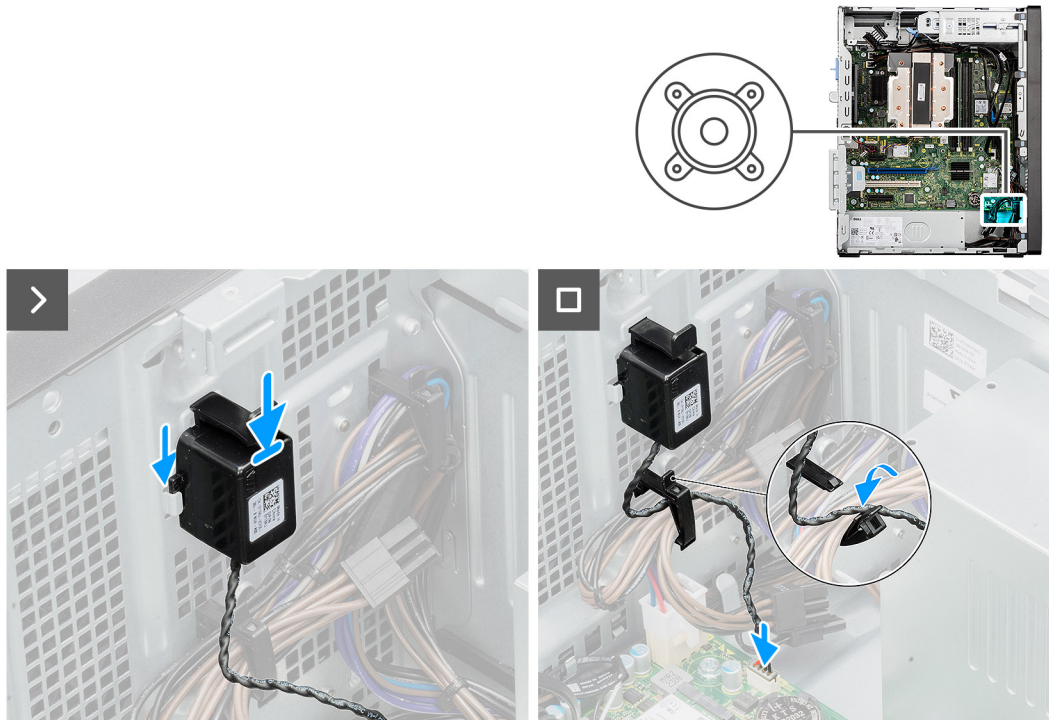

**Figure 51. Installing the internal speaker**

**Steps**

1. Press the tab on the internal speaker, align and slide the internal speaker in the slot on the chassis until it snaps in place.
  - NOTE:** Ensure that the internal speaker is secured under the tabs on the chassis.
2. Open the retention clip, route the internal-speaker cable through the retention clip and close the clip to secure the cable.
3. Connect the internal-speaker cable to the connector (INT SPKR) on the system board.

**Next steps**

1. Install the [side cover](#).
2. Follow the procedure in [After working inside your computer](#).

## Expansion card

### Removing the network card

**Prerequisites**

1. Follow the procedure in [Before working inside your computer](#).
2. Remove the [side cover](#).

**About this task**

The following images indicate the location of the network card and provide a visual representation of the removal procedure.



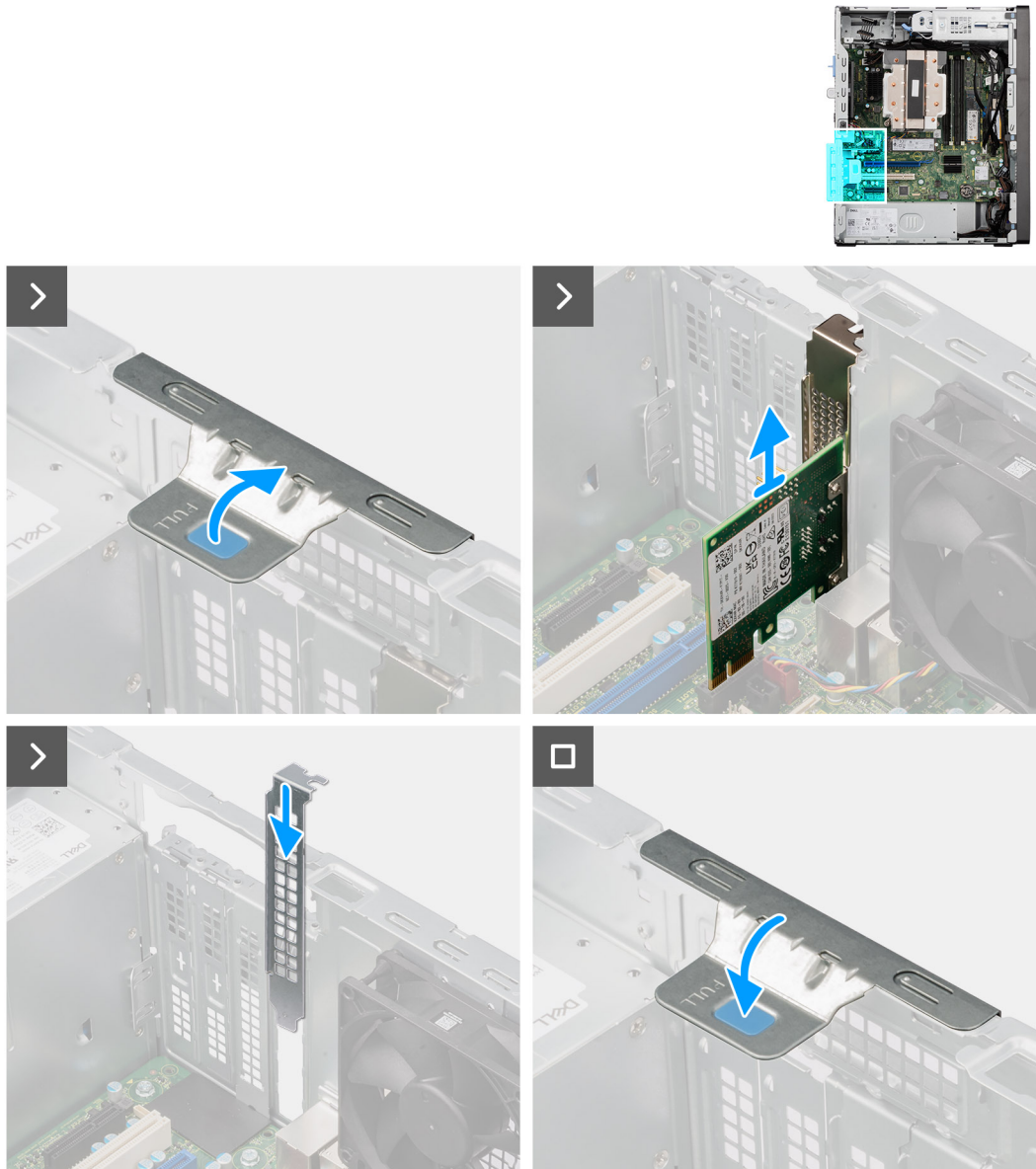

**Figure 52. Removing the network card**

### Steps

1. Lift the pull tab on the PCIe door outwards to open the PCIe door.
2. Gently remove the network card from the PCIe card connector (SLOT1) on the system board.
3. Align and slide the PCIe blanking plate in the slot on the chassis.

**NOTE:** Do not perform this step if you are immediately replacing the network card with a new PCIe card.

4. Close the PCIe door and press it gently until it clicks in place on the chassis.

**NOTE:** Do not perform this step if you are immediately replacing the network card with a new PCIe card.

## Installing the network card

### Prerequisites

If you are replacing a component, remove the existing component before performing the installation procedure.

### About this task

The following images indicate the location of the network card and provide a visual representation of the installation procedure.

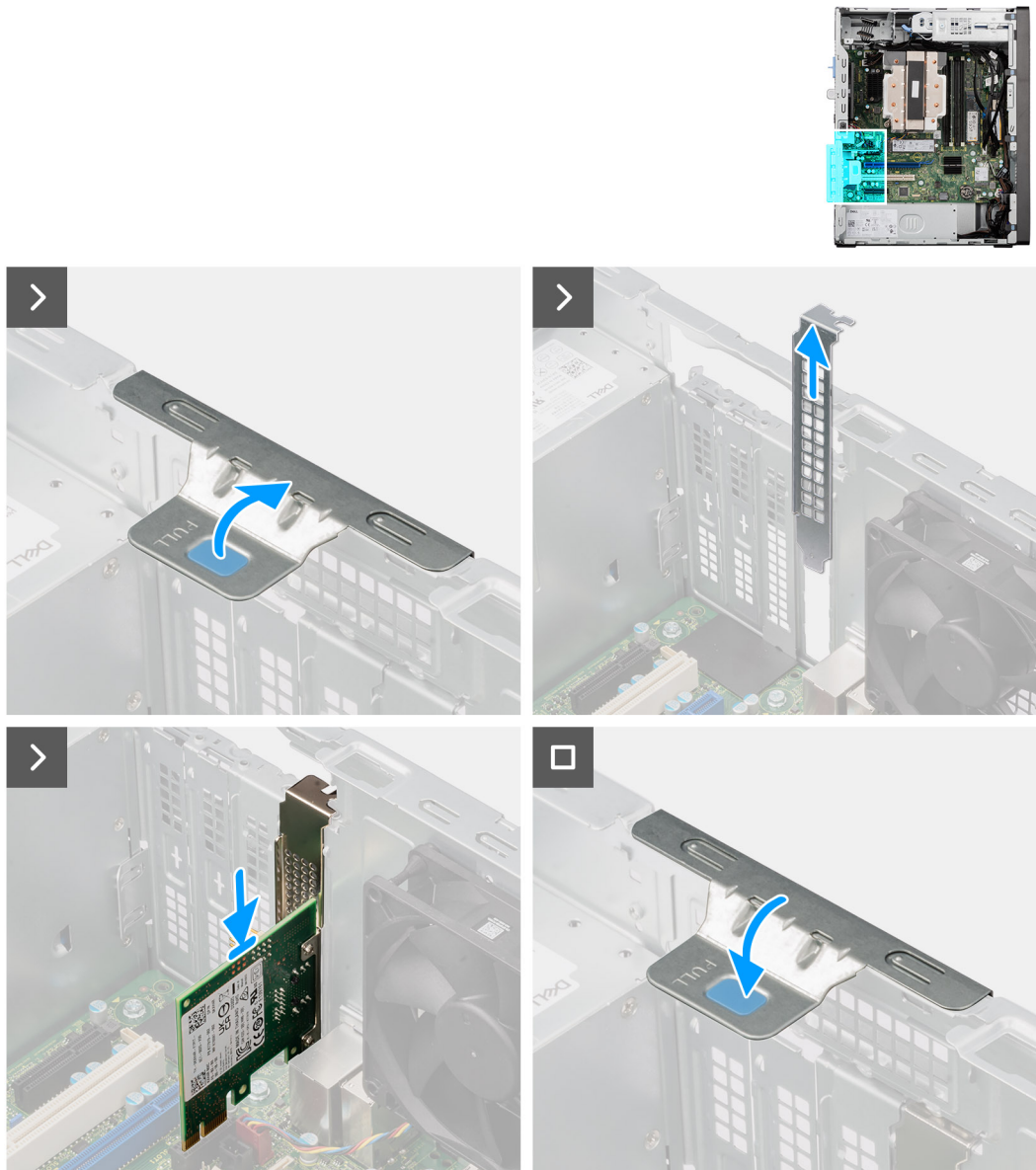

**Figure 53. Installing the network card**

### Steps

1. Lift the pull tab on the PCIe door outwards to open the PCIe door.
2. Remove the PCIe blanking plate from the slot on the chassis.  
**i** **NOTE:** Ensure to keep the PCIe blanking plate safe for future use.
3. Align the notch on the network card with the tab on the PCIe card connector (SLOT1) on the system board.
4. Gently press down on the network card till the tab on the PCIe connector locks in place.
5. Close the PCIe door and press it gently until it clicks in place on the chassis, to secure the network card.

### Next steps

1. Install the [side cover](#).
2. Follow the procedure in [After working inside your computer](#).

## Removing the serial/parallel port card

### Prerequisites

1. Follow the procedure in [Before working inside your computer](#).
2. Remove the [side cover](#).

### About this task

The following images indicate the location of the serial/parallel port card and provide a visual representation of the removal procedure.

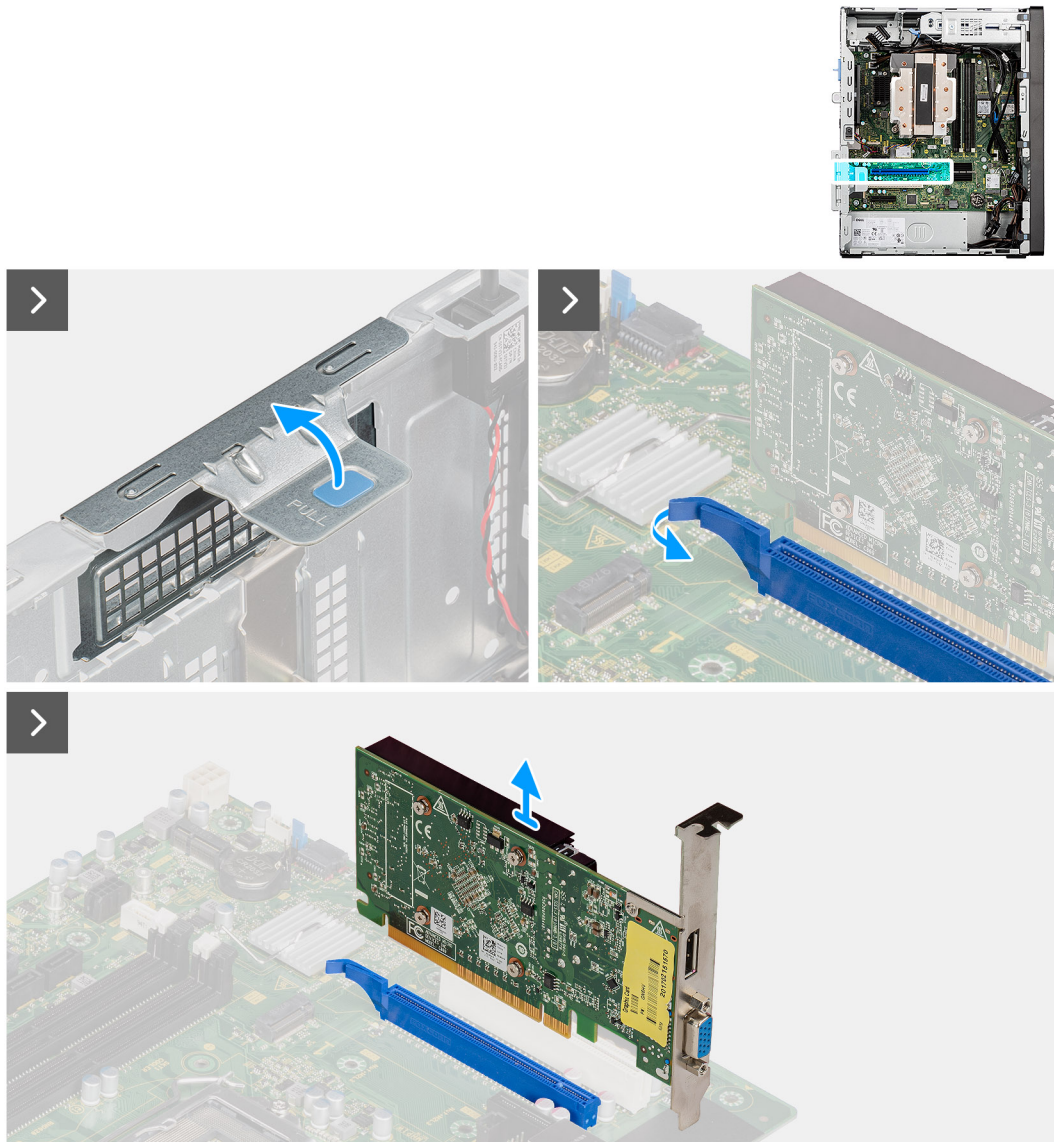
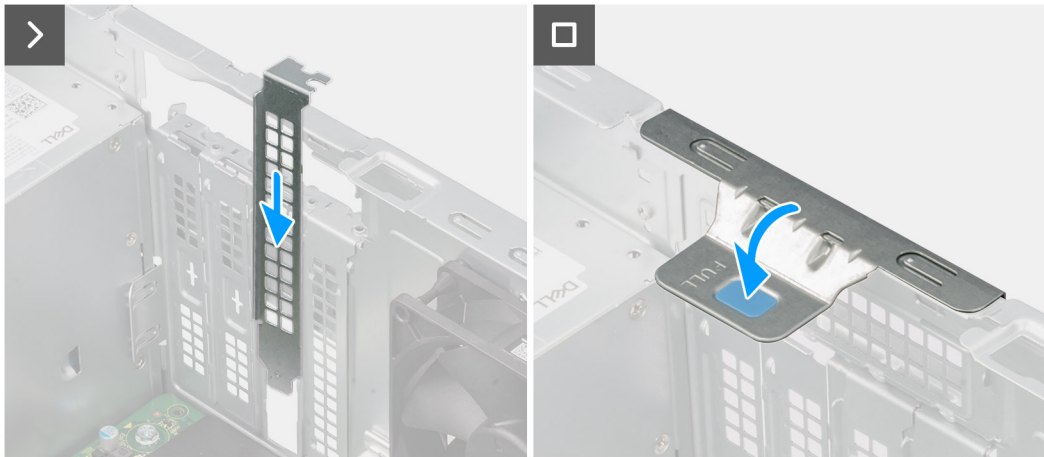

Figure 54. Removing the serial/parallel port card



**Figure 55. Removing the serial/parallel port card**

### Steps

1. Lift the pull tab on the PCIe door outwards to open the PCIe door.
2. Push and hold the tab that secures the serial/parallel port card to the PCIe card connector (SLOT2) on the system board.
3. Gently lift the serial/parallel port card off the PCIe card connector on the system board.
4. Align and slide the PCIe blanking plate in the slot on the chassis.

**i** **NOTE:** Do not perform this step if you are immediately replacing the serial/parallel port card with a new PCIe card.

5. Close the PCIe door and press it gently until it clicks in place on the chassis.

**i** **NOTE:** Do not perform this step if you are immediately replacing the serial/parallel port card with a new PCIe card.

## Installing the serial/parallel port card

### Prerequisites

If you are replacing a component, remove the existing component before performing the installation procedure.

### About this task

The following images indicate the location of the communication card and provide a visual representation of the installation procedure.

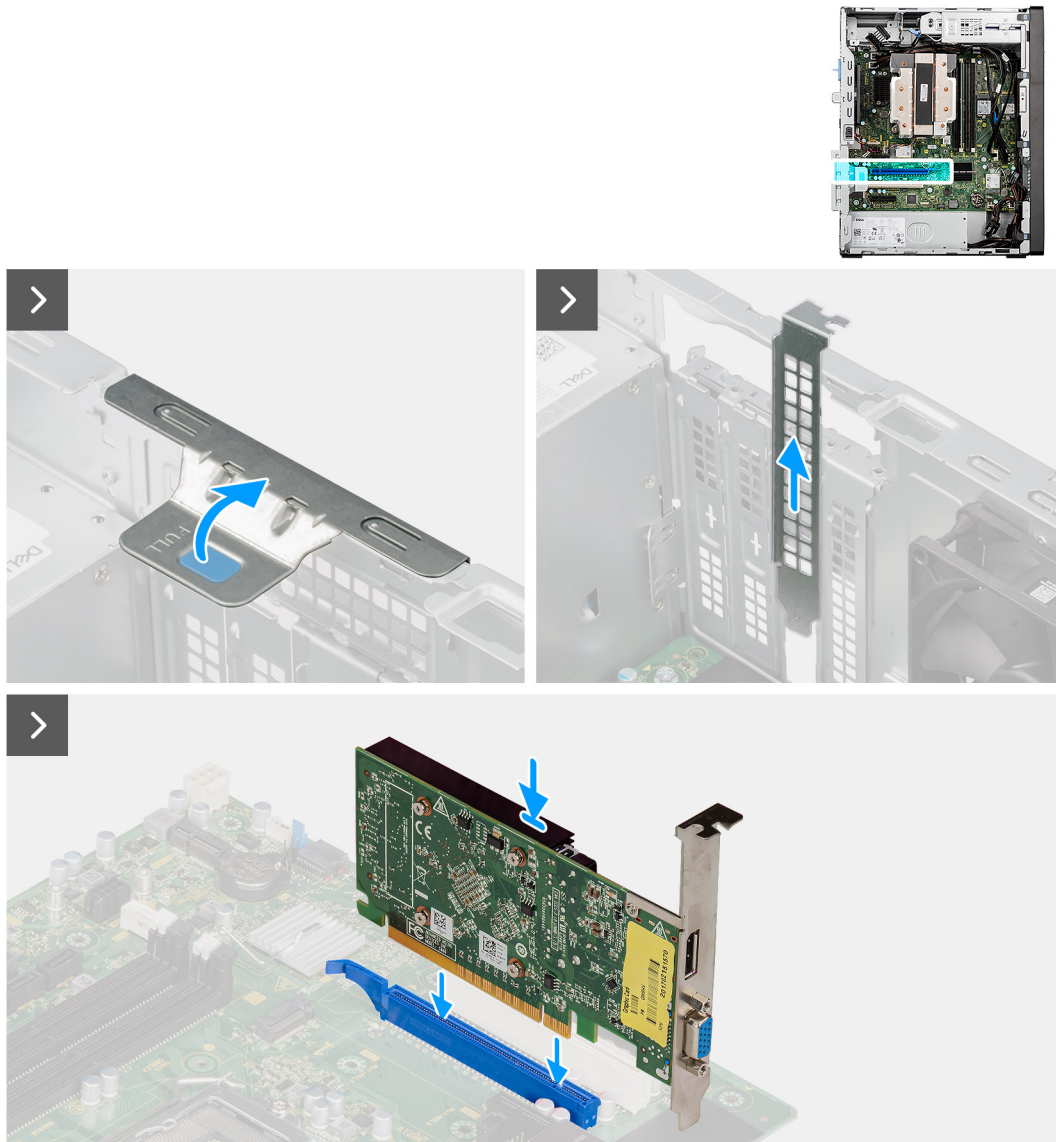

Figure 56. Installing the serial/parallel port card

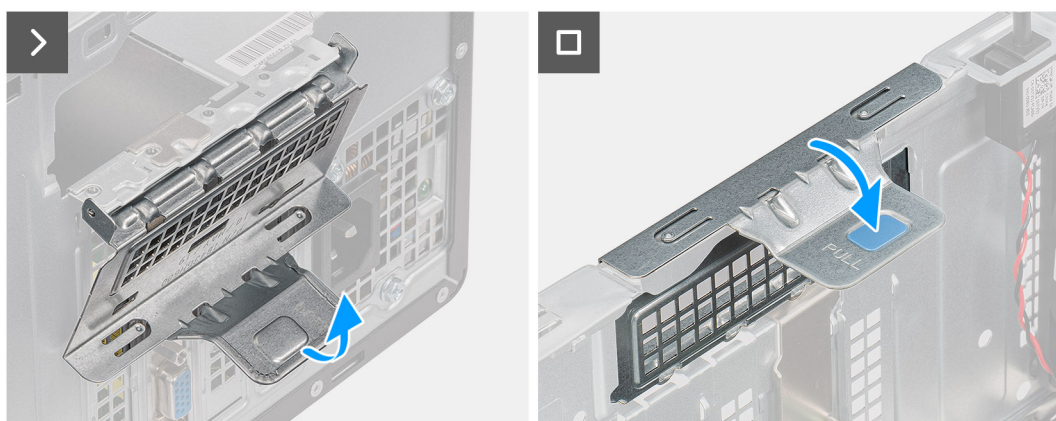

Figure 57. Installing the serial/parallel port card

#### Steps

1. Lift the pull tab on the PCIe door outwards to open the PCIe door.
2. Remove the PCIe blanking plate from the slot on the chassis.

**NOTE:** Ensure to keep the PCIe blanking plate safe for future use.

3. Align the notch on the serial/parallel port card with the tab on the PCIe card connector (SLOT2) on the system board.
4. Gently press down on the serial/parallel port card till the tab on the PCIe connector locks in place.
5. Close the PCIe door and press it gently until it clicks in place on the chassis, to secure the serial/parallel port card.

#### Next steps

1. Install the [side cover](#).
2. Follow the procedure in [After working inside your computer](#).

## Intrusion switch

### Removing the intrusion switch

#### Prerequisites

1. Follow the procedure in [Before working inside your computer](#).
2. Remove the [side cover](#).

#### About this task

The following images indicate the location of the intrusion switch and provide a visual representation of the removal procedure.



**Figure 58. Removing the intrusion switch**

#### Steps

1. Disconnect the intrusion-switch cable from the connector (INTRUSION) on the system board.
2. Slide the intrusion switch to the unlocked position and remove the intrusion switch from the chassis.

# Installing the intrusion switch

## Prerequisites

If you are replacing a component, remove the existing component before performing the installation procedure.

## About this task

The following images indicate the location of the intrusion switch and provide a visual representation of the installation procedure.



**Figure 59. Installing the intrusion switch**

## Steps

1. Insert the intrusion switch in the slot on the chassis and slide the intrusion switch to the locked position to secure it to the chassis.
2. Connect the intrusion-switch cable to the connector (INTRUSION) on the system board.

## Next steps

1. Install the [side cover](#).
2. Follow the procedure in [After working inside your computer](#).

# Removing and installing Field Replaceable Units (FRUs)

The replaceable components in this chapter are Field Replaceable Units (FRUs).

 **CAUTION:** The information in this removing and installing FRU's section is intended for authorized service technicians only.

 **CAUTION:** To avoid any potential damage to the component or loss of data, ensure that an authorized service technician replaces the Field Replaceable Units (FRUs).

 **CAUTION:** Dell Technologies recommends that this set of repairs, if needed, to be conducted by trained technical repair specialists.

 **CAUTION:** As a reminder, your warranty does not cover damages that may occur during FRU repairs that are not authorized by Dell Technologies.

 **NOTE:** The images in this document may differ from your computer depending on the configuration you ordered.

## Power button

### Removing the power button

 **CAUTION:** The information in this removal section is intended for authorized service technicians only.

#### Prerequisites

1. Follow the procedure in [Before working inside your computer](#).
2. Remove the [side cover](#).
3. Remove the [front bezel](#).

#### About this task

The following images indicate the location of the power button and provide a visual representation of the removal procedure.



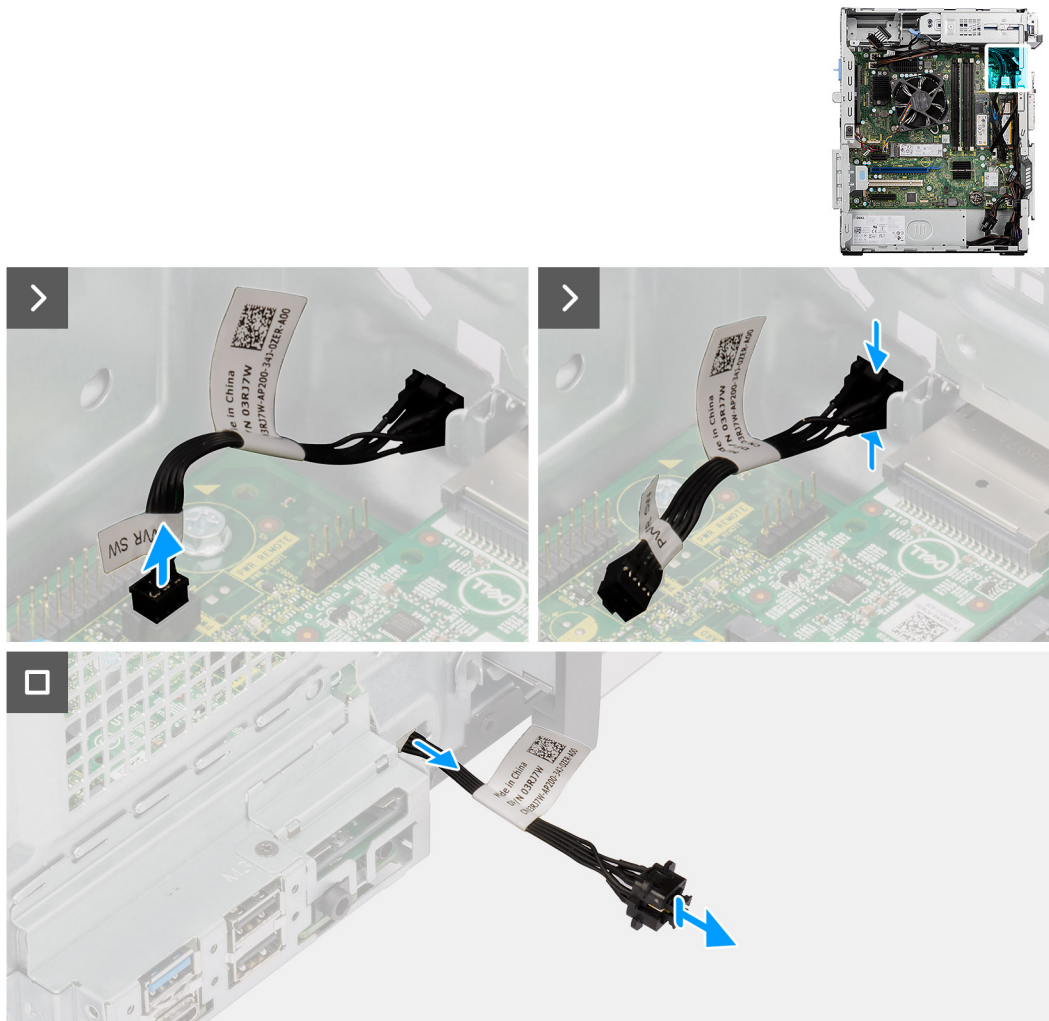

**Figure 60. Removing the power button**

**Steps**

1. Disconnect the power-button cable from the connector (PWR SW) on the system board.
2. Press the release tabs on the power-button head and slide the power-button cable out from the front-side chassis of the computer.
3. Remove the power-button cable from the computer.

## Installing the power button

**CAUTION:** The information in this installation section is intended for authorized service technicians only.

**Prerequisites**

If you are replacing a component, remove the existing component before performing the installation procedure.

**About this task**

The following images indicate the location of the power button and provide a visual representation of the installation procedure.

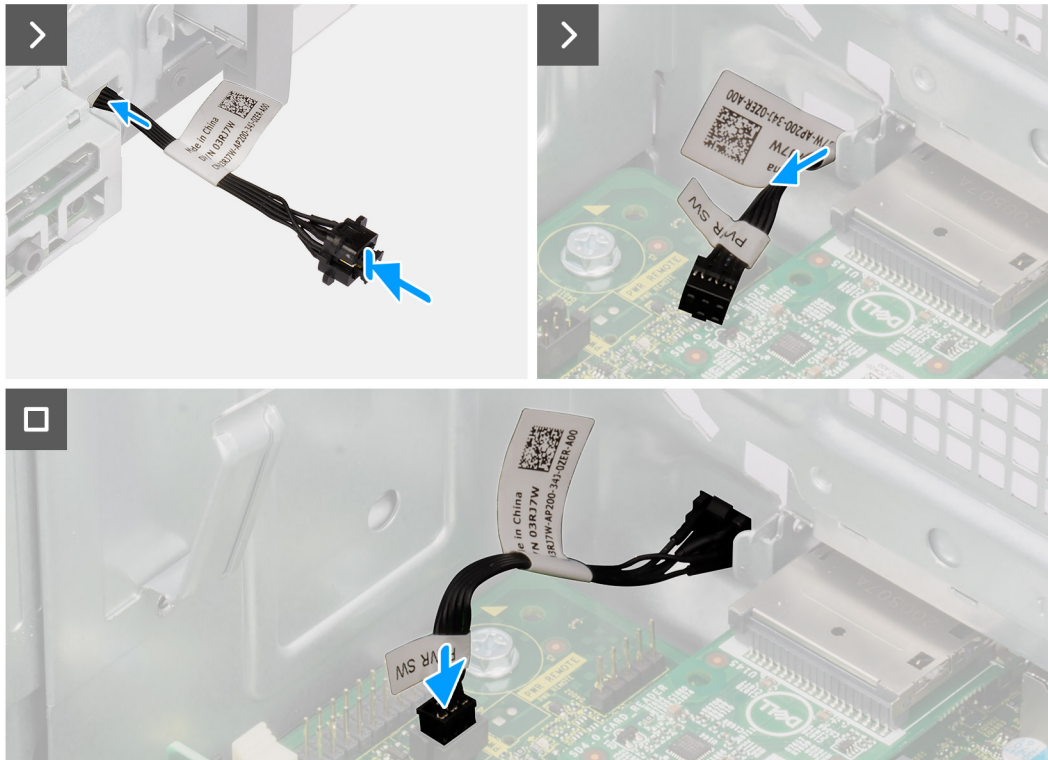

**Figure 61. Installing the power button**

**Steps**

1. Insert the power-button cable in the slot on the chassis from the front-side of the computer, and press the power-button head until it clicks into the place in the chassis.
2. Connect the power-button cable to the connector (PWR SW) on the system board.

**Next steps**

1. Install the [front bezel](#).
2. Install the [side cover](#).
3. Follow the procedure in [After working inside your computer](#).

## Wireless antenna kit

### Internal antenna module

### Removing the internal antenna module

 **CAUTION:** The information in this removal section is intended for authorized service technicians only.

### Prerequisites

1. Follow the procedure in [Before working inside your computer](#).
2. Remove the [side cover](#).
3. Remove the [front bezel](#).
4. Remove the [wireless card](#).

### About this task

The following images indicate the location of the internal antenna module and provide a visual representation of the removal procedure.

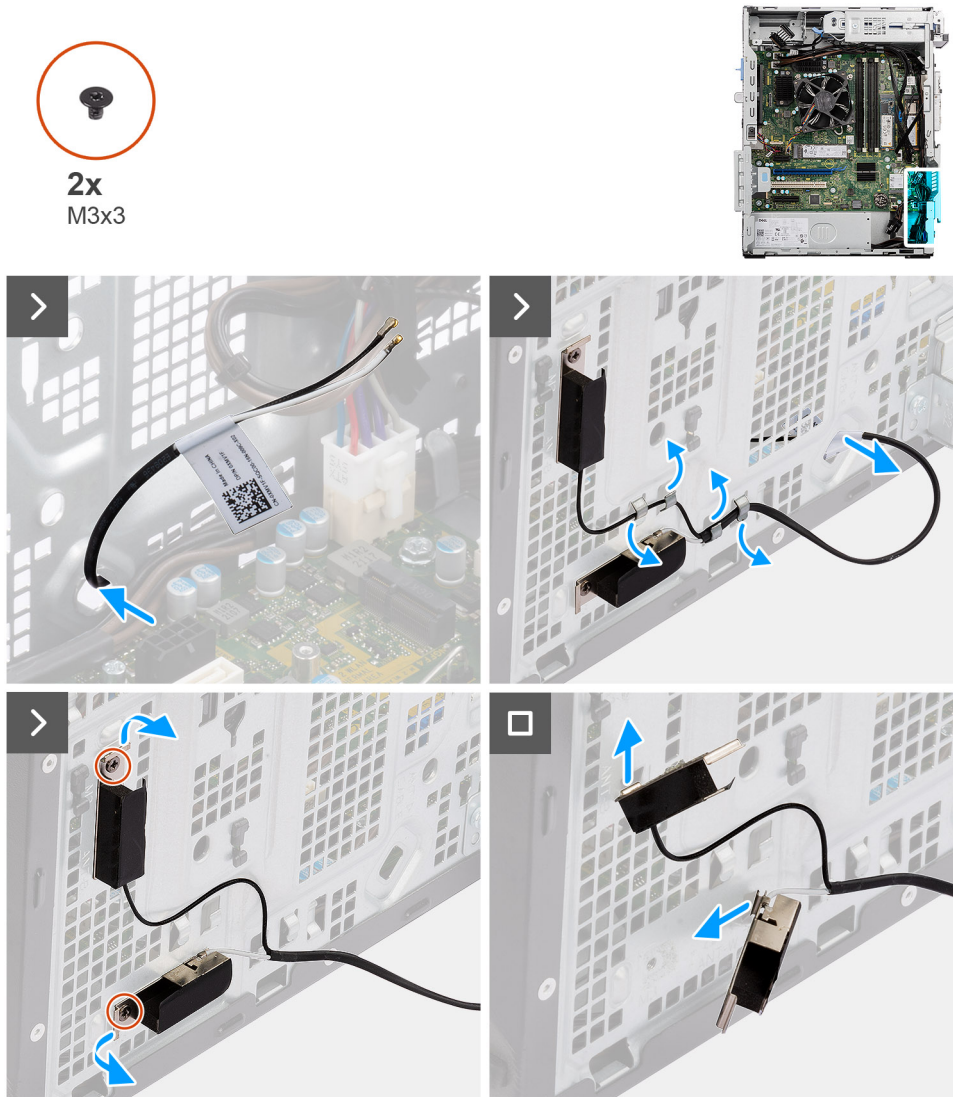
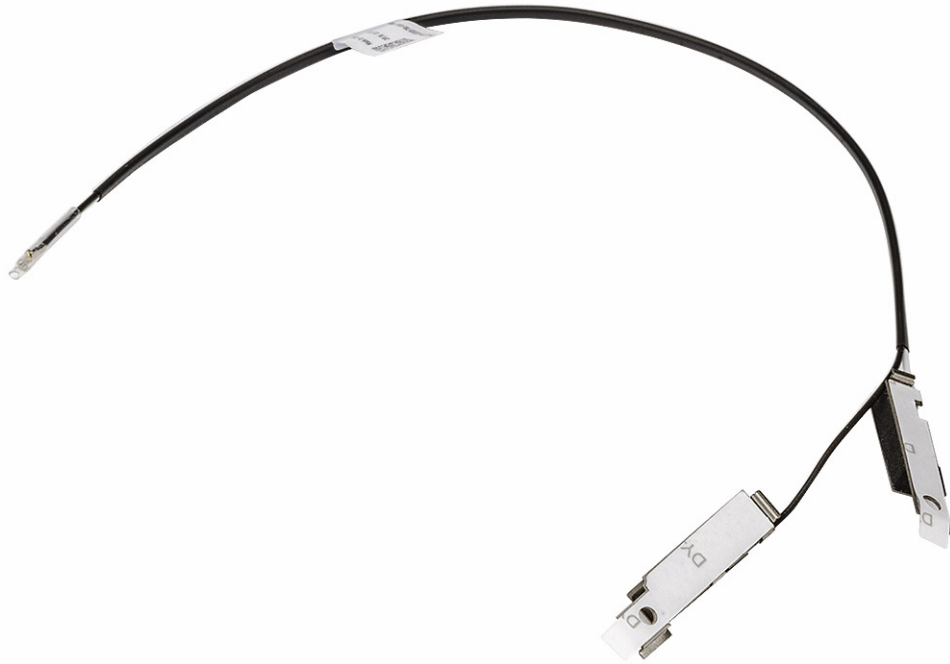

Figure 62. Removing the internal antenna module



**Figure 63. Internal antenna module**

#### **Steps**

1. Gently pull the internal-antenna cable out from the slot on the chassis.
2. Remove the internal-antenna cable from the routing guides on the chassis.
3. Remove the two screws (M3x3) that secure the internal antenna module to the chassis.
4. Remove the internal antenna module from the chassis.

## **Installing the internal antenna module**

**CAUTION:** The information in this installation section is intended for authorized service technicians only.

#### **Prerequisites**

If you are replacing a component, remove the existing component before performing the installation procedure.

#### **About this task**

The following images indicate the location of the internal antenna module and provide a visual representation of the installation procedure.

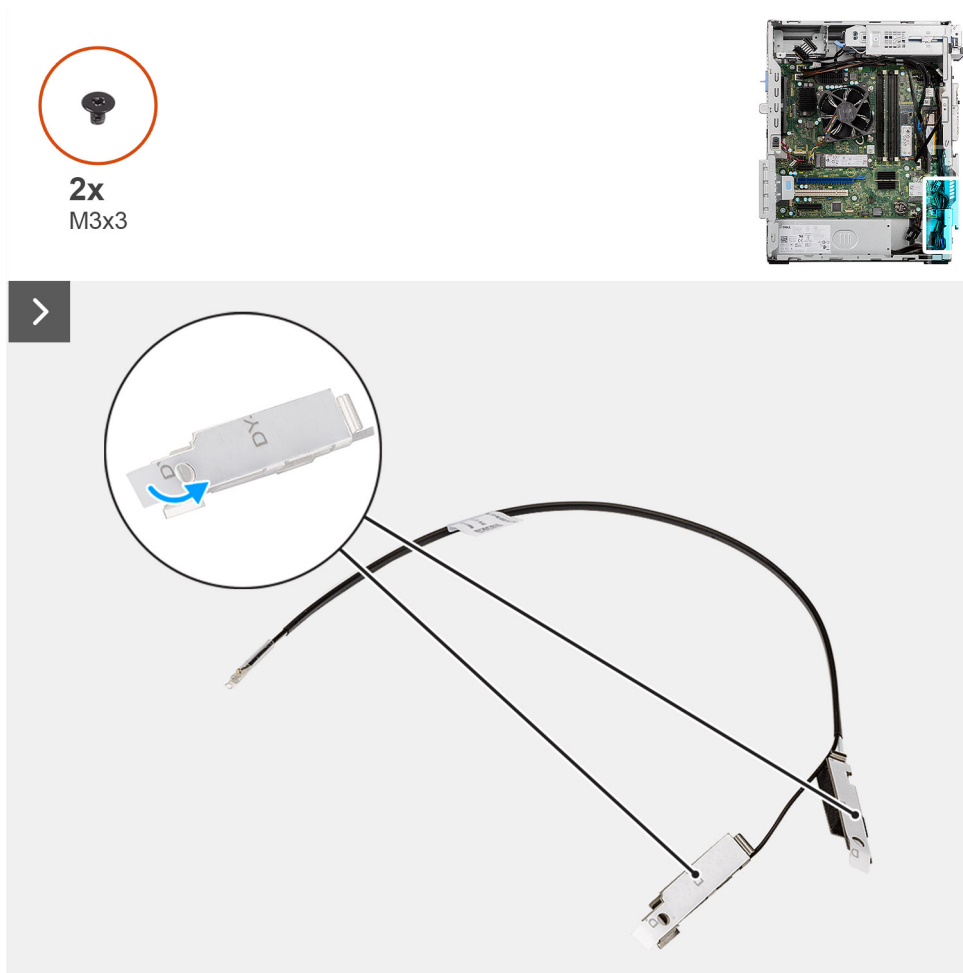
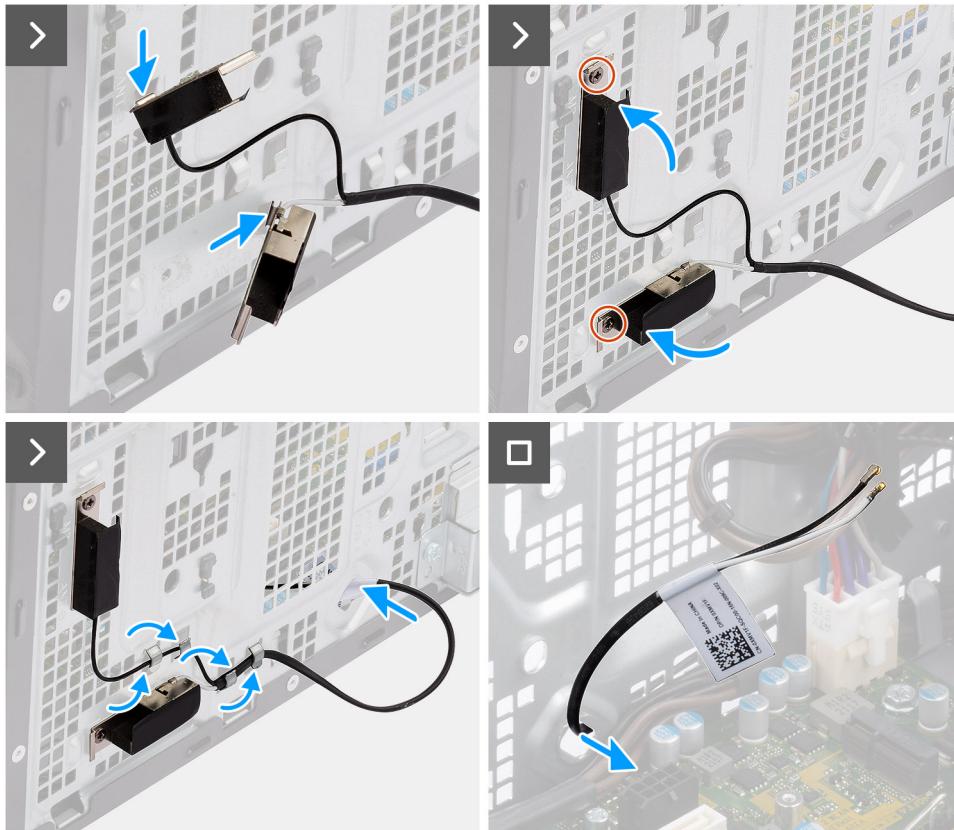

Figure 64. Installing the internal antenna module



**Figure 65. Installing the internal antenna module**

**Steps**

1. Peel away the protective tape from the back of the internal antenna module.
2. Insert the tabs on the internal antennas in the slots on the chassis.

**Table 29. Antenna-cable color scheme**

Chassis Label	Antenna-cable color
ANT-W	White
ANT-B	Black

3. Replace the two screws (M3x3) to secure the internal antenna module to the chassis.
4. Route the internal-antenna cable through the routing guide on the chassis.
5. Thread the internal-antenna cable through the slot on the chassis.

**Next steps**

1. Install the [wireless card](#).
2. Install the [front bezel](#).
3. Install the [side cover](#).
4. Follow the procedure in [After working inside your computer](#).

## External SMA antenna module

### Removing the external SMA antenna module

**CAUTION:** The information in this removal section is intended for authorized service technicians only.

### Prerequisites

1. Follow the procedure in [Before working inside your computer](#).
2. Remove the [side cover](#).
3. Remove the [external puck antenna](#).
4. Remove the [wireless card](#).

### About this task

**NOTE:** This step applies only to computers shipped with an optional external SMA antenna installed.

The following images indicate the location of the external SMA antenna module and provide a visual representation of the removal procedure.

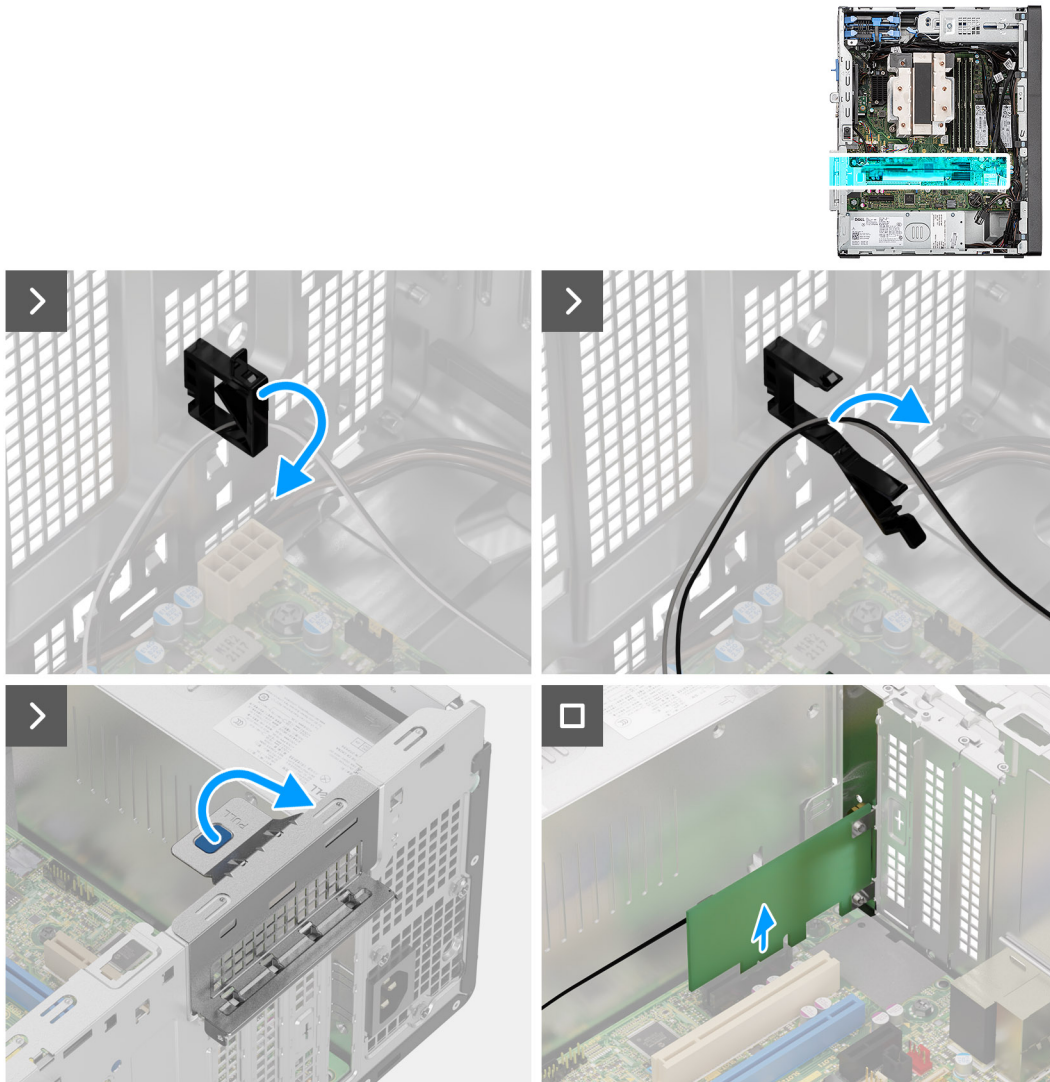
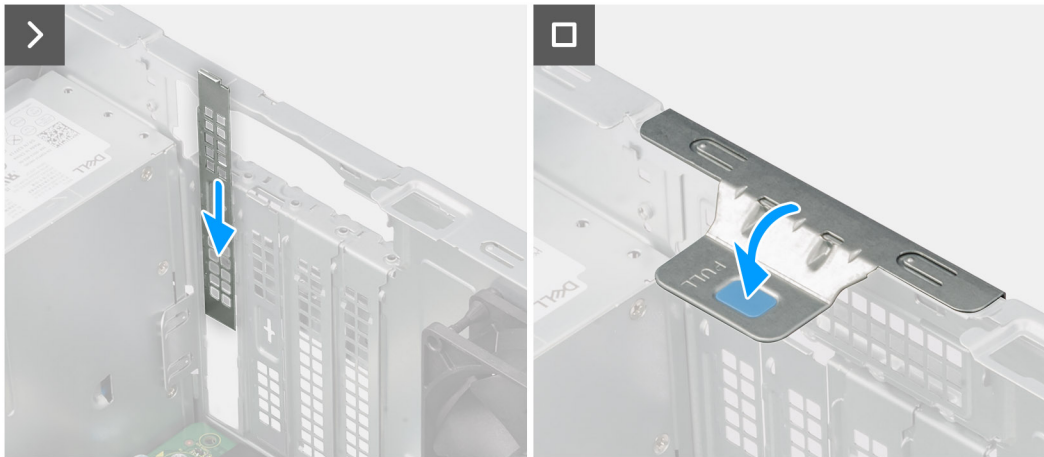

Figure 66. Removing the external SMA antenna module



**Figure 67. Removing the external SMA antenna module**

### Steps

1. Open the retention clip and remove the external SMA antenna-module cable from the retention clip on the chassis.
2. Lift the pull tab on the PCIe door outwards to open the PCIe door.
3. Gently remove the external SMA antenna module from the PCIe card connector (SLOT4) on the system board.
4. Align and slide the PCIe blanking plate in the slot on the chassis.

**NOTE:** Do not perform this step if you are immediately replacing the external SMA antenna module with a new PCIe card.

5. Close the PCIe door and press it gently until it clicks in place on the chassis.

**NOTE:** Do not perform this step if you are immediately replacing the external SMA antenna module with a new PCIe card.

## Installing the external SMA antenna module

**CAUTION:** The information in this installation section is intended for authorized service technicians only.

### Prerequisites

If you are replacing a component, remove the existing component before performing the installation procedure.

### About this task

The following images indicate the location of the external SMA antenna module and provide a visual representation of the installation procedure.



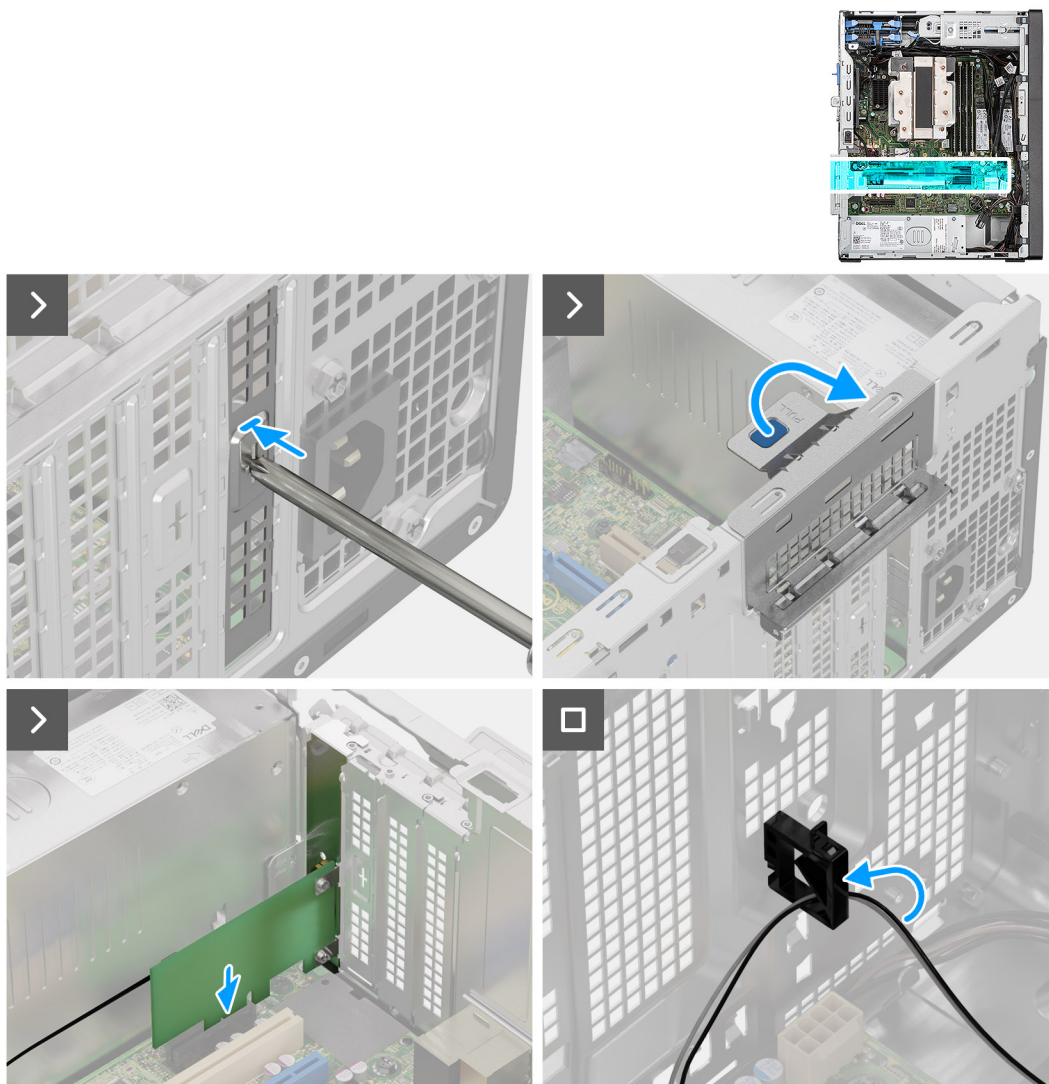

Figure 68. Installing the external SMA antenna module

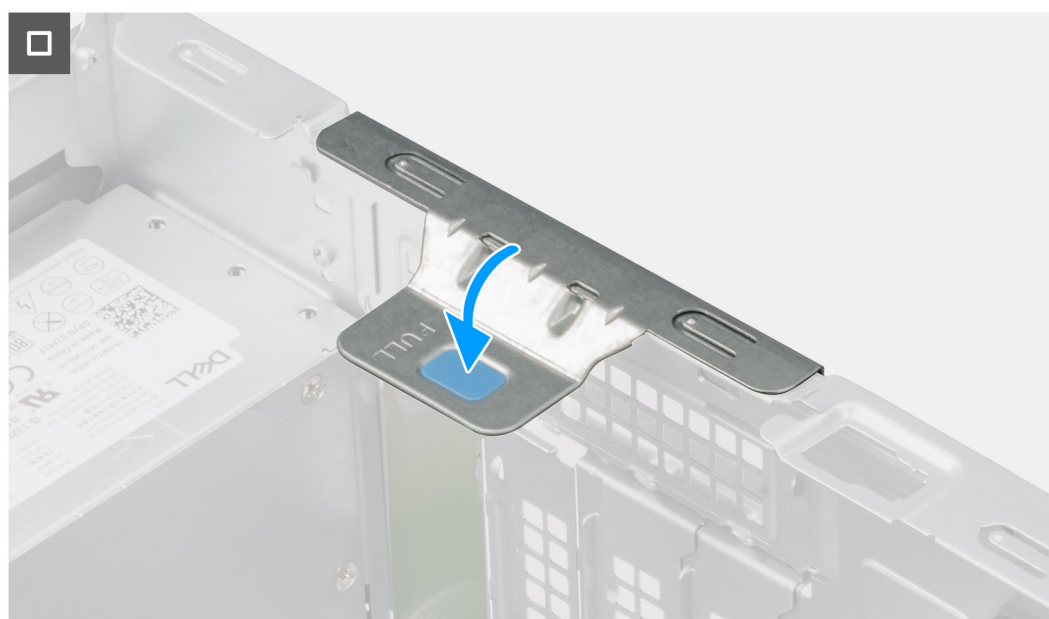







Figure 69. Installing the external SMA antenna module

## Steps

1. Using a screwdriver, remove the fixed PCIe blanking plate from the chassis.
  -  **NOTE:** This step is applicable only when the external SMA antenna module is being installed for the first time.
  -  **NOTE:** To remove the fixed PCIe blanking plate, insert a flat-head screwdriver in the hole of the cover, push the blanking plate to release it, and then lift the blanking plate off the chassis.
  -  **NOTE:** Ensure to keep the PCIe blanking plate safe for future use.
2. Lift the pull tab on the PCIe door outwards to open the PCIe door.
3. Remove the PCIe blanking plate from the slots on the chassis.
  -  **NOTE:** This step is applicable only when the external SMA antenna module is not being installed for the first time.
  -  **NOTE:** Ensure to keep the PCIe blanking plate safe for future use.
4. Align the notch on the external SMA antenna module with the tab on the PCIe card connector (SLOT4) on the system board.
5. Gently press down on the external SMA antenna module to connect it to the PCIe card connector on the system board.
6. Close the PCIe door and press it gently until it clicks in place on the chassis, to secure the external SMA antenna module.
7. Open the retention clip, route the external SMA antenna-module cables through the retention clip and close the clip to secure the cables.

## Next steps

1. Install the [wireless card](#).
2. Install the [external puck antenna](#).
3. Install the [side cover](#).
4. Follow the procedure in [After working inside your computer](#).

# Processor fan and heat-sink assembly

## Removing the processor fan and heat-sink assembly (for 65 W processors)

 **CAUTION:** The information in this removal section is intended for authorized service technicians only.

### Prerequisites

1. Follow the procedure in [Before working inside your computer](#).
2. Remove the [side cover](#).

### About this task

 **WARNING:** The processor fan and heat-sink assembly may become hot during normal operation. Allow sufficient time for the processor fan and heat-sink assembly to cool before you touch it.

 **CAUTION:** For maximum cooling of the processor, do not touch the heat transfer areas on the heat sink. The oils in your skin can reduce the heat transfer capability of the thermal grease.

The following images indicate the location of the processor fan and heat-sink assembly and provide a visual representation of the removal procedure.

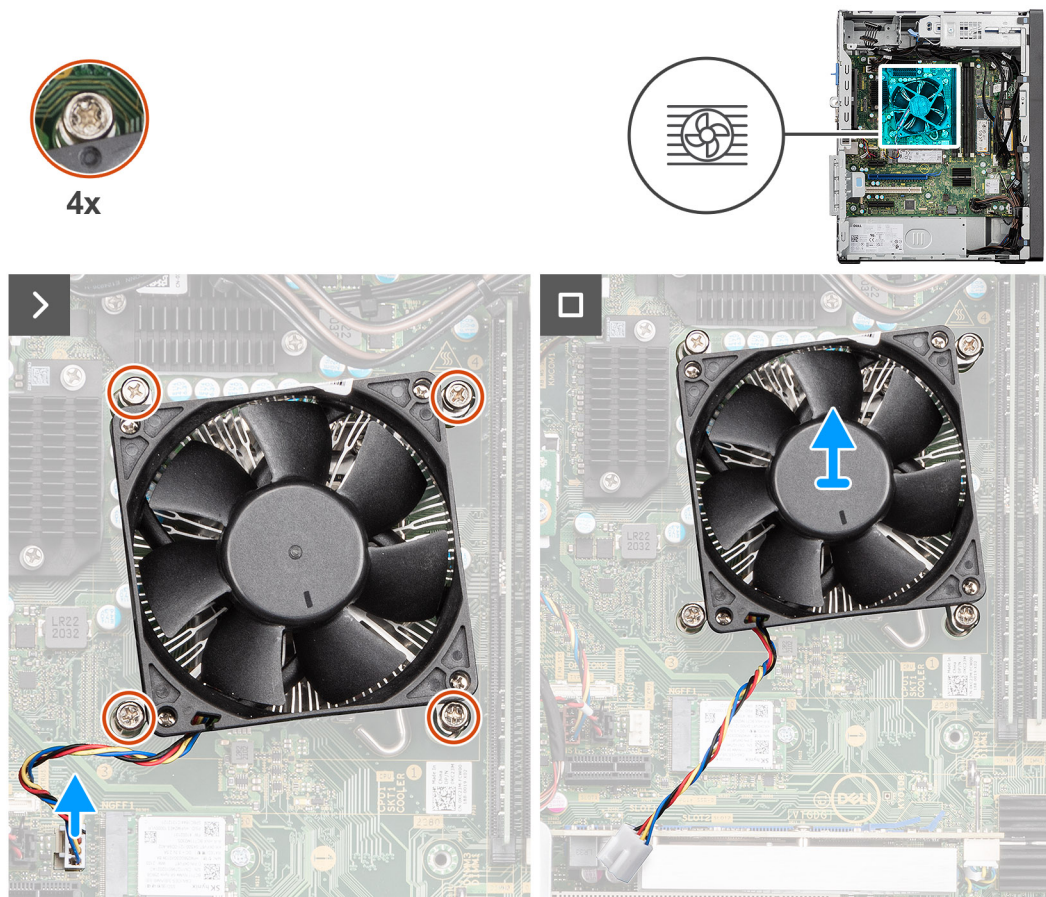

**Figure 70. Removing the processor fan and heat-sink assembly (for 65 W processors)**

### Steps

1. Disconnect the processor fan and heat-sink assembly cable from the connector (FAN CPU) on the system board.
2. In reverse sequential order (4 > 3 > 2 > 1) etched on the system board, loosen the four captive screws that secure the processor fan and heat-sink assembly to the system board.
3. Lift the processor fan and heat-sink assembly off the system board.

## Installing the processor fan and heat-sink assembly (for 65 W processors)

**CAUTION:** The information in this installation section is intended for authorized service technicians only.

### Prerequisites

If you are replacing a component, remove the existing component before performing the installation procedure.

### About this task

**NOTE:** If either the processor or the heat sink is replaced, use the thermal grease that is provided in the kit to ensure that thermal conductivity is achieved.

The following images indicate the location of the processor fan and heat-sink assembly and provide a visual representation of the installation procedure.

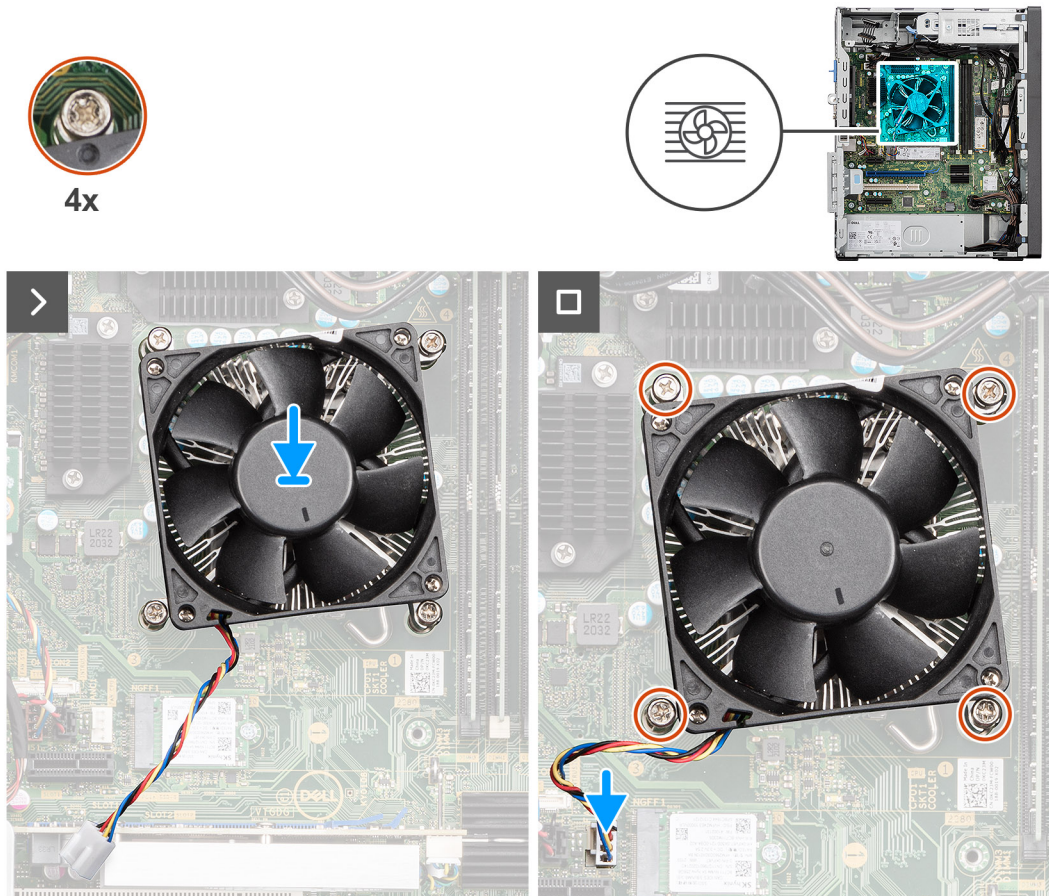

**Figure 71. Installing the processor fan and heat-sink assembly (for 65 W processors)**

#### Steps

1. Align the screw holes on the processor fan and heat-sink assembly with the screw holes on the system board.
2. Place the processor fan and heat-sink assembly on the processor.
3. In the sequential order (1 > 2 > 3 > 4) etched on the system board, tighten the four captive screws to secure the processor fan and heat-sink assembly to the system board.
4. Connect the processor fan and heat-sink assembly cable to the connector (FAN CPU) on the system board.

#### Next steps

1. Install the [side cover](#).
2. Follow the procedure in [After working inside your computer](#).

## Removing the processor fan and heat-sink assembly (for 125 W processors)

**CAUTION:** The information in this removal section is intended for authorized service technicians only.

#### Prerequisites

1. Follow the procedure in [Before working inside your computer](#).
2. Remove the [side cover](#).

### About this task

**WARNING:** The processor fan and heat-sink assembly may become hot during normal operation. Allow sufficient time for the processor fan and heat-sink assembly to cool before you touch it.

**CAUTION:** For maximum cooling of the processor, do not touch the heat transfer areas on the processor fan and heat-sink assembly. The oils in your skin can reduce the heat transfer capability of the thermal grease.

The following images indicate the location of the processor fan and heat-sink assembly and provide a visual representation of the removal procedure.

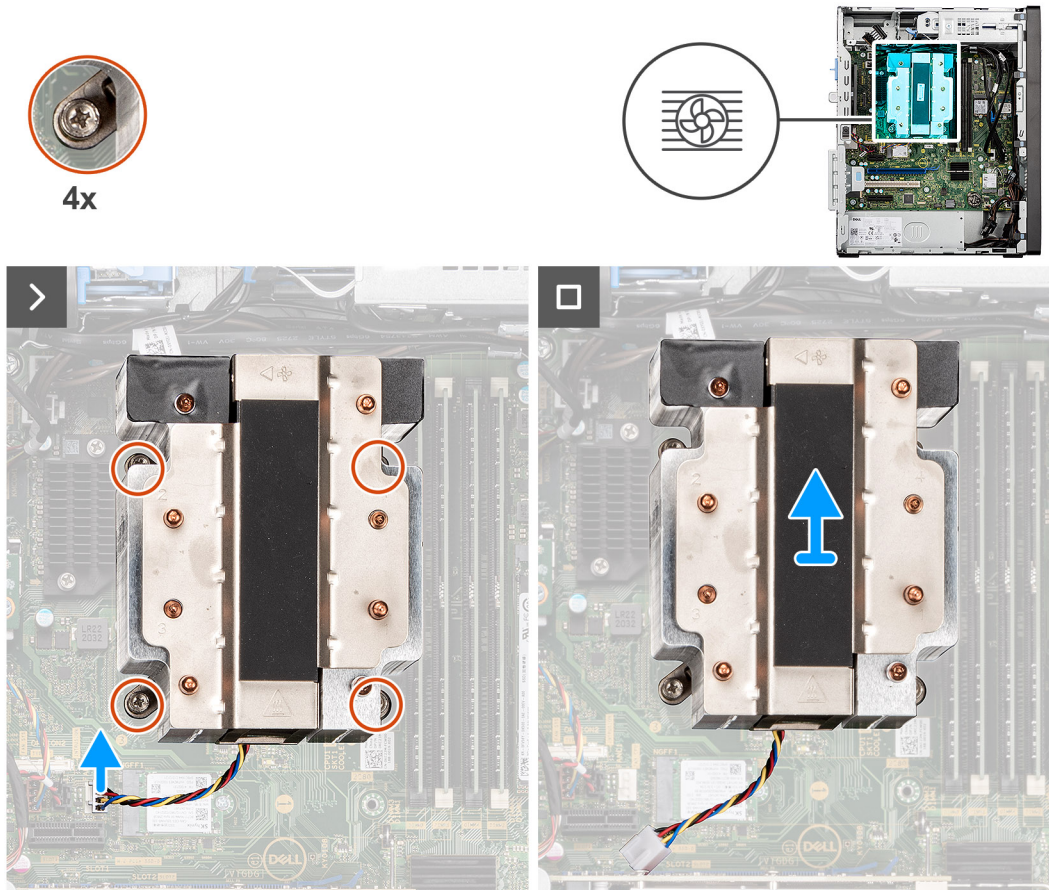

Figure 72. Removing the processor fan and heat-sink assembly (for 125 W processors)

### Steps

1. Disconnect the processor fan and heat-sink assembly cable from the connector (FAN CPU) on the system board.
2. In the reverse sequential order (4 > 3 > 2 > 1) etched on the heat-sink assembly, loosen the four captive screws that secure the processor fan and heat-sink assembly to the system board.
3. Lift the processor fan and heat-sink assembly off the system board.

## Installing the processor fan and heat-sink assembly (for 125 W processors)

**CAUTION:** The information in this installation section is intended for authorized service technicians only.

### Prerequisites

If you are replacing a component, remove the existing component before performing the installation procedure.

### About this task

**NOTE:** If either the processor or the heat sink is replaced, use the thermal grease that is provided in the kit to ensure that thermal conductivity is achieved.

The following images indicate the location of the processor fan and heat-sink assembly and provide a visual representation of the installation procedure.

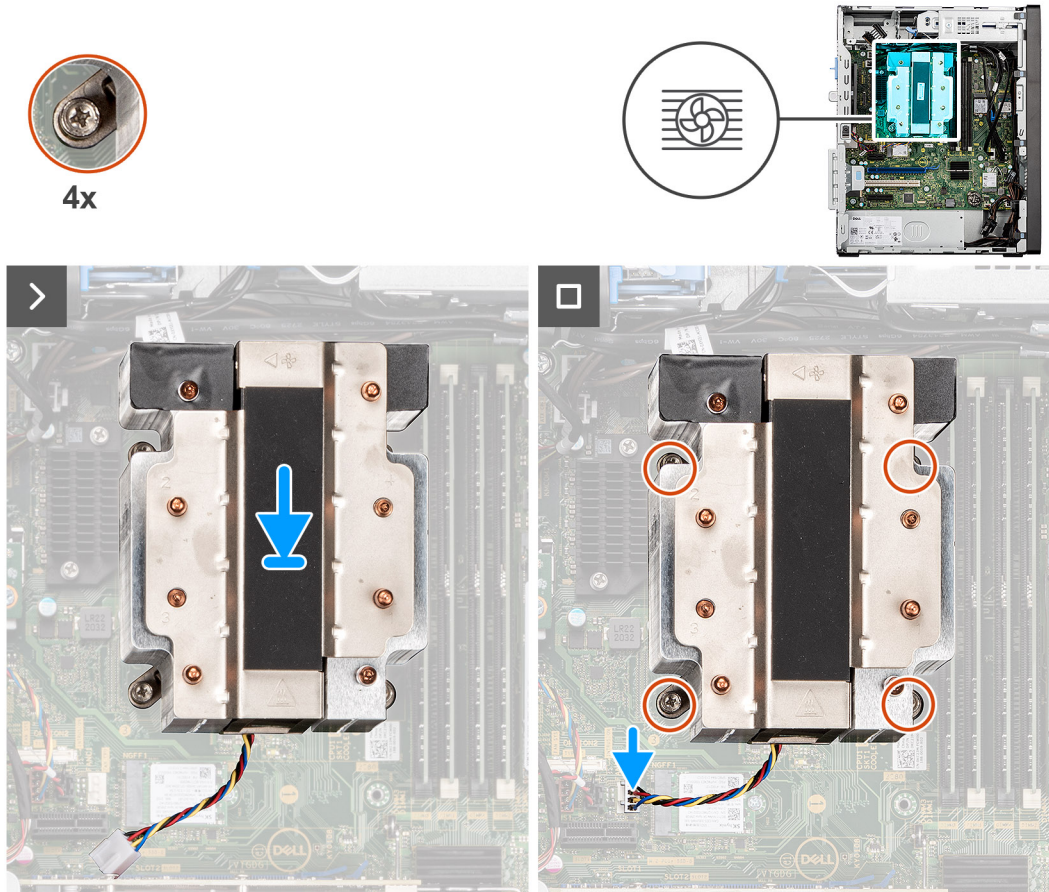

**Figure 73. Installing the processor fan and heat-sink assembly (for 125 W processors)**

### Steps

1. Align the screw holes on the processor fan and heat-sink assembly to the screw holes on the system board.
2. Place the processor fan and heat-sink assembly on the processor.
3. In the sequential order (1 > 2 > 3 > 4) etched on the heat-sink assembly, tighten the four captive screws to secure the processor fan and heat-sink assembly to the system board.
4. Connect the processor fan and heat-sink assembly cable to the connector (FAN CPU) on the system board.

### Next steps

1. Install the [side cover](#).
2. Follow the procedure in [After working inside your computer](#).

## Power-supply unit

### Removing the power-supply unit

**CAUTION:** The information in this removal section is intended for authorized service technicians only.

### Prerequisites

1. Follow the procedure in [Before working inside your computer](#).
  2. Remove the [side cover](#).
  3. Remove the [processor fan and heat-sink assembly](#) (for 125 W processors).
-  **NOTE:** This procedure applies only to computers shipped with 125 W processors.

### About this task

The following images indicate the location of the power-supply unit and provide a visual representation of the removal procedure.

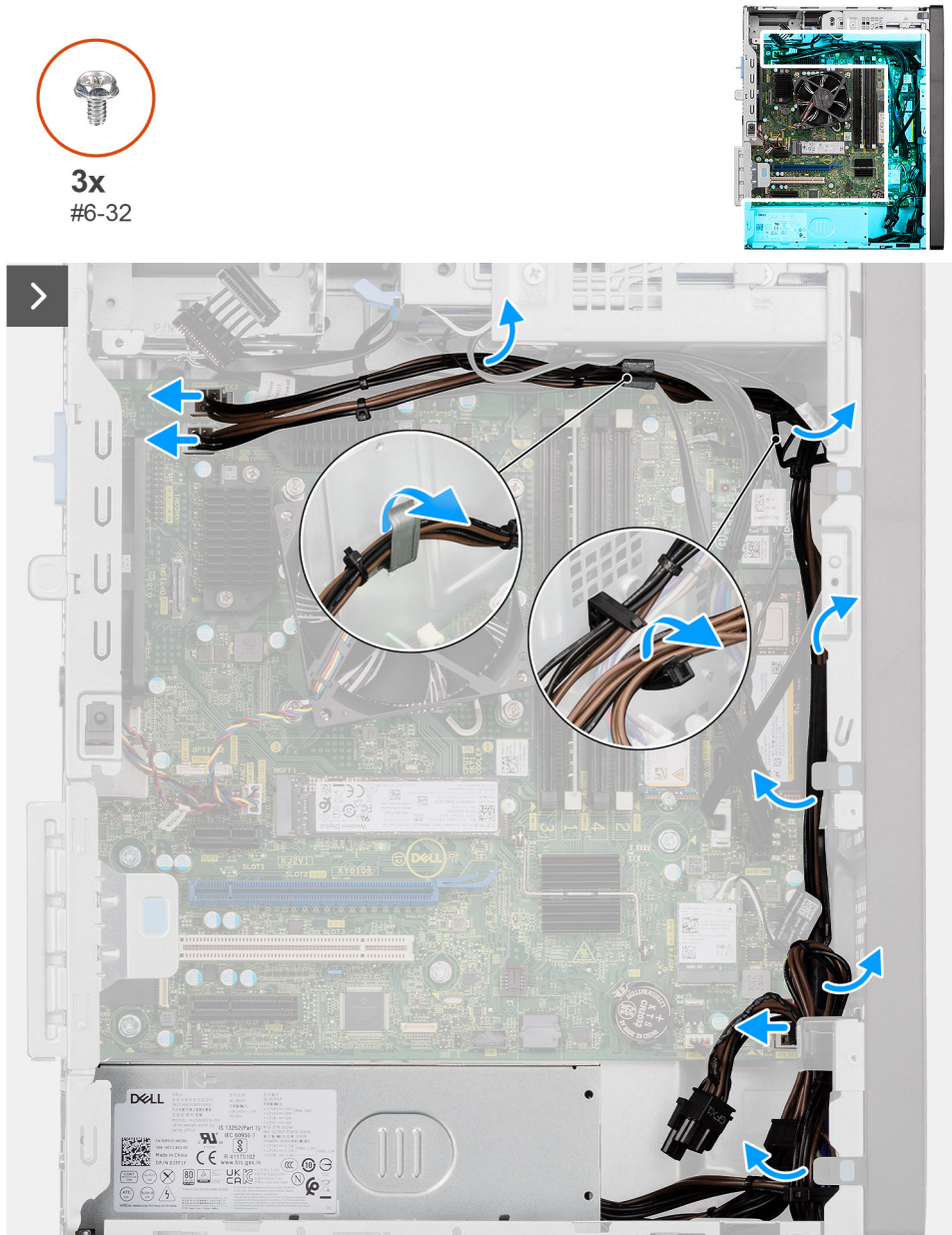
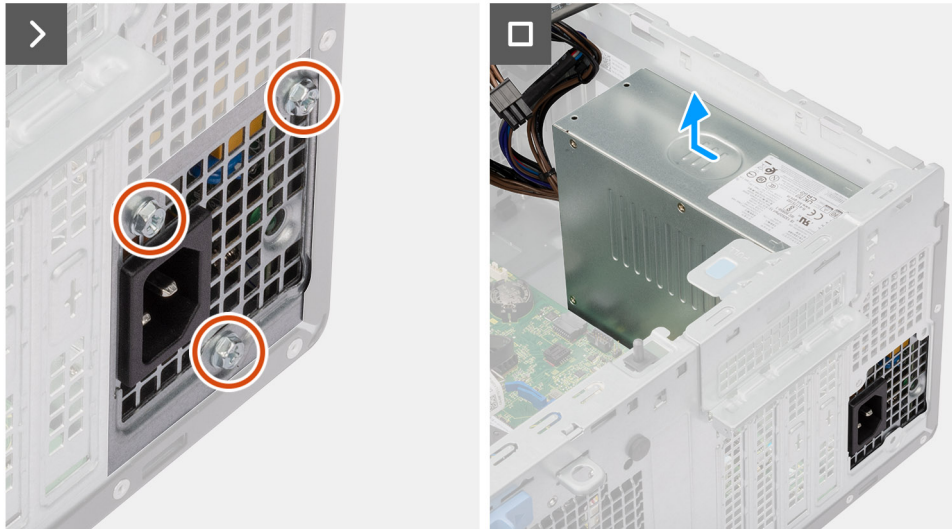

Figure 74. Removing the power-supply unit



**Figure 75. Removing the power-supply unit**

### Steps

1. Disconnect the power-supply unit cables from the connectors (ATX CPU1, ATX CPU2, and ATX SYS) on the system board.
2. Open the retention clips that secure the power-supply unit cables to the chassis.
3. Remove the power-supply unit cables from the routing guides on the chassis.
4. Remove the three screws (#6-32) that secure the power-supply unit to the chassis.
5. Slide and lift the power-supply unit off the chassis.

## Installing the power-supply unit

**CAUTION:** The information in this installation section is intended for authorized service technicians only.

### Prerequisites

If you are replacing a component, remove the existing component before performing the installation procedure.

### About this task

The following images indicate the location of the power-supply unit and provide a visual representation of the installation procedure.





**3x**  
#6-32



**Figure 76. Installing the power-supply unit**

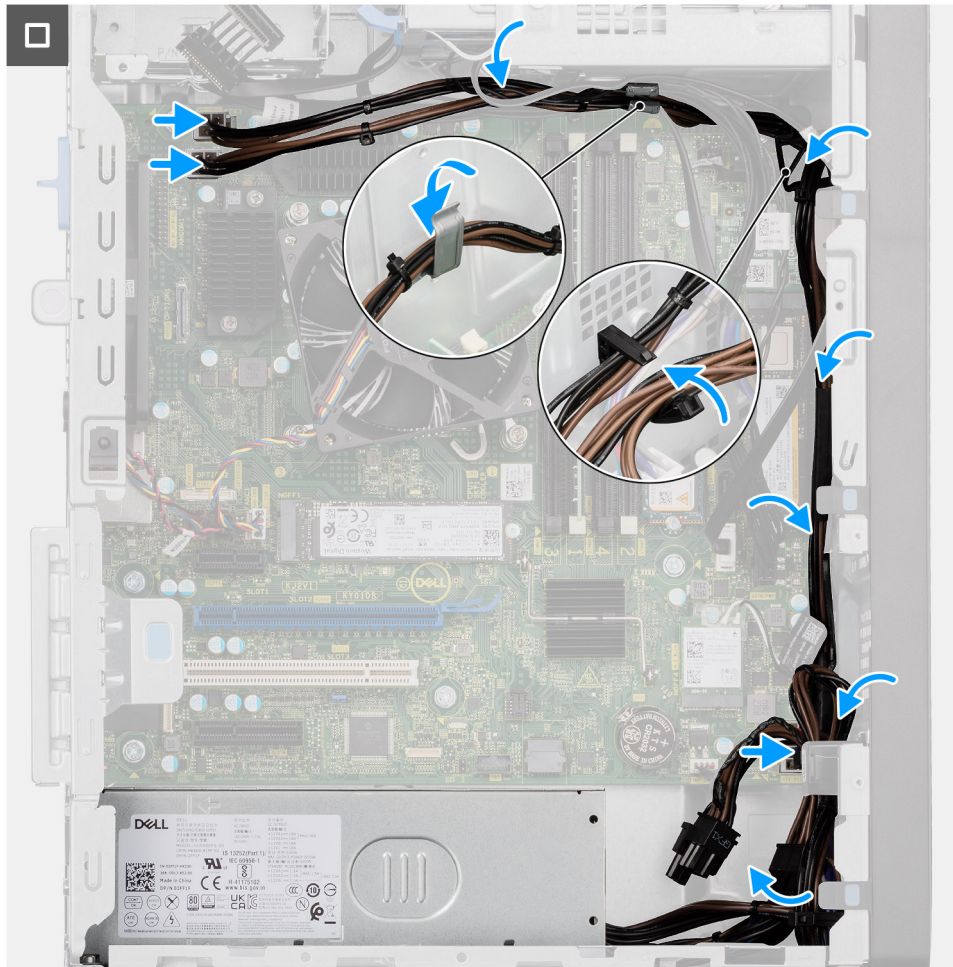

**Figure 77. Installing the power-supply unit**

**Steps**

1. Place the power-supply unit near the slot on the chassis and slide it towards the back of the chassis.
2. Align the screw holes on the power-supply unit with the screw holes on the chassis.
3. Replace the three screws (#6-32) to secure the power-supply unit to the chassis.
4. Route the power-supply unit cables through the routing guides on the chassis.
5. Close the retention clips to secure the power-supply cables to the chassis.
6. Connect the power-supply cables to the connectors (ATX CPU1, ATX CPU2, and ATX SYS) on the system board.

**Next steps**

1. Install the [processor fan and heat-sink assembly](#) (for 125 W processors).
  - i** **NOTE:** This procedure applies only to computers shipped with 125 W processors installed.
2. Install the [side cover](#).
3. Follow the procedure in [After working inside your computer](#).

## System fan

### Removing the system fan

**⚠ CAUTION:** The information in this removal section is intended for authorized service technicians only.

### Prerequisites

1. Follow the procedure in [Before working inside your computer](#).
2. Remove the [side cover](#).

### About this task

The following images indicate the location of the system fan and provide a visual representation of the removal procedure.

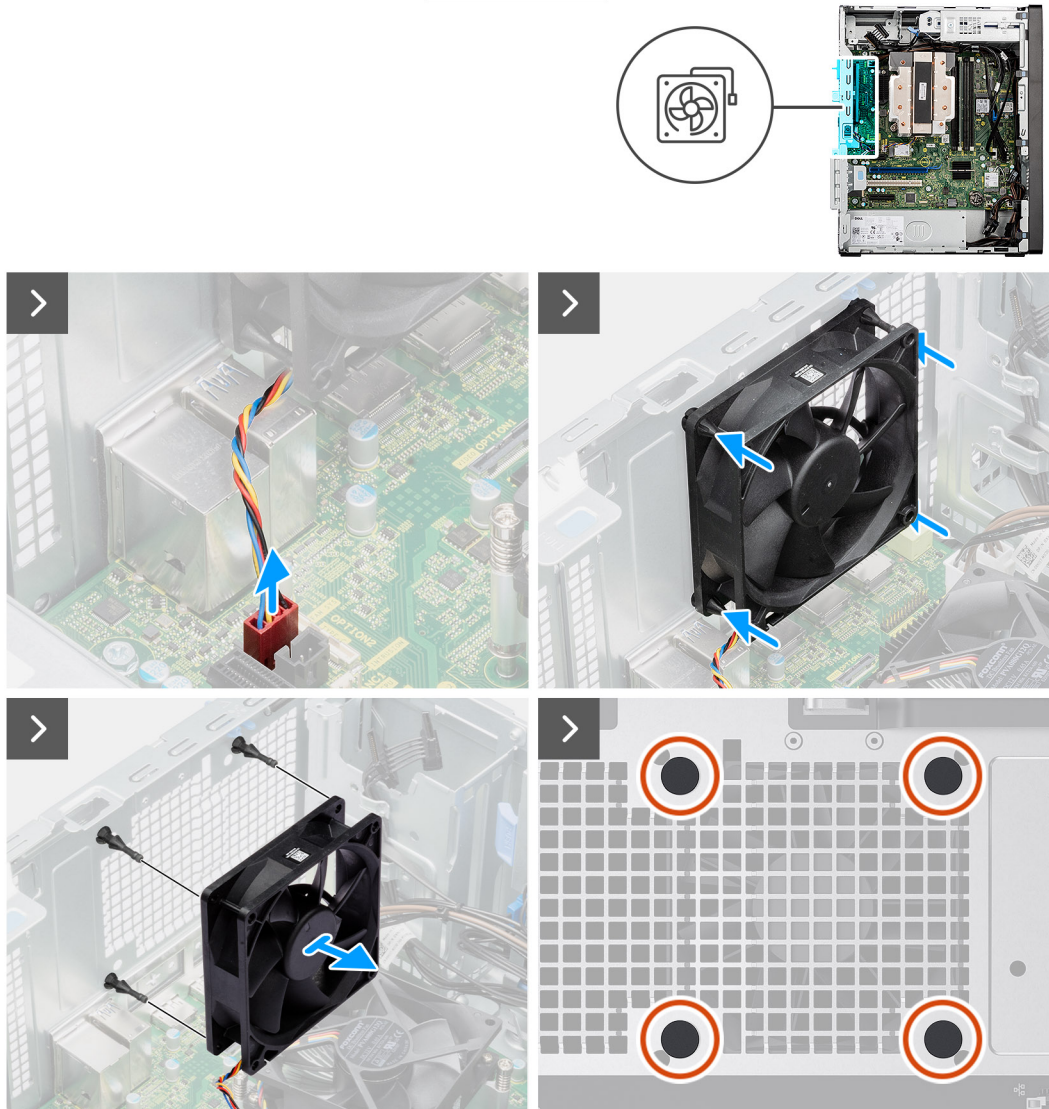

**Figure 78. Removing the system fan**

### Steps

1. Disconnect the system-fan cable from the connector (FAN SYS) on the system board.
2. Gently pull and release the system fan from the rubber grommets.
3. Remove the system fan from the chassis.

## Installing the system fan

**CAUTION:** The information in this installation section is intended for authorized service technicians only.

### Prerequisites

If you are replacing a component, remove the existing component before performing the installation procedure.

### About this task

The following images indicate the location of the system fan and provide a visual representation of the installation procedure.

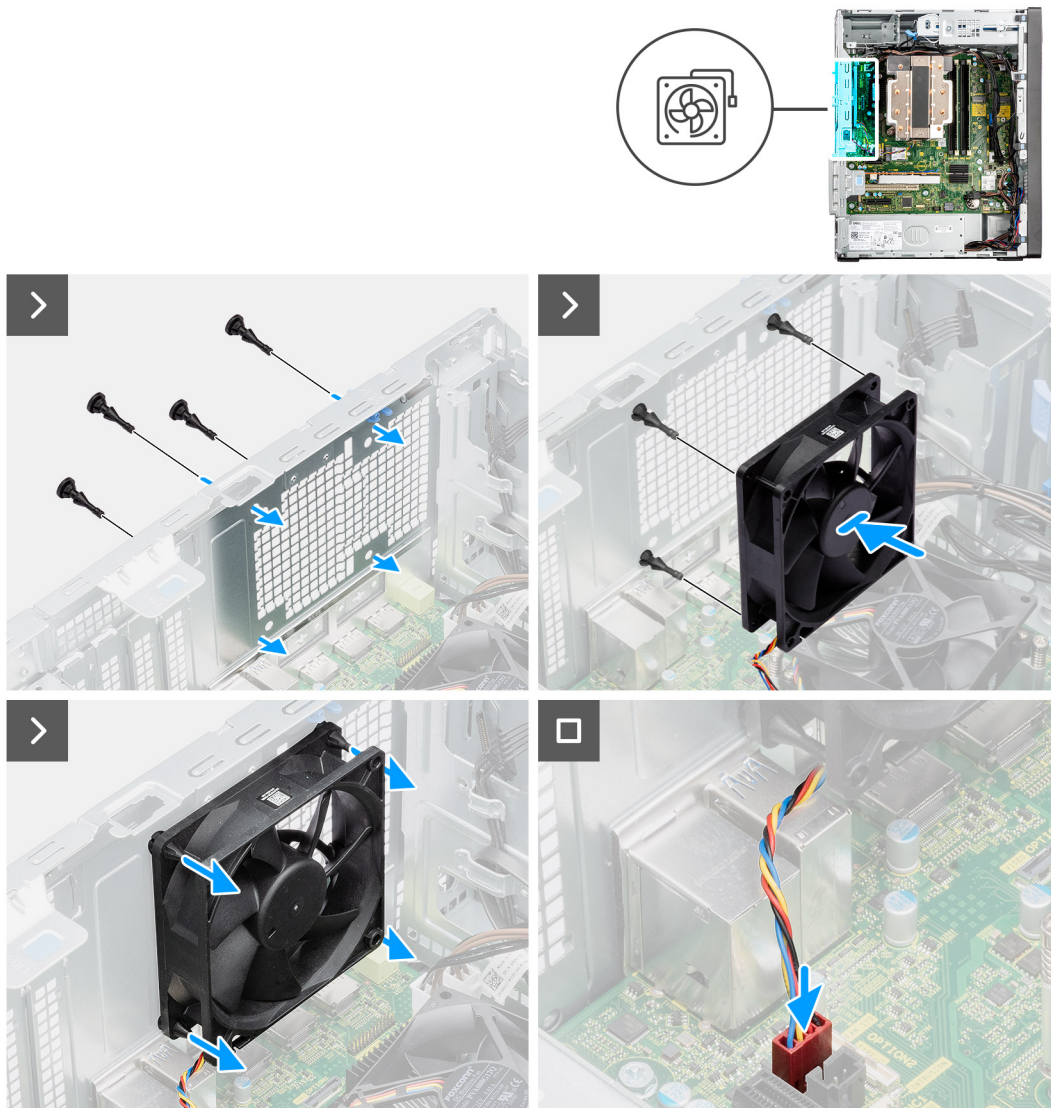

Figure 79. Installing the system fan

### Steps

1. Ensure that the rubber grommets are installed in the computer chassis.  
**NOTE:** Align and insert the rubber grommets through the holes on the chassis to install the rubber grommets in the computer chassis.
2. Align the holes on the system fan to the rubber grommets on the chassis.
3. Insert the rubber grommets through the holes on the system fan.
4. Pull the rubber grommets and push the system fan towards the chassis until it fits in place.
5. Connect the system-fan cable to the connector (FAN SYS) on the system board.

### Next steps

1. Install the [side cover](#).
2. Follow the procedure in [After working inside your computer](#).

# Processor

## Removing the processor

**CAUTION:** The information in this removal section is intended for authorized service technicians only.

### Prerequisites

1. Follow the procedure in [Before working inside your computer](#).
2. Remove the [side cover](#).
3. Remove the [processor fan and heat-sink assembly \(for 65 W processors\)](#) or the [processor fan and heat-sink assembly \(for 125 W processors\)](#), whichever is applicable.

### About this task

**NOTE:** The processor may still be hot after the computer is shut down. Allow the processor to cool down before removing it.

The following images indicate the location of the processor and provide a visual representation of the removal procedure.

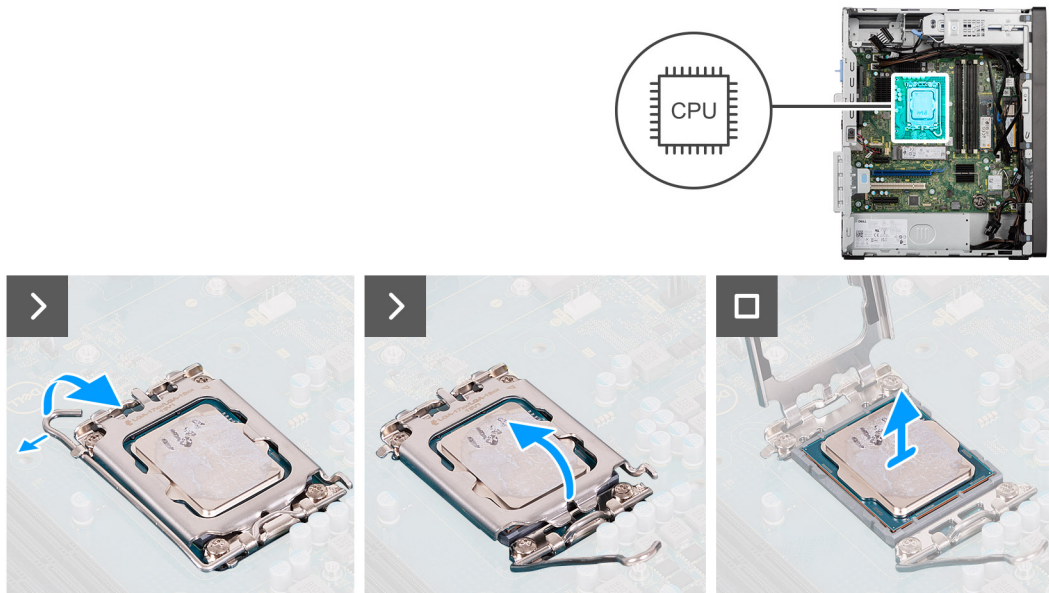

Figure 80. Removing the processor

### Steps

1. Press down and push the release lever away from the processor to release it from the securing tab.
2. Lift the lever upward and lift open the processor cover.
3. Gently remove the processor from the processor socket (CPU).

**CAUTION:** When removing the processor, do not touch any of the pins inside the socket or allow any objects to fall on the pins in the socket.

## Installing the processor

**CAUTION:** The information in this installation section is intended for authorized service technicians only.

## Prerequisites

If you are replacing a component, remove the existing component before performing the installation procedure.

## About this task

The following images indicate the location of the processor and provide a visual representation of the installation procedure.

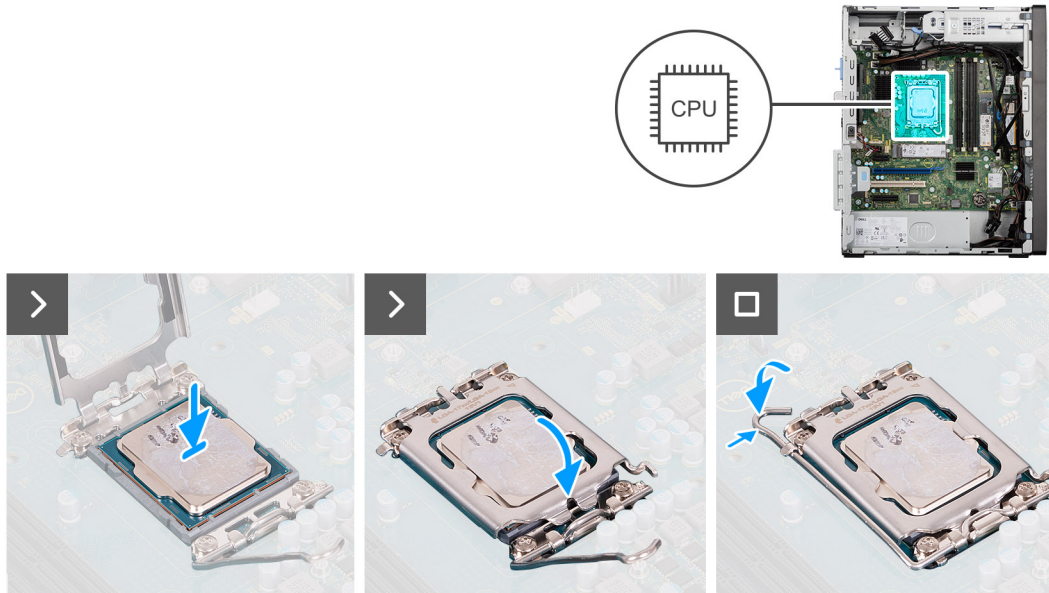

Figure 81. Installing the processor

## Steps

1. Ensure that the release lever and processor cover, on the processor socket (CPU), are fully extended in the open position.
2. Align the notches on the processor with the tabs on the processor socket and place the processor in the processor socket.  
**i** **NOTE:** The pin-1 corner of the processor has a triangle that aligns with the triangle on the pin-1 corner on the processor socket. When the processor is properly seated, all four corners are aligned at the same height. If one or more corners of the processor are higher than the others, the processor is not seated properly. Remove the processor and reinstall it.
3. When the processor is fully seated in the socket, close the processor cover over the processor socket.
4. Pivot the release-lever down and place it under the securing tab on the processor cover.

## Next steps

1. Install the [processor fan and heat-sink assembly \(for 65 W processors\)](#) or the [processor fan and heat-sink assembly \(for 125 W processors\)](#), whichever applicable.
2. Install the [side cover](#).
3. Follow the procedure in [After working inside your computer](#).

# Voltage-regulator heat sink

## Removing the voltage-regulator heat sink

**⚠ CAUTION:** The information in this removal section is intended for authorized service technicians only.

## Prerequisites

1. Follow the procedure in [Before working inside your computer](#).
2. Remove the [side cover](#).
3. Remove the [processor fan and heat-sink assembly \(for 125 W processors\)](#).

**NOTE:** This procedure applies only to computers shipped with 125 W processors installed.

#### About this task

**WARNING:** The voltage-regulator heat sink may become hot during normal operation. Allow sufficient time for the voltage-regulator heat sink to cool before you touch it.

**CAUTION:** For maximum cooling of the processor, do not touch the heat transfer areas on the voltage-regulator heat sink. The oils in your skin can reduce the heat transfer capability of the thermal grease.

The following images indicate the location of the voltage-regulator heat sink and provide a visual representation of the removal procedure.

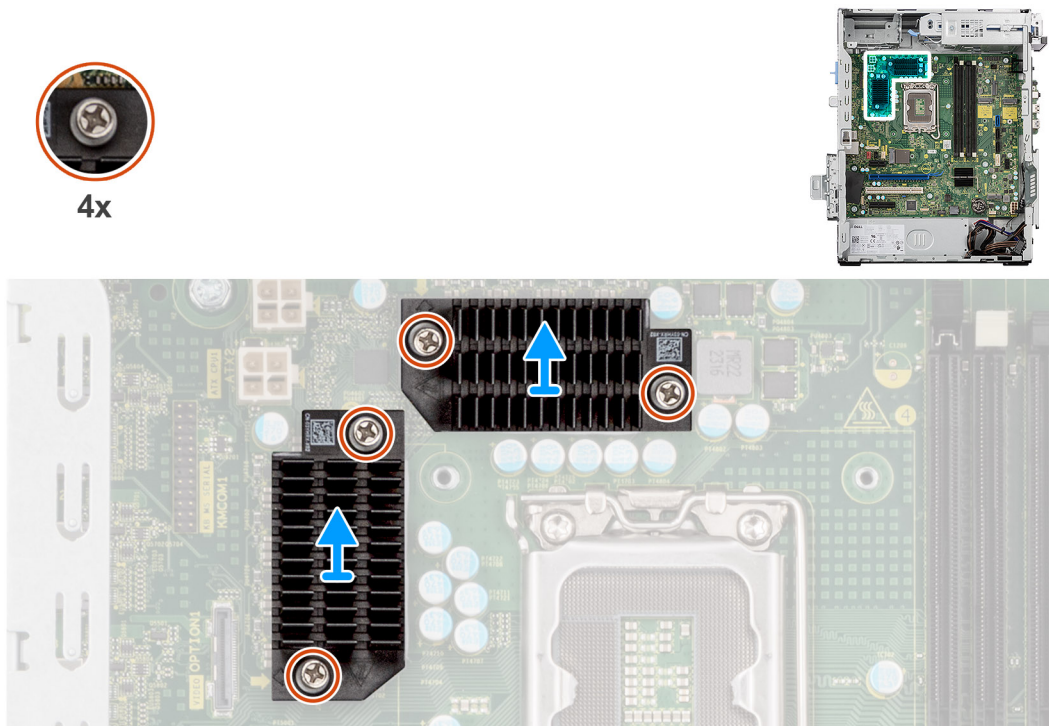

**Figure 82. Removing the voltage-regulator heat sink**

#### Steps

1. Loosen the four captive screws that secure the voltage-regulator heat sinks to the system board.
2. Lift the two voltage-regulator heat sinks off the system board.

## Installing the voltage-regulator heat sink

**CAUTION:** The information in this installation section is intended for authorized service technicians only.

#### Prerequisites

If you are replacing a component, remove the existing component before performing the installation procedure.

#### About this task

The following images indicate the location of the voltage-regulator heat sink and provide a visual representation of the installation procedure.



4x

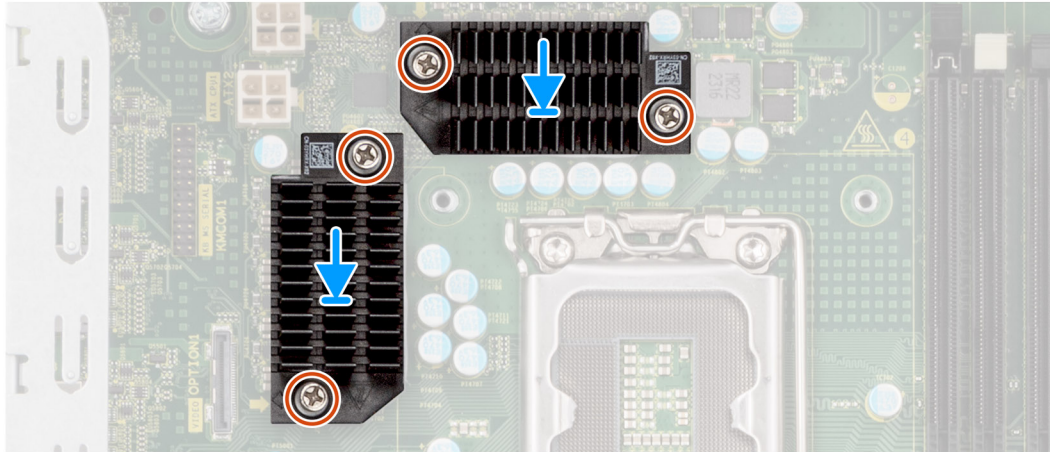
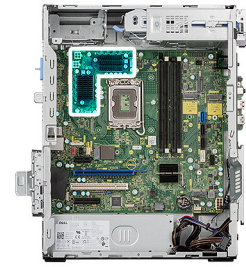

**Figure 83. Installing the voltage-regulator heat sink**

#### Steps

1. Align the screw holes on the voltage-regulator heat sinks to the screw holes on the system board.
2. Tighten the four captive screws to secure the voltage-regulator heat sinks to the system board.

#### Next steps

1. Install the [processor fan and heat-sink assembly](#) (for 125 W processors).  
**NOTE:** This procedure applies only to computers shipped with 125 W processors installed.
2. Install the [side cover](#).
3. Follow the procedure in [After working inside your computer](#).

## Optional I/O modules

### Optional serial module

#### Removing the optional serial module

**CAUTION:** The information in this removal section is intended for authorized service technicians only.

#### Prerequisites

1. Follow the procedure in [Before working inside your computer](#).
2. Remove the [side cover](#).

#### About this task

The following images indicate the location of the optional serial module and provide a visual representation of the removal procedure.





2x  
M3

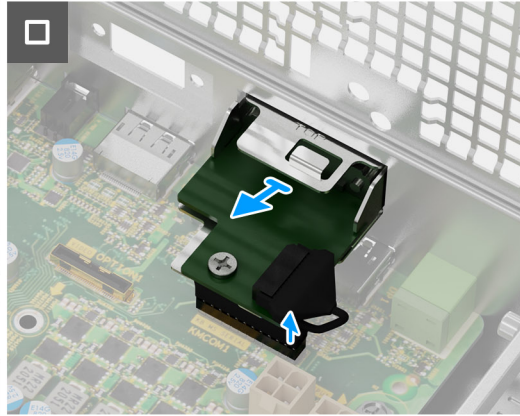
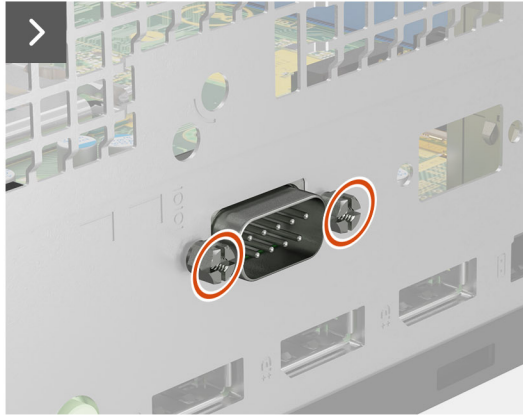

**Figure 84. Removing the optional serial module**

#### Steps

1. Remove the two screws (M3) that secure the optional serial module to the chassis.
2. Disconnect the optional serial module cable from the connector (KB MS SERIAL) on the system board.
3. Slide the optional serial module out of the port opening and lift the optional serial module off the system board.

## Installing the optional serial module

**CAUTION:** The information in this installation section is intended for authorized service technicians only.

#### Prerequisites

If you are replacing a component, remove the existing component before performing the installation procedure.

#### About this task

The following images indicate the location of the optional serial module and provide a visual representation of the installation procedure.



2x  
M3

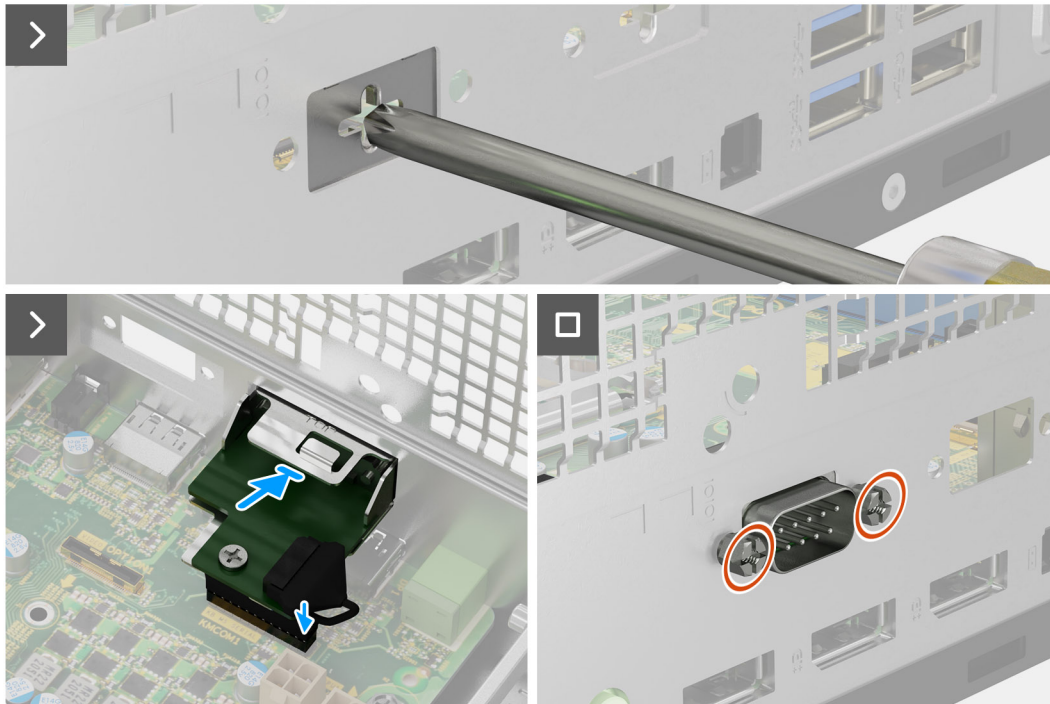

**Figure 85. Installing the optional serial module**

### Steps

1. Using a screwdriver, remove the optional-module cover from the chassis.
  - NOTE:** This step is applicable only when the optional serial module is being installed for the first time.
  - NOTE:** To remove the optional-module cover, insert a flat-head screwdriver in the hole of the cover, push the cover to release it, and then lift the cover off the chassis.
2. Insert the optional serial module in the slot on the chassis.
3. Connect the serial-module cable to the connector (KB MS SERIAL) on the system board
4. Replace the two screws (M3) to secure the optional serial module to the chassis.

### Next steps

1. Install the [side cover](#).
2. Follow the procedure in [After working inside your computer](#).

## Optional PS2 and serial module

### Removing the optional PS2 and serial module

#### Prerequisites

1. Follow the procedure in [Before working inside your computer](#).

2. Remove the [side cover](#).

### About this task

The following images indicate the location of the PS2 and serial module and provide a visual representation of the removal procedure.

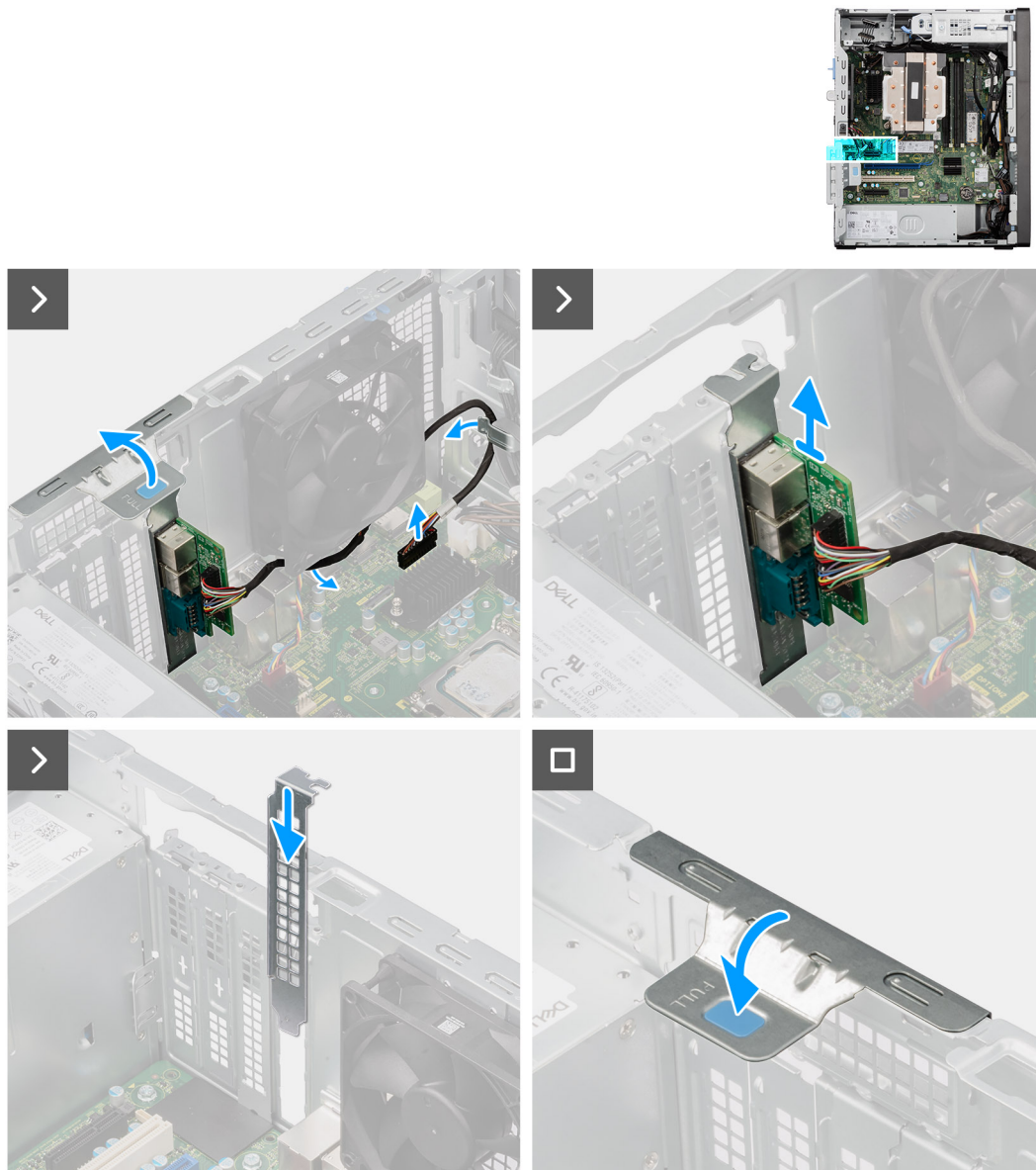

**Figure 86. Removing the optional PS2 and serial module**

### Steps

1. Lift the pull tab on the PCIe door outwards to open the PCIe door.
2. Disconnect the PS2 and serial module cable from the connector (KB MS SERIAL) on the system board.
3. Remove the PS2 and serial module cable from the routing guides on the chassis.
4. Remove the PS2 and serial module from the chassis.
5. Align and slide the PCIe blanking plate in the slot on the chassis.  
**(i) NOTE:** Do not perform this step if you are immediately replacing the serial module with a new PCIe card.
6. Close the PCIe door and press it gently until it clicks in place on the chassis.  
**(i) NOTE:** Do not perform this step if you are immediately replacing the serial module with a new PCIe card.

## Installing the optional PS2 and serial module

### Prerequisites

If you are replacing a component, remove the existing component before performing the installation procedure.

### About this task

The following images indicate the location of the PS2 and serial module and provide a visual representation of the installation procedure.

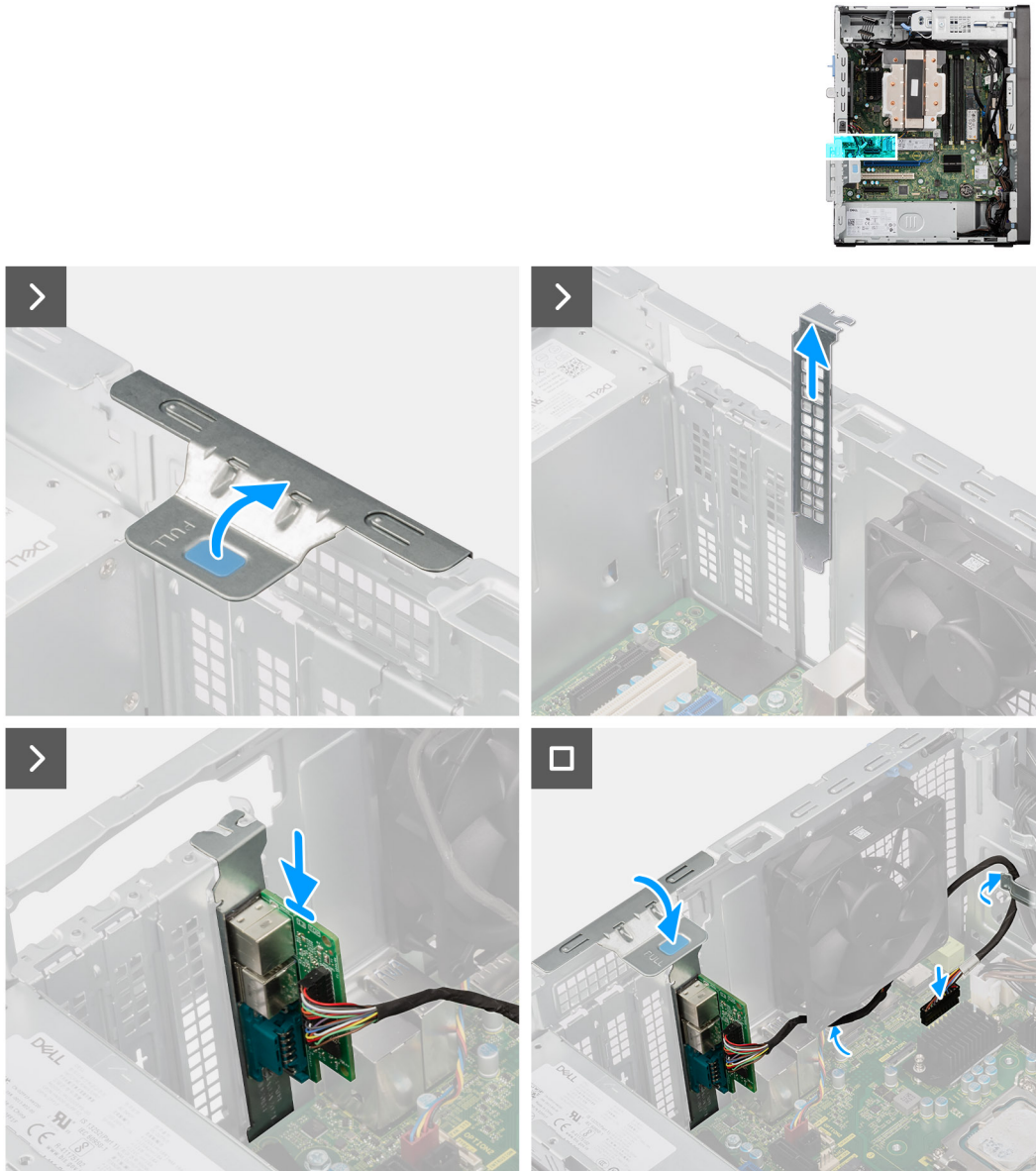

Figure 87. Installing the optional PS2 and serial module

### Steps

1. Lift the pull tab on the PCIe door outwards to open the PCIe door.
2. Remove the PCIe blanking plate from the slot on the chassis.  
**i** **NOTE:** Ensure to keep the PCIe blanking plate safe for future use.
3. Align and place the PS2 and serial module in the PCIe slot on the chassis.
4. Route the PS2 and serial module cable through the routing guides on the chassis.

5. Connect the PS2 and serial module cable to the connector (KB MS SERIAL) on the system board.
6. Close the PCIe door and press it gently until it clicks in place on the chassis, to secure the PS2 and serial module.

### Next steps

1. Install the [side cover](#).
2. Follow the procedure in [After working inside your computer](#).

## Optional HDMI module

### Removing the optional HDMI module

 **CAUTION:** The information in this removal section is intended for authorized service technicians only.

#### Prerequisites

1. Follow the procedure in [Before working inside your computer](#).
2. Remove the [side cover](#).

#### About this task

The following images indicate the location of the optional HDMI module and provide a visual representation of the removal procedure.

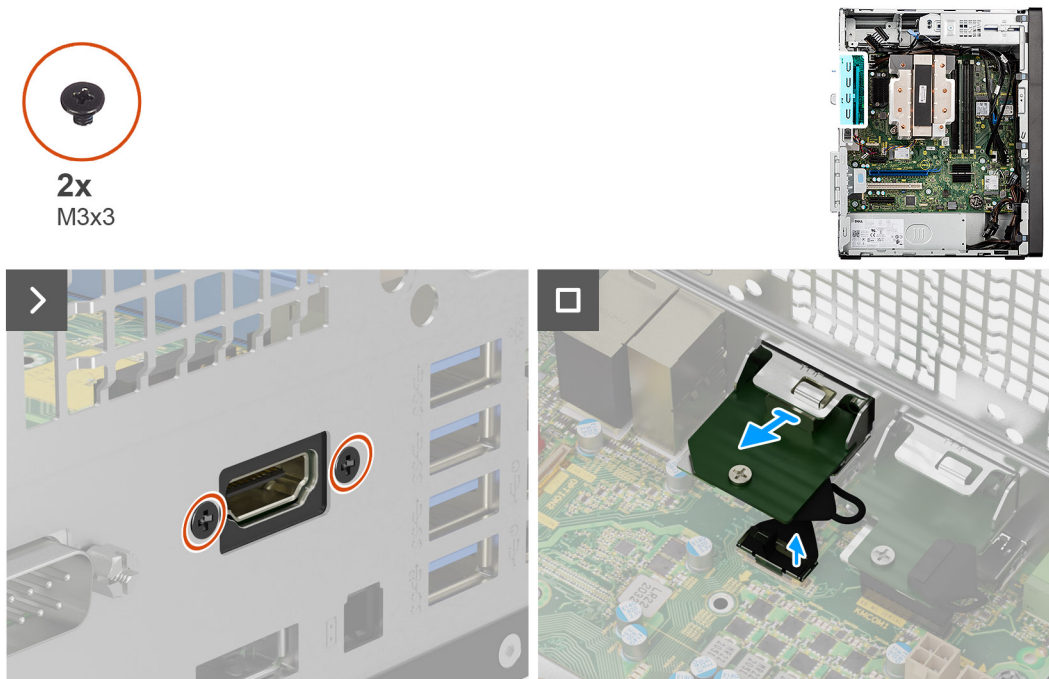

**Figure 88. Removing the optional HDMI module**

#### Steps

1. Remove the two screws (M3X3) that secure the optional HDMI module to the chassis.
2. Disconnect the optional HDMI-module cable from the connector (VIDEO) on the system board.
3. Lift the optional HDMI module off the system board.

### Installing the optional HDMI module

 **CAUTION:** The information in this installation section is intended for authorized service technicians only.

## Prerequisites

If you are replacing a component, remove the existing component before performing the installation procedure.

## About this task

The following images indicate the location of the optional HDMI module and provide a visual representation of the installation procedure.

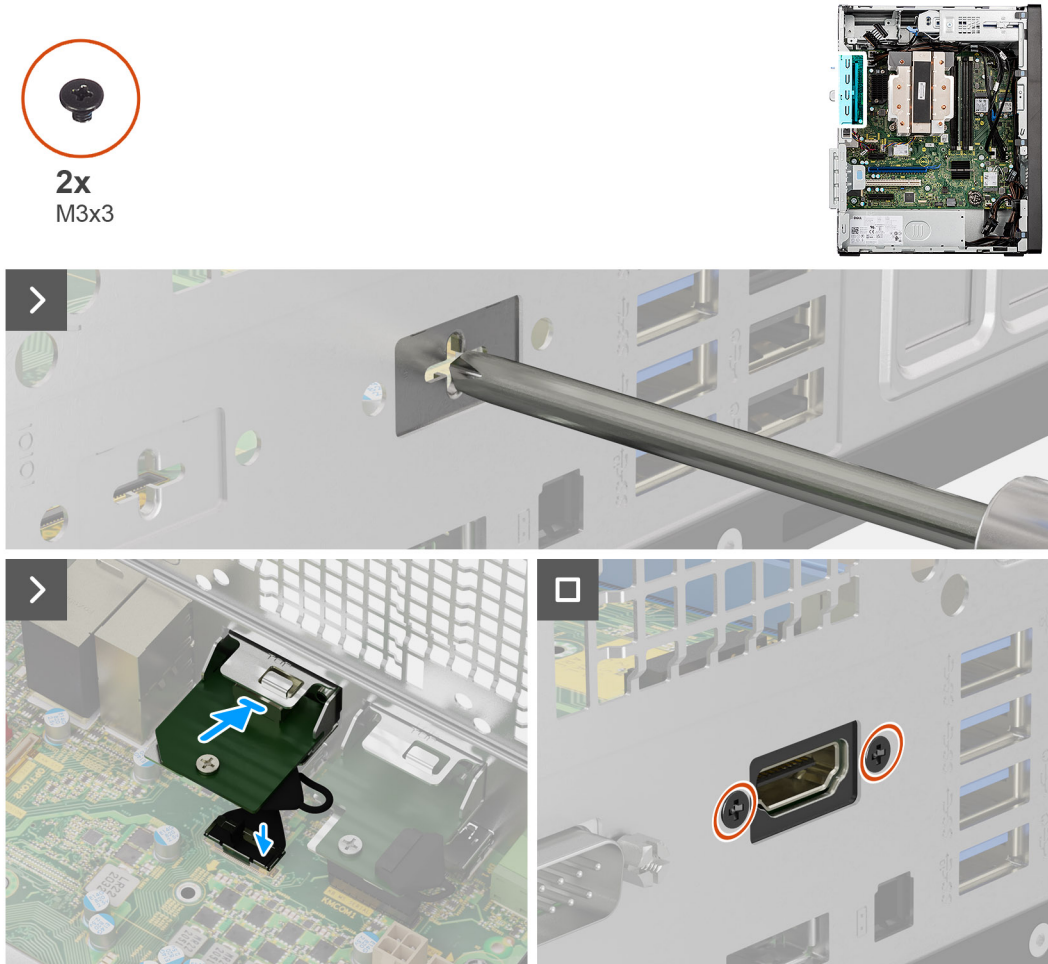

**Figure 89. Installing the optional HDMI module**

## Steps

1. Using a screwdriver, remove the optional-module cover from the chassis.
  - NOTE:** This step is applicable only when the optional HDMI module is being installed for the first time.
  - NOTE:** To remove the optional-module cover, insert a flat-head screwdriver in the hole of the cover, push the cover to release it, and then lift the cover off the chassis.
2. Insert the optional HDMI module in the slot on the chassis.
3. Connect the optional HDMI-module cable to the connector (VIDEO) on the system board .
4. Replace the two screws (M3X3) to secure the optional HDMI module to the chassis.

## Next steps

1. Install the [side cover](#).
2. Follow the procedure in [After working inside your computer](#).

# Optional DisplayPort module

## Removing the optional DisplayPort module

**CAUTION:** The information in this removal section is intended for authorized service technicians only.

### Prerequisites

1. Follow the procedure in [Before working inside your computer](#).
2. Remove the [side cover](#).

### About this task

The following images indicate the location of the optional DisplayPort module and provide a visual representation of the removal procedure.

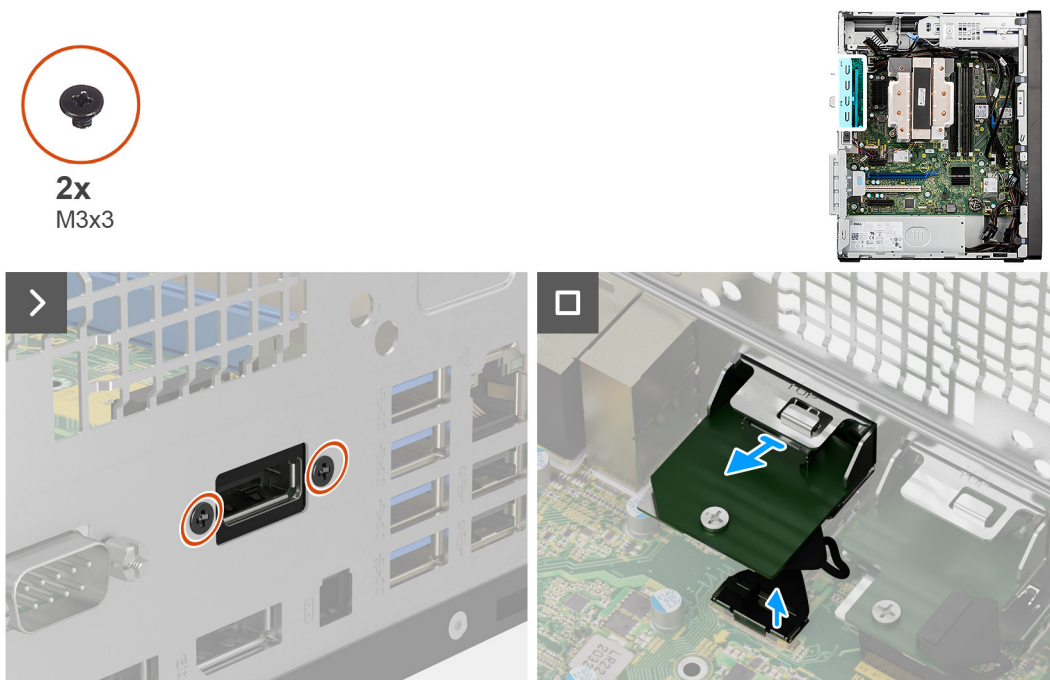

**Figure 90. Removing the optional DisplayPort module**

### Steps

1. Remove the two screws (M3X3) that secure the optional DisplayPort module to the chassis.
2. Disconnect the optional DisplayPort-module cable from the connector (VIDEO) on the system board.
3. Lift the optional DisplayPort module off the system board.

## Installing the optional DisplayPort module

**CAUTION:** The information in this installation section is intended for authorized service technicians only.

### Prerequisites

If you are replacing a component, remove the existing component before performing the installation procedure.

### About this task

The following images indicate the location of the optional DisplayPort module and provide a visual representation of the installation procedure.



2x  
M3x3

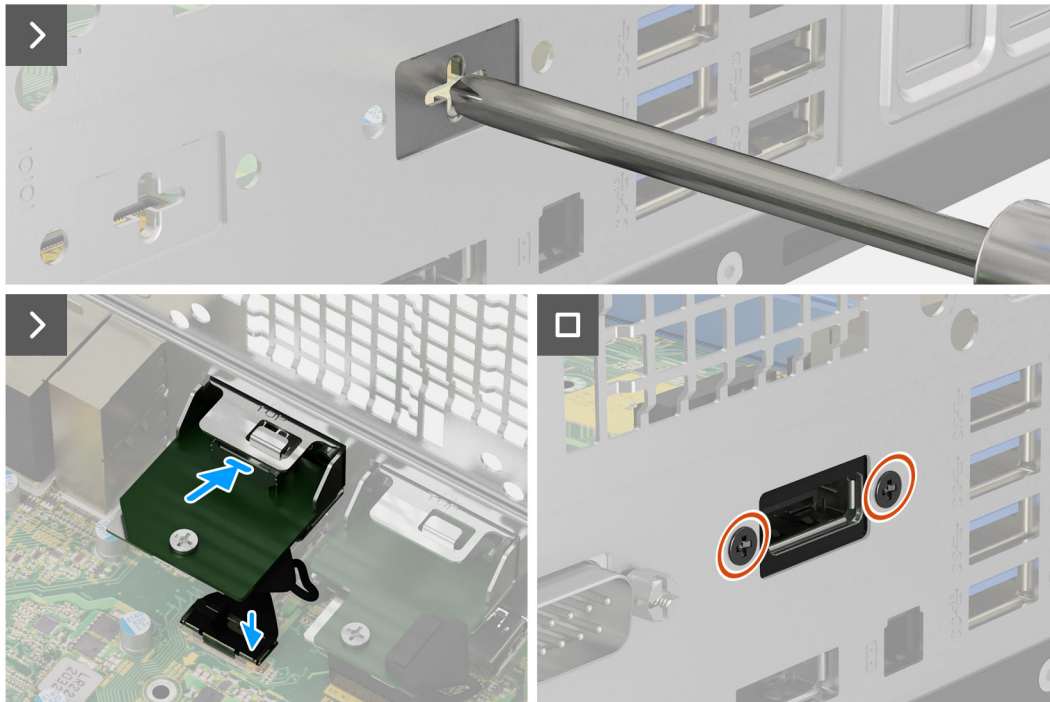

Figure 91. Installing the optional DisplayPort module

### Steps

1. Using a screwdriver, remove the optional-module cover from the chassis.
  - NOTE:** This step is applicable only when the optional DisplayPort module is being installed for the first time.
  - NOTE:** To remove the optional-module cover, insert a flat-head screwdriver in the hole of the cover, push the cover to release it, and then lift the cover off the chassis.
2. Insert the optional DisplayPort module in the slot on the chassis.
3. Connect the optional DisplayPort module cable to the connector (VIDEO) on the system board.
4. Replace the two screws (M3X3) to secure the optional DisplayPort module to the chassis.

### Next steps

1. Install the [side cover](#).
2. Follow the procedure in [After working inside your computer](#).

## Optional VGA module

### Removing the optional VGA module

**CAUTION:** The information in this removal section is intended for authorized service technicians only.



### Prerequisites

1. Follow the procedure in [Before working inside your computer](#).
2. Remove the [side cover](#).

### About this task

The following images indicate the location of the optional VGA module and provide a visual representation of the removal procedure.

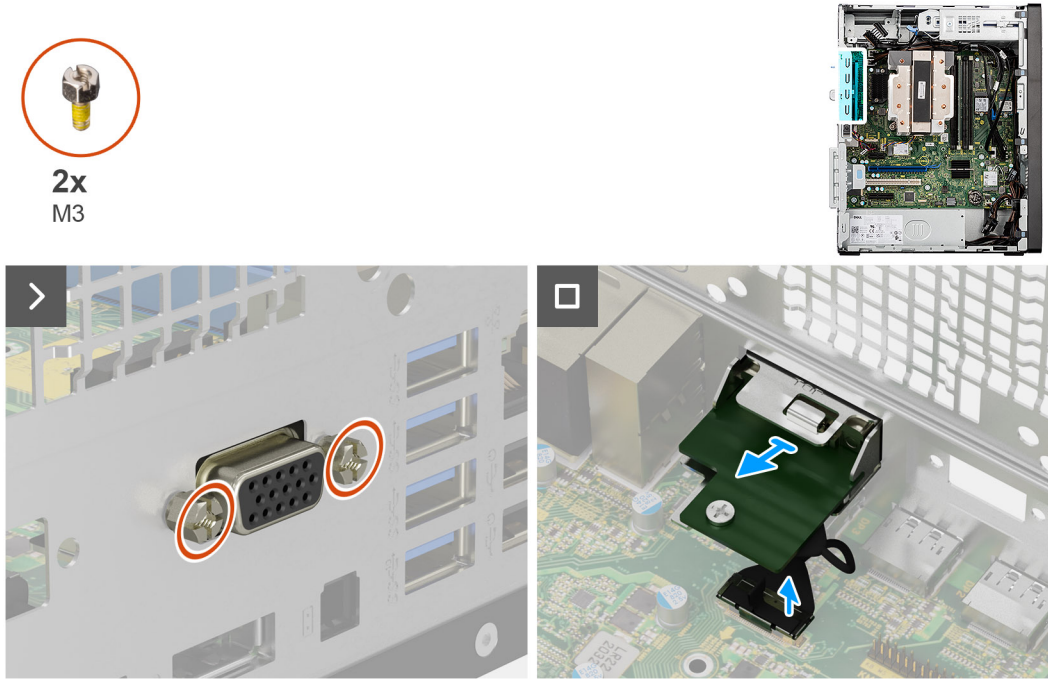

**Figure 92. Removing the optional VGA module**

### Steps

1. Remove the two screws (M3) that secure the optional VGA module to the chassis.
2. Disconnect the optional VGA module cable from the connector (VIDEO) on the system board.
3. Slide the optional VGA module out of the port opening and lift the optional VGA module off the system board.

## Installing the optional VGA module

**CAUTION:** The information in this installation section is intended for authorized service technicians only.

### Prerequisites

If you are replacing a component, remove the existing component before performing the installation procedure.

### About this task

The following images indicate the location of the optional VGA module and provide a visual representation of the installation procedure.



2x  
M3

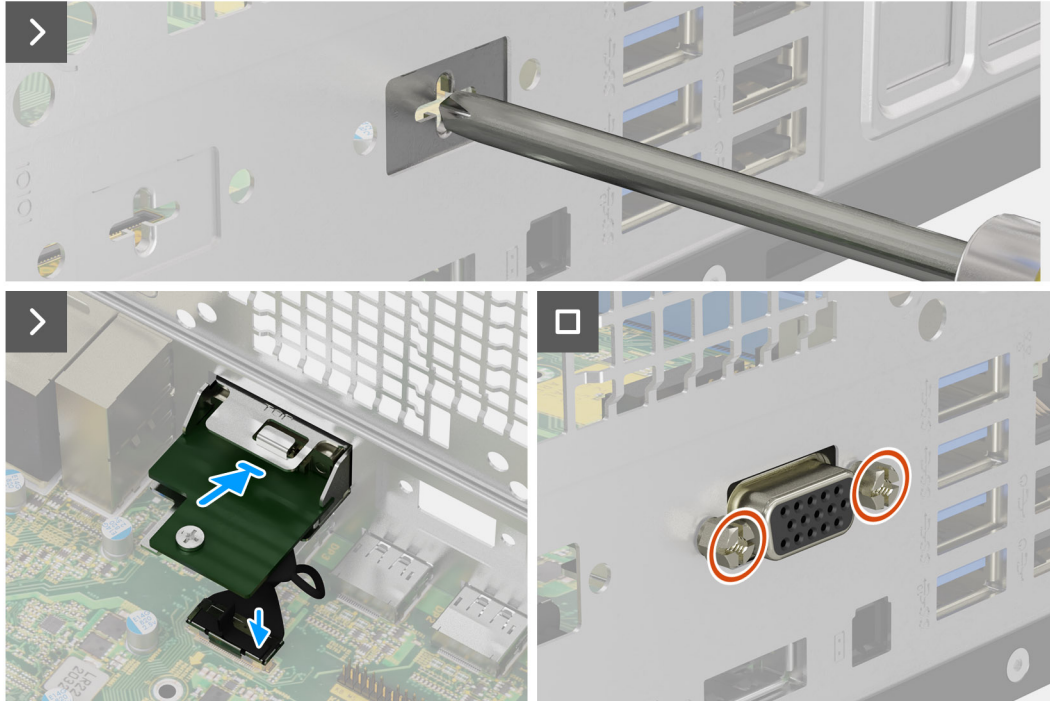

**Figure 93. Installing the optional VGA module**

### Steps

1. Using a screwdriver, remove the optional-module cover from the chassis.
  - NOTE:** This step is applicable only when the optional VGA module is being installed for the first time.
  - NOTE:** To remove the optional-module cover, insert a flat-head screwdriver in the hole of the cover, push the cover to release it, and then lift the cover off the chassis.
2. Insert the optional VGA module in the slot on the chassis.
3. Connect the VGA module cable to the connector (VIDEO) on the system board .
4. Replace the two screws (M3) to secure the optional VGA module to the chassis.

### Next steps

1. Install the [side cover](#).
2. Follow the procedure in [After working inside your computer](#).

## Optional USB Type-C module

### Removing the optional USB Type-C module

**CAUTION:** The information in this removal section is intended for authorized service technicians only.

### Prerequisites

1. Follow the procedure in [Before working inside your computer](#).
2. Remove the [side cover](#).

### About this task

The following images indicate the location of the optional USB Type-C module and provide a visual representation of the removal procedure.

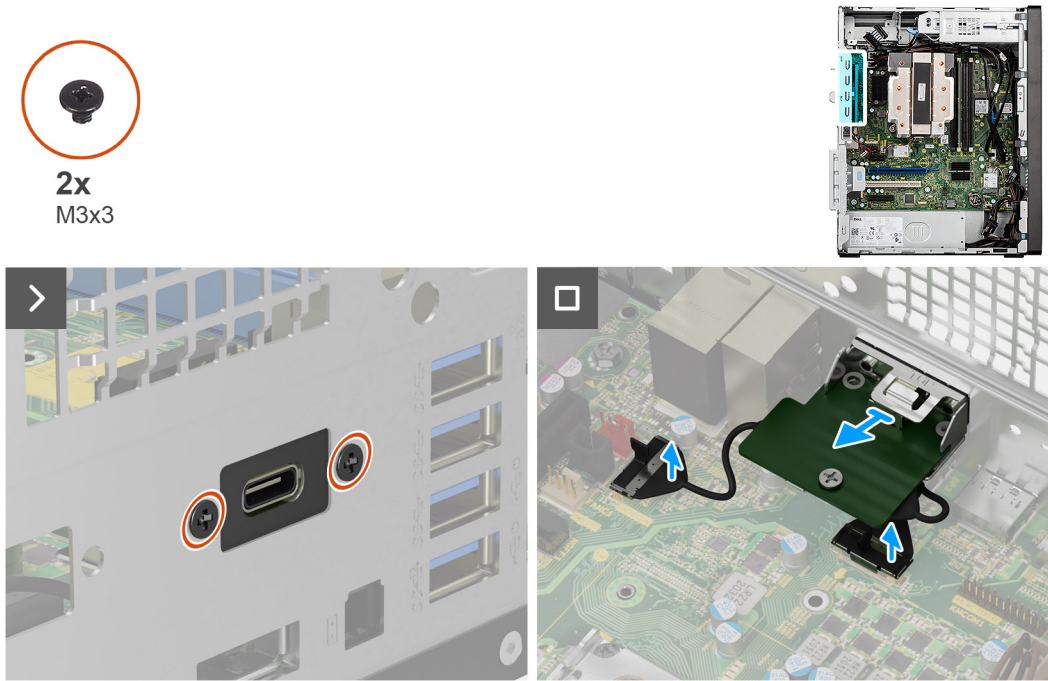

**Figure 94. Removing the optional USB Type-C module**

### Steps

1. Remove the two screws (M3x3) that secure the optional USB Type-C module to the chassis.
2. Disconnect the optional USB Type-C-module cables from the connectors (VIDEO and TYPE-C) on the system board.
3. Lift the optional USB Type-C module off the system board.

## Installing the optional USB Type-C module

**CAUTION:** The information in this installation section is intended for authorized service technicians only.

### Prerequisites

If you are replacing a component, remove the existing component before performing the installation procedure.

### About this task

The following images indicate the location of the optional USB Type-C module and provide a visual representation of the installation procedure.



2x  
M3x3

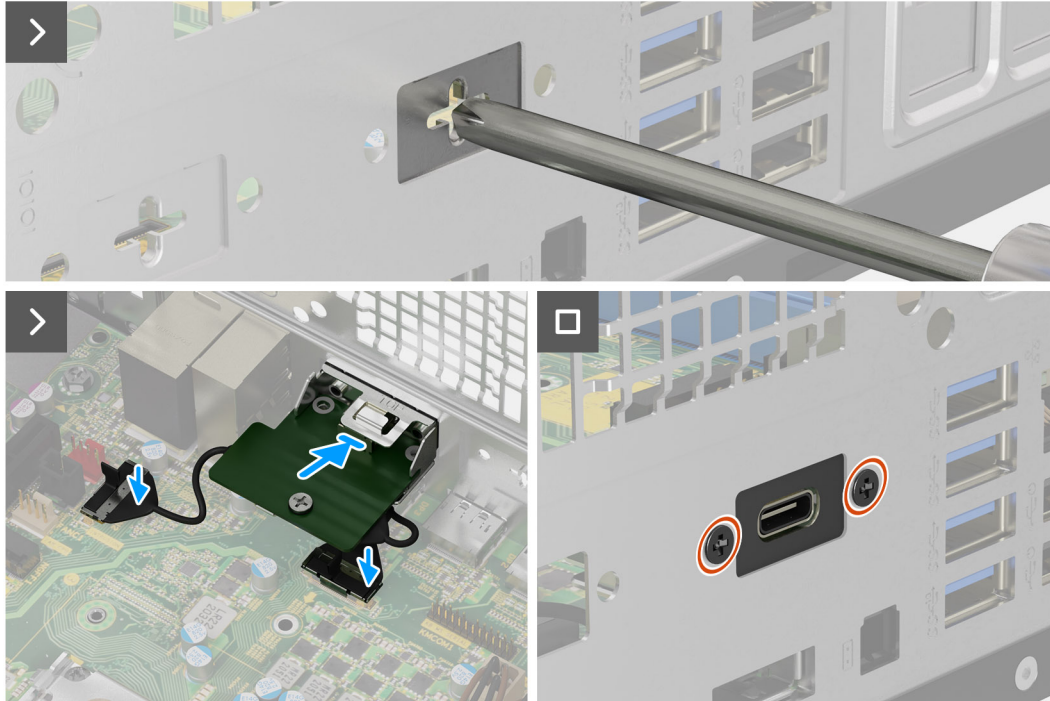

**Figure 95. Installing the optional USB Type-C module**

### Steps

1. Using a screwdriver, remove the optional-module cover from the chassis.
  - NOTE:** This step is applicable only when the optional USB Type-C module is being installed for the first time.
  - NOTE:** To remove the optional-module cover, insert a flat-head screwdriver in the hole of the cover, push the cover to release it, and then lift the cover off the chassis.
2. Insert the optional USB Type-C module in the slot on the chassis.
3. Connect the optional USB Type-C-module cables (VIDEO and TYPE-C) to the respective connectors on the system board.
4. Replace the two screws (M3x3) to secure the optional USB Type-C module to the chassis.

### Next steps

1. Install the [side cover](#).
2. Follow the procedure in [After working inside your computer](#).

## System board

### Removing the system board

**CAUTION:** The information in this removal section is intended for authorized service technicians only.

## Prerequisites

1. Follow the procedure in [Before working inside your computer](#).
2. Remove the [side cover](#).
3. Remove the [front bezel](#).
4. Remove the [memory module](#).
5. Remove the [M.2 2230 solid-state drive](#) or the [M.2 2280 solid-state drive](#), whichever is applicable.
6. Remove the [external puck antenna](#), if applicable.
7. Remove the [wireless card](#).
8. Remove the [graphics card](#) or the [powered graphics card](#), whichever is applicable.
9. Remove the [media-card reader](#), if applicable.
10. Remove the [3.5-inch hard drive](#) or the [secondary 3.5-inch hard drive](#), whichever is applicable.
11. Remove the [expansion card](#), if applicable.
12. Remove the [power button](#).
13. Remove the [external SMA antenna module](#), if applicable.
14. Remove the [processor fan and heat-sink assembly \(for 65 W processors\)](#) or the [processor fan and heat-sink assembly \(for 125 W processors\)](#), whichever is applicable.
15. Remove the [system fan](#).
16. Remove the [processor](#).
17. Remove the [voltage-regulator heat sink](#).
18. Remove the [optional I/O modules](#), if applicable.

## About this task

- NOTE:** The Service Tag of your computer is stored in the system board. You must enter the Service Tag in the BIOS setup program after you replace the system board.
- NOTE:** Replacing the system board removes any changes that you have made to the BIOS using the BIOS setup program. You must make the appropriate changes again after you replace the system board.
- NOTE:** Before disconnecting the cables from the system board, note the location of the connectors so that you can reconnect the cables correctly after you replace the system board.

The following image indicates the connectors on your system board.

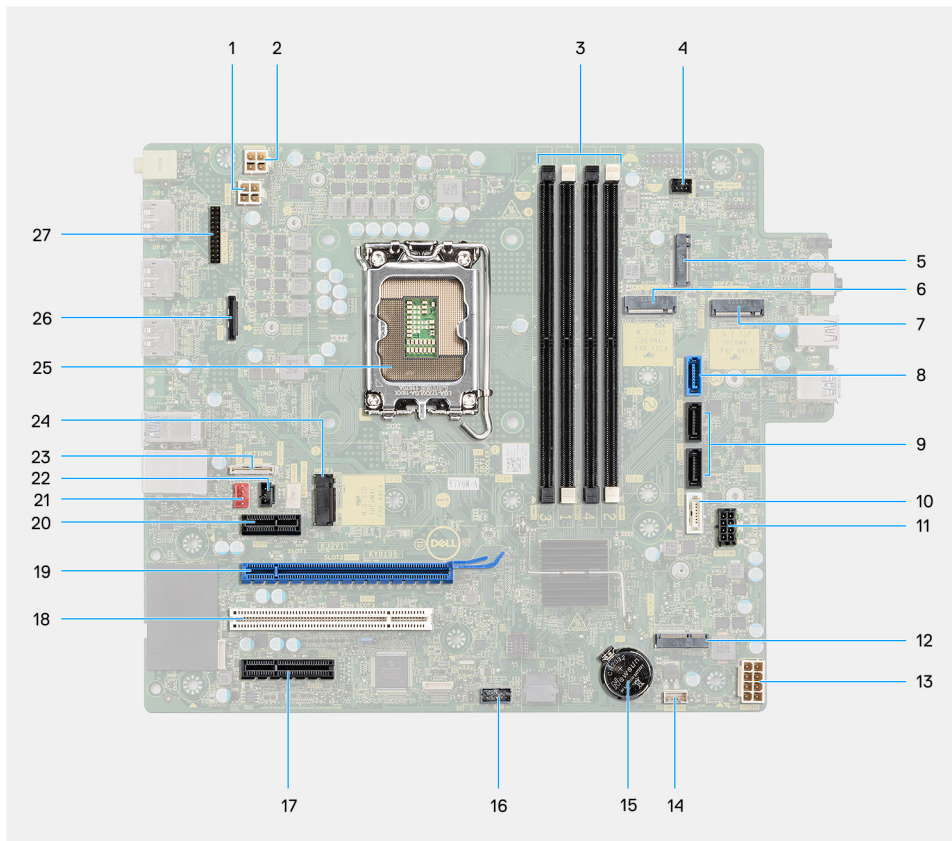

**Figure 96. System board connectors**

1. Power-supply unit cable connector (ATX CPU1)
2. Power-supply unit cable connector (ATX CPU2)
3. Memory module connectors (DIMM3, DIMM1, DIMM4, DIMM2)
4. Power-button cable connector (PWR SW)
5. Media-card reader connector (SD CARD)
6. M.2 2230/2280 solid-state drive connector (M.2 PCIe SSD-1)
7. M.2 2230 solid-state drive connector (M.2 PCIe SSD-2)
8. Hard-drive data cable connector (SATA0)
9. Hard drive/Slim optical drive power cable connector (SATA1 and SATA2)
10. Slim optical drive data cable connector (SATA3)
11. SATA power cable connector (SATA PWR)
12. Wireless card connector (M.2 WLAN)
13. Power-supply unit cable connector (ATX SYS)
14. Internal-speaker cable connector (INT SPKR)
15. Coin-cell battery connector (RTC)
16. Thunderbolt card connector (TBT)
17. PCIe x4 card connector (SLOT4)
18. PCI card connector (SLOT3)
19. PCIe x16 card connector (SLOT2)
20. PCIe x1 card connector (SLOT1)
21. System-fan cable connector (FAN SYS)
22. Intrusion-switch cable connector (INTRUSION)
23. USB Type-C port connector (TYPE-C)
24. M.2 2230/2280 solid-state drive connector (M.2 PCIe SSD-0)
25. Processor socket (CPU)
26. Optional video port connector (VIDEO)
27. Optional serial port connector (KB MS SERIAL)

The following images indicate the location of the system board and provide a visual representation of the removal procedure.

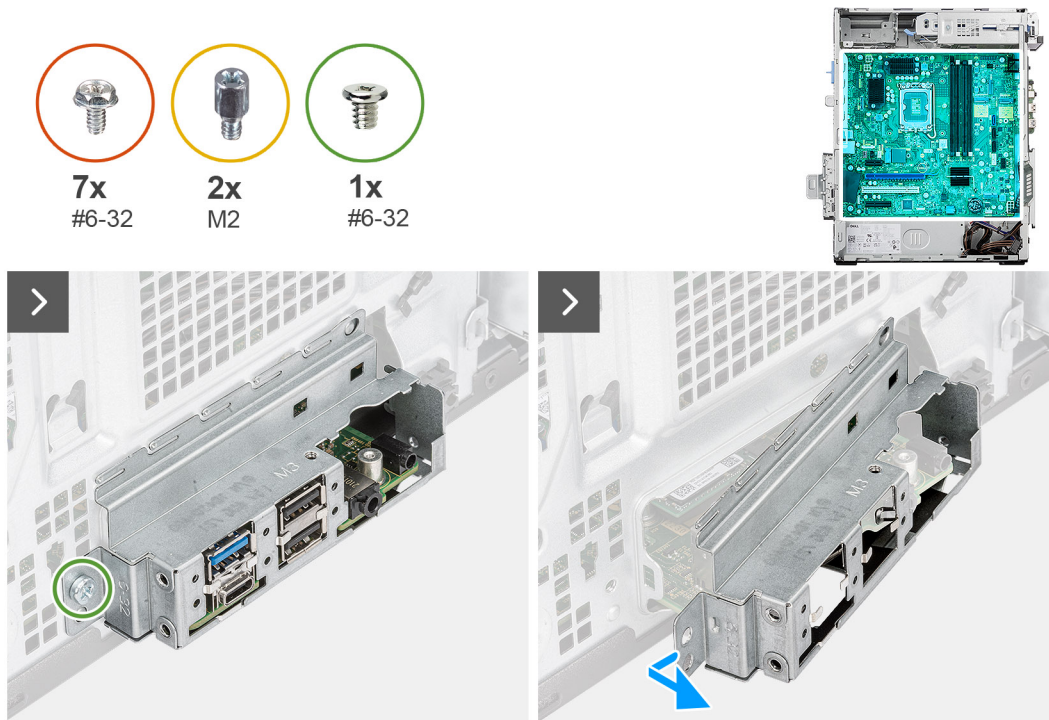

**Figure 97. Removing the system board**

**Steps**

1. Remove the screw (#6-32) that secures the front I/O-bracket to the chassis.
2. Slide and remove the front I/O-bracket from the chassis.
3. Disconnect the following cables from the respective connectors on the system board and remove them from the retention clips on the chassis, if applicable:
  - a. Power-supply unit cables (ATX CPU1, ATX CPU2 and ATX SYS)
  - b. Slim optical drive cable (SATA3)
  - c. Hard drive cables (SATA0 and SATA PWR)
  - d. Internal-speaker cable (INT SPKR)
  - e. Intrusion-switch cable (INTRUSION)

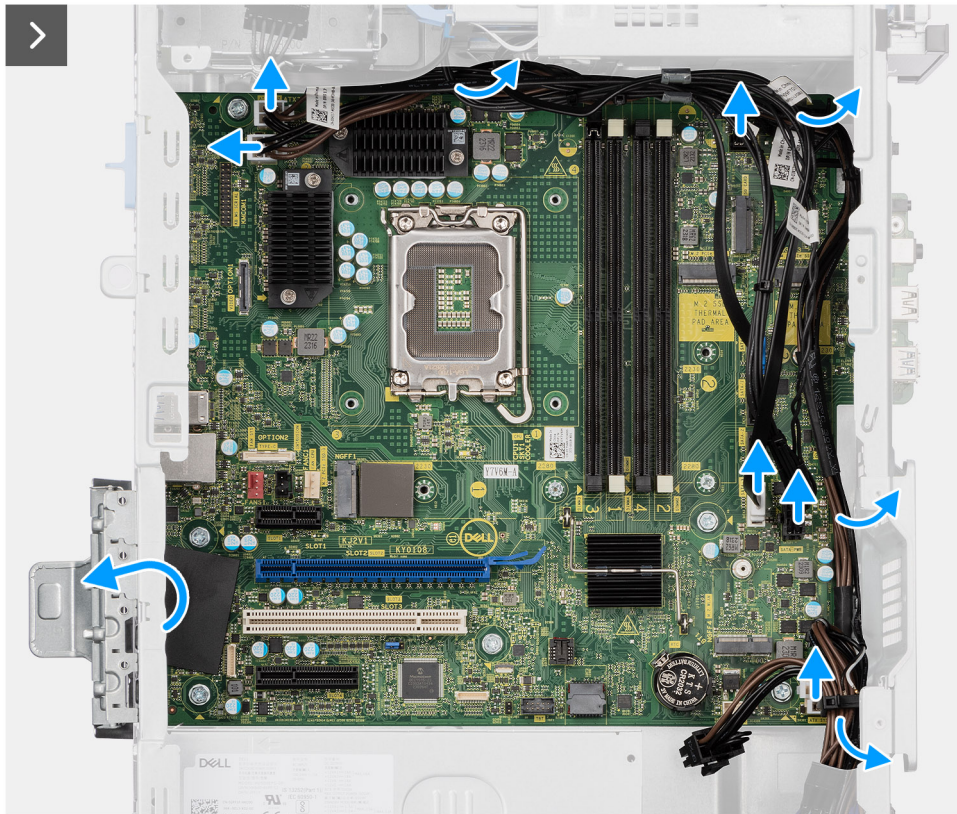

**Figure 98. Removing the system board**

4. Lift the pull tab on the PCIe door outwards to open the PCIe door.
5. Remove the seven screws (#6-32) that secure the system board to the chassis.
6. Remove the two M.2 solid-state drive standoff nuts (M2) that secure the system board to the chassis.



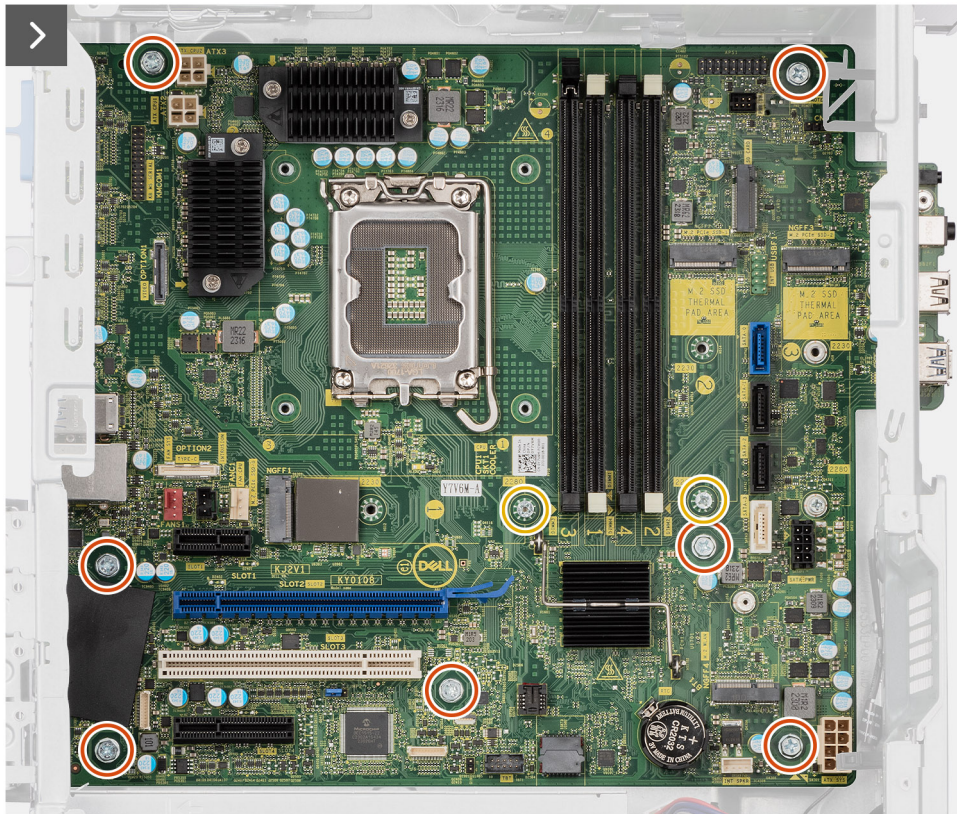

Figure 99. Removing the system board

7. Lift the system board at an angle and remove the system board from the chassis.

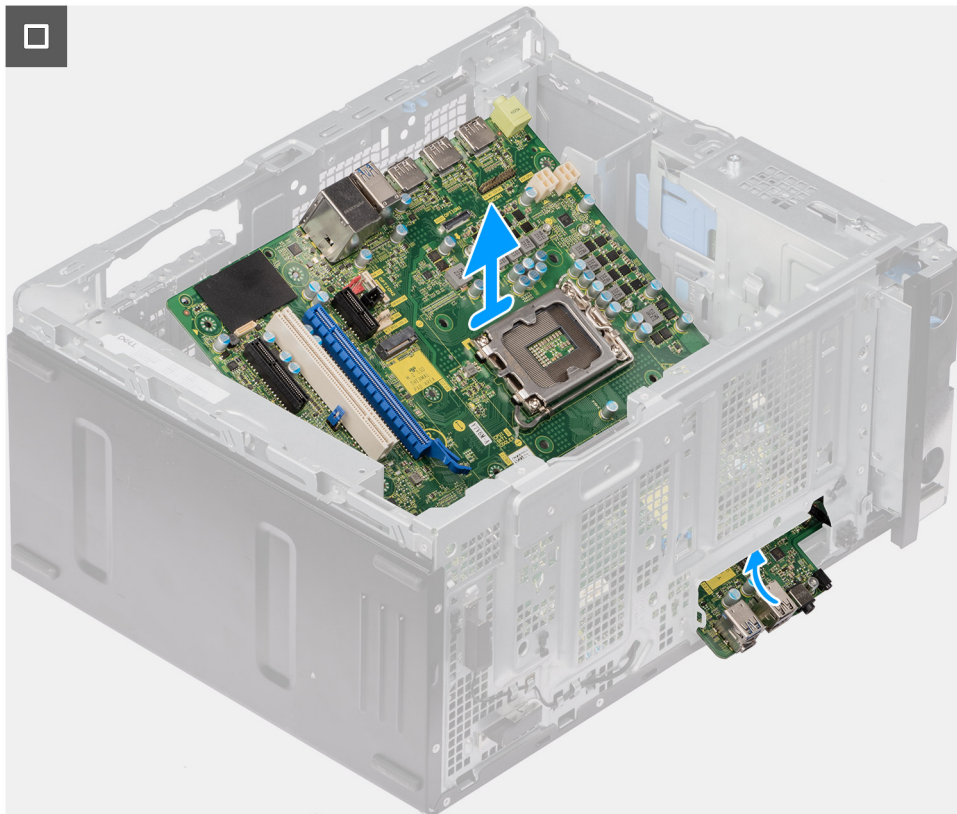

Figure 100. Removing the system board

# Installing the system board

**CAUTION:** The information in this installation section is intended for authorized service technicians only.

## Prerequisites

If you are replacing a component, remove the existing component before performing the installation procedure.

## About this task

**NOTE:** The Service Tag of your computer is stored in the system board. You must enter the Service Tag in the BIOS setup program after you replace the system board.

**NOTE:** Replacing the system board removes any changes that you have made to the BIOS using the BIOS setup program. You must make the appropriate changes again after you replace the system board.

The following image indicates the connectors on your system board.

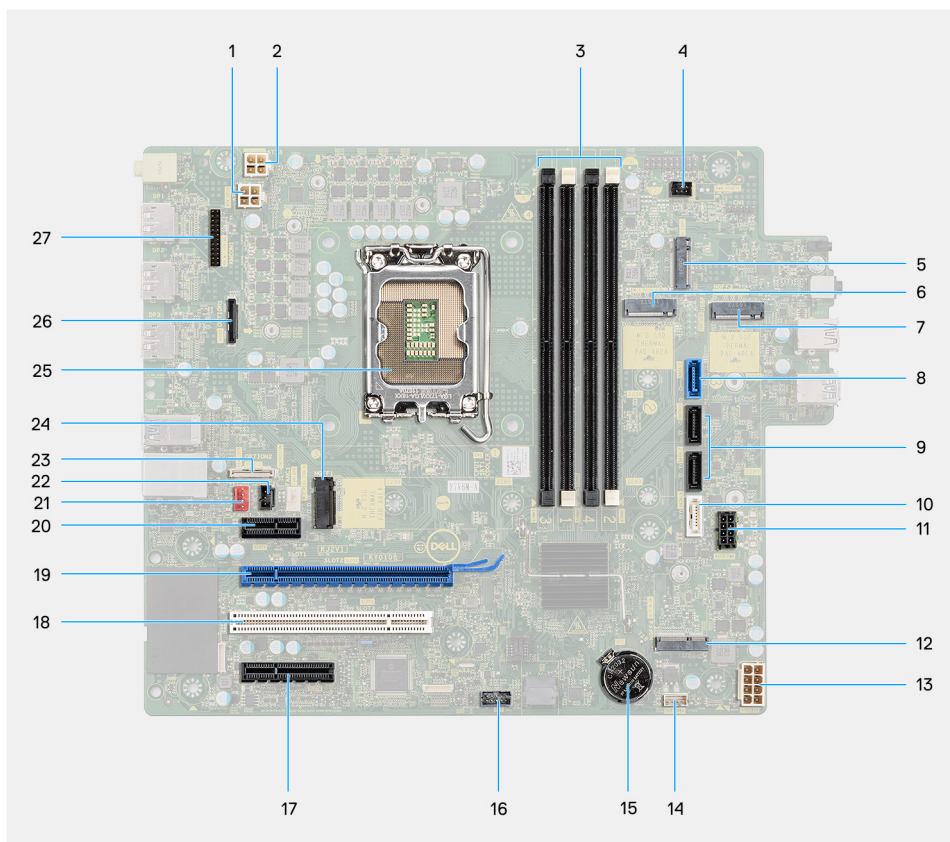
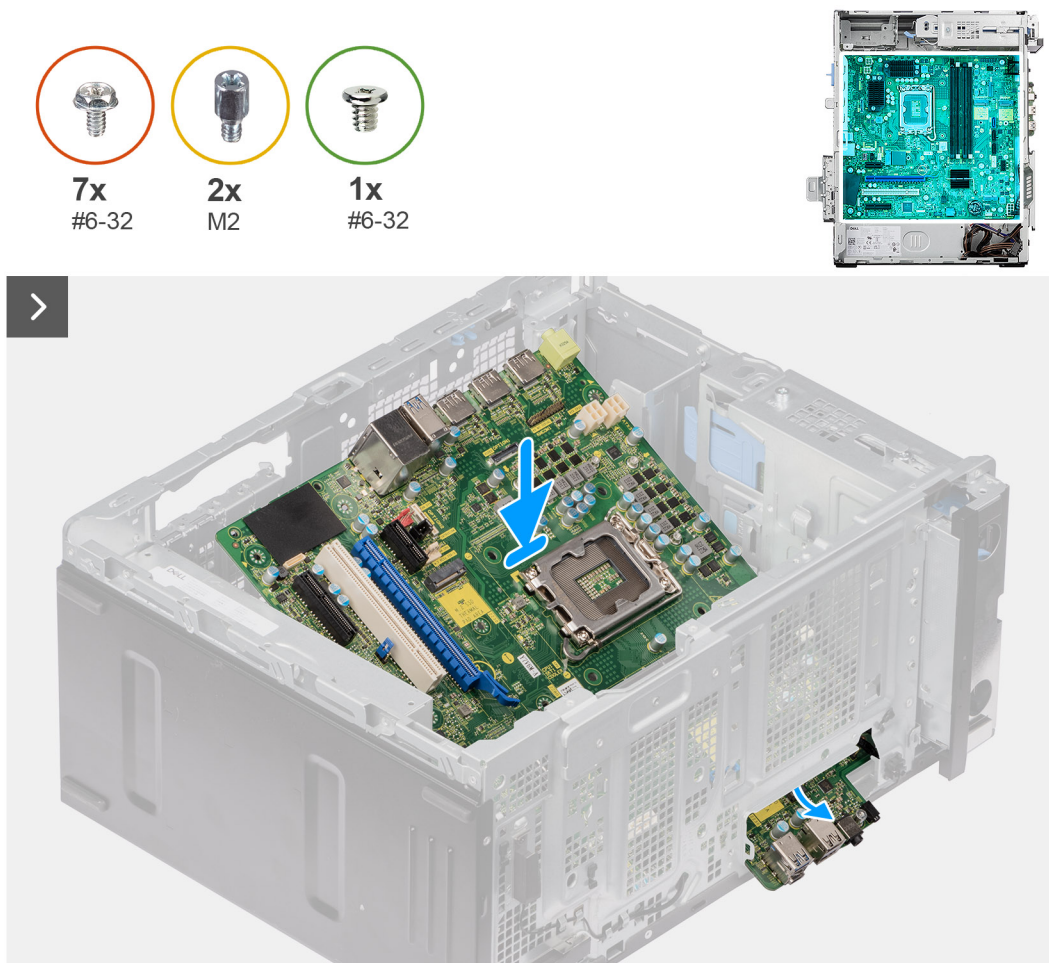

**Figure 101. System board connectors**

1. Power-supply unit cable connector (ATX CPU1)
2. Power-supply unit cable connector (ATX CPU2)
3. Memory module connectors (DIMM3, DIMM1, DIMM4, DIMM2)
4. Power-button cable connector (PWR SW)
5. Media-card reader connector (SD CARD)
6. M.2 2230/2280 solid-state drive connector (M.2 PCIe SSD-1)
7. M.2 2230 solid-state drive connector (M.2 PCIe SSD-2)
8. Hard-drive data cable connector (SATA0)
9. Hard drive/Slim optical drive power cable connector (SATA1 and SATA2)
10. Slim optical drive data cable connector (SATA3)
11. SATA power cable connector (SATA PWR)
12. Wireless card connector (M.2 WLAN)

13. Power-supply unit cable connector (ATX SYS)
14. Internal-speaker cable connector (INT SPKR)
15. Coin-cell battery connector (RTC)
16. Thunderbolt card connector (TBT)
17. PCIe x4 card connector (SLOT4)
18. PCI card connector (SLOT3)
19. PCIe x16 card connector (SLOT2)
20. PCIe x1 card connector (SLOT1)
21. System-fan cable connector (FAN SYS)
22. Intrusion-switch cable connector (INTRUSION)
23. USB Type-C port connector (TYPE-C)
24. M.2 2230/2280 solid-state drive connector (M.2 PCIe SSD-0)
25. Processor socket (CPU)
26. Optional video port connector (VIDEO)
27. Optional serial port connector (KB MS SERIAL)

The following images indicate the location of the system board and provide a visual representation of the installation procedure.



**Figure 102. Installing the system board**

**Steps**

1. Slide the front I/O-ports on the system board into the front I/O-slots on the chassis and align the screw holes on the system board with the screw holes on the chassis.
2. Replace the two M.2 solid-state drive standoff nuts (M2) to secure the system board to the chassis.
3. Replace the seven screws (#6-32) to secure the system board to the chassis.

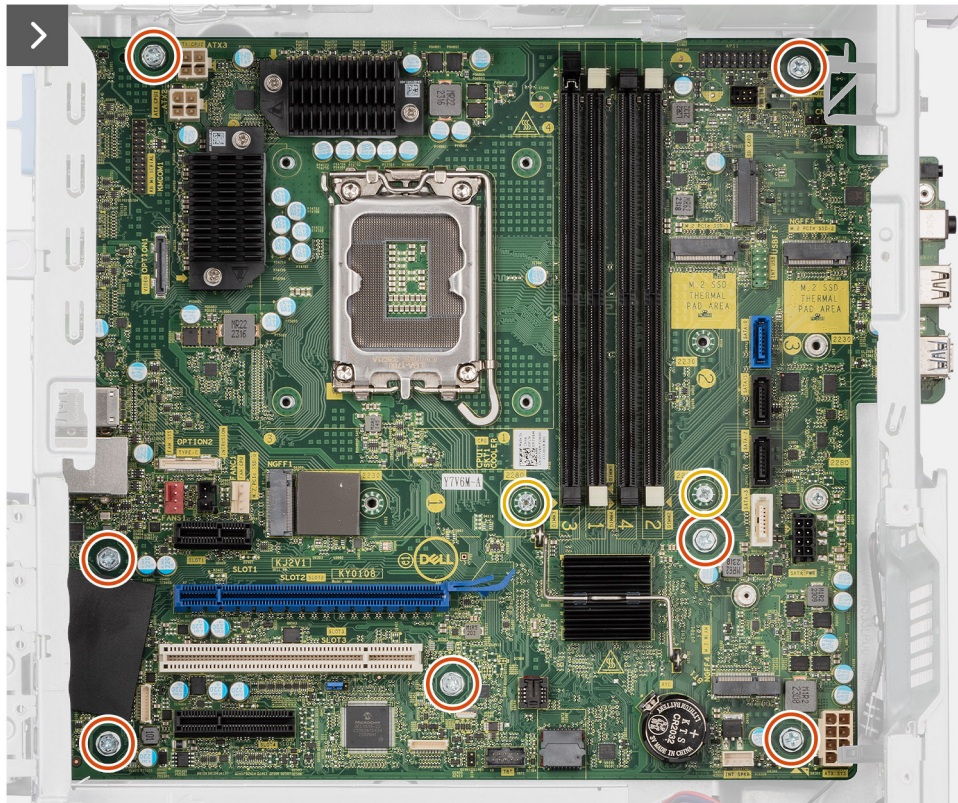

**Figure 103. Installing the system board**

4. Connect the following cables to the respective connectors on the system board and route them through the retention clips on the chassis, if applicable:
  - a. Power-supply unit cables (ATX CPU1, ATX CPU2 and ATX SYS)
  - b. Slim optical drive cable (SATA3)
  - c. Hard drive cables (SATA0 and SATA PWR)
  - d. Internal-speaker cable (INT SPKR)
  - e. Intrusion-switch cable (INTRUSION)

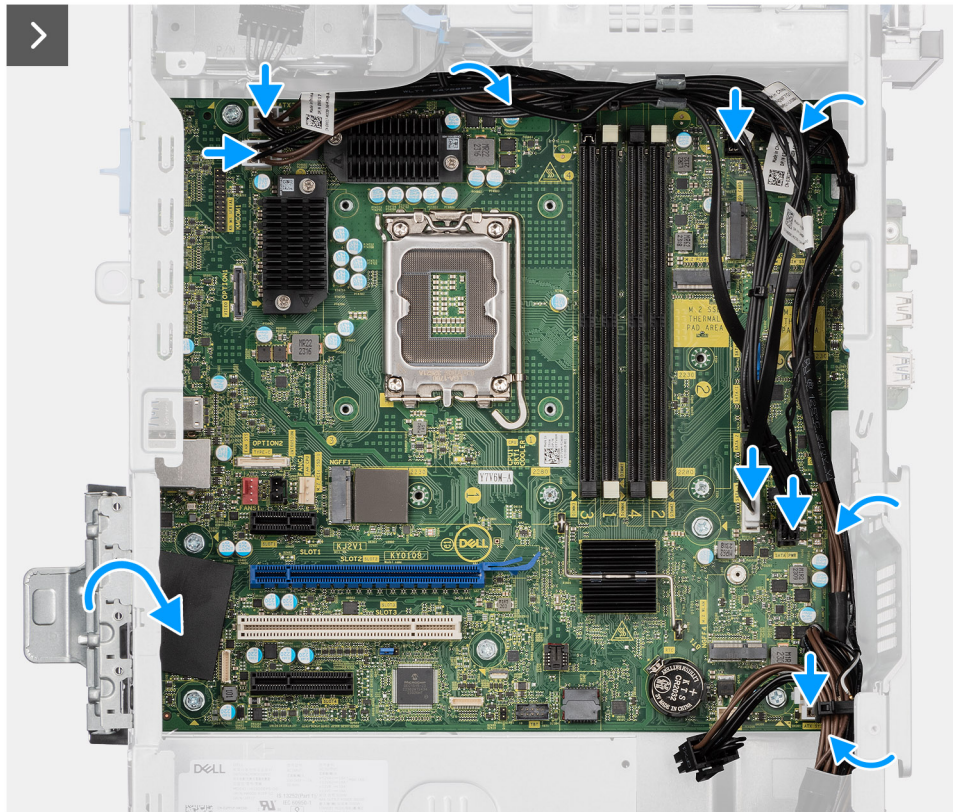

**Figure 104. Installing the system board**

5. Close the PCIe door and press it gently until it clicks in place on the chassis.
6. Align the tabs on the front I/O-bracket with the slots on the chassis.
7. Replace the screw (#6-32) to secure the front I/O-bracket to the chassis.

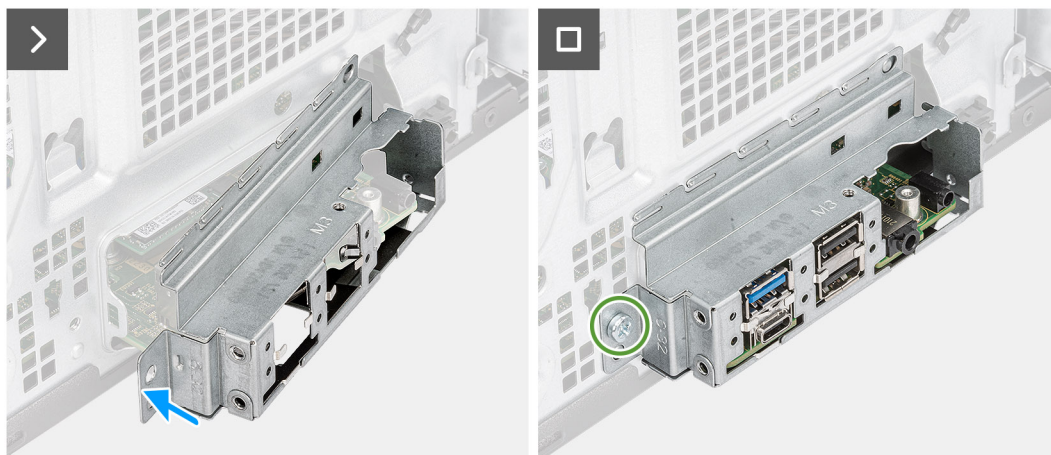

**Figure 105. Installing the system board**

### Next steps

1. Install the [optional I/O modules](#), if applicable.
2. Install the [voltage-regulator heat sink](#).
3. Install the [processor](#).
4. Install the [system fan](#).
5. Install the [processor fan and heat-sink assembly](#) (for 65 W processors) or the [processor fan and heat-sink assembly](#) (for 125 W processors), whichever is applicable.

6. Install the [external SMA antenna module](#), if applicable.
7. Install the [power button](#).
8. Install the [expansion card](#), if applicable.
9. Install the [3.5-inch hard drive](#) or the [secondary 3.5-inch hard drive](#), whichever is applicable.
10. Install the [media-card reader](#), if applicable.
11. Install the [graphics card](#) or the [powered graphics card](#), whichever is applicable.
12. Install the [wireless card](#).
13. Install the [external puck antenna](#), if applicable.
14. Install the [M.2 2230 solid-state drive](#) or the [M.2 2280 solid-state drive](#), whichever is applicable.
15. Install the [memory module](#).
16. Install the [front bezel](#).
17. Install the [side cover](#).
18. Follow the procedure in [After working inside your computer](#).

# Software

This chapter details the supported operating systems along with instructions on how to install the drivers.

## Operating system

Your OptiPlex Tower Plus 7020 supports the following operating systems:

- Windows 11 Home
- Windows 11 Pro
- Windows 11 Pro National Education
- Ubuntu Linux 22.04 LTS

## Drivers and downloads

When troubleshooting, downloading, or installing drivers, it is recommended that you read the Dell Knowledge Base article [Drivers and Downloads FAQs 000123347](#).

# BIOS Setup

**CAUTION:** Unless you are an expert computer user, do not change the settings in the BIOS Setup. Certain changes can make your computer work incorrectly.

**NOTE:** Depending on the computer and its installed devices, the items that are listed in this section may or may not be displayed.

**NOTE:** Before you change the settings in BIOS Setup, it is recommended that you note down the original settings for future reference.

Use BIOS Setup for the following purposes:

- Get information about the hardware installed in your computer, such as the amount of RAM and the size of the storage device.
- Change the system configuration information.
- Set or change a user-selectable option, such as the user password, type of hard drive installed, and enabling or disabling base devices.

## Entering BIOS Setup program

### About this task

Turn on (or restart) your computer and press F2 immediately.

## Navigation keys

**NOTE:** For most of the System Setup options, changes that you make are recorded but do not take effect until you restart the computer.

**Table 30. Navigation keys**

Keys	Navigation
Up arrow	Moves to the previous field.
Down arrow	Moves to the next field.
Enter	Selects a value in the selected field (if applicable) or follows the link in the field.
Spacebar	Expands or collapses a drop-down list, if applicable.
Tab	Moves to the next focus area. <b>NOTE:</b> For the standard graphical user interface only.
Esc	Moves to the previous page until you view the main screen. Pressing Esc in the main screen displays a message that prompts you to save any unsaved changes and restart the computer.

## F12 One Time Boot menu

To enter the One Time Boot menu, turn on your computer, and then press F12 immediately.



 **NOTE:** It is recommended to shut down the computer, if it is on.

The F12 One Time Boot menu displays the devices that you can boot from including the diagnostic option. The boot menu options are:

- Removable Drive (if available)
- STXXXX Drive (if available)
  -  **NOTE:** XXX denotes the SATA drive number.
- Optical Drive (if available)
- SATA Hard Drive (if available)
- Diagnostics

The boot sequence screen also displays the option to access System Setup.

## System setup options

 **NOTE:** Depending on your computer and its installed devices, the items that are listed in this section may or may not be displayed.

**Table 31. System setup options—Overview menu**

Overview	
OptiPlex Tower Plus 7020	
BIOS Version	Displays the BIOS version number.
Service Tag	Displays the Service Tag of the computer.
Asset Tag	Displays the Asset Tag of the computer.
Manufacture Date	Displays the manufacture date of the computer.
Ownership Date	Displays the ownership date of the computer.
Express Service Code	Displays the Express Service Code of the computer.
Ownership Tag	Displays the Ownership Tag of the computer.
Signed Firmware Update	Displays whether the Signed Firmware Update is enabled on your computer. By default, the <b>Signed Firmware Update</b> option is enabled.
Processor	
Processor Type	Displays the processor type.
Maximum Clock Speed	Displays the maximum processor clock speed.
Minimum Clock Speed	Displays the minimum processor clock speed.
Current Clock Speed	Displays the current processor clock speed.
Core Count	Displays the number of cores on the processor.
Processor ID	Displays the processor identification code.
Processor L2 Cache	Displays the processor L2 Cache size.
Processor L3 Cache	Displays the processor L3 Cache size.
Microcode Version	Displays the microcode version.
Intel Hyper-Threading Capable	Displays whether the processor is Hyper-Threading (HT) capable.
64-Bit Technology	Displays whether 64-bit technology is used.
Memory	
Memory Installed	Displays the total computer memory installed.

**Table 31. System setup options—Overview menu (continued)**

<b>Overview</b>	
Memory Available	Displays the total computer memory available.
Memory Speed	Displays the memory speed.
Memory Channel Mode	Displays single or dual channel mode.
Memory Technology	Displays the technology that is used for the memory.
DIMM 1 Size	Displays the DIMM 1 memory size.
DIMM 2 Size	Displays the DIMM 2 memory size.
DIMM 3 Size	Displays the DIMM 3 memory size.
DIMM 4 Size	Displays the DIMM 4 memory size.
<b>Devices</b>	
Video Controller	Displays the video controller type of the computer.
Video Memory	Displays the video memory information of the computer.
Wi-Fi Device	Displays the wireless device information of the computer.
Native Resolution	Displays the native resolution of the computer.
Video BIOS Version	Displays the video BIOS version of the computer.
Audio Controller	Displays the audio controller information of the computer.
Bluetooth Device	Displays the Bluetooth device information of the computer.
LOM MAC Address	Displays the LAN On Motherboard (LOM) MAC address of the computer.
Slot 1	Displays the PCIe information of the computer for PCIe slot 1.
Slot 2	Displays the PCIe information of the computer for PCIe slot 2.
Slot 3	Displays the PCIe information of the computer for PCIe slot 3.
Slot 4	Displays the PCIe information of the computer for PCIe slot 4.

**Table 32. System setup options—Boot Configuration menu**

<b>Boot Configuration</b>	
<b>Boot Sequence</b>	
Boot Mode: UEFI only	Displays the boot mode of the computer.
Boot Sequence	Displays the boot sequence.
<b>Enable PXE Boot Priority</b>	Enables the computer to add PXE boot option to the top of the Boot Sequence when a new PXE boot option is detected.  By default, the <b>Enable PXE Boot Priority</b> option is disabled.
<b>Force PXE On Next Boot</b>	Enables the Force PXE feature.  By default, the <b>Force PXE On Next Boot</b> option is disabled.
<b>Secure Digital (SD) Card Boot</b>	Enables or disables read-only boot from Secure Digital (SD) card.  By default, the <b>Secure Digital (SD) Card Boot</b> option is disabled.
<b>Secure Boot</b>	Secure Boot is a method of guaranteeing the integrity of the boot path by performing additional validation of the operating system and PCI add-in cards. The computer stops booting to the operating system when a component is not authenticated during the boot process. Secure Boot can be enabled in BIOS setup or using management interfaces like Dell Command Configure, but can only be disabled from BIOS setup.

**Table 32. System setup options—Boot Configuration menu (continued)**

<b>Boot Configuration</b>	
Enable Secure Boot	<p>Enables the computer to boot using only validated boot software.</p> <p>By default, the <b>Enable Secure Boot</b> option is disabled.</p> <p>For additional security, Dell Technologies recommends keeping the <b>Secure Boot</b> option enabled to ensure that the UEFI firmware validates the operating system during the boot process.</p> <p><b>i</b> <b>NOTE:</b> For Secure Boot to be enabled, the computer is required to be in UEFI boot mode and the Enable Legacy Option ROMs option is required to be turned off.</p>
Enable Microsoft UEFI CA	<p>When disabled, the UEFI CA is removed from the BIOS UEFI Secure Boot database.</p> <p><b>i</b> <b>NOTE:</b> When disabled, the Microsoft UEFI CA could render your computer unable to boot, computer graphics may not function, some devices may not function properly, and the computer could become unrecoverable.</p> <p>By default, the <b>Enable Microsoft UEFI CA</b> option is enabled.</p> <p>For additional security, Dell Technologies recommends keeping the <b>Microsoft UEFI CA</b> option enabled to ensure the broadest compatibility with devices and operating systems.</p>
Secure Boot Mode	<p>Enables or disables the Secure Boot operation mode.</p> <p>By default, the <b>Deployed Mode</b> is selected.</p> <p><b>i</b> <b>NOTE:</b> <b>Deployed Mode</b> should be selected for normal operation of Secure Boot.</p>
<b>Expert Key Management</b>	
Enable Custom Mode	<p>Enables or disables the keys in the PK, KEK, db, and dbx security key databases to be modified.</p> <p>By default, the <b>Enable Custom Mode</b> option is disabled.</p>
Custom Mode Key Management	<p>Selects the custom values for expert key management.</p> <p>By default, the <b>PK</b> option is selected.</p>

**Table 33. System setup options—Integrated Devices menu**

<b>Integrated Devices</b>	
<b>Date/Time</b>	
Date	<p>Sets the computer date in MM/DD/YYYY format. Changes to the date format take effect immediately.</p>
Time	<p>Sets the computer time in HH/MM/SS 24-hour format. You can switch between a 12-hour and 24-hour clock. Changes to the time format take effect immediately.</p>
<b>Audio</b>	
Enable Audio	<p>Enables all integrated audio controller.</p> <p>By default, all the options are enabled.</p>
Enable Microphone	<p>Enables the microphone.</p> <p>By default, the <b>Enable Microphone</b> option is enabled.</p> <p><b>i</b> <b>NOTE:</b> Depending on the configuration ordered, the microphone setup option may not be available.</p>
Enable Internal Speaker	<p>Enables the internal speaker.</p>

**Table 33. System setup options—Integrated Devices menu (continued)**

<b>Integrated Devices</b>	
	By default, the <b>Enable Internal Speaker</b> option is enabled.
<b>USB Configuration</b>	
Enable Front USB Ports	Enables the front USB ports. By default, the <b>Enable Front USB Ports</b> option is enabled.
Enable Rear USB Ports	Enables the rear USB ports. By default, the <b>Enable Rear USB Ports</b> option is enabled.
Enable USB Boot Support	Enables booting from USB mass storage devices that are connected to external USB ports. By default, the <b>Enable USB Boot Support</b> option is enabled.
<b>Front USB Configuration</b>	Enables or disables the individual front USB ports. By default, all the front USB ports are enabled.
<b>Rear USB Configuration</b>	Enables or disables the individual rear USB ports. By default, all the rear USB ports are enabled.
<b>Miscellaneous Devices</b>	
PCI Slot	Enables the PCI slots. By default, the <b>PCI Slot</b> option is disabled.
<b>Dust Filter Maintenance</b>	Enables or disables the BIOS message for maintaining the optional dust filter installed in your computer.  When this option is enabled, the BIOS generates a pre-boot reminder to clean or replace the dust filter based on the interval set.  By default, the <b>Dust Filter Maintenance</b> option is disabled.

**Table 34. System setup options—Storage menu**

<b>Storage</b>	
<b>SATA/NVMe Operation</b>	Sets the operating mode of the integrated storage device controller.  By default, the <b>RAID On</b> option is selected. The storage device is configured to support RAID functions with VMD controller.
<b>Storage Interface</b>	Displays the information of various onboard drives.
Port Enablement	Enables or disables the individual onboard drives installed on the computer. By default, all the onboard drives are enabled.
<b>SMART Reporting</b>	
Enable SMART Reporting	Enables SMART (Self-Monitoring, Analysis, and Reporting Technology) Reporting.  When enabled, the BIOS can receive analytical information from integrated drives and send notifications during startup about possible future failure of the hard drive.  By default, the <b>Enable SMART Reporting</b> option is disabled.
<b>Drive Information</b>	Displays the information of onboard drives.
<b>Enable MediaCard</b>	
Secure Digital (SD) Card	Enables or disables the SD card. By default, the <b>Secure Digital (SD) Card</b> option is enabled.

**Table 34. System setup options—Storage menu (continued)**

<b>Storage</b>	
Secure Digital (SD) Card Read-Only Mode	Enables or disables the SD card read-only mode. By default, the <b>Secure Digital (SD) Card Read-Only Mode</b> option is disabled.

**Table 35. System setup options—Display menu**

<b>Display</b>	
<b>Primary Display</b>	Determines the primary display when multiple controllers are available on the computer By default, the <b>Auto</b> option is selected.
<b>Full Screen Logo</b>	Enables or disables the computer to display a full-screen logo, if the image matches screen resolution. By default, the <b>Full Screen Logo</b> option is disabled.

**Table 36. System setup options—Connection menu**

<b>Connection</b>	
<b>Network Controller Configuration</b>	
Integrated NIC	Enables or disables the on-board LAN Controller. By default, the <b>Enabled with PXE</b> option is selected.
<b>Wireless Device Enable</b>	
WLAN	Enables or disables the internal WLAN device. By default, the <b>WLAN</b> option enabled.
Bluetooth	Enables or disables the internal Bluetooth device. By default, the <b>Bluetooth</b> option enabled.
<b>Enable UEFI Network Stack</b>	Enables or disables the UEFI Network Stack and controls the onboard LAN Controller. By default, the <b>Auto Enabled</b> option is selected.
<b>HTTP(s) Boot Feature</b>	
HTTP(s) Boot	Displays if the computer has HTTP(s) Boot capabilities or not. By default, the <b>HTTP(s) Boot</b> option is enabled.
HTTP(s) Boot Modes	Allows you to set the HTTP(s) Boot Mode for the computer. By default, the <b>Auto Mode</b> option is selected. HTTP(s) Boot automatically extracts Boot URL from Dynamic Host Configuration Protocol (DHCP).

**Table 37. System setup options—Power menu**

<b>Power</b>	
<b>USB PowerShare</b>	
Enable USB PowerShare	Enables external devices to be powered or charged using the stored system battery even when the computer is in sleep state. By default, the <b>Enable USB PowerShare</b> option is disabled.
<b>Thermal Management</b>	Enables or disables cooling of fan and manages processor heat to adjust the computer performance, noise, and temperature.

**Table 37. System setup options—Power menu (continued)**

<b>Power</b>	
	By default, the <b>Optimized</b> option is selected. Standard setting for balanced performance, noise, and temperature.
<b>USB Wake Support</b>	
Enable USB Wake Support	When enabled, connecting a USB device wakes the computer from Standby, Hibernate, and Power Off.  By default, the <b>Enable USB Wake Support</b> option is enabled.
<b>AC Behavior</b>	
AC Recovery	Determines the computer behavior when AC power is restored after an unexpected loss of AC power.  By default, the <b>Power Off</b> option is selected.
<b>Block Sleep</b>	
	Blocks the computer from entering Sleep (S3) mode in the operating system.  By default, the <b>Block Sleep</b> option is disabled.   <b>NOTE:</b> When enabled, the computer does not go to Sleep, Intel Rapid Start is disabled automatically, and the operating system power option is blank if it was set to Sleep.
<b>Deep Sleep Control</b>	
	Determines the computer behavior for conserving power when the computer is in Shutdown (S5) or Hibernate (S4) mode.  By default, the <b>Enabled in S4 and S5</b> option is selected.
<b>Fan Control Override</b>	
	Determines the speed of the system fan.  When this option is enabled, the system fan runs at full speed.  When disabled, the system fan controller uses system environment data to run the fan at optimal speed.  By default, the <b>Fan Control Override</b> option is disabled.
<b>Intel Speed Shift Technology</b>	
	Enables or disables the Intel Speed Shift Technology support. When enabled, the operating system selects the appropriate processor performance automatically.  By default, the <b>Intel Speed Shift Technology</b> option is enabled.



**Table 38. System setup options—Security menu**

<b>Security</b>	
<b>Trusted Platform Module (TPM) 2.0 Security</b>	The Trusted Platform Module (TPM) provides various cryptographic services which serve as the cornerstone for many platform security technologies. Trusted Platform Module (TPM) is a security device that stores computer-generated keys for encryption and features such as BitLocker, Virtual Secure Mode, remote Attestation.  By default, the <b>Trusted Platform Module (TPM)</b> option is enabled.  For additional security, Dell Technologies recommends keeping <b>Trusted Platform Module (TPM)</b> enabled to allow these security technologies to fully function.   <b>NOTE:</b> The options that are listed apply to computers with a discrete <b>Trusted Platform Module (TPM)</b> chip.
TPM 2.0 Security On	Allows you to select whether or not the TPM is visible to the operating system.  By default, the <b>TPM 2.0 Security On</b> option is enabled.  For additional security, Dell Technologies recommends keeping <b>TPM 2.0 Security On</b> enabled to allow these security technologies to fully function.

**Table 38. System setup options—Security menu (continued)**

<b>Security</b>	
Attestation Enable	<p>The <b>Attestation Enable</b> option controls the endorsement hierarchy of TPM. Disabling the <b>Attestation Enable</b> option prevents TPM from being used to digitally sign certificates.</p> <p>By default, the <b>Attestation Enable</b> option is enabled.</p> <p>For additional security, Dell Technologies recommends keeping the <b>Attestation Enable</b> option enabled.</p> <p><b>NOTE:</b> When disabled, this feature may cause compatibility issues or loss of functionality in some operating systems.</p>
Key Storage Enable	<p>The <b>Key Storage Enable</b> option controls the storage hierarchy of TPM, which is used to store digital keys. Disabling the <b>Key Storage Enable</b> option restricts the ability of TPM to store owner's data.</p> <p>By default, the <b>Key Storage Enable</b> option is enabled.</p> <p>For additional security, Dell Technologies recommends keeping the <b>Key Storage Enable</b> option enabled.</p> <p><b>NOTE:</b> When disabled, this feature may cause compatibility issues or loss of functionality in some operating systems.</p>
SHA-256	<p>Allows you to control the hashing algorithm that is used by the TPM. When enabled, the TPM uses the SHA-256 hashing algorithm. When disabled, the TPM uses the SHA-1 hash algorithm.</p> <p>By default, the <b>SHA-256</b> option is enabled.</p> <p>For additional security, Dell Technologies recommends keeping the <b>SHA-256</b> option enabled.</p>
Clear	<p>When enabled, the <b>Clear</b> option clears information that is stored in the TPM after exiting the computer's BIOS. This option returns to the disabled state when the computer restarts.</p> <p>By default, the <b>Clear</b> option is disabled.</p> <p>Dell Technologies recommends enabling the <b>Clear</b> option only when TPM data is required to be cleared.</p>
Physical Presence Interface (PPI) Bypass for Clear Commands	<p>By default, the <b>PPI Bypass for Clear Commands</b> option is disabled.</p> <p>For additional security, Dell Technologies recommends keeping the <b>PPI Bypass for Clear Commands</b> option disabled.</p>
<b>Intel Total Memory Encryption</b>	<p>Total Memory Encryption (TME) protects memory from physical attacks including freeze spray, probing DDR to read the cycles, and other such attacks.</p>
Multi-Key Total Memory Encryption (Up to 16 keys)	<p>Enables or disables the Multi-Key Total Memory Encryption option.</p> <p>When enabled, all of system memory is encrypted by the TME block attached to the memory controller. Up to 16 different encryption keys are supported for use by the operating system/VMM.</p> <p>By default, the <b>Multi-Key Total Memory Encryption (Up to 16 keys)</b> option is disabled.</p>
<b>SMM Security Mitigation</b>	<p>Enables or disables additional UEFI SMM Security Mitigation protections. This option uses the Windows SMM Security Mitigations Table (WSMT) to confirm to the operating system that security best practices have been implemented by the UEFI firmware.</p> <p>By default, the <b>SMM Security Mitigation</b> option is enabled.</p> <p>For additional security, Dell Technologies recommends keeping the <b>SMM Security Mitigation</b> option enabled unless you have a specific application which is not compatible.</p>

**Table 38. System setup options—Security menu (continued)**

Security	
	<p> <b>NOTE:</b> This feature may cause compatibility issues or loss of functionality with some legacy tools and applications.</p>
Data Wipe on Next Boot	
Start Data Wipe	<p>Data Wipe is a secure wipe operation that deletes information from a storage device.</p> <p> <b>CAUTION:</b> The secure Data Wipe operation deletes information in a way that it cannot be reconstructed.</p> <p>Commands such as delete and format in the operating system may remove files from showing up in the file system. However, they can be reconstructed through forensic means as they are still represented on the physical media. Data Wipe prevents this reconstruction and is not recoverable.</p> <p>When enabled, the data wipe option will prompt to wipe any storage devices that are connected to the computer on the next boot.</p> <p>By default, the <b>Start Data Wipe</b> option is disabled.</p>
Absolute	<p>Absolute Software provides various cyber security solutions, some requiring software preloaded on Dell computers and integrated into the BIOS. To use these features, you must enable the Absolute BIOS setting and contact Absolute for configuration and activation.</p> <p>By default, the <b>Enable Absolute</b> option is selected.</p> <p>For additional security, Dell Technologies recommends keeping the <b>Absolute</b> option enabled.</p> <p> <b>NOTE:</b> When the Absolute features are activated, the Absolute integration cannot be disabled from the BIOS setup screen.</p>
UEFI Boot Path Security	<p>Enables or disables the computer to prompt the user to enter the Administrator password (if set) when booting to a UEFI boot path device from the F12 boot menu.</p> <p>By default, the <b>Always Except Internal HDD</b> option is enabled.</p>

**Table 39. System setup options—Passwords menu**

Passwords	
<b>Administrator Password</b>	<p>The Administrator Password prevents unauthorized access to the BIOS Setup options. Once the administrator password is set, the BIOS setup options can only be modified after providing the correct password.</p> <p>The following rules and dependencies apply to the Administrator Password -</p> <ul style="list-style-type: none"> <li>• The administrator password cannot be set if computer and/or internal hard drive passwords are previously set.</li> <li>• The administrator password can be used in place of the computer and/or internal hard drive passwords.</li> <li>• When set, the administrator password must be provided during a firmware update.</li> <li>• Clearing the administrator password also clears the computer password (if set).</li> </ul> <p>Dell Technologies recommends using an administrator password to prevent unauthorized changes to BIOS setup options.</p>
<b>System Password</b>	<p>The System Password prevents the computer from booting to an operating system without entering the correct password.</p> <p>The following rules and dependencies apply when the System Password is used -</p>



**Table 39. System setup options—Passwords menu (continued)**

<p><b>Passwords</b></p>	<ul style="list-style-type: none"> <li>• The computer shuts down when idle for approximately 10 minutes at the computer password prompt.</li> <li>• The computer shuts down after three incorrect attempts to enter the computer password.</li> <li>• The computer shuts down when the <b>Esc</b> key is pressed at the System Password prompt.</li> <li>• The computer password is not prompted when the computer resumes from standby mode.</li> </ul> <p>Dell Technologies recommends using the computer password in situations where it is likely that a computer may be lost or stolen.</p>
<p><b>M.2 PCIe SSD-1</b></p>	<p>The M.2 PCIe SSD-1 Password can be set to prevent unauthorized access of the data stored on the solid-state drive. The computer prompts for the solid-state drive password during boot in order to unlock the drive. A password-secured solid-state drive stays locked even when removed from the computer or placed into another computer. It prevents an attacker from accessing data on the drive without authorization.</p> <p>The following rules and dependencies apply when the M.2 PCIe SSD-1 Password is used -</p> <ul style="list-style-type: none"> <li>• The solid-state drive password option cannot be accessed when a hard drive is disabled in the BIOS setup.</li> <li>• The computer shuts down when idle for approximately 10 minutes at the solid-state drive password prompt.</li> <li>• The computer shuts down after three incorrect attempts to enter the solid-state drive password and treats the hard drive as not available.</li> <li>• The solid-state drive does not accept password unlock attempts after five incorrect attempts to enter the solid-state drive password from the BIOS Setup. The solid-state drive password must be reset for the new password unlock attempts.</li> <li>• The computer treats the solid-state drive as not available when the <b>Esc</b> key is pressed at the solid-state drive password prompt.</li> <li>• The solid-state drive password is not prompted when the computer resumes from standby mode. When the solid-state drive is unlocked by the user before the computer goes into standby mode, it remains unlocked after the computer resumes from standby mode.</li> <li>• If the computer and solid-state drive passwords are set to the same value, the solid-state drive unlocks after the correct computer password is entered.</li> </ul> <p>Dell Technologies recommends using a solid-state drive password to protect unauthorized data access.</p>
<p><b>Password Configuration</b></p>	<p>The Password configuration page includes several options for changing the requirements of BIOS passwords. You can modify the minimum and maximum length of the passwords and require passwords to contain certain character classes (upper case, lower case, digit, special character).</p> <p>Dell Technologies recommends setting the minimum password length to at least eight characters.</p>
<p>Upper Case Letter</p>	<p>The Upper Case Letter field enforces stricter rules for administrator and system passwords.</p> <p>When enabled, the password is required to include at least one upper case letter.</p> <p>By default, the <b>Upper Case Letter</b> option is disabled.</p>
<p>Lower Case Letter</p>	<p>The Lower Case Letter field enforces stricter rules for administrator and system passwords.</p> <p>When enabled, the password is required to include at least one lower case letter.</p>

**Table 39. System setup options—Passwords menu (continued)**

<b>Passwords</b>	
	By default, the <b>Lower Case Letter</b> option is disabled.
Digit	The Digit field enforces stricter rules for administrator and system passwords. When enabled, the password is required to include at least one digit number. By default, the <b>Digit</b> option is disabled.
Special Character	The Special Character field enforces stricter rules for administrator and system passwords. When enabled, the password is required to include at least one special character. By default, the <b>Special Character</b> option is disabled.
Minimum Characters	The Minimum Characters field enforces stricter rules for administrator and system passwords. It allows you to set the minimum number of characters allowed for password. By default, the <b>Minimum Characters</b> option is set to 04.
<b>Password Bypass</b>	The <b>Password Bypass</b> option allows the computer to reboot from the operating system without entering the computer or hard drive password. If the computer has already booted to the operating system, it is presumed that the user has already entered the correct computer or hard drive password. <b>i</b> <b>NOTE:</b> This option does not remove the requirement to enter the password after shutting down. By default, the <b>Password Bypass</b> option is disabled. For additional security, Dell Technologies recommends keeping the <b>Password Bypass</b> option enabled.
<b>Password Changes</b>	
Allow Non-Admin Password Changes	The <b>Allow Non-Admin Password Changes</b> option in BIOS setup allows an end user to set or change the computer or hard drive passwords without entering the administrator password. This gives an administrator control over the BIOS settings but enables an end user to provide their own password. By default, the <b>Allow Non-Admin Password Changes</b> option is enabled. For additional security, Dell Technologies recommends keeping the <b>Allow Non-Admin Password Changes</b> option disabled.
<b>Admin Setup Lockout</b>	The <b>Admin Setup Lockout</b> option prevents an end user from even viewing the BIOS setup configuration without first entering the administrator password (if set).
Enable Admin Setup Lockout	By default, the <b>Enable Admin Setup Lockout</b> option is disabled. For additional security, Dell Technologies recommends keeping the <b>Enable Admin Setup Lockout</b> option disabled.
<b>Master Password Lockout</b>	
Enable Master Password Lockout	The Master Password Lockout setting allows you to disable the Recovery Password feature. If the computer, administrator, or hard drive password is forgotten, the computer becomes unusable. <b>i</b> <b>NOTE:</b> When the owner password is set, the Master Password Lockout option is not available. <b>i</b> <b>NOTE:</b> When an internal hard drive password is set, it must first be cleared before Master Password Lockout can be changed. By default, the <b>Enable Master Password Lockout</b> option is disabled.

**Table 39. System setup options—Passwords menu (continued)**

Passwords	
	For additional security, Dell Technologies does not recommend enabling the <b>Master Password Lockout</b> unless you have implemented your own password recovery computer.
Allow Non-Admin PSID Revert	
Enable Allow Non-Admin PSID Revert	<p>Allows you to control access to the Physical Security ID (PSID) revert of NVMe hard-drives from the Dell Security Manager prompt.</p> <p>When enabled, PSID revert is allowed to proceed without providing the BIOS Admin password.</p> <p>By default, the <b>Enable Allow Non-Admin PSID Revert</b> option is disabled.</p>

**Table 40. System setup options—Update, Recovery menu**

Update, Recovery	
UEFI Capsule Firmware Updates	
Enable UEFI Capsule Firmware Updates	<p>Enables or disables BIOS updates through UEFI capsule update packages.</p> <p><b>i</b> <b>NOTE:</b> Disabling this option blocks the BIOS updates from services such as Microsoft Windows Update and Linux Vendor Firmware Service (LVFS).</p> <p>By default, the <b>Enable UEFI Capsule Firmware Updates</b> option is enabled.</p>
BIOS Recovery from Hard Drive	
	<p>Enables or disables the user to recover from certain corrupted BIOS conditions from a recovery file on the user primary hard drive or an external USB key.</p> <p>By default, the <b>BIOS Recovery from Hard Drive</b> option is enabled.</p> <p><b>i</b> <b>NOTE:</b> BIOS Recovery from Hard Drive is not available for self-encrypting drives (SED).</p> <p><b>i</b> <b>NOTE:</b> BIOS recovery is designed to fix the main BIOS block and cannot work if the Boot Block is damaged. In addition, this feature cannot work in the event of EC corruption, ME corruption, or a hardware issue. The recovery image must exist on an unencrypted partition on the drive.</p>
BIOS Downgrade	
Allow BIOS Downgrade	<p>Controls flashing of the computer firmware to previous revisions.</p> <p>By default, the <b>Allow BIOS Downgrade</b> option is enabled.</p>
SupportAssist OS Recovery	
	<p>Enables or disables the boot flow for SupportAssist OS Recovery tool in the event of certain computer errors.</p> <p>By default, the <b>SupportAssist OS Recovery</b> option is enabled.</p>
Dell Auto OS Recovery Threshold	
	<p>Allows you to control the automatic boot flow for SupportAssist System Resolution Console and for Dell operating system Recovery Tool.</p> <p>By default, the <b>Dell Auto OS Recovery Threshold</b> value is set to 2.</p>

**Table 41. System setup options—System Management menu**

System Management	
Service Tag	
	Displays the Service Tag of the computer.
Asset Tag	
	<p>Creates a computer Asset Tag that can be used by an IT administrator to uniquely identify a particular computer.</p> <p><b>i</b> <b>NOTE:</b> Once set in BIOS, the Asset Tag cannot be changed.</p>
Wake on LAN/WLAN	
	Enables or disables the computer to turn on by a special LAN signal.

**Table 41. System setup options—System Management menu (continued)**

<b>System Management</b>	
	By default, the <b>Wake on LAN/WLAN</b> option is disabled.
<b>Auto On Time</b>	Enable to set the computer to turn on automatically every day or on a preselected date and time. This option can be configured only if the Auto On Time is set to Everyday, Weekdays, or Selected Days.  By default, the <b>Auto On Time</b> option is disabled.
<b>Intel AMT Capability</b>	
Enable Intel AMT Capability	Enables or disables the Intel Active Management Technology (AMT) capability.  By default, the <b>Restrict Preboot Access</b> option is selected.
<b>SERR Messages</b>	
Enable SERR Messages	Enables or disables the SERR message mechanism.  By default, the <b>Enable SERR Messages</b> option is enabled.
<b>First Power On Date</b>	
Set Ownership Date	Allows you to set the Ownership date of the computer.  By default, the <b>Set Ownership Date</b> option is disabled.
<b>Diagnostics</b>	
OS Agent Requests	Enables or disables the computer to turn on by a special LAN signal.  By default, the <b>OS Agent Requests</b> option is enabled.
<b>Power-on-Self-Test Automatic Recovery</b>	Enables or disables the computer to turn on by a special LAN signal.  By default, the <b>Power-on-Self-Test Automatic Recovery</b> option is enabled.

**Table 42. System setup options—Keyboard menu**

<b>Keyboard</b>	
<b>Keyboard Errors</b>	
Enable Keyboard Error Detection	Enables or disables the reporting of keyboard related errors when the computer boots.  By default, the <b>Enable Keyboard Error Detection</b> option is enabled.
<b>Numlock LED</b>	
Enable Numlock LED	Determines whether the Numlock LED is on when the computer boots.  By default, the <b>Enable Numlock LED</b> option is enabled.
<b>Device Configuration HotKey Access</b>	Allows you to control whether you can access device configuration screens through hotkeys during computer startup.  By default, the <b>Device Configuration HotKey Access</b> option is enabled.
	<b>NOTE:</b> This setting controls only the Intel RAID (CTRL+ I), MEBX (CTRL+ P), and LSI RAID (CTRL+ C) Option ROMs. Other preboot Option ROMs, which support entry using a key sequence, are not affected by this setting.

**Table 43. System setup options—Preboot Behavior menu**

<b>Preboot Behavior</b>	
<b>Warnings and Errors</b>	Enables or disables the action to be taken when a warning or error is encountered.

**Table 43. System setup options—Preboot Behavior menu (continued)**

Preboot Behavior	
	<p>By default, the <b>Prompt on Warnings and Errors</b> option is selected. Stop, prompt, and wait for user input when warnings or errors are detected.</p> <p><b>i</b> <b>NOTE:</b> Errors deemed critical to the operation of the computer hardware stop the functioning of the computer.</p>
<b>Extend BIOS POST Time</b>	<p>Sets the BIOS POST (Power-On Self-Test) load time.</p> <p>By default, the <b>0 seconds</b> option is selected.</p>

**Table 44. System setup options—Virtualization menu**

Virtualization Support	
<b>Intel Virtualization Technology</b>	
Enable Intel Virtualization Technology (VT)	<p>When enabled, the computer can run a Virtual Machine Monitor (VMM).</p> <p>By default, the <b>Enable Intel Virtualization Technology (VT)</b> option is enabled.</p>
<b>VT for Direct I/O</b>	
Enable Intel VT for Direct I/O	<p>When enabled, the computer can perform Virtualization Technology for Direct I/O (VT-d). VT-d is an Intel method that provides virtualization for memory map I/O.</p> <p>By default, the <b>Enable Intel VT for Direct I/O</b> option is enabled.</p>
<b>Intel Trusted Execution Technology (TXT)</b>	<p>Intel Trusted Execution Technology (TXT) is a set of hardware extensions to Intel processors and chipsets. It provides a hardware-based root of trust to ensure that a platform boots with a known good configuration of firmware, BIOS, virtual machine monitor, and operating system. The following must be enabled in order to enable Intel TXT -</p> <ul style="list-style-type: none"> <li>• Intel Virtualization Technology - X</li> <li>• Intel Virtualization Technology - Direct</li> </ul> <p>By default, the <b>Intel Trusted Execution Technology (TXT)</b> option is enabled.</p> <p>For additional security, Dell Technologies recommends keeping the <b>Intel Trusted Execution Technology (TXT)</b> option enabled.</p>
<b>DMA Protection</b>	
Enable Pre-Boot DMA Support	<p>Allows you to control the Pre-Boot DMA protection for both internal and external ports. This option does not directly enable DMA protection in the operating system.</p> <p><b>i</b> <b>NOTE:</b> This option is not available when the virtualization setting for IOMMU is disabled (VT-d/AMD Vi).</p> <p>By default, the <b>Enable Pre-Boot DMA Support</b> option is enabled.</p> <p>For additional security, Dell Technologies recommends keeping the <b>Enable Pre-Boot DMA Support</b> option enabled.</p> <p><b>i</b> <b>NOTE:</b> This option is provided only for compatibility purposes, since some older hardware is not DMA capable.</p>
Enable OS Kernel DMA Support	<p>Allows you to control the Kernel DMA protection for both internal and external ports. This option does not directly enable DMA protection in the operating system. For operating systems that support DMA protection, this setting indicates to the operating system that the BIOS supports the feature.</p> <p><b>i</b> <b>NOTE:</b> This option is not available when the virtualization setting for IOMMU is disabled (VT-d/AMD Vi).</p> <p>By default, the <b>Enable OS Kernel DMA Support</b> option is enabled.</p>

**Table 44. System setup options—Virtualization menu (continued)**

<b>Virtualization Support</b>	
 <b>NOTE:</b> This option is provided only for compatibility purposes, since some older hardware is not DMA capable.	

**Table 45. System setup options—Performance menu**

<b>Performance</b>	
<b>Multi-Core Support</b>	
Multiple Atom Cores	<p>Enables to change the number of Atom cores available to the operating system. The default value is set to the maximum number of cores.</p> <p>By default, the <b>All Cores</b> option is selected.</p>
<b>Intel SpeedStep</b>	
Enable Intel SpeedStep Technology	<p>Enables the computer to dynamically adjust processor voltage and core frequency, decreasing average power consumption and heat production.</p> <p>By default, the <b>Enable Intel SpeedStep Technology</b> option is enabled.</p>
<b>C-State Control</b>	
Enable C-State Control	<p>Enables or disables the ability of the CPU to enter and exit low-power state. When disabled, it disables all C-states. When enabled, it enables all C-states that the chipset or platform allows.</p> <p>By default, the <b>Enable C-State Control</b> option is enabled.</p>
<b>Intel Turbo Boost Technology</b>	
Enable Intel Turbo Boost Technology	<p>Enables the Intel TurboBoost mode of the processor. When enabled, the Intel TurboBoost driver increases the performance of the CPU or graphics processor.</p> <p>By default, the <b>Enable Intel Turbo Boost Technology</b> option is enabled.</p>
<b>Intel Hyper-Threading Technology</b>	
Enable Intel Hyper-Threading Technology	<p>Enables the Intel Hyper-Threading mode of the processor. When enabled, the Intel Hyper-Threading increases the efficiency of the processor resources when multiple threads run on each core.</p> <p>By default, the <b>Intel Hyper-Threading Technology</b> option is enabled.</p>
<b>PCIe Resizable Base Address Register (BAR)</b>	<p>Enables or disables the PCIe resizable BAR support.</p> <p>By default, the <b>PCIe Resizable Base Address Register (BAR)</b> option is disabled.</p>

**Table 46. System setup options—System Logs menu**

<b>System Logs</b>	
<b>BIOS Event Log</b>	
Clear BIOS Event Log	<p>Allows you to select option to keep or clear BIOS events logs.</p> <p>By default, the <b>Keep Log</b> option is selected.</p>
<b>Power Event Log</b>	
Clear Power Event Log	<p>Allows you to select option to keep or clear Power events logs.</p> <p>By default, the <b>Keep Log</b> option is selected.</p>

# Updating the BIOS

## Updating the BIOS in Windows

### About this task

 **CAUTION:** If BitLocker is not suspended before updating the BIOS, the next time you reboot the computer it will not recognize the BitLocker key. You will then be prompted to enter the recovery key to progress, and the computer will ask for this on each reboot. If the recovery key is not known this can result in data loss or an unnecessary operating system reinstall. For more information about this subject, search in the Knowledge Base Resource at [Dell Support Site](#).

### Steps

1. Go to [Dell Support Site](#).
2. Click **Product support**. In the **Search support** box, enter the Service Tag of your computer, and then click **Search**.  
 **NOTE:** If you do not have the Service Tag, use the SupportAssist feature to automatically identify your computer. You can also use the product ID or manually browse for your computer model.
3. Click **Drivers & Downloads**. Expand **Find drivers**.
4. Select the operating system installed on your computer.
5. In the **Category** drop-down list, select **BIOS**.
6. Select the latest version of BIOS, and click **Download** to download the BIOS file for your computer.
7. After the download is complete, browse the folder where you saved the BIOS update file.
8. Double-click the BIOS update file icon and follow the on-screen instructions.  
For more information, search in the Knowledge Base Resource at [Dell Support Site](#).

## Updating the BIOS in Linux and Ubuntu

To update the system BIOS on a computer that is installed with Linux or Ubuntu, see the knowledge base article [000131486](#) at [Dell Support Site](#).

## Updating the BIOS using the USB drive in Windows

### About this task

 **CAUTION:** If BitLocker is not suspended before updating the BIOS, the next time you reboot the computer it will not recognize the BitLocker key. You will then be prompted to enter the recovery key to progress, and the computer will ask for this on each reboot. If the recovery key is not known this can result in data loss or an unnecessary operating system reinstall. For more information about this subject, search in the Knowledge Base Resource at [Dell Support Site](#).

### Steps

1. Follow the procedure from step 1 to step 6 in [Updating the BIOS in Windows](#) to download the latest BIOS setup program file.
2. Create a bootable USB drive. For more information, search in the Knowledge Base Resource at [Dell Support Site](#).
3. Copy the BIOS setup program file to the bootable USB drive.
4. Connect the bootable USB drive to the computer that needs the BIOS update.
5. Restart the computer and press **F12**.
6. Select the USB drive from the **One Time Boot Menu**.
7. Type the BIOS setup program filename and press **Enter**.  
The **BIOS Update Utility** appears.
8. Follow the on-screen instructions to complete the BIOS update.

# Updating the BIOS from the F12 One-Time boot menu

Update your computer BIOS using the BIOS update.exe file that is copied to a FAT32 USB drive and booting from the F12 One-Time boot menu.

## About this task

**CAUTION:** If BitLocker is not suspended before updating the BIOS, the next time you reboot the computer it will not recognize the BitLocker key. You will then be prompted to enter the recovery key to progress, and the computer will ask for this on each reboot. If the recovery key is not known this can result in data loss or an unnecessary operating system reinstall. For more information about this subject, search in the Knowledge Base Resource at [Dell Support Site](#).

## BIOS Update

You can run the BIOS update file from Windows using a bootable USB drive or you can also update the BIOS from the F12 One-Time boot menu on the computer.

Most of the Dell computers built after 2012 have this capability, and you can confirm by booting your computer to the F12 One-Time Boot Menu to see if BIOS FLASH UPDATE is listed as a boot option for your computer. If the option is listed, then the BIOS supports this BIOS update option.

**NOTE:** Only computers with the BIOS Flash Update option in the F12 One-Time boot menu can use this function.

## Updating from the One-Time boot menu

To update your BIOS from the F12 One-Time boot menu, you need the following:

- USB drive formatted to the FAT32 file system (key does not have to be bootable)
- BIOS executable file that you downloaded from the Dell Support website and copied to the root of the USB drive
- AC power adapter that is connected to the computer
- Functional computer battery to flash the BIOS

Perform the following steps to perform the BIOS update flash process from the F12 menu:

**CAUTION:** Do not turn off the computer during the BIOS update process. The computer may not boot if you turn off your computer.

## Steps

1. From a turn off state, insert the USB drive where you copied the flash into a USB port of the computer.
2. Turn on the computer and press F12 to access the One-Time Boot Menu, select BIOS Update using the mouse or arrow keys then press Enter.  
The flash BIOS menu is displayed.
3. Click **Flash from file**.
4. Select an external USB device.
5. Select the file and double-click the flash target file, and then click **Submit**.
6. Click **Update BIOS**. The computer restarts to flash the BIOS.
7. The computer will restart after the BIOS update is completed.

# System and setup password

Table 47. System and setup password

Password type	Description
System password	Password that you must enter to log in to your system.
Setup password	Password that you must enter to access and make changes to the BIOS settings of your computer.

You can create a system password and a setup password to secure your computer.



 **CAUTION:** The password features provide a basic level of security for the data on your computer.

 **CAUTION:** Anyone can access the data that is stored on your computer, when not locked and left unattended.

 **NOTE:** System and setup password feature is disabled.

## Assigning a System Setup password

### Prerequisites

You can assign a new System or Admin Password only when the status is in **Not Set**.

### About this task

To enter BIOS System Setup, press F2 immediately after a power-on or reboot.

### Steps

1. In the **System BIOS** or **System Setup** screen, select **Security** and press Enter.  
The **Security** screen is visible.
2. Select **System/Admin Password** and create a password in the **Enter the new password** field.  
Use the following guidelines to assign the system password:
  - A password can have up to 32 characters.
  - At least one special character: "( ! " # \$ % & ' \* + , - . / : ; < = > ? @ [ \ ] ^ \_ ` { | } )"
  - Numbers 0 to 9.
  - Upper case letters from A to Z.
  - Lower case letters from a to z.
3. Type the system password that you entered earlier in the **Confirm new password** field and click **OK**.
4. Press Esc and save the changes as prompted by the message.
5. Press Y to save the changes.  
The computer restarts.

## Deleting or changing an existing system setup password

### Prerequisites

Ensure that the **Password Status** is Unlocked (in the System Setup) before attempting to delete or change the existing System and/or Setup password. You cannot delete or change an existing System or Setup password, if the **Password Status** is Locked.

### About this task

To enter the System Setup, press F2 immediately after a power-on or reboot.

### Steps

1. In the **System BIOS** or **System Setup** screen, select **System Security** and press Enter.  
The **System Security** screen is displayed.
2. In the **System Security** screen, verify that the Password Status is **Unlocked**.
3. Select **System Password**, update, or delete the existing system password, and press Enter or Tab.
4. Select **Setup Password**, update, or delete the existing setup password, and press Enter or Tab.  
 **NOTE:** If you change the System and/or Setup password, reenter the new password when prompted. If you delete the System and/or Setup password, confirm the deletion when prompted.
5. Press Esc. A message prompts you to save the changes.
6. Press Y to save the changes and exit from System Setup.  
The computer restarts.

# Clearing CMOS settings

## About this task

 **CAUTION:** Clearing CMOS settings will reset the BIOS settings on your computer.

## Steps

1. Remove the [side cover](#).
2. Remove the [coin-cell battery](#).
3. Wait for one minute.
4. Replace the [coin-cell battery](#).
5. Replace the [side cover](#).

# Clearing BIOS (System Setup) and System passwords

## About this task

To clear the computer or BIOS passwords, contact Dell technical support as described at [Contact Support](#). For more information, go to [Dell Support Site](#).

 **NOTE:** For information about how to reset Windows or application passwords, see the documentation accompanying Windows or your application.

# Troubleshooting

## Dell SupportAssist Pre-boot System Performance Check diagnostics

### About this task

SupportAssist diagnostics (also known as system diagnostics) performs a complete check of your hardware. The Dell SupportAssist Pre-boot System Performance Check diagnostics is embedded with the BIOS and launched by the BIOS internally. The embedded system diagnostics provides options for particular devices or device groups allowing you to:

- Run tests automatically or in an interactive mode.
- Repeat the tests.
- Display or save test results.
- Run thorough tests to introduce additional test options to provide extra information about one or more failed devices.
- View status messages that inform you the tests are completed successfully.
- View error messages that inform you of problems encountered during testing.

 **NOTE:** Some tests for specific devices require user interaction. Always ensure that you are present at the computer terminal when the diagnostic tests are performed.

For more information, see the knowledge base article [000180971](#).

## Running the SupportAssist Pre-Boot System Performance Check

### Steps

1. Turn on your computer.
2. As the computer boots, press the F12 key as the Dell logo appears.
3. On the boot menu screen, select the **Diagnostics** option.
4. Click the arrow at the bottom left corner.  
Diagnostics front page is displayed.
5. Click the arrow in the lower-right corner to go to the page listing.  
The items that are detected are listed.
6. To run a diagnostic test on a specific device, press Esc and click **Yes** to stop the diagnostic test.
7. Select the device from the left pane and click **Run Tests**.
8. If there are any issues, error codes are displayed.  
Note the error code and validation number and contact Dell.

## Power-Supply Unit Built-in Self-Test

Built-in Self-Test (BIST) helps determine if the power-supply unit is working. To run self-test diagnostics on the power-supply unit of a desktop or all-in-one computer, search in the Knowledge Base Resource at [Dell Support Site](#).

## System-diagnostic lights

This section lists the system-diagnostic lights of your OptiPlex Tower Plus 7020.

### Diagnostic light

The power and battery status light indicates the power and battery status of the computer. These are the power states:

**Solid white:** Power adapter is connected, and the battery has more than 5% charge.

**Amber:** Computer is running on battery, and the battery has less than 5% charge.

**Off:**

- Power adapter is connected, and the battery is fully charged.
- Computer is running on battery, and the battery has more than 5% charge.
- Computer is in sleep state, hibernation, or turned off.

The power and battery-status light may blink amber or white according to pre-defined "beep codes" indicating various failures.

For example, the power and battery-status light blinks amber two times followed by a pause, and then blinks white three times followed by a pause. This 2, 3 pattern continues until the computer is turned off, indicating no memory or RAM is detected.

The following table shows different power and battery-status light patterns and associated problems.

**NOTE:** The following diagnostic light codes and recommended solutions are intended for Dell service technicians to troubleshoot problems. You should only perform troubleshooting and repairs as authorized or directed by the Dell technical assistance team. Damage due to servicing that is not authorized by Dell is not covered by your warranty.

**Table 48. Diagnostic-light LED codes**

Blinking pattern		Problem description
Amber	White	
1	2	Unrecoverable SPI Flash Failure
2	1	CPU failure
2	2	System board failure (included BIOS corruption or ROM error)
2	3	No memory/RAM detected
2	4	Memory/RAM failure
2	5	Invalid memory installed
2	6	System board/Chipset Error/Clock failure/Gate A20 failure/Super I/O failure/Keyboard controller failure
3	1	CMOS battery failure
3	2	PCI or Video card/chip failure
3	3	BIOS Recovery image not found
3	4	BIOS Recovery image found but invalid
3	5	Power rail failure
3	6	SBIOS Flash corruption
3	7	Intel Management Engine (ME) Error
4	2	CPU Power Cable Connection Issue

**NOTE:** Blinking 3-3-3 LEDs on Lock LED (Caps Lock or Num Lock), Power button LED (without Fingerprint reader), and Diagnostic LED indicates failure to provide input during LCD panel test on Dell SupportAssist Pre-boot System Performance. Check diagnostics.

## Recovering the operating system

When your computer is unable to boot to the operating system even after repeated attempts, it automatically starts Dell SupportAssist OS Recovery.

Dell SupportAssist OS Recovery is a stand-alone tool that is preinstalled in all Dell computers that are installed with the Windows operating system. It consists of tools to diagnose and troubleshoot issues that may occur before your computer boots to the

operating system. It enables you to diagnose hardware issues, repair your computer, back up your files, or restore your computer to its factory state.

You can also download it from the Dell Support website to troubleshoot and fix your computer when it fails to boot into their primary operating system due to software or hardware failures.

For more information about the Dell SupportAssist OS Recovery, see *Dell SupportAssist OS Recovery User's Guide at Serviceability Tools at the Dell Support Site*. Click **SupportAssist** and then, click **SupportAssist OS Recovery**.

## Real Time Clock—RTC reset

The Real Time Clock (RTC) reset function allows you or the service technician to recover the recently launched model Dell Latitude and Precision systems from **No POST/No Boot/No Power** situations. You can initiate the RTC reset on the system from a power-off state only if it is connected to AC power. Press and hold the power button for 25 seconds. The system RTC reset occurs after you release the power button.

**i** **NOTE:** If AC power is disconnected from the system during the process or the power button is held longer than 40 seconds, the RTC reset process gets aborted.

The RTC reset will reset the BIOS to Defaults, un-provision Intel vPro and reset the system date and time. The following items are unaffected by the RTC reset:

- Service Tag
- Asset Tag
- Ownership Tag
- Admin Password
- System Password
- HDD Password
- Key Databases
- System Logs

**i** **NOTE:** The IT administrator's vPro account and password on the system will be un-provisioned. The system needs to go through the setup and configuration process again to reconnect it to the vPro server.

The below items may or may not reset based on your custom BIOS setting selections:

- Boot List
- Enable Legacy Option ROMs
- Secure Boot Enable
- Allow BIOS Downgrade

## Backup media and recovery options

It is recommended to create a recovery drive to troubleshoot and fix problems that may occur with Windows. Dell proposes multiple options for recovering the Windows operating system on your Dell computer. For more information, see [Dell Windows Backup Media and Recovery Options](#).

## Wi-Fi power cycle

### About this task

If your computer is unable to access the Internet due to Wi-Fi connectivity issues a Wi-Fi power cycle procedure may be performed. The following procedure provides the instructions on how to conduct a Wi-Fi power cycle:

**i** **NOTE:** Some Internet Service Providers (ISPs) provide a modem or router combo device.

### Steps

1. Turn off your computer.
2. Turn off the modem.
3. Turn off the wireless router.

4. Wait for 30 seconds.
5. Turn on the wireless router.
6. Turn on the modem.
7. Turn on your computer.

# Getting help and contacting Dell

## Self-help resources

You can get information and help on Dell products and services using these self-help resources:

**Table 49. Self-help resources**

Self-help resources	Resource location
Information about Dell products and services	<a href="#">Dell Site</a>
Tips	
Contact Support	In Windows search, type <code>Contact Support</code> , and press Enter.
Online help for operating system	<a href="#">Windows Support Site</a> <a href="#">Linux Support Site</a>
Access top solutions, diagnostics, drivers and downloads, and learn more about your computer through videos, manuals, and documents.	Your Dell computer is uniquely identified using a Service Tag or Express Service Code. To view relevant support resources for your Dell computer, enter the Service Tag or Express Service Code at <a href="#">Dell Support Site</a> .  For more information about how to find the Service Tag for your computer, see <a href="#">Locate the Service Tag on your computer</a> .
Dell knowledge base articles	<ol style="list-style-type: none"> <li>1. Go to <a href="#">Dell Support Site</a>.</li> <li>2. On the menu bar at the top of the Support page, select <b>Support &gt; Support Library</b>.</li> <li>3. In the Search field on the Support Library page, type the keyword, topic, or model number, and then click or tap the search icon to view the related articles.</li> </ol>

## Contacting Dell

To contact Dell for sales, technical support, or customer service issues, see [Dell Support Site](#).

 **NOTE:** Availability of the services may vary depending on the country or region, and product.

 **NOTE:** If you do not have an active Internet connection, you can find contact information about your purchase invoice, packing slip, bill, or Dell product catalog.