

# OptiPlex Small Form Factor 7020

## Owner's Manual

## Notes, cautions, and warnings

 **NOTE:** A NOTE indicates important information that helps you make better use of your product.

 **CAUTION:** A CAUTION indicates either potential damage to hardware or loss of data and tells you how to avoid the problem.

 **WARNING:** A WARNING indicates a potential for property damage, personal injury, or death.

|   |           |
|---|-----------|
| <b>Chapter 1: Views of OptiPlex Small Form Factor 7020</b> .....          | <b>7</b>  |
| Front.....  | 7         |
| Back.....   | 9         |
| <b>Chapter 2: Set up your computer</b> .....                              | <b>11</b> |
| <b>Chapter 3: Specifications of OptiPlex Small Form Factor 7020</b> ..... | <b>15</b> |
| Dimensions and weight.....  | 15        |
| Processor.....  | 15        |
| Chipset.....  | 16        |
| Operating system.....   | 17        |
| Memory.....   | 17        |
| Memory matrix.....  | 18        |
| External ports and slots.....   | 18        |
| Internal slots.....   | 19        |
| Ethernet.....   | 19        |
| Wireless module.....  | 20        |
| Audio.....  | 20        |
| Storage.....  | 20        |
| Storage matrix.....   | 21        |
| Redundant Array of Independent Disks (RAID).....                          | 21        |
| Power ratings.....  | 22        |
| Power supply connector.....   | 22        |
| GPU—Integrated.....   | 23        |
| Video port resolution (GPU—Integrated).....                               | 23        |
| External display support (GPU—Integrated).....                            | 23        |
| GPU—Discrete.....   | 24        |
| Video port resolution (GPU—Discrete).....                                 | 24        |
| External display support (GPU—Discrete).....                              | 24        |
| Hardware security.....  | 25        |
| Environmental.....  | 25        |
| Regulatory compliance.....  | 26        |
| Operating and storage environment.....                                    | 26        |
| <b>Chapter 4: Working inside your computer</b> .....                      | <b>27</b> |
| Safety instructions.....  | 27        |
| Before working inside your computer.....                                  | 27        |
| Safety precautions.....   | 28        |
| Electrostatic discharge—ESD protection.....                               | 28        |
| ESD Field Service kit .....   | 29        |
| Transporting sensitive components.....                                    | 30        |
| After working inside your computer.....                                   | 30        |
| BitLocker.....  | 30        |
| Recommended tools.....  | 30        |

|  |           |
|--|-----------|
| Screw list.....  | 31        |
| Major components of OptiPlex Small Form Factor 7020.....                         | 32        |
| <b>Chapter 5: Removing and installing side cover.....</b>                        | <b>35</b> |
| Removing the side cover.....   | 35        |
| Installing the side cover.....   | 35        |
| <b>Chapter 6: Removing and installing coin-cell battery.....</b>                 | <b>37</b> |
| Removing the coin-cell battery.....  | 37        |
| Installing the coin-cell battery.....  | 37        |
| <b>Chapter 7: Removing and installing Customer Replaceable Units (CRUs).....</b> | <b>39</b> |
| Front bezel .....  | 39        |
| Removing the front bezel.....  | 39        |
| Installing the front bezel.....  | 40        |
| 3.5-inch hard drive.....   | 41        |
| Removing the 3.5-inch hard drive.....  | 41        |
| Installing the 3.5-inch hard drive.....  | 43        |
| Disk-drive cage.....   | 45        |
| Removing the disk-drive cage.....  | 45        |
| Installing the disk-drive cage.....  | 47        |
| Optical drive.....   | 48        |
| Removing the optical drive.....  | 48        |
| Installing the optical drive.....  | 50        |
| Memory.....  | 51        |
| Removing the memory module.....  | 51        |
| Installing the memory module.....  | 52        |
| Solid-state drives.....  | 53        |
| Removing the M.2 2230 solid-state drive.....                                     | 53        |
| Installing the M.2 2230 solid-state drive.....                                   | 53        |
| Removing the M.2 2280 solid-state drive.....                                     | 55        |
| Installing the M.2 2280 solid-state drive.....                                   | 56        |
| Dell Ultra Speed Drive Gen3 card.....  | 58        |
| Wireless card.....   | 65        |
| Removing the wireless card.....  | 65        |
| Installing the wireless card.....  | 66        |
| External puck antenna.....   | 67        |
| Graphics card.....   | 67        |
| Removing the graphics card.....  | 67        |
| Installing the graphics card.....  | 68        |
| Internal speaker.....  | 70        |
| Removing the internal speaker.....   | 70        |
| Installing the internal speaker.....   | 70        |
| Intrusion switch.....  | 71        |
| Removing the intrusion switch.....   | 71        |
| Installing the Intrusion switch.....   | 72        |
| <b>Chapter 8: Removing and installing Field Replaceable Units (FRUs).....</b>    | <b>74</b> |
| Power button.....  | 74        |

|   |            |
|---|------------|
| Removing the power button.....  | 74         |
| Installing the power button.....  | 75         |
| Wireless antenna module.....  | 76         |
| Internal antenna module.....  | 76         |
| External SMA antenna module.....  | 81         |
| Power-supply unit.....  | 84         |
| Removing the power-supply unit.....                                     | 84         |
| Installing the power-supply unit.....                                   | 86         |
| Processor fan and heat-sink assembly.....                               | 87         |
| Removing the processor fan and heat-sink assembly.....                  | 87         |
| Installing the processor fan and heat-sink assembly.....                | 88         |
| Processor.....  | 89         |
| Removing the processor.....   | 89         |
| Installing the processor.....   | 90         |
| Optional Input/Output modules.....                                      | 91         |
| Serial module.....  | 91         |
| VGA module.....   | 94         |
| DP module.....  | 96         |
| HDMI module.....  | 98         |
| System board.....   | 100        |
| Removing the system board.....  | 100        |
| Installing the system board.....  | 104        |
| <b>Chapter 9: Software.....</b>   | <b>110</b> |
| Operating system.....   | 110        |
| Drivers and downloads.....  | 110        |
| <b>Chapter 10: BIOS Setup.....</b>                                      | <b>111</b> |
| Entering BIOS Setup program.....  | 111        |
| Navigation keys.....  | 111        |
| F12 One Time Boot menu.....   | 111        |
| System setup options.....   | 112        |
| Updating the BIOS.....  | 124        |
| Updating the BIOS in Windows.....                                       | 124        |
| Updating the BIOS in Linux and Ubuntu.....                              | 125        |
| Updating the BIOS using the USB drive in Windows.....                   | 125        |
| Updating the BIOS from the One-Time boot menu.....                      | 125        |
| System and setup password.....  | 126        |
| Assigning a System Setup password.....                                  | 126        |
| Deleting or changing an existing system password or setup password..... | 127        |
| Clearing CMOS settings.....   | 127        |
| Clearing BIOS (System Setup) and System passwords.....                  | 127        |
| <b>Chapter 11: Troubleshooting.....</b>                                 | <b>128</b> |
| Dell SupportAssist Pre-boot System Performance Check diagnostics.....   | 128        |
| Running the SupportAssist Pre-Boot System Performance Check.....        | 128        |
| Power-Supply Unit Built-in Self-Test .....                              | 128        |
| System-diagnostic lights.....   | 129        |
| Recovering the operating system.....                                    | 129        |

Real Time Clock—RTC reset.....130  
Backup media and recovery options..... 130  
Wi-Fi power cycle..... 130

**Chapter 12: Getting help and contacting Dell..... 131**

# Views of OptiPlex Small Form Factor 7020

## Front

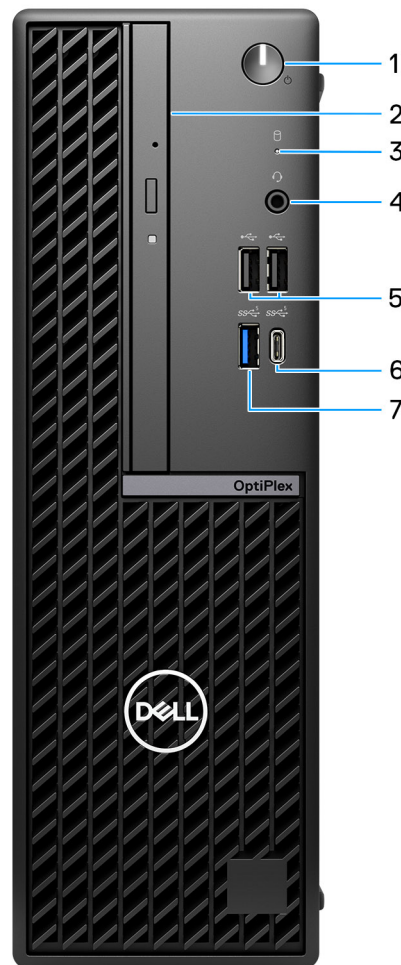

Figure 1. Front view

### 1. Power button with diagnostic LED

Press to turn on the computer if it is turned off, in Sleep state, or in Hibernate state.

When the computer is turned on, press the power button to put the computer into Sleep state; press and hold the power button for four seconds to force shut-down the computer.

**NOTE:** You can customize the power-button behavior in Windows.

Indicates the power-supply state.

**2. Slim optical drive (optional)**

Reads from and writes to CDs and DVDs.

**3. Hard-drive activity light**

The activity light turns on when the computer reads from or writes to the hard drive.

**4. Universal audio port**

Connect headphones or a headset (headphone and microphone combo).

**5. Two USB 2.0 (480 Mbps) ports**

Connect devices such as external storage devices and printers. Provides data transfer speeds of up to 480 Mbps.

**6. USB 3.2 Gen 1 (5 Gbps) Type-C port**

Connect to external storage devices. Provides data transfer speeds up to 5 Gbps.

 **NOTE:** This port does not support video/audio streaming.

**7. USB 3.2 Gen 1 (5 Gbps) port**

Connect devices such as external storage devices and printers. Provides data transfer speeds up to 5 Gbps.



# Back

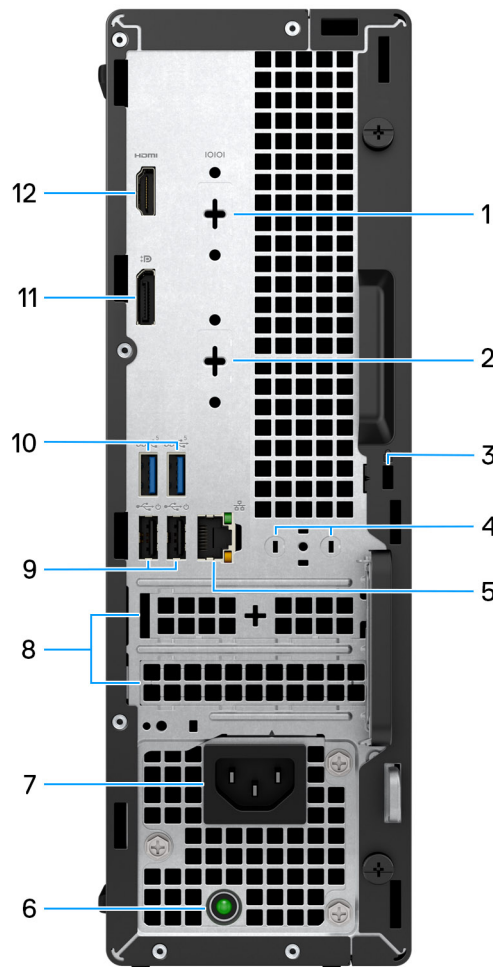

Figure 2. Back view

**1. Serial port (optional)**

Connect serial I/O devices.

**2. Optional port (HDMI 2.1/DisplayPort 1.4a (HBR3 support)/VGA)**

The port available at this location may vary depending on the optional I/O card that is installed on your computer.

- **HDMI 2.1 port**

Connect to a TV, external display, or another HDMI-in enabled device. Maximum resolution supported up to 4096x2160 @60Hz.

- **DisplayPort 1.4a (HBR3 support)**

Connect an external display or a projector. Maximum resolution supported up to 5120x3200 @60Hz.

- **VGA port**

Connect an external display or a projector. Maximum resolution supported up to 1920x1200 @60Hz.

**3. Security-cable slot (for Kensington locks)**

Connect a security cable to prevent unauthorized movement of your computer.

**4. External antenna slot**

Connect an external antenna for better connectivity.

**5. Network port**

Connect an Ethernet (RJ45) cable from a router or a broadband modem for network or Internet access.

**6. Power-supply diagnostic light**

Indicates the power-supply state.

**7. Power-cord connector port**

Connect a power cable to provide power to your computer.

**8. Two expansion card slots**

Connect a PCI-Express card such as graphics, audio, or network card to enhance the capabilities of your computer.

**9. Two USB 2.0 (480 Mbps) with SmartPower On ports**

Connect devices such as external storage devices and printers. Provides data transfer speeds of up to 480 Mbps.

 **NOTE:** When USB wake is enabled in the BIOS, the computer turns on or wake from hibernation when a USB mouse or keyboard that is connected to this port is used.

**10. Two USB 3.2 Gen 1 (5 Gbps) ports**

Connect devices such as external storage devices and printers. Provides data transfer speeds of up to 5 Gbps.

**11. DisplayPort 1.4a (HBR2 support) port**

Connect an external display or a projector.

 **NOTE:** The maximum resolution that is supported is up to 4096x2304 @60Hz.

**12. HDMI 1.4b port**

Connect to a TV, external display, or another HDMI-in enabled device. Provides video and audio output.

 **NOTE:** The maximum resolution that is supported is up to 1920 x 1200 @ 60Hz.

## Set up your computer

### Steps

1. Connect the keyboard and mouse.

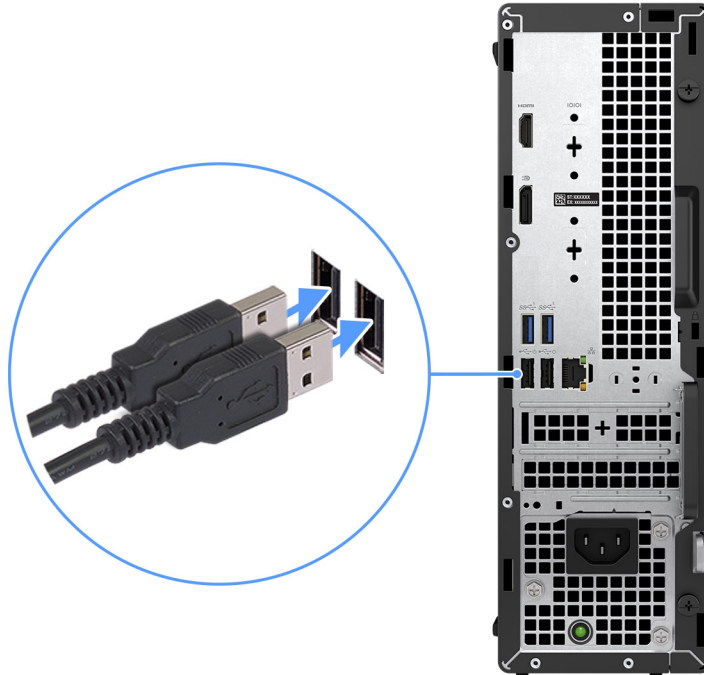

2. Connect to your network using a cable, or connect to a wireless network.

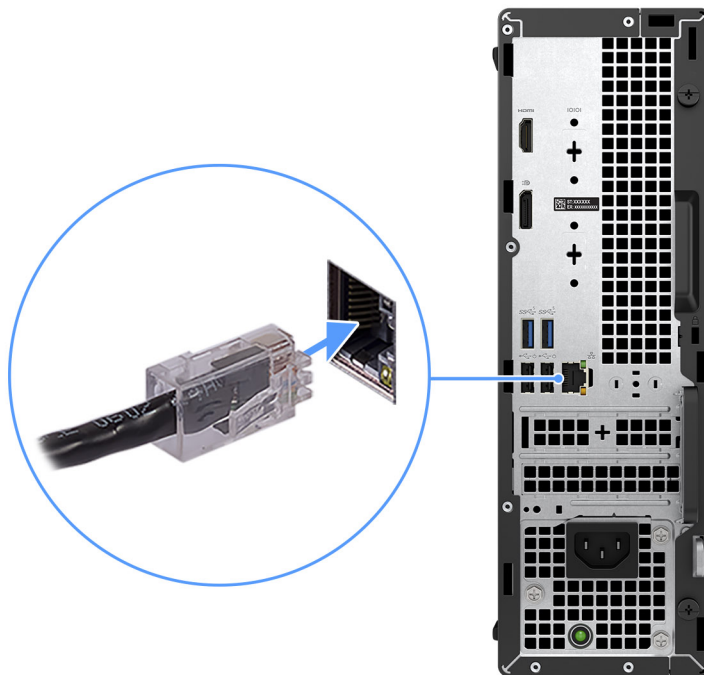

3. Connect the display.



4. Connect the power cable.

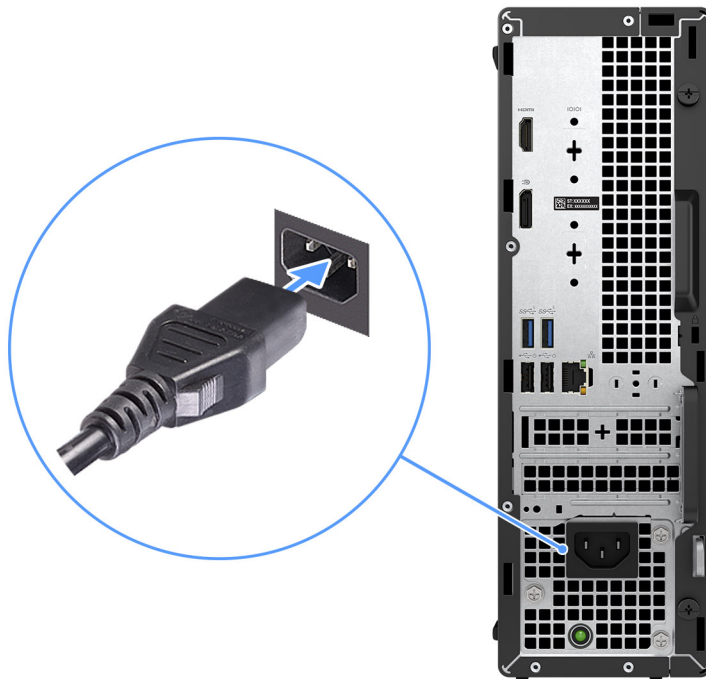

5. Press the power button.



6. Finish operating system setup.

**For Ubuntu:**

Follow the on-screen instructions to complete the setup. For more information about installing and configuring Ubuntu, search in the Knowledge Base Resource at [Dell Support Site](#).



**For Windows:**

Follow the on-screen instructions to complete the setup. When setting up, Dell Technologies recommends that you:

- Connect to a network for Windows updates.
  - **NOTE:** If connecting to a secured wireless network, enter the password for the wireless network access when prompted.
- If connected to the Internet, sign-in with or create a Microsoft account. If not connected to the Internet, create an offline account.
- On the **Support and Protection** screen, enter your contact details.

7. Locate and use Dell apps from the Windows Start menu—Recommended

**Table 1. Locate Dell apps**

| Resources   | Description  |
|---|--|
|  | <p><b>SupportAssist</b></p> <p>SupportAssist proactively and predictively identifies hardware and software issues on your computer and automates the engagement process with Dell Technical support. It addresses performance and stabilization issues, prevents security threats, monitors, and detects hardware failures. For more information, see <i>SupportAssist for Home PCs User's Guide</i> at <a href="#">Serviceability Tools at Dell Site</a>. Click <b>SupportAssist</b> and then, click <b>SupportAssist for Home PCs</b>.</p> <p><b>NOTE:</b> In SupportAssist, click the warranty expiry date to renew or upgrade your warranty.</p> |
|  | <p><b>Dell Update</b></p> <p>Updates your computer with critical fixes and latest device drivers as they become available. For more information on using Dell Update, search in the Knowledge Base Resource at <a href="#">Dell Support Site</a>.</p>  |

**Table 1. Locate Dell apps (continued)**

| <b>Resources</b>  | <b>Description</b>   |
|---|--|
|  | <p><b>Dell Digital Delivery</b></p> <p>Download software applications, which are purchased but not preinstalled on your computer. For more information on using Dell Digital Delivery, search in the Knowledge Base Resource at <a href="#">Dell Support Site</a>.</p> |

# Specifications of OptiPlex Small Form Factor 7020

## Dimensions and weight

The following table lists the height, width, depth, and weight of your OptiPlex Small Form Factor 7020.

**Table 2. Dimensions and weight**

| Description  | Values  |
|--|---|
| Height   | 290 mm (11.41 in.)  |
| Width  | 92.60 mm (3.64 in.)   |
| Depth  | 292.80 mm (11.52 in.)   |
| Weight<br> <b>NOTE:</b> The weight of your computer depends on the configuration ordered and manufacturing variability. | <ul style="list-style-type: none"> <li>• Minimum: 4.08 kg (8.99 lb)</li> <li>• Maximum: 5.38 kg (11.86 lb)</li> </ul> |

## Processor

The following table lists the details of the processors that are supported by your OptiPlex Small Form Factor 7020.

**Table 3. Processor**

| Description  | Option one               | Option two               | Option three           | Option four                              | Option five                         | Option six             |
|--|--------------------------|--------------------------|------------------------|--|-------------------------------------|------------------------|
| Processor type   | Intel Core i5 14600 vPro | Intel Core i5 14500 vPro | Intel Core i3 14100    | 12th Generation Intel Core i5-12500 vPro | 12th Generation Intel Core i3-12100 | Intel 300              |
| Processor wattage  | 65 W                     | 65 W                     | 60 W                   | 65 W                                     | 60 W                                | 46 W                   |
| Processor total core count   | 14                       | 14                       | 4                      | 6  | 4                                   | 2                      |
| Performance-cores  | 6                        | 6                        | 4                      | 6  | 4                                   | 2                      |
| Efficient-cores  | 8                        | 8                        | 0                      | 0  | 0                                   | 0                      |
|  <b>NOTE:</b> Intel® Hyper-Threading Technology is only available on Performance-cores. |                          |                          |                        |  |                                     |                        |
| Processor total thread counts  | 20                       | 20                       | 8                      | 12                                       | 8                                   | 4                      |
| Processor speed  | Up to 5.20 GHz           | Up to 5 GHz              | Up to 4.70 GHz         | Up to 4.60 GHz                           | Up to 4.30 GHz                      | Up to 3.90 GHz         |
| Performance-cores frequency  |                          |                          |                        |  |                                     |                        |
| Processor base frequency   | 2.70 GHz                 | 2.60 GHz                 | 3.50 GHz               | 3 GHz                                    | 3.30 GHz                            | 3.90 GHz               |
| Maximum turbo frequency  | 5.20 GHz                 | 5 GHz                    | 4.70 GHz               | 4.60 GHz                                 | 4.30 GHz                            | Not applicable         |
| Efficient-cores frequency  |                          |                          |                        |  |                                     |                        |
| Processor base frequency   | 2.70 GHz                 | 1.90 GHz                 | Not applicable         | Not applicable                           | Not applicable                      | Not applicable         |
| Maximum turbo frequency  | 3.90 GHz                 | 3.70 GHz                 | Not applicable         | Not applicable                           | Not applicable                      | Not applicable         |
| Processor cache  | 24 MB                    | 24 MB                    | 12 MB                  | 18 MB                                    | 12 MB                               | 6 MB                   |
| Integrated graphics  | Intel UHD Graphics 770   | Intel UHD Graphics 770   | Intel UHD Graphics 730 | Intel UHD Graphics 770                   | Intel UHD Graphics 730              | Intel UHD Graphics 710 |

## Chipset

The following table lists the details of the chipset that is supported in your OptiPlex Small Form Factor 7020.

**Table 4. Chipset**

| Description | Values   |
|-------------|--|
| Chipset     | Intel Q670   |
| Processor   | <ul style="list-style-type: none"> <li>Intel Core i3/i5 vPro</li> <li>Intel 300</li> </ul> |



**Table 4. Chipset (continued)**

| Description    | Values                 |
|----------------|------------------------|
| DRAM bus width | 64-bit/128-bit         |
| Flash EPROM    | 32 MB RPMC+16 MB nRPMC |
| PCIe bus       | Up to Gen4             |

## Operating system

Your OptiPlex Small Form Factor 7020 supports the following operating systems:

- Windows 11 Home
- Windows 11 Pro
- Windows 11 Pro National Education
- Ubuntu Linux 22.04 LTS

## Memory

The following table lists the memory specifications that are supported by your OptiPlex Small Form Factor 7020.

**Table 5. Memory specifications**

| Description                     | Values   |
|---------------------------------|--|
| Memory slots                    | Two UDIMM slots  |
| Memory type                     | DDR5   |
| Memory speed                    | <ul style="list-style-type: none"> <li>• 4800 MT/s for computers shipped with Intel 300, Intel Core i3 14100 or i5 14500 vPro, 12th Gen Intel Core i3-12100 or i5-12500 vPro processors</li> <li>• 5600 MT/s for computers shipped with Intel Core i5 14600 vPro processors</li> </ul>   |
| Maximum memory configuration    | 64 GB  |
| Minimum memory configuration    | 8 GB   |
| Memory size per slot            | 8 GB, 16 GB, or 32 GB  |
| Memory configurations supported | <p><b>For computers shipped with Intel 300, Intel Core i3 14100 or i5 14500 vPro, 12th Gen Intel Core i3-12100 or i5-12500 vPro processors:</b></p> <ul style="list-style-type: none"> <li>• 8 GB: 1 x 8 GB, DDR5, 4800 MT/s, UDIMM, single-channel</li> <li>• 16 GB: 1 x 16 GB, DDR5, 4800 MT/s, UDIMM, single-channel</li> <li>• 16 GB: 2 x 8 GB, DDR5, 4800 MT/s, UDIMM, dual-channel</li> <li>• 32 GB: 1 x 32 GB, DDR5, 4800 MT/s, UDIMM, single-channel</li> <li>• 32 GB: 2 x 16 GB, DDR5, 4800 MT/s, UDIMM, dual-channel</li> <li>• 64 GB: 2 x 32 GB, DDR5, 4800 MT/s, UDIMM, dual-channel</li> </ul> <p><b>For computers shipped with Intel Core i5 14600 vPro processor:</b></p> |

**Table 5. Memory specifications (continued)**

| Description | Values  |
|-------------|---|
|             | <ul style="list-style-type: none"> <li>8 GB: 1 x 8 GB, DDR5, 5600 MT/s, UDIMM, single-channel</li> <li>16 GB: 1 x 16 GB, DDR5, 5600 MT/s, UDIMM, single-channel</li> <li>16 GB: 2 x 8 GB, DDR5, 5600 MT/s, UDIMM, dual-channel</li> <li>32 GB: 1 x 32 GB, DDR5, 5600 MT/s, UDIMM, single-channel</li> <li>32 GB: 2 x 16 GB, DDR5, 5600 MT/s, UDIMM, dual-channel</li> <li>64 GB: 2 x 32 GB, DDR5, 5600 MT/s, UDIMM, dual-channel</li> </ul> |

## Memory matrix

The following table lists the memory configurations supported on your OptiPlex Small Form Factor 7020.

**Table 6. Memory matrix**

| Configuration | Slot   |        |
|---------------|--------|--------|
|               | UDIMM1 | UDIMM2 |
| 8 GB DDR5     | 8 GB   |        |
| 16 GB DDR5    | 16 GB  |        |
| 16 GB DDR5    | 8 GB   | 8 GB   |
| 32 GB DDR5    | 32 GB  |        |
| 32 GB DDR5    | 16 GB  | 16 GB  |
| 64 GB DDR5    | 32 GB  | 32 GB  |

## External ports and slots

The following table lists the external ports of your OptiPlex Small Form Factor 7020.

**Table 7. External ports and slots**

| Description   | Values   |
|---------------|--|
| Network port  | One RJ-45 port 10/100/100 Mbps   |
| USB ports     | <ul style="list-style-type: none"> <li>Two USB 2.0 (480 Mbps) ports</li> <li>One USB 3.2 Gen 1 (5 Gbps) port</li> <li>One USB 3.2 Gen 1 Type-C (5 Gbps) port</li> <li><b>NOTE:</b> This port does not support video/audio streaming.</li> <li>Two USB 2.0 (480 Mbps) with SmartPower On ports</li> <li>Two USB 3.2 Gen 1 (5 Gbps) ports</li> </ul> |
| Audio port    | One Universal audio port   |
| Video port(s) | <ul style="list-style-type: none"> <li>One optional port (HDMI 2.1/DisplayPort 1.4a (HBR3 support)/VGA)</li> <li><b>NOTE:</b> The maximum resolution supported by optional port is <ul style="list-style-type: none"> <li><b>HDMI 2.1 port:</b> Up to 4096x2160 @60Hz.</li> </ul> </li> </ul>  |

**Table 7. External ports and slots (continued)**

| Description         | Values   |
|---------------------|--|
|                     | <ul style="list-style-type: none"> <li>○ <b>DisplayPort 1.4a (HBR3 support) port:</b> Up to 5120x3200 @60Hz.</li> <li>○ <b>VGA port:</b> Up to 1920x1200 @60Hz.</li> <li>● One DisplayPort 1.4a (HBR2 support) port</li> <li> ⓘ <b>NOTE:</b> The maximum resolution that is supported is up to 4096x2304 @60Hz.</li> <li>● One HDMI 1.4b port</li> <li> ⓘ <b>NOTE:</b> The maximum resolution supported is up to 1920 x 1200 @ 60 Hz.</li> </ul> |
| Media-card reader   | Not supported  |
| Power-adaptor port  | Not supported  |
| Security-cable slot | <ul style="list-style-type: none"> <li>● Security-cable slot (for Kensington locks)</li> <li>● One Padlock ring</li> </ul>   |

## Internal slots

The following table lists the internal slots of your OptiPlex Small Form Factor 7020.

**Table 8. Internal slots**

| Description | Values  |
|-------------|---|
| Expansion   | <ul style="list-style-type: none"> <li>● One Half-height Gen3 PCIe x16 slot</li> <li>● One Half-height Gen3 PCIe x1 slot</li> </ul>   |
| M.2         | <ul style="list-style-type: none"> <li>● One M.2 2230 slot for Wi-Fi and Bluetooth combo card</li> <li>● One M.2 2230/2280 slot for solid-state drive</li> <li> ⓘ <b>NOTE:</b> To learn more about the features of different types of M.2 cards, search in the Knowledge Base Resource at <a href="#">Dell Support Site</a>.</li> </ul> |
| SATA slots  | <p>Two SATA 3.0 slots for 3.5-inch hard-disk drive and slim optical drive.</p> <li> ⓘ <b>NOTE:</b> Installing a slim optical drive causes the SATA 3.0 port to operate as SATA 2.0 port.</li>   |

## Ethernet

The following table lists the wired Ethernet Local Area Network (LAN) specifications of your OptiPlex Small Form Factor 7020.

**Table 9. Ethernet specifications**

| Description   | Values           |
|---------------|------------------|
| Model number  | Intel WGI219LM   |
| Transfer rate | 10/100/1000 Mbps |

# Wireless module

The following table lists the Wireless Local Area Network (WLAN) module specifications of your OptiPlex Small Form Factor 7020.

**Table 10. Wireless module specifications**

| Description               | Option one  | Option two   | Option three   |
|---------------------------|---|--|--|
| Model number              | Intel AX210   | Realtek RTL8852BE  | Realtek RTL8851BE  |
| Transfer rate             | Up to 2400 Mbps   | Up to 867 Mbps   | Up to TBD Mbps   |
| Frequency bands supported | 2.4 GHz/5 GHz/6 GHz   | 2.40 GHz/5 GHz   | 2.40 GHz/5 GHz   |
| Wireless standards        | <ul style="list-style-type: none"> <li>• WiFi 802.11a/b/g</li> <li>• Wi-Fi 4 (WiFi 802.11n)</li> <li>• Wi-Fi 5 (WiFi 802.11ac)</li> <li>• Wi-Fi 6E (WiFi 802.11ax)</li> </ul>   | <ul style="list-style-type: none"> <li>• WiFi 802.11a/b/g</li> <li>• Wi-Fi 4 (WiFi 802.11n)</li> <li>• Wi-Fi 5 (WiFi 802.11ac)</li> <li>• Wi-Fi 6 (WiFi 802.11ax)</li> </ul> | <ul style="list-style-type: none"> <li>• WiFi 802.11a/b/g</li> <li>• Wi-Fi 4 (WiFi 802.11n)</li> <li>• Wi-Fi 5 (WiFi 802.11ac)</li> <li>• Wi-Fi 6 (WiFi 802.11ax)</li> </ul> |
| Encryption                | <ul style="list-style-type: none"> <li>• 64-bit/128-bit WEP</li> <li>• AES-CCMP</li> <li>• TKIP</li> </ul>  | <ul style="list-style-type: none"> <li>• 64-bit/128-bit WEP</li> <li>• AES-CCMP</li> <li>• TKIP</li> </ul>   | <ul style="list-style-type: none"> <li>• 64-bit/128-bit WEP</li> <li>• AES-CCMP</li> <li>• TKIP</li> </ul>   |
| Bluetooth wireless card   | Bluetooth 5.3   | Bluetooth 5.3  | Bluetooth 5.3  |
|                           |  <b>NOTE:</b> The version of the Bluetooth wireless card may vary depending on the operating system that is installed on your computer. |  |  |

# Audio

The following table lists the audio specifications of your OptiPlex Small Form Factor 7020.

**Table 11. Audio specifications**

| Description              | Values                      |
|--------------------------|-----------------------------|
| Audio type               | High Definition Audio       |
| Audio controller         | Realtek ALC3204-CG          |
| Internal audio interface | High Definition Audio (HDA) |
| External audio interface | Universal audio jack        |

# Storage

This section lists the storage options on your OptiPlex Small Form Factor 7020.

**Table 12. Storage specifications**

| Storage type                         | Interface type           | Capacity   |
|--------------------------------------|--------------------------|------------|
| 3.5-inch hard-disk drive, 7200 RPM   | SATA 3.0                 | Up to 2 TB |
| M.2 2230 solid-state drive, Class 25 | PCIe NVMe, up to 32 Gbps | Up to 2 TB |
| M.2 2230 solid-state drive, Class 35 | PCIe NVMe, up to 32 Gbps | Up to 1 TB |

**Table 12. Storage specifications (continued)**

| Storage type  | Interface type           | Capacity   |
|---|--------------------------|------------|
| M.2 2230 solid-state drive, Class 35, Self-Encrypting drive | PCIe NVMe, up to 32 Gbps | 256 GB     |
| M.2 2280 solid-state drive, Class 40                        | PCIe NVMe, up to 32 Gbps | Up to 1 TB |
| M.2 2280 solid-state drive, Class 40, Self-Encrypting drive | PCIe NVMe, up to 32 Gbps | Up to 1 TB |

## Storage matrix

The following table lists the storage configurations supported on your OptiPlex Small Form Factor 7020.

**Table 13. Storage matrix**

| Storage  | Slot                                      |                       |       |
|--|---|-----------------------|-------|
|  | SSD0 (Primary M.2 PCIe for boot function) | SLOT2 (PCIe x16 slot) | SATA0 |
| One M.2 2230/2280 solid-state drive  | Yes                                       |                       |       |
| One M.2 2230/2280 solid-state drive<br>+<br>One 3.5-inch hard-disk drive   | Yes                                       |                       | Yes   |
| One M.2 2230/2280 solid-state drive<br>+<br>One M.2 2230/2280 solid-state drive (via PCIe Expansion card)                                      | Yes                                       | Yes                   |       |
| One M.2 2230/2280 solid-state drive<br>+<br>One 3.5-inch hard-disk drive<br>+<br>One M.2 2230/2280 solid-state drive (via PCIe Expansion card) | Yes                                       | Yes                   | Yes   |

## Redundant Array of Independent Disks (RAID)

For optimal performance when configuring drives as a RAID volume, Dell Technologies recommends drive models that are identical.

 **NOTE:** RAID is not supported on Intel Optane configurations.

RAID 0 (Striped, Performance) volumes benefit from higher performance when drives are matched because the data is split across multiple drives: any I/O operations with block sizes larger than the stripe size splits the I/O and become constrained by the slowest of the drives. For RAID 0 I/O operations where block sizes are smaller than the stripe size, whichever drive the I/O operation targets, determines the performance, which increases variability and results in inconsistent latencies. This variability is particularly pronounced for write operations, and it can be problematic for applications that are latency sensitive. One such example of this is any application that performs thousands of random writes per second in very small block sizes.

RAID 1 (Mirrored, Data Protection) volumes benefit from higher performance when drives are matched because the data is mirrored across multiple drives all I/O operations must be performed identically to both drives, thus variations in drive performance when the models are different result in the I/O operations completing only as fast as the slowest drive. While this does not suffer from the variable latency issue in small random I/O operations as with RAID 0 across heterogeneous drives, the impact is nonetheless large because the higher performing drive becomes limited in all I/O types. One of the worst examples

of constrained performance here is when using unbuffered I/O. To ensure that that writes are fully committed to nonvolatile regions of the RAID volume, unbuffered I/O bypasses cache (for example by using the Force Unit Access bit in the NVMe protocol) and the I/O operation will not complete until all the drives in the RAID volume have completed the request to commit the data. This kind of I/O operation completely negates any advantage of a higher performing drive in the volume.

Care must be taken to match not only the drive vendor, capacity, and class, but also the specific model. Drives from the same vendor, with the same capacity, and even within the same class, can have different performance characteristics for certain types of I/O operations. Thus, matching by model ensures that the RAID volume consists of a homogeneous array of drives that deliver all the benefits of a RAID volume without incurring the additional penalties when one or more drives in the volume are lower performing.

## Power ratings

The following table lists the power rating specifications of OptiPlex Small Form Factor 7020.

**Table 14. Power ratings**

| Description                 | Option one  | Option two  |
|-----------------------------|---|---|
| Type                        | 180 W internal power supply unit (PSU), 85% Efficient, 80 Plus Bronze   | 300 W internal power supply unit (PSU), 92% Efficient, 80 Plus Platinum   |
| Input voltage               | 90 VAC - 264 VAC  | 90 VAC - 264 VAC  |
| Input frequency             | 47 Hz - 63 Hz   | 47 Hz - 63 Hz   |
| Input current (maximum)     | 3.0 A   | 4.2 A   |
| Output current (continuous) | <ul style="list-style-type: none"> <li>● 12 VA / 15 A</li> <li>● 12 VB / 14 A</li> </ul> Standby mode: <ul style="list-style-type: none"> <li>● 12 VA / 1.5 A</li> <li>● 12 VB / 3.3 A</li> </ul> | <ul style="list-style-type: none"> <li>● 12 VA / 18 A</li> <li>● 12 VB / 18 A</li> </ul> Standby mode: <ul style="list-style-type: none"> <li>● 12 VA / 1.5 A</li> <li>● 12 VB / 3.3 A</li> </ul> |
| Rated output voltage        | <ul style="list-style-type: none"> <li>● +12 VA</li> <li>● +12 VB</li> </ul>  | <ul style="list-style-type: none"> <li>● +12 VA</li> <li>● +12 VB</li> </ul>  |
| Temperature range           |   |   |
| Operating                   | 5°C to 45°C (41°F to 113°F)   | 5°C to 45°C (41°F to 113°F)   |
| Storage                     | -40°C to 70°C (-40°F to 158°F)  | -40°C to 70°C (-40°F to 158°F)  |

## Power supply connector

The following table lists the Power supply connector specifications of your OptiPlex Small Form Factor 7020.

**Table 15. Power supply connector**

| Power supply unit   | Connectors   |
|---|--|
| 180 W internal power supply unit (PSU), 85% Efficient, 80 Plus Bronze   | <ul style="list-style-type: none"> <li>● Two 4 pin connectors for processor</li> <li>● One 8 pin connector for system board</li> </ul> |
| 300 W internal power supply unit (PSU), 92% Efficient, 80 Plus Platinum | <ul style="list-style-type: none"> <li>● Two 4 pin connectors for processor</li> <li>● One 8 pin connector for system board</li> </ul> |

# GPU—Integrated

The following table lists the specifications of the integrated Graphics Processing Unit (GPU) supported by your OptiPlex Small Form Factor 7020.

**Table 16. GPU—Integrated**

| Controller             | External display support  | Memory size          | Processor   |
|------------------------|---|----------------------|---|
| Intel UHD Graphics 710 | <ul style="list-style-type: none"> <li>One DisplayPort 1.4a (HBR2 support) port</li> <li>One HDMI 1.4b port</li> <li>One video port (HDMI 2.1/ Displayport 1.4a (HBR3)/ VGA)(optional)</li> </ul> | Shared system memory | Intel 300 processor   |
| Intel UHD Graphics 730 | <ul style="list-style-type: none"> <li>One DisplayPort 1.4a (HBR2 support) port</li> <li>One HDMI 1.4b port</li> <li>One video port (HDMI 2.1/ Displayport 1.4a (HBR3)/ VGA)(optional)</li> </ul> | Shared system memory | <ul style="list-style-type: none"> <li>Intel Core i3 14100 processor</li> <li>12th Generation Intel Core i3-12100 processor</li> </ul>                              |
| Intel UHD Graphics 770 | <ul style="list-style-type: none"> <li>One DisplayPort 1.4a (HBR2 support) port</li> <li>One HDMI 1.4b port</li> <li>One video port (HDMI 2.1/ Displayport 1.4a (HBR3)/ VGA)(optional)</li> </ul> | Shared system memory | <ul style="list-style-type: none"> <li>Intel Core i5 14500 vPro and i5 14600 vPro processors</li> <li>12th Generation Intel Core i5-12500 vPro processor</li> </ul> |

## Video port resolution (GPU—Integrated)

**Table 17. Video port resolution (GPU—Integrated)**

| Graphics card      | Video ports   | Maximum supported resolution  |
|--------------------|---|---|
| Intel UHD Graphics | <ul style="list-style-type: none"> <li>One HDMI 1.4b port</li> <li>One DisplayPort 1.4a (HBR2 support) port</li> <li>One video port (HDMI 2.1/ Displayport 1.4a (HBR3)/VGA) (optional)</li> </ul> | <ul style="list-style-type: none"> <li>HDMI 1.4b port - 1920 x 1200 @ 60 Hz</li> <li>DisplayPort 1.4a port - 4096 x 2304 @60Hz</li> <li>One video port (HDMI 2.1/ Displayport 1.4a (HBR3)/VGA) (optional) - maximum resolution supported by HDMI 2.1 is up to 4096 x 2160 @60Hz, DisplayPort 1.4a (HBR3) is up to 5120 x 3200 @60Hz, VGA is up to 1920 x 1200 @60Hz,</li> </ul> |

## External display support (GPU—Integrated)

Display support for the integrated graphics card

**Table 18. Display support specifications**

| Graphics card                  | Supported external displays   |
|--------------------------------|---|
| Intel UHD Graphics 710/730/770 | <ul style="list-style-type: none"> <li>With MST- 4</li> <li>Without MST- 2</li> </ul> |

**Table 18. Display support specifications (continued)**

| Graphics card                                    | Supported external displays   |
|--|---|
| Intel UHD Graphics 710/730/770 + optional module | <ul style="list-style-type: none"> <li>• With MST- 4</li> <li>• Without MST- 3</li> </ul> |

**NOTE:** MST (Multi-Stream Transport)/daisy-chaining supports four displays.

## GPU—Discrete

**Table 19. GPU—Discrete**

| Controller         | External display support               | Memory size | Memory type  |
|--------------------|--|-------------|--------------|
| AMD Radeon RX 6500 | Two DisplayPort 1.4a ( DP1.4a*2) ports | 4 GB        | 64-bit, DDR6 |
| AMD Radeon RX 6300 | Two DisplayPort 1.4a ( DP1.4a*2) ports | 2 GB        | 64-bit, DDR6 |

## Video port resolution (GPU—Discrete)

**Table 20. Video port resolution (GPU—Discrete)**

| Graphics card      | Video port                             | Maximum supported resolution  |
|--------------------|--|---|
| AMD Radeon RX 6300 | Two DisplayPort 1.4a ( DP1.4a*2) ports | For one-port configuration - <ul style="list-style-type: none"> <li>• With DSC enabled - 8K @ 60 Hz</li> <li>• Without DSC enabled - 5120 x 2880 @ 60 Hz</li> </ul> |
| AMD Radeon RX 6500 | Two DisplayPort 1.4a ( DP1.4a*2) ports | For one-port configuration - <ul style="list-style-type: none"> <li>• With DSC enabled - 8K @ 60 Hz</li> <li>• Without DSC enabled - 5120 x 2880 @ 60 Hz</li> </ul> |

## External display support (GPU—Discrete)

**Table 21. External display support (GPU—Discrete)**

| Graphics Card     | Video ports                     | Number of supported external displays | DisplayPort Multi-Stream Transport (MST) support |
|-------------------|---------------------------------|---------------------------------------|--|
| AMD Radeon RX6300 | Two DisplayPort 1.4a (DP1.4a*2) | 4                                     | Supported  |
| AMD Radeon RX6500 | Two DisplayPort 1.4a (DP1.4a*2) | 4                                     | Supported  |

**NOTE:** DisplayPort Multi-Stream Transport (MST) allows you to daisy chain monitors that have DisplayPort 1.2 and above ports and MST support. For more information about using DisplayPort Multi-Stream Transport, see [Dell Support Site](#).



# Hardware security

The following table lists the hardware security of your OptiPlex Small Form Factor 7020.

**Table 22. Hardware security**

| Hardware security  |
|--|
| Kensington security-cable slot   |
| Padlock loop   |
| Chassis lock slot support  |
| Chassis intrusion switch   |
| Lockable cable covers  |
| SafelD including Trusted Platform Module (TPM) 2.0   |
| Smart card keyboard (FIPS)   |
| Microsoft 10 Device Guard and Credential Guard (Enterprise SKU)  |
| Microsoft Windows Bitlocker  |
| Local hard drive data wipe through BIOS (Secure Erase)   |
| Self-encrypting storage drives (Opal, FIPS)  |
| Trusted Platform Module TPM 2.0  |
| China TPM  |
| Intel Secure Boot  |
| Intel Authenticate   |
| SafeBIOS: includes Dell Off-host BIOS Verification, BIOS Resilience, BIOS Recovery, and additional BIOS Controls |
| OptiPlex SFF Cable Cover   |

# Environmental

The following table lists the environmental specifications of your OptiPlex Small Form Factor 7020.

**Table 23. Environmental**

| Feature                                | Values |
|--|--------|
| Recyclable packaging                   | Yes    |
| Vertical orientation packaging support | No     |
| Multi-Pack packaging                   | Yes    |

**NOTE:** Wood-based fiber packaging contains a minimum of 35% recycled content by total weight of wood-based fiber. Packaging that contains without wood-based fiber can be claimed as Not Applicable. The anticipated required criteria for EPEAT 2018.

# Regulatory compliance

The following table lists the regulatory compliance of your OptiPlex Small Form Factor 7020.

**Table 24. Regulatory compliance**

|  |
|--|
| <b>Regulatory compliance</b>                                     |
| <a href="#">Product Safety, EMC and Environmental Datasheets</a> |
| <a href="#">Dell Regulatory Compliance Home Page</a>             |
| <a href="#">Responsible Business Alliance Policy</a>             |

# Operating and storage environment

This table lists the operating and storage specifications of your OptiPlex Small Form Factor 7020.

**Airborne contaminant level:** G1 as defined by ISA-S71.04-1985

**Table 25. Computer environment**

| Description                 | Operating  | Storage  |
|-----------------------------|--|--|
| Temperature range           | 10°C to 35°C (50°F to 95°F)  | -40°C to 65°C (-40°F to 149°F)   |
| Relative humidity (maximum) | 20% to 80% (non-condensing, Max dew point temperature = 26°C)                                | 5% to 95% (non-condensing, Max dew point temperature = 33°C)                                 |
| Vibration (maximum)*        | 0.26 GRMS random at 5 Hz to 350 Hz   | 1.37 GRMS random at 5 Hz to 350 Hz   |
| Shock (maximum)             | Bottom half-sine pulse with a change in velocity of 50.8 cm/sec (20 in./sec)                 | 105G half-sine pulse with a change in velocity of 133 cm/sec (52.5 in./sec)                  |
| Altitude range              | -15.2 m to 3048 m (-49.8 ft to 10,000 ft)  | -15.2 m to 10,668 m (-49.8 ft to 35,000 ft)  |
| Airborne Contaminants       | ISA-71 G1**†: <300A/month copper coupon corrosion AND <200A/month of silver coupon corrosion | ISA-71 G1**†: <300A/month copper coupon corrosion AND <200A/month of silver coupon corrosion |

**CAUTION:** Operating and storage temperature ranges may differ among components, so operating or storing the device outside these ranges may impact the performance of specific components.











\* Measured using a random vibration spectrum that simulates user environment.

† Measured using a 2 ms half-sine pulse.

# Working inside your computer

## Safety instructions

Use the following safety guidelines to protect your computer from potential damage and to ensure your personal safety. Unless otherwise noted, each procedure in this document assumes that you have read the safety information that shipped with your computer.



-  **WARNING:** Before working inside your computer, read the safety information that is shipped with your computer. For more safety best practices, see [Dell Regulatory Compliance Home Page](#).
-  **WARNING:** Disconnect your computer from all power sources before opening the computer cover or panels. After you finish working inside the computer, replace all covers, panels, and screws before connecting your computer to an electrical outlet.
-  **CAUTION:** To avoid damaging the computer, ensure that the work surface is flat, dry, and clean.
-  **CAUTION:** To avoid damaging the components and cards, handle them by their edges, and avoid touching the pins and the contacts.
-  **CAUTION:** You should only perform troubleshooting and repairs as authorized or directed by the Dell technical support team. Damage due to servicing that is not authorized by Dell is not covered by your warranty. See the safety instructions that is shipped with the product or at [Dell Regulatory Compliance Home Page](#).
-  **CAUTION:** Before touching anything inside your computer, ground yourself by touching an unpainted metal surface, such as the metal at the back of the computer. While you work, periodically touch an unpainted metal surface to dissipate static electricity which could harm internal components.
-  **CAUTION:** When you disconnect a cable, pull it by its connector or its pull tab, not the cable itself. Some cables have connectors with locking tabs or thumbscrews that you must disengage before disconnecting the cable. When disconnecting cables, keep them evenly aligned to avoid bending the connector pins. When connecting cables, ensure that the connector on the cable is correctly oriented and aligned with the port.
-  **CAUTION:** Press and eject any installed card from the media-card reader.
-  **CAUTION:** Exercise caution when handling rechargeable Li-ion batteries in laptops. Swollen batteries should not be used and should be replaced and disposed properly.
-  **NOTE:** The color of your computer and certain components may differ from what is shown in this document.

## Before working inside your computer

### About this task

-  **NOTE:** The images in this document may differ from your computer depending on the configuration you ordered.

### Steps

1. Save and close all open files and exit all open applications.
2. Shut down your computer. For Windows operating system, click **Start** >  **Power** > **Shut down**.
  -  **NOTE:** If you are using a different operating system, see the documentation of your operating system for shut-down instructions.

3. Disconnect your computer and all attached devices from their electrical outlets.
4. Disconnect all attached network devices and peripherals, such as keyboard, mouse, and monitor from your computer.

 **CAUTION: To disconnect a network cable, first unplug the cable from your computer and then unplug the cable from the network device.**

5. Remove any media card and optical disc from your computer, if applicable.

## Safety precautions

The safety precautions section details the primary steps to be taken before performing any disassembly instructions.

Observe the following safety precautions before you perform any installation or break-fix procedures involving disassembly or reassembly:

- Turn off the computer and all attached peripherals.
- Disconnect the computer from AC power.
- Disconnect all network cables and peripherals from the computer.
- Use an ESD field service kit when working inside any desktop to avoid electrostatic discharge (ESD) damage.
- After removing a computer component, carefully place the removed component on an anti-static mat.
- Wear shoes with non-conductive rubber soles to reduce the chance of getting electrocuted.
- Unplugging, pressing, and holding the power button for 15 seconds should discharge residual power in the system board.

## Standby power

Dell products with standby power must be unplugged before you open the case. Systems equipped with standby power are powered while turned off. The internal power enables the computer to be remotely turned on (Wake-on-LAN) and suspended into a sleep mode and has other advanced power management features.

## Bonding

Bonding is a method for connecting two or more grounding conductors to the same electrical potential. This is done by using a field service electrostatic discharge (ESD) kit. When connecting a bonding wire, ensure that it is connected to bare metal and never to a painted or nonmetal surface. Ensure that the wrist strap is secure and in full contact with your skin. Remove all jewelry such as watches, bracelets, or rings before to grounding yourself and the equipment.

## Electrostatic discharge—ESD protection

ESD is a major concern when you handle electronic components, especially sensitive components such as expansion cards, processors, memory modules, and system boards. A slight charge can damage circuits in ways that may not be obvious, such as intermittent problems or a shortened product life span. As the industry pushes for lower power requirements and increased density, ESD protection is an increasing concern.

Due to the increased density of semiconductors used in recent Dell products, the sensitivity to static damage is now higher than in previous Dell products. For this reason, some previously approved methods of handling parts are no longer applicable.

Two recognized types of ESD damage are catastrophic and intermittent failures.

- **Catastrophic** – Catastrophic failures represent approximately 20 percent of ESD-related failures. The damage causes an immediate and complete loss of device functionality. An example of catastrophic failure is a memory module that has received a static shock and immediately generates a "No POST/No Video" symptom with a beep code that is emitted for missing or non-functional memory.
- **Intermittent** – Intermittent failures represent approximately 80 percent of ESD-related failures. The high rate of intermittent failures means that most of the time when damage occurs, it is not immediately recognizable. The memory module receives a static shock, but the tracing is merely weakened and does not immediately produce outward symptoms that are related to the damage. The weakened trace may take weeks or months to melt, and in the meantime may cause degradation of memory integrity, intermittent memory errors, and so on.

Intermittent failures also called latent or "walking wounded" are difficult to detect and troubleshoot.

Perform the following steps to prevent ESD damage:

- Use a wired ESD wrist strap that is properly grounded. Wireless anti-static straps do not provide adequate protection. Touching the chassis before handling parts does not ensure adequate ESD protection on parts with increased sensitivity to ESD damage.
- Handle all static-sensitive components in a static-safe area. If possible, use anti-static floor pads and workbench pads.
- When unpacking a static-sensitive component from its shipping carton, do not remove the component from the anti-static packing material until you are ready to install the component. Before unwrapping the anti-static packaging, use the anti-static wrist strap to discharge the static electricity from your body.
- Before transporting a static-sensitive component, place it in an anti-static container or packaging.

## ESD Field Service kit

The unmonitored Field Service kit is the most commonly used service kit. Each Field Service kit includes three main components: anti-static mat, wrist strap, and bonding wire.

 **CAUTION: It is critical to keep ESD-sensitive devices away from internal parts that are insulators and often highly charged, such as plastic heat sink casings.**

## Working Environment

Before deploying the ESD Field Service kit, assess the situation at the customer location. For example, deploying the kit for a server environment is different than for a desktop or laptop environment. Servers are typically installed in a rack within a data center; desktops or laptops are typically placed on office desks or cubicles. Always look for a large open flat work area that is free of clutter and large enough to deploy the ESD kit with additional space to accommodate the type of computer that is being repaired. The workspace should also be free of insulators that can cause an ESD event. On the work area, insulators such as Styrofoam and other plastics should always be moved at least 12 inches or 30 centimeters away from sensitive parts before physically handling any hardware components.

## ESD Packaging

All ESD-sensitive devices must be shipped and received in static-safe packaging. Metal, static-shielded bags are preferred. However, you should always return the damaged part using the same ESD bag and packaging that the new part arrived in. The ESD bag should be folded over and taped shut and all the same foam packing material should be used in the original box that the new part arrived in. ESD-sensitive devices should be removed from packaging only at an ESD-protected work surface, and parts should never be placed on top of the ESD bag because only the inside of the bag is shielded. Always place parts in your hand, on the ESD mat, in the computer, or inside an anti-static bag.

## Components of an ESD Field Service kit

The components of an ESD Field Service kit are:

- **Anti-Static Mat** – The anti-static mat is dissipative and parts can be placed on it during service procedures. When using an anti-static mat, your wrist strap should be snug and the bonding wire should be connected to the anti-static mat and to any bare metal on the computer being worked on. Once deployed properly, service parts can be removed from the ESD bag and placed directly on the anti-static mat. ESD-sensitive items are safe in your hand, on the anti-static mat, in the computer, or inside an ESD bag.
- **Wrist Strap and Bonding Wire** – The wrist strap and bonding wire can be either directly connected between your wrist and bare metal on the hardware if the ESD mat is not required, or connected to the anti-static mat to protect hardware that is temporarily placed on the mat. The physical connection of the wrist strap and bonding wire between your skin, the ESD mat, and the hardware is known as bonding. Use only Field Service kits with a wrist strap, anti-static mat, and bonding wire. Never use wireless wrist straps. Always be aware that the internal wires of a wrist strap are prone to damage from normal wear and tear, and must be checked regularly with a wrist strap tester in order to avoid accidental ESD hardware damage. It is recommended to test the wrist strap and bonding wire at least once per week.
- **ESD Wrist Strap Tester** – The wires inside an ESD strap are prone to damage over time. When using an unmonitored kit, it is a best practice to regularly test the strap prior to each service call, and at a minimum, test once per week. A wrist strap tester is the best method for doing this test. If you do not have your own wrist strap tester, check with your regional office to find out if they have one. To perform the test, plug the bonding-wire of the wrist-strap into the tester while it is strapped to your wrist and push the button to test. A green LED is lit if the test is successful; a red LED is lit and an alarm sounds if the test fails.

**NOTE:** It is recommended to always use the traditional wired ESD grounding wrist strap and protective anti-static mat when servicing Dell products. In addition, it is critical to keep sensitive parts separate from all insulator parts while servicing the computer, and use anti-static bags for transporting sensitive components.

## Transporting sensitive components

When transporting ESD sensitive components such as replacement parts or parts to be returned to Dell, it is critical to place these parts in anti-static bags for safe transport.

## Lifting equipment

Adhere to the following guidelines when lifting heavy equipment:

**CAUTION:** Do not lift greater than 50 pounds. Always obtain additional resources or use a mechanical lifting device.

1. Get a firm balanced footing. Keep your feet apart for a stable base, and point your toes out.
2. Tighten stomach muscles. Abdominal muscles support your spine when you lift, offsetting the force of the load.
3. Lift with your legs, not your back.
4. Keep the load close. The closer it is to your spine, the less force it exerts on your back.
5. Keep your back upright, whether lifting or setting down the load. Do not add the weight of your body to the load. Avoid twisting your body and back.
6. Follow the same technique in reverse to set the load down.

## After working inside your computer

### About this task

**CAUTION:** Leaving stray or loose screws inside your computer may severely damage your computer.

### Steps

1. Replace all screws and ensure that no stray screws remain inside your computer.
2. Connect any external devices, peripherals, or cables you removed before working on your computer.
3. Replace any media cards, discs, or any other parts that you removed before working on your computer.
4. Connect your computer and all attached devices to their electrical outlets.
5. Turn on your computer.

## BitLocker

**CAUTION:** If BitLocker is not suspended before updating the BIOS, the BitLocker key is not recognized the next time you reboot the computer. You will then be prompted to enter the recovery key to progress, and the system displays a prompt for the recovery key on each reboot. If the recovery key is not known, this can result in data loss or an operating system reinstall. For more information, see Knowledge Article: [updating the BIOS on Dell systems with BitLocker enabled](#).

The installation of the following components triggers BitLocker:

- Hard disk drive or solid-state drive
- System board

## Recommended tools

The procedures in this document may require the following tools:

- Phillips screwdriver #0

- Phillips screwdriver #1
- Torx #5 (T5) screwdriver
- Plastic scribe













## Screw list

**NOTE:** When removing screws from a component, it is recommended to note the screw type and the quantity of screws, and then place them in a screw storage box. This is to ensure that the correct number of screws and correct screw type is restored when the component is replaced.

**NOTE:** Some computers have magnetic surfaces. Ensure that the screws are not left attached to such surfaces when replacing a component.

**NOTE:** Screw color may vary depending on the configuration ordered.

**Table 26. Screw list**

| Component                            | Screw type | Quantity | Screw image   |
|--------------------------------------|------------|----------|---|
| M.2 2230/M.2 2280 Solid-state drive  | M2x3.5     | 1        |    |
| Hard-drive and optical-drive cage    | #6-32      | 2        |    |
| Optical-drive supporting bracket     | #6-32      | 1        |   |
| 3.5-inch Hard-drive                  | #6-32      | 2        |  |
| Serial/VGA module (optional)         | M3         | 2        |  |
| DP/HDMI module (optional)            | M3x3       | 2        |  |
| WLAN card                            | M2x3.5     | 1        |  |
| Internal antenna module              | M3x3       | 2        |  |
| Processor-fan and heat-sink assembly | Captive    | 4        |  |
| Power-supply unit                    | #6-32      | 3        |  |
| Front I/O bracket                    | #6-32      | 1        |  |
| System board                         | #6-32      | 7        |  |

**Table 26. Screw list (continued)**

| Component | Screw type | Quantity | Screw image   |
|-----------|------------|----------|---|
|           | M2         | 1        |  |

## Major components of OptiPlex Small Form Factor 7020

The following image shows the major components of OptiPlex Small Form Factor 7020.



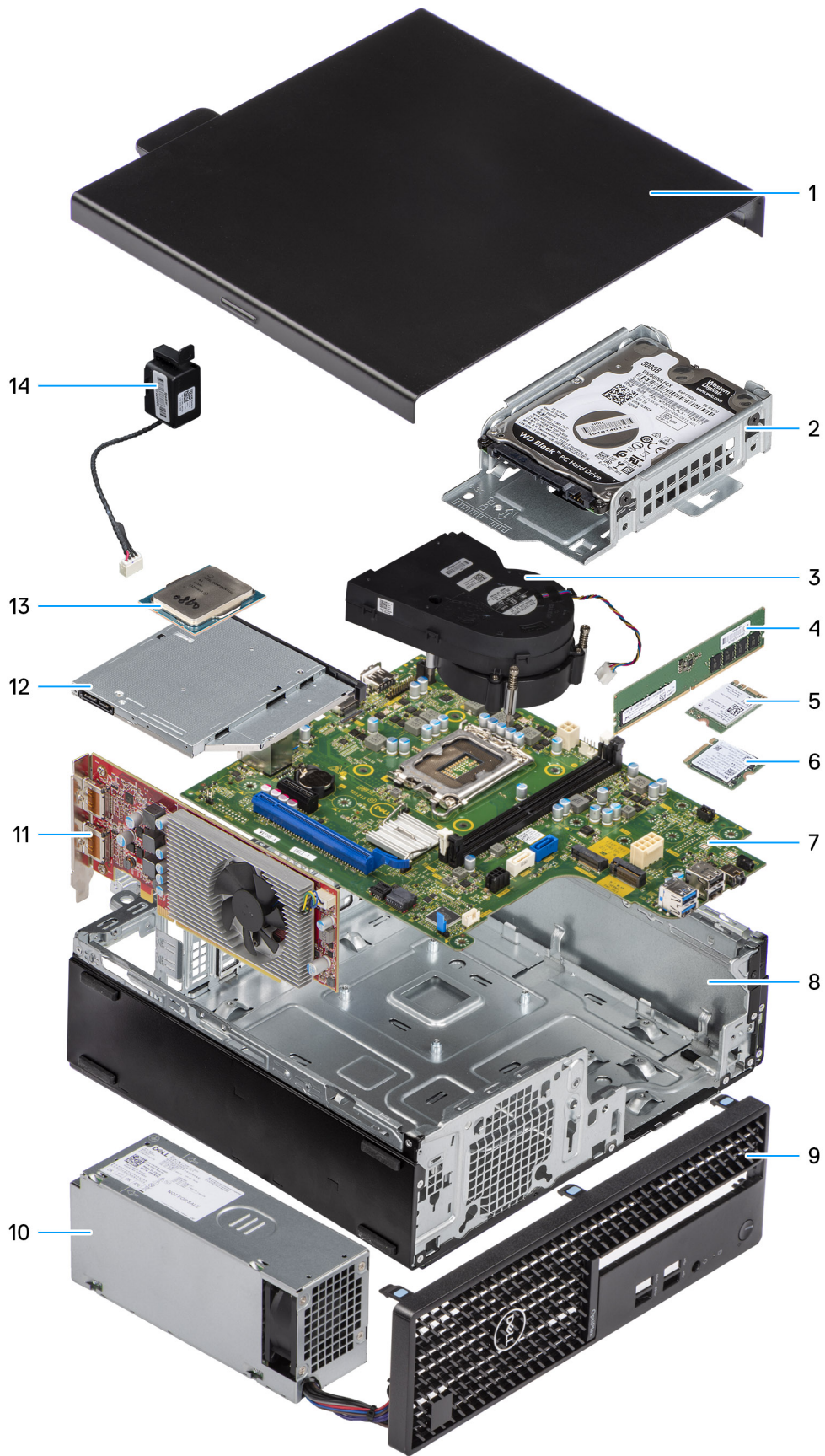

- 1. Side cover
- 3. Processor fan and heat-sink assembly
- 5. Wireless card

- 2. Hard-drive assembly
- 4. Memory module
- 6. M.2 solid-state drive

- 7. System board
- 9. Front bezel
- 11. Expansion card
- 13. Processor

- 8. Chassis
- 10. Power-supply unit
- 12. Slim optical drive
- 14. Speaker

 **NOTE:** Dell provides a list of components and their part numbers for the original system configuration purchased. These parts are available according to warranty coverages purchased by the customer. Contact your Dell sales representative for purchase options.

# Removing and installing side cover

## Removing the side cover

### Prerequisites

1. Follow the procedure in [Before working inside your computer](#).

### About this task

The following images indicate the location of the side cover and provide a visual representation of the removal procedure.

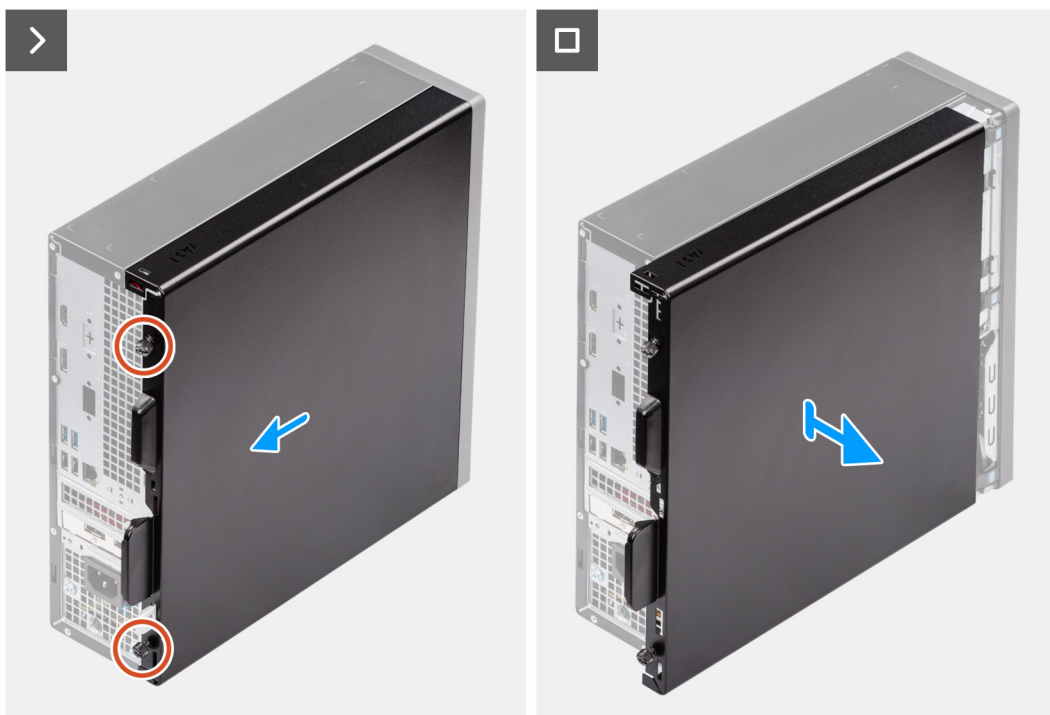

Figure 3. Removing the side cover

### Steps

1. Loosen the two captive screws that secure the side cover to the chassis.
2. Slide the side cover towards the back of the computer.
3. Lift the side cover from the chassis.

## Installing the side cover

### Prerequisites

If you are replacing a component, remove the existing component before performing the installation procedure.

### About this task

The following images indicate the location of the side cover and provide a visual representation of the installation procedure.

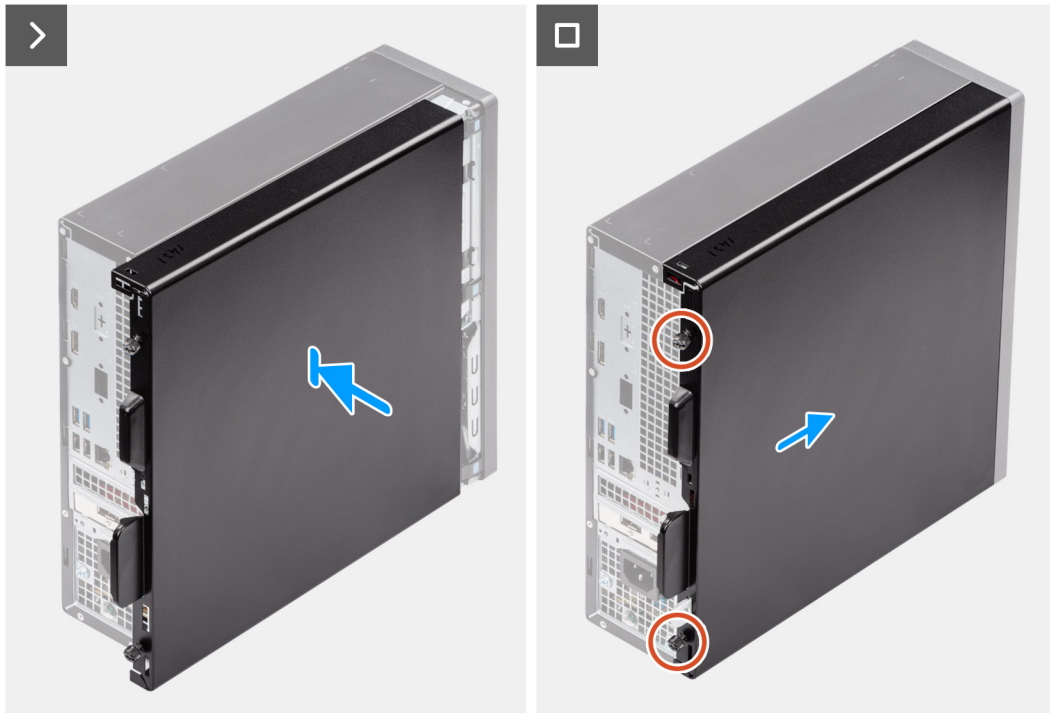

**Figure 4. Installing the side cover**

**Steps**

1. Align the tabs on the side cover with the slots on the chassis.
2. Slide the side cover towards the front of the computer.
3. Tighten the two captive screws that secure the side cover to the chassis.

**Next steps**

1. Follow the procedure in [After working inside your computer.](#)

# Removing and installing coin-cell battery

## Removing the coin-cell battery

**⚠ WARNING:** This computer contains a coin-cell battery and requires trained technicians for handling guidance.

**⚠ CAUTION:** Removing the coin-cell battery will clear the CMOS and will reset BIOS settings.

### Prerequisites

1. Follow the procedure in [Before working inside your computer](#).
2. Remove the [side cover](#).

### About this task

The following images indicate the location of the coin-cell battery and provide a visual representation of the removal procedure.

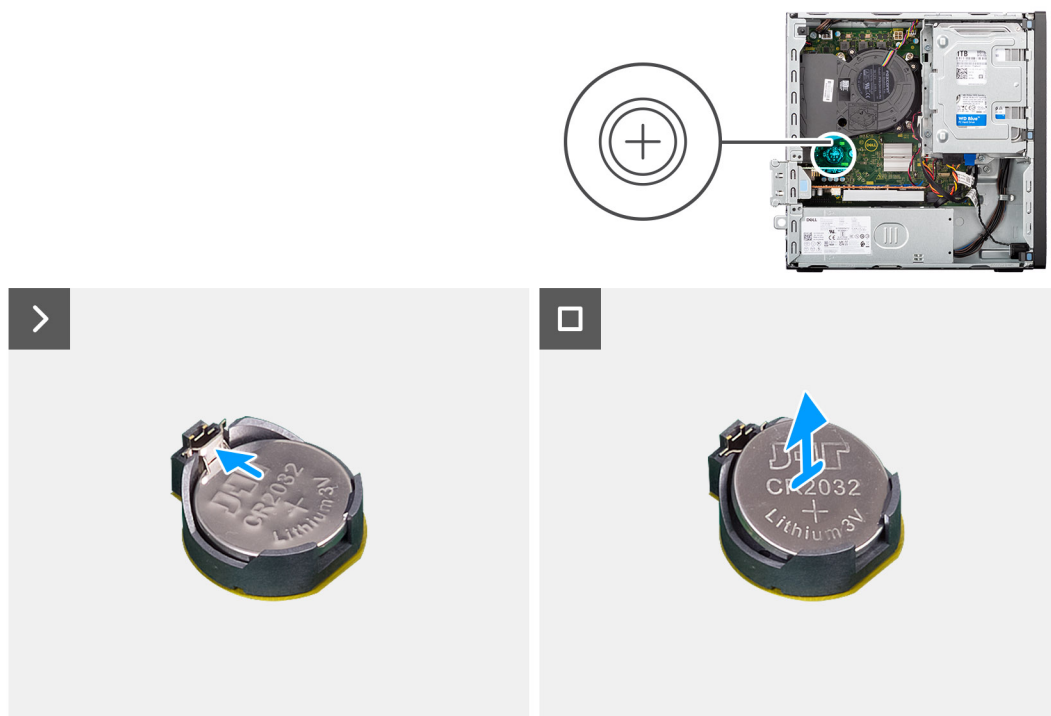

Figure 5. Removing the coin-cell battery

### Steps

1. Push the coin-cell battery-release lever on the coin-cell battery socket (RTC) to release the coin-cell battery out of the socket.
2. Remove the coin-cell battery.

## Installing the coin-cell battery

**⚠ WARNING:** This computer contains a coin-cell battery and requires trained technicians for handling guidance.

## Prerequisites

If you are replacing a component, remove the existing component before performing the installation procedure.

## About this task

The following images indicate the location of the coin-cell battery and provide a visual representation of the installation procedure.

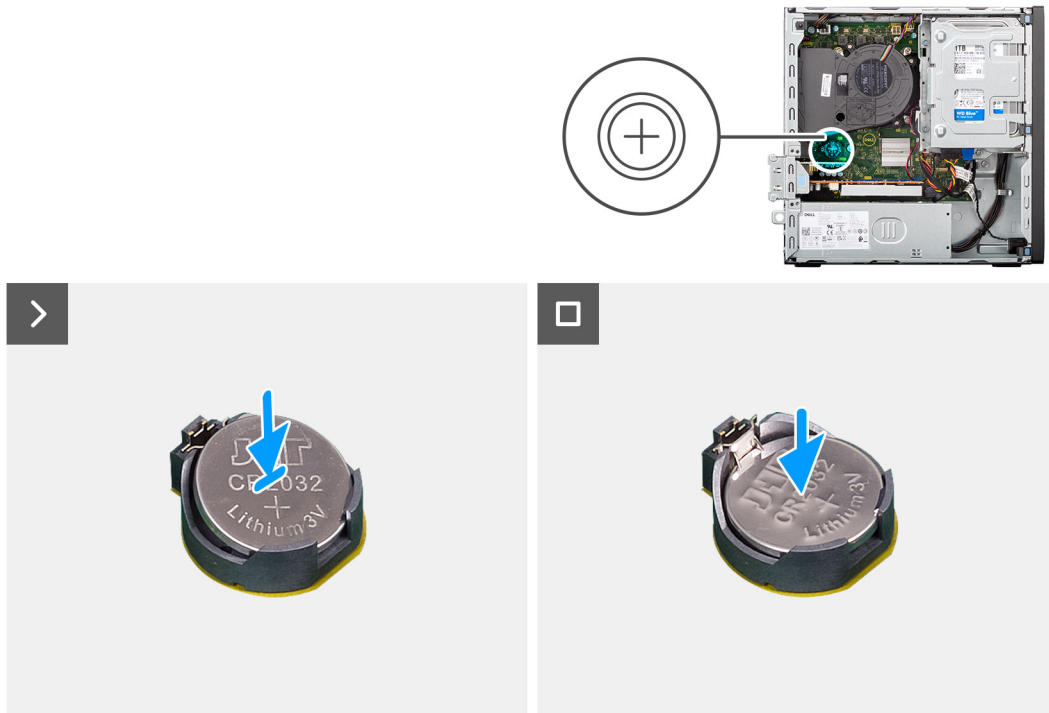

**Figure 6. Installing the coin-cell battery**

## Steps

With the positive side (+) facing up, insert the coin-cell battery into the battery socket (RTC) on the system board and snap the battery in place.

## Next steps

1. Install the [side cover](#).
2. Follow the procedure in [After working inside your computer](#).

# Removing and installing Customer Replaceable Units (CRUs)

The replaceable components in this chapter are Customer Replaceable Units (CRUs).

 **CAUTION:** Customers can replace only the Customer Replaceable Units (CRUs) following the safety precautions and replacement procedures.

 **NOTE:** The images in this document may differ from your computer depending on the configuration you ordered.

## Front bezel

### Removing the front bezel

#### Prerequisites

1. Follow the procedure in [Before working inside your computer](#).
2. Remove the [side cover](#).

#### About this task

The following images indicate the location of the front bezel and provide a visual representation of the removal procedure.



**Figure 7. Removing the front bezel**

**Steps**

1. Using a plastic scribe, gently pry and release the front-bezel tabs sequentially from the top.
2. Rotate the front bezel outward from the chassis and remove the front bezel.

## Installing the front bezel

**Prerequisites**

If you are replacing a component, remove the existing component before performing the installation procedure.

**About this task**

The following images indicate the location of the front bezel and provide a visual representation of the installation procedure.



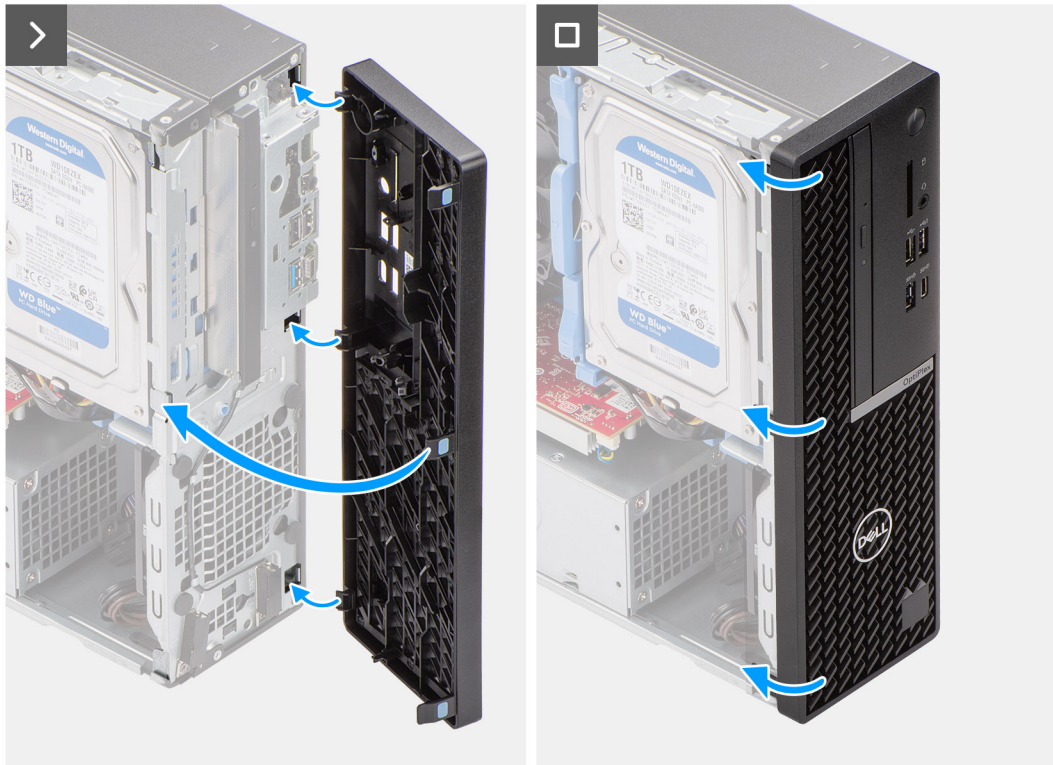

**Figure 8. Installing the front bezel**

#### Steps

1. Insert the tabs on the right side of the bezel into the corresponding slots on the chassis.
2. Push the left-side of the front bezel towards the side cover, snapping the tabs into position.

#### Next steps

1. Install the [side cover](#).
2. Follow the procedure in [After working inside your computer](#).

## 3.5-inch hard drive

### Removing the 3.5-inch hard drive

#### Prerequisites

1. Follow the procedure in [Before working inside your computer](#).
2. Remove the [side cover](#).

#### About this task

The following images indicate the location of the 3.5-inch hard drive assembly and provide a visual representation of the removal procedure.



2x  
#6-32

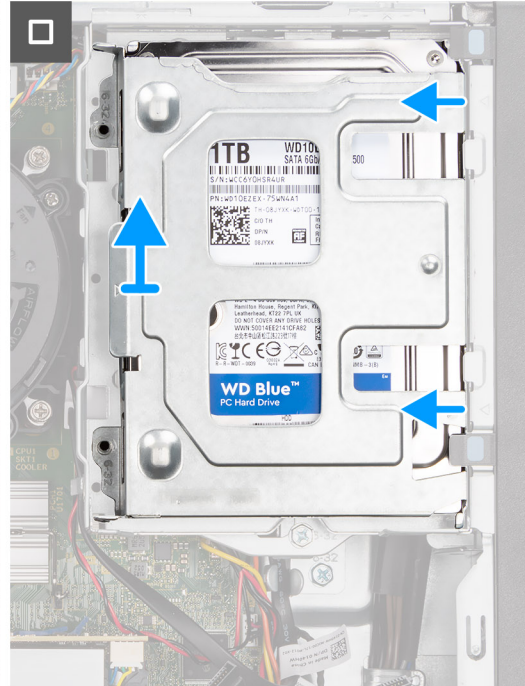
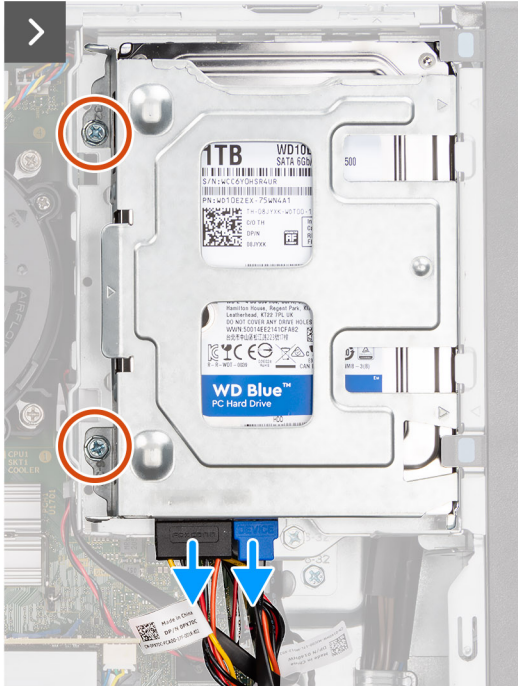
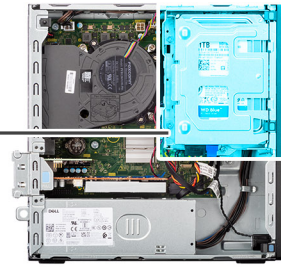



**2x**  
#6-32

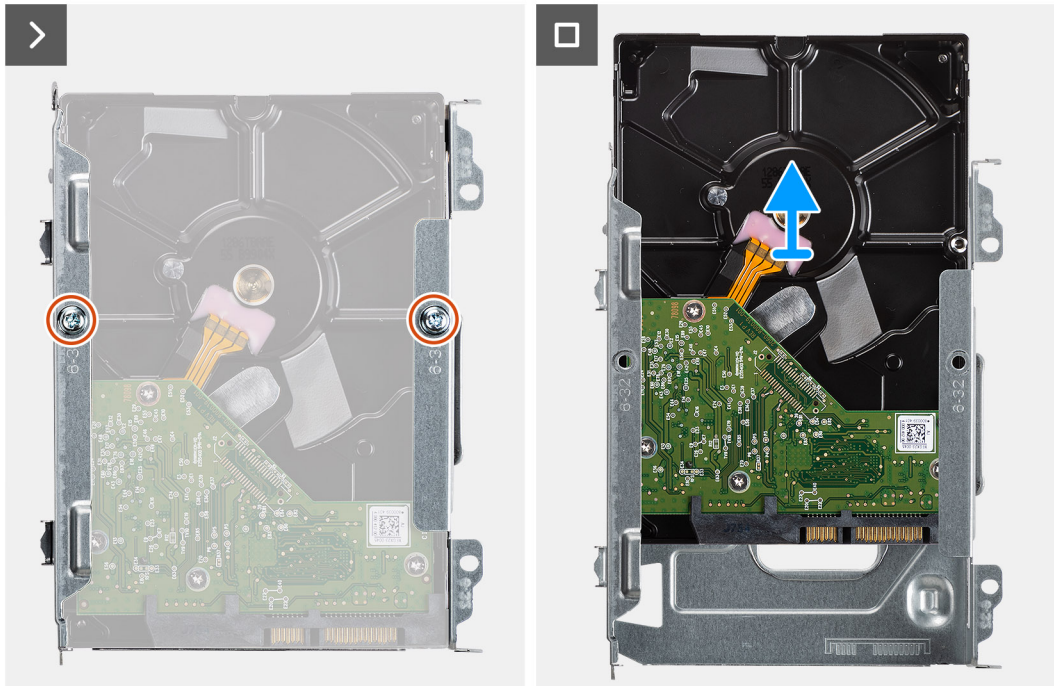

**Figure 9. Removing the 3.5-inch hard drive**

### Steps

1. Disconnect the data and power cables from the hard drive.
2. Remove the two screws (#6-32) that secure the hard-drive assembly to the chassis.
3. Slide the hard-drive assembly away from the chassis and remove the hard-drive assembly out of the disk-drive cage.
4. Remove the two screws (#6-32) that secure the hard drive to the hard-drive carrier.
5. Slide and remove the hard drive from the hard-drive carrier.

## Installing the 3.5-inch hard drive

### Prerequisites

If you are replacing a component, remove the existing component before performing the installation procedure.

### About this task

The following images indicate the location of the 3.5-inch hard drive and provide a visual representation of the installation procedure.



**2x**  
#6-32

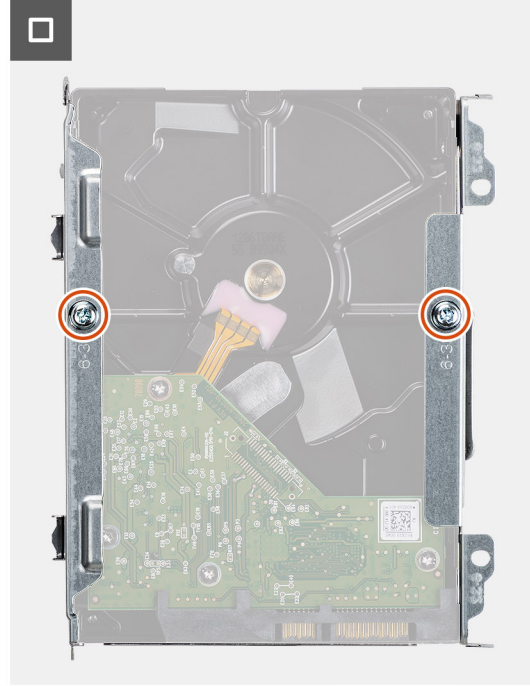
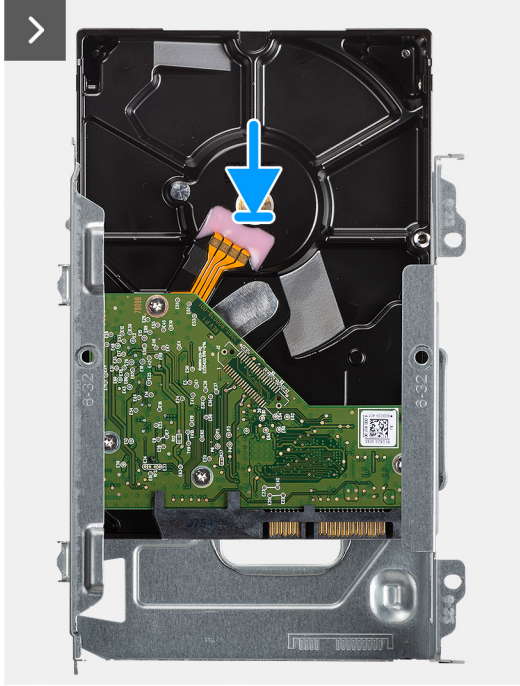

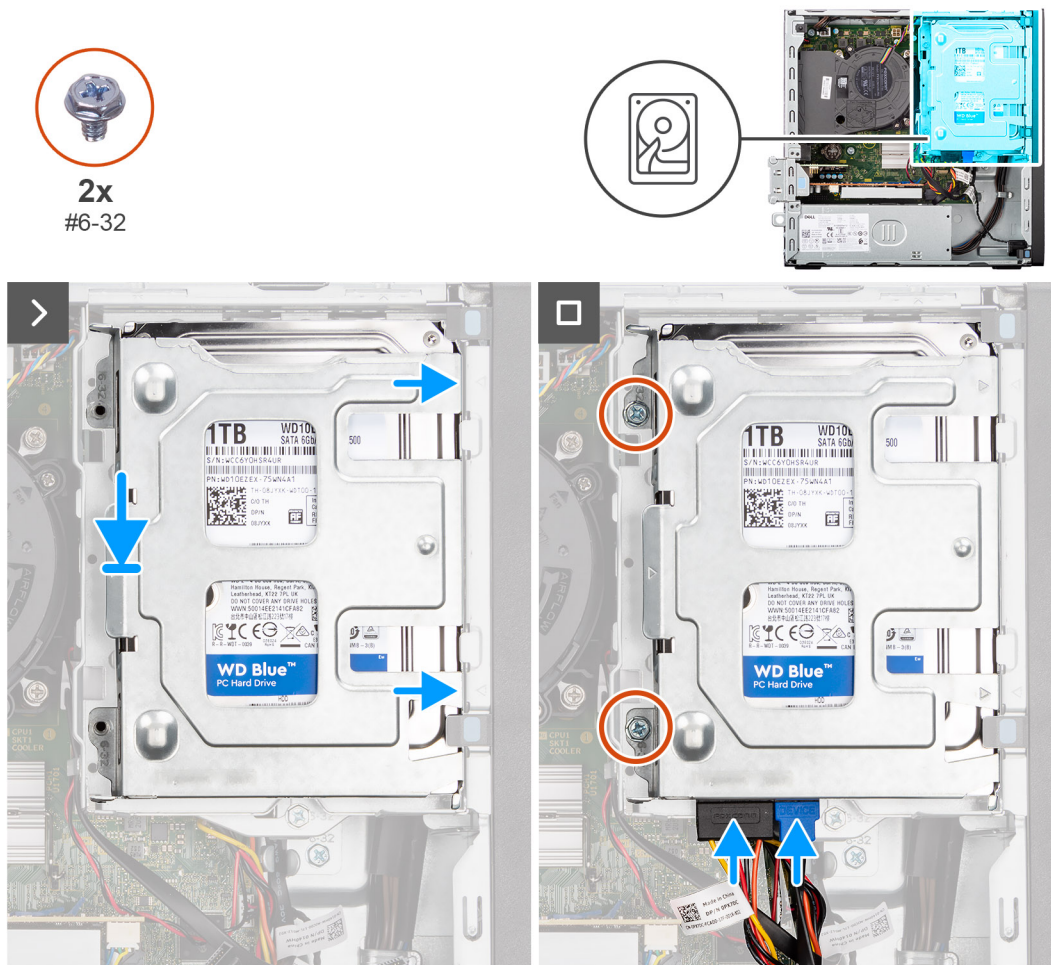

**Figure 10. Installing the 3.5-inch hard drive**

### Steps

1. Slide the hard drive into the hard-drive carrier.
2. Replace the two screws (#6-32) that secure the hard drive to the hard-drive carrier.
3. Align the tabs on the hard-drive carrier with the slots on the chassis and snap the hard-drive assembly onto the disk-drive cage.
4. Replace the two screws (#6-32) that secure the hard drive assembly on the chassis.
5. Connect the data and power cables to the connectors on the hard drive.

### Next steps

1. Install the [side cover](#).
2. Follow the procedure in [After working inside your computer](#).

## Disk-drive cage

### Removing the disk-drive cage

#### Prerequisites

1. Follow the procedure in [Before working inside your computer](#).
2. Remove the [side cover](#).
3. Remove the [front bezel](#).
4. Remove the [3.5-inch hard drive](#), if applicable.

**About this task**

The following images indicate the location of the disk-drive cage and provide a visual representation of the removal procedure.

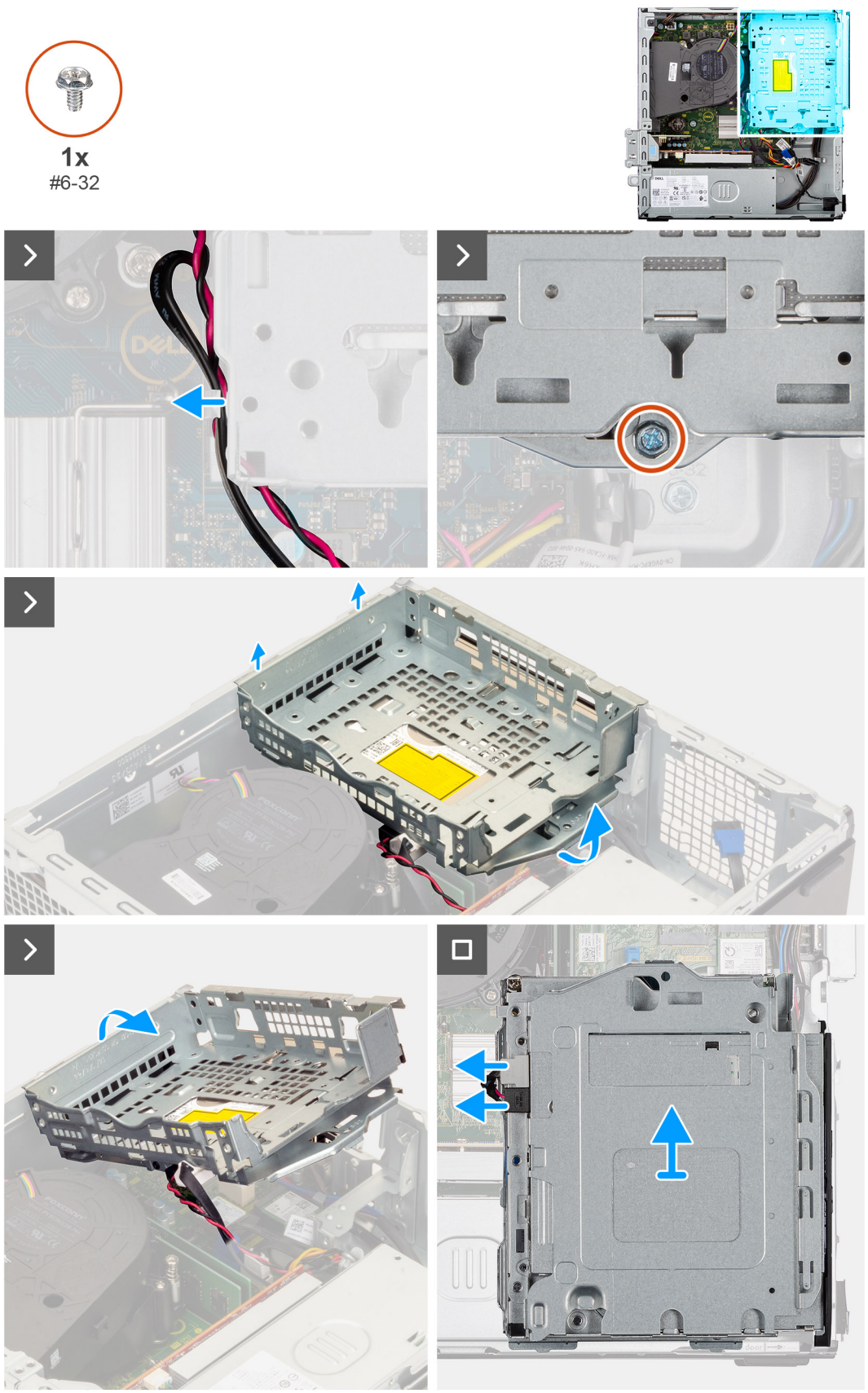

**Figure 11. Removing the disk-drive cage**

## Steps

1. If the optical drive is installed, remove the data and power cables from the routing points on the disk-drive cage.
2. Remove the screw (#6-32) that secure the disk-drive cage to the chassis.
3. Lift the disk-drive to a certain angle and slide it outwards to detach it from the mounting points on the chassis.
4. Rotate the drive-cage upside down and place it on the chassis.
5. If the optical drive is installed, disconnect the power and data cables from the connectors on the optical drive.
6. Lift the disk-drive cage away from the computer.

## Installing the disk-drive cage

### Prerequisites

If you are replacing a component, remove the existing component before performing the installation procedure.

### About this task

The following images indicate the location of the disk-drive cage and provide a visual representation of the installation procedure.



1x  
#6-32

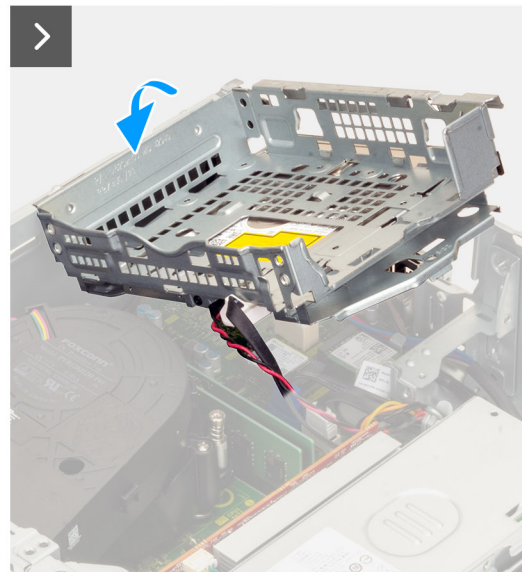
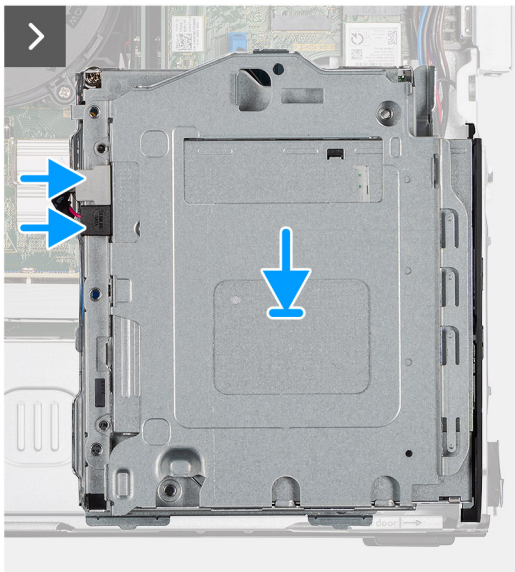

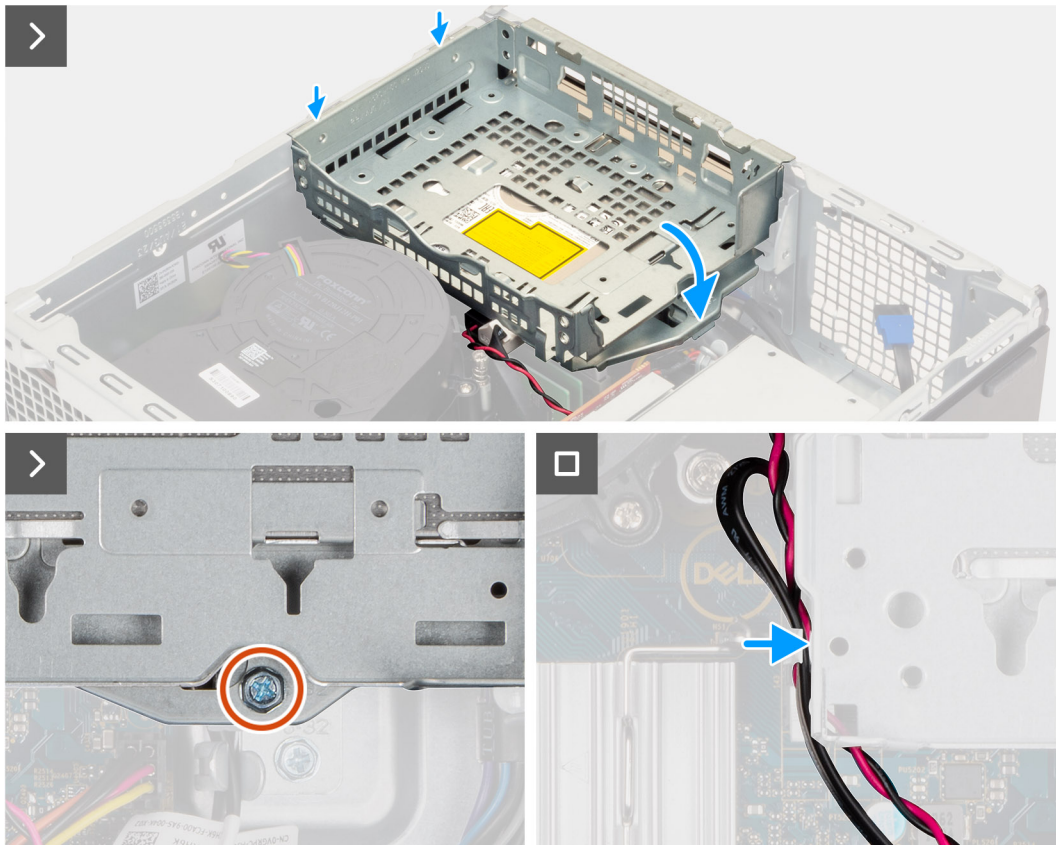

**Figure 12. Installing the disk-drive cage**

### Steps

1. Place the disk-drive cage upside down on the chassis.
2. If the optical drive is installed, connect the data and power cable to the connectors on the optical drive.
3. Rotate the disk-drive cage upside down.
4. Slide the disk-drive cage at a certain angle into its slot on the chassis and align the mounting points on the disk-drive cage with the slots on the chassis.
5. Rotate the disk-drive cage downwards until it sits in the slot in the chassis.
6. Align the screw hole on the cage with the screw hole on the chassis.
7. Replace the screw (#6-32) that secures the disk-drive cage to the chassis.
8. If the optical drive is installed, route the power and data cables through the routing guide on the disk-drive cage.

### Next steps

1. Install the [3.5-inch hard drive](#), if applicable.
2. Install the [front bezel](#).
3. Install the [side cover](#).
4. Follow the procedure in [After working inside your computer](#).

## Optical drive

### Removing the optical drive

#### Prerequisites

1. Follow the procedure in [Before working inside your computer](#).
2. Remove the [side cover](#).



3. Remove the [front bezel](#).
4. Remove the [3.5-inch hard drive](#), if applicable.
5. Remove the [disk-drive cage](#).

**About this task**

**NOTE:** The optical drive is located within the disk-drive cage. Follow the below-mentioned procedure **on the disk-drive cage** to remove or install the optical drive.

The following images indicate the location of the optical-drive assembly and provide a visual representation of the removal procedure.

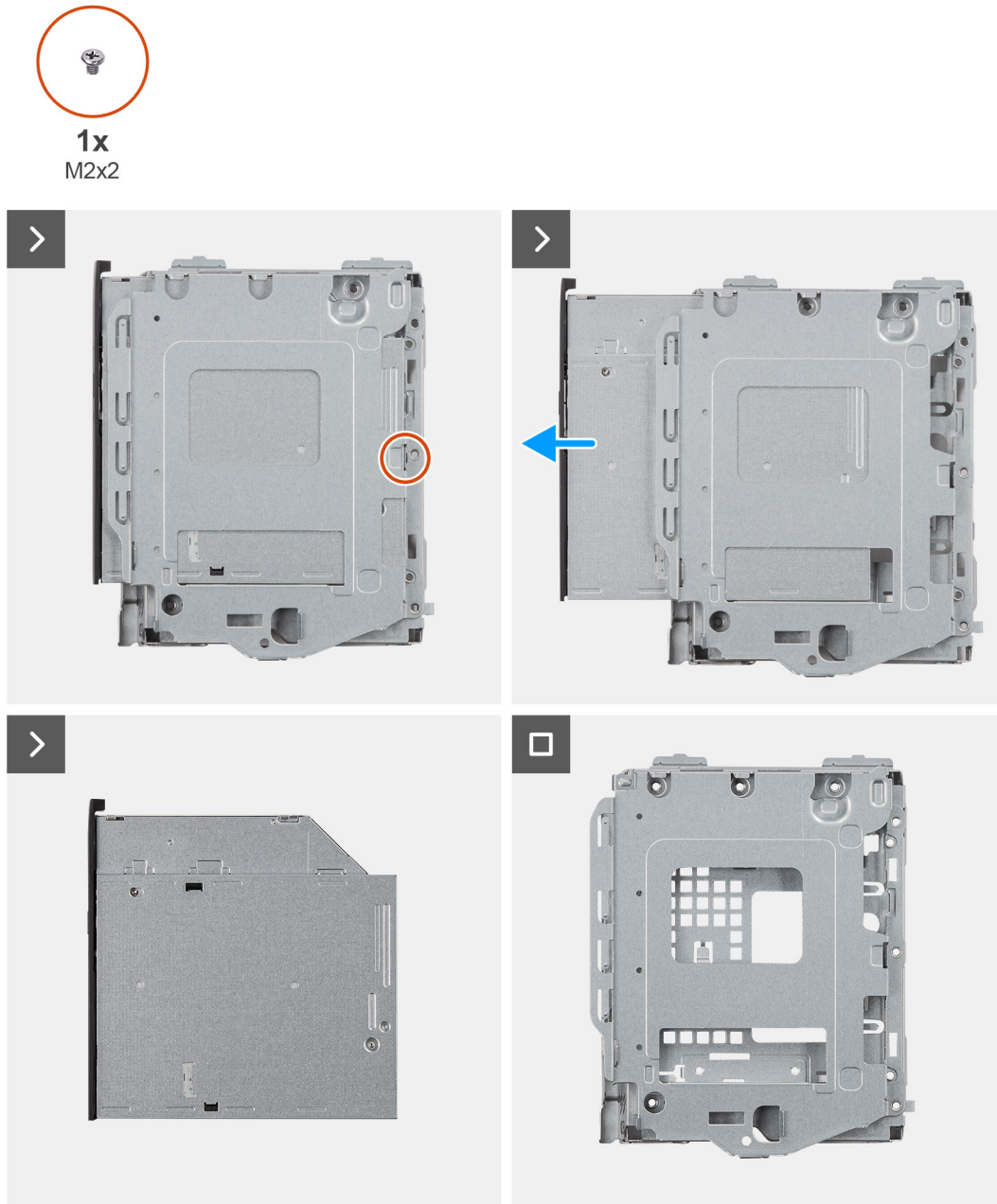

**Figure 13. Removing the optical drive**

**Steps**

1. Remove the screw (M2x2) to release the optical drive from the disk-drive cage.
2. Gently slide the optical drive out of the disk-drive cage.

# Installing the optical drive

## Prerequisites

If you are replacing a component, remove the existing component before performing the installation procedure.

## About this task

**NOTE:** The optical drive is located within the disk-drive cage. Follow the below-mentioned procedure **on the disk-drive cage** to remove or install the optical drive.

The following images indicate the location of the optical drive and provide a visual representation of the installation procedure.

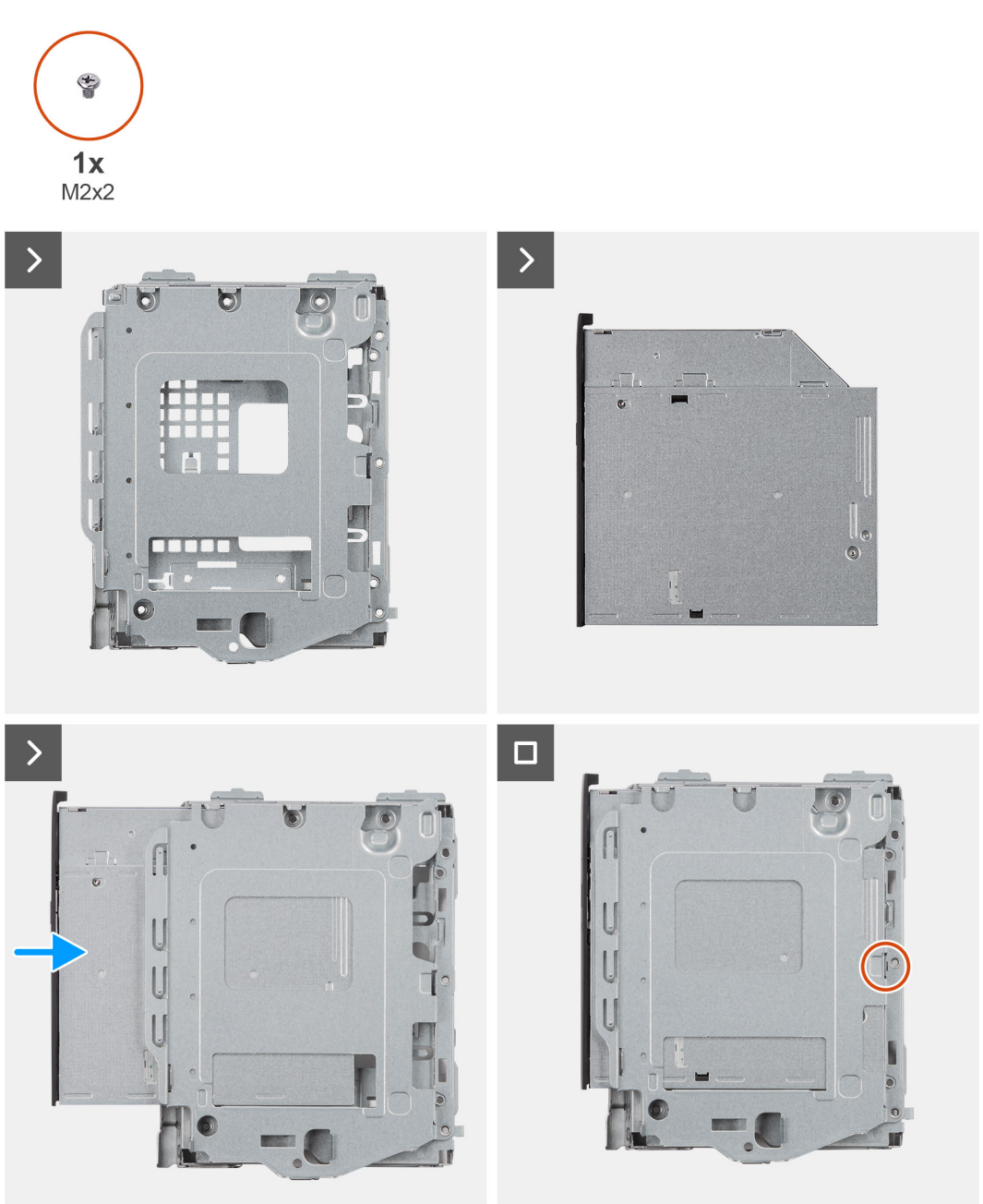

Figure 14. Installing the optical drive

## Steps

1. Slide the optical drive into the disk-drive cage until it snaps into place.

2. Install the screw (M2x2) that secures the optical drive to disk-drive cage.

### Next steps

1. Install the [disk-drive cage](#).
2. Install the [3.5-inch hard drive](#), if applicable.
3. Install the [front bezel](#).
4. Install the [side cover](#).
5. Follow the procedure in [After working inside your computer](#).

## Memory

### Removing the memory module

#### Prerequisites

1. Follow the procedure in [Before working inside your computer](#).
2. Remove the [side cover](#).
3. Remove the [front bezel](#).
4. Remove the [3.5-inch hard drive](#), if applicable.
5. Remove the [disk-drive cage](#).

#### About this task

The following images indicate the location of the memory modules and provide a visual representation of the removal procedure.

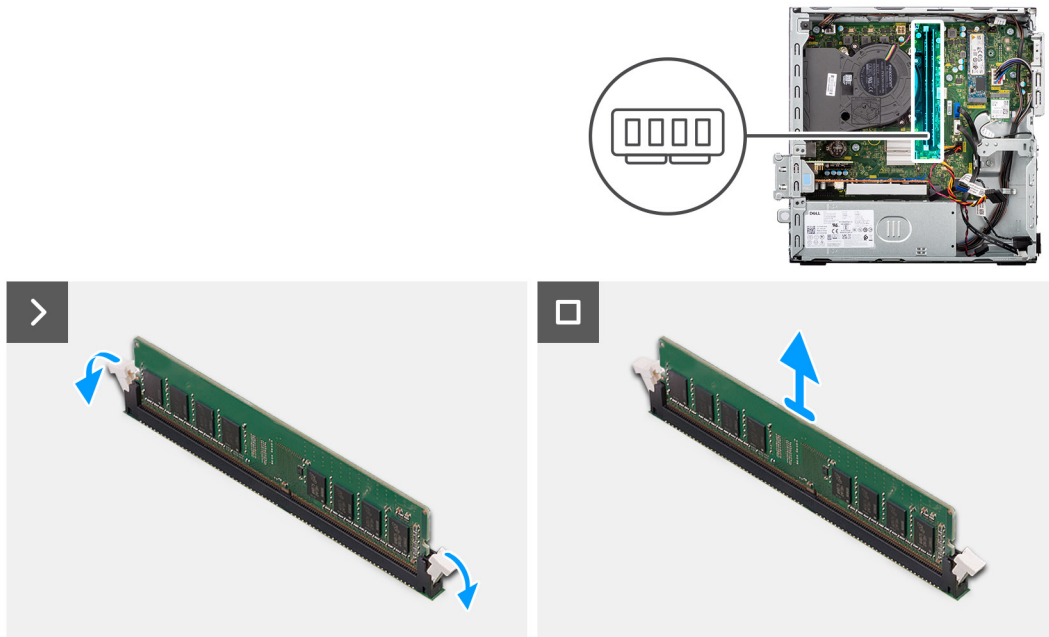

Figure 15. Removing the memory

#### Steps

1. Use your fingertips to carefully spread apart the securing-clips on each end of the memory-module slot (DIMM1 or DIMM2, whichever is applicable) .
2. Grasp the memory module near the securing clip, and then gently ease the memory module out of the memory-module slot.

**CAUTION:** To prevent damage to the memory module, hold the memory module by the edges. Do not touch the components or metallic contacts on the memory module as electrostatic discharge (ESD) can inflict severe damage on the components. To read more about ESD protection, see [ESD protection](#).

**NOTE:** If the memory module is difficult to remove, gently ease the memory module back and forth to remove it from the slot.

**NOTE:** Note the slot and the orientation of the memory module in order to replace it in the correct slot.

3. Repeat step 1 and 2 to remove any other memory modules installed in your computer.

## Installing the memory module

### Prerequisites

If you are replacing a component, remove the existing component before performing the installation procedure.

### About this task

The following images indicate the location of the memory modules and provide a visual representation of the installation procedure.

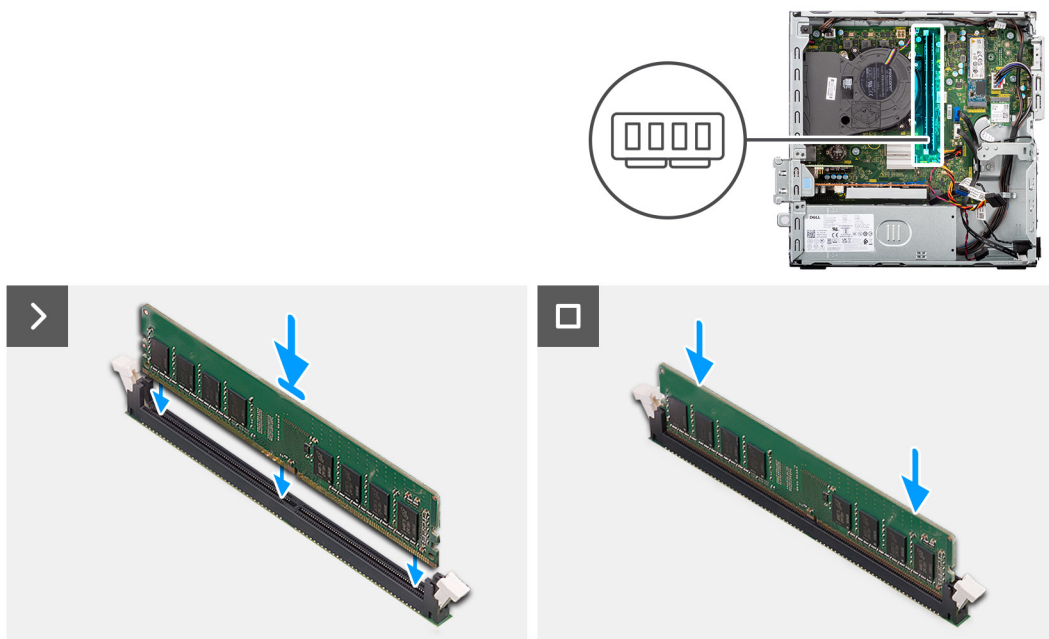

Figure 16. Installing the memory

### Steps

1. Ensure that the memory-module securing clips are in an open position.
2. Align the notch on the memory module with the tab on the memory-module slot (DIMM1 or DIMM2, whichever is applicable).
3. Press down on the memory module until the memory module snaps into position and the securing clips lock in place.

**CAUTION:** To prevent damage to the memory module, hold the memory module by the edges. Do not touch the components or metallic contacts on the memory module as electrostatic discharge (ESD) can inflict severe damage on the components. To read more about ESD protection, see [ESD protection](#).

**NOTE:** If you do not hear the click, remove the memory module and reinstall it.

4. Repeat steps 1 to 3 to install the other memory modules in your computer, if applicable.

### Next steps

1. Install the [disk-drive cage](#).
2. Install the [3.5-inch hard drive](#), if applicable.
3. Install the [front bezel](#).

4. Install the [side cover](#).
5. Follow the procedure in [After working inside your computer](#).

## Solid-state drives

### Removing the M.2 2230 solid-state drive

#### Prerequisites

1. Follow the procedure in [Before working inside your computer](#).
2. Remove the [side cover](#).
3. Remove the [front bezel](#).
4. Remove the [3.5-inch hard drive](#), if applicable.
5. Remove the [disk-drive cage](#).

#### About this task

The following images indicate the location of the M.2 2230 solid-state drive in slot 0 and provide a visual representation of the removal procedure.

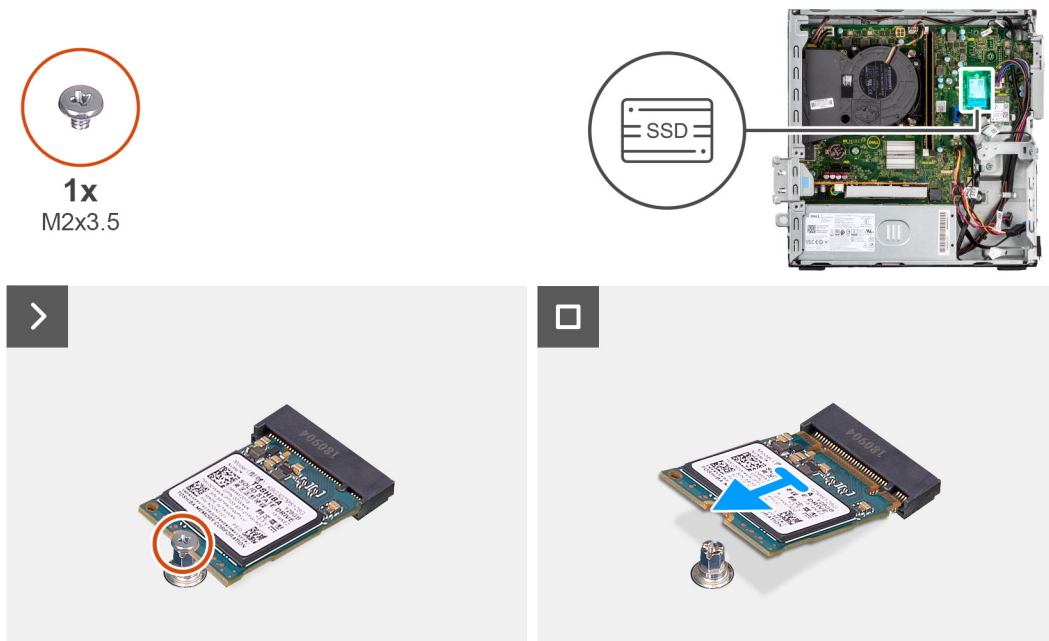

**Figure 17. Removing the M.2 2230 solid-state drive**

#### Steps

1. Remove the screw (M2x3.5) that secures the M.2 2230 solid-state drive to the system board.
2. Slide and lift the M.2 2230 solid-state drive off the solid-state drive slot 0 (M.2 PCIE SSD-0) on the system board.

### Installing the M.2 2230 solid-state drive

#### Prerequisites

If you are replacing a component, remove the existing component before performing the installation procedure.

#### About this task

**NOTE:** If you are replacing a M.2 2280 solid-state drive with a M.2 2230 solid-state drive, ensure that the M.2 2280 solid-state drive is removed first.

**NOTE:** Steps 1 to 3 are applicable only if you are installing a new M.2 2230 solid-state drive for the first time in your computer.

The following images indicate the location of the M.2 2230 solid-state drive and provide a visual representation of the installation procedure.

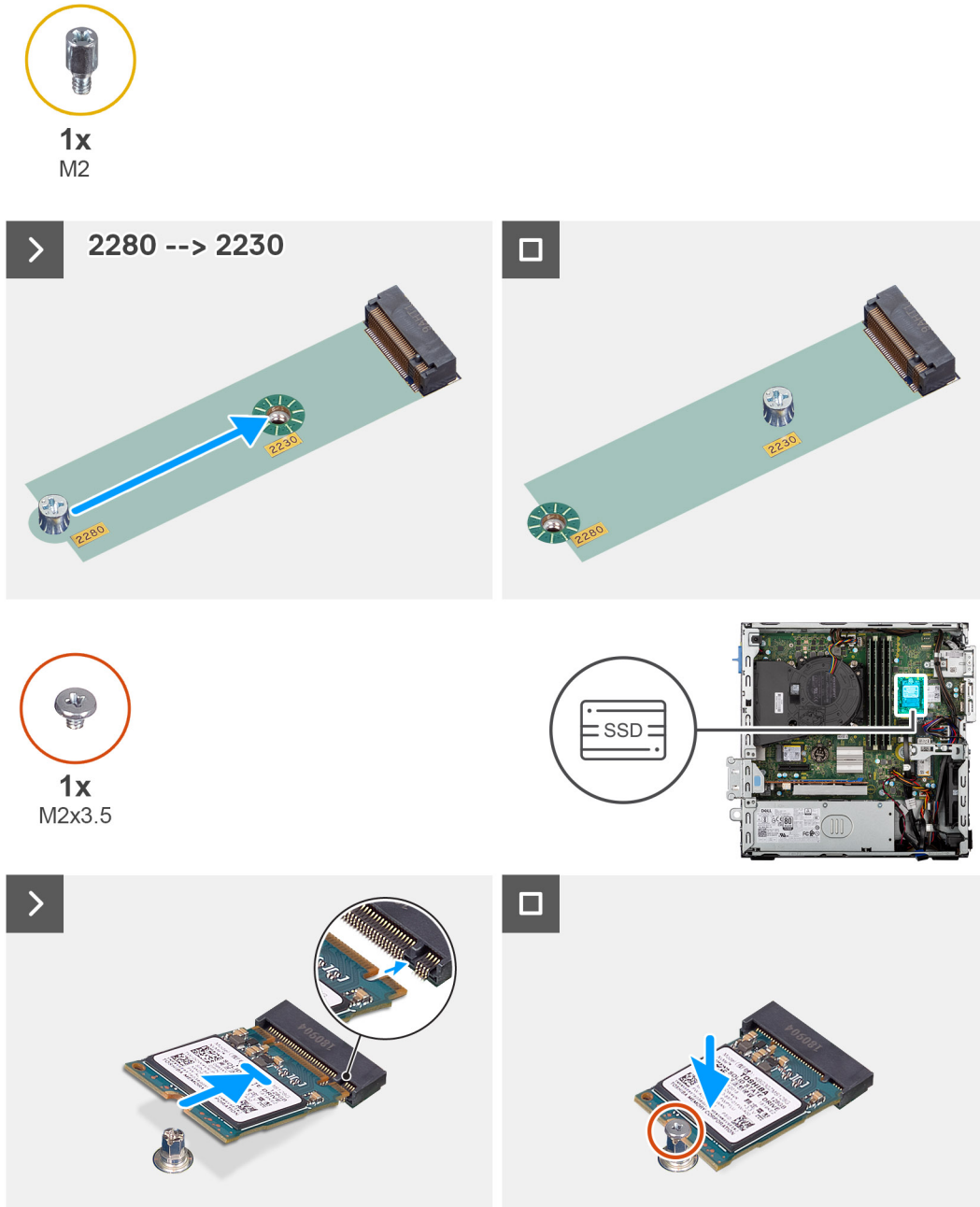
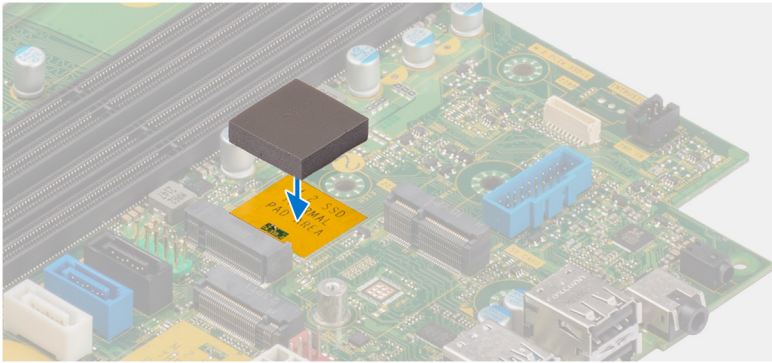

**Figure 18. Installing the M.2 2230 solid-state drives**

### Steps

1. Peel off the protection film on the thermal pad.
2. Align and adhere the thermal pad on the solid-state drive slot 1(M.2 PCIE SSD-0) on the system board.

**NOTE:** The thermal pad is re-usable. The thermal pad is preinstalled on systems that are shipped with solid-state drive. If the solid-state drive is purchased separately, the thermal pad is not bundled with the solid-state drive kit and must be purchased separately.



3. Peel off the protective Mylar on the thermal pad.
4. Remove the standoff nut (M2) from the M.2 slot (2280) and place it on the M.2 slot (2230), at half length, on the system board.  
**i** **NOTE:** This step applies only if you are replacing a M.2 2280 solid-state drive with a M.2 2230 solid-state drive.
5. Align the notch on the M.2 2230 solid-state drive with the tab on the solid-state drive slot 0 (M.2 PCIE SSD-0) on the system board.
6. Slide the M.2 2230 solid-state drive into the solid-state drive slot 0 (M.2 PCIE SSD-0) on the system board.
7. Replace the screw (M2x3.5) that secures the M.2 2230 solid-state drive to the system board.

#### Next steps

1. Install the [disk-drive cage](#).
2. Install the [3.5-inch hard drive](#), if applicable.
3. Install the [front bezel](#).
4. Install the [side cover](#).
5. Follow the procedure in [After working inside your computer](#).

## Removing the M.2 2280 solid-state drive

#### Prerequisites

1. Follow the procedure in [Before working inside your computer](#).
2. Remove the [side cover](#).
3. Remove the [front bezel](#).
4. Remove the [3.5-inch hard drive](#), if applicable.
5. Remove the [disk-drive cage](#).

#### About this task

The following images indicate the location of the M.2 2280 solid-state drive and provide a visual representation of the removal procedure.

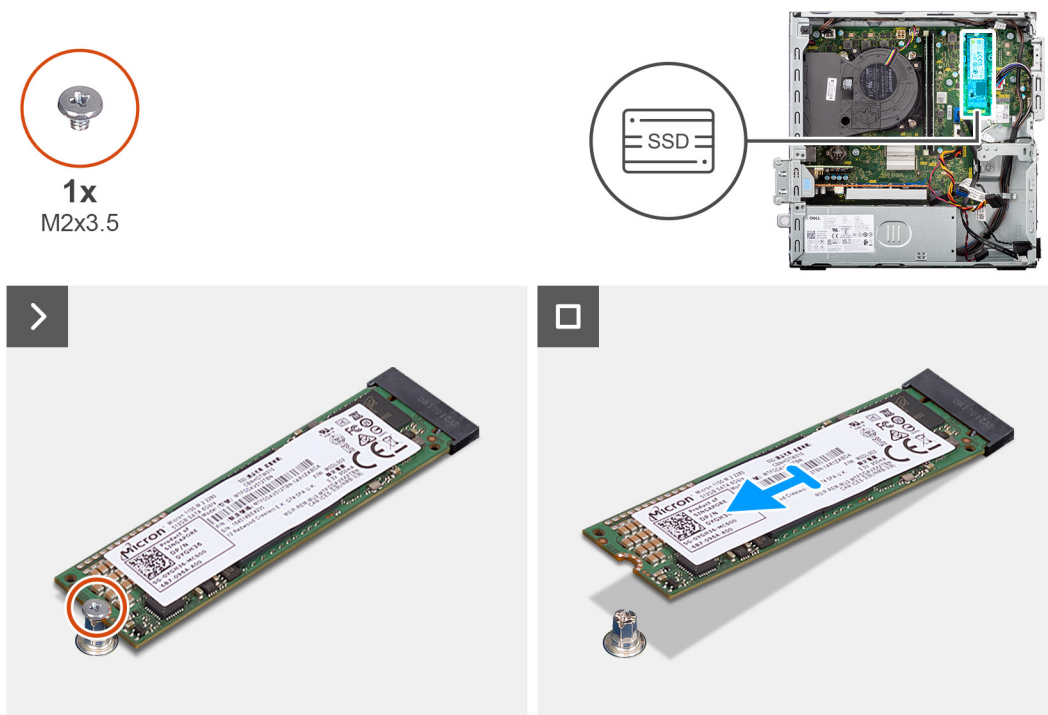

**Figure 19. Removing the M.2 2280 solid-state drive**

### Steps

1. Remove the screw (M2x3.5) that secures the M.2 2280 solid-state drive to the system board.
2. Slide and lift the M.2 2280 solid-state drive off the solid-state drive slot (M.2 PCIe SSD-0) on the system board.

## Installing the M.2 2280 solid-state drive

### Prerequisites

If you are replacing a component, remove the existing component before performing the installation procedure.

### About this task

- NOTE:** If you are replacing a M.2 2230 solid-state drive with a M.2 2280 solid-state drive, ensure that the M.2 2230 solid-state drive is removed first.
- NOTE:** Steps 1 to 3 are applicable only if you are installing a new M.2 2230 solid-state drive for the first time in your computer.

The following images indicate the location of the M.2 2280 solid-state drive and provide a visual representation of the installation procedure.





1x  
M2

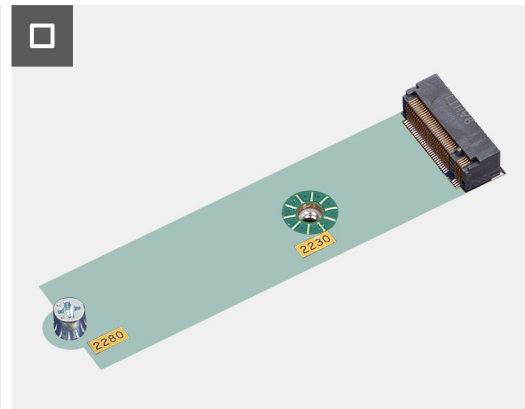
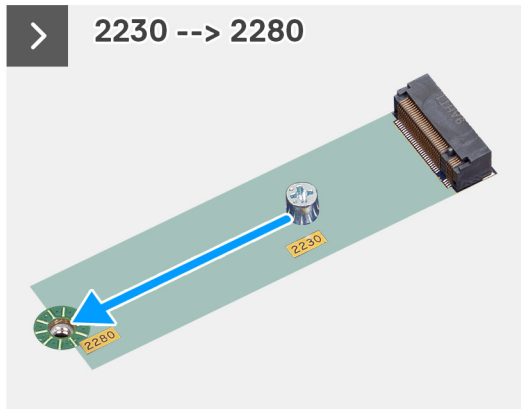

1x  
M2x3.5

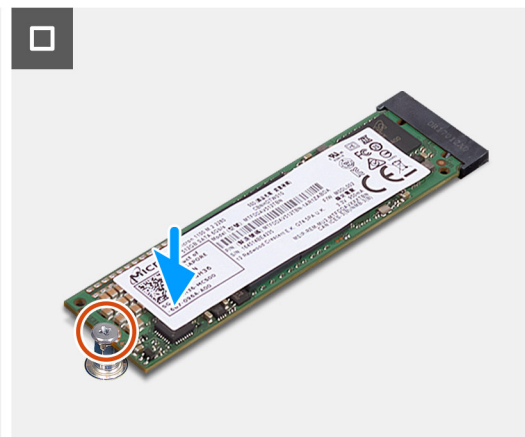
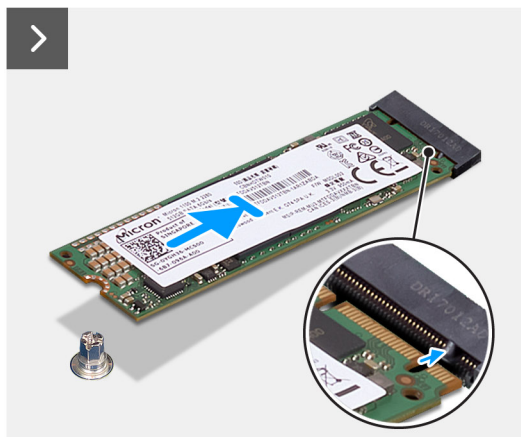
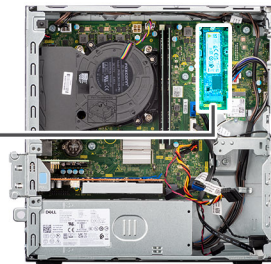
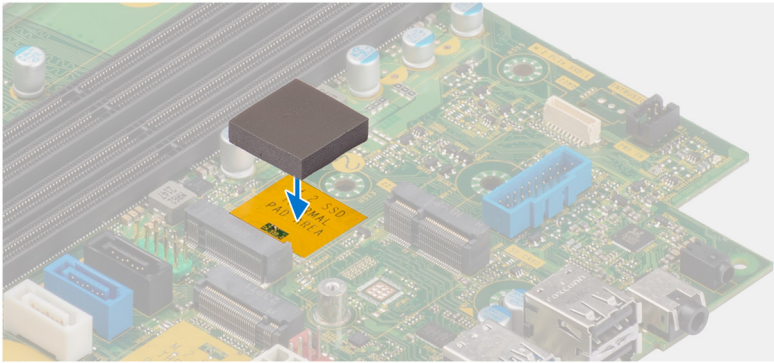

Figure 20. Installing the M.2 2280 solid-state drive

### Steps

1. Peel off the protection film on the thermal pad.
2. Align and adhere the thermal pad on the M.2 2280 solid-state drive slot on the system board.

**i** **NOTE:** The thermal pad is re-usable. The thermal pad is pre-installed on computers that are shipped with solid-state drive. If the solid-state drive is purchased separately, the thermal pad is not bundled with the solid-state drive kit and must be purchased separately.



3. Peel off the protection Mylar on the thermal pad.
4. Remove the standoff nut (M2) from the M.2 slot (2230) and place it on the M.2 slot (2280), at full length, on the system board.

**i** **NOTE:** This step applies only if you are replacing a M.2 2230 solid-state drive with a M.2 2280 solid-state drive.

5. Align the notch on the M.2 2280 solid-state drive with the tab on the solid-state drive slot (M.2 PCIe SSD-0) on the system board.
6. Slide the M.2 2280 solid-state drive into the solid-state drive slot (M.2 PCIe SSD-0) on the system board.
7. Replace the screw (M2x3.5) that secures the M.2 2280 solid-state drive to the system board.

#### Next steps

1. Install the [disk-drive cage](#).
2. Install the [3.5-inch hard drive](#), if applicable.
3. Install the [front bezel](#).
4. Install the [side cover](#).
5. Follow the procedure in [After working inside your computer](#).

## Dell Ultra Speed Drive Gen3 card

### Removing Dell Ultra Speed Drive Gen3 card

#### Prerequisites

1. Follow the procedure in [Before working inside your computer](#).
2. Remove the [side cover](#).

#### About this task

The following images indicate the location of the Dell Ultra Speed Drive Gen3 card and provide a visual representation of the removal procedure.

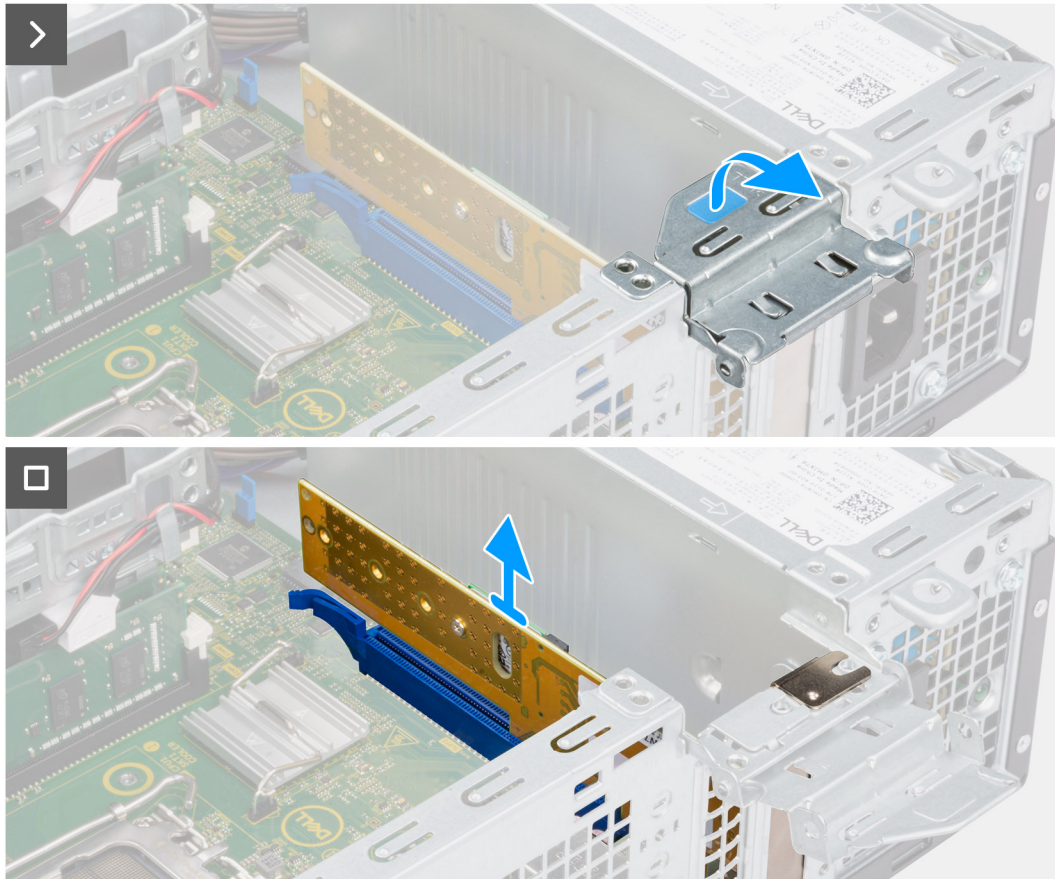
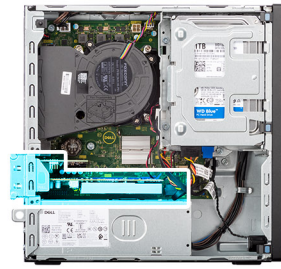

Figure 21. Removing Dell Ultra Speed Drive Gen3 card

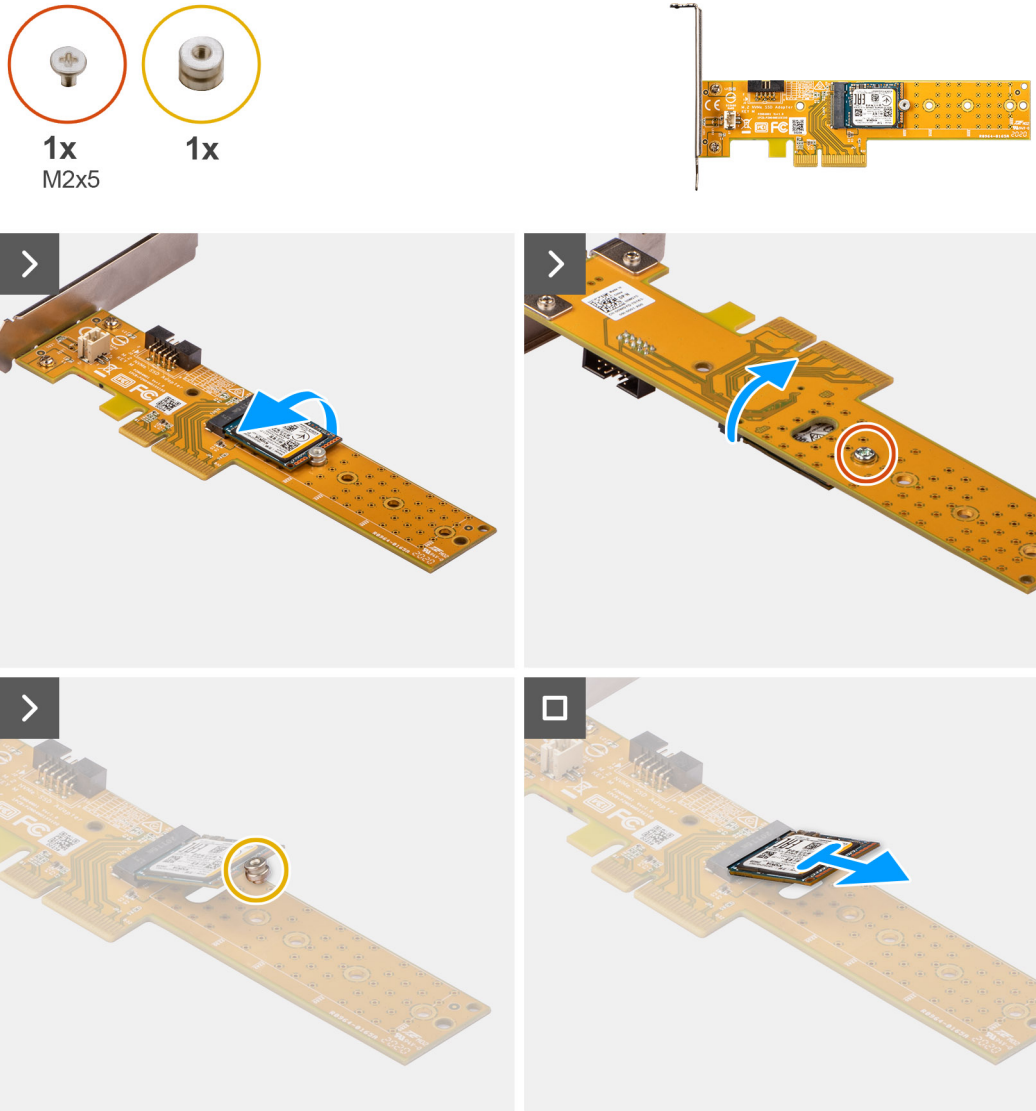
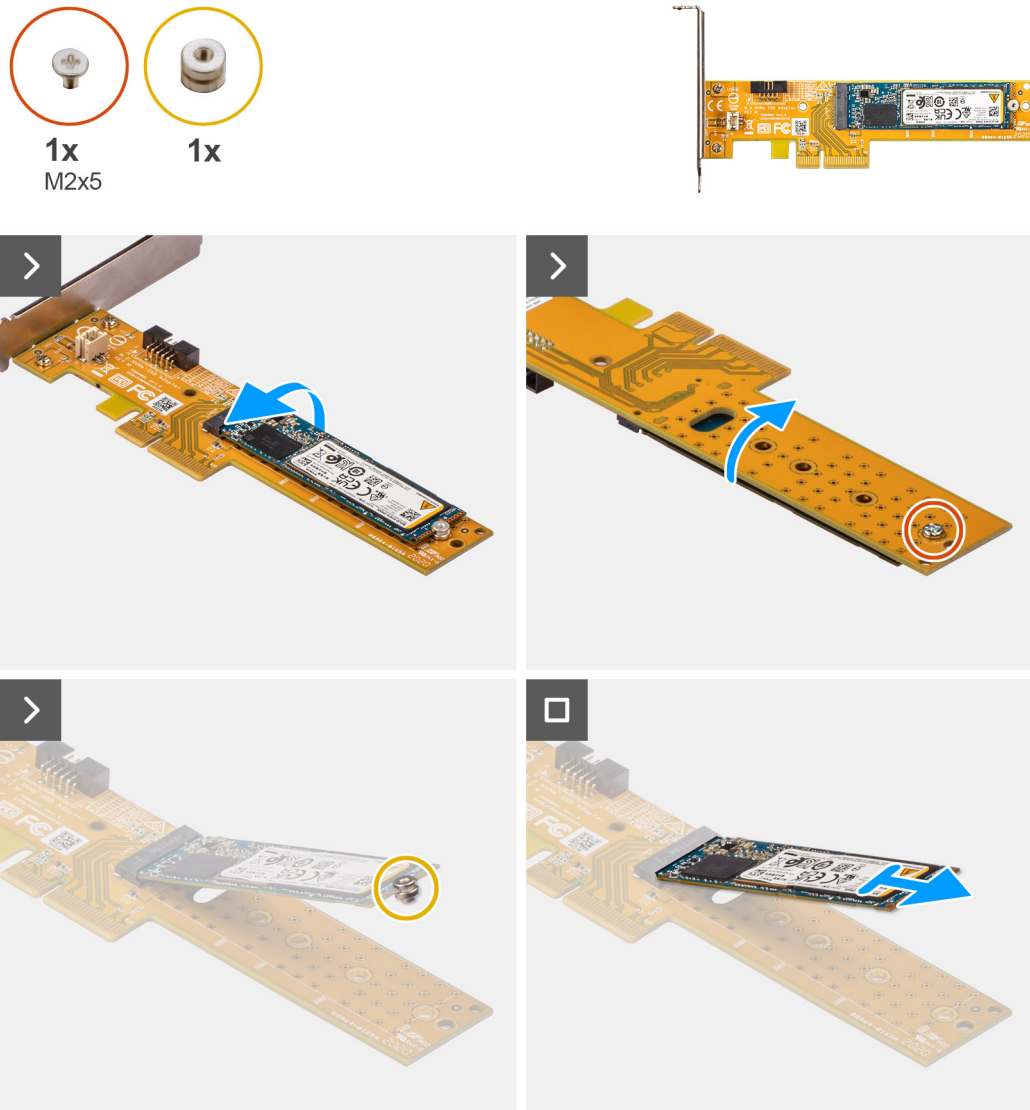

Figure 22. Removing M.2 2230 solid-state drive from Dell Ultra Speed Drive Gen3 card



**Figure 23. Removing M.2 2280 solid-state drive from Dell Ultra Speed Drive Gen3 card**

**Steps**

1. Pull the tab to open the PCIe door.
2. Press down on the release tab on the PCIe slot (SLOT 2) and lift the Dell Ultra Speed Drive Gen3 card off the system board.
3. Turn the Dell Ultra Speed Drive Gen3 card over.
4. Remove the screw (M2x5) that secures the M.2 2230 or 2280 solid-state drive to the Dell Ultra Speed Drive Gen3 card.
5. Turn the Dell Ultra Speed Drive Gen3 card over.
6. Remove the M.2 solid-state drive standoff nut from the M.2 2230 or 2280 solid-state drive.
7. Slide the M.2 2230 or 2280 solid state drive out of the M.2 2230 or 2280 slot on the Dell Ultra Speed Drive Gen3 card.

**Installing the Dell Ultra Speed Drive Gen3 card**

**About this task**

**NOTE:** The Dell Ultra Speed Drive Gen3 card must be installed in the PCIe x16 slot (SLOT 2).

The following images indicate the location of the Dell Ultra Speed Drive Gen3 card and provide a visual representation of the installation procedure.

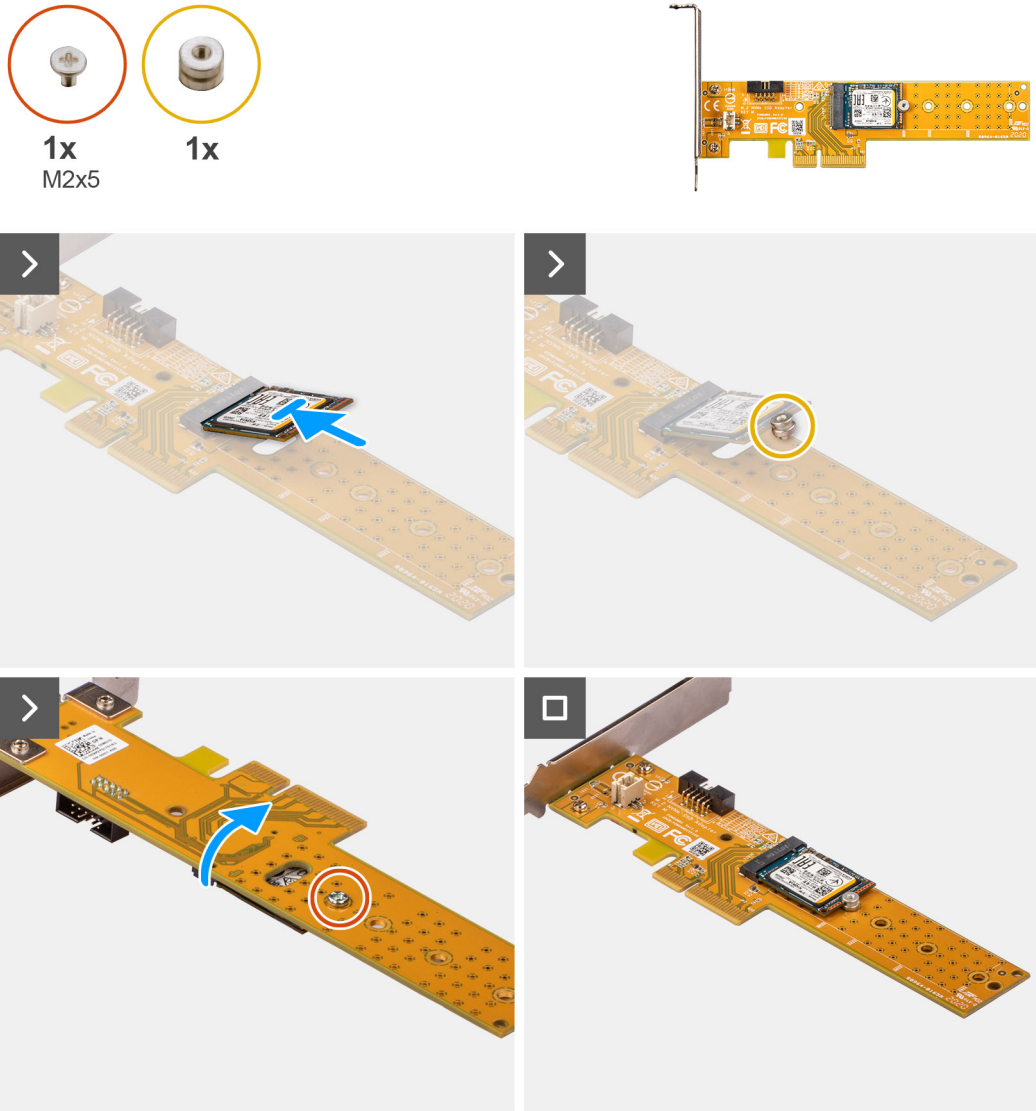

Figure 24. Installing the M.2 2230 solid-state drive on Dell Ultra Speed Drive Gen3 card

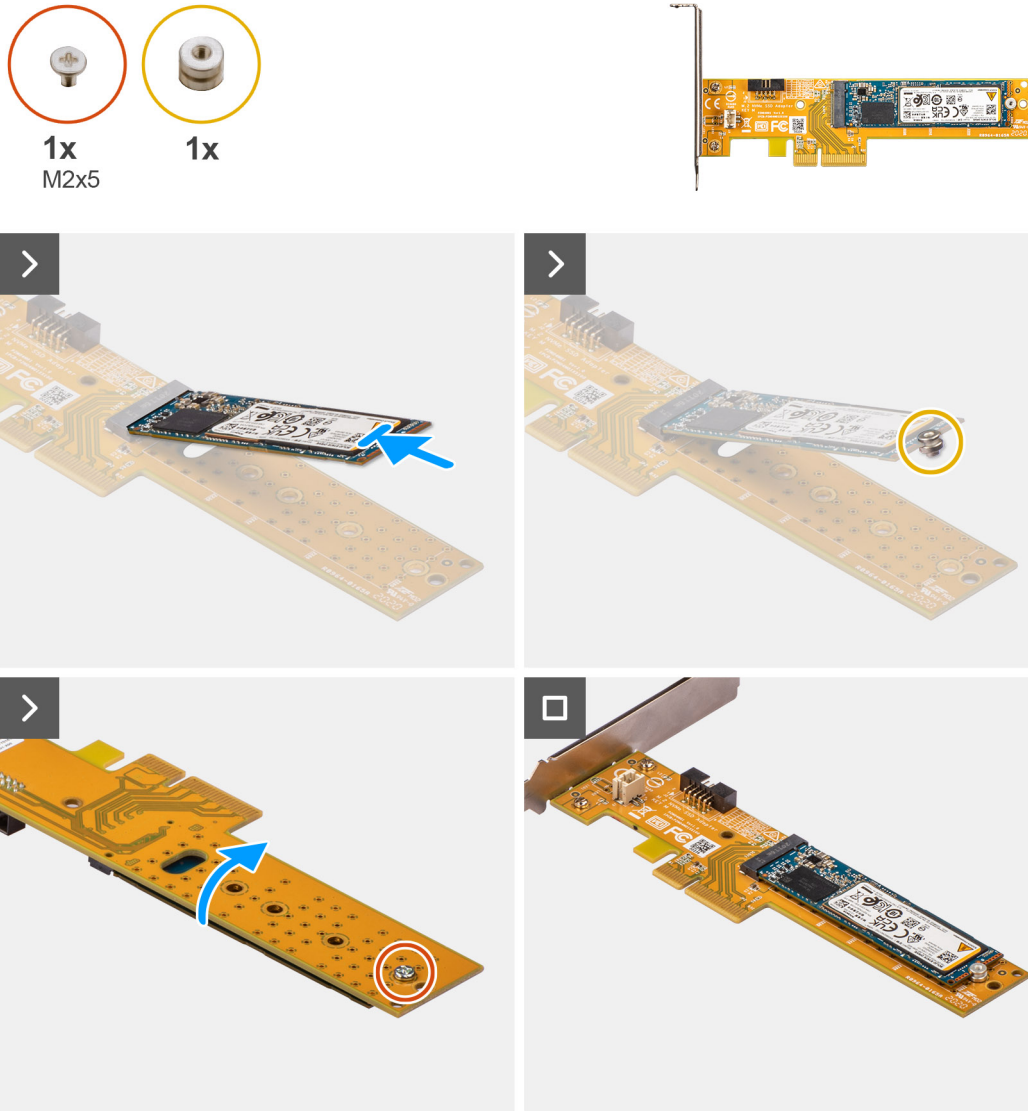
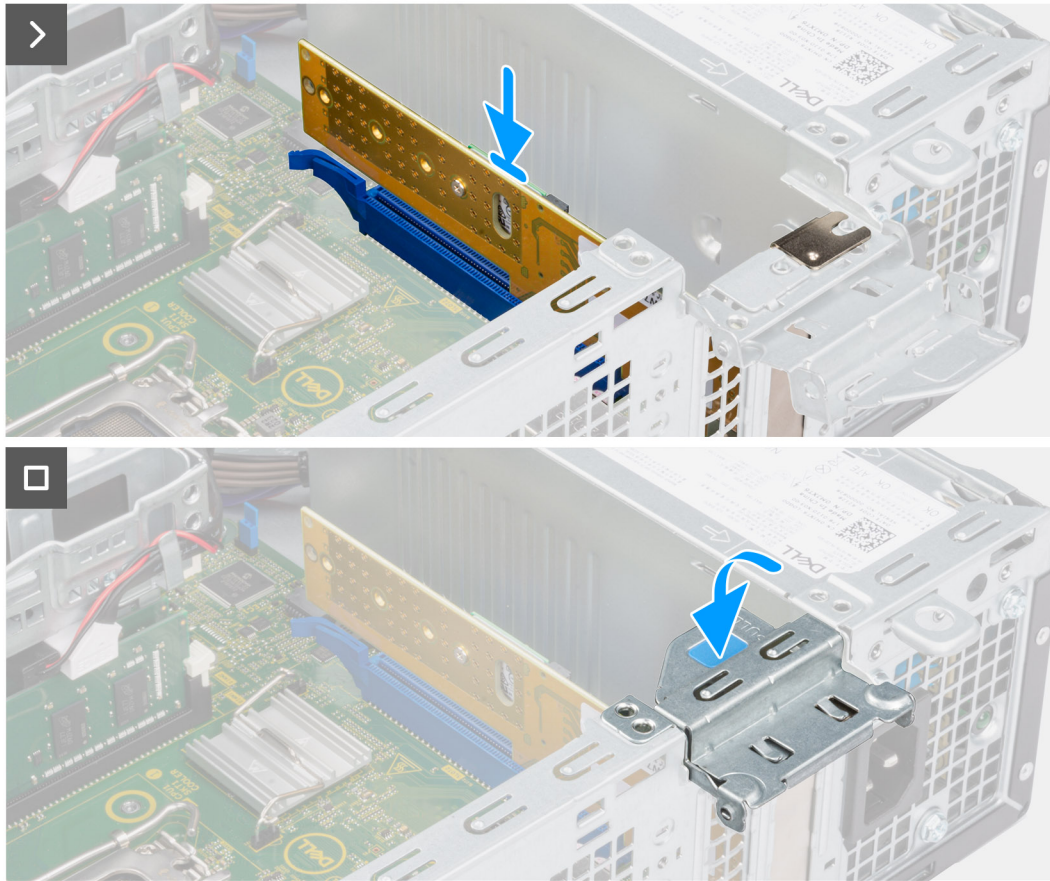

Figure 25. Installing the M.2 2280 solid-state drive on Dell Ultra Speed Drive Gen3 card



**Figure 26. Installing the Dell Ultra Speed Drive Gen3 card**

### Steps

1. Slide the M.2 2230 or 2280 solid-state drive into the M.2 2230 or 2280 slot on the Dell Ultra Speed Drive Gen3 card.
2. Install the M.2 solid-state drive standoff nut on to the M.2 2230 or 2280 solid-state drive.
3. Align the screw holes on the standoff nut with screw holes on the Dell Ultra Speed Drive Gen3 card.
4. Turn the Dell Ultra Speed Drive Gen3 card over.
5. Install the screw (M2x5) that secures the M.2 2230 or 2280 solid-state drive to the Dell Ultra Speed Drive Gen3 card.
6. Turn the Dell Ultra Speed Drive Gen3 card over.
7. **NOTE:** Ensure that PCIe door is open and the release tab on the PCIe slot (SLOT2) is downwards.

Align the Dell Ultra Speed Drive Gen3 card with the PCIe slot (SLOT2) on the system board.

8. Gently press down on the Dell Ultra Speed Drive Gen3 card till the tab on the PCIe slot (SLOT 2) locks in place.
9. Ensure that the card is firmly seated.
10. Close the PCIe door.

### Next steps

1. Install the [side cover](#).
2. Follow the procedure in [After working inside your computer](#).



# Wireless card

## Removing the wireless card

### Prerequisites

1. Follow the procedure in [Before working inside your computer](#).
2. Remove the [side cover](#).
3. Remove the [front bezel](#).
4. Remove the [3.5-inch hard drive](#), if applicable.
5. Remove the [disk-drive cage](#).

### About this task

The following images indicate the location of the wireless card and provide a visual representation of the removal procedure.

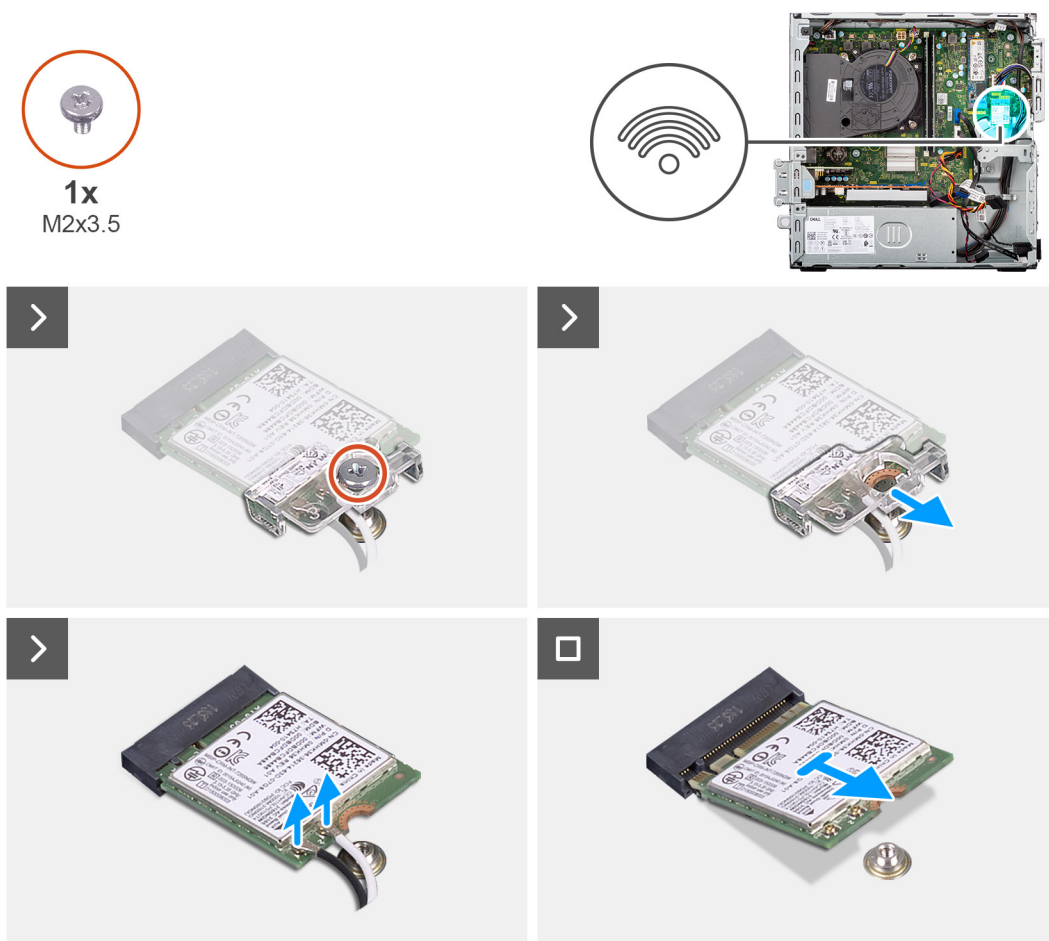

Figure 27. Removing the wireless card

### Steps

1. Remove the screw (M2x3.5) that secures the wireless-card bracket to the system board.
2. Slide and lift the wireless-card bracket off the wireless card.
3. Disconnect the antenna cables from the wireless card.
4. Slide and remove the wireless card from the wireless-card slot (M.2 WLAN) on the system board.

# Installing the wireless card

## Prerequisites

If you are replacing a component, remove the existing component before performing the installation procedure.

## About this task

The following images indicate the location of the wireless card and provide a visual representation of the installation procedure.

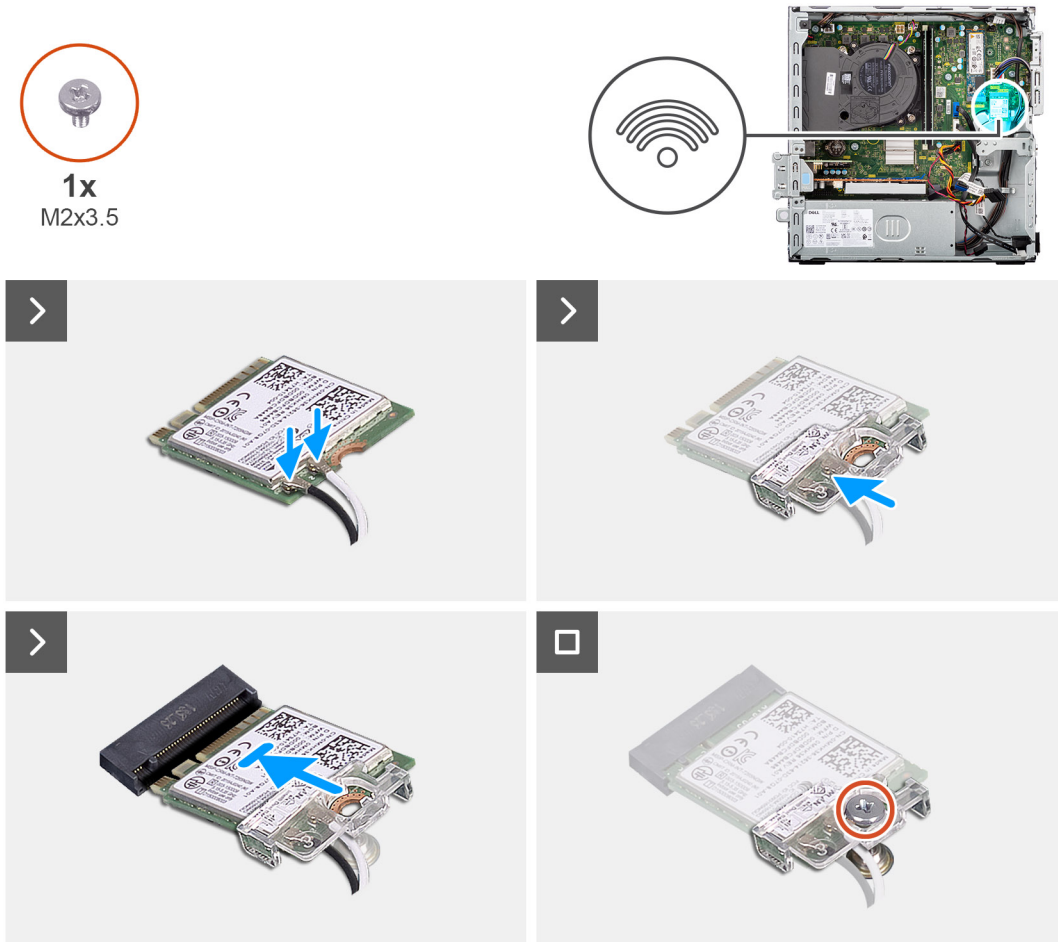

Figure 28. Installing the wireless card

## Steps

1. Connect the antenna cables to the wireless card.

Table 27. Antenna-cable color scheme

| Connector on the wireless card | Antenna-cable color | Silkscreen marking |                    |
|--------------------------------|---------------------|--------------------|--------------------|
| Main                           | White               | MAIN               | △ (white triangle) |
| Auxiliary                      | Black               | AUX                | ▲ (black triangle) |

2. Place the wireless-card bracket on the wireless card.
3. Align the notch on the wireless card with the tab on the wireless-card slot (M.2 WLAN).
4. Slide the wireless card at an angle into the wireless-card slot (M.2 WLAN).
5. Replace the screw (M2x3.5) that secures the wireless-card bracket to the wireless card.

### Next steps

1. Install the [disk-drive cage](#).
2. Install the [3.5-inch hard drive](#), if applicable.
3. Install the [front bezel](#).
4. Install the [side cover](#).
5. Follow the procedure in [After working inside your computer](#).

## External puck antenna

Computers that are shipped with **Intel Wi-Fi 6E AX211** wireless card come with an external SMA antenna installed.

For more information about the installation procedure of external SMA antenna for your computer, see *OptiPlex Antenna Installation Guide* on the documentation support page of [OptiPlex Small Form Factor 7020](#).

## Graphics card

### Removing the graphics card

#### Prerequisites

1. Follow the procedure in [Before working inside your computer](#).
2. Remove the [side cover](#).

#### About this task

The following images indicate the location of the graphics card and provide a visual representation of the removal procedure.

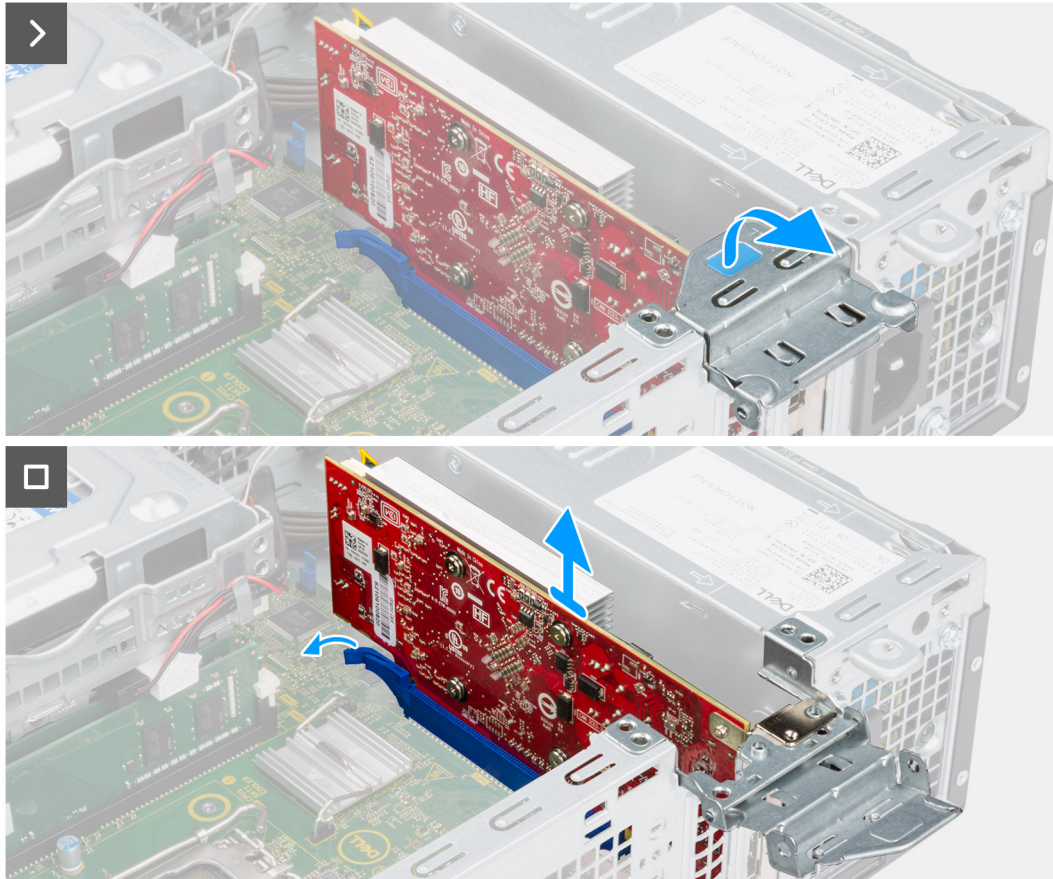
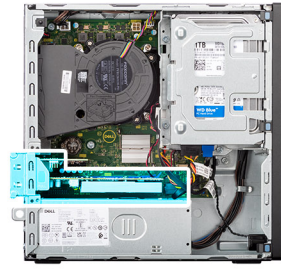

**Figure 29. Removing the graphics card**

**Steps**

1. Pull to open the PCIe latch that secures the graphics card to the PCI card connector (SLOT 2).
2. Push and hold the tab that secures the graphics card to the PCIe card connector (SLOT 2).
3. Gently lift the graphics card off the PCIe card connector (SLOT 2) on the system board.

## Installing the graphics card

**Prerequisites**

If you are replacing a component, remove the existing component before performing the installation procedure.

**About this task**

The following images indicate the location of the graphics card and provide a visual representation of the installation procedure.

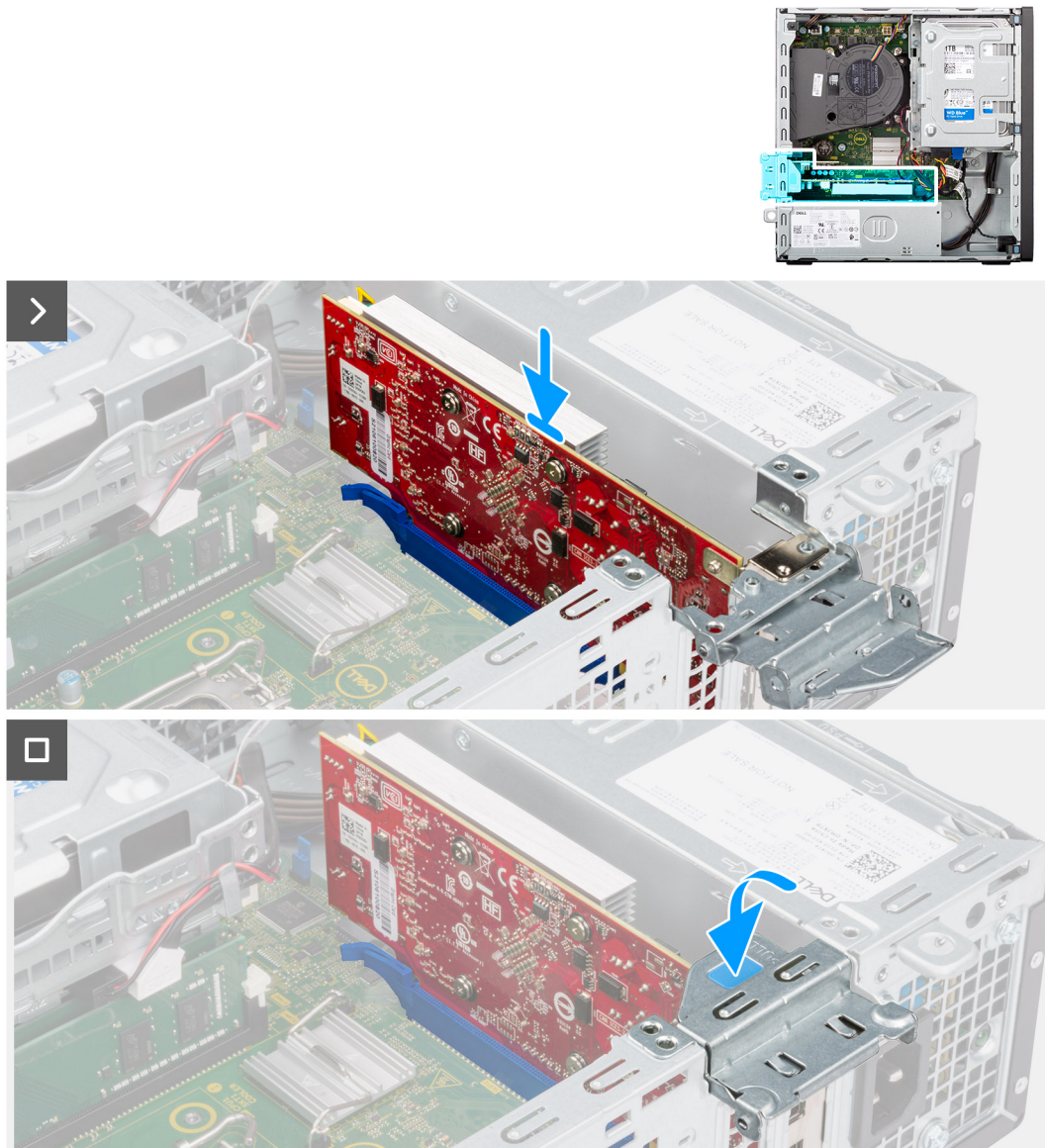

**Figure 30. Installing the graphics card**

### Steps

1. **NOTE:** Ensure that PCIe door is in open position and the release tab on the PCIe slot (SLOT 2) is downwards.  
Align the graphics card with the connector on the system board.
2. Gently press down on the graphics card till the tab on the PCIe card connector (SLOT 2) locks in place.
3. Close the PCIe latch to secure the graphics card in PCI card connector (SLOT 2).

### Next steps

1. Install the [side cover](#).
2. Follow the procedure in [After working inside your computer](#).

# Internal speaker

## Removing the internal speaker

### Prerequisites

1. Follow the procedure in [Before working inside your computer](#).
2. Remove the [side cover](#).

### About this task

The following images indicate the location of the speaker and provide a visual representation of the removal procedure.

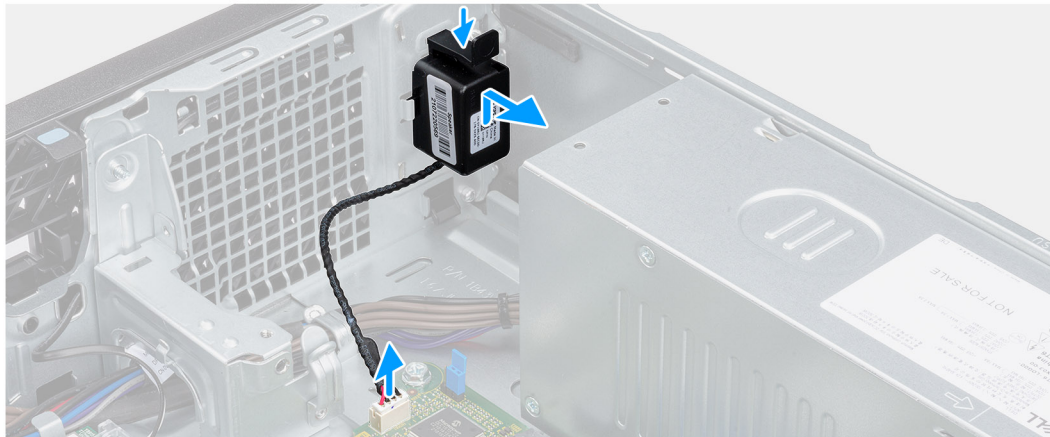
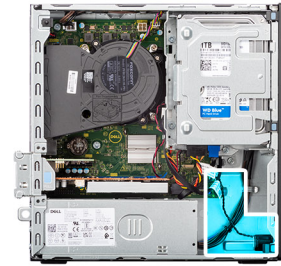

**Figure 31. Removing the speaker**

### Steps

1. Disconnect the speaker cable from its connector (INT SPKR) on the system board.
2. Press the tab, lift and slide the speaker along with the cable from the slot on the chassis.

## Installing the internal speaker

### Prerequisites

If you are replacing a component, remove the existing component before performing the installation procedure.

### About this task

The following images indicate the location of the speaker and provide a visual representation of the installation procedure.

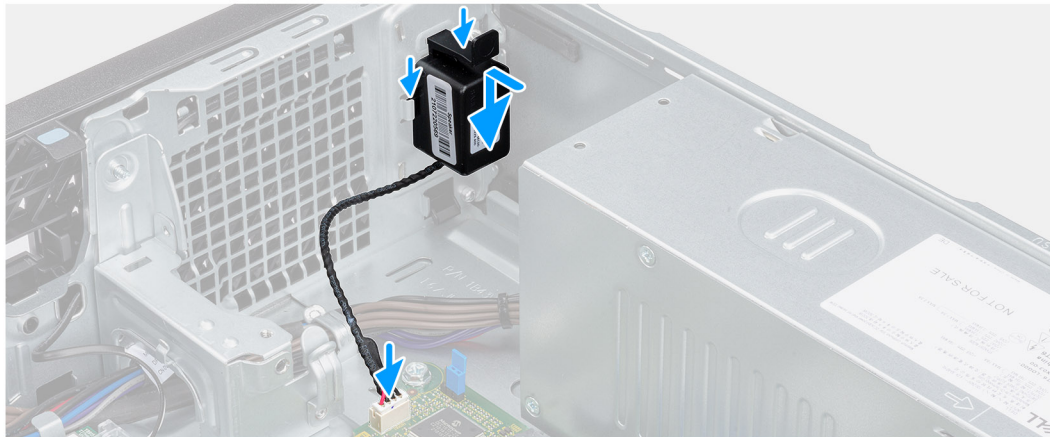
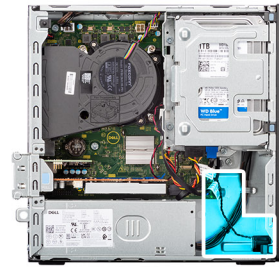

**Figure 32. Installing the speaker**

#### Steps

1. Press the tab on the speaker and slide the speaker into the slot on the chassis until it snaps into place.
2. Connect the speaker cable to its connector (INT SPKR) on the system board.

#### Next steps

1. Install the [side cover](#).
2. Follow the procedure in [After working inside your computer](#).

## Intrusion switch

### Removing the intrusion switch

**CAUTION:** The information in this removal section is intended for authorized service technicians only.

#### Prerequisites

1. Follow the procedure in [Before working inside your computer](#).
2. Remove the [side cover](#).

#### About this task

The following image indicates the location of the intrusion switch and provides a visual representation of the removal procedure.

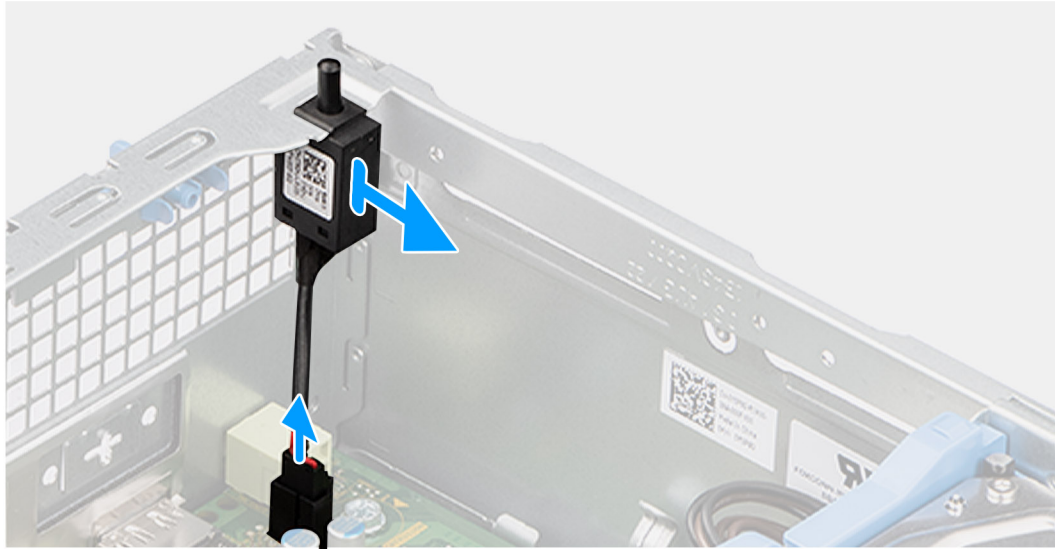

**Figure 33. Removing the intrusion switch**

**Steps**

1. Disconnect the intrusion-switch cable from its connector (INTRUSION) on the system board.
2. Slide and lift the Intrusion switch away from the computer.

## Installing the Intrusion switch

**CAUTION:** The information in this removal section is intended for authorized service technicians only.

**Prerequisites**

If you are replacing a component, remove the existing component before performing the installation procedure.

**About this task**

The following image indicates the location of the Intrusion switch and provides a visual representation of the installation procedure.



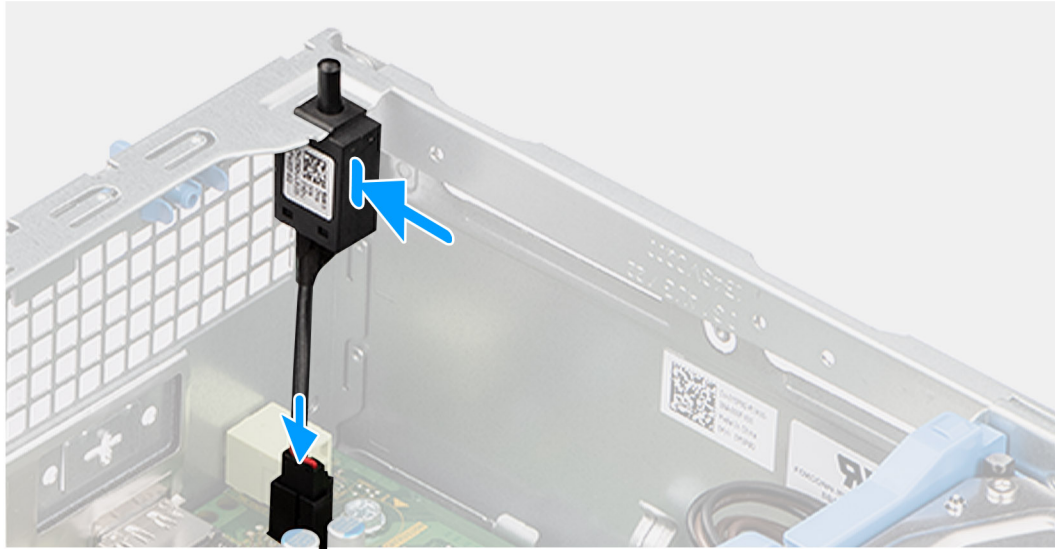

**Figure 34. Installing the Intrusion switch**

**Steps**

1. Slide the intrusion switch into the slot on the chassis.
2. Connect the intrusion-switch cable to its connector (INTRUSION) on the system board.

**Next steps**

1. Install the [side cover](#).
2. Follow the procedure in [After working inside your computer](#).

# Removing and installing Field Replaceable Units (FRUs)

The replaceable components in this chapter are Field Replaceable Units (FRUs).

**CAUTION:** The information in this removing and installing FRU's section is intended for authorized service technicians only.

**CAUTION:** To avoid any potential damage to the component or loss of data, ensure that an authorized service technician replaces the Field Replaceable Units (FRUs).

**CAUTION:** Dell Technologies recommends that this set of repairs, if needed, to be conducted by trained technical repair specialists.

**CAUTION:** As a reminder, your warranty does not cover damages that may occur during FRU repairs that are not authorized by Dell Technologies.

**NOTE:** The images in this document may differ from your computer depending on the configuration you ordered.

## Power button

### Removing the power button

**CAUTION:** The information in this removal section is intended for authorized service technicians only.

#### Prerequisites

1. Follow the procedure in [Before working inside your computer](#).
2. Remove the [side cover](#).
3. Remove the [front bezel](#).
4. Remove the [3.5-inch hard drive](#), if applicable.
5. Remove the [disk-drive cage](#).

#### About this task

The following image indicates the location of the power button and provides a visual representation of the removal procedure.



**Figure 35. Removing the power button**

**Steps**

1. Disconnect the power button cable from its connector (PWR SW) on the system board.
2. Press the release tabs on the power-button head and push the power-button head outside the chassis.
3. Slide the power-button cable out from the front-side of the chassis of the computer and remove the power-button from the computer.

## Installing the power button

**CAUTION:** The information in this removal section is intended for authorized service technicians only.

**Prerequisites**

If you are replacing a component, remove the existing component before performing the installation procedure.

**About this task**

The following image indicates the location of the power button and provides a visual representation of the installation procedure.



**Figure 36. Installing the power button**

**Steps**

1. Insert the power-button cable through the slot on the chassis from the front-side of the computer.
2. Align and place the power-button head into the slot on the chassis until it clicks into the place.
3. Connect the power button cable to its connector (PWR SW) on the system board.

**Next steps**

1. Install the [disk-drive cage](#).
2. Install the [3.5-inch hard drive](#), if applicable.
3. Install the [front bezel](#).
4. Install the [side cover](#).
5. Follow the procedure in [After working inside your computer](#).

## Wireless antenna module

### Internal antenna module

### Removing the internal antenna module

**CAUTION:** The information in this section is intended for authorized service technicians only.

**Prerequisites**

1. Follow the procedure in [Before working inside your computer](#).
2. Remove the [side cover](#).
3. Remove the [front bezel](#).
4. Remove the [3.5-inch hard drive](#), if applicable.
5. Remove the [disk-drive cage](#).
6. Remove the [wireless card](#).

**About this task**

The following images indicate that the location of the internal antenna module and provide a visual representation of the removal procedure.

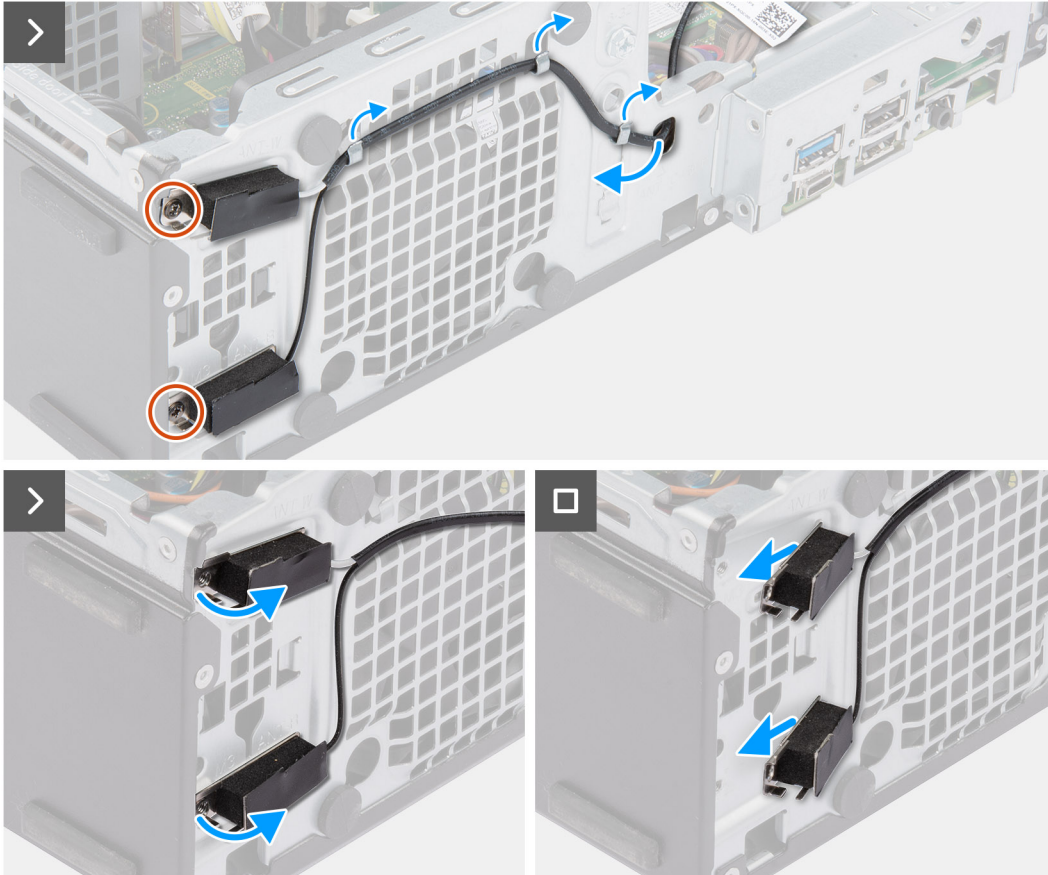

**Figure 37. Removing the internal antenna module**



**Figure 38. Internal antenna module**

#### **Steps**

1. Gently pull the internal-antenna module cable out from the slot on the chassis.
2. Remove the internal antenna module cable from the routing guides on the chassis.
3. Remove the two screws (M3x3) that secure the internal antenna module to the chassis.
4. Remove the internal antenna module from the chassis.

## **Installing the internal antenna module**

**⚠ CAUTION:** The information in this section is intended for authorized service technicians only.

#### **Prerequisites**

If you are replacing a component, remove the existing component before performing the installation procedure.

#### **About this task**

The following images indicate the location of the internal antenna module and provide a visual representation of the installation procedure.

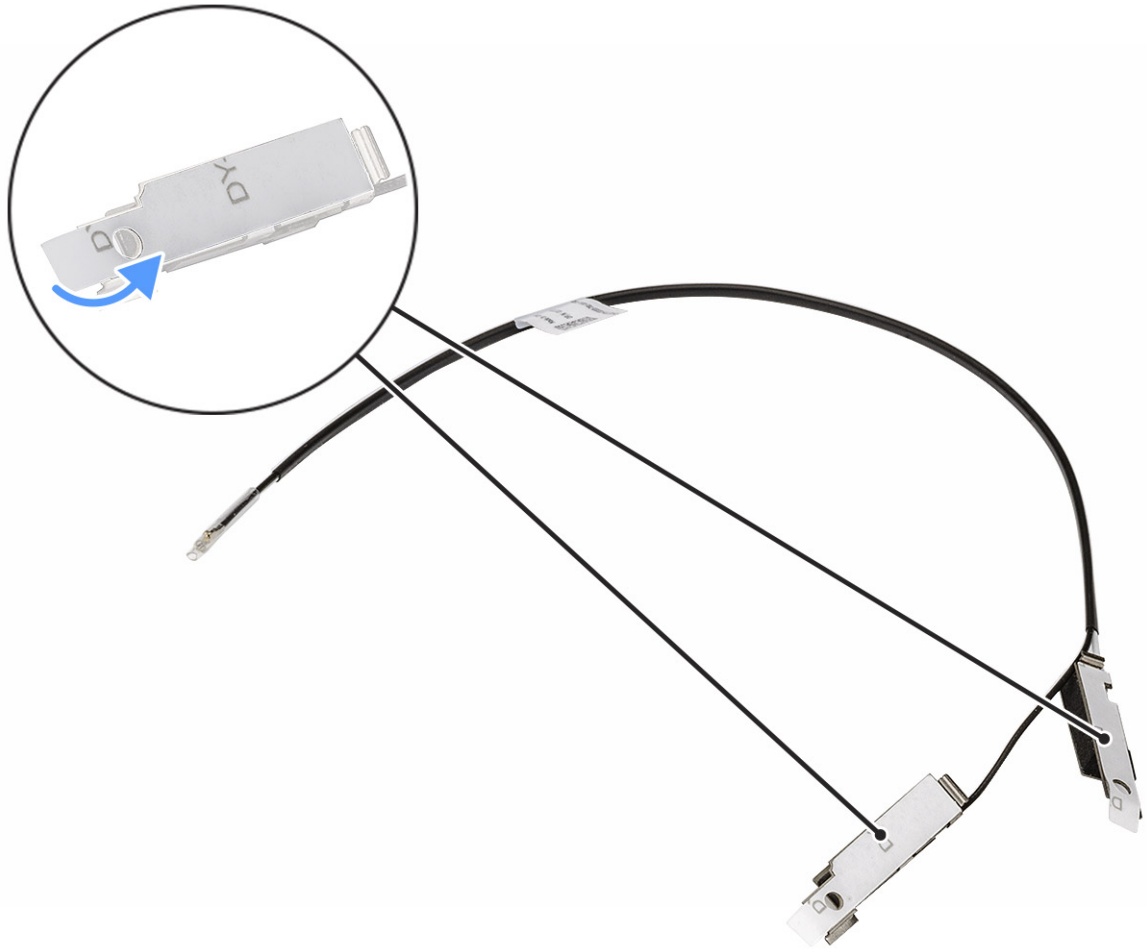

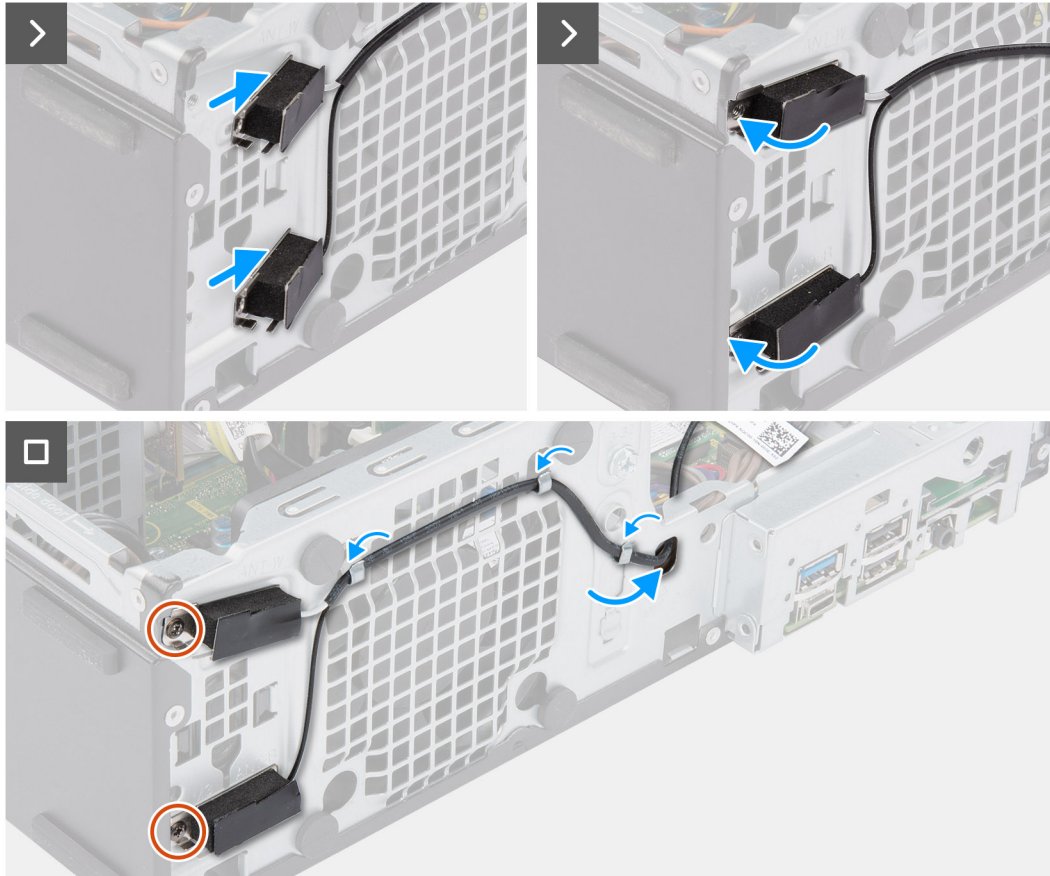

**Figure 39. Installing the internal antenna module**

**Steps**

1. Remove the protection mylars from the internal antennas, if available.
2. Insert the tabs on the internal antennas in the slots on the chassis.  
The antennas should be installed on the appropriate slots on the chassis. The following table provides guidance on the correct installation method.

**Table 28. Antenna-cable color Scheme**

| CHASSIS LABEL | ANTENNA-CABLE COLOR |
|---------------|---------------------|
| ANT-W         | White               |
| ANT-B         | Black               |

3. Replace the two screws (M3x3) that secure the internal antenna module to the chassis.
4. Route the internal antenna module cable through the routing guides on the chassis.
5. Thread the internal antenna module cable through the slot on the chassis.



### Next steps

1. Install the [wireless card](#).
2. Install the [disk-drive cage](#).
3. Install the [3.5-inch hard drive](#), if applicable.
4. Install the [front bezel](#).
5. Install the [side cover](#).
6. Follow the procedure in [After working inside your computer](#).

## External SMA antenna module

### Removing the external SMA antenna module

 **CAUTION:** The information in this section is intended for authorized service technicians only.

#### Prerequisites

1. Follow the procedure in [Before working inside your computer](#).
2. Remove the [side cover](#).
3. Remove the [front bezel](#).
4. Remove the [3.5-inch hard drive](#), if applicable.
5. Remove the [disk-drive cage](#).
6. Remove the [wireless card](#).
7. Remove the [graphics card](#), if applicable.
8. Remove the [external antenna](#).

#### About this task

The following images indicate the location of the external SMA antenna module and provide a visual representation of the removal procedure.

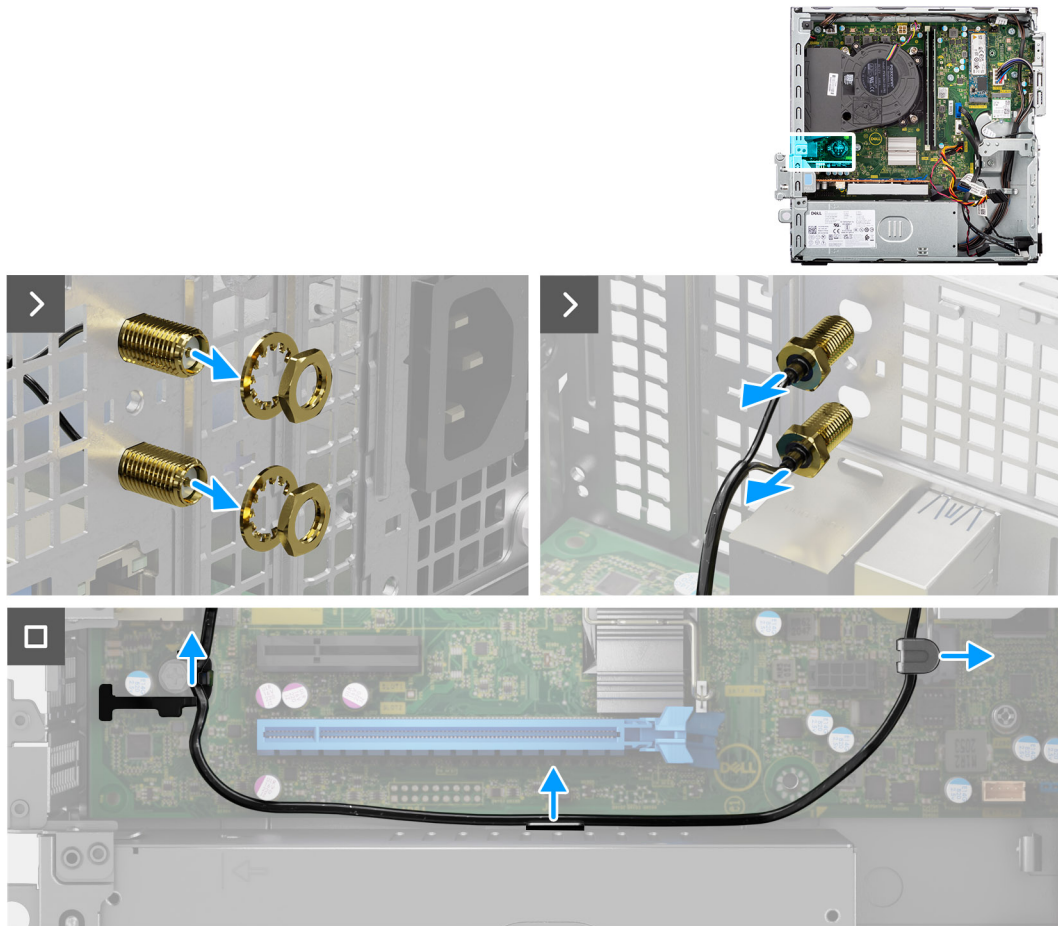

**Figure 40. Removing the external SMA antenna module**

### Steps

1. Remove the nut and washer from the antenna heads.
2. Gently pry and remove the antenna heads from the chassis.
3. Remove the antenna cables from routing guides on the system board.
4. Remove the external SMA antenna module off the system board.

## Installing the external SMA antenna module

**CAUTION:** The information in this section is intended for authorized service technicians only.

### Prerequisites

If you are replacing a component, remove the existing component before performing the installation procedure.

### About this task

The following images indicate the location of the external SMA antenna module and provide a visual representation of the installation procedure.

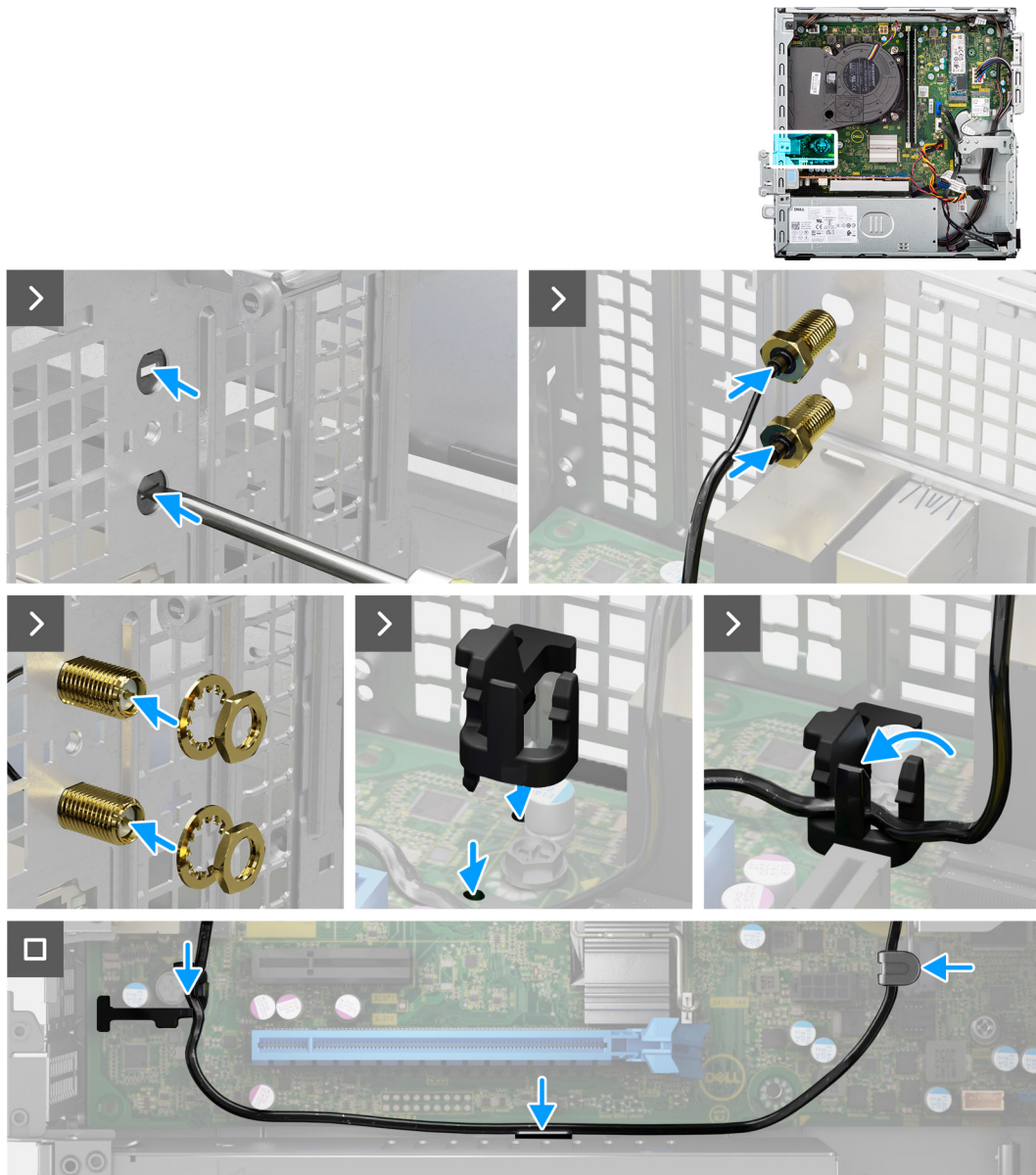

**Figure 41. Installing the external SMA antenna module**

**Steps**

1.  **NOTE:** Steps 1, 2, and 3 are required when installing the SMA antenna kit for the first time.  
Using a screw driver, push and remove the antenna cover from the chassis.
2. Remove the antenna cover from the screw driver and dispose the antenna cover.
3. Align the pins on the clip with the holes on the system board and press the clip to secure the clip to the system board.
4. Push the antenna heads into the slots on the back of the chassis.
5. Install the nut and washer to secure the antenna heads to the chassis.
6. Route the antenna cables through the routing guides on the system board.
7. Press the antenna cable into the clip on the system board.

**Next steps**

1. Install the [external antenna](#).
2. Install the [graphics card](#).
3. Install the [wireless card](#).
4. Install the [disk-drive cage](#).

5. Install the [3.5-inch hard drive](#), if applicable.
6. Install the [front bezel](#).
7. Install the [side cover](#).
8. Follow the procedure in [After working inside your computer](#).

## Power-supply unit

### Removing the power-supply unit

 **CAUTION:** The information in this section is intended for authorized service technicians only.

#### Prerequisites

1. Follow the procedure in [Before working inside your computer](#).
2. Remove the [side cover](#).
3. Remove the [front bezel](#).
4. Remove the [3.5-inch hard drive](#), if applicable.
5. Remove the [disk-drive cage](#).

#### About this task

The following images indicate the location of the power-supply unit and provide a visual representation of the removal procedure.

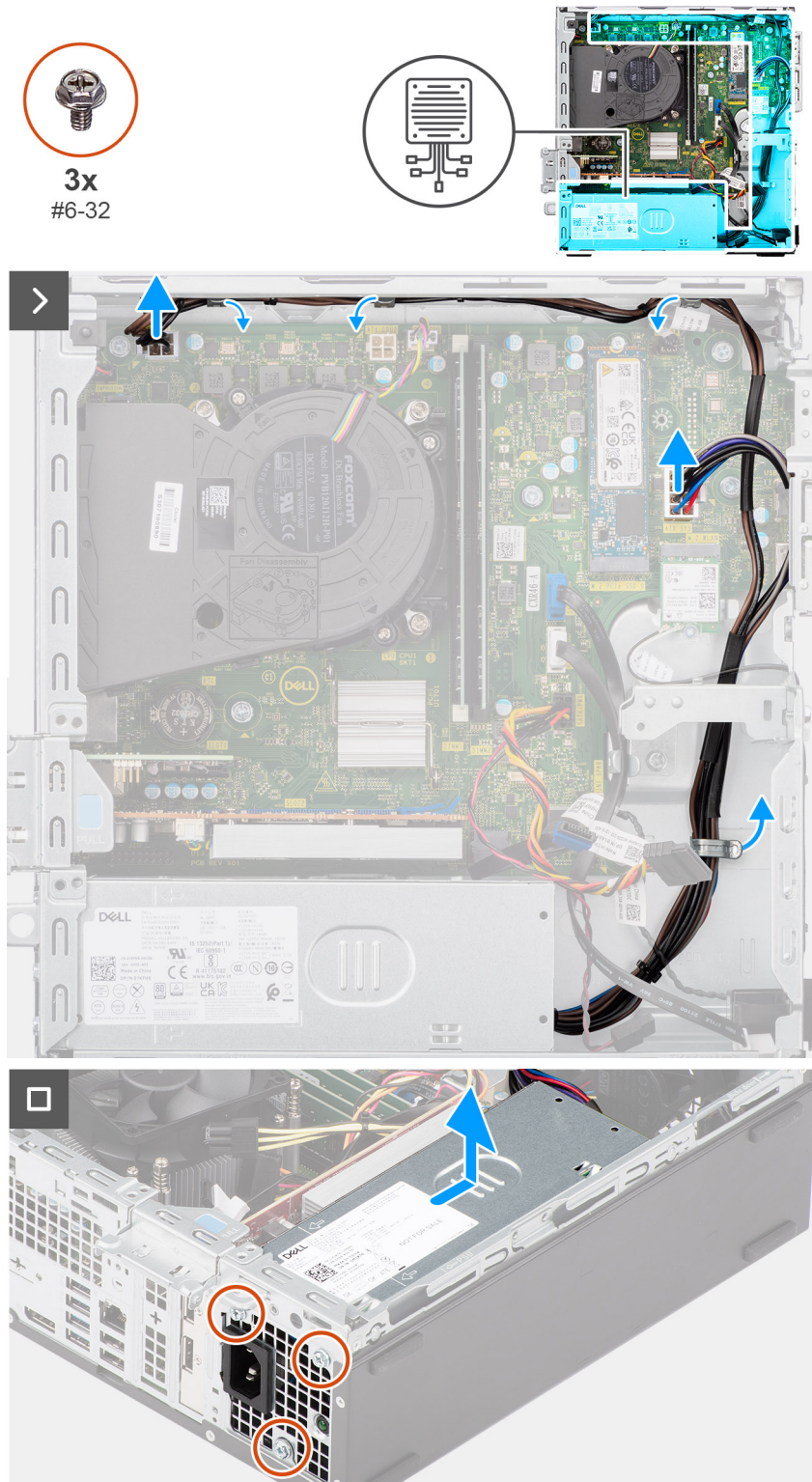

**Figure 42. Removing the power-supply unit**

**Steps**

1. Disconnect the power-supply cables from their connectors (ATX CPU1, ATX CPU2 and ATX SYS) on the system board.
2. Remove the power-supply cables from the routing guides on the chassis.
3. Remove the three screws (#6-32) that secure the power-supply unit to the chassis.
4. Slide and lift the power-supply unit off the chassis.

## Installing the power-supply unit

**CAUTION:** The information in this section is intended for authorized service technicians only.

### Prerequisites

If you are replacing a component, remove the existing component before performing the installation procedure.

### About this task

The following images indicate the location of the power-supply unit and provide a visual representation of the installation procedure.

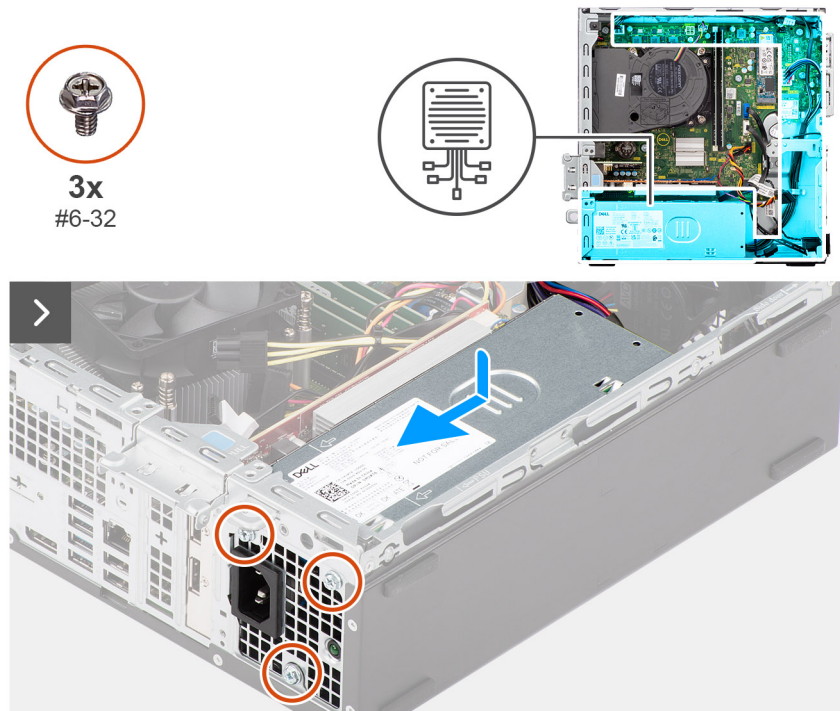

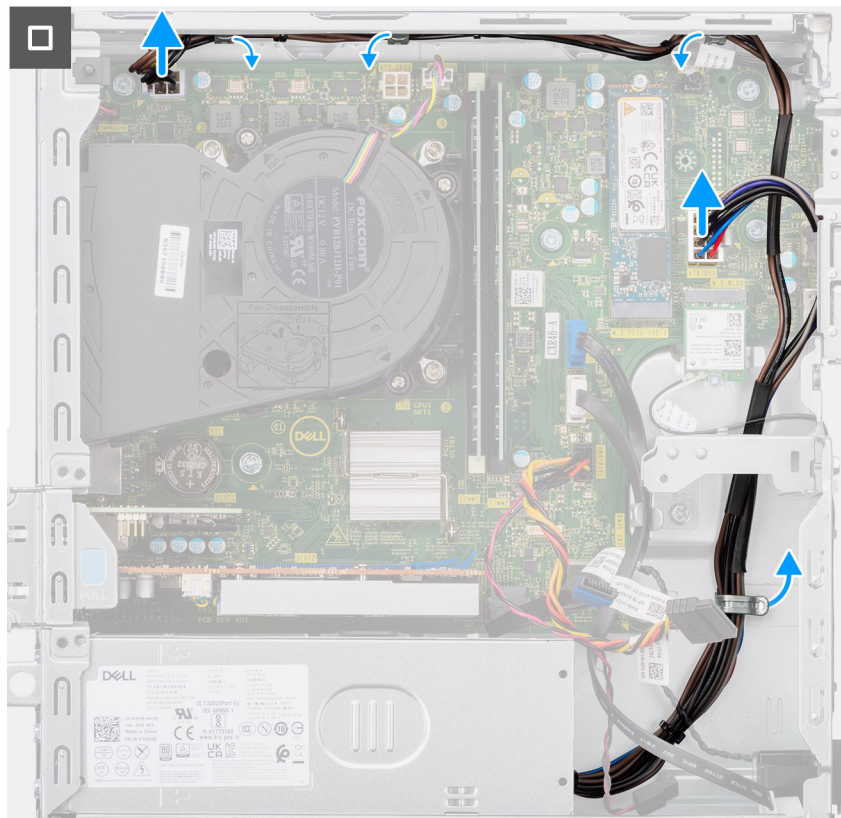

**Figure 43. Installing the power-supply unit**

#### Steps

1. Place the power-supply unit on the chassis and slide it towards the back of the chassis.
2. Replace the three screws (#6-32) that secure the power-supply unit to the chassis.
3. Route the power-supply cables through their routing guides on the chassis.
4. Connect the power-supply cables to their connectors (ATX CPU1, ATX CPU2 and ATX SYS) on the system board.

#### Next steps

1. Install the [disk-drive cage](#).
2. Install the [3.5-inch hard drive](#), if applicable.
3. Install the [front bezel](#).
4. Install the [side cover](#).
5. Follow the procedure in [After working inside your computer](#).

## Processor fan and heat-sink assembly

### Removing the processor fan and heat-sink assembly

**CAUTION:** The information in this section is intended for authorized service technicians only.

#### Prerequisites

1. Follow the procedure in [Before working inside your computer](#).
2. Remove the [side cover](#).
3. Remove the [front bezel](#).
4. Remove the [3.5-inch hard drive](#), if applicable.
5. Remove the [disk-drive cage](#).

### About this task

The following images indicate the location of the processor fan and heat-sink assembly and provide a visual representation of the removal procedure.

**CAUTION:** For maximum cooling of the processor, do not touch the heat transfer areas on the heat sink. The oils in your skin can reduce the heat transfer capability of the thermal grease.

**NOTE:** The heat sink may become hot during normal operation. Allow sufficient time for the heat sink to cool before you touch it.

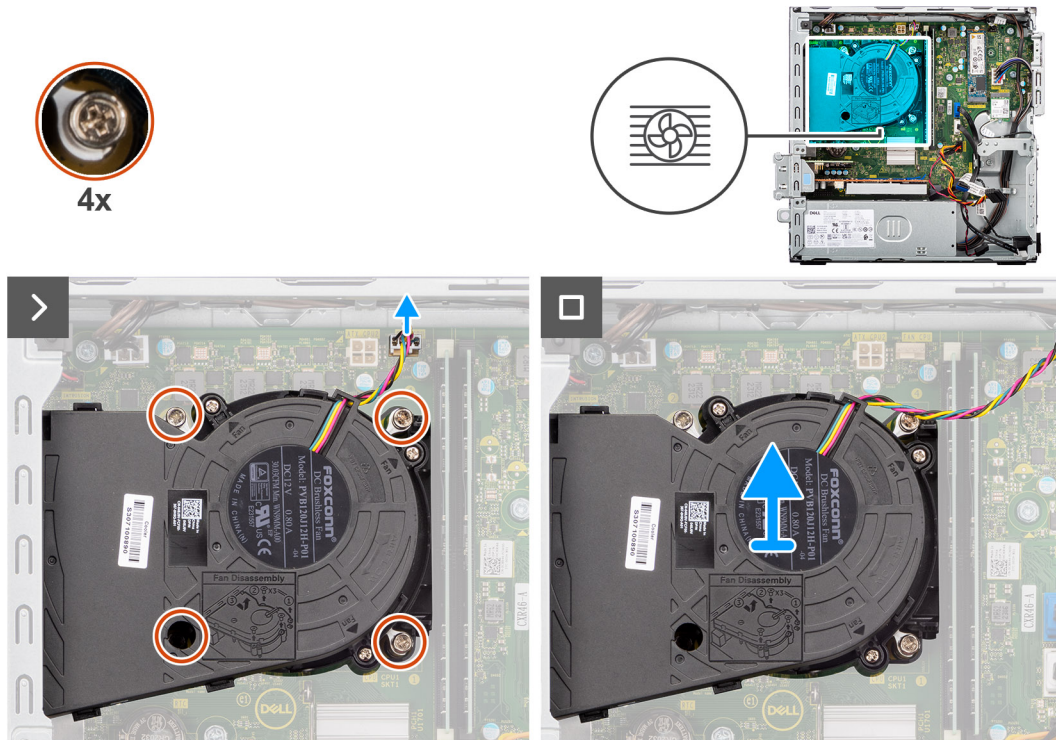

Figure 44. Removing the processor-fan and heat-sink assembly

### Steps

1. Disconnect the processor-fan cable from its connector (FAN CPU) on the system board.
2. In the reverse sequential order (4>3>2>1), loosen the four captive screws that secure the processor fan and heat-sink assembly to the system board.
3. Lift the processor fan and heat-sink assembly off the system board.

## Installing the processor fan and heat-sink assembly

**CAUTION:** The information in this section is intended for authorized service technicians only.

### Prerequisites

If you are replacing a component, remove the existing component before performing the installation procedure.

### About this task

The following images indicate the location of the processor fan and heat-sink assembly and provide a visual representation of the installation procedure.

**NOTE:** If either the processor or the fan and heat-sink assembly is replaced, use the thermal grease provided in the kit to ensure that thermal conductivity is achieved.



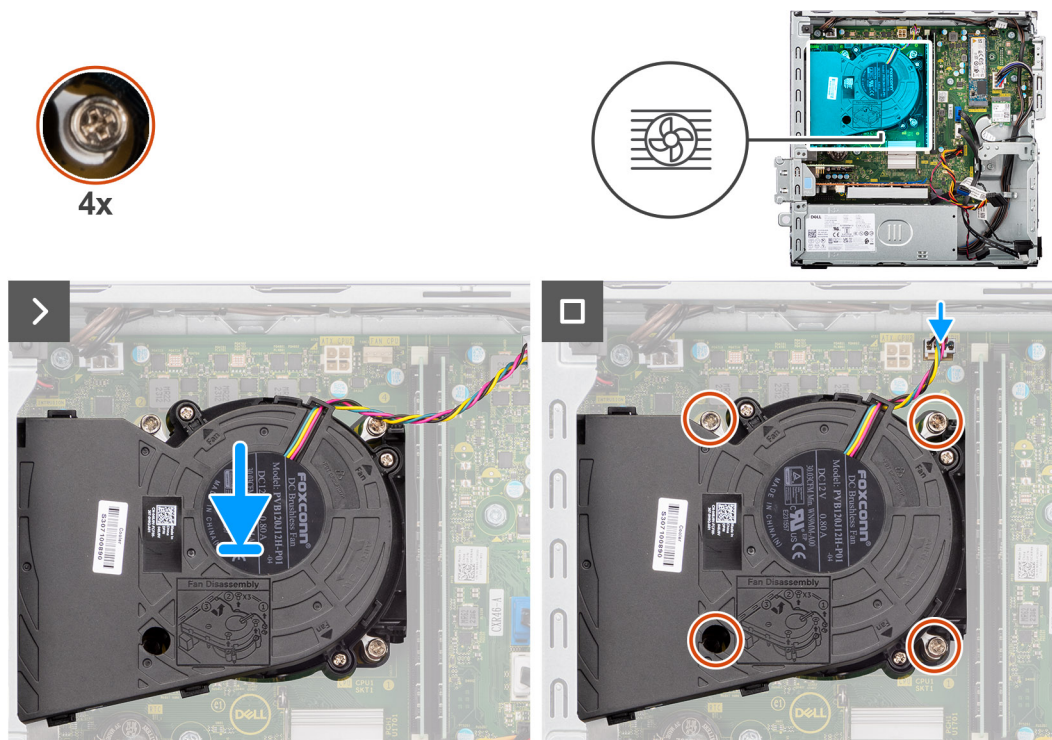

**Figure 45. Installing the processor fan and heat-sink assembly**

### Steps

1. Place the processor fan and heat-sink assembly on the system board and align the captive screws to the screw holes on the system board.
2. In sequential order (1>2>3>4), tighten the four captive screws that secure the processor fan and heat sink assembly to the system board.
3. Connect the processor-fan cable to its connector (FAN CPU) on the system board.

### Next steps

1. Install the [disk-drive cage](#).
2. Install the [3.5-inch hard drive](#), if applicable.
3. Install the [front bezel](#).
4. Install the [side cover](#).
5. Follow the procedure in [After working inside your computer](#).

## Processor

### Removing the processor

**CAUTION:** The information in this section is intended for authorized service technicians only.

### Prerequisites

1. Follow the procedure in [Before working inside your computer](#).
2. Remove the [side cover](#).
3. Remove the [front bezel](#).
4. Remove the [3.5-inch hard drive](#), if applicable.
5. Remove the [disk-drive cage](#).
6. Remove the [processor fan and heat-sink assembly](#).

### About this task

The following images indicate the location of the processor and provide a visual representation of the removal procedure.

**⚠ WARNING:** The processor might still be hot after the computer is shut down. Allow the processor to cool down before removing it.

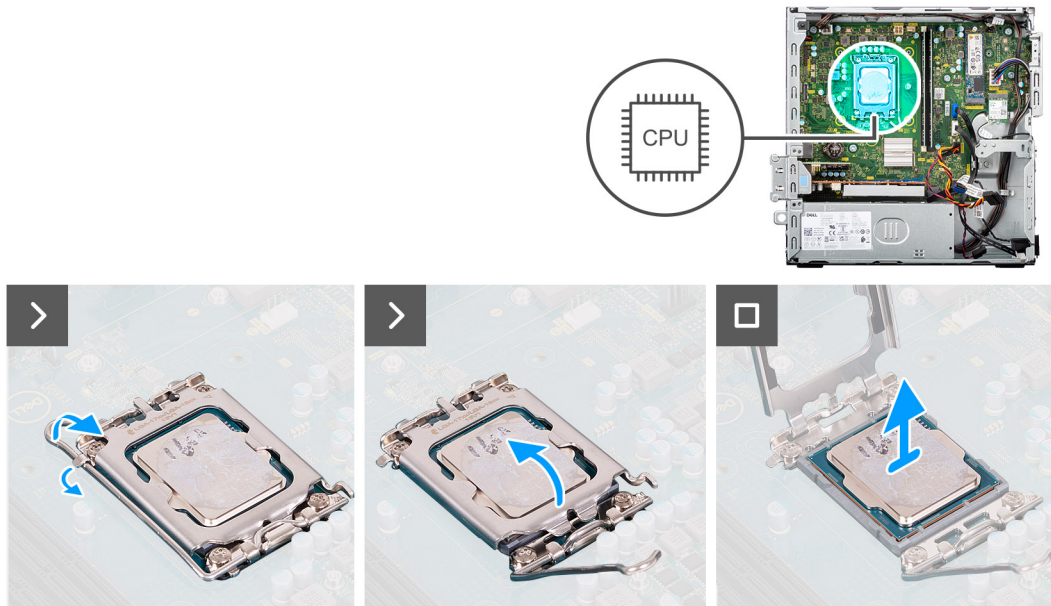

Figure 46. Removing the processor

### Steps

1. Press the release lever down and then push it away from the processor to release it from the securing tab.
2. Extend the release lever completely and open the processor cover.

**⚠ CAUTION:** When removing the processor, do not touch any of the pins inside the socket or allow any objects to fall on the pins in the socket.

3. Gently lift the processor from the processor socket.

## Installing the processor

**⚠ CAUTION:** The information in this section is intended for authorized service technicians only.

### Prerequisites

If you are replacing a component, remove the existing component before performing the installation procedure.

### About this task

The following images indicate the location of the processor and provide a visual representation of the installation procedure.

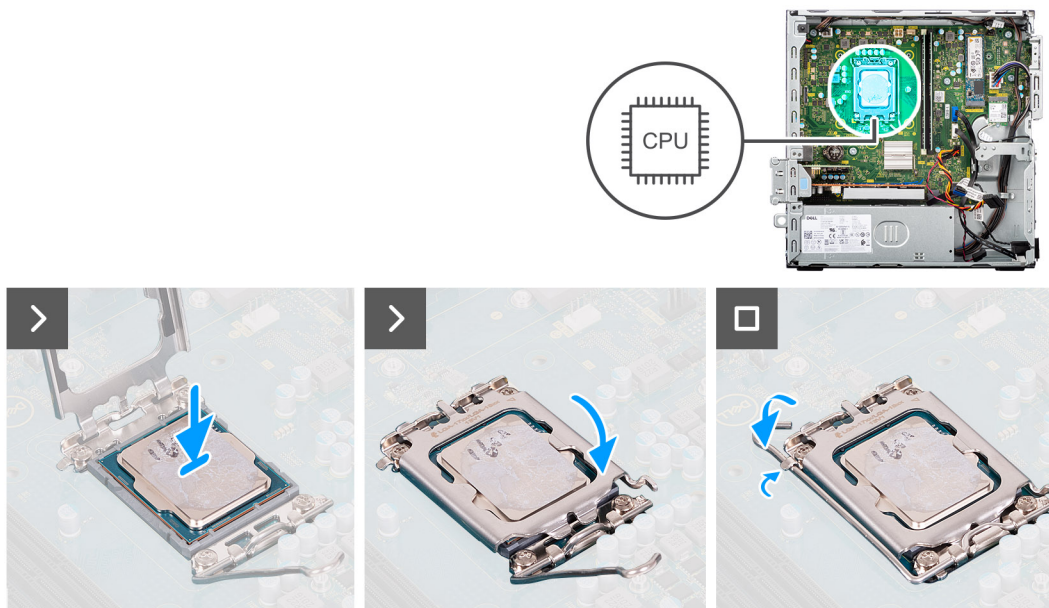

**Figure 47. Installing the processor**

### Steps

1. Ensure that the release lever on the processor socket is fully extended in the open position.
  - NOTE:** The pin-1 corner of the processor has a triangle that aligns with the triangle on the pin-1 corner on the processor socket. When the processor is properly seated, all four corners are aligned at the same height. If one or more corners of the processor are higher than the others, the processor is not seated properly.
2. Align the notches on the processor with the tabs on the processor socket and place the processor in the processor socket.
  - CAUTION:** Ensure that the processor-cover notch is positioned underneath the alignment post.
3. When the processor is fully seated in the socket, pivot the release-lever down and place it under the tab on the processor cover.

### Next steps

1. Install the [processor fan and heat-sink assembly](#).
2. Install the [disk-drive cage](#).
3. Install the [3.5-inch hard drive](#), if applicable.
4. Install the [front bezel](#).
5. Install the [side cover](#).
6. Follow the procedure in [After working inside your computer](#).

## Optional Input/Output modules

### Serial module

#### Removing the serial module

**CAUTION:** The information in this removal section is intended for authorized service technicians only.

#### Prerequisites

1. Follow the procedure in [Before working inside your computer](#).

2. Remove the [side cover](#).
3. Remove the [front bezel](#).
4. Remove the [3.5-inch hard drive](#), if applicable.
5. Remove the [disk-drive cage](#).
6. Remove the [processor fan and heat-sink assembly](#).

**About this task**

The following images indicate the location of the serial module and provide a visual representation of the removal procedure.

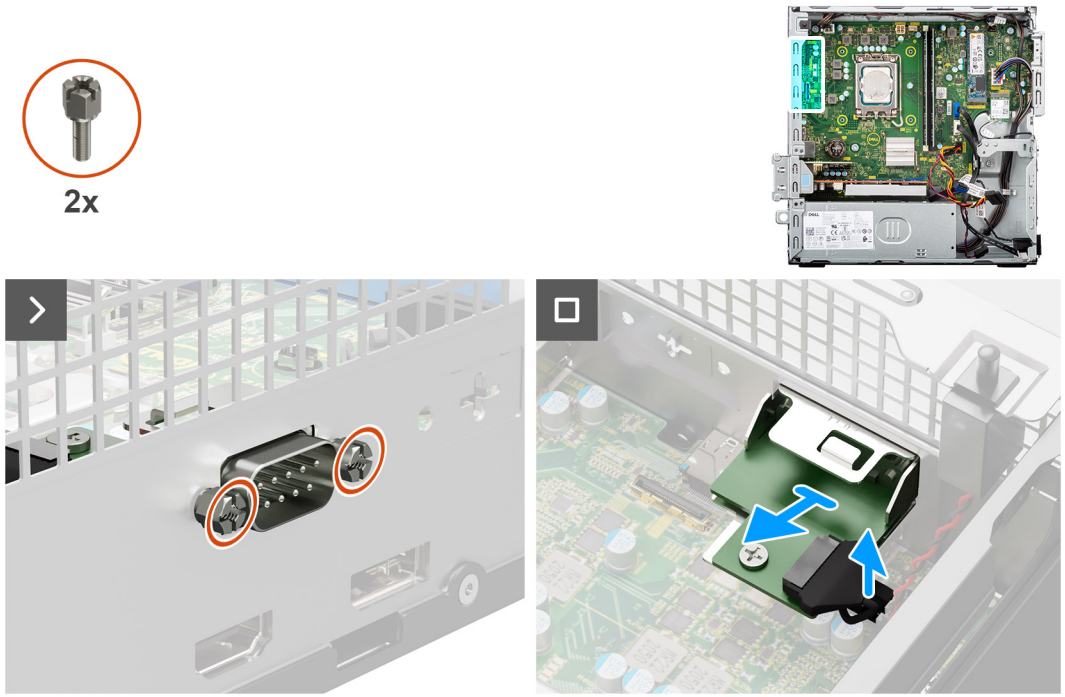

**Figure 48. Removing the serial module**

**Steps**

1. Remove the two screws (M3) that secure the serial module to the chassis.
2. Disconnect the serial-module cable from its connector (KB MS, SERIAL) on the system board.
3. Lift the serial module off the system board.

**Installing the serial module**

**CAUTION:** The information in this removal section is intended for authorized service technicians only.

**Prerequisites**

If you are replacing a component, remove the existing component before performing the installation procedure.

**About this task**

The following images indicate the location of the serial module and provide a visual representation of the installation procedure.

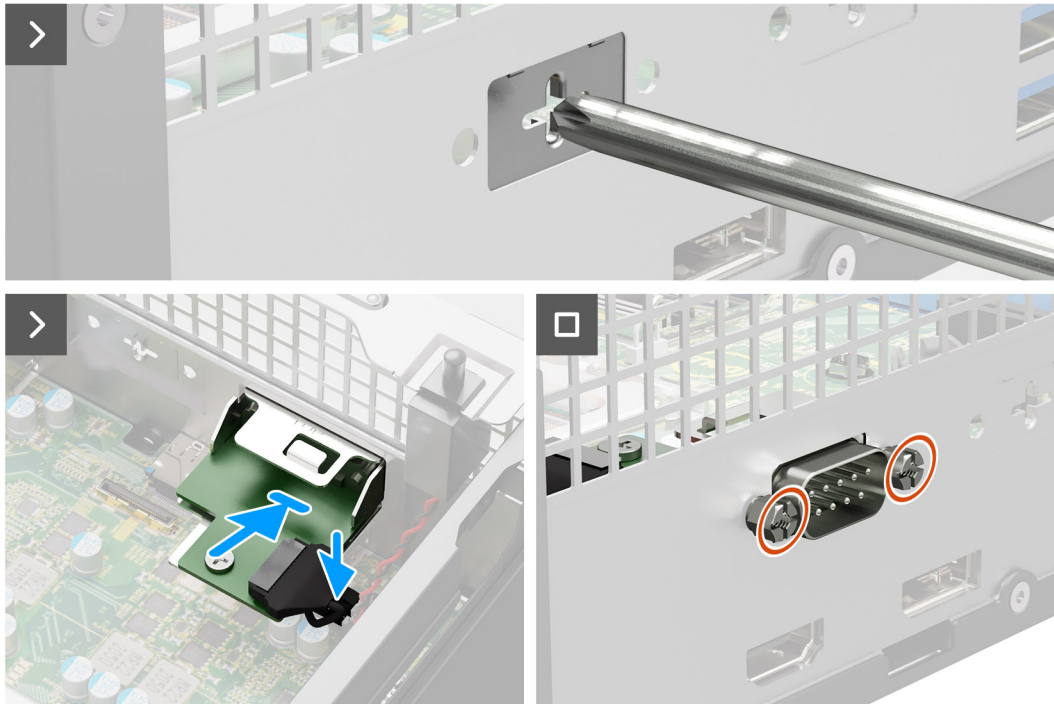

**Figure 49. Installing the serial module**

### Steps

1. Using a screwdriver, remove the serial module cover from the chassis.

**i** **NOTE:** This step is applicable only when the serial module is installed for the first time.

**i** **NOTE:** To remove the optional-module cover, insert a flat-head screwdriver in the hole of the cover, push the cover to release it, and then lift the cover off the chassis .

2. Connect the serial-module cable to its connector (KB MS, SERIAL) on the system board
3. Insert the serial module into the slot on the chassis.
4. Replace the two screws (M3) that secure the serial module to the chassis.

### Next steps

1. Install the [processor fan and heat-sink assembly](#).
2. Install the [disk-drive cage](#).
3. Install the [3.5-inch hard drive](#), if applicable.
4. Install the [front bezel](#).
5. Install the [side cover](#).
6. Follow the procedure in [After working inside your computer](#).

# VGA module

## Removing the VGA module

**CAUTION:** The information in this removal section is intended for authorized service technicians only.

### Prerequisites

1. Follow the procedure in [Before working inside your computer](#).
2. Remove the [side cover](#).
3. Remove the [front bezel](#).
4. Remove the [3.5-inch hard drive](#), if applicable.
5. Remove the [disk-drive cage](#).
6. Remove the [processor fan and heat-sink assembly](#).

### About this task

The following image indicates the location of the VGA module and provides a visual representation of the removal procedure.

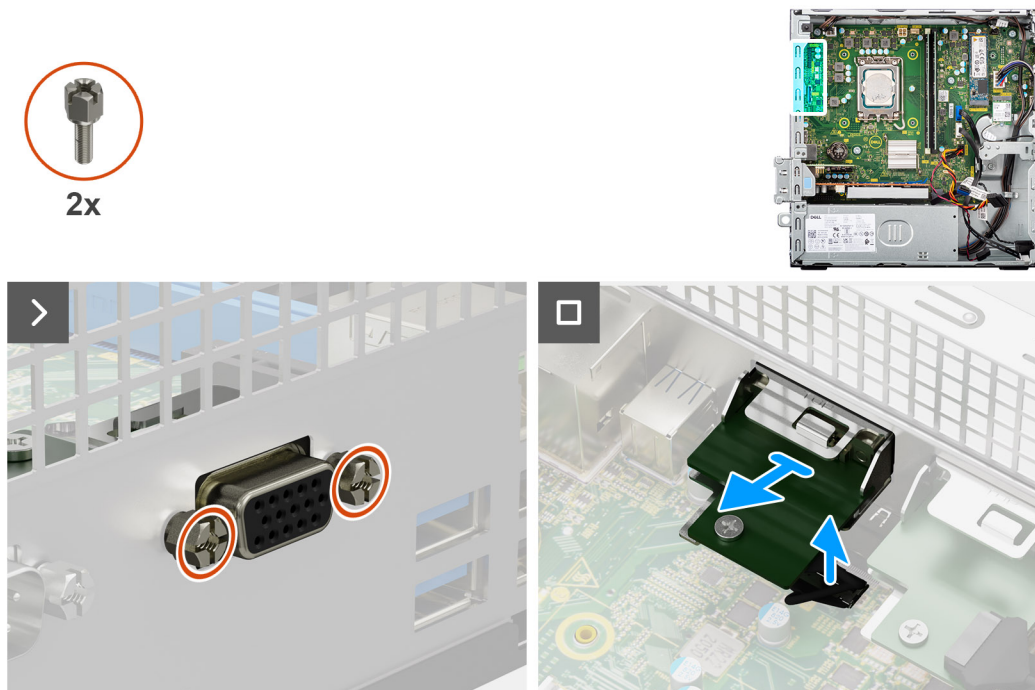

Figure 50. Removing the VGA module

### Steps

1. Remove the two screws (M3) that secure the VGA module to the chassis.
2. Disconnect the VGA-module cable from its connector (VIDEO) on the system board.
3. Lift the VGA module off the system board.

## Installing the VGA module

**CAUTION:** The information in this removal section is intended for authorized service technicians only.

### Prerequisites

If you are replacing a component, remove the existing component before performing the installation procedure.

### About this task

The following image indicates the location of the VGA module and provides a visual representation of the installation procedure.

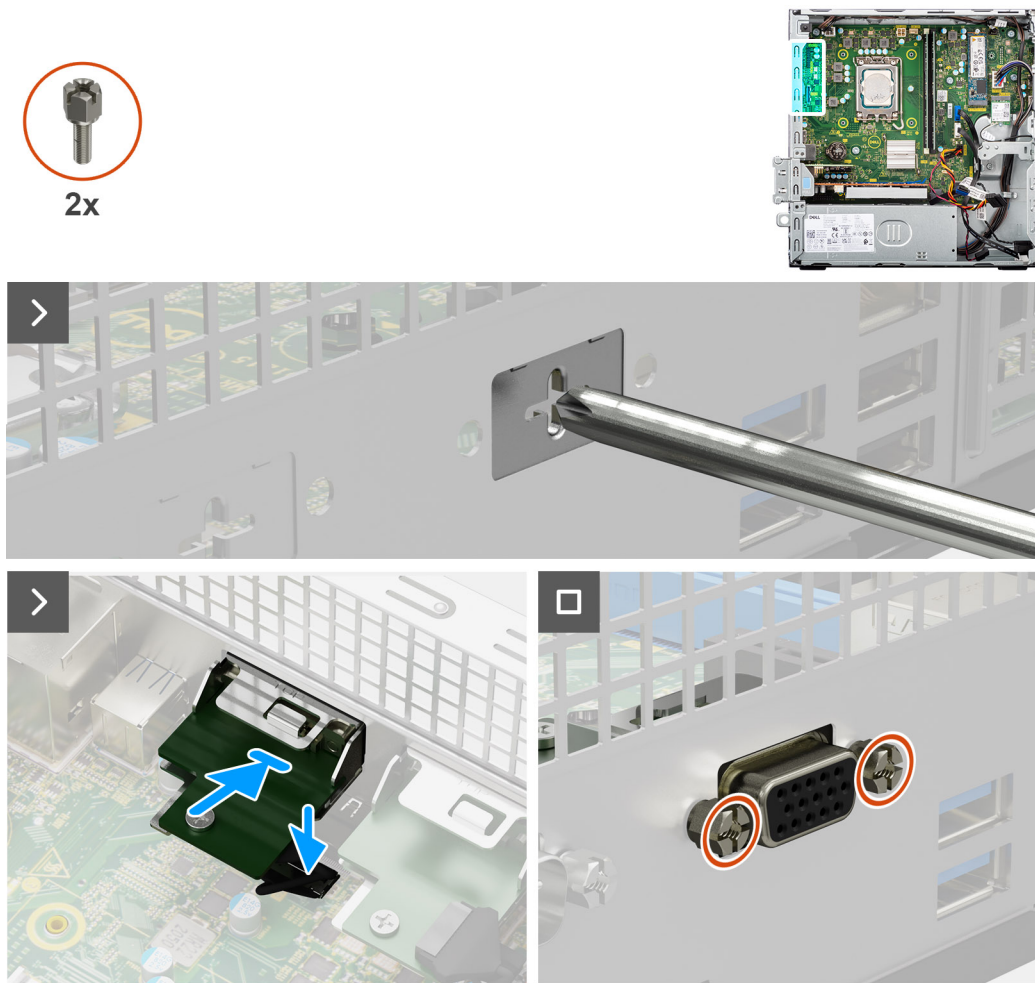

**Figure 51. Installing the VGA module**

### Steps

1. Using a screwdriver, remove the VGA module cover from the chassis.
  - i** **NOTE:** This step is applicable only when the VGA module is being installed for the first time.
  - i** **NOTE:** To remove the optional-module cover, insert a flat-head screwdriver in the hole of the cover, push the cover to release it, and then lift the cover off the chassis .
2. Connect the VGA-module cable to its connector (VIDEO) on the system board.
3. Insert the VGA module into the slot on the chassis.
4. Replace the two screws (M3) that secure the VGA module to the chassis.

### Next steps

1. Install the [processor fan and heat-sink assembly](#).
2. Install the [disk-drive cage](#).
3. Install the [3.5-inch hard drive](#), if applicable.
4. Install the [front bezel](#).
5. Install the [side cover](#).
6. Follow the procedure in [After working inside your computer](#).

# DP module

## Removing the DisplayPort module

**CAUTION:** The information in this removal section is intended for authorized service technicians only.

### Prerequisites

1. Follow the procedure in [Before working inside your computer](#).
2. Remove the [side cover](#).
3. Remove the [front bezel](#).
4. Remove the [3.5-inch hard drive](#), if applicable.
5. Remove the [disk-drive cage](#).
6. Remove the [processor fan and heat-sink assembly](#).

### About this task

The following image indicates the location of the DisplayPort module and provides a visual representation of the removal procedure.

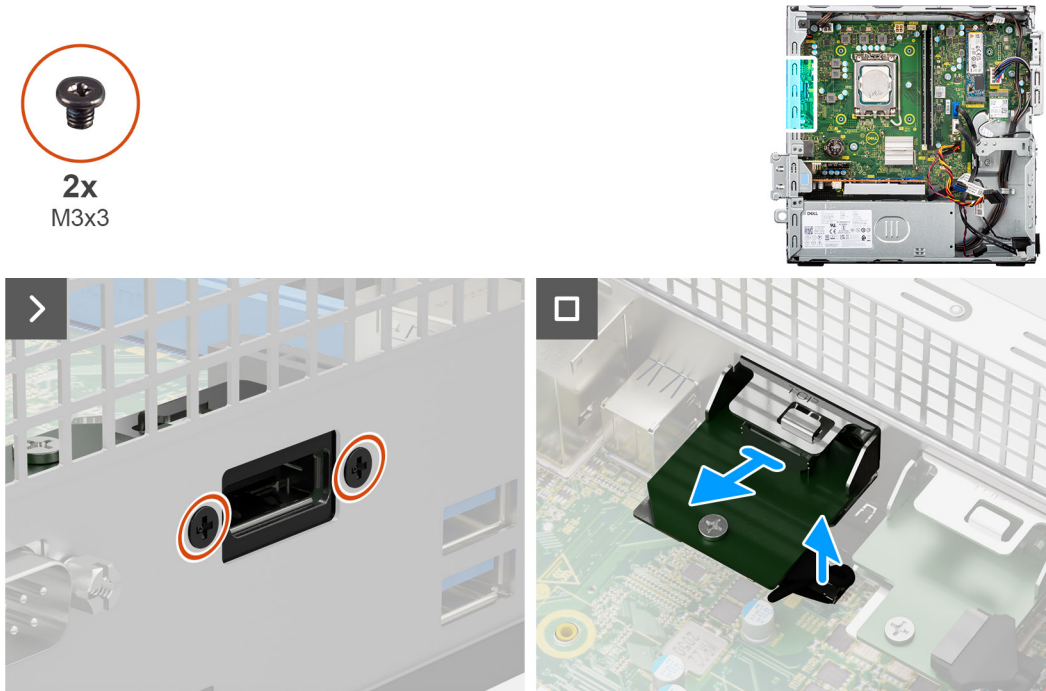

**Figure 52. Removing the DisplayPort module**

### Steps

1. Remove the two screws (M3x3) that secure the DisplayPort module to the chassis.
2. Disconnect the DisplayPort-module cable from its connector (VIDEO) on the system board.
3. Lift the DisplayPort module off the system board.

## Installing the DisplayPort module

**CAUTION:** The information in this removal section is intended for authorized service technicians only.

### Prerequisites

If you are replacing a component, remove the existing component before performing the installation procedure.



### About this task

The following image indicates the location of the DisplayPort module and provides a visual representation of the installation procedure.

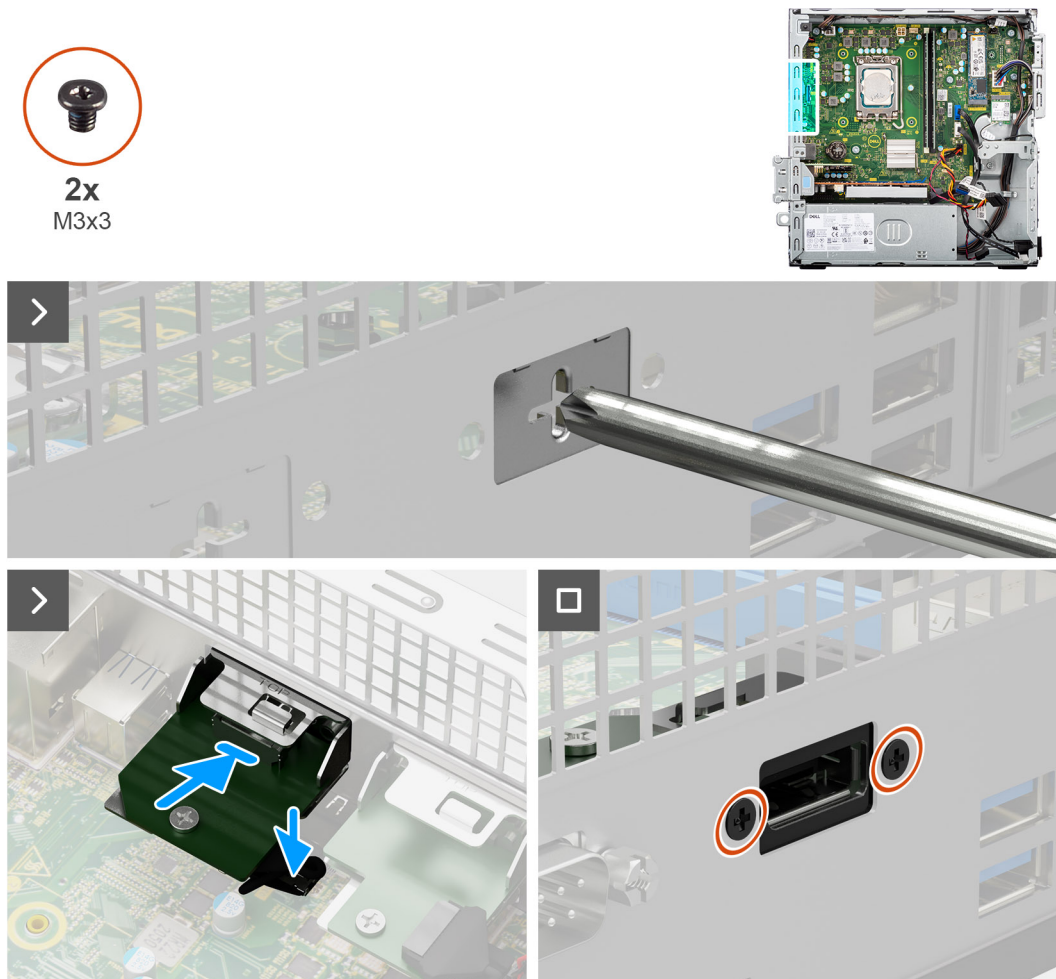

**Figure 53. Installing the DisplayPort module**

### Steps

1. Using a screwdriver, remove the DisplayPort module cover from the chassis.
  - i** **NOTE:** This step is applicable only when the DisplayPort module is being installed for the first time.
  - i** **NOTE:** To remove the optional-module cover, insert a flat-head screwdriver in the hole of the cover, push the cover to release it, and then lift the cover off the chassis .
2. Connect the DisplayPort-module cable to its connector (VIDEO) on the system board.
3. Insert the DisplayPort module into the slot on the chassis.
4. Replace the two screws (M3x3) that secure the DisplayPort module to the chassis.

### Next steps

1. Install the [processor fan and heat-sink assembly](#).
2. Install the [disk-drive cage](#).
3. Install the [3.5-inch hard drive](#), if applicable.
4. Install the [front bezel](#).
5. Install the [side cover](#).
6. Follow the procedure in [After working inside your computer](#).

# HDMI module

## Removing the HDMI module

**CAUTION:** The information in this removal section is intended for authorized service technicians only.

### Prerequisites

1. Follow the procedure in [Before working inside your computer](#).
2. Remove the [side cover](#).
3. Remove the [front bezel](#).
4. Remove the [3.5-inch hard drive](#), if applicable.
5. Remove the [disk-drive cage](#).
6. Remove the [processor fan and heat-sink assembly](#).

### About this task

The following image indicates the location of the HDMI module and provides a visual representation of the removal procedure.

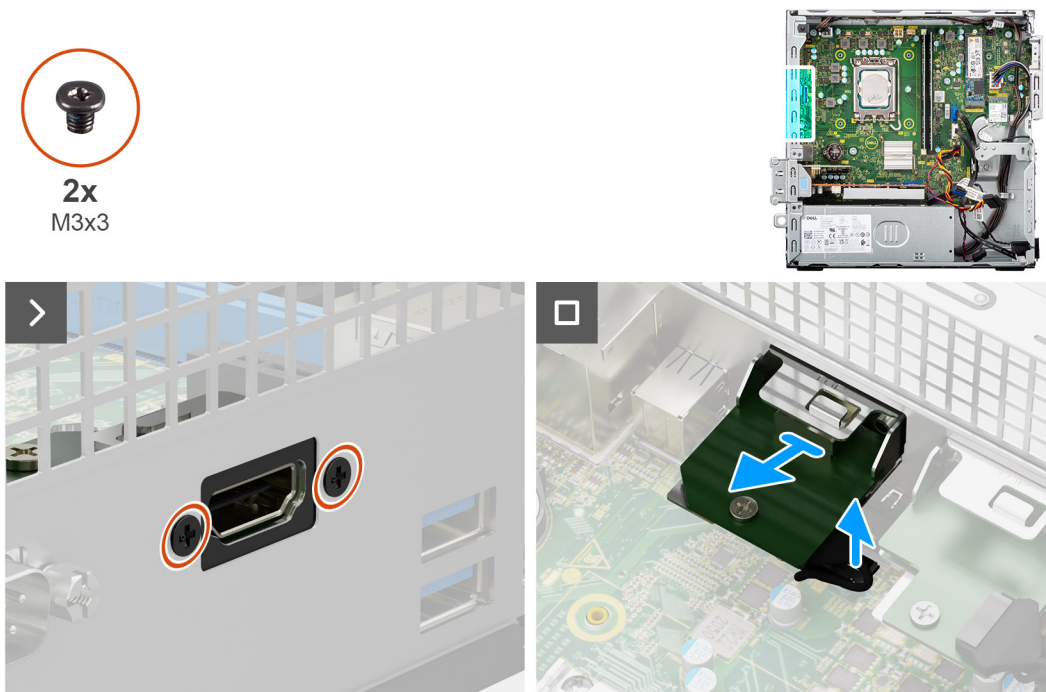

**Figure 54. Removing the HDMI module**

### Steps

1. Remove the two screws (M3x3) that secure the HDMI module to the chassis.
2. Disconnect the HDMI-module cable from its connector (VIDEO) on the system board.
3. Lift the HDMI module off the system board.

## Installing the HDMI module

**CAUTION:** The information in this removal section is intended for authorized service technicians only.

### Prerequisites

If you are replacing a component, remove the existing component before performing the installation procedure.

## About this task

The following image indicates the location of the HDMI module and provides a visual representation of the installation procedure.

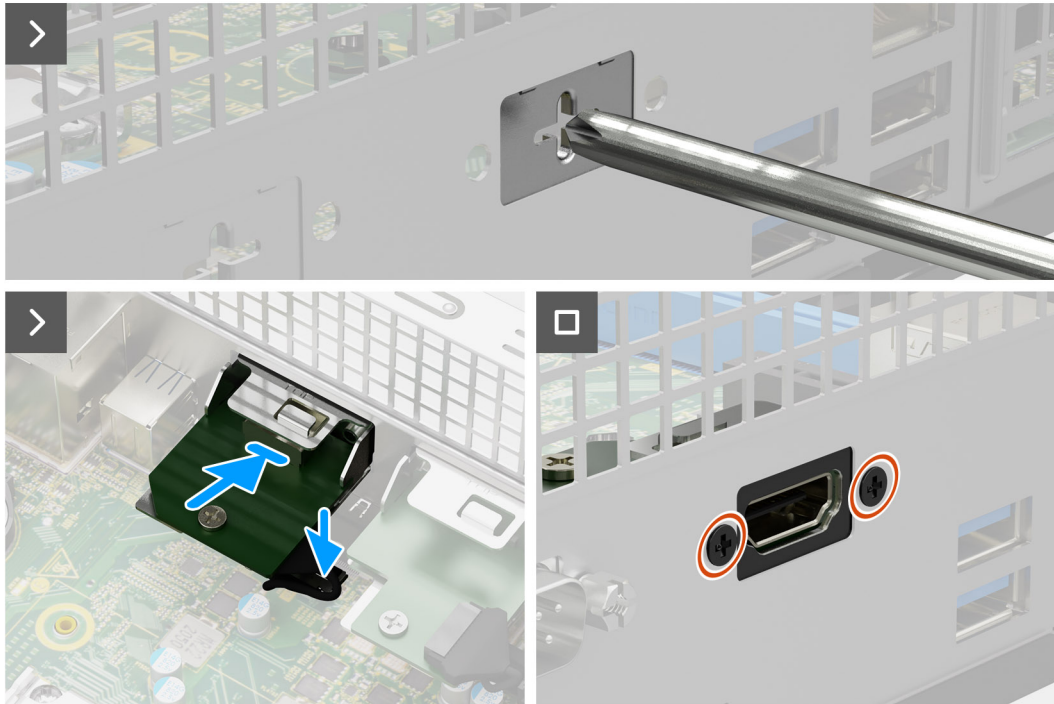

**Figure 55. Installing the HDMI module**

### Steps

1. Using a screwdriver, remove the HDMI module cover from the chassis.
  - NOTE:** This step is applicable only when the HDMI module is being installed for the first time.
  - NOTE:** To remove the optional-module cover, insert a flat-head screwdriver in the hole of the cover, push the cover to release it, and then lift the cover off the chassis .
2. Connect the HDMI-module cable to its connector (VIDEO) on the system board.
3. Insert the HDMI module into the slot on the chassis.
4. Replace the two screws (M3x3) that secure the HDMI module to the chassis.

### Next steps

1. Install the [processor fan and heat-sink assembly](#).
2. Install the [disk-drive cage](#).
3. Install the [3.5-inch hard drive](#), if applicable.
4. Install the [front bezel](#).
5. Install the [side cover](#).
6. Follow the procedure in [After working inside your computer](#).

# System board

## Removing the system board

**CAUTION:** The information in this removal section is intended for authorized service technicians only.

### Prerequisites

1. Follow the procedure in [Before working inside your computer](#).
2. Remove the [side cover](#).
3. Remove the [front bezel](#).
4. Remove the [3.5-inch hard drive](#), if applicable.
5. Remove the [disk-drive cage](#).
6. Remove the [graphics card](#), if applicable.
7. Remove the [internal speaker](#).
8. Remove the [memory modules](#).
9. Remove the [solid-state drives](#).
10. Remove the [wireless card](#) or the [external SMA antenna](#), whichever is applicable.
11. Remove the [intrusion switch](#).
12. Remove the [external SMA antenna module](#), if applicable.
13. Remove the [processor fan and heat-sink assembly](#).
14. Remove the [processor](#).
15. Remove the [optional I/O modules](#), whichever is applicable.

### About this task

The following image indicates the connectors on your system board.

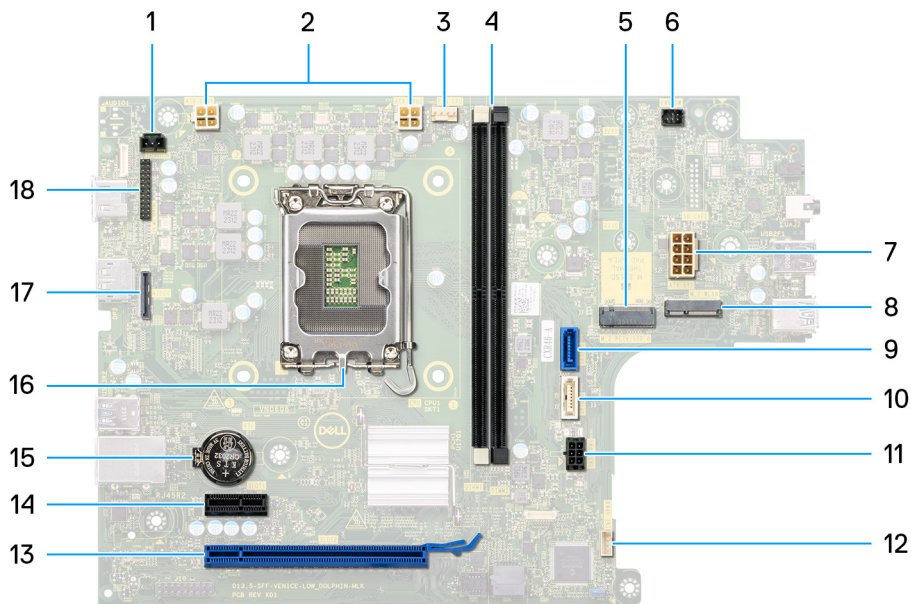

**Figure 56. System board overview**

1. Intrusion-switch connector (INTRUSION)
2. ATX CPU power connector (ATX CPU1 and ATX CPU2)
3. Processor-fan connector (FAN CPU)

4. UDIMM slots

From the left (a>b):

DIMM1

DIMM2

5. M.2 2230/2280 solid-state drive slot (M.2 PCIe SSD-0)

6. Power-button connector (PWR SW)

7. System-power connector (ATX SYS)

8. M.2 WLAN slot (M.2 WLAN)

9. Hard-drive data connector (SATA-0)

10. Optical-drive/hard-drive data connector (SATA-3)

11. SATA power connector (SATA PWR)

12. Internal-speaker connector (INT SPKR)

13. PCIe x16 slot (SLOT2)

14. PCIe x1 slot (SLOT1)

15. Coin-cell battery socket (RTC)

16. Processor socket (CPU)

17. Optional video connector (VIDEO)

18. Serial/PS2 module connector (KB MS SERIAL)

The following images indicate the location of the system board and provide a visual representation of the removal procedure.

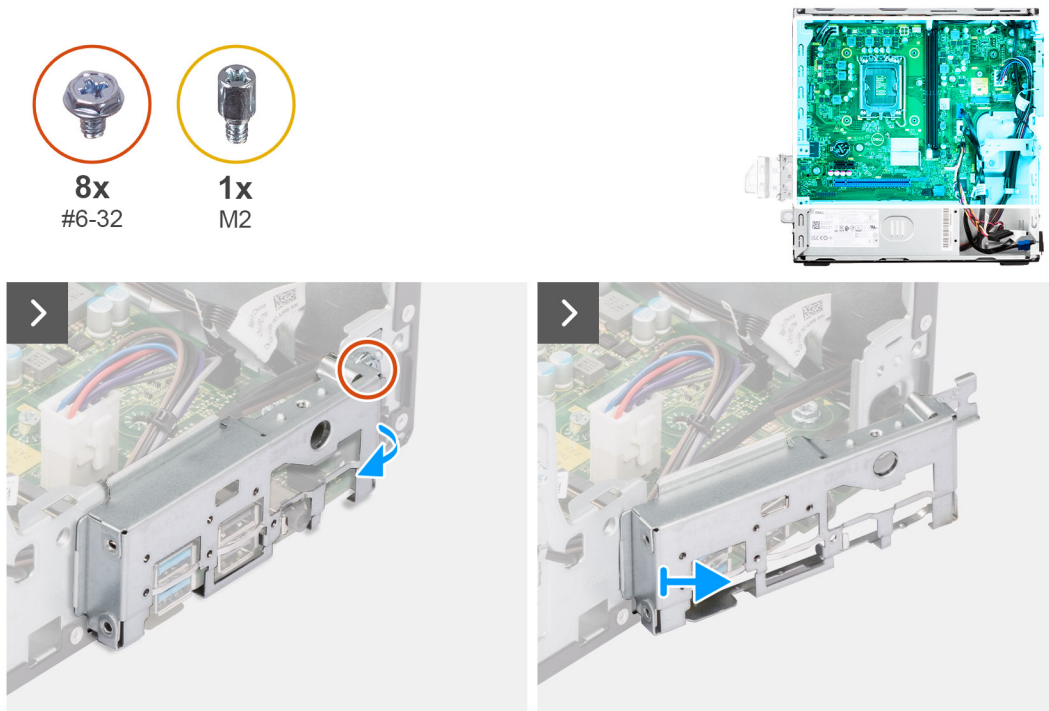

**Figure 57. Removing the system board**

**Steps**

1. Remove the screw (#6-32) that secures the front I/O bracket to the chassis.
2. Rotate and remove the front I/O-bracket from the chassis.

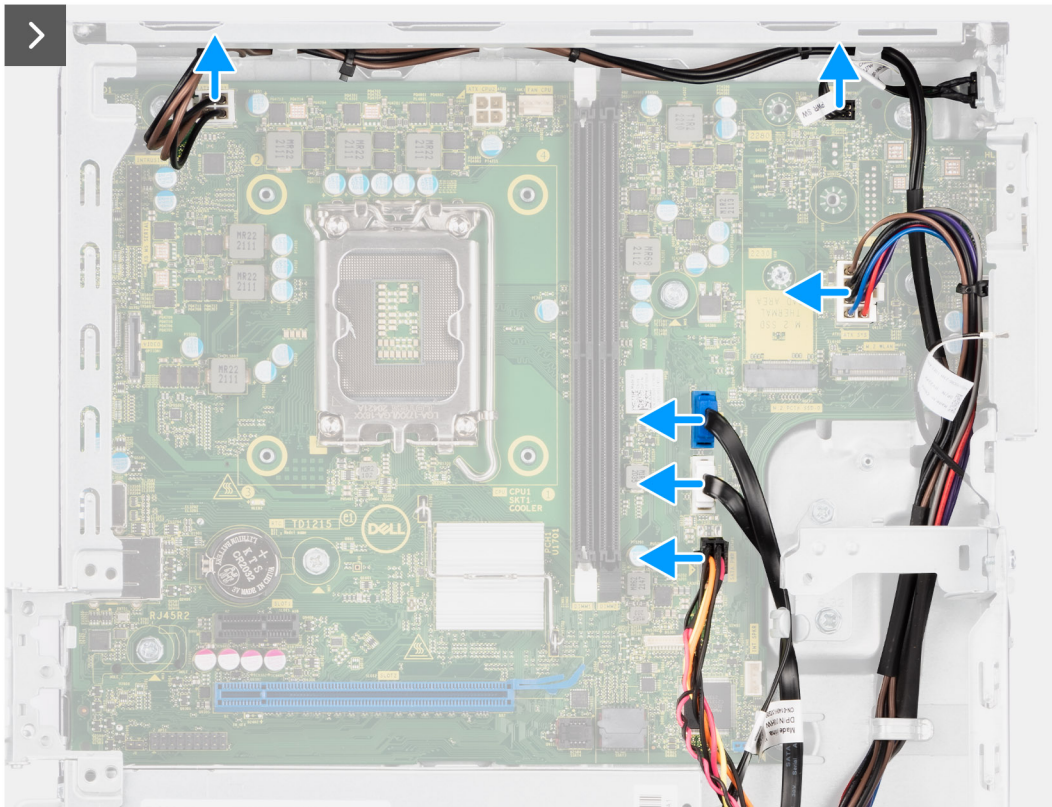

**Figure 58. Removing the system board**

3. Disconnect the power-supply cables from their connectors (ATX CPU1, ATX CPU2 and ATX SYS) on the system board.
4. Disconnect the power button cable from its connector (PWR SW) on the system board.
5. Disconnect the system-fan cable from its connector (FAN SYS) on the system board.
6. Disconnect the hard-drive data cable from its connector (SATA-0) on the system board.
7. Disconnect the optical-drive/hard-drive data cable from its connector (SATA-3) on the system board.
8. Disconnect the SATA power cable from its connector (SATA PWR) on the system board.

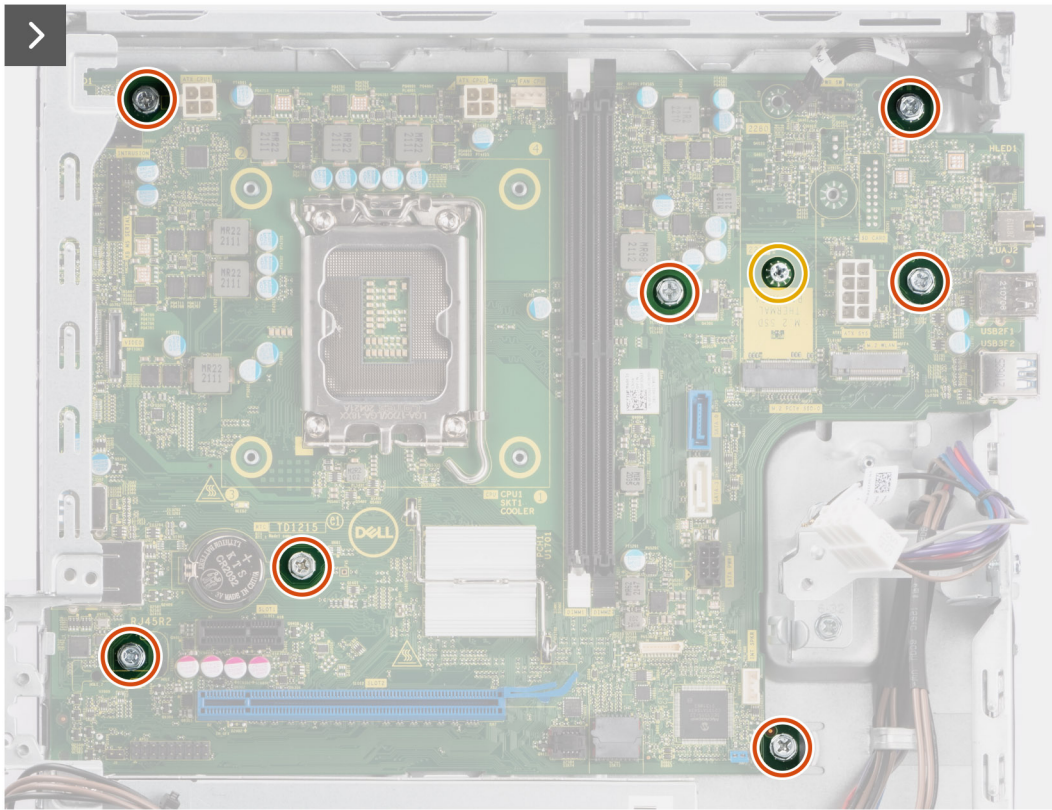

**Figure 59. Removing the system board**

9. Remove the seven screws (#6-32) that secure the system board to the chassis.
10. Remove the screw mount that secures the system board to the chassis, if applicable.

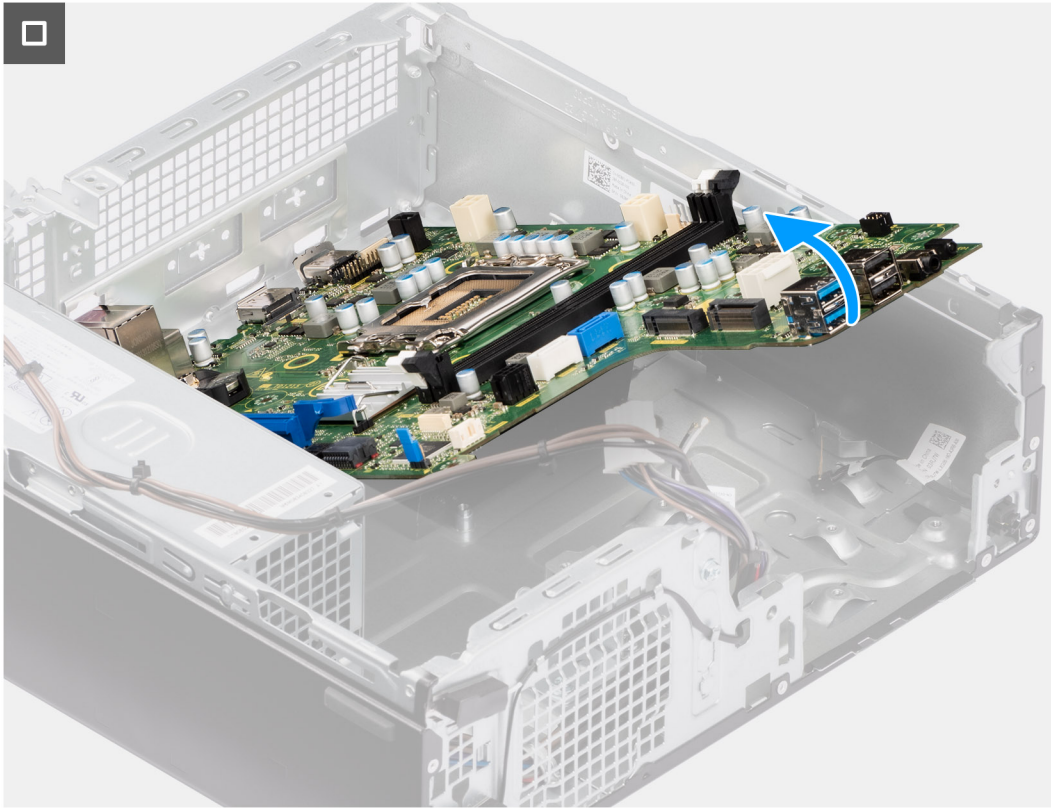

**Figure 60. Removing the system board**

11. Free the system board from the back I/O panel by sliding it towards the right and lift the system board out of the chassis.

## Installing the system board

**CAUTION:** The information in this removal section is intended for authorized service technicians only.

### Prerequisites

If you are replacing a component, remove the existing component before performing the installation procedure.

### About this task

The following image indicates the connectors on your system board.



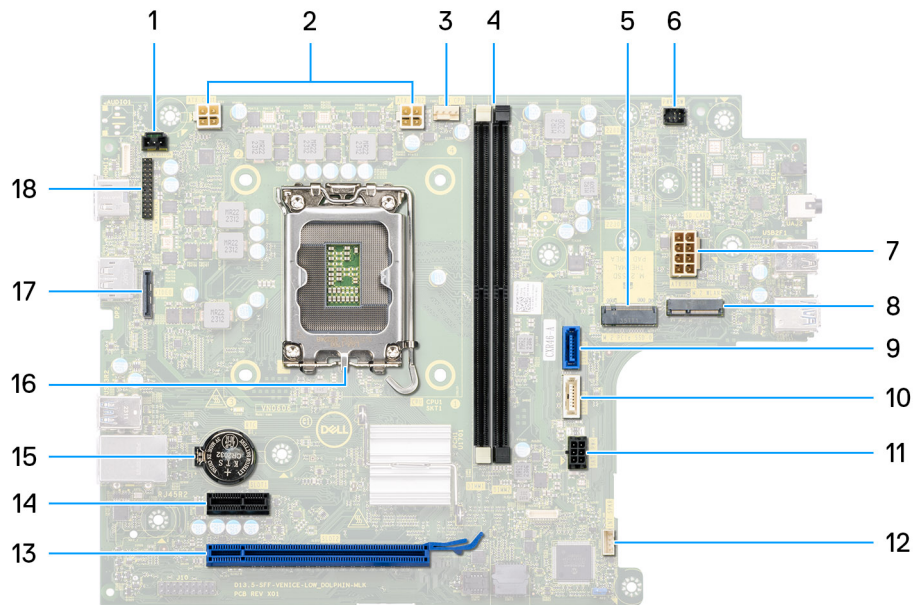

**Figure 61. System board overview**

1. Intrusion-switch connector (INTRUSION)
2. ATX CPU power connector (ATX CPU1 and ATX CPU2)
3. Processor-fan connector (FAN CPU)
4. UDIMM slots  
From the left (a>b):  
DIMM1  
DIMM2
5. M.2 2230/2280 solid-state drive slot (M.2 PCIe SSD-0)
6. Power-button connector (PWR SW)
7. System-power connector (ATX SYS)
8. M.2 WLAN slot (M.2 WLAN)
9. Hard-drive data connector (SATA-0)
10. Optical-drive/hard-drive data connector (SATA-3)
11. SATA power connector (SATA PWR)
12. Internal-speaker connector (INT SPKR)
13. PCIe x16 slot (SLOT2)
14. PCIe x1 slot (SLOT1)
15. Coin-cell battery socket (RTC)
16. Processor socket (CPU)
17. Optional video connector (VIDEO)
18. Serial/PS2 module connector (KB MS SERIAL)

The following image indicates the location of the system board and provides a visual representation of the installation procedure.



8x  
#6-32



1x  
M2

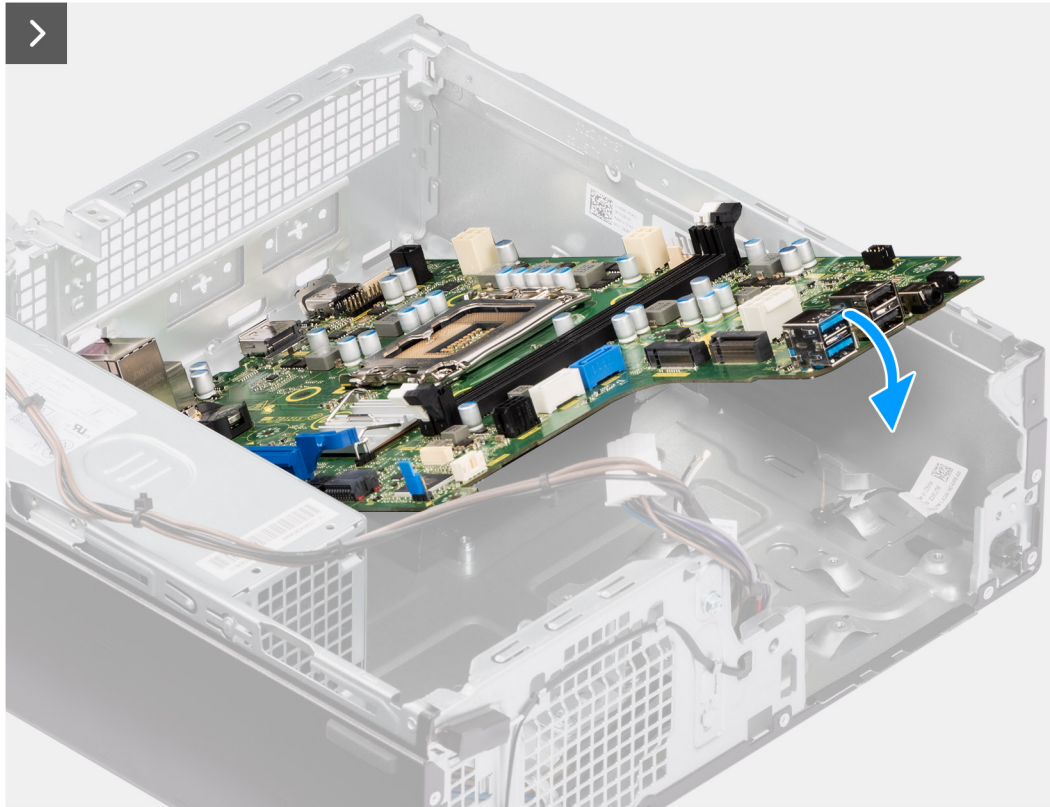
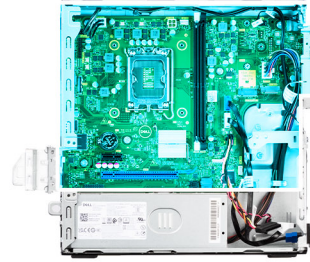

**Figure 62. Installing the system board**

**Steps**

1. Align and lower the system board into the chassis until the standoff points at the back of the system board align with those on the chassis.

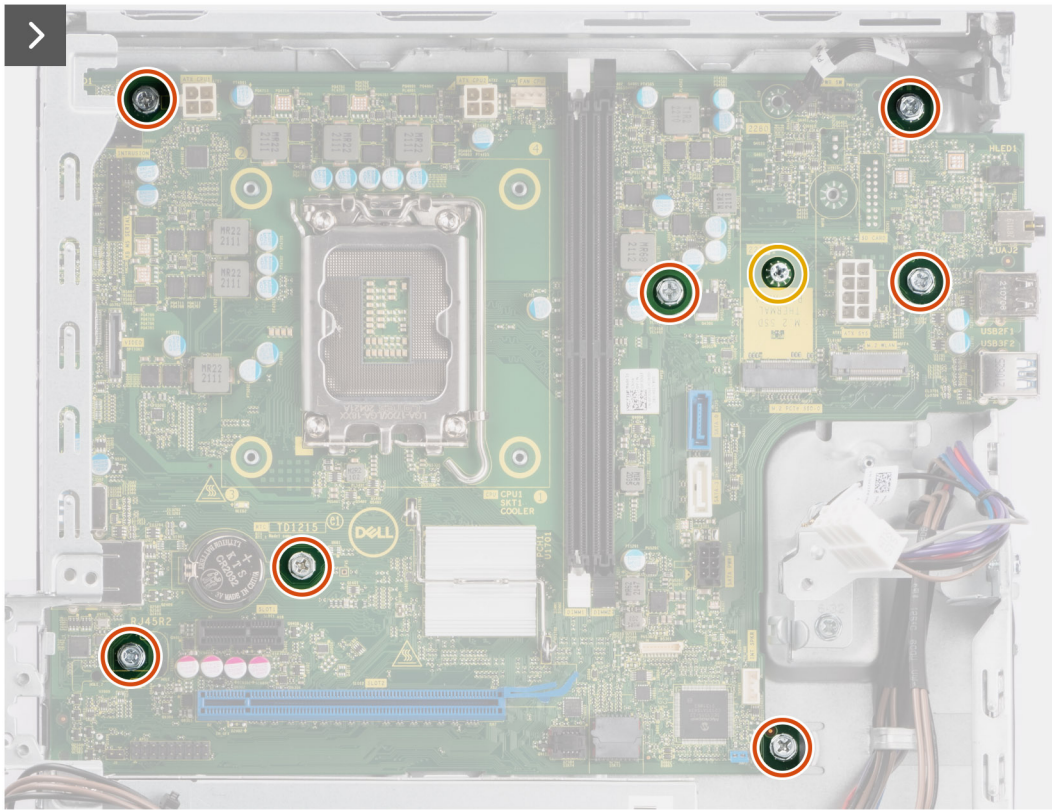

**Figure 63. Installing the system board**

2. Replace the screw mount that secures the system board to the chassis, if applicable.
3. Replace the seven screws (#6-32) that secure the system board to the chassis.

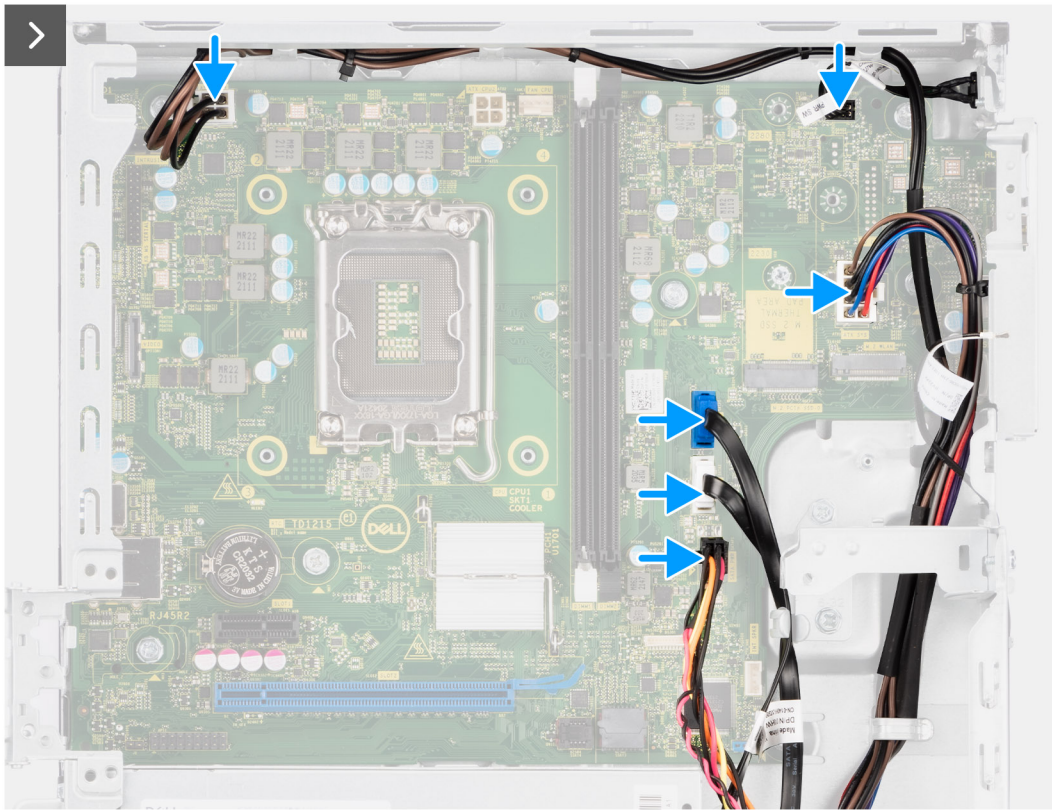

**Figure 64. Installing the system board**

4. Route and connect the SATA power cable to its connector (SATA PWR) on the system board.
5. Route and connect the optical-drive/hard-drive data cable to its connector (SATA-3) on the system board.
6. Route and connect the hard-drive data cable to its connector (SATA-0) on the system board.
7. Route and connect the system-fan cable to its connector (FAN SYS) on the system board.
8. Route and connect the power-button cable to its connector (PWR SW) on the system board.
9. Route and connect the power-supply cables to their connectors (ATX CPU1, ATX CPU2 and ATX SYS) on the system board.

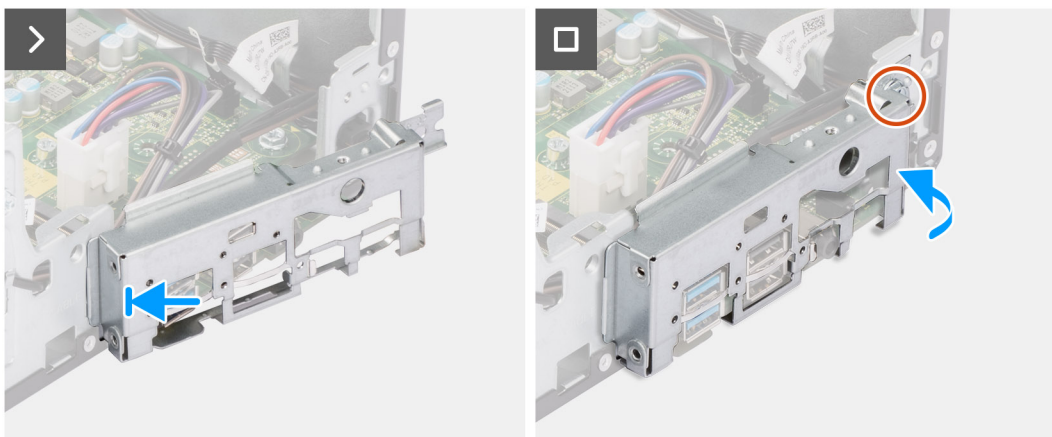

**Figure 65. Installing the system board**

10. Place and align the front I/O-bracket with the I/O slot on the chassis.
11. Replace the screw (#6-32) that secures the front I/O-bracket to the chassis.

**Next steps**

1. Install the [optional I/O modules](#), whichever is applicable.

2. Install the [processor](#).
3. Install the [processor fan and heat-sink assembly](#).
4. Install the [external SMA antenna module](#), if applicable.
5. Install the [intrusion switch](#).
6. Install the [wireless card](#) or the [external SMA antenna](#), whichever is applicable.
7. Install the [solid-state drives](#).
8. Install the [memory modules](#).
9. Install the [internal speaker](#).
10. Install the [graphics card](#), if applicable.
11. Install the [disk-drive cage](#).
12. Install the [3.5-inch hard drive](#), if applicable.
13. Install the [front bezel](#).
14. Install the [side cover](#).
15. Follow the procedure in [After working inside your computer](#).

# Software

This chapter details the supported operating systems along with instructions on how to install the drivers.

## Operating system

Your OptiPlex Small Form Factor 7020 supports the following operating systems:

- Windows 11 Home
- Windows 11 Pro
- Windows 11 Pro National Education
- Ubuntu Linux 22.04 LTS

## Drivers and downloads

When troubleshooting, downloading, or installing drivers, it is recommended that you read the Dell Knowledge Base article [Drivers and Downloads FAQs 000123347](#).

# BIOS Setup

**CAUTION:** Unless you are an expert computer user, do not change the settings in the BIOS Setup. Certain changes can make your computer work incorrectly.

**NOTE:** Depending on the computer and the installed devices, the options that are listed in this section may or may not be displayed.

**NOTE:** Before you change the settings in BIOS Setup, it is recommended that you note down the original settings for future reference.

Use BIOS Setup for the following purposes:

- Get information about the hardware installed in your computer, such as the amount of RAM and the size of the storage device.
- Change the system configuration information.
- Set or change a user-selectable option, such as the user password, type of hard drive installed, and enable or disable base devices.

## Entering BIOS Setup program

### About this task

Turn on (or restart) your computer and press F2 immediately.

## Navigation keys

**NOTE:** For most of the BIOS Setup options, changes that you make are recorded but do not take effect until you restart the computer.

**Table 29. Navigation keys**

| Keys       | Navigation   |
|------------|--|
| Up arrow   | Moves to the previous field.   |
| Down arrow | Moves to the next field.   |
| Enter      | Selects a value in the selected field (if applicable) or follows the link in the field.  |
| Spacebar   | Expands or collapses a drop-down list, if applicable.  |
| Tab        | Moves to the next focus area.  |
| Esc        | Moves to the previous page until you view the main screen. Pressing Esc in the main screen displays a message that prompts you to save any unsaved changes and restart the computer. |

## F12 One Time Boot menu

To enter the One Time Boot menu, turn on your computer, and then press F12 immediately.

**NOTE:** If you are unable to enter the One Time Boot menu, repeat the above action.

The One Time Boot menu displays the devices that you can boot from and also display the options to start diagnostics. The boot menu options are:

- Removable Drive (if available)
- STXXXX Drive (if available)
-  **NOTE:** XXX denotes the SATA drive number.
- Optical Drive (if available)
- SATA Hard Drive (if available)
- Diagnostics

The One Time Boot menu screen also displays the option to access BIOS Setup.

## System setup options

 **NOTE:** Depending on your computer and its installed devices, the items that are listed in this section may or may not be displayed.

**Table 30. System setup options—Overview menu**

| <b>Overview</b>               |  |
|-------------------------------|--|
| BIOS Version                  | Displays the BIOS version number.  |
| Service Tag                   | Displays the Service Tag of the computer.  |
| Asset Tag                     | Displays the Asset Tag of the computer.  |
| Manufacture Date              | Displays the manufacture date of the computer.   |
| Ownership Date                | Displays the ownership date of the computer.   |
| Express Service Code          | Displays the Express Service Code of the computer.   |
| Ownership Tag                 | Displays the Ownership Tag of the computer.  |
| Signed Firmware Update        | Displays whether the Signed Firmware Update is enabled on your computer.<br>By default, the <b>Signed Firmware Update</b> option is enabled. |
| <b>Processor Information</b>  |  |
| Processor Type                | Displays the processor type.   |
| Maximum Clock Speed           | Displays the maximum processor clock speed.  |
| Minimum Clock Speed           | Displays the minimum processor clock speed.  |
| Current Clock Speed           | Displays the current processor clock speed.  |
| Core Count                    | Displays the number of cores on the processor.   |
| Processor ID                  | Displays the processor identification code.  |
| Processor L2 Cache            | Displays the processor L2 Cache size.  |
| Processor L3 Cache            | Displays the processor L3 Cache size.  |
| Microcode Version             | Displays the microcode version.  |
| Intel Hyper-Threading Capable | Displays whether the processor is Hyper-Threading (HT) capable.  |
| 64-Bit Technology             | Displays whether 64-bit technology is used.  |
| <b>Memory Information</b>     |  |
| Memory Installed              | Displays the total computer memory installed.  |
| Memory Available              | Displays the total computer memory available.  |
| Memory Speed                  | Displays the memory speed.   |



**Table 30. System setup options—Overview menu (continued)**

| <b>Overview</b>            |  |
|----------------------------|--|
| Memory Channel Mode        | Displays single or dual channel mode.                      |
| Memory Technology          | Displays the technology that is used for the memory.       |
| DIMM 1 Size                | Displays the DIMM 1 memory size.                           |
| DIMM 2 Size                | Displays the DIMM 2 memory size.                           |
| <b>Devices Information</b> |  |
| Video Controller           | Displays the video controller type of the computer.        |
| Video Memory               | Displays the video memory information of the computer.     |
| Wi-Fi Device               | Displays the wireless device information of the computer.  |
| Native Resolution          | Displays the native resolution of the computer.            |
| Video BIOS Version         | Displays the video BIOS version of the computer.           |
| Audio Controller           | Displays the audio controller information of the computer. |
| Bluetooth Device           | Displays the Bluetooth device information of the computer. |
| LOM MAC Address            | Displays the LOM MAC address of the computer.              |
| dGPU Video Controller      | Displays the dGPU video controller of the computer.        |
| Slot 1                     | Displays the slot 1 information of the computer.           |
| Slot 2                     | Displays the slot 2 information of the computer.           |

**Table 31. System setup options—Boot Configuration menu**

| <b>Boot Configuration</b>     |   |
|-------------------------------|---|
| <b>Boot Sequence</b>          |   |
| Boot Mode: UEFI only          | Displays the boot mode of the computer.   |
| Boot Sequence                 | Displays the boot sequence.   |
| Enable PXE Boot Priority      | Enables or disables a new PXE boot option to move to the top of the Boot Sequence.<br><br>By default, the <b>Enable PXE Boot Priority</b> option is disabled.   |
| Force PXE on Next Boot        | Enables or disables the Force PXE on next boot.<br><br>By default, the <b>Force PXE on Next Boot</b> option is not selected.  |
| Secure Digital (SD) Card Boot | Enables or disables read-only boot from Secure Digital (SD) card.<br><br>By default, the <b>Secure Digital (SD) Card Boot</b> option is enabled.  |
| <b>Secure Boot</b>            |   |
|                               | Secure Boot is a method of guaranteeing the integrity of the boot path by performing additional validation of the operating system and PCI add-in cards. The computer stops booting to the operating system when a component is not authenticated during the boot process. Secure Boot can be enabled in BIOS setup or using management interfaces like Dell Command Configure, but can only be disabled from BIOS setup. |
| Enable Secure Boot            | Enables the computer to boot using only validated boot software.<br><br>By default, the <b>Enable Secure Boot</b> option is enabled.<br><br>For additional security, Dell Technologies recommends keeping the <b>Secure Boot</b> option enabled to ensure that the UEFI firmware validates the operating system during the boot process.  |

**Table 31. System setup options—Boot Configuration menu (continued)**

| <b>Boot Configuration</b>    |   |
|------------------------------|---|
|                              | <p><b>i</b> <b>NOTE:</b> For Secure Boot to be enabled, the computer is required to be in UEFI boot mode and the Enable Legacy Option ROMs option is required to be turned off.</p>   |
| Enable Microsoft UEFI CA     | <p>When disabled, the UEFI CA is removed from the BIOS UEFI Secure Boot database.</p> <p><b>i</b> <b>NOTE:</b> When disabled, the Microsoft UEFI CA could render your computer unable to boot, computer graphics may not function, some devices may not function properly, and the computer could become unrecoverable.</p> <p>By default, the <b>Enable Microsoft UEFI CA</b> option is enabled.</p> <p>For additional security, Dell Technologies recommends keeping the <b>Microsoft UEFI CA</b> option enabled to ensure the broadest compatibility with devices and operating systems.</p> |
| Secure Boot Mode             | <p>Enables or disables the Secure Boot operation mode.</p> <p>By default, the <b>Deployed Mode</b> is selected.</p> <p><b>i</b> <b>NOTE:</b> <b>Deployed Mode</b> should be selected for normal operation of Secure Boot.</p>   |
| <b>Expert Key Management</b> |   |
| Enable Custom Mode           | <p>Enables or disables the keys in the PK, KEK, db, and dbx security key databases to be modified.</p> <p>By default, the <b>Enable Custom Mode</b> option is disabled.</p>   |
| Custom Mode Key Management   | <p>Selects the custom values for expert key management.</p> <p>By default, the <b>PK</b> option is selected.</p>  |

**Table 32. System setup options—Integrated Devices menu**

| <b>Integrated Devices</b> |  |
|---------------------------|--|
| <b>Date/Time</b>          |  |
| Date                      | Sets the computer date in MM/DD/YYYY format. Changes to the date format take effect immediately.   |
| Time                      | Sets the computer time in HH/MM/SS 24-hour format. You can switch between a 12-hour and 24-hour clock. Changes to the time format take effect immediately.   |
| <b>Audio</b>              |  |
| Enable Audio              | <p>Enables all integrated audio controller.</p> <p>By default, all the options are enabled.</p>  |
| Enable Microphone         | <p>Enables the microphone.</p> <p>By default, the <b>Enable Microphone</b> option is enabled.</p> <p><b>i</b> <b>NOTE:</b> Depending on the configuration ordered, the microphone setup option may not be available.</p> |
| Enable Internal Speaker   | <p>Enables the internal speaker.</p> <p>By default, the <b>Enable Internal Speaker</b> option is enabled.</p>  |
| <b>USB Configuration</b>  |  |
| Enable Front USB Ports    | <p>Enables the front USB ports.</p> <p>By default, the <b>Enable Front USB Ports</b> option is enabled.</p>  |

**Table 32. System setup options—Integrated Devices menu (continued)**

| <b>Integrated Devices</b>      |   |
|--------------------------------|---|
| Enable Rear USB Ports          | Enables the rear USB ports.<br>By default, the <b>Enable Rear USB Ports</b> option is enabled.  |
| Enable USB Boot Support        | Enables booting from USB mass storage devices that are connected to external USB ports.<br>By default, the <b>Enable USB Boot Support</b> option is enabled.                |
| <b>Front USB Configuration</b> | Allows the user to enable or disable individual front USB ports.<br>By default, all the front USB ports are enabled.  |
| <b>Rear USB Configuration</b>  | Allows the user to enable or disable individual rear USB ports.<br>By default, all the rear USB ports are enabled.  |
| <b>Dust Filter Maintenance</b> |   |
| Dust Filter Maintenance        | Enables or disables BIOS messages for maintaining the optional dust filter installed in the computer.<br>By default, the <b>Dust Filter Maintenance</b> option is disabled. |

**Table 33. System setup options—Storage menu**

| <b>Storage</b>             |   |
|----------------------------|---|
| <b>SATA/NVMe Operation</b> |   |
| SATA/NVMe Operation        | Sets the operating mode of the integrated SATA hard drive controller.<br>By default, the <b>RAID On</b> option is selected.                                     |
| <b>Storage Interface</b>   |   |
| Port Enablement            | Enables or disables the M.2 PCIe SSD option.<br>By default, the <b>SATA</b> option is enabled.<br>By default, the <b>M.2 PCIe SSD</b> option is enabled.        |
| <b>SMART Reporting</b>     |   |
| Enable SMART Reporting     | Enables or disables the BIOS to report integrated hard-drive errors during system startup.<br>By default, the <b>Enable SMART Reporting</b> option is disabled. |
| <b>Drive Information</b>   |   |
|                            | Displays the information of onboard drives.   |

**Table 34. System setup options—Display menu**

| <b>Display</b>          |   |
|-------------------------|---|
| <b>Multi-Display</b>    |   |
| Enable Multi-Display    | Enables or disables the multi-display feature of the Windows operating system.<br>By default, the <b>Enable Multi-Display</b> option is enabled.  |
| <b>Primary Display</b>  |   |
| Primary Display         | Allows the user to select which video controller will be utilized for primary display if there are multiple video controllers in the system.<br>By default, the <b>Auto</b> option is selected. |
| <b>Full Screen Logo</b> |   |
|                         | Enables or disables the computer to display a full-screen logo, if the image matches screen resolution.   |

**Table 34. System setup options—Display menu (continued)**

|   |  |
|---|--|
| <b>Display</b>  |  |
| By default, the <b>Full Screen Logo</b> option is disabled. |  |

**Table 35. System setup options—Connection menu**

|   |  |
|---|--|
| <b>Connection</b>                       |  |
| <b>Network Controller Configuration</b> |  |
| Integrated NIC                          | Enables or disables the onboard LAN controller.<br>By default, the <b>Enabled with PXE</b> option is selected.   |
| <b>Wireless Device Enable</b>           |  |
| WLAN                                    | Enables or disables the internal WLAN device.<br>By default, the <b>WLAN</b> option enabled.   |
| Bluetooth                               | Enables or disables the internal Bluetooth device.<br>By default, the <b>Bluetooth</b> option enabled.   |
| <b>Enable UEFI Network Stack</b>        | Enables or disables the UEFI Network Stack and controls the onboard LAN Controller.<br>By default, the <b>Auto Enabled</b> option is selected.   |
| <b>HTTP(s) Boot Feature</b>             |  |
| HTTP(s) Boot                            | Enables or disables HTTP(s) Boot feature.<br>By default, the <b>HTTP(s) Boot</b> option is enabled.  |
| HTTP(s) Boot Modes                      | Configures HTTP(s) Boot Modes.<br>By default, <b>Auto Mode</b> option is selected. HTTP(s) Boot automatically extracts Boot URL from the Dynamic Host Configuration (DHCP).<br> <b>NOTE:</b> Provisioning of the Certificate is required to connect to HTTPs Boot server. |



**Table 36. System setup options—Power menu**

|                           |  |
|---------------------------|--|
| <b>Power</b>              |  |
| <b>Thermal Management</b> | Enables or disables cooling of fan and manages processor heat to adjust the computer performance, noise, and temperature.<br>By default, the <b>Optimized</b> option is selected. Standard setting for balanced performance, noise, and temperature. |
| <b>USB Wake Support</b>   |  |
| Enable USB Wake Support   | Enables or disables the computer to wake from Standby, Hibernation, or Power Off mode using USB devices like a mouse or keyboard.<br>By default, the <b>Enable USB Wake Support</b> option is enabled.   |
| <b>AC Behavior</b>        |  |
| AC Recovery               | Allows the user to select computer's behavior when AC power is restored after an unexpected loss of AC power.<br>By default, the <b>Power Off</b> option is selected.  |
| <b>Block Sleep</b>        | Enables or disables the computer from entering Sleep (S3) mode in the operating system.<br>By default, the <b>Block Sleep</b> option is disabled.  |



**Table 36. System setup options—Power menu (continued)**

| Power                        |  |
|------------------------------|--|
|                              | <p> <b>NOTE:</b> When enabled, the computer does not go to Sleep, Intel Rapid Start is disabled automatically, and the operating system power option is blank if it was set to Sleep.</p> |
| Deep Sleep Control           |  |
| Deep Sleep Control           | <p>Enables or disables the computer to select the extent of power conserving while in Shutdown (S5) or Hibernate (S4) mode.</p> <p>By default, the <b>Enabled in S4 and S5</b> option is selected.</p>   |
| Fan Control Override         |  |
| Fan Control Override         | <p>Enables or disables the fan to run at full speed.</p> <p>By default, the <b>Fan Control Override</b> option is disabled.</p>  |
| Intel Speed Shift Technology |  |
|                              | <p>Enables or disables the Intel Speed Shift Technology support. When enabled, the operating system selects the appropriate processor performance automatically.</p> <p>By default, the <b>Intel Speed Shift Technology</b> option is enabled.</p>                         |

**Table 37. System setup options—Security menu**

| Security                      |  |
|-------------------------------|--|
| Trusted Platform Module (TPM) |  |
|                               | <p>The Trusted Platform Module (TPM) provides various cryptographic services which serve as the cornerstone for many platform security technologies. Trusted Platform Module (TPM) is a security device that stores computer-generated keys for encryption and features such as BitLocker, Virtual Secure Mode, remote Attestation.</p> <p>By default, the <b>Trusted Platform Module (TPM)</b> option is enabled.</p> <p>For additional security, Dell Technologies recommends keeping <b>Trusted Platform Module (TPM)</b> enabled to allow these security technologies to fully function.</p> <p> <b>NOTE:</b> The options that are listed apply to computers with a discrete <b>Trusted Platform Module (TPM)</b> chip.</p> |
| TPM 2.0 Security On           | <p>Allows you to enable or disable TPM.</p> <p>By default, the <b>TPM 2.0 Security On</b> option is enabled.</p> <p>For additional security, Dell Technologies recommends keeping <b>TPM 2.0 Security On</b> enabled to allow these security technologies to fully function.</p>   |
| Attestation Enable            | <p>The <b>Attestation Enable</b> option controls the endorsement hierarchy of TPM. Disabling the <b>Attestation Enable</b> option prevents TPM from being used to digitally sign certificates.</p> <p>By default, the <b>Attestation Enable</b> option is enabled.</p> <p>For additional security, Dell Technologies recommends keeping the <b>Attestation Enable</b> option enabled.</p> <p> <b>NOTE:</b> When disabled, this feature may cause compatibility issues or loss of functionality in some operating systems.</p>   |
| Key Storage Enable            | <p>The <b>Key Storage Enable</b> option controls the storage hierarchy of TPM, which is used to store digital keys. Disabling the <b>Key Storage Enable</b> option restricts the ability of TPM to store owner's data.</p> <p>By default, the <b>Key Storage Enable</b> option is enabled.</p> <p>For additional security, Dell Technologies recommends keeping the <b>Key Storage Enable</b> option enabled.</p>  |

**Table 37. System setup options—Security menu (continued)**

| <b>Security</b>   |   |
|---|---|
|   | <p> <b>NOTE:</b> When disabled, this feature may cause compatibility issues or loss of functionality in some operating systems.</p>  |
| SHA-256   | <p>Allows you to control the hashing algorithm that is used by the TPM. When enabled, the TPM uses the SHA-256 hashing algorithm. When disabled, the TPM uses the SHA-1 hash algorithm.</p> <p>By default, the <b>SHA-256</b> option is enabled.</p> <p>For additional security, Dell Technologies recommends keeping the <b>SHA-256</b> option enabled.</p>  |
| Clear   | <p>When enabled, the <b>Clear</b> option clears information that is stored in the TPM after exiting the computer's BIOS. This option returns to the disabled state when the computer restarts.</p> <p>By default, the <b>Clear</b> option is disabled.</p> <p>Dell Technologies recommends enabling the <b>Clear</b> option only when TPM data is required to be cleared.</p>   |
| Physical Presence Interface (PPI) Bypass for Clear Commands | <p>By default, the <b>PPI Bypass for Clear Commands</b> option is disabled.</p> <p>For additional security, Dell Technologies recommends keeping the <b>PPI Bypass for Clear Commands</b> option disabled.</p>  |
| <b>SMM Security Mitigation</b>                              | <p>Enables or disables additional UEFI SMM Security Mitigation protections. This option uses the Windows SMM Security Mitigations Table (WSMT) to confirm to the operating system that security best practices have been implemented by the UEFI firmware.</p> <p>By default, the <b>SMM Security Mitigation</b> option is enabled.</p> <p>For additional security, Dell Technologies recommends keeping the <b>SMM Security Mitigation</b> option enabled unless you have a specific application which is not compatible.</p> <p> <b>NOTE:</b> This feature may cause compatibility issues or loss of functionality with some legacy tools and applications.</p>  |
| <b>Data Wipe on Next Boot</b>                               |   |
| Start Data Wipe   | <p>Data Wipe is a secure wipe operation that deletes information from a storage device.</p> <p> <b>CAUTION: The secure Data Wipe operation deletes information in a way that it cannot be reconstructed.</b></p> <p>Commands such as delete and format in the operating system may remove files from showing up in the file system. However, they can be reconstructed through forensic means as they are still represented on the physical media. Data Wipe prevents this reconstruction and is not recoverable.</p> <p>When enabled, the data wipe option will prompt to wipe any storage devices that are connected to the computer on the next boot.</p> <p>By default, the <b>Start Data Wipe</b> option is disabled.</p> |
| <b>Absolute</b>   |   |
| Absolute  | <p>Absolute Software provides various cyber security solutions, some requiring software preloaded on Dell computers and integrated into the BIOS. To use these features, you must enable the Absolute BIOS setting and contact Absolute for configuration and activation.</p> <p>By default, the <b>Absolute</b> option is enabled.</p> <p>For additional security, Dell Technologies recommends keeping the <b>Absolute</b> option enabled.</p>  |



**Table 37. System setup options—Security menu (continued)**

|   |   |
|---|---|
| <b>Security</b>   |   |
| <p> <b>NOTE:</b> When the Absolute features are activated, the Absolute integration cannot be disabled from the BIOS setup screen.</p> |   |
| <b>UEFI Boot Path Security</b>  |   |
| UEFI Boot Path Security   | <p>Enables or disables the computer to prompt the user to enter the Administrator password (if set) when booting to a UEFI boot path device from the F12 boot menu.</p> <p>By default, the <b>Always Except Internal HDD</b> option is enabled.</p> |

**Table 38. System setup options—Passwords menu**

|                               |   |
|-------------------------------|---|
| <b>Passwords</b>              |   |
| <b>Administrator Password</b> | <p>The Administrator Password prevents unauthorized access to the BIOS Setup options. Once the administrator password is set, the BIOS setup options can only be modified after providing the correct password.</p> <p>The following rules and dependencies apply to the Administrator Password -</p> <ul style="list-style-type: none"> <li>• The administrator password cannot be set if computer and/or internal hard drive passwords are previously set.</li> <li>• The administrator password can be used in place of the computer and/or internal hard drive passwords.</li> <li>• When set, the administrator password must be provided during a firmware update.</li> <li>• Clearing the administrator password also clears the computer password (if set).</li> </ul> <p>Dell Technologies recommends using an administrator password to prevent unauthorized changes to BIOS setup options.</p> |
| <b>System Password</b>        | <p>The System Password prevents the computer from booting to an operating system without entering the correct password.</p> <p>The following rules and dependencies apply when the System Password is used -</p> <ul style="list-style-type: none"> <li>• The computer shuts down when idle for approximately 10 minutes at the computer password prompt.</li> <li>• The computer shuts down after three incorrect attempts to enter the computer password.</li> <li>• The computer shuts down when the <b>Esc</b> key is pressed at the System Password prompt.</li> <li>• The computer password is not prompted when the computer resumes from standby mode.</li> </ul> <p>Dell Technologies recommends using the computer password in situations where it is likely that a computer may be lost or stolen.</p>   |
| <b>M.2 PCIe SSD-0</b>         | Enables the user to set, change, or delete the M.2 PCIe SSD-0 password.   |
| <b>Password Configuration</b> | <p>The Password configuration page includes several options for changing the requirements of BIOS passwords. You can modify the minimum and maximum length of the passwords and require passwords to contain certain character classes (upper case, lower case, digit, special character).</p> <p>Dell Technologies recommends setting the minimum password length to at least eight characters.</p>  |
| <b>Password Bypass</b>        | <p>The <b>Password Bypass</b> option allows the computer to reboot from the operating system without entering the computer or hard drive password. If the computer has already booted to the operating system, it is presumed that the user has already entered the correct computer or hard drive password.</p>  |

**Table 38. System setup options—Passwords menu (continued)**

| <b>Passwords</b>                   |  |
|------------------------------------|--|
|                                    | <p> <b>NOTE:</b> This option does not remove the requirement to enter the password after shutting down.</p> <p>By default, the <b>Password Bypass</b> option is disabled.</p> <p>For additional security, Dell Technologies recommends keeping the <b>Password Bypass</b> option enabled.</p>   |
| <b>Password Changes</b>            |  |
| Allow Non-Admin Password Changes   | <p>The <b>Allow Non-Admin Password Changes</b> option in BIOS setup allows an end user to set or change the computer or hard drive passwords without entering the administrator password. This gives an administrator control over the BIOS settings but enables an end user to provide their own password.</p> <p>By default, the <b>Allow Non-Admin Password Changes</b> option is disabled.</p> <p>For additional security, Dell Technologies recommends keeping the <b>Allow Non-Admin Password Changes</b> option disabled.</p>   |
| <b>Admin Setup Lockout</b>         |  |
|                                    | <p>The <b>Admin Setup Lockout</b> option prevents an end user from even viewing the BIOS setup configuration without first entering the administrator password (if set).</p> <p>By default, the <b>Admin Setup Lockout</b> option is disabled.</p> <p>For additional security, Dell Technologies recommends keeping the <b>Admin Setup Lockout</b> option disabled.</p>  |
| <b>Master Password Lockout</b>     |  |
| Enable Master Password Lockout     | <p>The Master Password Lockout setting allows you to disable the Recovery Password feature. If the computer, administrator, or hard drive password is forgotten, the computer becomes unusable.</p> <p> <b>NOTE:</b> When the owner password is set, the Master Password Lockout option is not available.</p> <p> <b>NOTE:</b> When an internal hard drive password is set, it must first be cleared before Master Password Lockout can be changed.</p> <p>By default, the <b>Enable Master Password Lockout</b> option is disabled.</p> <p>Dell does not recommend enabling the <b>Master Password Lockout</b> unless you have implemented your own password recovery computer.</p> |
| <b>Allow Non-Admin PSID Revert</b> |  |
| Enable Allow Non-Admin PSID Revert | <p>Controls access to the Physical Security ID (PSID) revert of NVMe hard drives from the Dell Security Manager prompt.</p> <p>By default, the <b>Enable Allow Non-Admin PSID Revert</b> option is disabled.</p>   |

**Table 39. System setup options—Update, Recovery menu**

| <b>Update, Recovery</b>              |  |
|--------------------------------------|--|
| <b>UEFI Capsule Firmware Updates</b> |  |
| Enable UEFI Capsule Firmware Updates | <p>Enables or disables BIOS updates through UEFI capsule update packages.</p> <p> <b>NOTE:</b> Disabling this option blocks the BIOS updates from services such as Microsoft Windows Update and Linux Vendor Firmware Service (LVFS).</p> <p>By default, the <b>Enable UEFI Capsule Firmware Updates</b> option is enabled.</p> |
| <b>BIOS Recovery from Hard Drive</b> |  |
|                                      | <p>Enables or disables the user to recover from certain corrupted BIOS conditions from a recovery file on the user primary hard drive or an external USB key.</p> <p>By default, the <b>BIOS Recovery from Hard Drive</b> option is enabled.</p>   |



**Table 39. System setup options—Update, Recovery menu (continued)**

| <b>Update, Recovery</b>                |  |
|--|--|
|  | <p><b>i</b> <b>NOTE:</b> BIOS Recovery from Hard Drive is not available for self-encrypting drives (SED).</p> <p><b>i</b> <b>NOTE:</b> BIOS recovery is designed to fix the main BIOS block and cannot work if the Boot Block is damaged. In addition, this feature cannot work in the event of EC corruption, ME corruption, or a hardware issue. The recovery image must exist on an unencrypted partition on the drive.</p> |
| <b>BIOS Downgrade</b>                  |  |
| Allow BIOS Downgrade                   | <p>Controls flashing of the computer firmware to previous revisions.</p> <p>By default, the <b>Allow BIOS Downgrade</b> option is enabled.</p>   |
| <b>SupportAssist OS Recovery</b>       |  |
|  | <p>Enables or disables the boot flow for SupportAssist OS Recovery tool in the event of certain computer errors.</p> <p>By default, the <b>SupportAssist OS Recovery</b> option is enabled.</p>  |
| <b>BIOSConnect</b>                     |  |
|  | <p>Enables or disables cloud Service operating system recovery if the main operating system fails to boot with the number of failures equal to or greater than the value specified by the Auto operating system Recovery Threshold setup option and local Service operating system does not boot or is not installed.</p> <p>By default, the <b>BIOSConnect</b> option is enabled.</p>   |
| <b>Dell Auto OS Recovery Threshold</b> |  |
|  | <p>Allows you to control the automatic boot flow for SupportAssist System Resolution Console and for Dell operating system Recovery Tool.</p> <p>By default, the <b>Dell Auto OS Recovery Threshold</b> value is set to 2.</p>   |

**Table 40. System setup options—System Management menu**

| <b>System Management</b>    |   |
|-----------------------------|---|
| <b>Service Tag</b>          | Displays the Service Tag of the computer.   |
| <b>Asset Tag</b>            | <p>Creates a computer Asset Tag that can be used by an IT administrator to uniquely identify a particular computer.</p> <p><b>i</b> <b>NOTE:</b> Once set in BIOS, the Asset Tag cannot be changed.</p>   |
| <b>Wake on LAN</b>          | <p>Enables or disables the computer to turn on by a special LAN signal.</p> <p>By default, the <b>Wake on LAN</b> option is disabled.</p>   |
| <b>Auto On Time</b>         | <p>Enable to set the computer to turn on automatically every day or on a preselected date and time. This option can be configured only if the Auto On Time is set to Everyday, Weekdays, or Selected Days.</p> <p>By default, the <b>Auto On Time</b> option is disabled.</p> |
| <b>Intel AMT Capability</b> |   |
| Enable Intel AMT Capability | <p>Enables or disables the MEBx in pre-boot menu.</p> <p>By default, the <b>Restrict Boot Access</b> option is selected.</p>  |
| <b>Enable SERR Messages</b> | <p>Enables or disables SERR messages.</p> <p>By default, the <b>Enable SERR Messages</b> option is enabled.</p>   |
| <b>First Power On Date</b>  |   |
| Set Ownership Date          | <p>Allows the user to set the Ownership date..</p> <p>By default, the <b>Set Ownership Date</b> option is disabled.</p>   |

**Table 40. System setup options—System Management menu (continued)**

|  |  |
|--|--|
| <b>System Management</b>                     |  |
| <b>Diagnostics</b>                           |  |
| OS Agent Requests                            | Enables the user to configure the Ownership date.<br>By default, the <b>OS Agent Requests</b> option is enabled.   |
| <b>Power-on Self-Test Attomatic Recovery</b> |  |
| Power-on Self-Test Automatic Recovery        | Enables or disables the computer to respond before completing the BIOS Power-on Self-Test (POST).<br>By default, the <b>Power-on Self-Test Automatic Recovery</b> option is enabled. |

**Table 41. System setup options—Keyboard menu**

|   |   |
|---|---|
| <b>Keyboard</b>                           |   |
| <b>Keyboard Errors</b>                    |   |
| Enable Keyboard Error Detection           | Enables or disables the keyboard error detection.<br>By default, the <b>Enable Keyboard Error Detection</b> option is enabled.  |
| <b>Numlock LED</b>                        |   |
| Enable Numlock LED                        | Enables or disables Numlock LED.<br>By default, the <b>Enable Numlock LED</b> option is enabled.  |
| <b>Device Configuration HotKey Access</b> | Allows you to control whether you can access device configuration screens through hotkeys during computer startup.<br>By default, the <b>Device Configuration HotKey Access</b> option is enabled.<br><b>i NOTE:</b> This setting controls only the Intel RAID (CTRL+I), MEBX (CTRL+P), and LSI RAID (CTRL+C) Option ROMs. Other preboot Option ROMs, which support entry using a key sequence, are not affected by this setting. |

**Table 42. System setup options—Preboot Behavior menu**

|                            |   |
|----------------------------|---|
| <b>Preboot Behavior</b>    |   |
| <b>Warnings and Errors</b> | Enables or disables the action to be taken when a warning or error is encountered.<br>By default, the <b>Prompt on Warnings and Errors</b> option is selected. Stop, prompt, and wait for user input when warnings or errors are detected.<br><b>i NOTE:</b> Errors deemed critical to the operation of the computer hardware stop the functioning of the computer. |
| Extend BIOS POST Time      | Sets the BIOS POST (Power-On Self-Test) load time.<br>By default, the <b>0 seconds</b> option is selected.  |

**Table 43. System setup options—Virtualization menu**

|   |  |
|---|--|
| <b>Virtualization Support</b>               |  |
| <b>Intel Virtualization Technology</b>      |  |
| Enable Intel Virtualization Technology (VT) | When enabled, the computer can run a Virtual Machine Monitor (VMM).<br>By default, the <b>Enable Intel Virtualization Technology (VT)</b> option is enabled. |
| <b>VT for Direct I/O</b>                    |  |

**Table 43. System setup options—Virtualization menu (continued)**

| <b>Virtualization Support</b>  |  |
|--------------------------------|--|
| Enable Intel VT for Direct I/O | <p>When enabled, the computer can perform Virtualization Technology for Direct I/O (VT-d). VT-d is an Intel method that provides virtualization for memory map I/O.</p> <p>By default, the <b>Enable Intel VT for Direct I/O</b> option is enabled.</p>  |
| <b>DMA Protection</b>          |  |
| Enable Pre-Boot DMA Support    | <p>Allows you to control the Pre-Boot DMA protection for both internal and external ports. This option does not directly enable DMA protection in the operating system.</p> <p><b>i</b> <b>NOTE:</b> This option is not available when the virtualization setting for IOMMU is disabled (VT-d/AMD Vi).</p> <p>By default, the <b>Enable Pre-Boot DMA Support</b> option is enabled.</p> <p>For additional security, Dell Technologies recommends keeping the <b>Enable Pre-Boot DMA Support</b> option enabled.</p> <p><b>i</b> <b>NOTE:</b> This option is provided only for compatibility purposes, since some older hardware is not DMA capable.</p>          |
| Enable OS Kernel DMA Support   | <p>Allows you to control the Kernel DMA protection for both internal and external ports. This option does not directly enable DMA protection in the operating system. For operating systems that support DMA protection, this setting indicates to the operating system that the BIOS supports the feature.</p> <p><b>i</b> <b>NOTE:</b> This option is not available when the virtualization setting for IOMMU is disabled (VT-d/AMD Vi).</p> <p>By default, the <b>Enable OS Kernel DMA Support</b> option is enabled.</p> <p><b>i</b> <b>NOTE:</b> This option is provided only for compatibility purposes, since some older hardware is not DMA capable.</p> |

**Table 44. System setup options—Performance menu**

| <b>Performance</b>                      |  |
|---|--|
| <b>Multi-Core Support</b>               |  |
| Multiple Atom Cores                     | <p>Enables to change the number of Atom cores available to the operating system. The default value is set to the maximum number of cores.</p> <p>By default, the <b>All Cores</b> option is selected.</p>  |
| <b>Intel SpeedStep</b>                  |  |
| Enable Intel SpeedStep Technology       | <p>Enables the computer to dynamically adjust processor voltage and core frequency, decreasing average power consumption and heat production.</p> <p>By default, the <b>Enable Intel SpeedStep Technology</b> option is enabled.</p>   |
| <b>C-States Control</b>                 |  |
| Enable C-State Control                  | <p>Enables or disables the ability of the CPU to enter and exit low-power state. When disabled, it disables all C-states. When enabled, it enables all C-states that the chipset or platform allows.</p> <p>By default, the <b>Enable C-State Control</b> option is enabled.</p> |
| <b>Intel Turbo Boost Technology</b>     |  |
| Enable Intel Turbo Boost Technology     | <p>Enables the Intel TurboBoost mode of the processor. When enabled, the Intel TurboBoost driver increases the performance of the CPU or graphics processor.</p> <p>By default, the <b>Enable Intel Turbo Boost Technology</b> option is enabled.</p>                            |
| <b>Intel Hyper-Threading Technology</b> |  |

**Table 44. System setup options—Performance menu (continued)**

| <b>Performance</b>                                |  |
|---|--|
| Enable Intel Hyper-Threading Technology           | Enables the Intel Hyper-Threading mode of the processor. When enabled, the Intel Hyper-Threading increases the efficiency of the processor resources when multiple threads run on each core.<br><br>By default, the <b>Intel Hyper-Threading Technology</b> option is enabled. |
| <b>PCIe Resizable Base Address Register (BAR)</b> |  |
| PCIe Resizable Base Address Register (BAR)        | Enables or disables the support for PCIe Resizable BAR.<br><br>By default, the <b>PCIe Resizable Base Address Register (BAR)</b> option is enabled.  |

**Table 45. System setup options—System Logs menu**

| <b>System Logs</b>     |  |
|------------------------|--|
| <b>BIOS Event Log</b>  |  |
| Clear BIOS Event Log   | Allows you to select option to keep or clear BIOS events logs.<br><br>By default, the <b>Keep Log</b> option is selected.  |
| <b>Power Event Log</b> |  |
| Clear Power Event Log  | Allows you to select option to keep or clear Power events logs.<br><br>By default, the <b>Keep Log</b> option is selected. |

## Updating the BIOS

### Updating the BIOS in Windows

#### About this task

 **CAUTION:** If BitLocker is not suspended before updating the BIOS, the next time you reboot the computer it will not recognize the BitLocker key. You will then be prompted to enter the recovery key to progress, and the computer will ask for this on each reboot. If the recovery key is not known this can result in data loss or an unnecessary operating system reinstall. For more information about this subject, search in the Knowledge Base Resource at [Dell Support Site](#).

#### Steps

1. Go to [Dell Support Site](#).
2. Click **Product support**. In the **Search support** box, enter the Service Tag of your computer, and then click **Search**.  
 **NOTE:** If you do not have the Service Tag, use the SupportAssist to automatically identify your computer. You can also use the product ID or manually browse for your computer model.
3. Click **Drivers & Downloads**. Expand **Find drivers**.
4. Select the operating system installed on your computer.
5. In the **Category** drop-down list, select **BIOS**.
6. Select the latest version of BIOS, and click **Download** to download the BIOS file for your computer.
7. After the download is complete, browse the folder where you saved the BIOS update file.
8. Double-click the BIOS update file icon and follow the on-screen instructions.  
For more information, search in the Knowledge Base Resource at [Dell Support Site](#).

# Updating the BIOS in Linux and Ubuntu

To update the system BIOS on a computer that is installed with Linux or Ubuntu, see the knowledge base article [000131486](#) at [Dell Support Site](#).

## Updating the BIOS using the USB drive in Windows

### About this task

 **CAUTION:** If BitLocker is not suspended before updating the BIOS, the next time you reboot the computer it will not recognize the BitLocker key. You will then be prompted to enter the recovery key to progress, and the computer will ask for this on each reboot. If the recovery key is not known this can result in data loss or an unnecessary operating system reinstall. For more information about this subject, search in the Knowledge Base Resource at [Dell Support Site](#).

### Steps

1. Follow the procedure from step 1 to step 6 in [Updating the BIOS in Windows](#) to download the latest BIOS setup program file.
2. Create a bootable USB drive. For more information, search in the Knowledge Base Resource at [Dell Support Site](#).
3. Copy the BIOS setup program file to the bootable USB drive.
4. Connect the bootable USB drive to the computer that needs the BIOS update.
5. Restart the computer and press **F12**.
6. Select the USB drive from the **One Time Boot Menu**.
7. Type the BIOS setup program filename and press **Enter**.  
The **BIOS Update Utility** appears.
8. Follow the on-screen instructions to complete the BIOS update.

## Updating the BIOS from the One-Time boot menu

Update your computer BIOS using the BIOS XXXX.exe file that is copied to a FAT32 USB drive and booting from the One-Time boot menu.

### About this task

 **CAUTION:** If BitLocker is not suspended before updating the BIOS, the next time you reboot the computer it will not recognize the BitLocker key. You will then be prompted to enter the recovery key to progress, and the computer will ask for this on each reboot. If the recovery key is not known this can result in data loss or an unnecessary operating system reinstall. For more information about this subject, search in the Knowledge Base Resource at [Dell Support Site](#).

### BIOS Update

You can run the BIOS flash update file from Windows using a bootable USB drive or you can also update the BIOS from the One-Time boot menu on the computer.

You can confirm by booting your computer to the **One Time Boot** Menu to see if BIOS FLASH UPDATE is listed as a boot option. If the option is listed, then the BIOS can be updated using this method..

### Updating from the One-Time boot menu

To update your BIOS from the One-Time boot menu, you need the following:

- USB drive formatted to the FAT32 file system (the drive does not have to be bootable)
- BIOS executable file that you downloaded from the Dell Support website and copied to the root of the USB drive
- AC power adapter must be connected to the computer
- Functional computer battery to flash the BIOS

Perform the following steps to perform the BIOS flash update process from the One-Time boot menu:

 **CAUTION:** Do not turn off the computer during the BIOS flash update process. The computer may not boot if you turn off your computer.

### Steps

1. Turn off your computer, insert the USB drive where you copied the BIOS flash update file into a USB port of the computer.
2. Turn on the computer and press to access the **One Time Boot** Menu. Select BIOS Update using the mouse or arrow keys then press Enter.  
The flash BIOS menu is displayed.
3. Click **Flash from file**.
4. Select the external USB device.
5. Select the file and double-click the flash target file, and then click **Submit**.
6. Click **Update BIOS**. The computer restarts to flash the BIOS.
7. The computer will restart after the BIOS flash update is completed.

## System and setup password

Table 46. System and setup password

| Password type   | Description  |
|-----------------|--|
| System password | Password that you must enter to log in to your system.   |
| Setup password  | Password that you must enter to access and make changes to the BIOS settings of your computer. |

You can create a system password and a setup password to secure your computer.

 **CAUTION:** The password features provide a basic level of security for the data on your computer.

 **CAUTION:** Anyone can access the data that is stored on your computer, when left unattended.

 **NOTE:** System and setup password feature is disabled.

## Assigning a System Setup password

### Prerequisites

You can assign a new System or Admin Password only when the status is in **Not Set**.

### About this task

To enter BIOS System Setup, press F2 immediately after a power-on or reboot.

### Steps

1. In the **System BIOS** or **System Setup** screen, select **Security** and press Enter.  
The **Security** screen is displayed.
2. Select **System/Admin Password** and create a password in the **Enter the new password** field.  
Use the following guidelines to assign the system password:
  - A password can have up to 32 characters.
  - At least one special character: "( ! " # \$ % & ' \* + , - . / : ; < = > ? @ [ \ ] ^ \_ ` { | } )"
  - Numbers 0 to 9.
  - Upper case letters from A to Z.
  - Lower case letters from a to z.
3. **Confirm new password** type the system password that you entered earlier in the field and click **OK**.
4. Press Esc and save the changes as prompted by the message.
5. Press Y to save the changes.  
The computer restarts.

# Deleting or changing an existing system password or setup password

## Prerequisites

Ensure that the **Password Status** is Unlocked (in the System Setup) before attempting to delete or change the existing system password and/or setup password. You cannot delete or change an existing system password or setup password if the **Password Status** is Locked.

## About this task

To enter the System Setup, press F2 immediately after a power-on or reboot.

## Steps

1. In the **System BIOS** or **System Setup** screen, select **System Security** and press Enter.  
The **System Security** screen is displayed.
2. In the **System Security** screen, verify that the **Password Status** is Unlocked.
3. Select **System Password**. Update or delete the existing system password, and press Enter or Tab.
4. Select **Setup Password**. Update or delete the existing setup password, and press Enter or Tab.  
 **NOTE:** If you change the system password and/or setup password, reenter the new password when prompted. If you delete the system password and/or setup password, confirm the deletion when prompted.
5. Press Esc. A message prompts you to save the changes.
6. Press Y to save the changes and exit from **System Setup**.  
The computer restarts.

# Clearing CMOS settings

## About this task

 **CAUTION:** Clearing CMOS settings will reset the BIOS settings on your computer.

## Steps

1. Remove the [side cover](#).
2. Remove the [coin-cell battery](#).
3. Wait for one minute.
4. Replace the [coin-cell battery](#).
5. Replace the [side cover](#).

# Clearing BIOS (System Setup) and System passwords

## About this task

To clear the computer or BIOS passwords, contact Dell technical support as described at [Contact Support](#). For more information, go to [Dell Support Site](#).

 **NOTE:** For information about how to reset Windows or application passwords, see the documentation accompanying Windows or your application.

# Troubleshooting

## Dell SupportAssist Pre-boot System Performance Check diagnostics

### About this task

SupportAssist diagnostics (also known as system diagnostics) performs a complete check of your hardware. The Dell SupportAssist Pre-boot System Performance Check diagnostics is embedded with the BIOS and launched by the BIOS internally. The embedded system diagnostics provides options for particular devices or device groups allowing you to:

- Run tests automatically or in an interactive mode.
- Repeat the tests.
- Display or save test results.
- Run thorough tests to introduce additional test options to provide extra information about one or more failed devices.
- View status messages that inform you the tests are completed successfully.
- View error messages that inform you of problems encountered during testing.

 **NOTE:** Some tests for specific devices require user interaction. Always ensure that you are present at the computer when the diagnostic tests are performed.

For more information, see the knowledge base article [000180971](#).

## Running the SupportAssist Pre-Boot System Performance Check

### Steps

1. Turn on your computer.
2. As the computer boots, press the F12 key as the Dell logo appears.
3. On the boot menu screen, select the **Diagnostics** option.
4. Click the arrow at the bottom left corner.  
Diagnostics page is displayed.
5. Click the arrow in the lower-right corner to go to the page listing.  
The items that are detected are listed.
6. To run a diagnostic test on a specific device, press Esc and click **Yes** to stop the diagnostic test.
7. Select the device from the left pane and click **Run Tests**.
8. If there are any issues, error codes are displayed.  
Note the error code and validation number and contact Dell.

## Power-Supply Unit Built-in Self-Test

Built-in Self-Test (BIST) helps determine if the power-supply unit is working. To run self-test diagnostics on the power-supply unit of a desktop or all-in-one computer, search in the Knowledge Base Resource at [Dell Support Site](#).



# System-diagnostic lights

Table 47. Diagnostic LED behavior

| Blinking pattern |       | Problem description                                   |
|------------------|-------|---|
| Amber            | White |   |
| 1                | 1     | TPM Detection Failure                                 |
| 1                | 2     | Unrecoverable SPI Flash Failure                       |
| 1                | 5     | EC unable to program i-Fuse                           |
| 1                | 6     | Generic catch-all for ungraceful EC code flow errors  |
| 1                | 7     | Non-RPMC Flash on Boot Guard fused system             |
| 2                | 1     | CPU failure   |
| 2                | 2     | System board, BIOS corruption, or ROM error           |
| 2                | 3     | No Memory/RAM detected                                |
| 2                | 4     | Memory/RAM failure                                    |
| 2                | 5     | Invalid memory installed                              |
| 2                | 6     | System board/ chipset error                           |
| 2                | 7     | LCD failure - SBIOS message                           |
| 2                | 8     | System board - EC detection of LCD power rail failure |
| 3                | 1     | CMOS battery failure                                  |
| 3                | 2     | PCI of Video card or chip failure                     |
| 3                | 3     | BIOS Recovery image not found                         |
| 3                | 4     | BIOS Recovery image found but not valid               |
| 3                | 5     | EC ran into power sequencing failure                  |
| 3                | 6     | Flash corruption detected by SBIOS                    |
| 3                | 7     | Timeout waiting on ME to reply to HECI message        |
| 4                | 1     | Memory DIMM power rail failure                        |
| 4                | 2     | CPU Power Cable Connection Issue                      |

## Recovering the operating system

When your computer is unable to boot to the operating system even after repeated attempts, it automatically starts Dell SupportAssist OS Recovery.

Dell SupportAssist OS Recovery is a stand-alone tool that is preinstalled in Dell computers running Windows operating system. It consists of tools to diagnose and troubleshoot issues that may occur before your computer boots to the operating system. It enables you to diagnose hardware issues, repair your computer, back up your files, or restore your computer to its factory state.

You can also download it from the Dell Support website to troubleshoot and fix your computer when it fails to boot into the primary operating system due to software or hardware failures.

For more information about the Dell SupportAssist OS Recovery, see *Dell SupportAssist OS Recovery User's Guide* at [Serviceability Tools at the Dell Support Site](#). Click **SupportAssist** and then, click **SupportAssist OS Recovery**.

## Real Time Clock—RTC reset

The Real Time Clock (RTC) reset function allows you or the service technician to recover the recently launched model Dell Latitude and Precision systems from **No POST/No Boot/No Power** situations. You can initiate the RTC reset on the system from a power-off state only if it is connected to AC power. Press and hold the power button for 25 seconds. The system RTC reset occurs after you release the power button.

**NOTE:** If AC power is disconnected from the system during the process or the power button is held longer than 40 seconds, the RTC reset process gets aborted.

The RTC reset will reset the BIOS to Defaults, un-provision Intel vPro and reset the system date and time. The following items are unaffected by the RTC reset:

- Service Tag
- Asset Tag
- Ownership Tag
- Admin Password
- System Password
- HDD Password
- Key Databases
- System Logs

**NOTE:** The IT administrator's vPro account and password on the system will be un-provisioned. The system needs to go through the setup and configuration process again to reconnect it to the vPro server.

The below items may or may not reset based on your custom BIOS setting selections:

- Boot List
- Enable Legacy Option ROMs
- Secure Boot Enable
- Allow BIOS Downgrade

## Backup media and recovery options

It is recommended to create a recovery drive to troubleshoot and fix problems that may occur with Windows. Dell provides multiple options for recovering the Windows operating system on your Dell computer. For more information, see [Dell Windows Backup Media and Recovery Options](#).

## Wi-Fi power cycle

### About this task

If your computer is unable to access the Internet due to Wi-Fi connectivity issues, reset your Wi-Fi device by performing the following steps:

### Steps

1. Turn off the computer.
2. Turn off the modem.

**NOTE:** Some Internet service providers (ISPs) provide a modem and router combo device.

3. Turn off the wireless router.
4. Wait for 30 seconds.
5. Turn on the wireless router.
6. Turn on the modem.
7. Turn on the computer.

# Getting help and contacting Dell

## Self-help resources

You can get information and help on Dell products and services using these self-help resources:

**Table 48. Self-help resources**

| Self-help resources  | Resource location   |
|--|---|
| Information about Dell products and services   | <a href="#">Dell Site</a>   |
| Tips   |    |
| Contact Support  | In Windows search, type <code>Contact Support</code> , and press Enter.   |
| Online help for operating system   | <a href="#">Windows Support Site</a><br><a href="#">Linux Support Site</a>  |
| Access top solutions, diagnostics, drivers and downloads, and learn more about your computer through videos, manuals, and documents. | Your Dell computer is uniquely identified using a Service Tag or Express Service Code. To view relevant support resources for your Dell computer, enter the Service Tag or Express Service Code at <a href="#">Dell Support Site</a> .<br><br>For more information about how to find the Service Tag for your computer, see <a href="#">Locate the Service Tag on your computer</a> . |
| Dell knowledge base articles   | <ol style="list-style-type: none"> <li>1. Go to <a href="#">Dell Support Site</a>.</li> <li>2. On the menu bar at the top of the Support page, select <b>Support &gt; Support Library</b>.</li> <li>3. In the Search field on the Support Library page, type the keyword, topic, or model number, and then click or tap the search icon to view the related articles.</li> </ol>      |

## Contacting Dell

To contact Dell for sales, technical support, or customer service issues, see [Dell Support Site](#).

 **NOTE:** Availability of the services may vary depending on the country or region, and product.

 **NOTE:** If you do not have an active Internet connection, you can find contact information about your purchase invoice, packing slip, bill, or Dell product catalog.