

Inspiron 27 7730 All-in-One

Owner's Manual

Notes, cautions, and warnings

 **NOTE:** A NOTE indicates important information that helps you make better use of your product.

 **CAUTION:** A CAUTION indicates either potential damage to hardware or loss of data and tells you how to avoid the problem.

 **WARNING:** A WARNING indicates a potential for property damage, personal injury, or death.

Chapter 1: Views of Inspiron 27 7730 All-in-One	7
Right.....	7
Front.....	8
Back.....	9
Back panel.....	10
Bottom.....	11
Service Tag.....	12
Tilt.....	12
Retractable camera.....	13
Inside view of your computer.....	15
Chapter 2: Set up your Inspiron 27 7730 All-in-One	16
Chapter 3: Specifications of Inspiron 27 7730 All-in-One	22
Dimensions and weight.....	22
Stand.....	22
Processor.....	24
Chipset.....	25
Operating system.....	26
Memory.....	26
External ports and slots.....	26
Internal slots.....	27
Ethernet.....	27
Wireless module.....	27
Audio.....	28
Storage.....	28
Media-card reader.....	28
Camera.....	29
Power adapter.....	29
Display.....	30
GPU—Integrated.....	31
GPU—Discrete.....	31
Environmental.....	31
Regulatory compliance.....	32
Operating and storage environment.....	32
Dell support policy.....	33
Chapter 4: Working inside your computer	34
Safety instructions.....	34
Before working inside your computer.....	34
Safety precautions.....	35
Electrostatic discharge—ESD protection.....	35
ESD Field Service kit	36
Transporting sensitive components.....	37

After working inside your computer.....	37
BitLocker.....	37
Recommended tools.....	37
Screw list.....	38
Major components of Inspiron 27 7730 All-in-One.....	39
Chapter 5: Removing and installing Customer Replaceable Units (CRUs).....	42
Stand.....	42
Removing the stand.....	42
Installing the stand.....	43
Back cover.....	44
Removing the back cover.....	44
Installing the back cover.....	45
I/O cover.....	46
Removing the I/O cover.....	46
Installing the I/O cover.....	47
Stand hinges.....	48
Removing the stand hinges.....	48
Installing the stand hinges.....	49
System-board shield.....	50
Removing the system-board shield.....	50
Installing the system-board shield.....	51
Solid-state drive.....	53
Removing the M.2 2230 solid-state drive.....	53
Installing the M.2 2230 solid-state drive.....	54
Memory module.....	55
Removing the memory module.....	55
Installing the memory module.....	56
Wireless card.....	57
Removing the wireless card.....	57
Installing the wireless card.....	58
Retractable-camera assembly.....	60
Removing the retractable-camera assembly.....	60
Installing the retractable-camera assembly.....	61
Fan.....	62
Removing the fan.....	62
Installing the fan.....	63
Speakers.....	64
Removing the speakers.....	64
Installing the speakers.....	65
Coin-cell battery.....	66
Removing the coin-cell battery.....	66
Installing the coin-cell battery.....	67
Chapter 6: Removing and installing Field Replaceable Units (FRUs).....	68
Heat sink.....	68
Removing the heat sink- UMA.....	68
Installing the heat sink- UMA.....	69
Removing the heat sink- discrete.....	70

Installing the heat sink- discrete.....	71
Media-card reader.....	72
Removing the media-card reader.....	72
Installing the media-card reader.....	73
Power-button board with USB.....	74
Removing the power-button board with USB.....	74
Installing the power-button board with USB.....	77
System board.....	79
Removing the system board.....	79
Installing the system board.....	83
Microphones.....	86
Removing the microphones.....	86
Installing the microphones.....	87
Antennas.....	88
Removing the antennas.....	88
Installing the antennas.....	90
Display panel.....	91
Removing the display panel.....	91
Installing the display panel.....	93
Middle frame assembly.....	96
Removing the middle-frame assembly.....	96
Installing the middle-frame assembly.....	97
Chapter 7: Software.....	99
Operating system.....	99
Drivers and downloads.....	99
Chapter 8: BIOS Setup.....	100
Entering BIOS setup program.....	100
Navigation keys.....	100
One time boot menu.....	100
System setup options.....	101
Updating the BIOS.....	112
Updating the BIOS in Windows.....	112
Updating the BIOS using the USB drive in Windows.....	112
Updating the BIOS in Linux and Ubuntu.....	113
Updating the BIOS from the One Time Boot menu.....	113
System and setup password.....	114
Assigning a system setup password.....	114
Deleting or changing an existing system setup password.....	114
Clearing CMOS settings.....	115
Clearing BIOS (System Setup) and System passwords.....	115
Chapter 9: Troubleshooting.....	116
Dell SupportAssist Pre-boot System Performance Check diagnostics.....	116
Running the SupportAssist Pre-Boot System Performance Check.....	116
System-diagnostic lights.....	116
Recovering the operating system.....	118
Backup media and recovery options.....	118

Wi-Fi power cycle.....119

Chapter 10: Getting help and contacting Dell..... 120

Views of Inspiron 27 7730 All-in-One

Right



Figure 1. Right view

1. USB 3.2 Gen 2 Type-C port

Connect devices such as external storage devices and printers.

Provides data transfer speeds up to 10 Gbps.

NOTE: Connected USB devices will not charge when the computer is turned off or in sleep state. Turn on the computer to charge the connected USB devices.

Front



Figure 2. Front view

1. Retractable-camera assembly

Enables you to videochat, capture photos, and record videos. This camera can be retracted to protect your privacy.

2. Display panel

Provides visual output to the user.

3. Speakers

Provides audio output.

Back



Figure 3. Back view

1. Back cover

Removable chassis that covers the internal components of your computer.

2. Back panel

Connect USB, audio, video, and other devices.

3. Stand

Allows the system to be mounted vertically.

Back panel

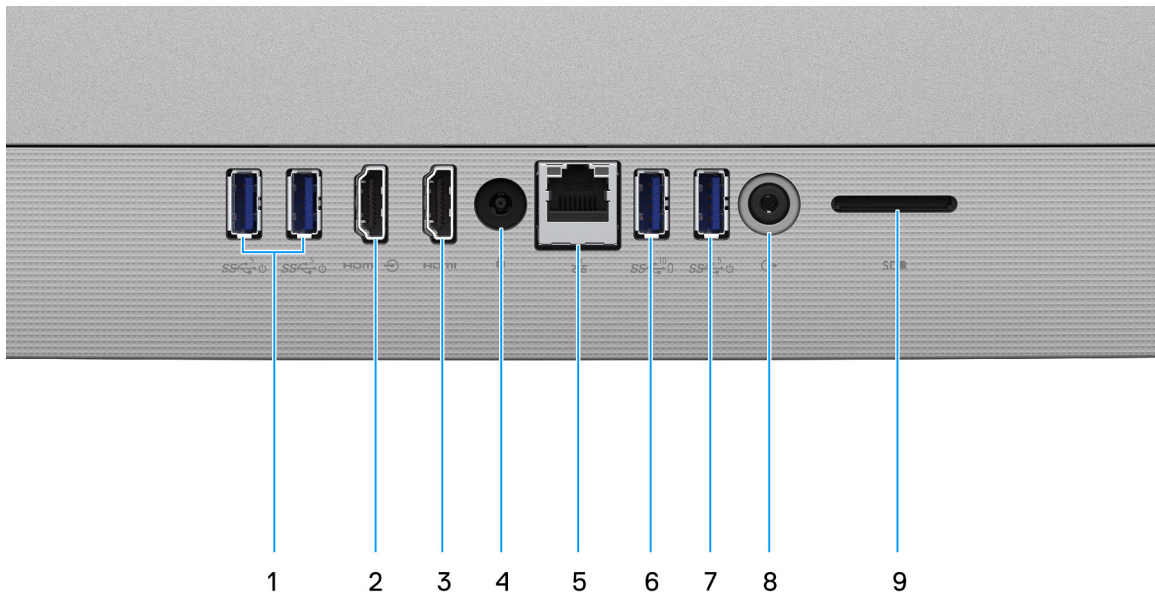

Figure 4. Back panel

1. 2 USB 3.2 Gen 1 port with Power on/Wake-up support

Connect peripherals such as external storage devices and printers. Provides data transfer speeds up to 5 Gbps. Wake the computer from standby with the keyboard or mouse connected to this port.

NOTE: Set the BIOS Deep Sleep control to disabled to enable Wake up when the computer is powered off.

2. HDMI-in port

Connect a gaming console, Blu-ray player, or other HDMI-out enabled device.

3. HDMI port

Connect to a TV, external display or another HDMI-in enabled device. Provides video and audio output.

4. Power-adapter port

Connect a power adapter to provide power to your computer and charge the battery.

5. Network port

Connect an Ethernet (RJ45) cable from a router or a broadband modem for network or Internet access.

6. USB 3.2 Gen 2 port with PowerShare

Connect peripherals such as external storage devices and printers.

Provides data transfer speeds up to 10 Gbps. PowerShare enables you to charge connected USB devices.

NOTE: Connected USB devices will not charge when the computer is turned off. Please set BIOS Deep Sleep control to disabled to start charging when the computer is powered off.

7. USB 3.2 Gen 1 port with Power on/Wake-up support

Connect peripherals such as external storage devices and printers. Provides data transfer speeds up to 5 Gbps. Wake the computer from standby with the keyboard or mouse connected to this port.

NOTE: Set the BIOS Deep Sleep control to disabled to enable Wake up when the computer is powered off.

8. Universal headset jack

Connect audio-output devices such as speakers, amplifiers, and so on.

9. SD-card slot

Reads from and writes to the SD card. The computer supports the following card types:

- Secure Digital (SD)
- Secure Digital High Capacity (SDHC)
- Secure Digital Extended Capacity (SDXC)

Bottom

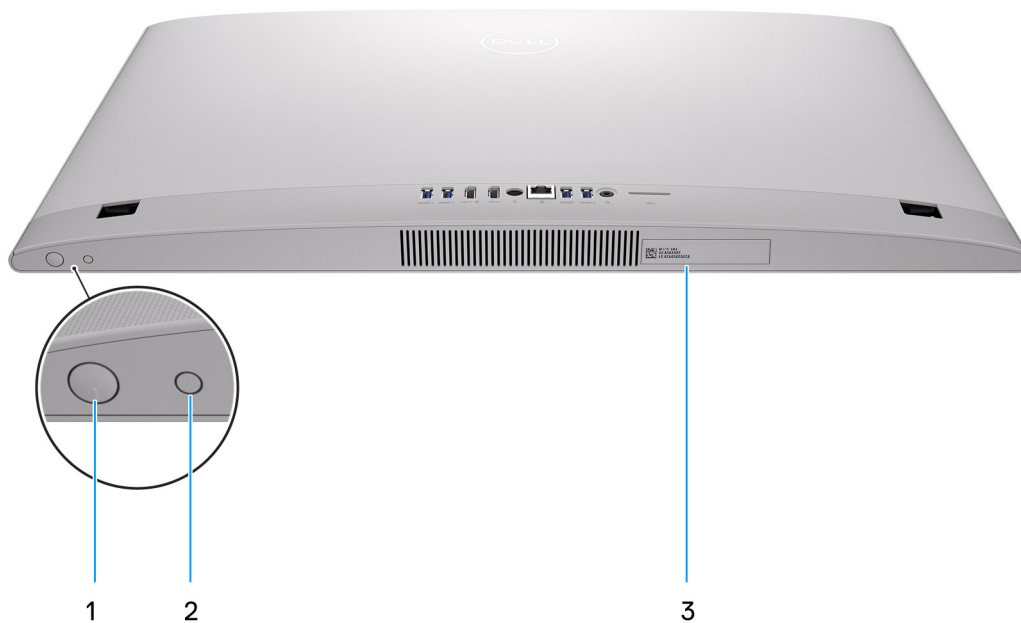

Figure 5. Bottom view

1. Power button

Press to turn on the computer if it is turned off, in sleep state, or in hibernate state.

When the computer is turned on, press the power button to put the computer into sleep state; press and hold the power button for 10 seconds to force shut-down the computer.

i **NOTE:** You can customize the power-button behavior in Windows.

2. Display Built-in Self Test button/Input-source selection button

This button has two functions:

- When the computer is on, use this button to select the video input-source.
Press the button to switch the display between the internal system display and HDMI input.
- When the computer is off (there is no power; neither is it in sleep state nor hibernate state), use this button to run the built-in self-test for the display.
Press and hold down this button, and then press the power button to turn on the computer. The built-in color pattern for the LCD monitor will appear on the screen.

For more information, see [Troubleshooting](#).

3. Service Tag label

The Service Tag is a unique alphanumeric identifier that enables Dell service technicians to identify the hardware components in your computer and access warranty information.

Service Tag

The service tag is a unique alphanumeric identifier that allows Dell service technicians to identify the hardware components in your computer and access warranty information.



Figure 6. Service Tag location

Tilt

Y stand



Isosceles stand



Retractable camera

Push the top of camera to extend or retract the camera. Extend the camera before use and retract the camera to protect your privacy when not in use.



Inside view of your computer

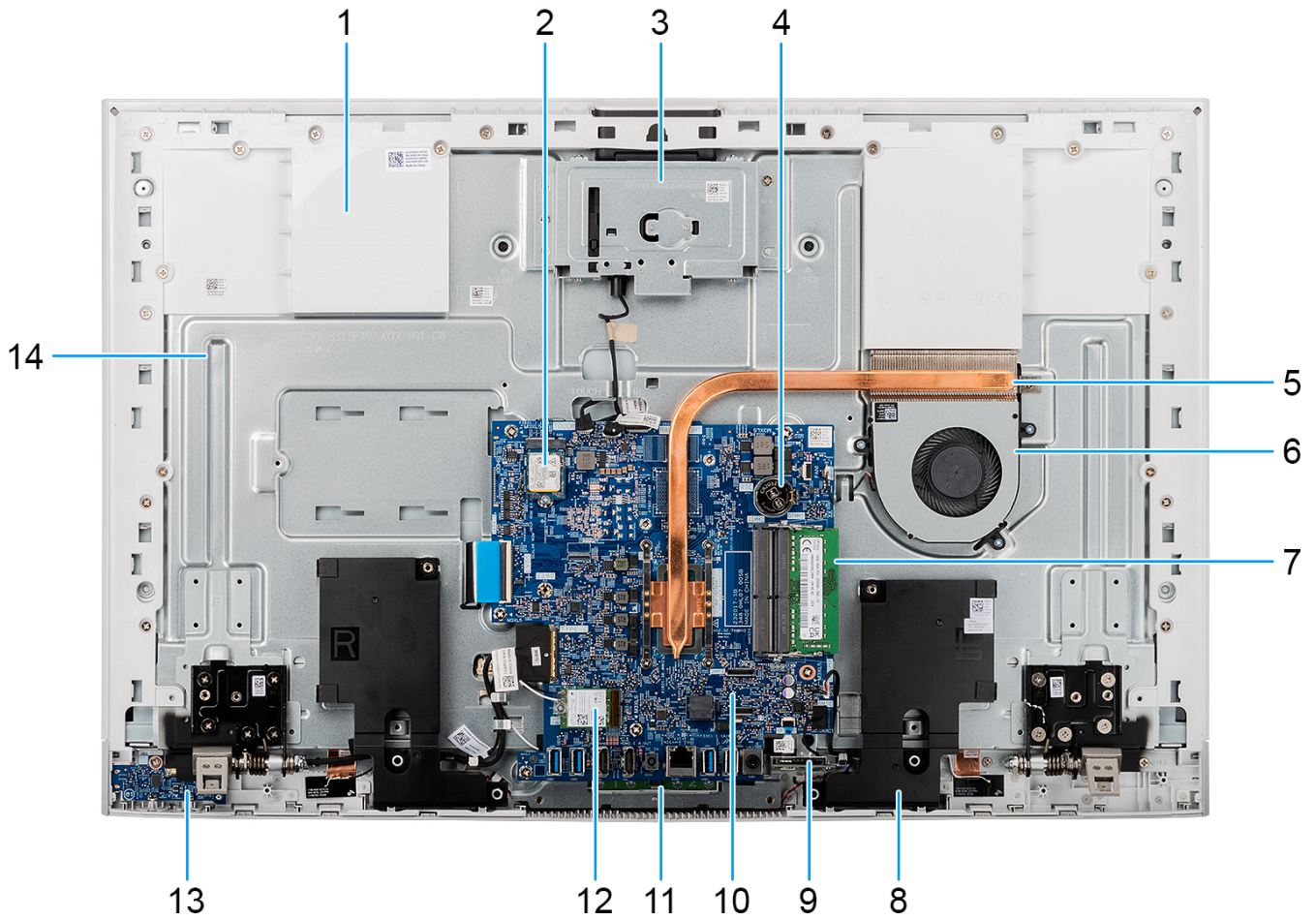

Figure 7. Inside view of your computer

- 1. Base panel
- 2. Solid-state drive slot
- 3. Camera module
- 4. Coin-cell battery
- 5. Heat sink
- 6. Fan
- 7. Memory module
- 8. Speaker
- 9. Media-card reader
- 10. System board
- 11. Microphone module
- 12. Wireless card slot
- 13. Power-button board with USB
- 14. Display-assembly base

Set up your Inspiron 27 7730 All-in-One

About this task

NOTE: The images in this document may differ from your computer depending on the configuration you ordered.

Steps

1. Set up the stand by inserting it into the slot on the back cover until it snaps into place.



Figure 8. Install the stand

2. Connect the keyboard and mouse.

NOTE: To connect your wireless keyboard and mouse, find User Guides and other resources for your products at [Dell Support Site](#).

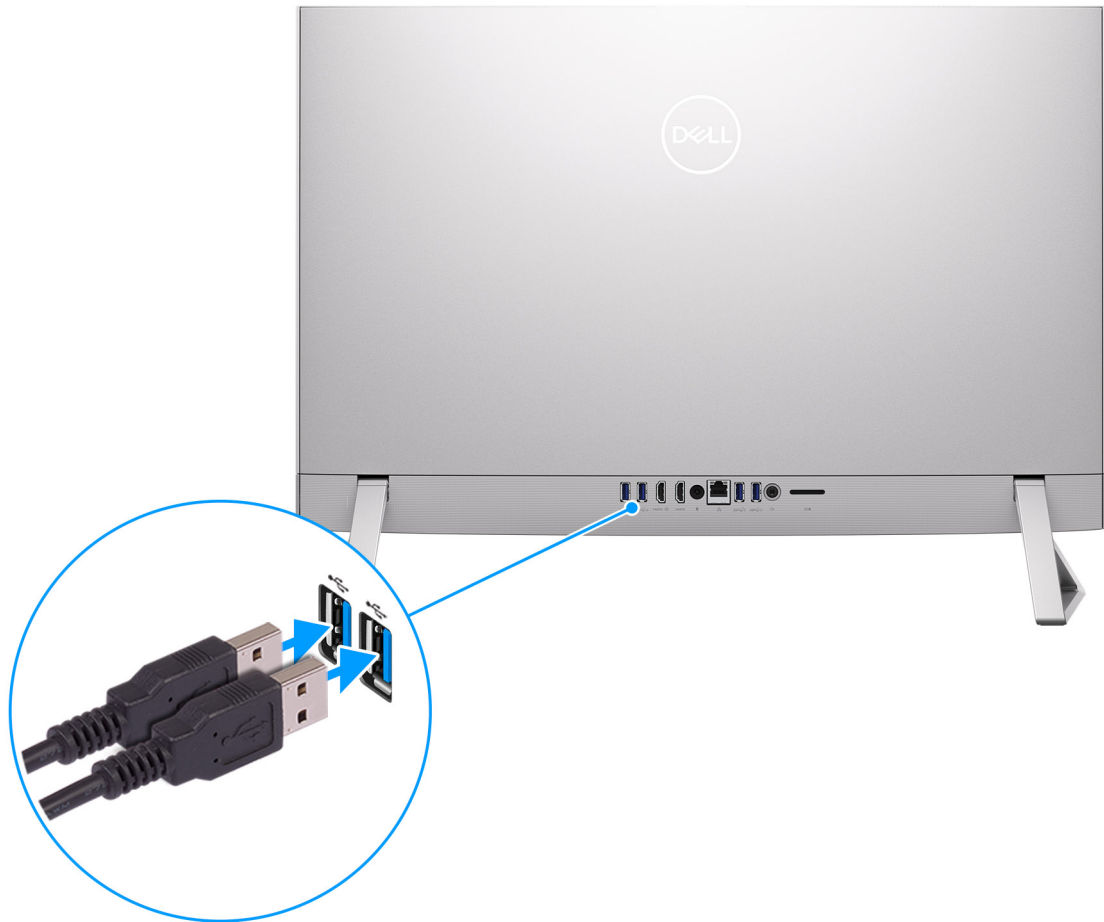

Figure 9. Connect the keyboard and mouse

3. Connect to your network using a cable.

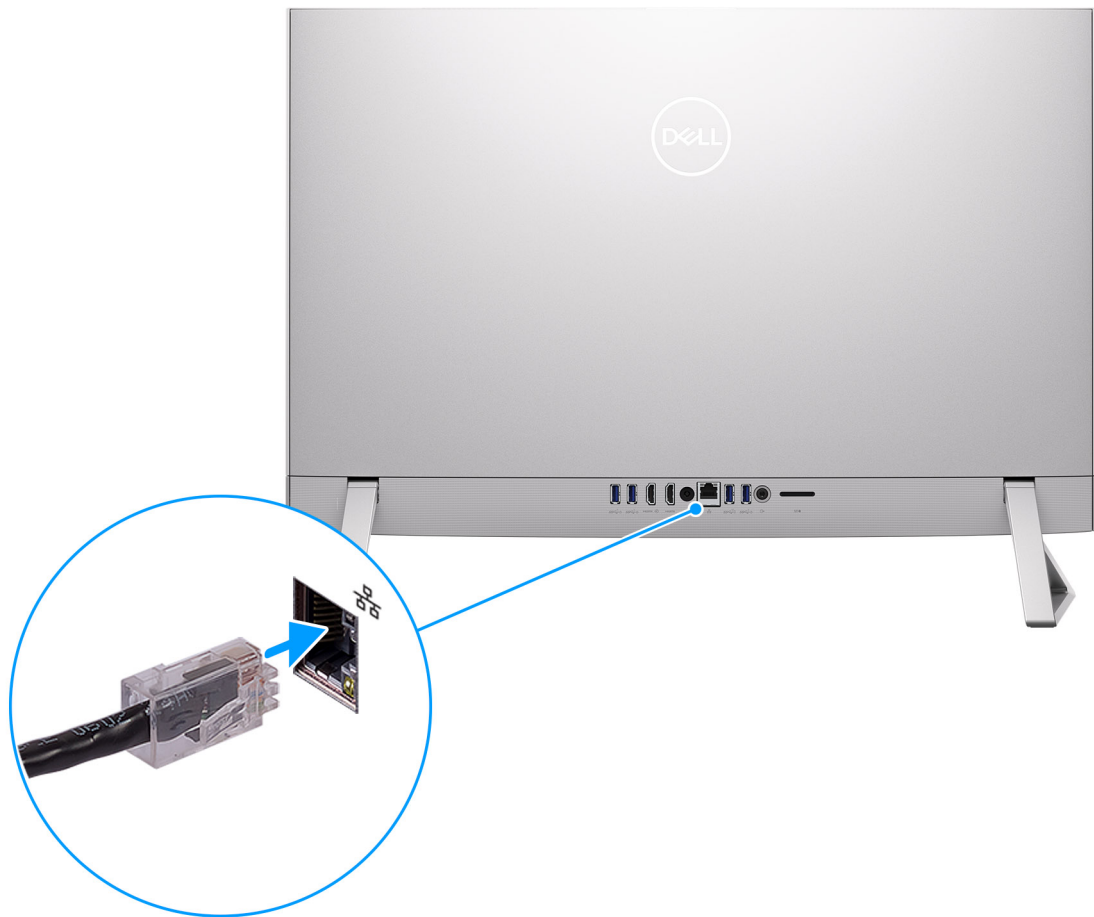

Figure 10. Connect to a network

i **NOTE:** Alternatively, you can connect to a wireless network.

4. Connect the power adapter.



Figure 11. Connect the power adapter .

5. Press the power button.



Figure 12. Press the power button

6. Finish the operating system setup.

For Windows:

Follow the on-screen instructions to complete the setup. When setting up, Dell Technologies recommends that you:

- Connect to a network for Windows updates.
 -  **NOTE:** If connecting to a secured wireless network, enter the password for the wireless network access when prompted.
- If connected to the Internet, sign in with or create a Microsoft account. If not connected to the Internet, create an offline account.
- On the **Support and Protection** screen, enter your contact details.

7. Locate and use Dell apps from the Windows Start menu—Recommended.

Table 1. Locate Dell apps in Windows in S-mode



Resources	Description
	<p>Dell Product Registration</p> <p>Register your computer with Dell.</p>
	<p>Dell Help & Support</p> <p>Access help and support for your computer.</p>

Table 1. Locate Dell apps in Windows in S-mode (continued)







Resources	Description
	<p>SupportAssist</p> <p>SupportAssist proactively and predictively identifies hardware and software issues on your computer and automates the engagement process with Dell Technical support. It addresses performance and stabilization issues, prevents security threats, monitors, and detects hardware failures. For more information, see SupportAssist for Home PCs User's Guide.</p> <p> NOTE: In SupportAssist, click the warranty expiry date to renew or upgrade your warranty.</p>

Table 2. Locate Dell apps in Windows

Resources	Description
	<p>My Dell</p> <p>MyDell is a software application that offers you a single streamlined engagement platform including account access, device information, and hardware settings. This software delivers intelligent features that automatically fine-tune your computer for the best possible audio, power, and performance. Get the most out of your Dell device with intelligent, personalized technology from MyDell. Following are the key features of MyDell:</p> <ul style="list-style-type: none"> • Application • Audio • Power • Color and Display • Presence detection <p>For more information about how to use MyDell, see product guides at Dell Support Site.</p>
	<p>Dell Update</p> <p>Updates your computer with critical fixes and latest device drivers as they become available. For more information about using Dell Update, see the product guides and third-party license documents at Dell Support Site.</p>
	<p>Dell Digital Delivery</p> <p>Download software applications, which are purchased but not preinstalled on your computer. For more information about using Dell Digital Delivery, search in the Knowledge Base Resource at Dell Support Site.</p>
	<p>SupportAssist</p> <p>SupportAssist proactively and predictively identifies hardware and software issues on your computer and automates the engagement process with Dell Technical support. It addresses performance and stabilization issues, prevents security threats, monitors, and detects hardware failures. For more information, see SupportAssist for Home PCs User's Guide.</p> <p> NOTE: In SupportAssist, click the warranty expiry date to renew or upgrade your warranty.</p>

Specifications of Inspiron 27 7730 All-in-One

Dimensions and weight

The following table lists the height, width, depth, and weight of your Inspiron 27 7730 All-in-One.

Table 3. Computer dimensions and weight (without stand)

Description		Values
Height		
	Front	394.82 mm (15.54 in.) i NOTE: The height of your computer varies depending on the stand installed.
	Rear	399.74 mm (15.73 in.) i NOTE: The height of your computer varies depending on the stand installed.
Width		614.70 mm (24.20 in.)
Depth		41.80 mm (1.64 in.)
Weight		<ul style="list-style-type: none"> • Maximum weight (non-touchscreen)- 6.79 kg (14.96 lb) • Maximum weight (touchscreen)- 7.08 kg (15.60 lb) i NOTE: The weight of your computer varies depending on the configuration ordered and the manufacturing variability.

Stand

The following table provides the height, width, depth, and weight of the stand supported by your Inspiron 27 7730 All-in-One.

Table 4. Stand

Description	Y stand	Isosceles stand
Height	96.81 mm (3.81 in.)	97.56 mm (3.84 in.)
Width	72.25 mm (2.84 in.)	66.95 mm (2.63 in.)
Depth	199.55 mm (7.85 in.)	200.46 mm (7.89 in.)
Weight	0.24 kg (0.53 lb)	0.32 kg (0.71 lb)

Y stand

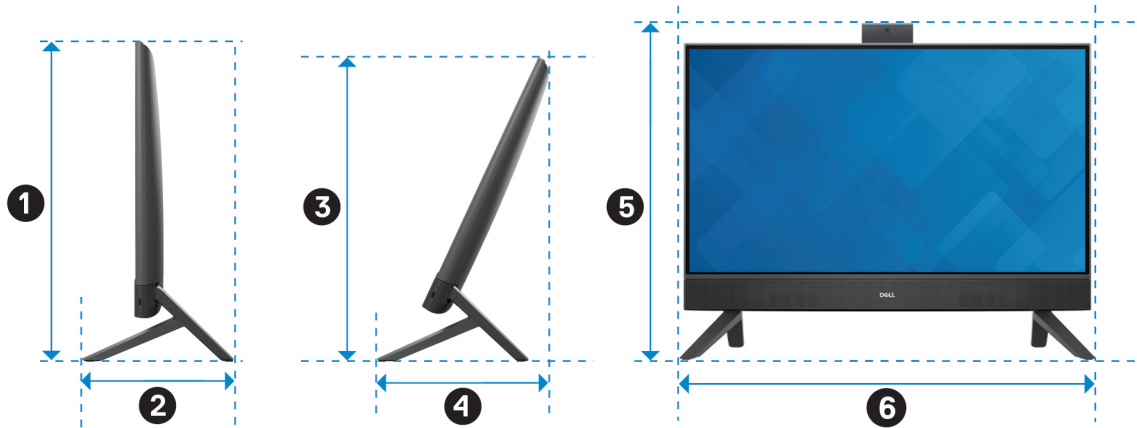

Figure 13. Y stand dimensions

The following table provides the dimensions of Y stand dimensions along with the computer.

Table 5. Y stand

Description	Dimensions
①	455.50 mm (17.93 in.)
②	199.55 mm (7.85 in.)
③	427.50 mm (16.83 in.)
④	244.84 mm (9.63 in.)
⑤	480.40 mm (18.91 in.)
⑥	611.11 mm (24.05 in.)

Isosceles stand

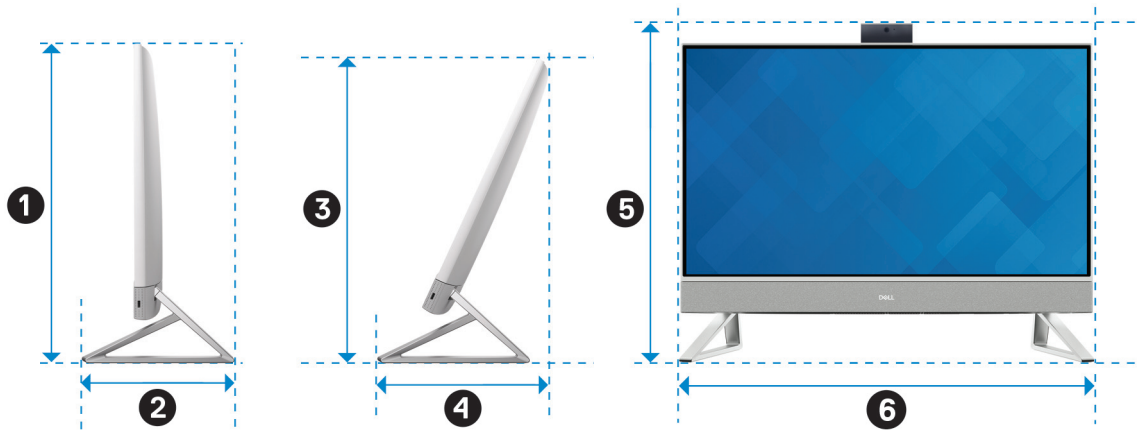

Figure 14. Isosceles stand dimensions

The following table provides the dimensions of Isosceles stand dimensions along with the computer.

Table 6. Isosceles stand

Description	Dimensions
①	455.50 mm (17.93 in.)
②	200.70 mm (7.90 in.)
③	427.50 mm (16.83 in.)
④	244.84 mm (9.63 in.)
⑤	480.40 mm (18.91 in.)
⑥	603.70 mm (23.76 in.)

Processor

The following table lists the details of the processors that are supported for your Inspiron 27 7730 All-in-One.

Table 7. Processor

Description	Option one	Option two	Option three
Processor type	Intel Core 5-120U Processor	Intel Core 7-150U Processor	Intel Core i5-1334U Processor
Processor wattage	15 W	15 W	15 W
Processor total core count	10	10	10
Performance-cores	2	2	2
Efficient-cores	8	8	8

Table 7. Processor (continued)

Description		Option one	Option two	Option three
Processor total thread count		12	12	12
<p>i NOTE: Intel Hyper-Threading Technology is only available on Performance-cores.</p>				
Processor speed		Up to 5.00 GHz	Up to 5.40 GHz	Up to 4.60 GHz
Performance-cores frequency				
	Processor base frequency	1.40 GHz	1.80 GHz	1.30 GHz
	Maximum turbo frequency	5.00 GHz	5.40 GHz	4.60 GHz
Efficient-cores frequency				
	Processor base frequency	1.40 GHz	1.80 GHz	0.90 GHz
	Maximum turbo frequency	3.80 GHz	4.00 GHz	3.40 GHz
Thermal Mode/Thermal Design Power (TDP)				
	Cool	Not supported	Not supported	Not supported
	Optimized	Not supported	Not supported	Not supported
	Quiet	Not supported	Not supported	Not supported
	Ultra Performance	15 W to 16 W	15 W to 18 W	15 W to 16 W
<p>i NOTE: Processor clock speeds and thermal design power differ according to the thermal mode selected in the My Dell app on your computer.</p>				
Processor cache		12 MB	12 MB	12 MB
Integrated graphics		Intel Iris X ^e Graphics	Intel Iris X ^e Graphics	Intel Iris X ^e Graphics

Chipset

The following table lists the details of the chipset that is supported in your Inspiron 27 7730 All-in-One.

Table 8. Chipset

Description	Values
Chipset	Integrated in the processor
Processor	<ul style="list-style-type: none"> Intel Core 5/7 Processor Intel Core i5-1334U Processor
DRAM bus width	64-bit
Flash EPROM	32 MB
PCIe bus	Up to Gen4

Operating system

Your Inspiron 27 7730 All-in-One supports the following operating systems:

- Windows 11 Home
- Windows 11 Pro

Memory

The following table lists the memory specifications of your Inspiron 27 7730 All-in-One.

Table 9. Memory specifications

Description	Values
Memory slots	Two SODIMM slots
Memory type	DDR4
Memory speed	3200 MT/s
Maximum memory configuration	32 GB
Minimum memory configuration	8 GB
Memory size per slot	8 GB, 16 GB, and 32 GB
Memory configurations supported	<ul style="list-style-type: none">• 8 GB: 1 x 8 GB, DDR4, 3200 MT/s, single-channel• 16 GB: 2 x 8 GB, DDR4, 3200 MT/s, dual-channel• 16 GB: 1 x 16 GB, DDR4, 3200 MT/s, single-channel• 32 GB: 2 x 16 GB, DDR4, 3200 MT/s, dual-channel• 32 GB: 1 x 32 GB, DDR4, 3200 MT/s , single-channel

External ports and slots

The following table lists the external ports of your Inspiron 27 7730 All-in-One.

Table 10. External ports and slots

Description	Values
Network port	One RJ45 ethernet port
USB ports	<ul style="list-style-type: none">• Three USB 3.2 Gen 1 ports with Power on/Wake-up support• One USB 3.2 Gen 2 port with PowerShare• One USB 3.2 Type-C Gen 2 port
Audio port	One universal headset jack
Video port(s)	<ul style="list-style-type: none">• One HDMI-out 1.4• One HDMI-in 1.4
Media-card reader	One SD-card 3.0 slot
Power-adaptor port	One 4.50 mm x 2.90 mm DC-in port
Security-cable slot	Not supported

Internal slots

The following table lists the internal slots of your Inspiron 27 7730 All-in-One.

Table 11. Internal slots

Description	Values
M.2	<ul style="list-style-type: none">One M.2 2230/2280 slot for PCIe solid-state driveOne M.2 2230 slot for WiFi and Bluetooth combo card <p>NOTE: To learn more about the features of different types of M.2 cards, search in the Knowledge Base Resource at Dell Support Site.</p>

Ethernet

The following table lists the wired Ethernet Local Area Network (LAN) specifications of your Inspiron 27 7730 All-in-One.

Table 12. Ethernet specifications

Description	Values
Model number	RTL8111HSD-CG
Transfer rate	10/100/1000 Mbps

Wireless module

The following table lists the Wireless Local Area Network (WLAN) module that is supported on your Inspiron 27 7730 All-in-One.

Table 13. Wireless module specifications

Description	Values
Model number	Intel AX211
Transfer rate	Up to 2400 Mbps
Frequency bands supported	2.40 GHz/5 GHz/6 GHz
Wireless standards	<ul style="list-style-type: none">WiFi 802.11a/b/gWi-Fi 4 (WiFi 802.11n)Wi-Fi 5 (WiFi 802.11ac)Wi-Fi 6/6E (WiFi 802.11ax)
Encryption	<ul style="list-style-type: none">64-bit/128-bit WEPAES-CCMPTKIP
Bluetooth wireless card	Bluetooth 5.3
	<p>NOTE: The version of the Bluetooth wireless card may vary depending on the operating system that is installed on your computer.</p>

Audio

The following table lists the audio specifications of your Inspiron 27 7730 All-in-One.

Table 14. Audio specifications

Description		Values
Audio controller		Realtek ALC3289
Stereo conversion		Supported
Internal audio interface		High definition audio interface
External audio interface		One Universal headset Jack
Number of speakers		2
Internal-speaker amplifier		Supported
External volume controls		Not supported
Speaker output:		
	Average speaker output	5 W x 2 = 10
	Peak speaker output	6 W x 2 = 12
Subwoofer output		Not supported
Microphone		Digital-array microphones in camera assembly

Storage

This section lists the storage options on your Inspiron 27 7730 All-in-One.

Your Inspiron 27 7730 All-in-One supports the M.2 2230 solid-state drive as the primary storage device.

Table 15. Storage specifications

Storage type	Interface type	Capacity
M.2 2230, solid-state drive	Gen4 x4 PCIe NVMe, up to 64 Gbps	Up to 1 TB
M.2 2230, solid-state drive	QLC Gen4 x4 PCIe NVMe, up to 64 Gbps	Up to 1 TB

Media-card reader

The following table lists the media cards that are supported in your Inspiron 27 7730 All-in-One.

Table 16. Media-card reader specifications

Description	Values
Media-card type	One SD-card 3.0 slot
Media-cards supported	<ul style="list-style-type: none"> Secure Digital (SD) Secure Digital High Capacity (SDHC) Secure Digital Extended Capacity (SDXC)

Table 16. Media-card reader specifications (continued)

Description	Values
 NOTE: The maximum capacity that is supported by the media-card reader varies depending on the standard of the media card that is installed on your computer.	

Camera

The following table lists the camera specifications of your Inspiron 27 7730 All-in-One.

Table 17. Camera specifications

Description	Option one	Option two
Number of cameras	One	One
Camera type	FHD RGB camera	5 MP RGB + Infrared camera
Camera location	Front camera	Front camera
Camera sensor type	CMOS sensor technology	CMOS sensor technology
Camera resolution:		
Still image	2.07 megapixels	4.92 megapixels
Video	1920 x 1080 (FHD) at 30 fps	2560 x 1920 (5 MP) at 30 fps
Infrared camera resolution:		
Still image	Not supported	0.23 megapixels
Video	Not supported	640 x 360 at 15 fps
Diagonal viewing angle:		
Camera	82 degrees	92 degrees
Infrared camera	Not supported	77.90 degrees

Power adapter

The following table lists the power adapter specifications of your Inspiron 27 7730 All-in-One.

Table 18. Power adapter specifications

Description	Option one	Option two
Type	90W AC	130W AC
Connector dimensions:		
External diameter	4.50 mm (0.17 in.)	4.50 mm (0.17 in.)
Internal diameter	2.90 mm (0.11 in.)	2.90 mm (0.11 in.)
Power-adapter dimensions:		
Height	32.00 mm (1.50 in.)	25.40 mm (1.00 in.)

Table 18. Power adapter specifications (continued)

Description		Option one	Option two
	Width	52.00 mm (2.00 in.)	76.20 mm (3.00 in.)
	Depth	128.00 mm (5.00 in.)	154.70 mm (6.10 in.)
Input voltage		100 VAC–240 VAC	100 VAC–240 VAC
Input frequency		50 Hz–60 Hz	50 Hz–60 Hz
Input current (maximum)		1.50 A	2.50 A
Output current (continuous)		4.62 A (continuous)	6.70 A (continuous)
Rated output voltage		19.50 VDC	19.50 VDC
Temperature range:			
	Operating	0°C to 40°C (32°F to 104°F)	0°C to 40°C (32°F to 104°F)
	Storage	-40°C to 70°C (-40°F to 158°F)	-40°C to 70°C (-40°F to 158°F)
 CAUTION: Operating and storage temperature ranges may differ among components, so operating or storing the device outside these ranges may impact the performance of specific components.			

Display

The following table lists the display specifications of your Inspiron 27 7730 All-in-One.

Table 19. Display specifications

Description		Option one	Option two
Display type		27", Full High Definition (FHD)	27", Full High definition (FHD)
Touch options		Touch support with 10 touch points	Not supported
Display-panel technology		Wide View Angle (WVA)	Wide view Angle (WVA)
Display-panel dimensions (active area):			
	Height	336.31 mm (13.24 in.)	336.31 mm (13.24 in.)
	Width	597.88 mm (23.54 in.)	597.88 mm (23.54 in.)
	Diagonal	685.98 mm (27.01 in.)	685.98 mm (27.01 in.)
Display-panel native resolution		1920 x 1080	1920 x 1080
Luminance (typical)		250 nits	300 nits
Megapixels		2.07 megapixels	2.07 megapixels
Color gamut		99% (sRGB) - typical	99% (sRGB) - typical
Pixels Per Inch (PPI)		81	81
Contrast ratio (minimum)		700:1	700:1

Table 19. Display specifications (continued)

Description	Option one	Option two
Response time (maximum)	28 ms	25 ms
Refresh rate	60 Hz	60 Hz
Horizontal view angle	<ul style="list-style-type: none"> +/- 85 degrees (typ.) +/- 89 degrees (min.) 	<ul style="list-style-type: none"> +/- 85 degrees (typ.) +/- 89 degrees (min.)
Vertical view angle	<ul style="list-style-type: none"> +/- 85 degrees (typ.) +/- 89 degrees (min.) 	<ul style="list-style-type: none"> +/- 85 degrees (typ.) +/- 89 degrees (min.)
Pixel pitch	0.3114 mm x 0.3114 mm	0.3114 mm x 0.3114 mm
Power consumption (maximum)	19.64W	19.24W
Anti-glare vs glossy finish	TrueLife	Anti-glare

GPU—Integrated

The following table lists the specifications of the integrated Graphics Processing Unit (GPU) supported by your Inspiron 27 7730 All-in-One.

Table 20. GPU—Integrated

Controller	Memory size	Processor
Intel Iris X ^e Graphics	Shared system memory	<ul style="list-style-type: none"> Intel Core 5/7 Processor Intel Core i5-1334U Processor

GPU—Discrete

The following table lists the specifications of the discrete Graphics Processing Unit (GPU) supported by your Inspiron 27 7730 All-in-One.

Table 21. GPU—Discrete

Controller	Memory size	Memory type
NVIDIA GeForce MX570A	2 GB	GDDR6

Environmental

The following table lists the environmental specifications of your Inspiron 27 7730 All-in-One.

Table 22. Environmental

Feature	Values
Recyclable packaging	Yes
BFR/PVC—free chassis	No
Vertical orientation packaging support	Yes
Multi-Pack packaging	No
Energy-Efficient Power Supply	Standard

Table 22. Environmental (continued)

Feature	Values
ENV0424 compliant	Yes

NOTE: Wood-based fiber packaging contains a minimum of 35% recycled content by total weight of wood-based fiber. Packaging that contains without wood-based fiber can be claimed as Not Applicable. The anticipated required criteria for EPEAT 2018.

Regulatory compliance

The following table lists the regulatory compliance of your Inspiron 27 7730 All-in-One.

Table 23. Regulatory compliance

Regulatory compliance
US CEC MEPS compliant configurations available
Australia and New Zealand MEPS compliant configurations available
CEL
WEEE
Japan Energy Law
South Korea E-standby
EU RoHS
China RoHS

Operating and storage environment

This table lists the operating and storage specifications of your Inspiron 27 7730 All-in-One.

Airborne contaminant level: G1 as defined by ISA-S71.04-1985

Table 24. Computer environment

Description	Operating	Storage
Temperature range	0°C to 35°C (32°F to 95°F)	-40°C to 65°C (-40°F to 149°F)
Relative humidity (maximum)	10% to 90% (non-condensing)	0% to 95% (non-condensing)
Vibration (maximum)*	0.66 GRMS	1.30 GRMS
Shock (maximum)	110 G†	160 G†
Altitude range	0 m to 3048 m (0 ft to 10000 ft)	0 m to 10668 m (0 ft to 35000 ft)

CAUTION: Operating and storage temperature ranges may differ among components, so operating or storing the device outside these ranges may impact the performance of specific components.

* Measured using a random vibration spectrum that simulates the user environment.

† Measured using a 2 ms half-sine pulse.











Dell support policy

For information about Dell support policy, search in the Knowledge Base Resource at [Dell Support Site](#).

Working inside your computer

Safety instructions

Use the following safety guidelines to protect your computer from potential damage and to ensure your personal safety. Unless otherwise noted, each procedure in this document assumes that you have read the safety information that shipped with your computer.



-  **WARNING:** Before working inside your computer, read the safety information that is shipped with your computer. For more safety best practices, see [Dell Regulatory Compliance Home Page](#).
-  **WARNING:** Disconnect your computer from all power sources before opening the computer cover or panels. After you finish working inside the computer, replace all covers, panels, and screws before connecting your computer to an electrical outlet.
-  **CAUTION:** To avoid damaging the computer, ensure that the work surface is flat, dry, and clean.
-  **CAUTION:** To avoid damaging the components and cards, handle them by their edges, and avoid touching the pins and the contacts.
-  **CAUTION:** You should only perform troubleshooting and repairs as authorized or directed by the Dell technical support team. Damage due to servicing that is not authorized by Dell is not covered by your warranty. See the safety instructions that is shipped with the product or at [Dell Regulatory Compliance Home Page](#).
-  **CAUTION:** Before touching anything inside your computer, ground yourself by touching an unpainted metal surface, such as the metal at the back of the computer. While you work, periodically touch an unpainted metal surface to dissipate static electricity which could harm internal components.
-  **CAUTION:** When you disconnect a cable, pull it by its connector or its pull tab, not the cable itself. Some cables have connectors with locking tabs or thumbscrews that you must disengage before disconnecting the cable. When disconnecting cables, keep them evenly aligned to avoid bending the connector pins. When connecting cables, ensure that the connector on the cable is correctly oriented and aligned with the port.
-  **CAUTION:** Press and eject any installed card from the media-card reader.
-  **CAUTION:** Exercise caution when handling rechargeable Li-ion batteries in laptops. Swollen batteries should not be used and should be replaced and disposed properly.
-  **NOTE:** The color of your computer and certain components may differ from what is shown in this document.

Before working inside your computer

About this task

-  **NOTE:** The images in this document may differ from your computer depending on the configuration you ordered.

Steps

1. Save and close all open files and exit all open applications.
2. Shut down your computer. For Windows operating system, click **Start** >  **Power** > **Shut down**.
 -  **NOTE:** If you are using a different operating system, see the documentation of your operating system for shut-down instructions.

3. Disconnect your computer and all attached devices from their electrical outlets.
4. Disconnect all attached network devices and peripherals, such as keyboard, mouse, and monitor from your computer.

 **CAUTION: To disconnect a network cable, first unplug the cable from your computer and then unplug the cable from the network device.**

5. Remove any media card and optical disc from your computer, if applicable.

Safety precautions

The safety precautions section details the primary steps to be taken before performing any disassembly instructions.

Observe the following safety precautions before you perform any installation or break-fix procedures involving disassembly or reassembly:

- Turn off the computer and all attached peripherals.
- Disconnect the computer from AC power.
- Disconnect all network cables and peripherals from the computer.
- Use an ESD field service kit when working inside any desktop to avoid electrostatic discharge (ESD) damage.
- After removing a computer component, carefully place the removed component on an anti-static mat.
- Wear shoes with non-conductive rubber soles to reduce the chance of getting electrocuted.
- Unplugging, pressing, and holding the power button for 15 seconds should discharge residual power in the system board.

Standby power

Dell products with standby power must be unplugged before you open the case. Systems equipped with standby power are powered while turned off. The internal power enables the computer to be remotely turned on (Wake-on-LAN) and suspended into a sleep mode and has other advanced power management features.

Bonding

Bonding is a method for connecting two or more grounding conductors to the same electrical potential. This is done by using a field service electrostatic discharge (ESD) kit. When connecting a bonding wire, ensure that it is connected to bare metal and never to a painted or nonmetal surface. Ensure that the wrist strap is secure and in full contact with your skin. Remove all jewelry such as watches, bracelets, or rings before to grounding yourself and the equipment.

Electrostatic discharge—ESD protection

ESD is a major concern when you handle electronic components, especially sensitive components such as expansion cards, processors, memory modules, and system boards. A slight charge can damage circuits in ways that may not be obvious, such as intermittent problems or a shortened product life span. As the industry pushes for lower power requirements and increased density, ESD protection is an increasing concern.

Due to the increased density of semiconductors used in recent Dell products, the sensitivity to static damage is now higher than in previous Dell products. For this reason, some previously approved methods of handling parts are no longer applicable.

Two recognized types of ESD damage are catastrophic and intermittent failures.

- **Catastrophic** – Catastrophic failures represent approximately 20 percent of ESD-related failures. The damage causes an immediate and complete loss of device functionality. An example of catastrophic failure is a memory module that has received a static shock and immediately generates a "No POST/No Video" symptom with a beep code that is emitted for missing or non-functional memory.
- **Intermittent** – Intermittent failures represent approximately 80 percent of ESD-related failures. The high rate of intermittent failures means that most of the time when damage occurs, it is not immediately recognizable. The memory module receives a static shock, but the tracing is merely weakened and does not immediately produce outward symptoms that are related to the damage. The weakened trace may take weeks or months to melt, and in the meantime may cause degradation of memory integrity, intermittent memory errors, and so on.

Intermittent failures also called latent or "walking wounded" are difficult to detect and troubleshoot.

Perform the following steps to prevent ESD damage:

- Use a wired ESD wrist strap that is properly grounded. Wireless anti-static straps do not provide adequate protection. Touching the chassis before handling parts does not ensure adequate ESD protection on parts with increased sensitivity to ESD damage.
- Handle all static-sensitive components in a static-safe area. If possible, use anti-static floor pads and workbench pads.
- When unpacking a static-sensitive component from its shipping carton, do not remove the component from the anti-static packing material until you are ready to install the component. Before unwrapping the anti-static packaging, use the anti-static wrist strap to discharge the static electricity from your body.
- Before transporting a static-sensitive component, place it in an anti-static container or packaging.

ESD Field Service kit

The unmonitored Field Service kit is the most commonly used service kit. Each Field Service kit includes three main components: anti-static mat, wrist strap, and bonding wire.

 **CAUTION: It is critical to keep ESD-sensitive devices away from internal parts that are insulators and often highly charged, such as plastic heat sink casings.**

Working Environment

Before deploying the ESD Field Service kit, assess the situation at the customer location. For example, deploying the kit for a server environment is different than for a desktop or laptop environment. Servers are typically installed in a rack within a data center; desktops or laptops are typically placed on office desks or cubicles. Always look for a large open flat work area that is free of clutter and large enough to deploy the ESD kit with additional space to accommodate the type of computer that is being repaired. The workspace should also be free of insulators that can cause an ESD event. On the work area, insulators such as Styrofoam and other plastics should always be moved at least 12 inches or 30 centimeters away from sensitive parts before physically handling any hardware components.

ESD Packaging

All ESD-sensitive devices must be shipped and received in static-safe packaging. Metal, static-shielded bags are preferred. However, you should always return the damaged part using the same ESD bag and packaging that the new part arrived in. The ESD bag should be folded over and taped shut and all the same foam packing material should be used in the original box that the new part arrived in. ESD-sensitive devices should be removed from packaging only at an ESD-protected work surface, and parts should never be placed on top of the ESD bag because only the inside of the bag is shielded. Always place parts in your hand, on the ESD mat, in the computer, or inside an anti-static bag.

Components of an ESD Field Service kit

The components of an ESD Field Service kit are:

- **Anti-Static Mat** – The anti-static mat is dissipative and parts can be placed on it during service procedures. When using an anti-static mat, your wrist strap should be snug and the bonding wire should be connected to the anti-static mat and to any bare metal on the computer being worked on. Once deployed properly, service parts can be removed from the ESD bag and placed directly on the anti-static mat. ESD-sensitive items are safe in your hand, on the anti-static mat, in the computer, or inside an ESD bag.
- **Wrist Strap and Bonding Wire** – The wrist strap and bonding wire can be either directly connected between your wrist and bare metal on the hardware if the ESD mat is not required, or connected to the anti-static mat to protect hardware that is temporarily placed on the mat. The physical connection of the wrist strap and bonding wire between your skin, the ESD mat, and the hardware is known as bonding. Use only Field Service kits with a wrist strap, anti-static mat, and bonding wire. Never use wireless wrist straps. Always be aware that the internal wires of a wrist strap are prone to damage from normal wear and tear, and must be checked regularly with a wrist strap tester in order to avoid accidental ESD hardware damage. It is recommended to test the wrist strap and bonding wire at least once per week.
- **ESD Wrist Strap Tester** – The wires inside an ESD strap are prone to damage over time. When using an unmonitored kit, it is a best practice to regularly test the strap prior to each service call, and at a minimum, test once per week. A wrist strap tester is the best method for doing this test. If you do not have your own wrist strap tester, check with your regional office to find out if they have one. To perform the test, plug the bonding-wire of the wrist-strap into the tester while it is strapped to your wrist and push the button to test. A green LED is lit if the test is successful; a red LED is lit and an alarm sounds if the test fails.

NOTE: It is recommended to always use the traditional wired ESD grounding wrist strap and protective anti-static mat when servicing Dell products. In addition, it is critical to keep sensitive parts separate from all insulator parts while servicing the computer, and use anti-static bags for transporting sensitive components.

Transporting sensitive components

When transporting ESD sensitive components such as replacement parts or parts to be returned to Dell, it is critical to place these parts in anti-static bags for safe transport.

Lifting equipment

Adhere to the following guidelines when lifting heavy equipment:

CAUTION: Do not lift greater than 50 pounds. Always obtain additional resources or use a mechanical lifting device.

1. Get a firm balanced footing. Keep your feet apart for a stable base, and point your toes out.
2. Tighten stomach muscles. Abdominal muscles support your spine when you lift, offsetting the force of the load.
3. Lift with your legs, not your back.
4. Keep the load close. The closer it is to your spine, the less force it exerts on your back.
5. Keep your back upright, whether lifting or setting down the load. Do not add the weight of your body to the load. Avoid twisting your body and back.
6. Follow the same technique in reverse to set the load down.

After working inside your computer

About this task

CAUTION: Leaving stray or loose screws inside your computer may severely damage your computer.

Steps

1. Replace all screws and ensure that no stray screws remain inside your computer.
2. Connect any external devices, peripherals, or cables you removed before working on your computer.
3. Replace any media cards, discs, or any other parts that you removed before working on your computer.
4. Connect your computer and all attached devices to their electrical outlets.
5. Turn on your computer.

BitLocker

CAUTION: If BitLocker is not suspended before updating the BIOS, the BitLocker key is not recognized the next time you reboot the computer. You will then be prompted to enter the recovery key to progress, and the system displays a prompt for the recovery key on each reboot. If the recovery key is not known, this can result in data loss or an operating system reinstall. For more information, see Knowledge Article: [updating the BIOS on Dell systems with BitLocker enabled](#).

The installation of the following components triggers BitLocker:

- Hard disk drive or solid-state drive
- System board

Recommended tools

The procedures in this document may require the following tools:

- Phillips screwdriver #0

- Phillips screwdriver #1
- Plastic scribe

Screw list

NOTE: When removing screws from a component, it is recommended to note the screw type and the quantity of screws, and then place them in a screw storage box. This is to ensure that the correct number of screws and correct screw type is restored when the component is replaced.

NOTE: Some computers have magnetic surfaces. Ensure that the screws are not left attached to such surfaces when replacing a component.

NOTE: Screw color may vary depending on the configuration ordered.

Table 25. Screw list

















Component	Screw type	Quantity	Screw image
I/O cover	M3x5	5	
Hard-drive assembly	M3x5	1	
Hard-drive bracket	M3x3.5	4	
System-board shield	M3x5	4	
Wireless-card bracket	M2x3.5	1	
M.2 2230/M.2 2280 solid-state drive	M2x3.5	1	
Solid-state drive screw mount	M3x4	1	
Retractable camera assembly	M3x5	2	
Fan	M2x3.5	3	
Stand hinges	M3x4.5	10	
Media-card reader	M3x3.5	1	
Power-button board	M3x4.5	5	
Power-button board	M3x5	1	
System board	M3x5	6	

Table 25. Screw list (continued)

Component	Screw type	Quantity	Screw image
Microphones	M2x2.5	4	
Display assembly	M3x5	12	
Display panel	M3x3	5	

Major components of Inspiron 27 7730 All-in-One

The following image shows the major components of Inspiron 27 7730 All-in-One.

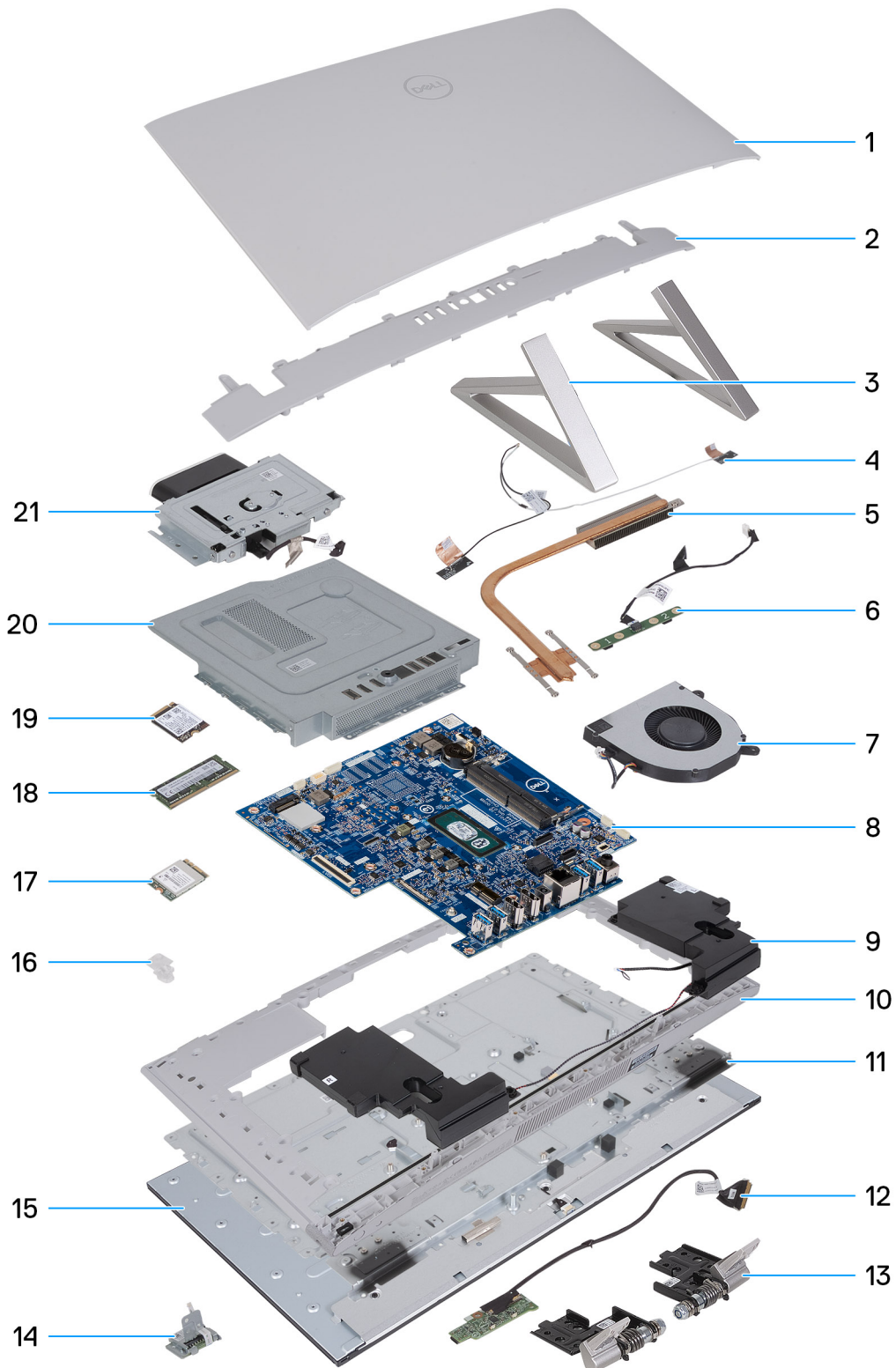

Figure 15. Major components of your computer

1. Back cover
2. I/O cover
3. Isosceles stand
4. Wireless antenna

5. Heat sink
6. Microphone module
7. Fan
8. System board
9. Speakers
10. Base panel
11. Middle frame
12. Power-button board with USB
13. Hinges
14. Media-card reader
15. Display panel
16. Wireless-card bracket
17. Wireless card
18. Memory module
19. M.2 2230 solid-state drive
20. System-board shield
21. Camera module

Removing and installing Customer Replaceable Units (CRUs)

The replaceable components in this chapter are Customer Replaceable Units (CRUs).

CAUTION: Customers can replace only the Customer Replaceable Units (CRUs) following the safety precautions and replacement procedures.

NOTE: The images in this document may differ from your computer depending on the configuration you ordered.

Stand

Removing the stand

Prerequisites

Follow the procedure in [Before working inside your computer](#).

CAUTION: When servicing the computer, place it on an elevated, clean, and flat surface. Place the display flat on the surface with the stand over the edge of the surface. It is recommended to remove the stand to avoid accidental damage to the computer display when servicing.

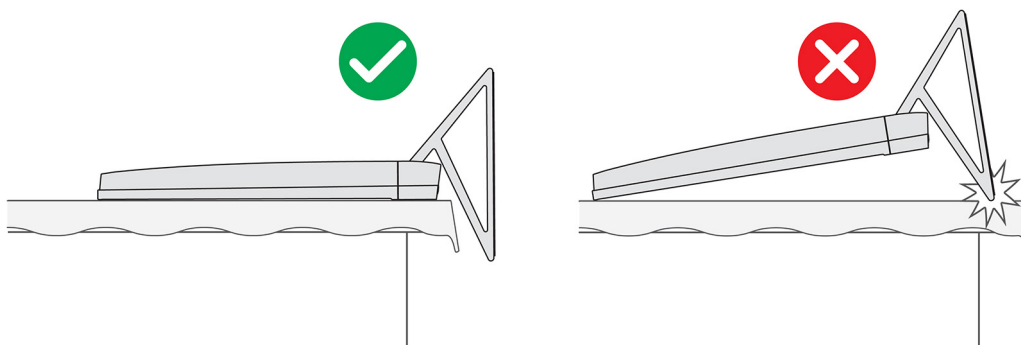

Figure 16. Caution for stand

NOTE: The following procedure is applicable for both Y stand and Isosceles stand.

NOTE: For replacement of stand or stand hinges, the replacement kit is shipped with both stand and stand hinges. Both components are replaced together.

About this task

The following image indicates the location of the stand and provides a visual representation of the removal procedure.



Figure 17. Removing the stand

Steps

1. Locate the tab on the stand, and push a scribe into the tab to release the stand from the display-assembly base.
2. Lift the stand off the display-assembly base.

Installing the stand

Prerequisites

If you are replacing a component, remove the existing component before performing the installation procedure.

NOTE: The following procedure is applicable for both Y stand and Isosceles stand.

NOTE: For replacement of stand or stand hinges, the replacement kit is shipped with both stand and stand hinges. Both components are replaced together.

About this task

The following image indicates the location of the stand and provides a visual representation of the installation procedure.



Figure 18. Installing the stand

Insert the stands into the slots on the back cover until they snap into place on the display-assembly base.

Next steps

Follow the procedure in [After working inside your computer](#).

Back cover

Removing the back cover

Prerequisites

1. Follow the procedure in [Before working inside your computer](#).

CAUTION: When servicing the computer, place it on an elevated, clean, and flat surface. Place the display flat on the surface with the stand over the edge. It is recommended to remove the stand to avoid accidental damage to the computer display when servicing.

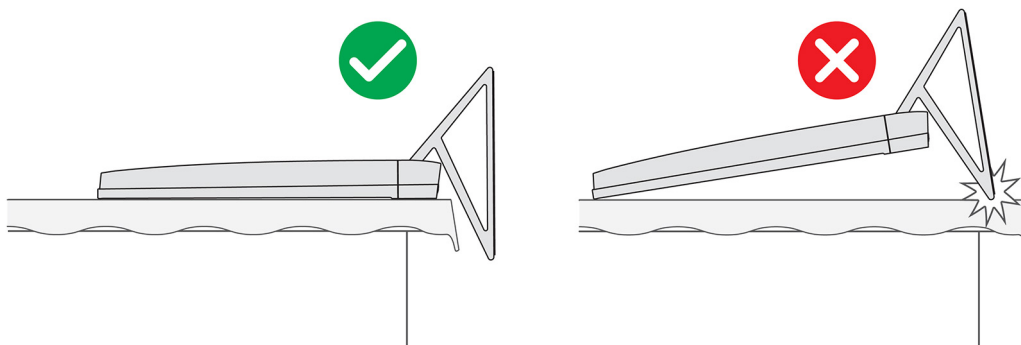

Figure 19. Caution for stand

About this task

The following image indicates the location of the back cover and provides a visual representation of the removal procedure.



Figure 20. Removing back cover

Steps

1. Place your palm in the middle of the back cover, and then pry the back cover from the display-assembly base starting from the top corners.
2. Remove the back cover from the display-assembly base.

Installing the back cover

Prerequisites

If you are replacing a component, remove the existing component before performing the installation procedure.

About this task

The following image indicates the location of the back cover and provides a visual representation of the installation procedure.



Figure 21. Installing the back cover

Steps

Align the slots on the back cover with the slots on the computer, and press along the side to snap the back cover into place.

Next steps

1. Follow the procedure in [After working inside your computer](#).

I/O cover

Removing the I/O cover

Prerequisites

1. Follow the procedure in [Before working inside your computer](#).
2. Remove the [stand](#).
3. Remove the [back cover](#).

About this task

The following image indicates the location of the I/O cover and provides a visual representation of the removal procedure.



5x
M3x5

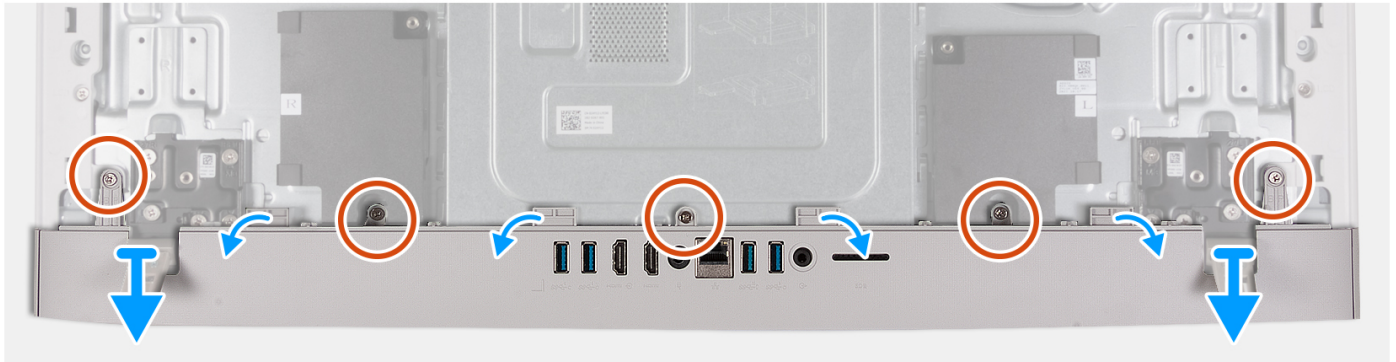
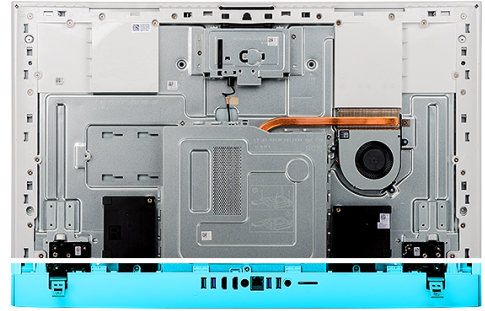

Figure 22. Removing I/O cover

Steps

1. Remove the five screws (M3x5) that secure the I/O cover to the display-assembly base.
2. Lift the I/O cover off the display-assembly base.

Installing the I/O cover

Prerequisites

If you are replacing a component, remove the existing component before performing the installation procedure.

About this task

The following image indicates the location of the I/O cover and provides a visual representation of the installation procedure.



5x
M3x5

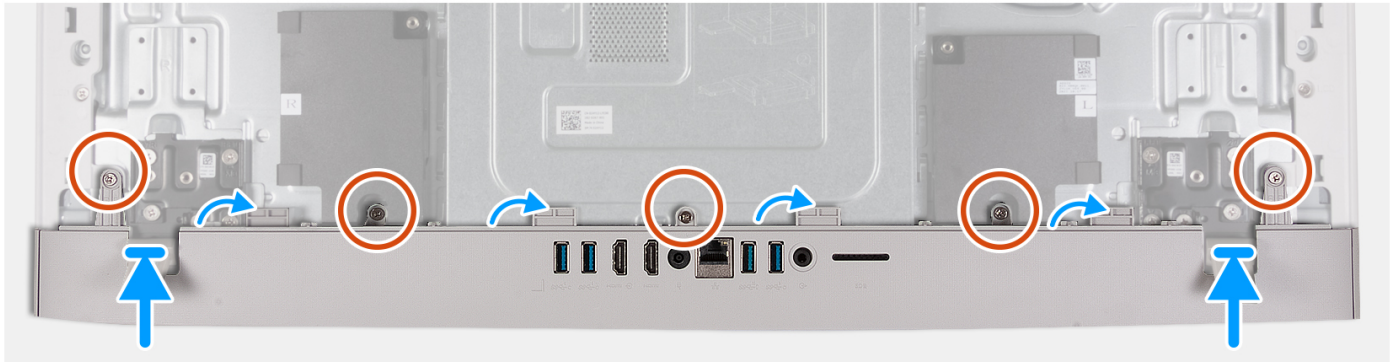
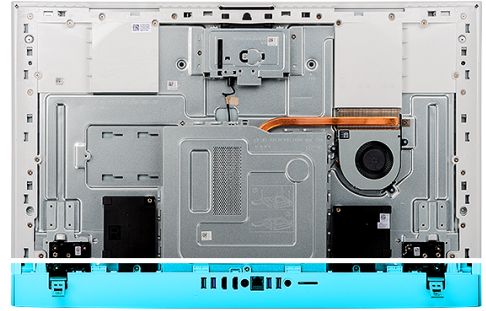

Figure 23. Installing bottom cover

Steps

1. Place the I/O cover on the display-assembly base.
2. Align the screw holes on the I/O cover with the screw holes on the display-assembly base.
3. Replace the two screws (M3x5) that secure the I/O cover to the display-assembly base and snap the I/O cover back into place.

Next steps

1. Install the [back cover](#).
2. Install the [stand](#).
3. Follow the procedure in [After working inside your computer](#).

Stand hinges

Removing the stand hinges

Prerequisites

1. Follow the procedure in [Before working inside your computer](#).
2. Remove the [stand](#).
3. Remove the [back cover](#).
4. Remove the [I/O cover](#).

NOTE: For replacement of stand or stand hinges, the replacement kit is shipped with both stand and stand hinges. Both components are replaced together. See the procedure for [removing the stand](#) and [installing the stand](#).

About this task

The following image indicates the location of the stand hinges and provides a visual representation of the removal procedure.



10x
M3x4.5

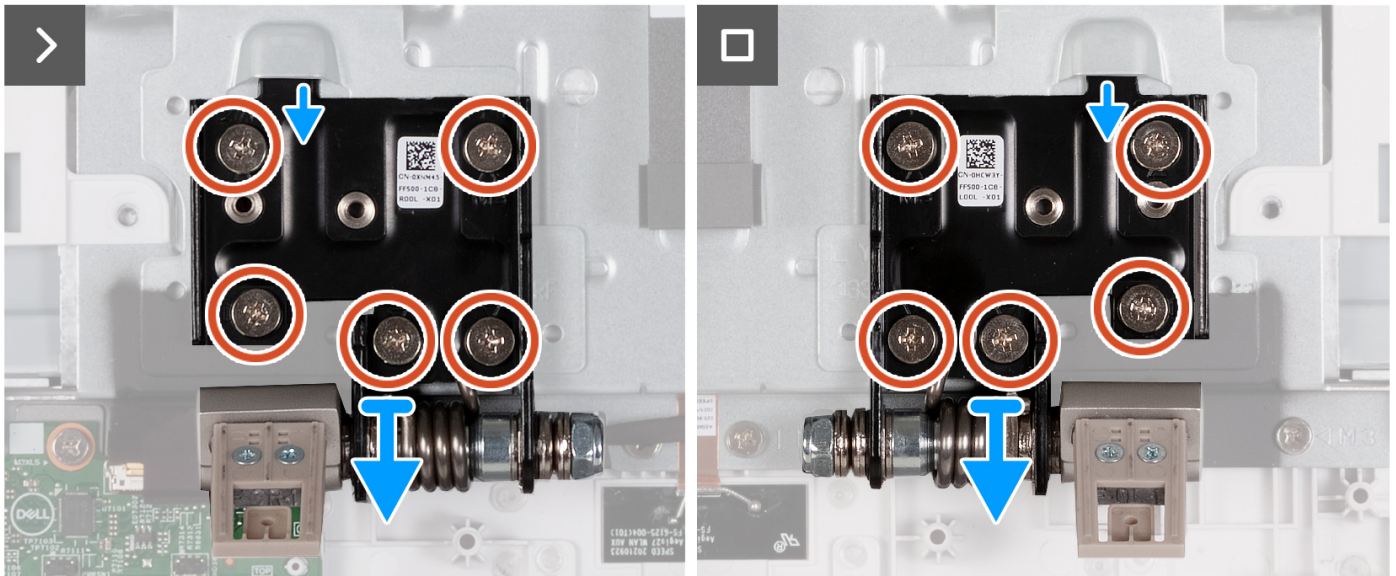
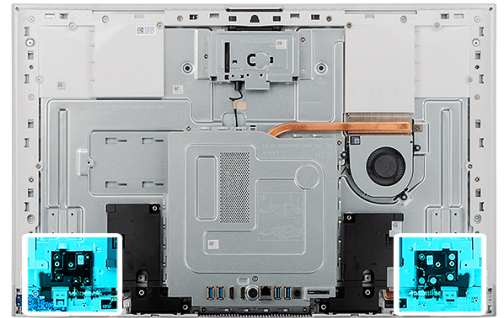

Figure 24. Removing the stand hinges

Steps

1. Remove the 10 screws (M3x4.5) that secure the right and left stand hinges to the display-assembly base.
2. Lift the stand hinges off the display-assembly base.

Installing the stand hinges

Prerequisites

If you are replacing a component, remove the existing component before performing the installation procedure.

i **NOTE:** For replacement of stand or stand hinges, the replacement kit is shipped with both stand and stand hinges. Both components are replaced together. See the procedure for [removing the stand](#) and [installing the stand](#).

About this task

The following image indicates the location of the stand hinges and provides a visual representation of the installation procedure.



10x
M3x4.5

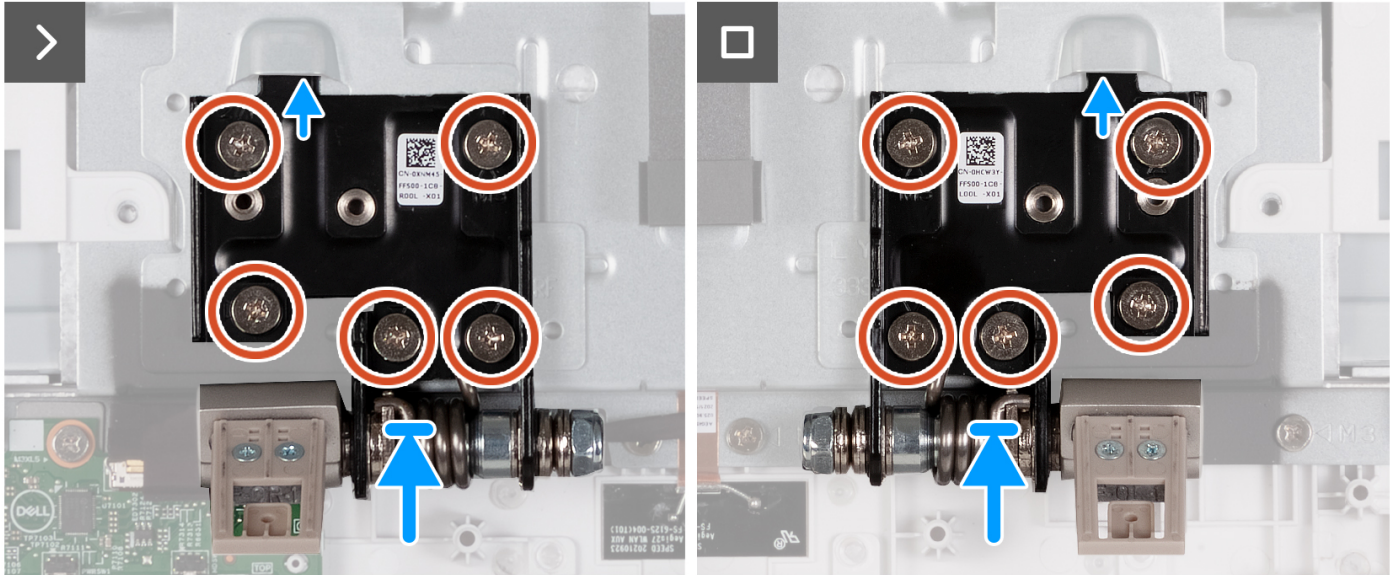
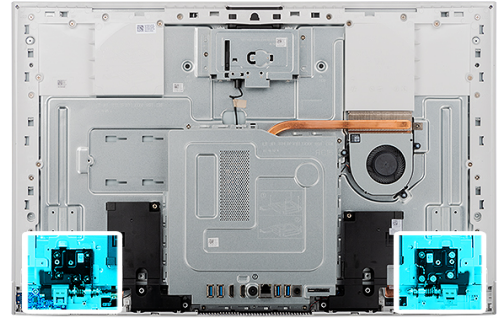

Figure 25. Installing the stand hinges

Steps

1. Align the screw holes on the stand hinges with the screw holes on the display-assembly base.
2. Replace the 10 screws (M3x4.5) that secure the stand hinges to the display-assembly base.

Next steps

1. Install the [I/O cover](#).
2. Install the [back cover](#).
3. Install the [stand](#).
4. Follow the procedure in [After working inside your computer](#).

System-board shield

Removing the system-board shield

Prerequisites

1. Follow the procedure in [Before working inside your computer](#).
2. Remove the [stand](#).
3. Remove the [back cover](#).
4. Remove the [I/O cover](#).

 **NOTE:** The etchings on the system-board shield do not represent the components that are supported by this computer.

About this task

The following image indicates the location of the system-board shield and provides a visual representation of the removal procedure.



4x
M3x5

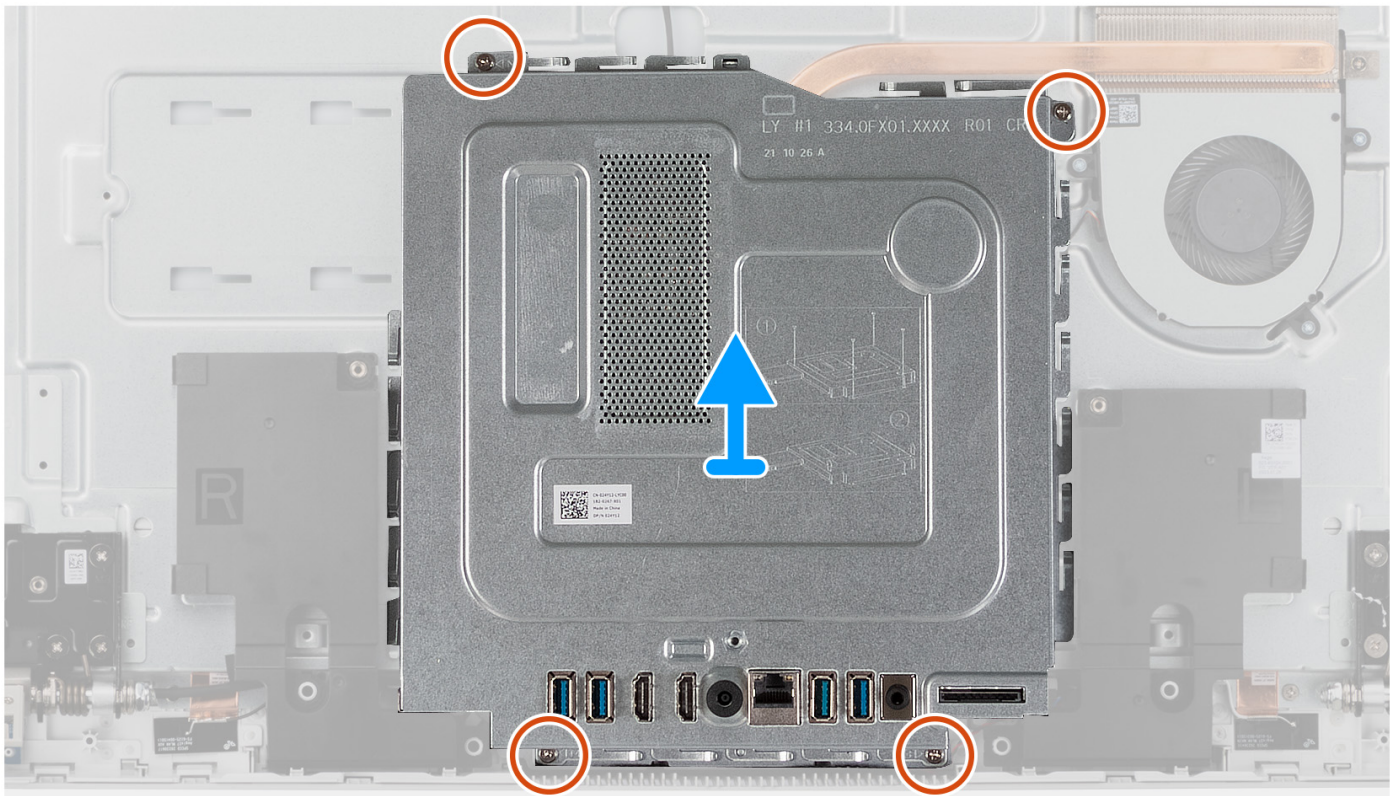
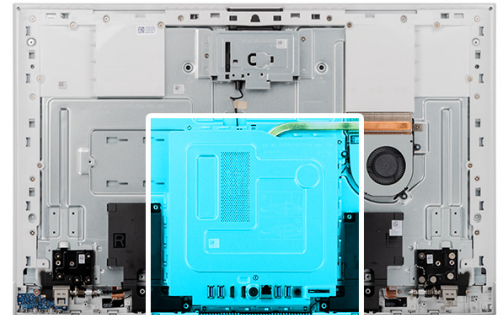

Figure 26. Removing the system-board shield

Steps

1. Remove the four screws (M3x5) that secure the system-board shield to the display-assembly base.
2. Lift the system-board shield off the display-assembly base.

Installing the system-board shield

Prerequisites

If you are replacing a component, remove the existing component before performing the installation procedure.

NOTE: The etchings on the system-board shield do not represent the components that are supported by this computer.

About this task

The following image indicates the location of the system-board shield and provides a visual representation of the installation procedure.



4x
M3x5

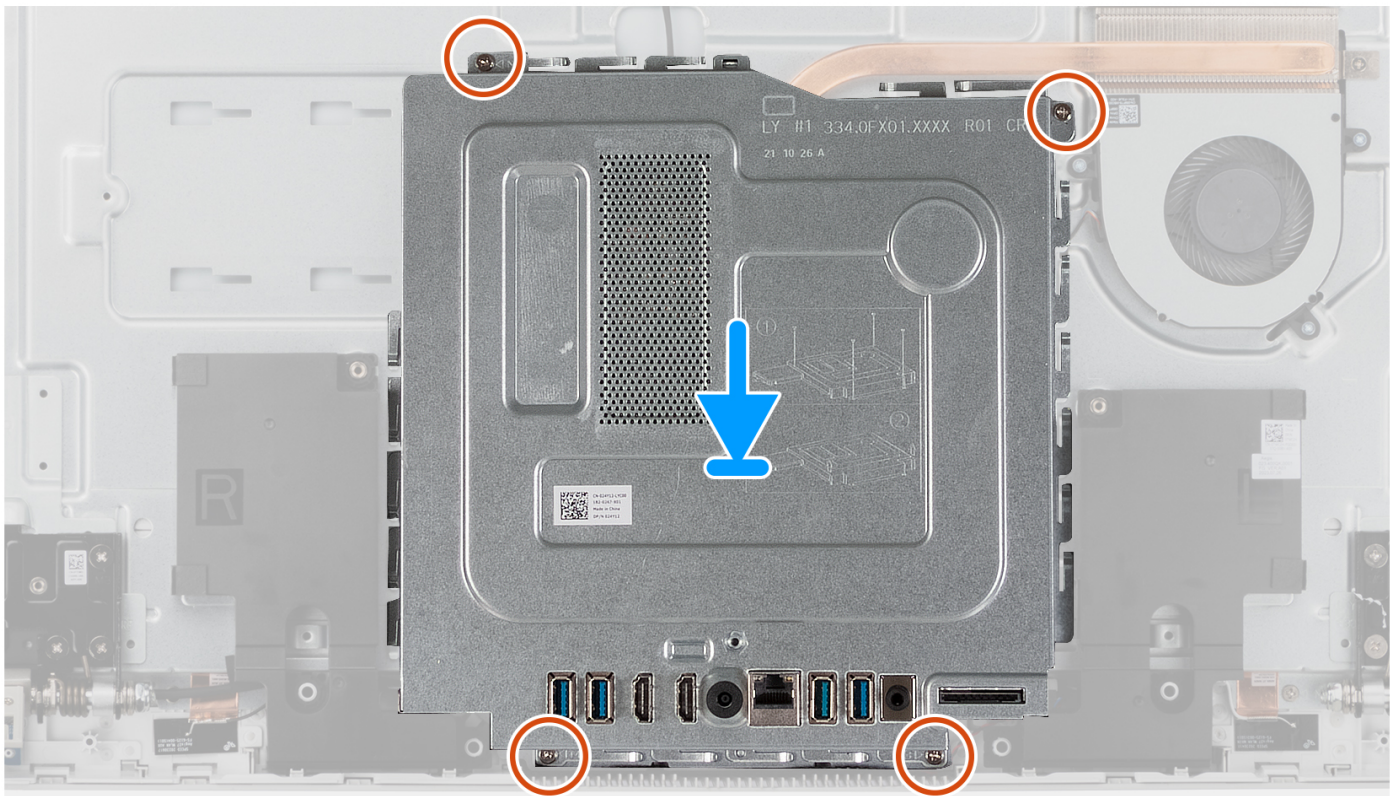
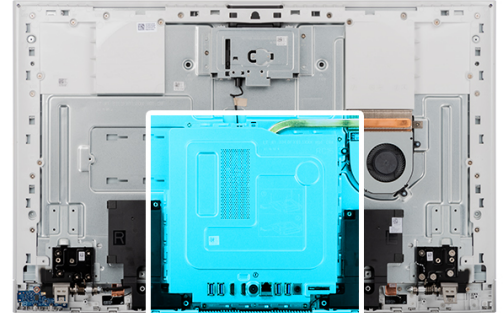

Figure 27. Installing the system-board shield

Steps

1. Align the screw holes on the system-board shield with the slots on the display-assembly base.
2. Place the system-board shield on the display-assembly base.
3. Replace the four screws (M3x5) that secure the system-board shield to the display-assembly base.

Next steps

1. Install the [I/O cover](#).
2. Install the [back cover](#).
3. Install the [stand](#).
4. Follow the procedure in [After working inside your computer](#).

Solid-state drive

Removing the M.2 2230 solid-state drive

Prerequisites

1. Follow the procedure in [Before working inside your computer](#).
2. Remove the [stand](#).
3. Remove the [back cover](#).
4. Remove the [I/O cover](#).
5. Remove the [system-board shield](#).

About this task

NOTE: The M.2 card that is installed on your computer depends on the configuration ordered. The supported card configurations on the M.2 card slot are:

- M.2 2230 solid-state drive
- M.2 2280 solid-state drive

NOTE: This procedure applies only to computers shipped with an M.2 2230 solid-state drive.

The following image indicates the location of the solid-state drive and provides a visual representation of the removal procedure.

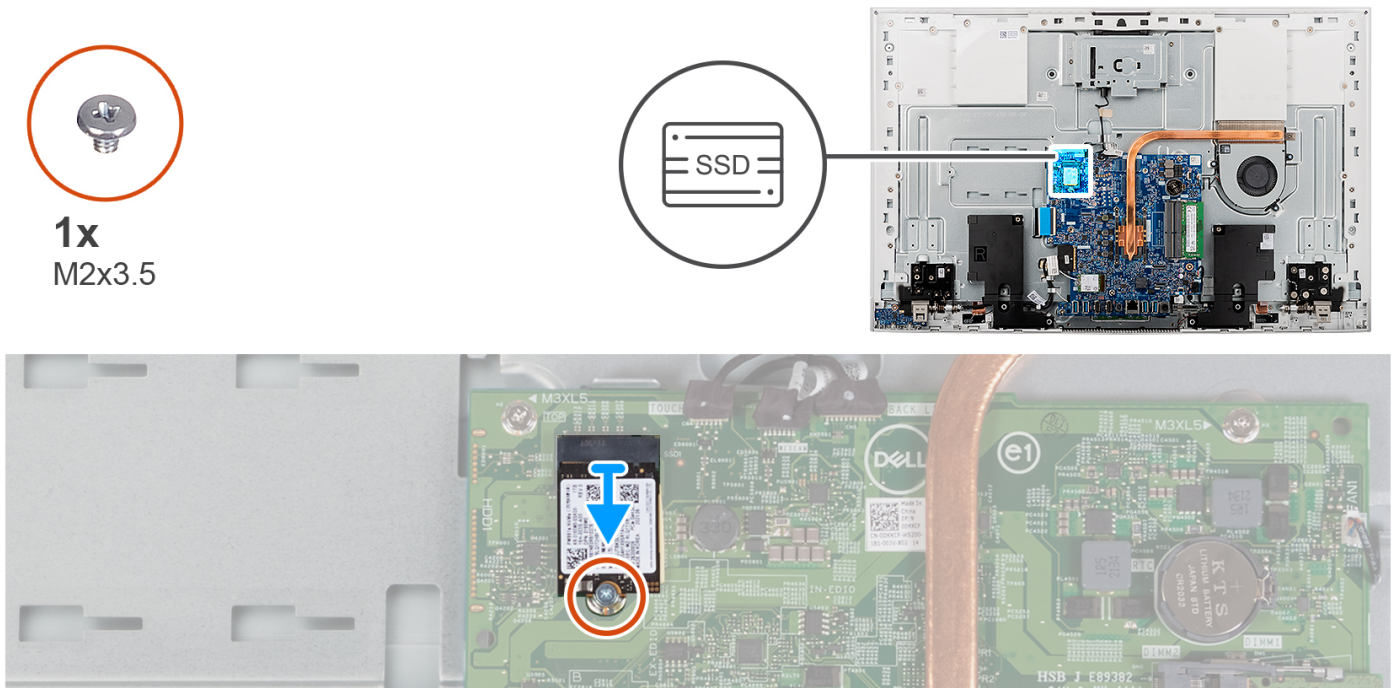

Figure 28. Removing the M.2 2230 solid-state drive

Steps

1. Remove the screw (M2x3.5) that secures the solid-state drive to the system board.
2. Slide and remove the solid-state drive from the M.2 card slot on the system board.

Installing the M.2 2230 solid-state drive

Prerequisites

CAUTION: Solid-state drives are fragile. Exercise care when handling the solid-state drive.

If you are replacing a component, remove the existing component before performing the installation procedure.

About this task

The following image indicates the location of the solid-state drive and provides a visual representation of the installation procedure.

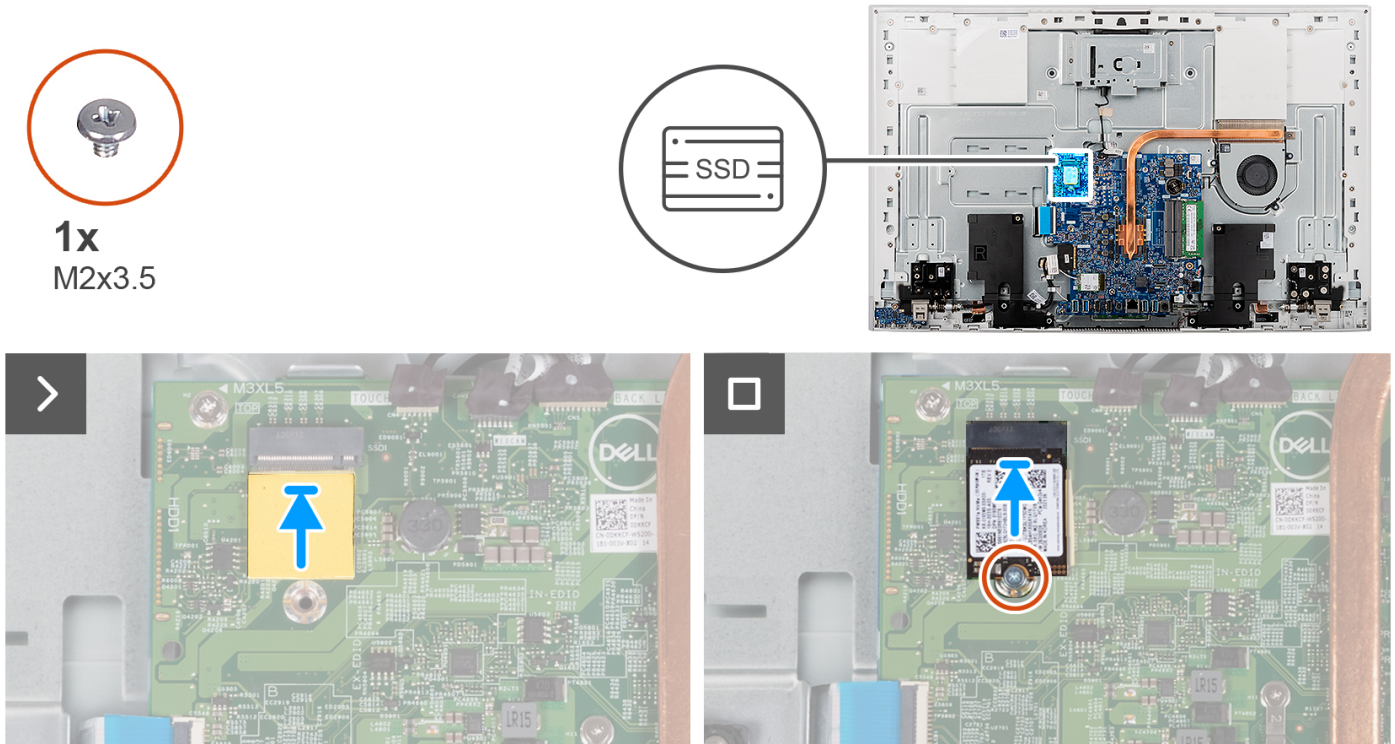

Figure 29. Installing the M.2 2230 solid-state drive

Steps

1. Ensure that the thermal pad covering the M.2 2230 slot on the system board is in place.
2. Align the notch on the solid-state drive with the tab on the M.2 card slot.
3. Slide the solid-state drive into the M.2 card slot on the system board.
4. Replace the screw (M2x3.5) that secures the solid-state drive to the system board.

Next steps

1. Install the [system-board shield](#).
2. Install the [I/O cover](#).
3. Install the [back cover](#).
4. Install the [stand](#).
5. Follow the procedure in [After working inside your computer](#).

Memory module

Removing the memory module

Prerequisites

1. Follow the procedure in [Before working inside your computer](#).
2. Remove the [stand](#).
3. Remove the [back cover](#).
4. Remove the [I/O cover](#).
5. Remove the [system-board shield](#).

About this task

The following image indicates the location of the memory module and provides a visual representation of the removal procedure.

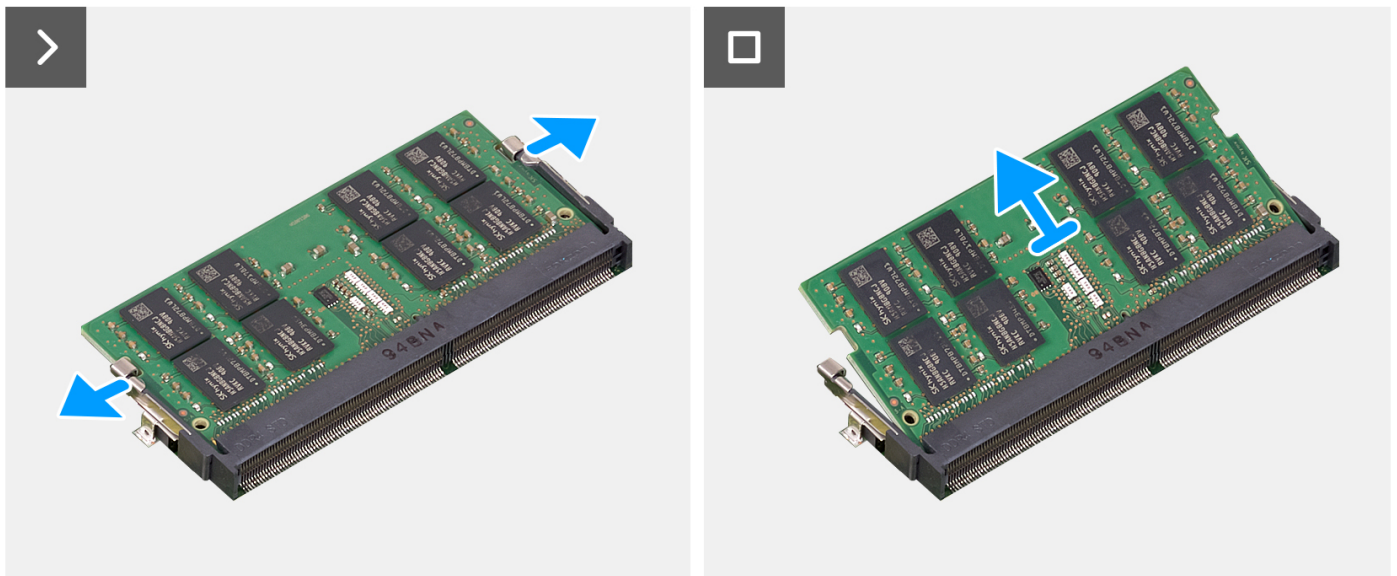
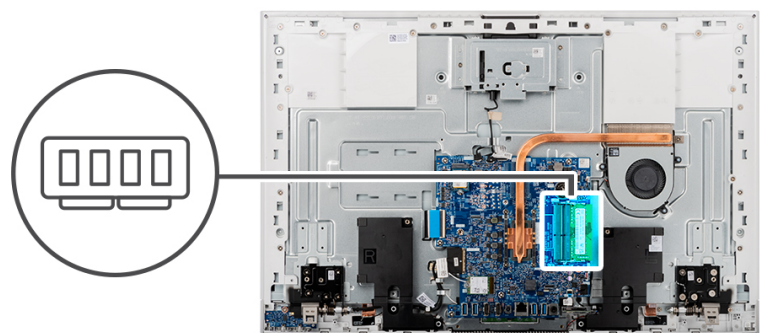

Figure 30. Removing the memory module

Steps

1. Carefully spread apart the securing-clips on each end of the memory-module slot until the memory module is released.
2. Slide and remove the memory module from the memory-module slot.

NOTE: Repeat steps 1 and 2 if you want to remove the other memory module.

Installing the memory module

Prerequisites

If you are replacing a component, remove the existing component before performing the installation procedure.

About this task

The following image indicates the location of the memory module and provides a visual representation of the installation procedure.

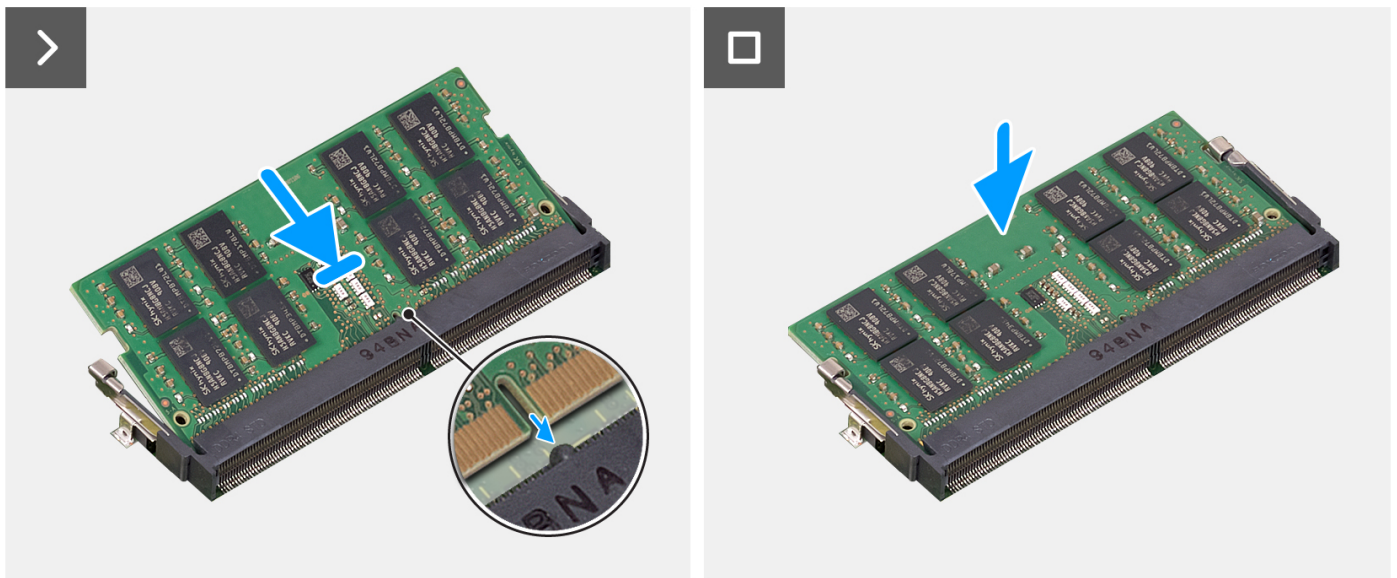
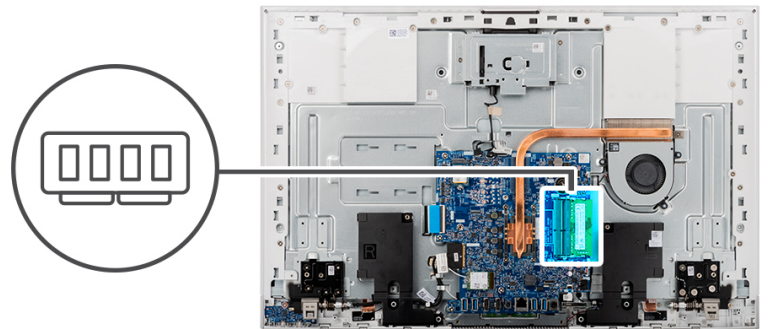

Figure 31. Installing the memory module

Steps

1. Align the notch on the memory module with the tab on the memory-module slot.
2. Slide the memory module firmly into the slot at an angle and press the memory module down until it clicks into place.

(i) NOTE: If you do not hear the click, remove the memory module and reinstall it.

(i) NOTE: Repeat steps 1 and 2 if you want to install the other memory module.

Next steps

1. Install the [system-board shield](#).
2. Install the [I/O cover](#).
3. Install the [back cover](#).
4. Install the [stand](#).
5. Follow the procedure in [After working inside your computer](#).

Wireless card

Removing the wireless card

Prerequisites

1. Follow the procedure in [Before working inside your computer](#).
2. Remove the [stand](#).
3. Remove the [back cover](#).
4. Remove the [I/O cover](#).
5. Remove the [system-board shield](#).

About this task

The following image indicates the location of the wireless card and provides a visual representation of the removal procedure.



1x
M2x3.5



Figure 32. Removing the wireless card

Steps

1. Remove the screw (M2x3.5) that secures the wireless-card bracket to the wireless card.
2. Slide and lift the wireless-card bracket off the wireless card.
3. Disconnect the antenna cables from the wireless card.
4. Slide and remove the wireless card from the wireless-card slot.

Installing the wireless card

Prerequisites

If you are replacing a component, remove the existing component before performing the installation procedure.

 **CAUTION: To avoid damage to the wireless card, do not place any cables under it.**

About this task

The following image indicates the location of the wireless card and provides a visual representation of the installation procedure.



1x
M2x3.5



Figure 33. Installing the wireless card

Steps

1. Connect the antenna cables to the wireless card.
The following table provides the antenna-cable color scheme for the wireless card that is supported by your computer.

Table 26. Antenna-cable color scheme

Connectors on the wireless card	Antenna-cable color
Main (white triangle)	White
Auxiliary (black triangle)	Black

2. Place the wireless-card bracket on the wireless card.
3. Align the notch on the wireless card with the tab on the wireless-card slot.
4. Slide the wireless card at an angle into the wireless-card slot.
5. Replace the screw (M2x3.5) that secures the wireless-card bracket to the wireless card.

Next steps

1. Install the [system-board shield](#).
2. Install the [I/O cover](#).
3. Install the [back cover](#).
4. Install the [stand](#).
5. Follow the procedure in [After working inside your computer](#).

Retractable-camera assembly

Removing the retractable-camera assembly

Prerequisites

1. Follow the procedure in [Before working inside your computer](#).
2. Remove the [stand](#).
3. Remove the [back cover](#).
4. Remove the [I/O cover](#).
5. Remove the [system-board shield](#).

About this task

The following image indicates the location of the retractable-camera assembly and provides a visual representation of the removal procedure.

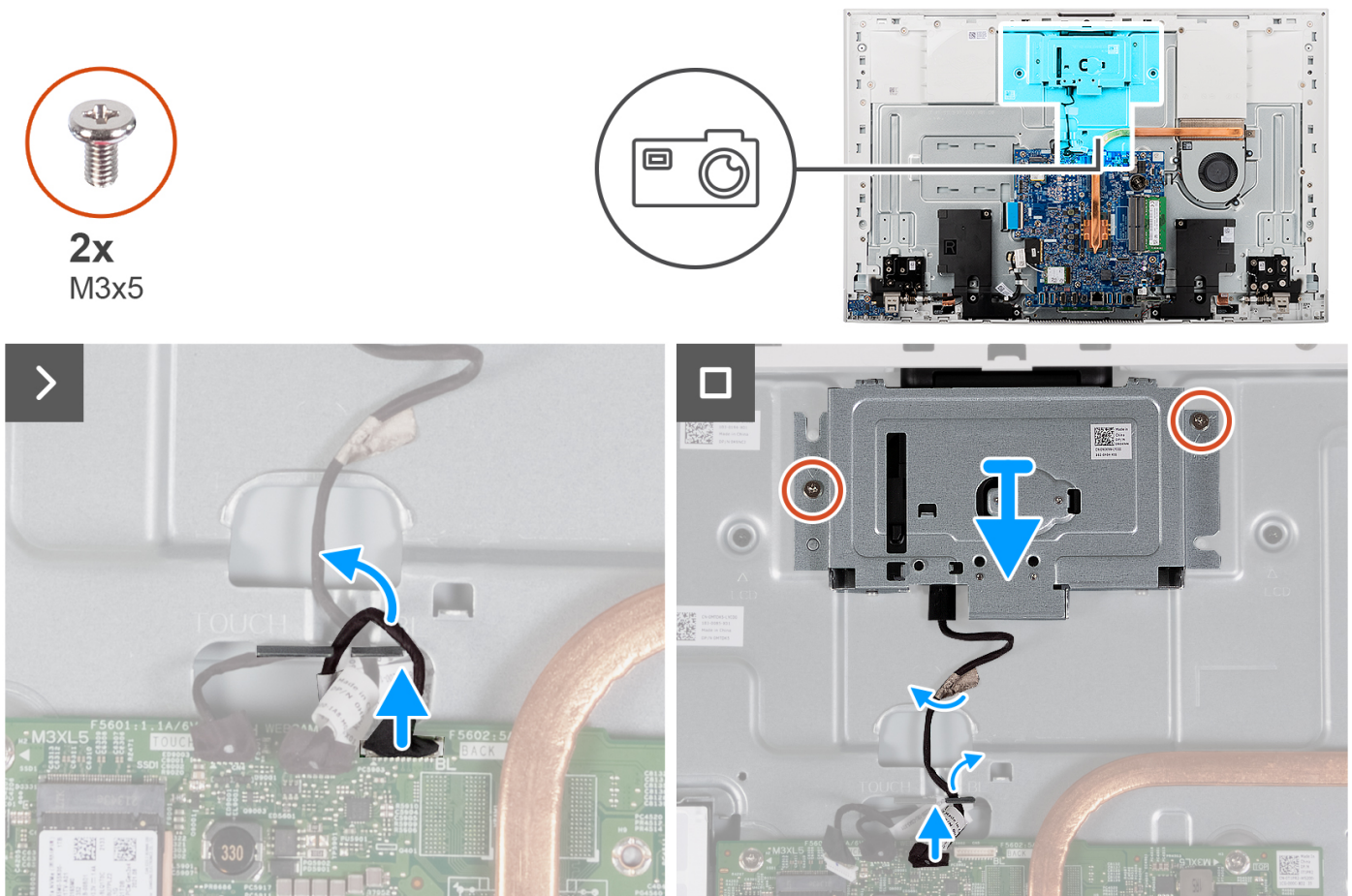

Figure 34. Removing the camera

Steps

1. Disconnect the camera cable from its connector (WEBCAM) on the system board.
2. Peel the tape that secures the camera cable to the display-assembly base.
3. Remove the two screws (M3x5) that secure the retractable-camera assembly to the display-assembly base.
4. Remove the retractable-camera assembly from the display-assembly base.

Installing the retractable-camera assembly

Prerequisites

If you are replacing a component, remove the existing component before performing the installation procedure.

About this task

The following image indicates the location of the retractable-camera assembly and provides a visual representation of the installation procedure.

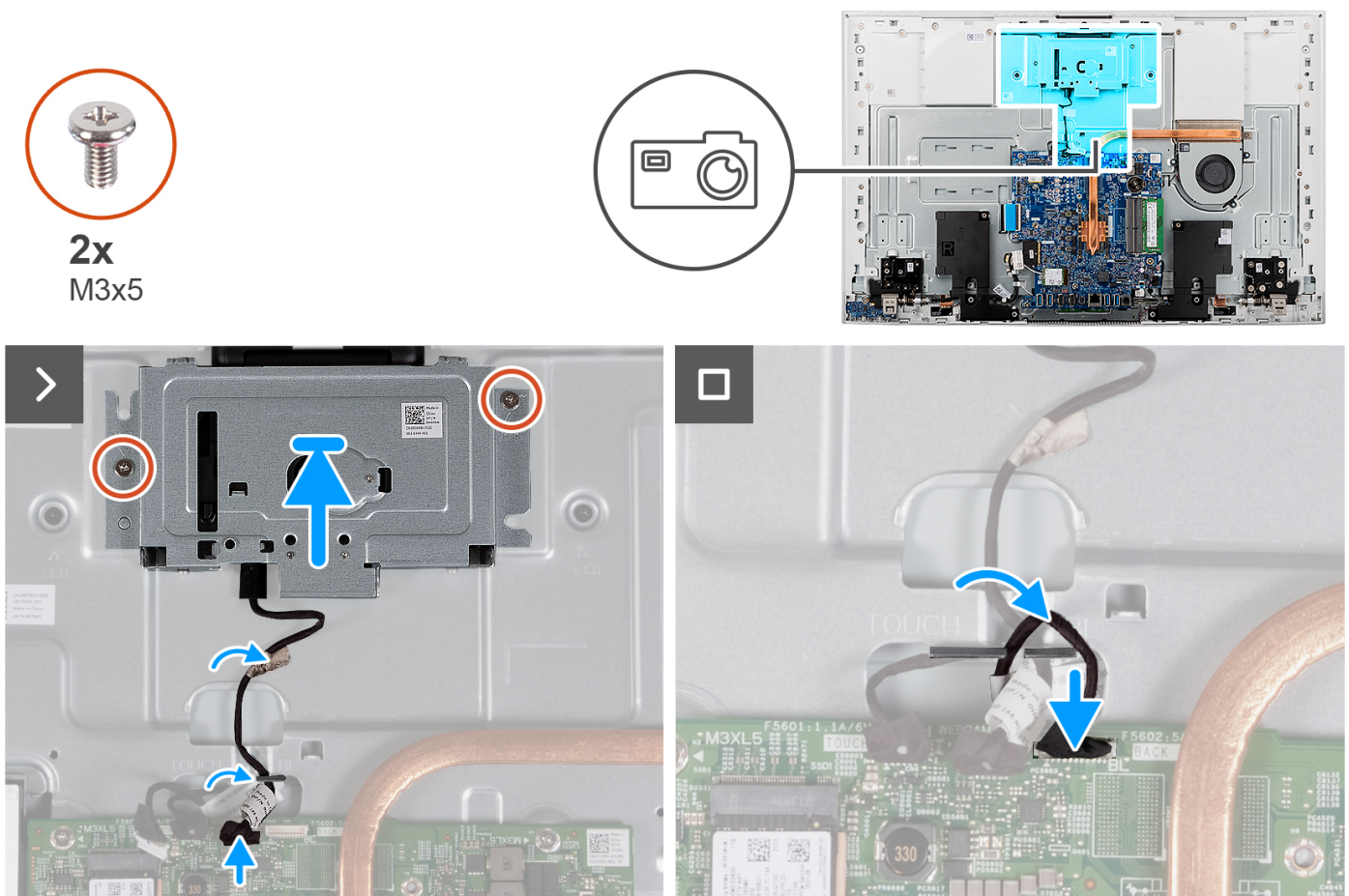

Figure 35. Installing the camera

Steps

1. Slide and place the retractable-camera assembly on the display-assembly base.
2. Replace the two screws (M3x5) that secure the retractable-camera assembly to the display-assembly base.
3. Adhere the tape that secures the camera cable to the display-assembly base.
4. Connect the camera cable to its connector (WEBCAM) on the system board.

Next steps

1. Install the [system-board shield](#).

2. Install the [I/O cover](#).
3. Install the [back cover](#).
4. Install the [stand](#).
5. Follow the procedure in [After working inside your computer](#).

Fan

Removing the fan

Prerequisites

1. Follow the procedure in [Before working inside your computer](#).
2. Remove the [stand](#).
3. Remove the [back cover](#).
4. Remove the [I/O cover](#).
5. Remove the [system-board shield](#).

About this task

The following image indicates the location of the fan and provides a visual representation of the removal procedure.

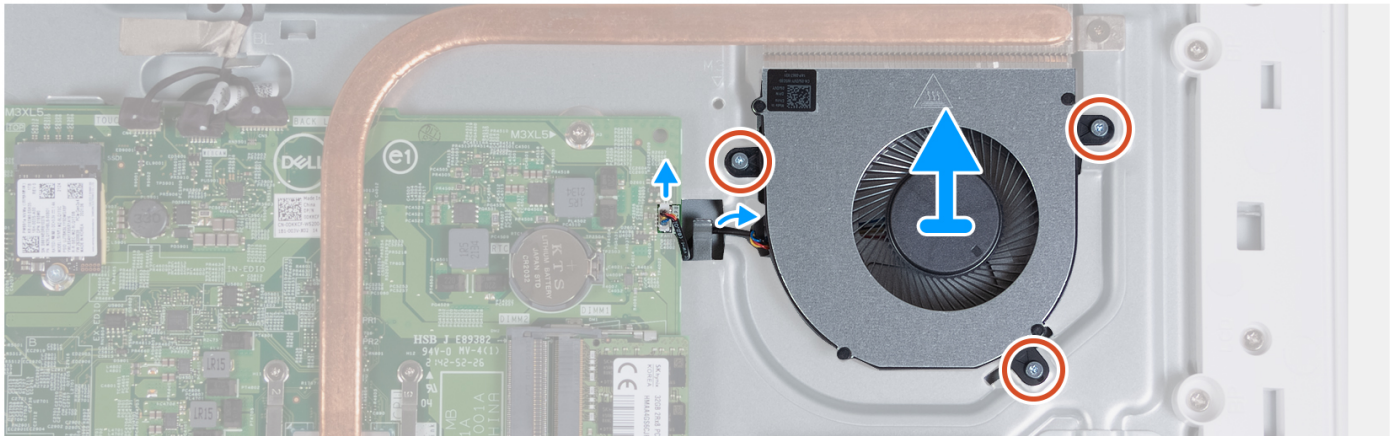
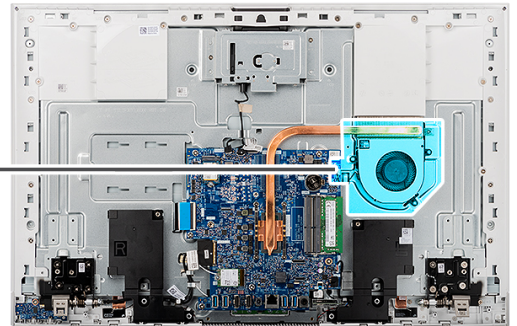
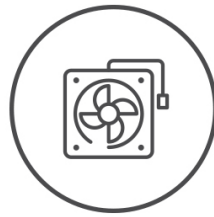
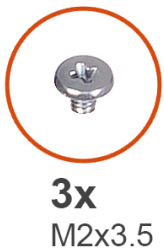

Figure 36. Removing the fan

Steps

1. Disconnect the fan cable from its connector (FAN1) on the system board.
2. Remove the fan cable from the routing post on the display-assembly base.
3. Remove the three screws (M2x3.5) that secure the fan to the display-assembly base.
4. Lift the fan, along with its cable, off the display-assembly base.

Installing the fan

Prerequisites

If you are replacing a component, remove the existing component before performing the installation procedure.

About this task

The following image indicates the location of the fan and provides a visual representation of the installation procedure.

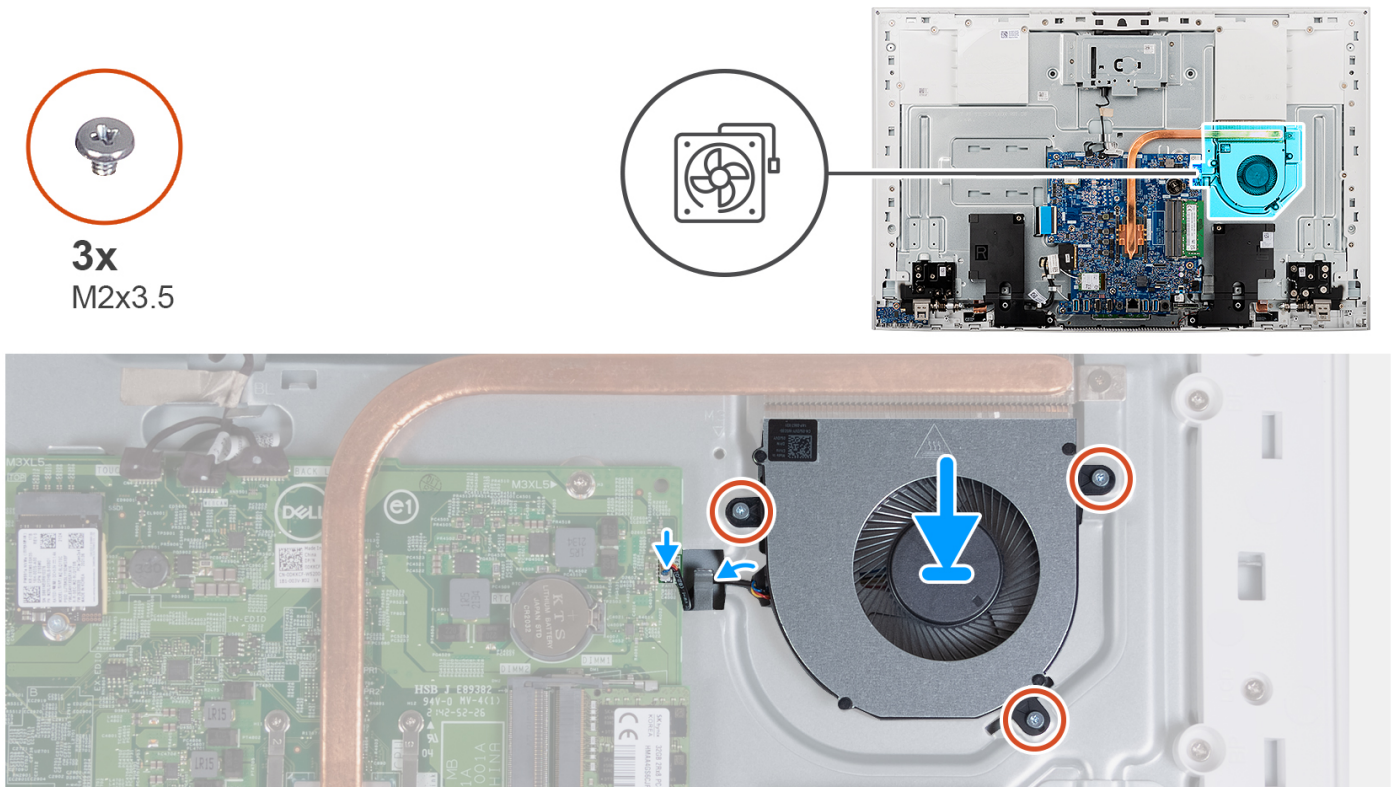

Figure 37. Installing the fan

Steps

1. Align the screw holes on the fan with the screw holes on the display-assembly base.
2. Replace the three screws (M2x3.5) that secure the fan to the display-assembly base.
3. Route the fan cable through the routing post on the display-assembly base.
4. Connect the fan cable to its connector (FAN1) on the system board.

Next steps

1. Install the [system-board shield](#).
2. Install the [I/O cover](#).
3. Install the [back cover](#).
4. Install the [stand](#).
5. Follow the procedure in [After working inside your computer](#).

Speakers

Removing the speakers

Prerequisites

1. Follow the procedure in [Before working inside your computer](#).
2. Remove the [stand](#).
3. Remove the [back cover](#).
4. Remove the [I/O cover](#).
5. Remove the [system-board shield](#).

About this task

The following image indicates the location of the speakers and provides a visual representation of the removal procedure.

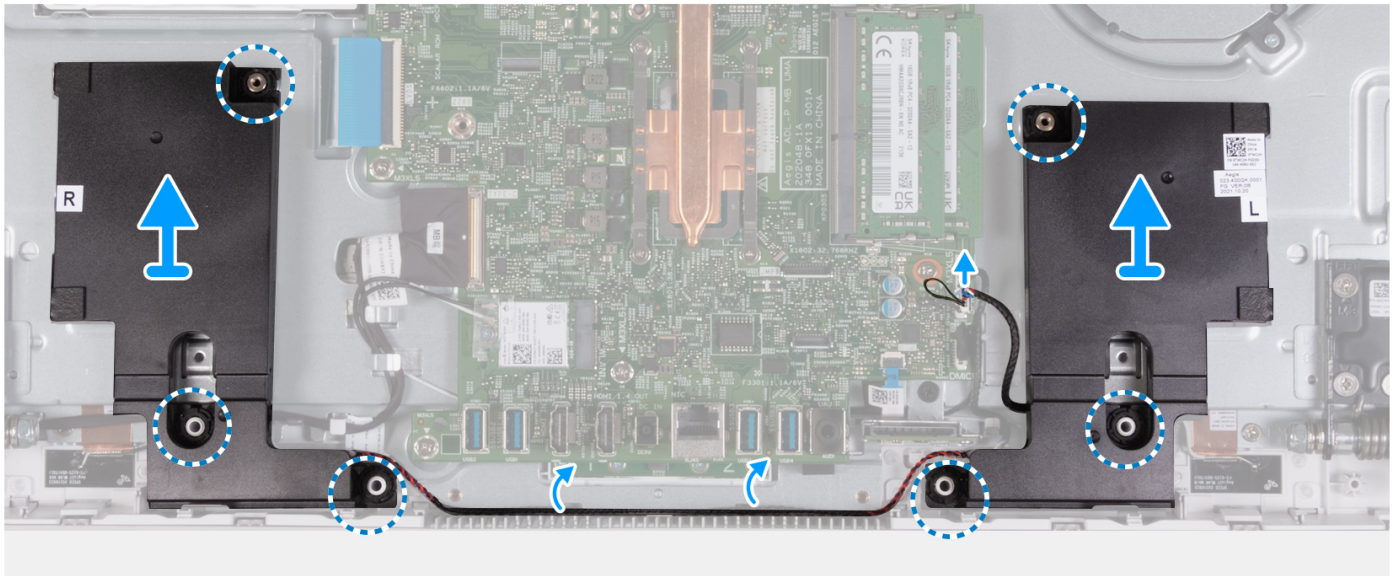
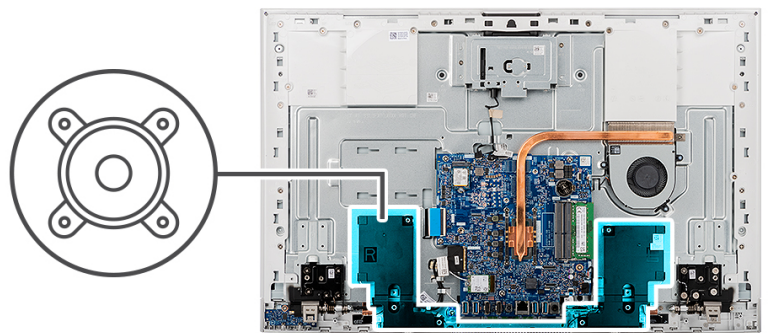

Figure 38. Removing the speakers

Steps

1. Disconnect the speaker cable from its connector (SPK1) the system board.
2. Remove the speaker cable from the routing guides on the display-assembly base.
3. Lift the speakers along with the cable off the display-assembly base.

Installing the speakers

Prerequisites

If you are replacing a component, remove the existing component before performing the installation procedure.

About this task

The following image indicates the location of the speakers and provides a visual representation of the installation procedure.

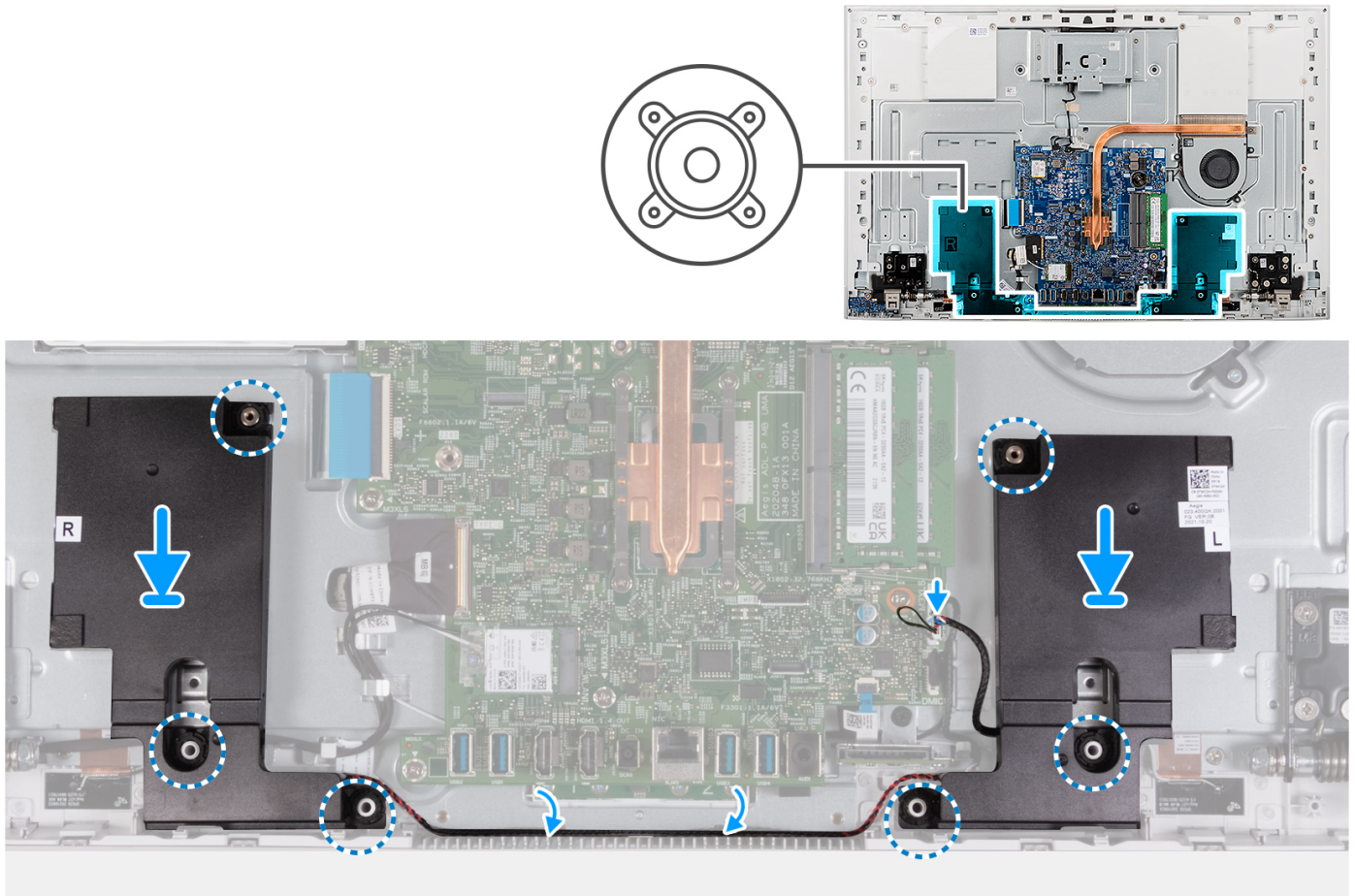

Figure 39. Installing the speakers

Steps

1. Using the alignment posts and rubber grommets, place the speakers on the slots on the display-assembly base.
2. Route the speaker cable through the routing guide on the display-assembly base.
3. Connect the speaker cable to its connector (SPK1) on the system board.

Next steps

1. Install the [system-board shield](#).
2. Install the [I/O cover](#).
3. Install the [back cover](#).
4. Install the [stand](#).
5. Follow the procedure in [After working inside your computer](#).

Coin-cell battery

Removing the coin-cell battery

Prerequisites

1. Follow the procedure in [Before working inside your computer](#).
2. Remove the [stand](#).
3. Remove the [back cover](#).
4. Remove the [I/O cover](#).
5. Remove the [system-board shield](#).

About this task

The following image indicates the location of the coin-cell battery and provides a visual representation of the removal procedure.

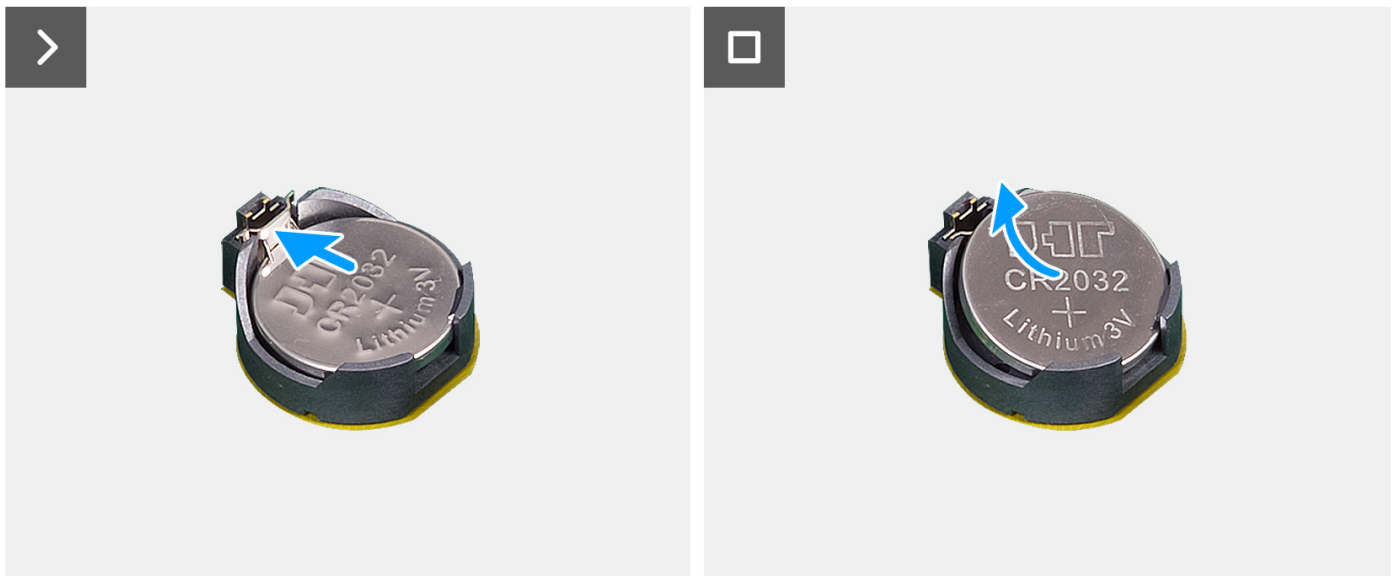
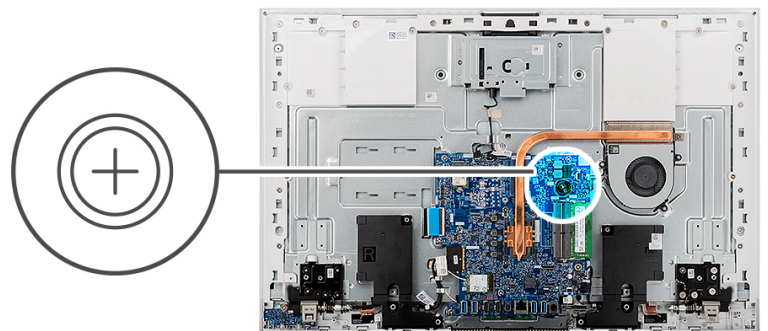

Figure 40. Removing the coin-cell battery

Steps

1. Press the metal tab to release the coin-cell battery from the coin-cell battery socket.
2. Lift the coin-cell battery from the coin-cell battery socket.

Installing the coin-cell battery

Prerequisites

If you are replacing a component, remove the existing component before performing the installation procedure.

About this task

The following image indicates the location of the coin-cell battery and provides a visual representation of the installation procedure.

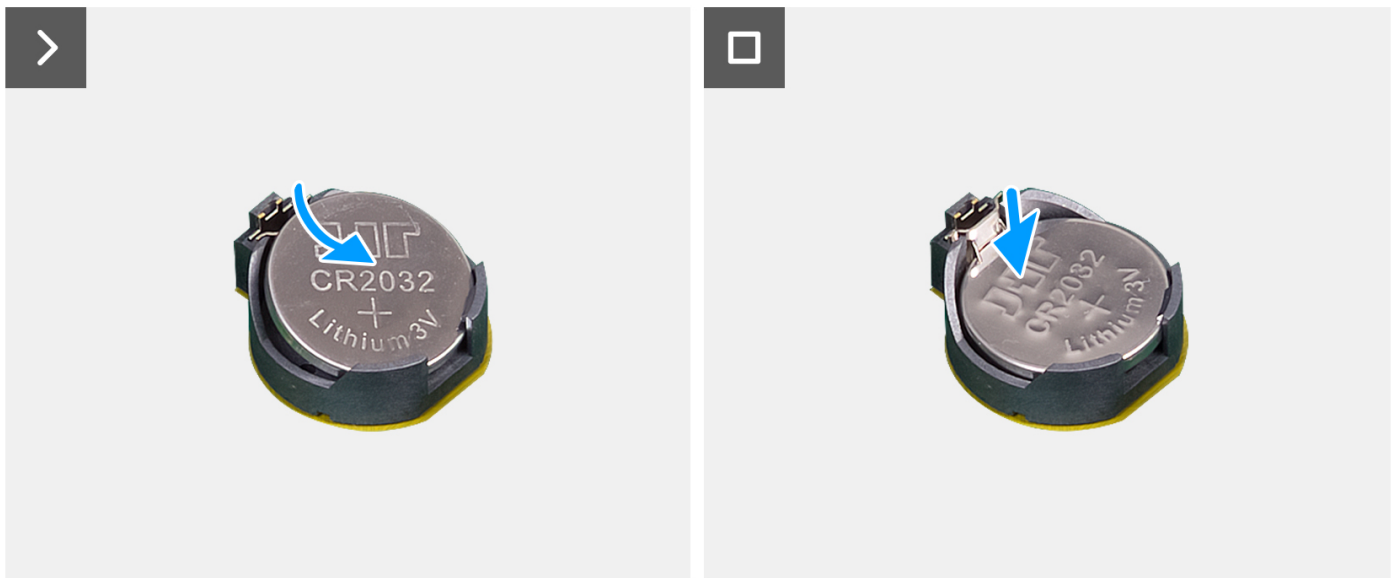
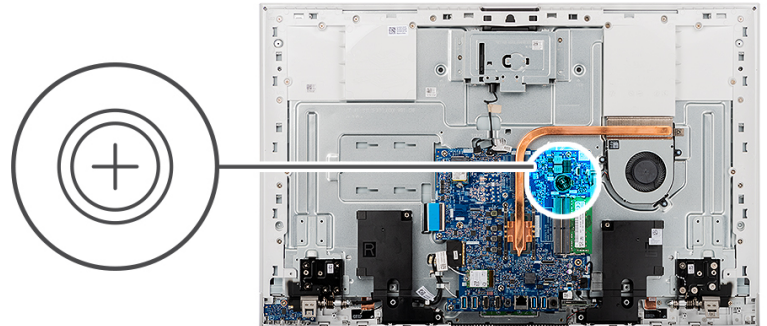

Figure 41. Installing the coin-cell battery

Steps





With the positive-side facing up, insert the coin-cell battery into the battery socket on the system board and snap the battery into place.

Next steps

1. Install the [system-board shield](#).
2. Install the [I/O cover](#).
3. Install the [back cover](#).
4. Install the [stand](#).
5. Follow the procedure in [After working inside your computer](#).

Removing and installing Field Replaceable Units (FRUs)

The replaceable components in this chapter are Field Replaceable Units (FRUs).

-  **CAUTION:** The information in this removing and installing FRU's section is intended for authorized service technicians only.
-  **CAUTION:** To avoid any potential damage to the component or loss of data, ensure that an authorized service technician replaces the Field Replaceable Units (FRUs).
-  **CAUTION:** Dell Technologies recommends that this set of repairs, if needed, to be conducted by trained technical repair specialists.
-  **CAUTION:** As a reminder, your warranty does not cover damages that may occur during FRU repairs that are not authorized by Dell Technologies.

 **NOTE:** The images in this document may differ from your computer depending on the configuration you ordered.

Heat sink

Removing the heat sink- UMA

 **CAUTION:** The information in this section is intended for authorized service technicians only.

Prerequisites

1. Follow the procedure in [Before working inside your computer](#).
2. Remove the [stand](#).
3. Remove the [back cover](#).
4. Remove the [I/O cover](#).
5. Remove the [system-board shield](#).

About this task

The following image indicates the location of the heat sink and provides a visual representation of the removal procedure.

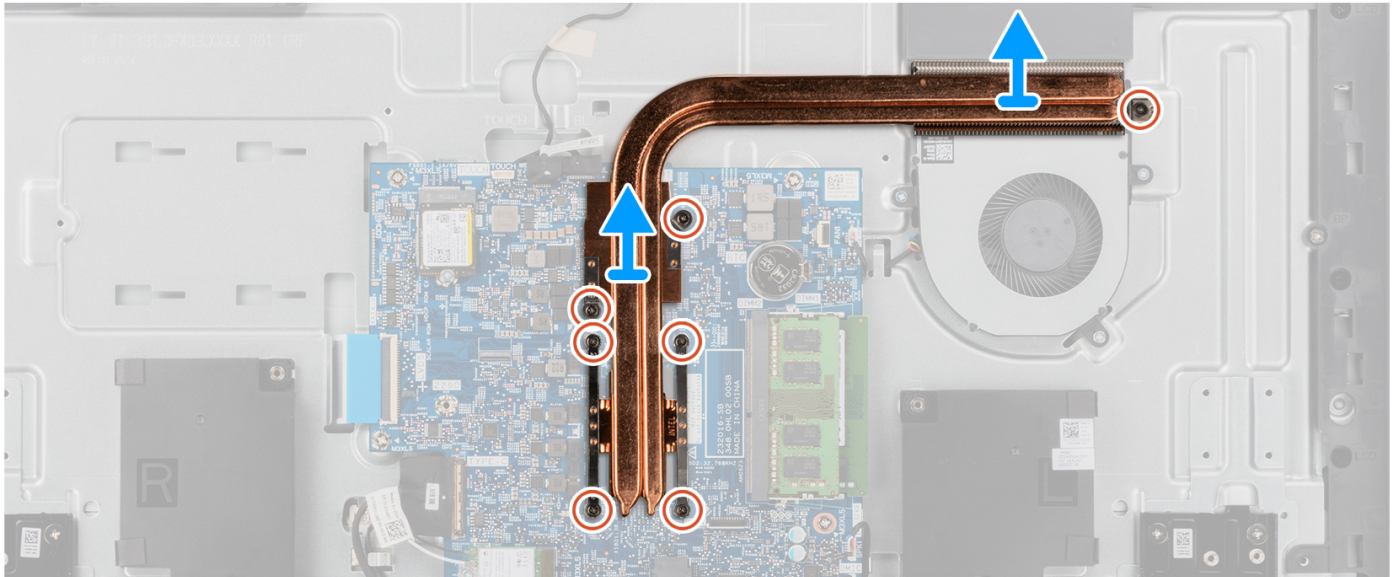

Figure 42. Removing the heat sink- UMA

Steps

1. In reverse sequential order (5>4>3>2>1), loosen the five captive screws that secure the heat sink to the system board.
2. Lift the heat sink off the system board.

Installing the heat sink- UMA

 **CAUTION:** The information in this section is intended for authorized service technicians only.

Prerequisites

If you are replacing a component, remove the existing component before performing the installation procedure.

 **NOTE:** If either the system board or the heat sink is replaced, use the thermal pad or paste provided in the service kit. The thermal pad or paste ensures that the thermal conductivity is achieved.

About this task

The following image indicates the location of the heat sink and provides a visual representation of the installation procedure.

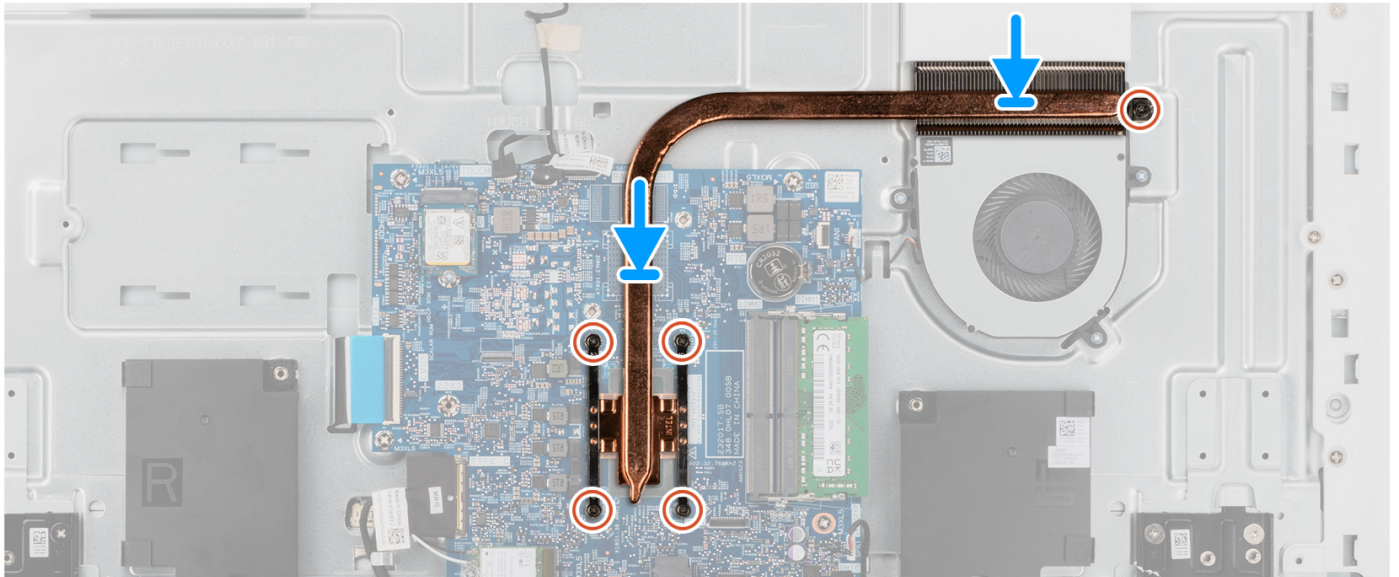

Figure 43. Installing the heat sink- UMA

Steps

1. Align the screw holes on the heat sink with the screw holes on the system board.
2. In sequential order (1>2>3>4>5), tighten the five captive screws that secure the heat sink to the system board.

Next steps

1. Install the [system-board shield](#).
2. Install the [I/O cover](#).
3. Install the [back cover](#).
4. Install the [stand](#).
5. Follow the procedure in [After working inside your computer](#).

Removing the heat sink- discrete

 **CAUTION:** The information in this section is intended for authorized service technicians only.

Prerequisites

1. Follow the procedure in [Before working inside your computer](#).
2. Remove the [stand](#).
3. Remove the [back cover](#).
4. Remove the [I/O cover](#).
5. Remove the [system-board shield](#).

About this task

The following image indicates the location of the heat sink and provides a visual representation of the removal procedure.

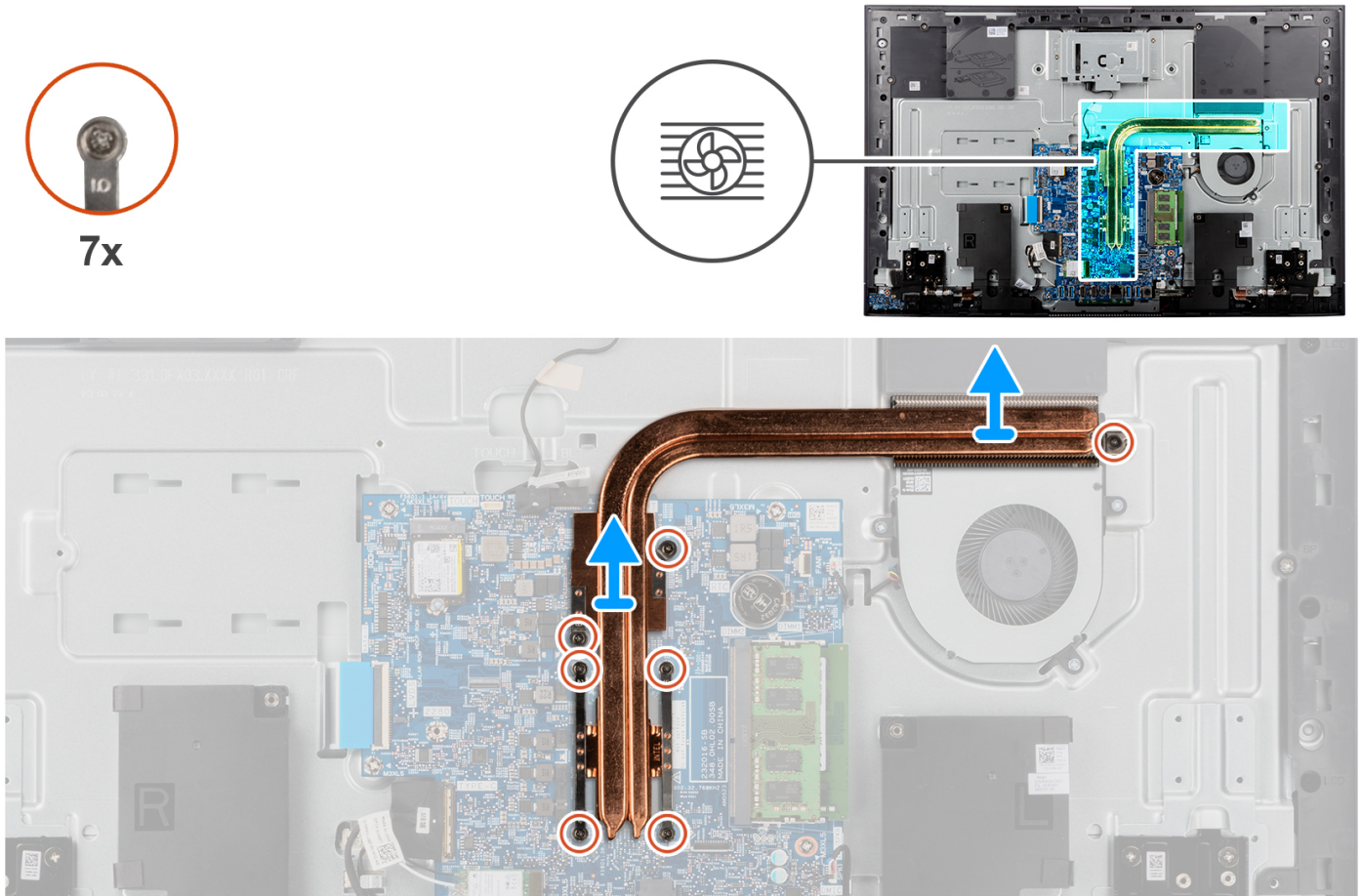

Figure 44. Removing the heat sink- discrete

Steps

1. In reverse sequential order (7>6>5>4>3>2>1), loosen the seven captive screws that secure the heat sink to the system board.
2. Lift the heat sink off the system board.

Installing the heat sink- discrete

CAUTION: The information in this section is intended for authorized service technicians only.

Prerequisites

If you are replacing a component, remove the existing component before performing the installation procedure.

NOTE: If either the system board or the heat sink is replaced, use the thermal pad or paste provided in the service kit. The thermal pad or paste ensures that the thermal conductivity is achieved.

About this task

The following image indicates the location of the heat sink and provides a visual representation of the installation procedure.

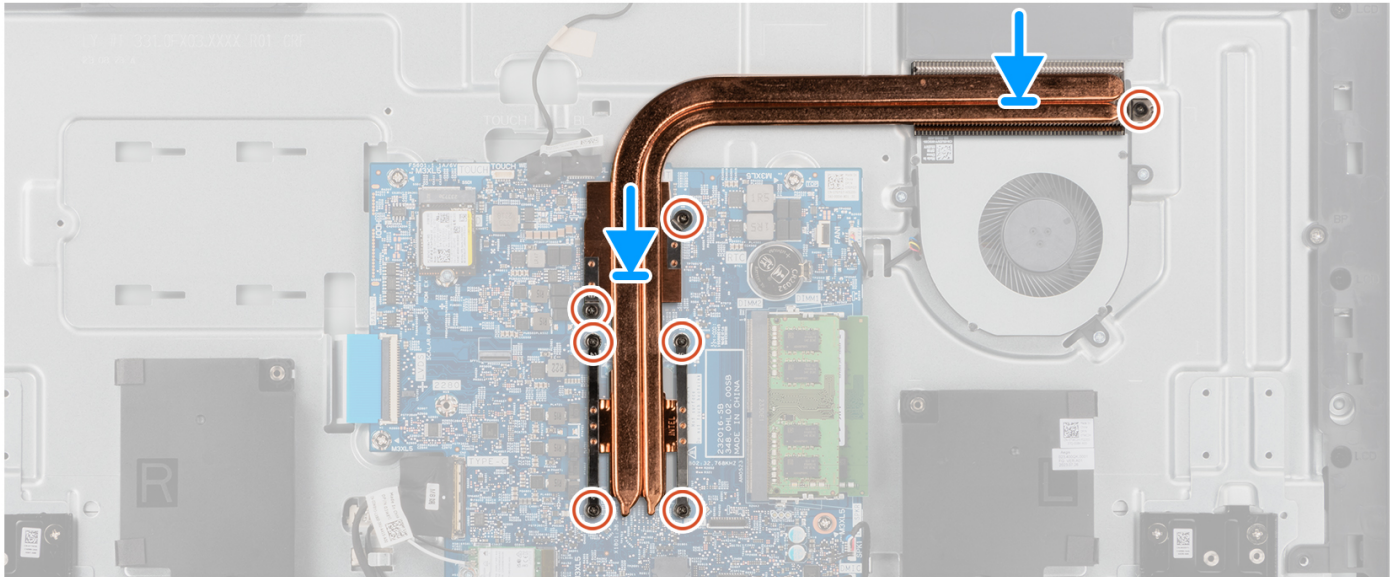

Figure 45. Installing the heat sink- discrete

Steps

1. Align the screw holes on the heat sink with the screw holes on the system board.
2. In sequential order (1>2>3>4>5>6>7), tighten the seven captive screws that secure the heat sink to the system board.

Next steps

1. Install the [system-board shield](#).
2. Install the [I/O cover](#).
3. Install the [back cover](#).
4. Install the [stand](#).
5. Follow the procedure in [After working inside your computer](#).

Media-card reader

Removing the media-card reader

⚠ CAUTION: The information in this section is intended for authorized service technicians only.

Prerequisites

1. Follow the procedure in [Before working inside your computer](#).
2. Remove the [stand](#).
3. Remove the [back cover](#).

4. Remove the I/O cover.
5. Remove the system-board shield.

About this task

The following image indicates the location of the media-card reader and provides a visual representation of the removal procedure.



1x
M3x3.5

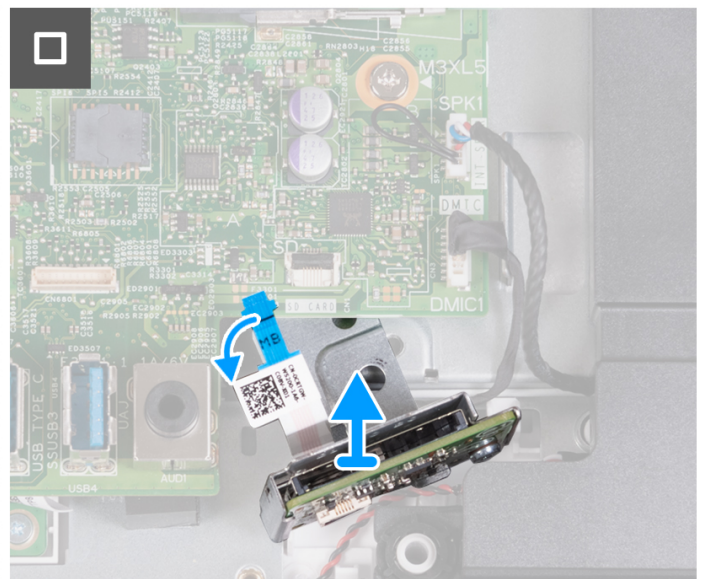
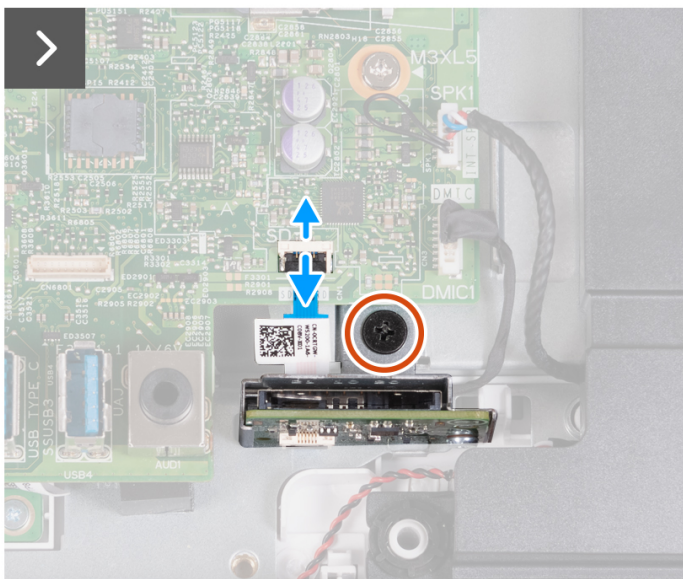

Figure 46. Removing the media-card reader

Steps

1. Remove the screw (M3x3.5) that secures the media-card reader to the display-assembly base.
2. Open the latch and disconnect the media-card reader cable from its connector (SD CARD) on the system board.
3. Gently slide and remove the media-card reader, along with its cable, from the media-card reader slot.

Installing the media-card reader

⚠ CAUTION: The information in this section is intended for authorized service technicians only.

Prerequisites

If you are replacing a component, remove the existing component before performing the installation procedure.

About this task

The following image indicates the location of the media-card reader and provides a visual representation of the installation procedure.



1x
M3x3.5

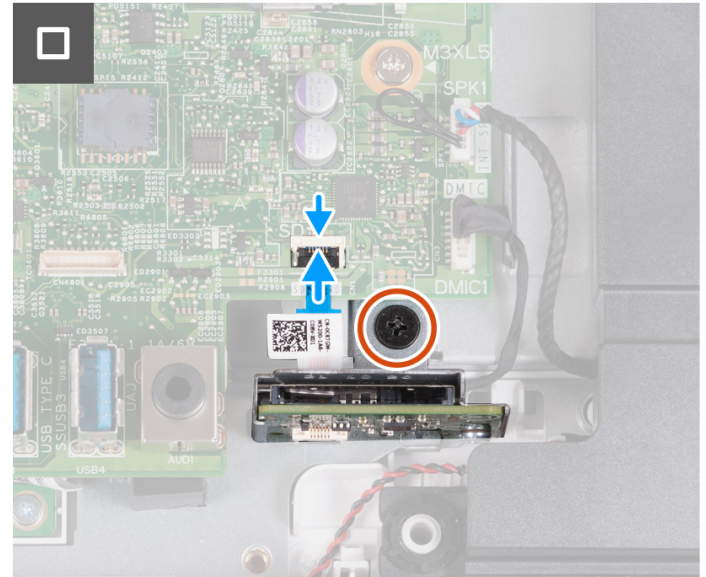
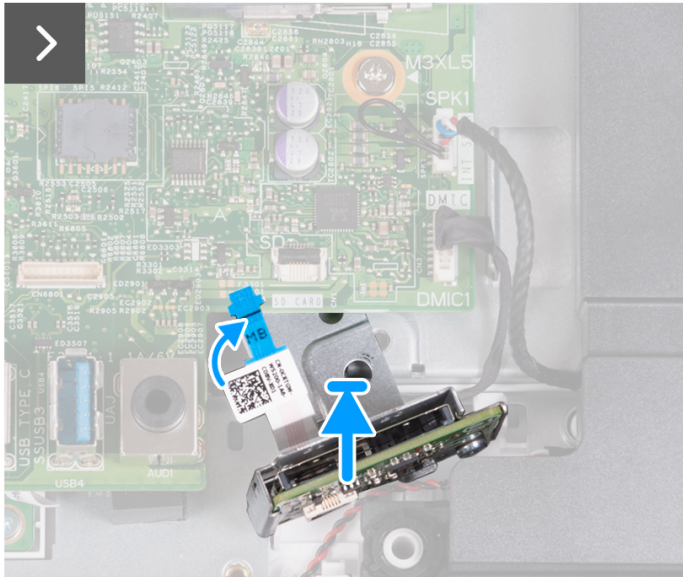

Figure 47. Installing the media-card reader

Steps

1. Slide the media-card reader under the system board and align the screw hole on the media-card reader with the screw hole on the display-assembly base.

NOTE: Ensure that the media-card reader cable stays above the system board.

2. Connect the media-card reader cable to its connector (DS CARD) on the system board and close the latch to secure the cable.
3. Replace the screw (M3x3.5) that secures the media-card reader to the display-assembly base.

Next steps

1. Install the [system-board shield](#).
2. Install the [I/O cover](#).
3. Install the [back cover](#).
4. Install the [stand](#).
5. Follow the procedure in [After working inside your computer](#).

Power-button board with USB

Removing the power-button board with USB

CAUTION: The information in this section is intended for authorized service technicians only.

Prerequisites

1. Follow the procedure in [Before working inside your computer](#).
2. Remove the [stand](#).
3. Remove the [back cover](#).
4. Remove the [I/O cover](#).
5. Remove the [system-board shield](#).

About this task

The following image indicates the location of the power-button board with USB and provides a visual representation of the removal procedure.



5x
M3x4.5



1x
M3x5

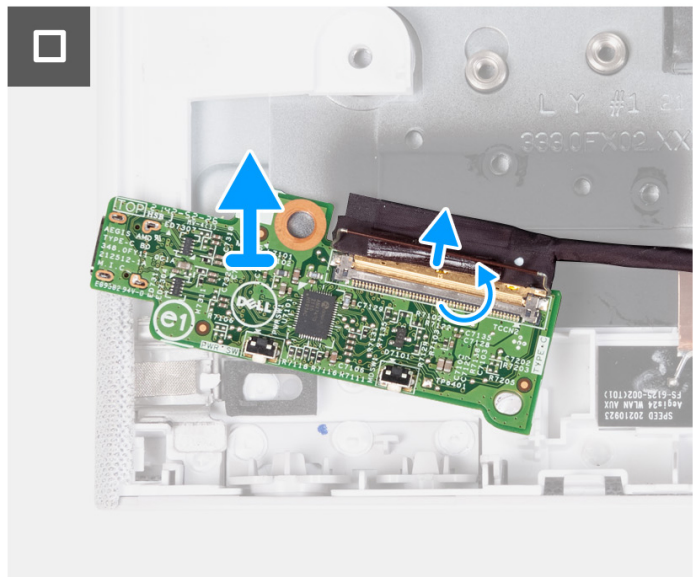
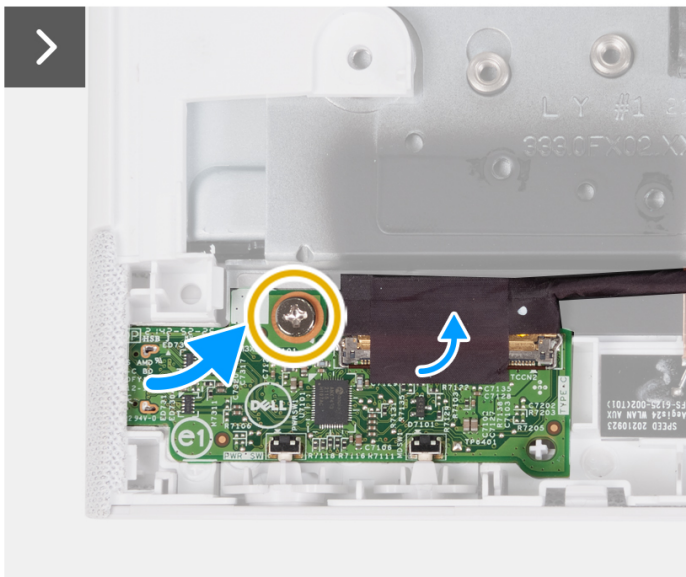
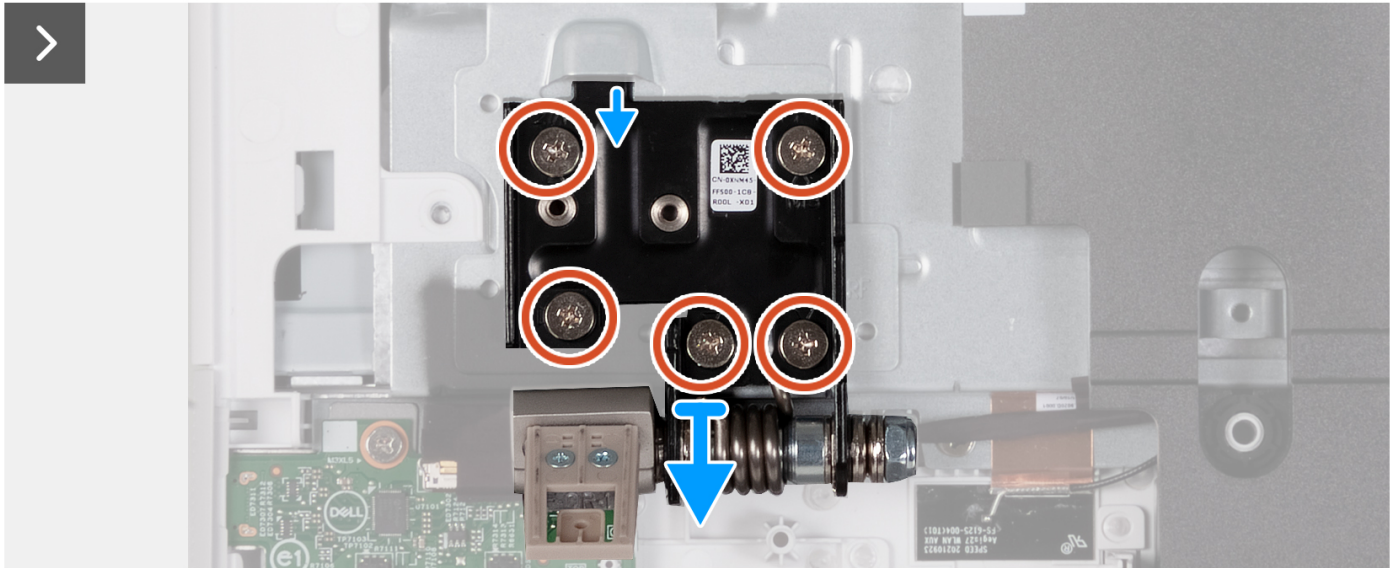

Figure 48. Removing the power-button board with USB

Steps

1. Remove the five screws (M3x4.5) that secure the left-stand hinge to the display-assembly base.
2. Lift the left-stand hinge off the display-assembly base.
3. Remove the screw (M3x5) that secures the power-button board to the display-assembly base.
4. Peel the tape that secures the power-button board cable to the power-button board.
5. Gently lift the power-button board from the tabs on the display-assembly base.
6. Open the latch and disconnect the power-button board cable from its connector (TYPE-C) on the power-button board.

7. Lift the power-button board off the display-assembly base.

Installing the power-button board with USB

 **CAUTION:** The information in this section is intended for authorized service technicians only.

Prerequisites

If you are replacing a component, remove the existing component before performing the installation procedure.

About this task

The following image indicates the location of the power-button board with USB and provides a visual representation of the installation procedure.



6x
M3x4.5



1x
M3x5

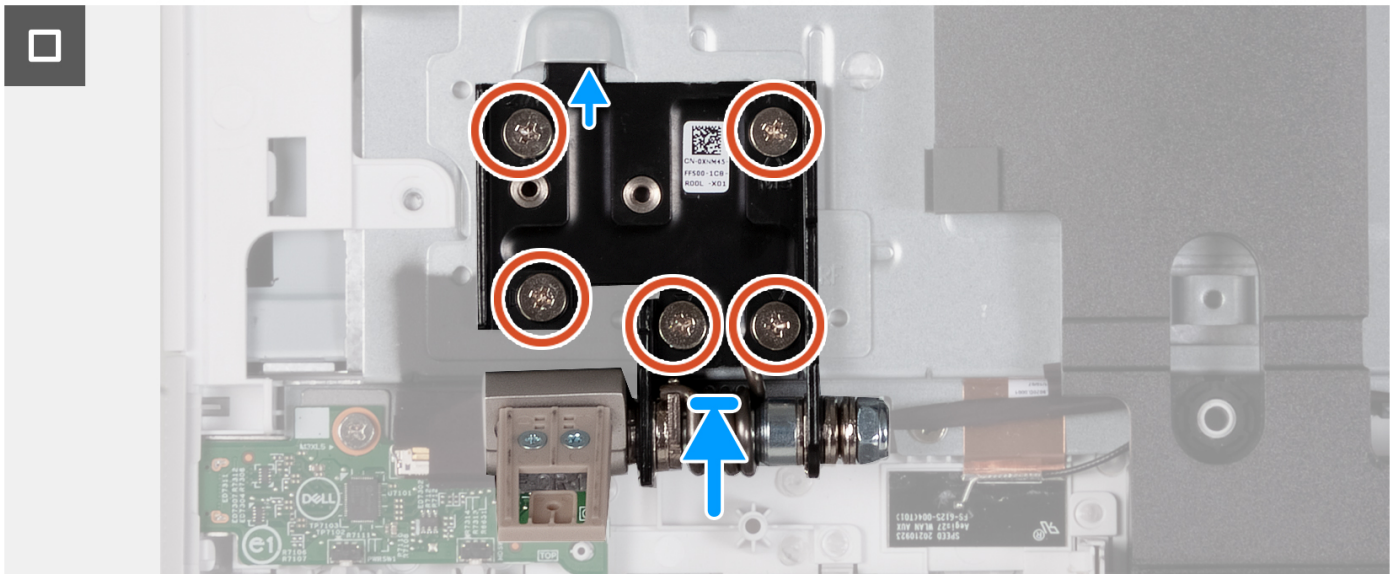
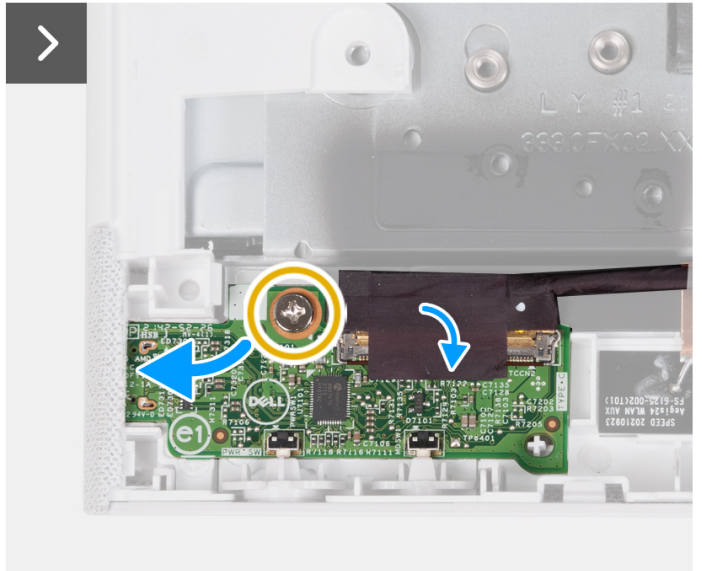
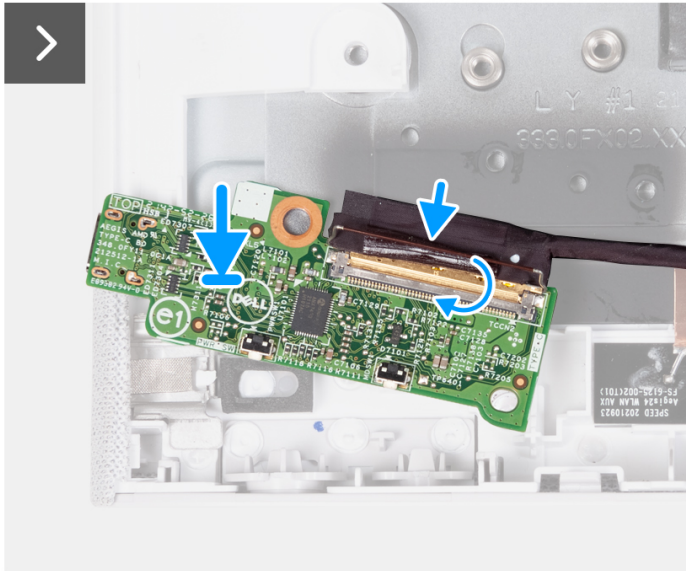
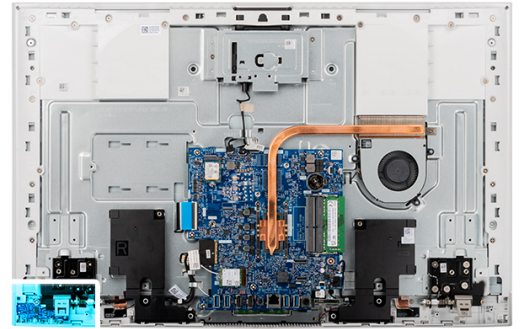

Figure 49. Installing the power-button board with USB

Steps

1. Connect the power-button board cable to its connector (TYPE-C) on the power-button board and close the latch to secure the cable.
2. Using the alignment tabs as reference, align and place the power-button board in the slot on the display-assembly base.
3. Replace the screw (M3x5) that secures the power-button board to the display-assembly base.
4. Adhere the tape that secures the power-button cable to the power-button board.
5. Align and place the left-stand hinge on the display-assembly base.

6. Replace the five screws (M3x4.5) that secure the left-stand hinge to the display-assembly base.

Next steps





1. Install the [system-board shield](#).
2. Install the [I/O cover](#).
3. Install the [back cover](#).
4. Install the [stand](#).
5. Follow the procedure in [After working inside your computer](#).

System board

Removing the system board

 **CAUTION:** The information in this section is intended for authorized service technicians only.

Prerequisites

-  **NOTE:** Your computer's Service Tag is stored in the system board. You must enter the Service Tag in the BIOS setup program after you replace the system board.
 -  **NOTE:** Replacing the system board removes any changes that you have made to the BIOS using the BIOS setup program. You must make the appropriate changes again after you replace the system board.
 -  **NOTE:** Before disconnecting the cables from the system board, note the location of the connectors so that you can reconnect the cables correctly after you replace the system board.
1. Follow the procedure in [Before working inside your computer](#).
 2. Remove the [stand](#).
 3. Remove the [back cover](#).
 4. Remove the [I/O cover](#).
 5. Remove the [system-board shield](#).
 6. Remove the [memory module](#).
 7. Remove the [wireless card](#).
 8. Remove the [M.2 2230 solid-state drive](#).
 9. Remove the [integrated heat sink](#) or [discrete heat sink](#), as applicable.
-  **NOTE:** The system board can be removed and installed along with the heat sink. This simplifies the removal and installation procedure and avoids breaking the thermal bond between the system board and heat sink.

About this task

The following image indicates the connectors on your system board.

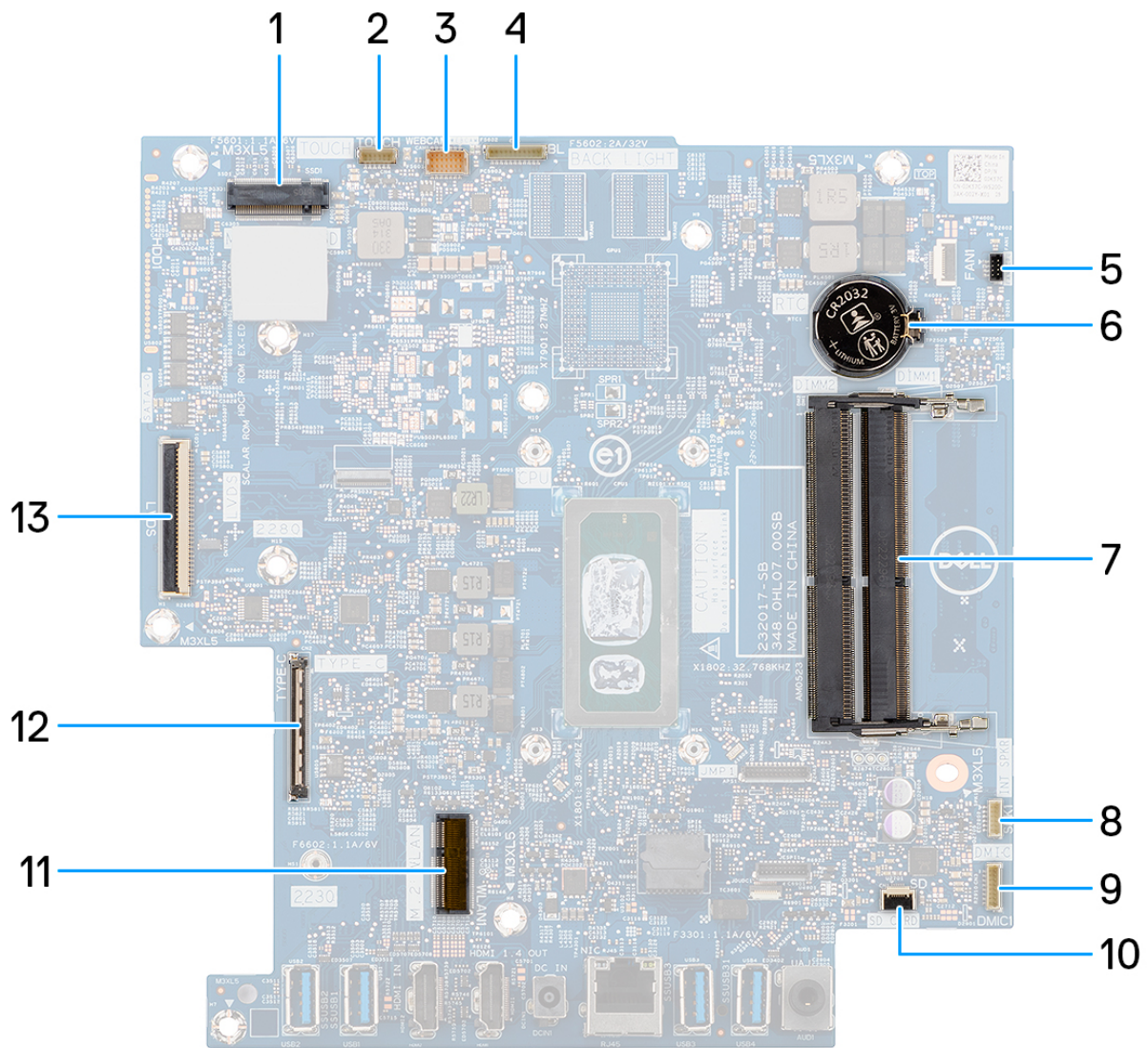

Figure 50. System-board connectors

- | | |
|--|---|
| 1. Solid-state drive slot (M.2 PCIe SSD) | 2. Touchscreen-cable connector (optional) (TOUCH) |
| 3. Camera-cable connector (WEBCAM) | 4. Backlight-cable connector (BL) |
| 5. Fan-cable connector (FAN1) | 6. Coin-cell battery (RTC) |
| 7. Memory-module slots (DIMM2, DIMM1) | 8. Speaker-cable connector (SPK1) |
| 9. Microphone-module cable connector (DMIC1) | 10. Media-card reader cable connector (SD CARD) |
| 11. Wireless-card slot (M.2 WLAN) | 12. Power-button board cable connector (TYPE-C) |
| 13. Display-cable connector (LVDS) | |

The following image indicates the location of the system board and provides a visual representation of the removal procedure.



6x
M3x5



1x
M3x4

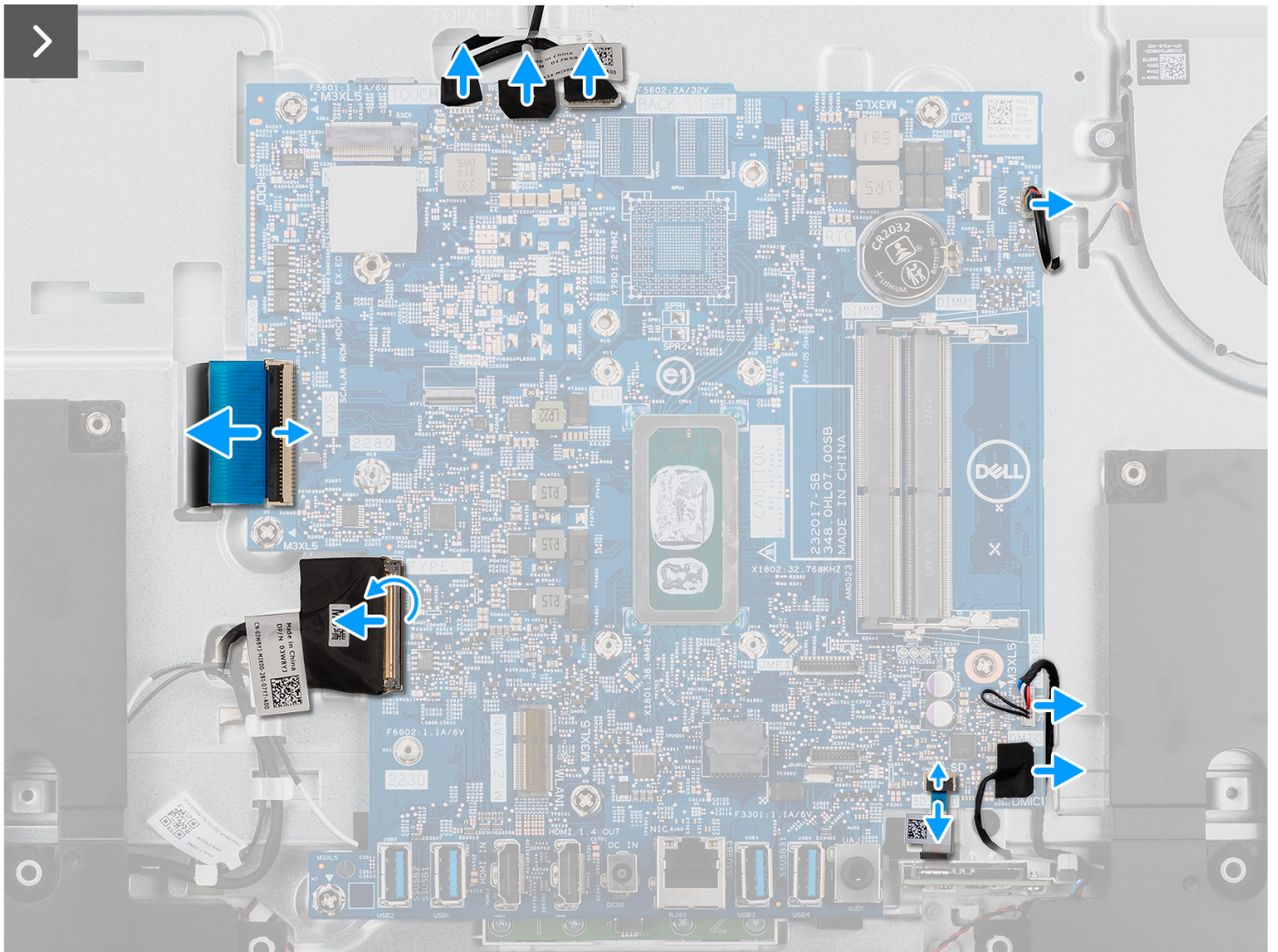
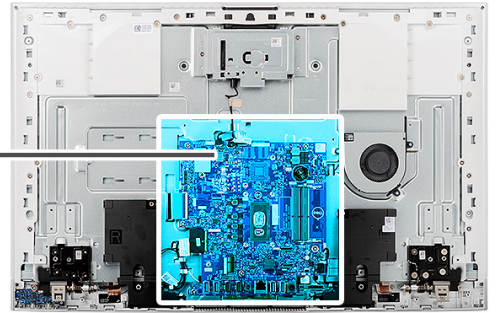

Figure 51. Removing the system board

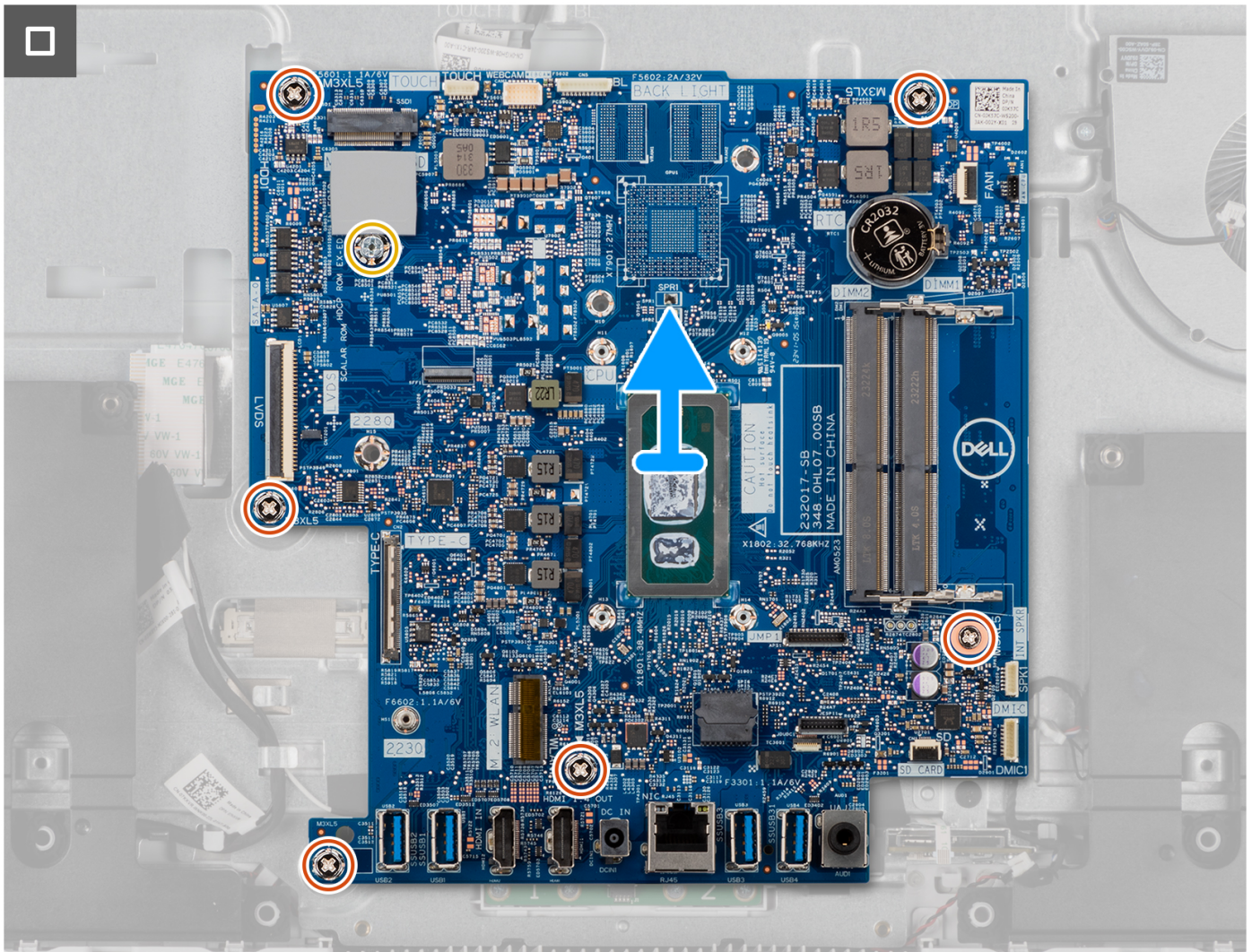

Figure 52. Lifting the system board off the chassis

Steps

1. Disconnect the touchscreen cable from its connector (TOUCH) on the system board.
 - i** **NOTE:** This cable is only available on computers that support the touch option.
2. Disconnect the camera cable from its connector (WEBCAM) on the system board.
3. Disconnect the backlight cable from its connector (BL) on the system board.
4. Disconnect the fan cable from its connector (FAN1) on the system board.
5. Disconnect the speaker cable from its connector (SPK1) on the system board.
6. Disconnect the microphone-module cable from its connector (DMIC1) on the system board.
7. Open the latch and disconnect the media-card reader cable from its connector (SD CARD) on the system board.
8. Open the latch and disconnect the power-button board cable from its connector (TYPE-C) on the system board.
9. Open the latch and disconnect the display cable from its connector (LVDS) on the system board.
10. Remove the six screws (M3x5) that secure the system board to the display-assembly base.
11. Remove the solid-state drive screw mount (M3x4) that secures the system board to the display-assembly base.
12. Lift the system board off the display-assembly base.

Installing the system board

CAUTION: The information in this section is intended for authorized service technicians only.

Prerequisites

If you are replacing a component, remove the existing component before performing the installation procedure.

About this task

The following image indicates its connectors on your system board.

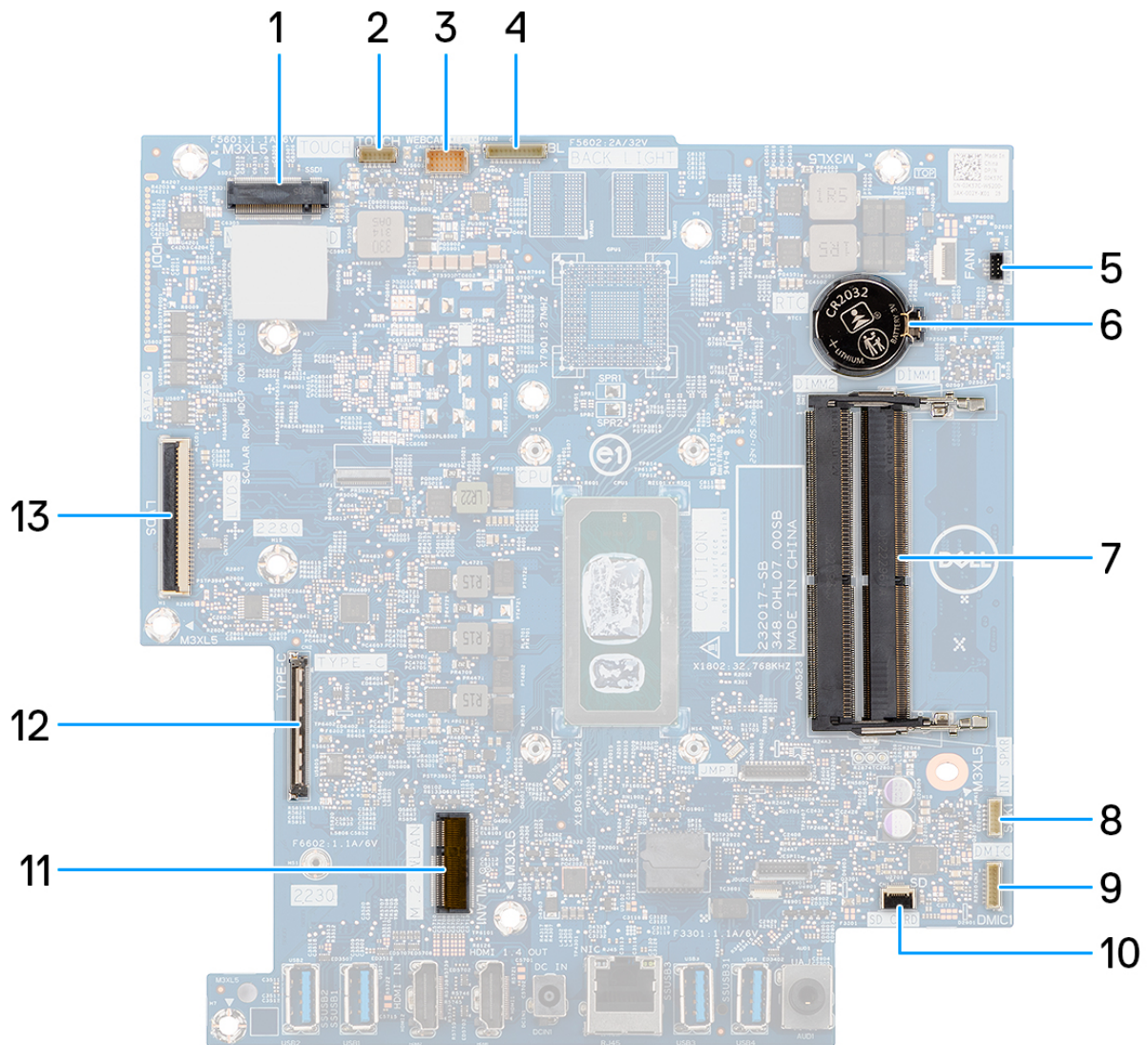

Figure 53. System-board connectors

- 1. Solid-state drive slot (M.2 PCIe SSD)
- 2. Touchscreen-cable connector (optional) (TOUCH)
- 3. Camera-cable connector (WEBCAM)
- 4. Backlight-cable connector (BL)
- 5. Fan cable connector (FAN1)
- 6. Coin-cell battery (RTC)
- 7. Memory-module slots (DIMM2, DIMM1)
- 8. Speaker-cable connector (SPK1)
- 9. Microphone-module cable connector (DMIC1)
- 10. Media-card reader cable connector (SD CARD)
- 11. Wireless-card slot (M.2 WLAN)
- 12. Power-button board cable connector (TYPE-C)
- 13. Display-cable connector (LVDS)

The following image indicates the location of the system board and provides a visual representation of the installation procedure.

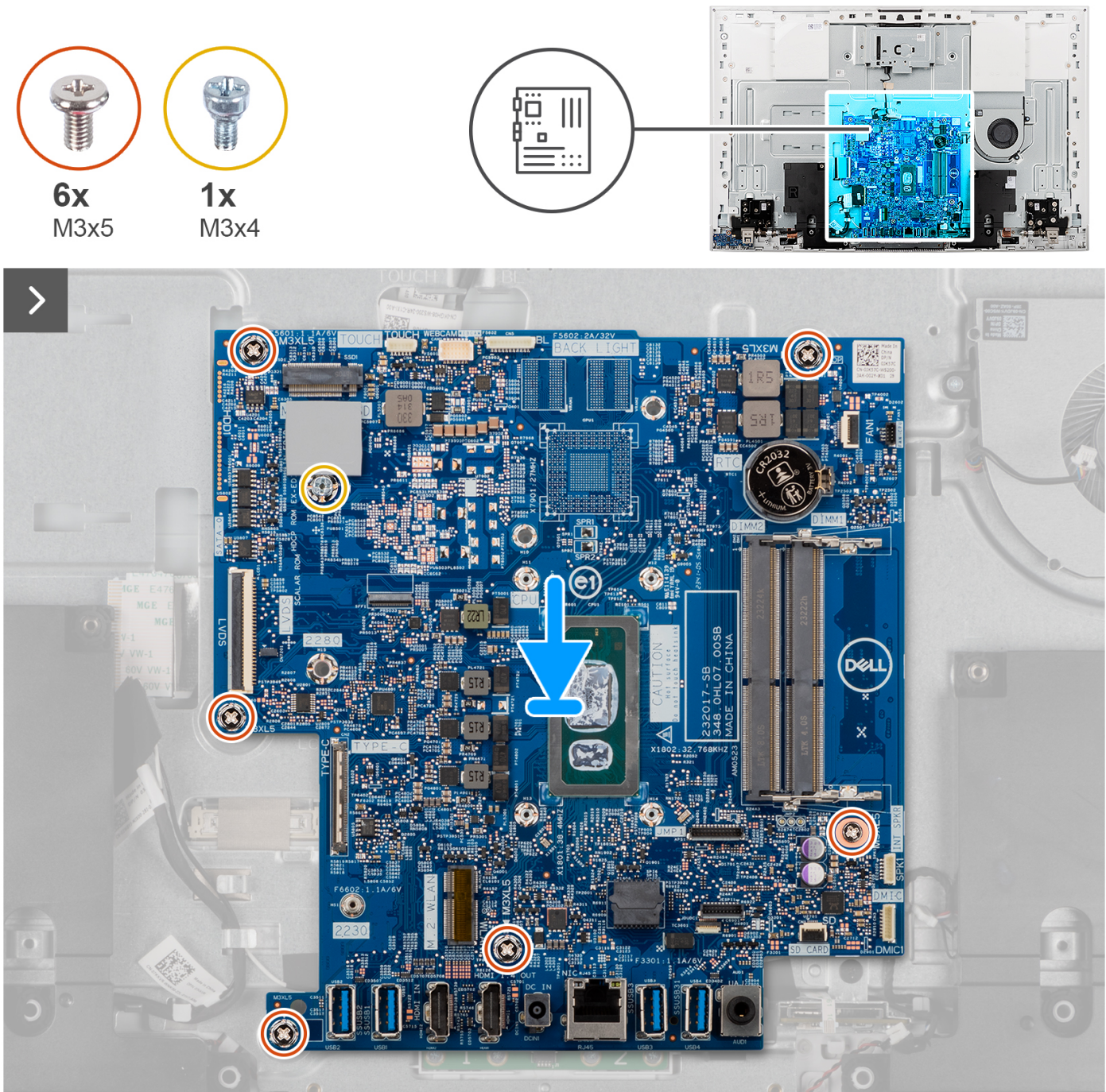

Figure 54. Placing the system board in the chassis

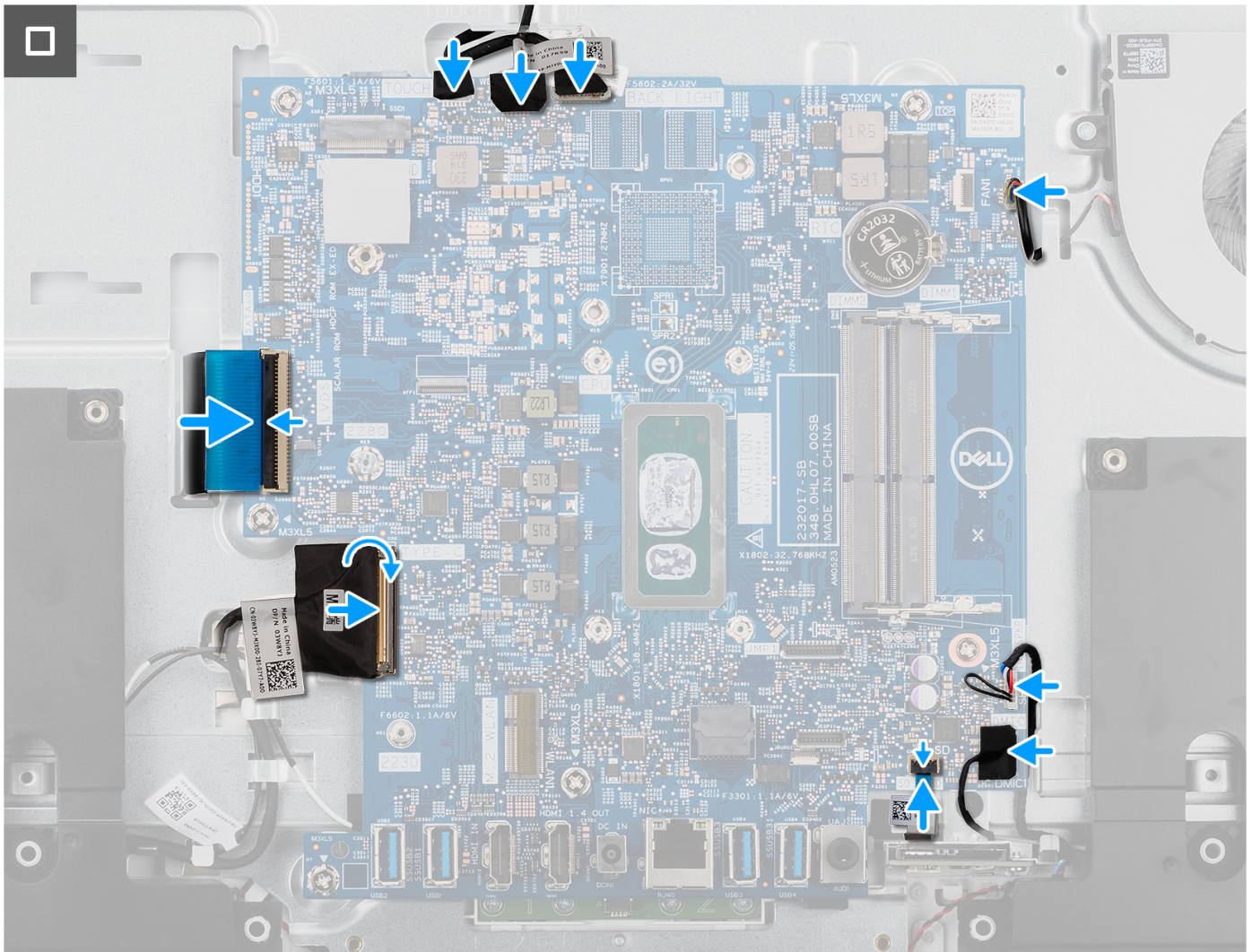

Figure 55. Installing the system board

Steps

1. Place the system board on the display-assembly base.
2. Align the screw holes on the system board with the screw holes on the display-assembly base.
3. Replace the six screws (M3x5) that secure the system board to the display-assembly base.
4. Replace the solid-state drive screw mount (M3x4) that secures the system board to the display-assembly base.
5. Connect the display cable to its connector (LVDS) on the system board and close the latch to secure the cable.
6. Connect the power-button board cable to its connector (TYPE-C) on the system board and close the latch to secure the cable.
7. Connect the media-card reader cable to its connector (SD CARD) on the system board and close the latch to secure the cable.
8. Connect the microphone-module cable to its connector (DMIC1) on the system board.
9. Connect the speaker cable to its connector (SPK1) on the system board.
10. Connect the fan cable to its connector (FAN1) on the system board.
11. Connect the backlight cable to its connector (BL) on the system board.
12. Connect the camera cable to its connector (WEBCAM) on the system board.
13. Connect the touchscreen cable to its connector (TOUCH) on the system board.

NOTE: This cable is only available on computers that support the touch option.

Next steps

1. Install the [integrated heat sink](#) or [discrete heat sink](#), as applicable.

i **NOTE:** The system board can be removed and installed along with the heat sink. This simplifies the removal and installation procedure and avoids breaking the thermal bond between the system board and heat sink.

2. Install the [M.2 2230 solid-state drive](#).
3. Install the [wireless card](#).
4. Install the [memory module](#).
5. Install the [system-board shield](#).
6. Install the [I/O cover](#).
7. Install the [back cover](#).
8. Install the [stand](#).
9. Follow the procedure in [After working inside your computer](#).

i **NOTE:** Your computer's Service Tag is stored in the system board. You must enter the Service Tag in the BIOS setup program after you replace the system board.

i **NOTE:** Replacing the system board removes any changes that you have made to the BIOS using the BIOS setup program. You must make the appropriate changes again after you replace the system board.

Microphones

Removing the microphones

⚠ **CAUTION:** The information in this section is intended for authorized service technicians only.

Prerequisites

1. Follow the procedure in [Before working inside your computer](#).
2. Remove the [stand](#).
3. Remove the [back cover](#).
4. Remove the [I/O cover](#).
5. Remove the [system-board shield](#).
6. Remove the [media-card reader](#).
7. Remove the [memory module](#).
8. Remove the [wireless card](#).
9. Remove the [M.2 2230 solid-state drive](#).
10. Remove the [integrated heat sink](#) or [discrete heat sink](#), as applicable.
11. Remove the [system board](#).

About this task

The following image indicates the location of the microphones and provides a visual representation of the removal procedure.



4x
M2x2.5

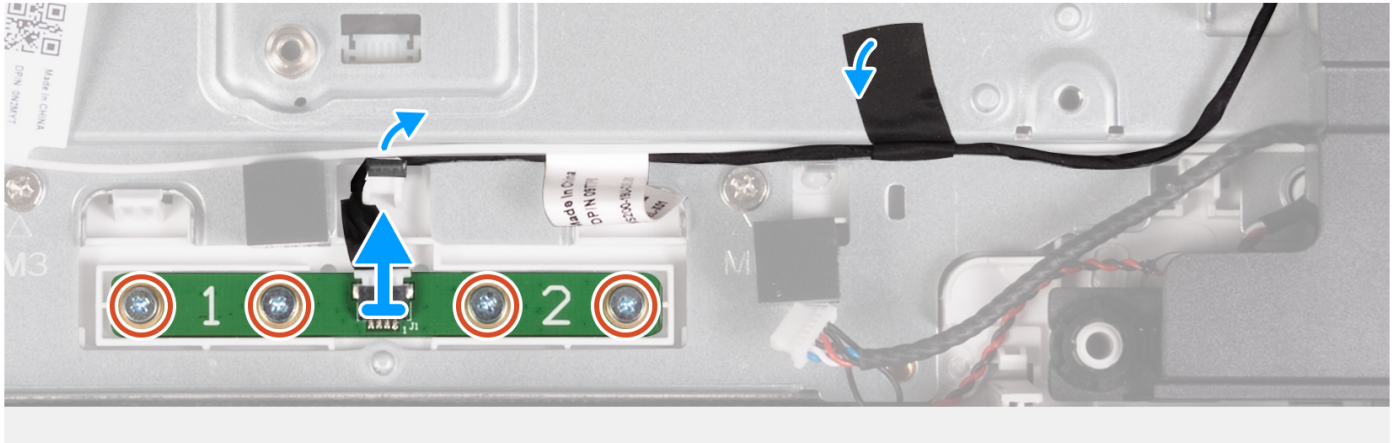
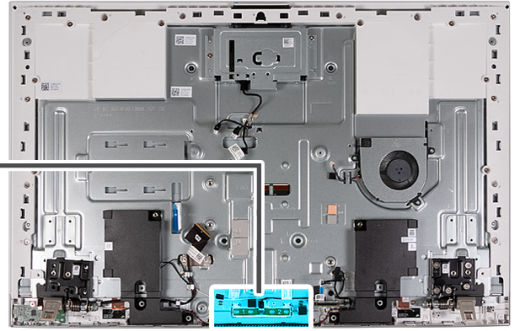

Figure 56. Removing the microphones

Steps

1. Remove the four screws (M2X3.5) that secure the microphone module to the display-assembly base.
2. Peel the tape that secures the microphone cable to the display-assembly base.
3. Remove the microphone cable from the routing guides on the display-assembly base.
4. Lift the microphone module off the display-assembly base.

Installing the microphones

⚠ CAUTION: The information in this section is intended for authorized service technicians only.

Prerequisites

If you are replacing a component, remove the existing component before performing the installation procedure.

About this task

The following image indicates the location of the microphones and provides a visual representation of the installation procedure.



4x
M2x2.5

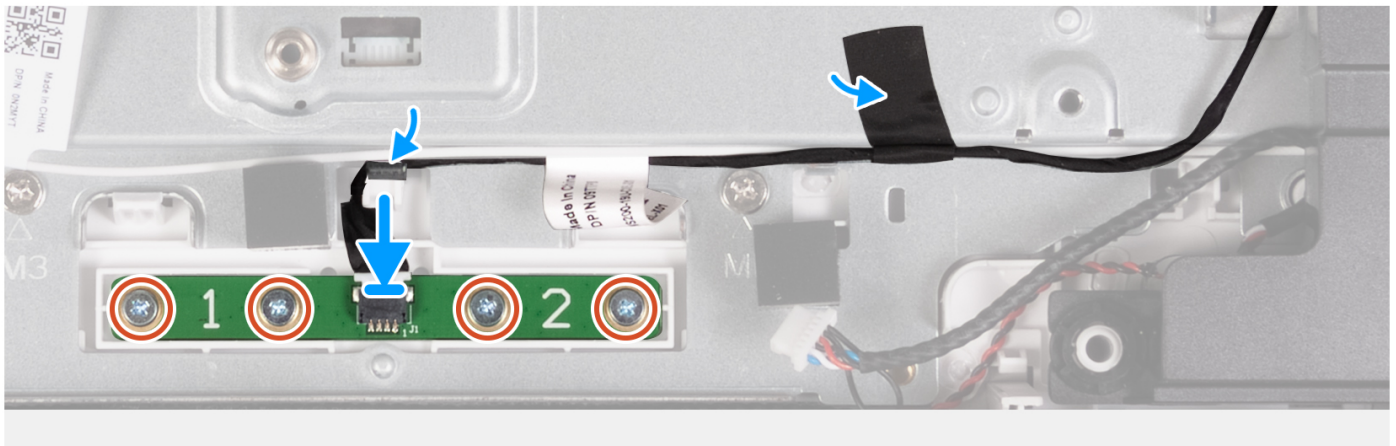
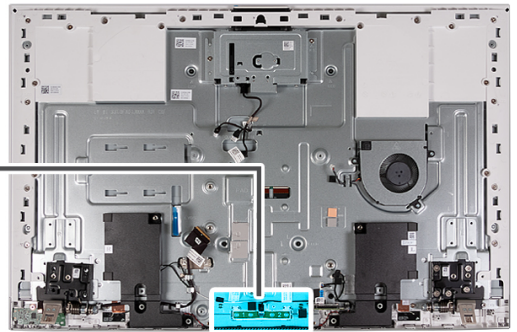

Figure 57. Installing the microphones

Steps

1. Align and place the microphone module into the slot on the display-assembly base.
2. Replace the four screws (M2X3.5) that secure the microphone module to the display-assembly base.
3. Route the microphone cable through the routing guides on the display-assembly base.
4. Adhere the tape that secures the microphone cable to the display-assembly base.

Next steps

1. Install the [system board](#).
2. Install the [integrated heat sink](#) or, [discrete heat sink](#), as applicable.
3. Install the [M.2 2230 solid-state drive](#).
4. Install the [wireless card](#).
5. Install the [memory module](#).
6. Install the [media-card reader](#).
7. Install the [system-board shield](#).
8. Install the [I/O cover](#).
9. Install the [back cover](#).
10. Install the [stand](#).
11. Follow the procedure in [After working inside your computer](#).

Antennas

Removing the antennas

 **CAUTION:** The information in this section is intended for authorized service technicians only.

Prerequisites

1. Follow the procedure in [Before working inside your computer](#).
2. Remove the [stand](#).
3. Remove the [back cover](#).
4. Remove the [I/O cover](#).
5. Remove the [system-board shield](#).
6. Remove the [media-card reader](#).
7. Remove the [memory module](#).
8. Remove the [wireless card](#).
9. Remove the [M.2 2230 solid-state drive](#).
10. Remove the [integrated heat sink](#) or [discrete heat sink](#), as applicable.
11. Remove the [system board](#).
12. Remove the [speakers](#).
13. Remove the [stand hinges](#).
14. Remove the [power-button board with USB](#).

About this task

The following image indicates the location of the antennas and provides a visual representation of the removal procedure.

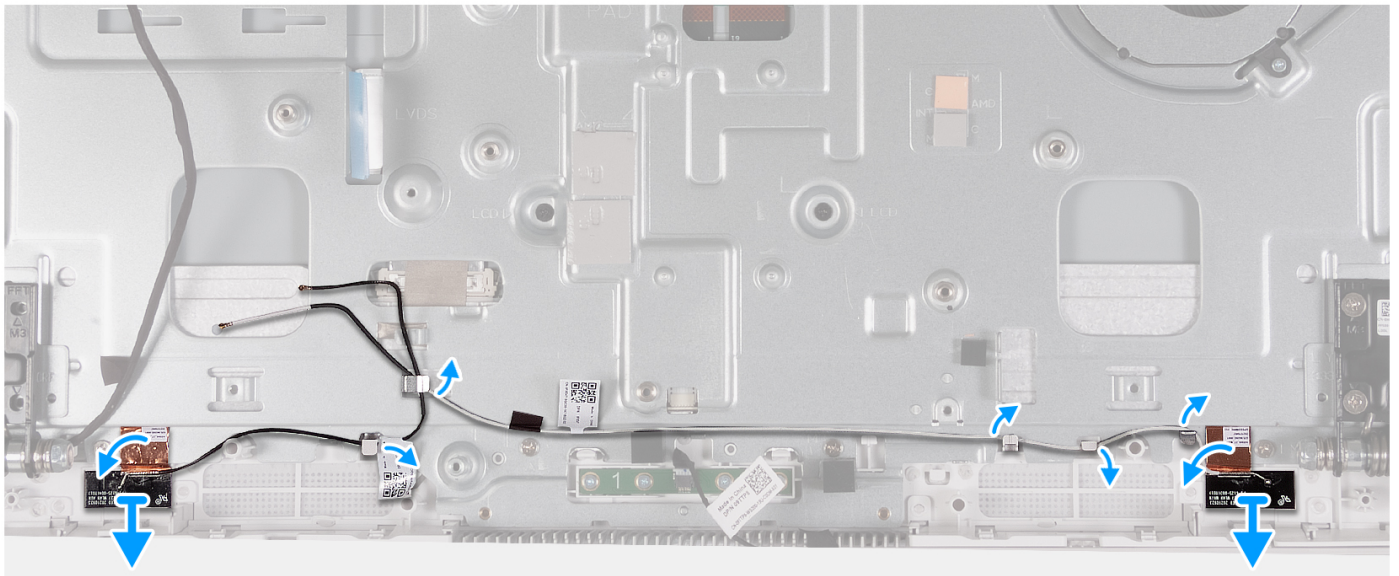
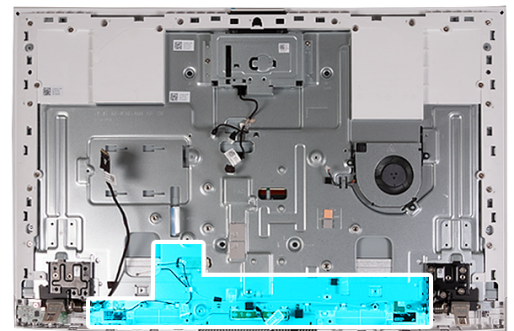

Figure 58. Removing the antennas

Steps

1. Remove the antenna cables from the routing guides on the display-assembly base.
NOTE: Make a note of the cable routing before removing the them form the routing guides.
2. Carefully peel the copper foil that secures the antenna cables on both sides of the display-assembly base.

3. Lift the antenna modules off the display-assembly base.

Installing the antennas

CAUTION: The information in this section is intended for authorized service technicians only.

Prerequisites

If you are replacing a component, remove the existing component before performing the installation procedure.

About this task

The following image indicates the location of the antennas and provides a visual representation of the installation procedure.

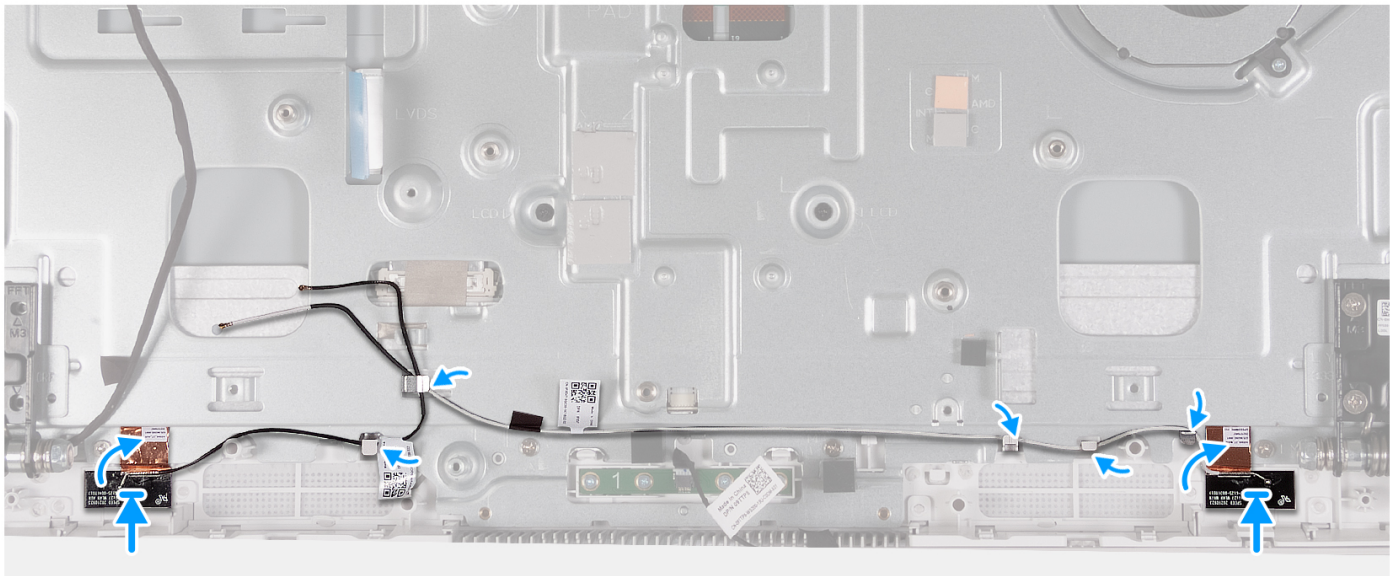
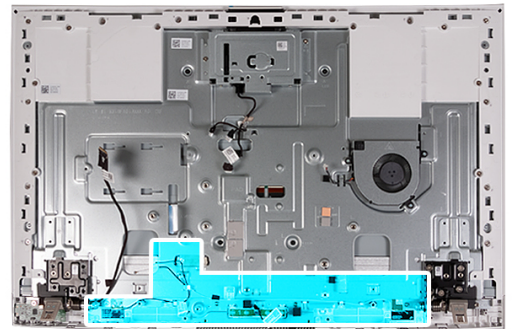

Figure 59. Installing the antennas

Steps

1. Align and place the antenna modules into the slots on the display-assembly base.

NOTE: The location of the antenna modules is printed on the display-assembly base as ANT-B (black) and ANT-W (white).

2. Adhere the copper foil that secures the antenna cables on both sides of the display-assembly base.
3. Route the antenna cables through the routing guides on the display-assembly base.

Next steps

1. Install the [power-button board with USB](#).
2. Install the [stand hinges](#).

3. Install the [speakers](#).
4. Install the [system board](#).
5. Install the [integrated heat sink](#) or, [discrete heat sink](#), as applicable.
6. Install the [M.2 2230 solid-state drive](#).
7. Install the [wireless card](#).
8. Install the [memory module](#).
9. Install the [media-card reader](#).
10. Install the [system-board shield](#).
11. Install the [I/O cover](#).
12. Install the [back cover](#).
13. Install the [stand](#).
14. Follow the procedure in [After working inside your computer](#).

Display panel

Removing the display panel

 **CAUTION:** The information in this section is intended for authorized service technicians only.

Prerequisites

1. Follow the procedure in [Before working inside your computer](#).
2. Remove the [stand](#).
3. Remove the [back cover](#).
4. Remove the [I/O cover](#).
5. Remove the [system-board shield](#).
6. Remove the [media-card reader](#).
7. Remove the [wireless card](#).
8. Remove the [M.2 2230 solid-state drive](#).
9. Remove the [integrated heat sink](#) or [discrete heat sink](#), as applicable.
10. Remove the [system board](#).

About this task

The following image indicates the location of the display panel and provides a visual representation of the removal procedure.

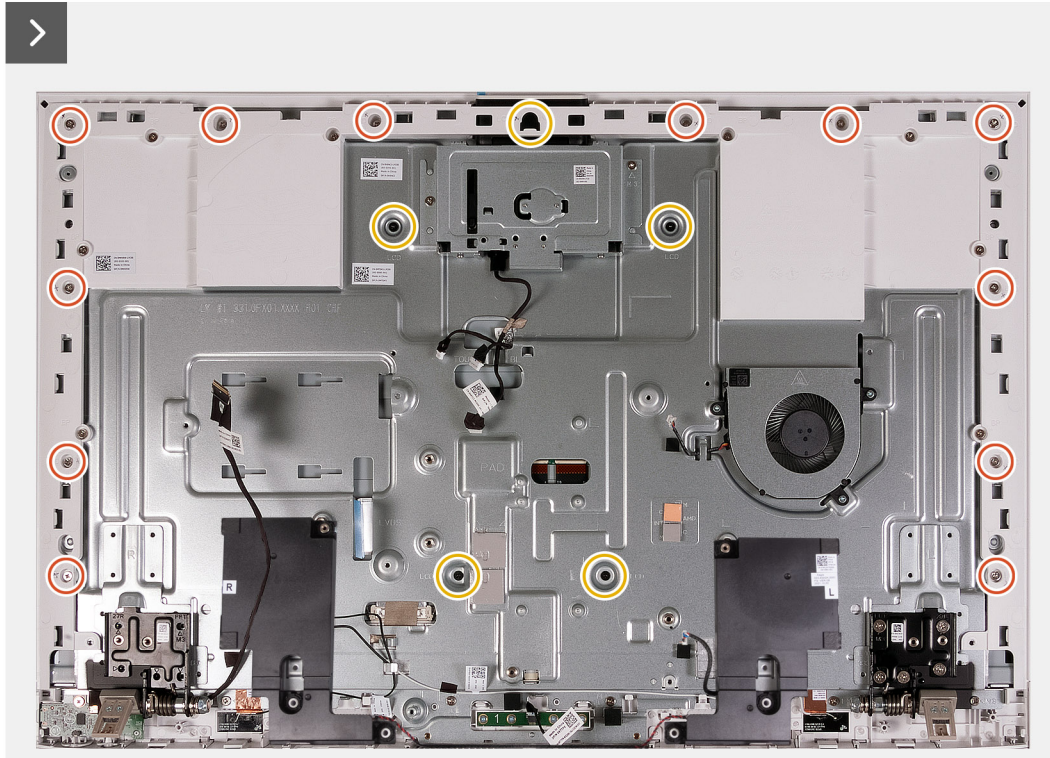

Figure 60. Removing the screws



Figure 61. Removing the display panel

Steps

1. Remove the 12 screws (M3x5) that secure the display panel to the display-assembly base.
2. Remove the five screws (M3x3) that secure the display panel to the display-assembly base.
3. Place the computer in an upright position.
4. Holding the top corner, push the display panel away from the display-assembly base using the push holes available on the display-assembly base.
5. Slide the display-backlight cable, touchscreen cable, and display cable on the display panel through the slots on the display-assembly base.
6. Lift the display panel up from the display-assembly base.

Installing the display panel

 **CAUTION:** The information in this section is intended for authorized service technicians only.

Prerequisites

If you are replacing a component, remove the existing component before performing the installation procedure.

About this task

The following image indicates the location of the display panel and provides a visual representation of the installation procedure.



12x
M3x5



5x
M3x3



Figure 62. Installing the display panel

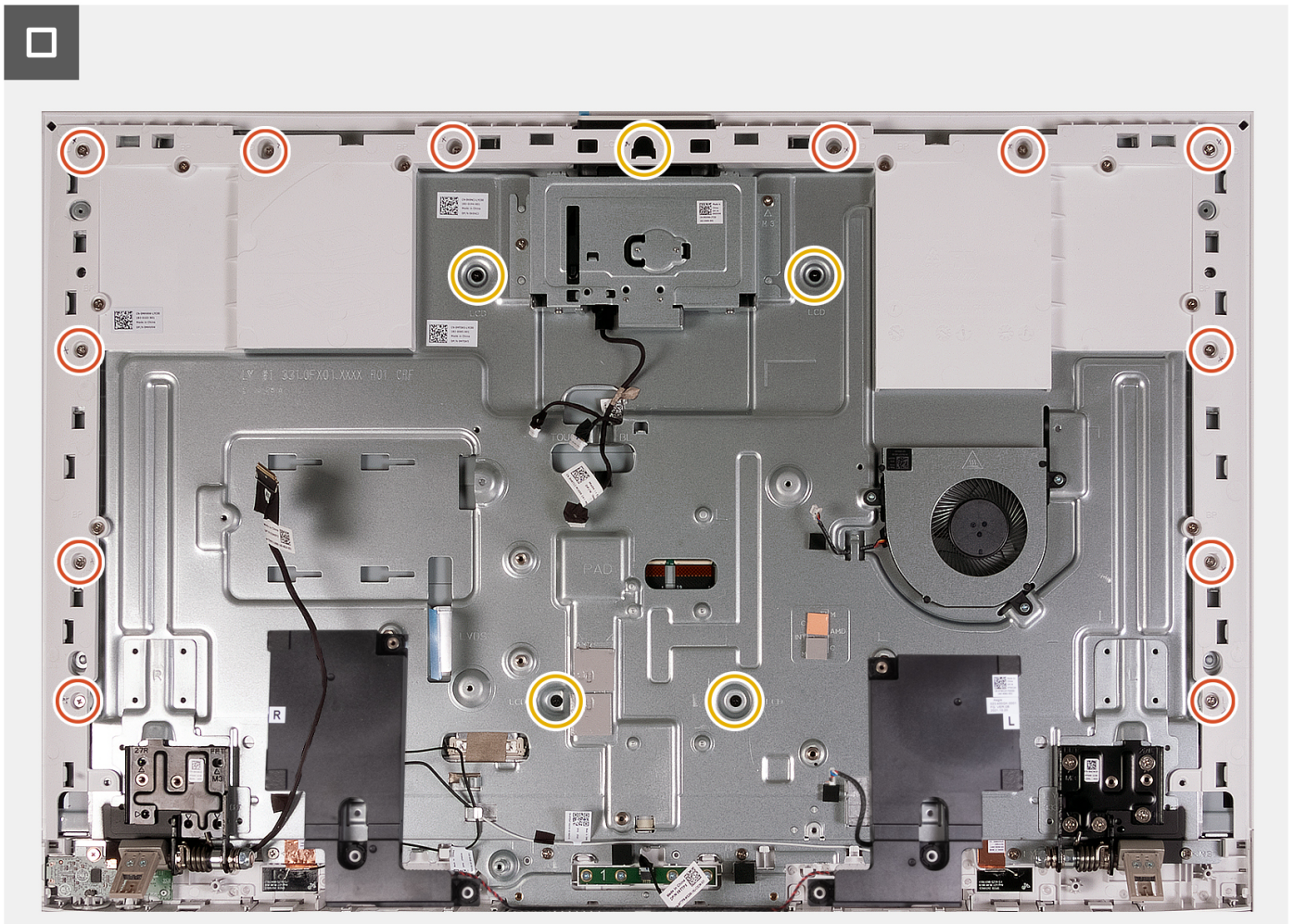

Figure 63. Replacing the screws

Steps

1. Slide and insert the display panel into the slot on the display-assembly base.
2. Route the display-backlight cable, touchscreen cable, and display cable on the display panel through the slots on the display-assembly base.
3. Place the display-assembly base on a clean and flat surface with the display panel facing down.
4. Replace the 12 screws (M3x5) that secure the display panel to the display-assembly base.
5. Replace the five screws (M3x3) that secure the display panel to the display-assembly base.

NOTE: The screws that secure the middle frame and display panel to the display-assembly base are silver in color and etched with "LCD" around the screw holes.

Next steps

1. Install the [system board](#).
2. Install the [integrated heat sink](#) or, [discrete heat sink](#), as applicable.
3. Install the [M.2 2230 solid-state drive](#).
4. Install the [wireless card](#).
5. Install the [media-card reader](#).
6. Install the [system-board shield](#).
7. Install the [I/O cover](#).
8. Install the [back cover](#).
9. Install the [stand](#).
10. Follow the procedure in [After working inside your computer](#).

Middle frame assembly

Removing the middle-frame assembly

CAUTION: The information in this section is intended for authorized service technicians only.

Prerequisites

1. Follow the procedure in [Before working inside your computer](#).
2. Remove the [stand](#).
3. Remove the [back cover](#).
4. Remove the [I/O cover](#).
5. Remove the [system-board shield](#).
6. Remove the [media-card reader](#).
7. Remove the [fan](#).
8. Remove the [memory module](#).
9. Remove the [wireless card](#).
10. Remove the [retractable-camera assembly](#).
11. Remove the [M.2 2230 solid-state drive](#).
12. Remove the [integrated heat sink](#) or [discrete heat sink](#), as applicable.
13. Remove the [system board](#).
14. Remove the [speakers](#).
15. Remove the [microphones](#).
16. Remove the [stand hinges](#).
17. Remove the [power-button board with USB](#).
18. Remove the [display panel](#).

About this task

The following image indicates the location of the middle-frame assembly and provides a visual representation of the removal procedure.

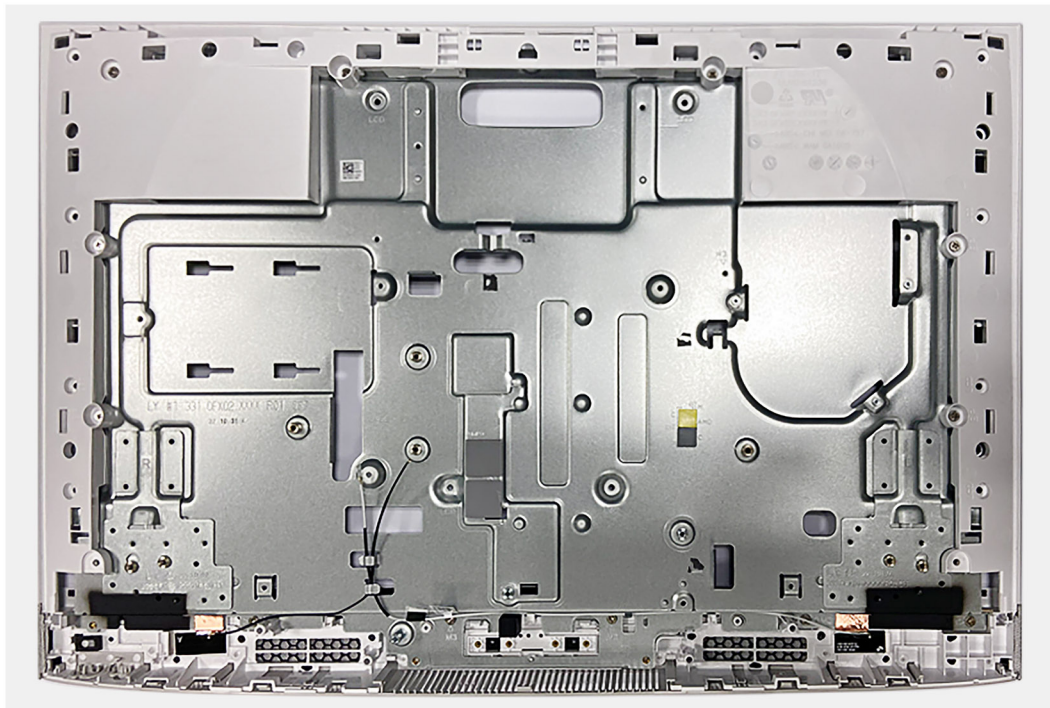

Figure 64. Removing the middle-frame assembly

Steps

After performing the pre-requisites, you are left with the middle-frame assembly.

i **NOTE:** The middle-frame assembly consists of the following:

- Middle frame
- Base panel
- Wireless antennas (2)

Installing the middle-frame assembly

⚠ **CAUTION:** The information in this section is intended for authorized service technicians only.

Prerequisites

If you are replacing a component, remove the existing component before performing the installation procedure.

About this task

The following image indicates the location of the middle-frame assembly and provides a visual representation of the installation procedure.

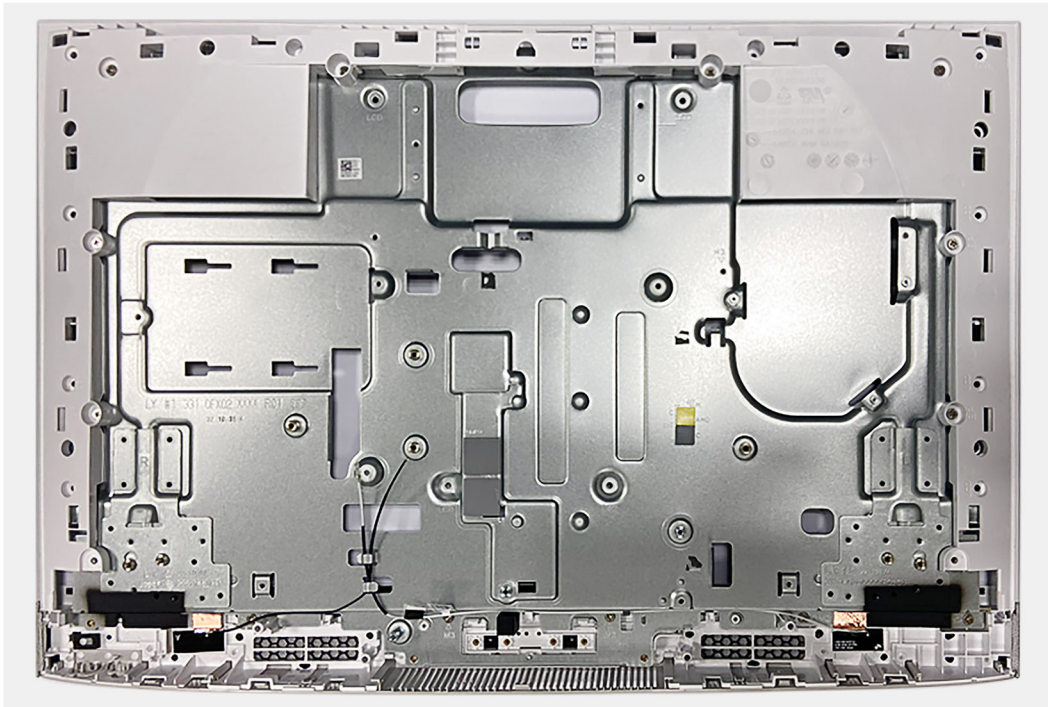

Figure 65. Installing the middle-frame assembly

Steps

Place the middle-frame assembly on a flat and clean surface and perform the steps in the [Post-requisites](#) to install the middle-frame assembly.

i **NOTE:** The middle-frame assembly consists of the following:

- Middle frame
- Base panel
- Wireless antenna

Next steps

1. Install the [display panel](#).
2. Install the [power-button board with USB](#).
3. Install the [stand hinges](#).
4. Install the [microphones](#).
5. Install the [speakers](#).
6. Install the [system board](#).
7. Install the [integrated heat sink](#) or, [discrete heat sink](#), as applicable.
8. Install the [M.2 2230 solid-state drive](#).
9. Install the [wireless card](#).
10. Install the [memory module](#).
11. Install the [retractable-camera assembly](#).
12. Install the [fan](#).
13. Install the [media-card reader](#).
14. Install the [system-board shield](#).
15. Install the [I/O cover](#).
16. Install the [back cover](#).
17. Install the [stand](#).
18. Follow the procedure in [After working inside your computer](#).

Software

This chapter details the supported operating systems along with instructions on how to install the drivers.

Operating system

Your Inspiron 27 7730 All-in-One supports the following operating systems:

- Windows 11 Home
- Windows 11 Pro

Drivers and downloads

When troubleshooting, downloading, or installing drivers, it is recommended that you read the Dell Knowledge Base article Drivers and Downloads FAQs [000123347](#).

BIOS Setup

CAUTION: Unless you are an expert computer user, do not change the settings in the BIOS Setup. Certain changes can make your computer work incorrectly.

NOTE: Depending on the computer and the installed devices, the options that are listed in this section may or may not be displayed.

NOTE: Before you change the settings in BIOS Setup, it is recommended that you note down the original settings for future reference.

Use BIOS Setup for the following purposes:

- Get information about the hardware installed in your computer, such as the amount of RAM and the size of the storage device.
- Change the system configuration information.
- Set or change a user-selectable option, such as the user password, type of hard drive installed, and enable or disable base devices.

Entering BIOS setup program

About this task

Turn on (or restart) your computer and press F2 immediately.

NOTE: If you are connected to the Dell Pro Wireless Keyboard KM5221W, press Fn+F2.

Navigation keys

NOTE: For most of the BIOS Setup options, changes that you make are recorded but do not take effect until you restart the computer.

Table 27. Navigation keys

Keys	Navigation
Up arrow	Moves to the previous field.
Down arrow	Moves to the next field.
Enter	Selects a value in the selected field (if applicable) or follows the link in the field.
Spacebar	Expands or collapses a drop-down list, if applicable.
Tab	Moves to the next focus area.
Esc	Moves to the previous page until you view the main screen. Pressing Esc in the main screen displays a message that prompts you to save any unsaved changes and restart the computer.

One time boot menu

To enter **one time boot menu**, turn on your computer, and then press F12 immediately.

NOTE: If you are connected to the Dell Pro Wireless Keyboard KM5221W, press Fn+F12.

NOTE: It is recommended to shutdown the computer if it is on.

The one-time boot menu displays the devices that you can boot from including the diagnostic option. The boot menu options are:

- Windows Boot Manager
- UEFI HTTPs Boot
- UEFI RST Micron 2450 SSD
- Onboard NIC (IPV4)
- Onboard NIC (IPV6)

The boot sequence screen also displays the option to access the System Setup screen.

System setup options

NOTE: Depending on your computer and its installed devices, the items that are listed in this section may or may not be displayed.

Table 28. System setup options—Overview menu

Overview	
Inspiron 27 7730 All-in-One	
BIOS Version	Displays the BIOS version number.
Service Tag	Displays the Service Tag of the computer.
Asset Tag	Displays the Asset Tag of the computer.
Manufacture Date	Displays the manufacture date of the computer.
Ownership Date	Displays the ownership date of the computer.
Express Service Code	Displays the Express Service Code of the computer.
Ownership Tag	Displays the Ownership Tag of the computer.
Signed Firmware Update	Displays whether the Signed Firmware Update is enabled on your computer. By default, the Signed Firmware Update option is enabled.
Processor Information	
Processor Type	Displays the processor type.
Maximum Clock Speed	Displays the maximum processor clock speed.
Minimum Clock Speed	Displays the minimum processor clock speed.
Current Clock Speed	Displays the current processor clock speed.
Core Count	Displays the number of cores on the processor.
Processor ID	Displays the processor identification code.
Processor L2 Cache	Displays the processor L2 Cache size.
Processor L3 Cache	Displays the processor L3 Cache size.
Microcode Version	Displays the microcode version.
Intel Hyper-Threading Capable	Displays whether the processor is Hyper-Threading (HT) capable.
64-Bit Technology	Displays whether 64-bit technology is used.
Memory Information	
Memory Installed	Displays the total computer memory installed.

Table 28. System setup options—Overview menu (continued)

Overview	
Memory Available	Displays the total computer memory available.
Memory Speed	Displays the memory speed.
Memory Channel Mode	Displays single or dual channel mode.
Memory Technology	Displays the technology that is used for the memory.
DIMM 1 size	Displays the total size of the DIMM 1 memory module.
DIMM 2 size	Displays the total size of the DIMM 2 memory module.
Devices Information	
Panel Type	Displays the Panel Type of the computer.
Video Controller	Displays the video controller type of the computer.
Video Memory	Displays the video memory information of the computer.
Wi-Fi Device	Displays the wireless device information of the computer.
Native Resolution	Displays the native resolution of the computer.
Video BIOS Version	Displays the video BIOS version of the computer.
Audio Controller	Displays the audio controller information of the computer.
Bluetooth Device	Displays the Bluetooth device information of the computer.
LOC MAC Address	Displays the MAC address of the video pass-through.
dGPU Video Controller	Displays the dGPU video controller type of the computer.

Table 29. System setup options—Boot Configuration menu

Boot Configuration	
Boot Sequence	
Boot Mode: UEFI only	Displays the boot mode of the computer.
Boot Sequence	<p>Displays the boot sequence.</p> <p>By default, the UEFI RST P0221 NVMe Phison 1024GB H5FGYSAPT36F0036 option is selected.</p> <p>By default, the ONBOARD NIC (IPV4) option is selected.</p> <p>By default, the ONBOARD NIC (IPV6) option is selected.</p> <p>By default, the UEFI HTTPs (MAC:20881078A4CD) option is selected.</p>
Secure Boot	
	<p>Secure Boot is a method of guaranteeing the integrity of the boot path by performing additional validation of the operating system and PCI add-in cards. The computer stops booting to the operating system when a component is not authenticated during the boot process. Secure Boot can be enabled in BIOS setup or using management interfaces like Dell Command Configure, but can only be disabled from BIOS setup.</p>
Enable Secure Boot	<p>Enables the computer to boot using only validated boot software.</p> <p>By default, the Enable Secure Boot option is disabled.</p> <p>For additional security, Dell Technologies recommends keeping the Secure Boot option enabled to ensure that the UEFI firmware validates the operating system during the boot process.</p> <p>i NOTE: For Secure Boot to be enabled, the computer is required to be in UEFI boot mode and the Enable Legacy Option ROMs option is required to be turned off.</p>

Table 29. System setup options—Boot Configuration menu (continued)

Boot Configuration	
Secure Boot Mode	<p>Enables or disables the Secure Boot operation mode.</p> <p>By default, the Deployed Mode is selected.</p> <p> NOTE: Deployed Mode should be selected for normal operation of Secure Boot.</p>
Expert Key Management	
Enable Custom Mode	<p>Enables or disables the keys in the PK, KEK, db, and dbx security key databases to be modified.</p> <p>By default, the Enable Custom Mode option is disabled.</p>
Custom Mode Key Management	<p>Selects the custom values for expert key management.</p> <p>By default, the PK option is selected.</p>

Table 30. System setup options—Integrated Devices menu

Integrated Devices	
Date/Time	
Date	<p>Sets the computer date in MM/DD/YYYY format. Changes to the date format take effect immediately.</p>
Time	<p>Sets the computer time in HH/MM/SS 24-hour format. You can switch between a 12-hour and 24-hour clock. Changes to the time format take effect immediately.</p>
Camera	
Enable Camera	<p>Enables the camera.</p> <p>By default, the Enable Camera option is enabled.</p>
Audio	
Enable Audio	<p>Enables all integrated audio controller.</p> <p>By default, all the options are enabled.</p>
Enable Microphone	<p>Enables the microphone.</p> <p>By default, the Enable Microphone option is enabled.</p>
Enable Internal Speaker	<p>Enables the internal speaker.</p> <p>By default, the Enable Internal Speaker option is enabled.</p>
USB Configuration	
Enable Rear USB Ports	<p>Enables the rear USB ports.</p> <p>By default, the Enable Rear USB Ports option is enabled.</p>
Enable Side Boot Support	<p>Enables the side USB ports.</p> <p>By default, the Enable Side USB Ports option is enabled.</p>
Enable USB Boot Support	<p>Enables booting from USB mass storage devices that are connected to external USB ports.</p> <p>By default, the Enable USB Boot Support option is enabled.</p>

Table 31. System setup options—Storage menu

Storage	
SATA/NVMe Operation	

Table 31. System setup options—Storage menu (continued)

Storage	
SATA/NVMe Operation	Sets the operating mode of the integrated SATA hard drive controller. By default, the RAID On option is selected.
Storage Interface	
Port Enablement	Enables or disables the M.2 PCIe SSD option. By default, the M.2 PCIe SSD option is enabled.
SMART reporting	
Enable SMART reporting	If S.M.A.R.T. (Self-monitoring, Analysis, and Reporting Technology) is enabled the BIOS can receive analytical information from integrated devices and send notifications during startup about possible failure of the device. By default, the option is disabled.
Drive information	Displays the drive type and device name.

Table 32. System setup options—Display menu

Display	
Touchscreen	Enables or disables the touch screen option. By default, the Touchscreen option is enabled.
OSD Button Management	
Disable OSD buttons	Disable the OSD (On-Screen Display) buttons on their All-in-One system. By default, the option is disabled.
Full Screen Logo	Enables or disables the computer to display a full-screen logo, if the image matches screen resolution. By default, the Full Screen Logo option is disabled.

Table 33. System setup options—Connection menu

Connection	
Network Controller Configuration	
Integrated NIC	Sets the on-board LAN controller. By default, the Enabled with PXE option is selected.
Wireless Device Enable	
WLAN	Enables or disables the internal WLAN device. By default, the WLAN option is enabled.
Bluetooth	Enables or disables the internal Bluetooth device. By default, the Bluetooth option is enabled.
Enable UEFI Network Stack	Enables or disables the UEFI Network Stack and controls the onboard LAN Controller. By default, the Auto Enabled option is selected.
HTTP(s) Boot Feature	
HTTP(s) Boot	Enables or disables the HTTP(s) boot capabilities. By default, the option is eabled.

Table 33. System setup options—Connection menu (continued)

Connection	
HTTP(s) Boot Modes	<p>Sets the Boot Mode.</p> <p>By default, the Auto Mode option is selected.</p>

Table 34. System setup options—Power menu

Power	
USB PowerShare	
Enable USB PowerShare	<p>Enables or disables external devices (phones, portable music players) to be power or charged using system battery.</p> <p>By default, the option is disabled.</p>
USB Wake Support	
Enable USB Wake support	<p>Enable or disable USB devices like a mouse or keyboard to wake the system from Standby, Hibernate, and Power Off.</p> <p>By default, the USB Wake Support option is disabled.</p>
AC Behavior	
AC Recover	<p>Set what the your system will do when power is restored after an unexpected loss of power.</p> <p>By default the Power OFF option is selected.</p>
Block Sleep	
	<p>Enables or disables the computer from entering Sleep (S3) mode in the operating system.</p> <p>By default, the Block Sleep option is disabled.</p> <p>i NOTE: When enabled, the computer does not go to Sleep, Intel Rapid Start is disabled automatically, and the operating system power option is blank if it was set to Sleep.</p>
Deep Sleep Control	
Deep Sleep Control	<p>Set how aggressive the system is at conserving power while in Shutdown (S5) or Hibernate (S4) mode.</p> <p>By default, the option is disabled.</p>
Intel Speed Shift Technology	
	<p>Enables or disables the Intel Speed Shift Technology support. When enabled, the operating system selects the appropriate processor performance automatically.</p> <p>By default, the Intel Speed Shift Technology option is enabled.</p>

Table 35. System setup options—Security menu

Security	
Intel Platform Trust Technology	
Intel Platform Trust Technology	<p>This option lets you control whether the Intel Platform Trust Technology (PTT) feature is visible to the operating system.</p> <p>i NOTE: Disabling this option does not change any settings you have made to the PTT, nor does it delete or change any information or keys you may have stored in PTT. Changes to this setting take effect immediately.</p>
SMM Security Mitigation	
	<p>Enables or disables additional UEFI SMM Security Mitigation protections. This option uses the Windows SMM Security Mitigations Table (WSMT) to confirm to the operating system that security best practices have been implemented by the UEFI firmware.</p> <p>By default, the SMM Security Mitigation option is enabled.</p>

Table 35. System setup options—Security menu (continued)



Security	
	<p>For additional security, Dell Technologies recommends keeping the SMM Security Mitigation option enabled unless you have a specific application which is not compatible.</p> <p> NOTE: This feature may cause compatibility issues or loss of functionality with some legacy tools and applications.</p>
Data Wipe on Next Boot	
Start Data Wipe	<p>Data Wipe is a secure wipe operation that deletes information from a storage device.</p> <p> CAUTION: The secure Data Wipe operation deletes information in a way that it cannot be reconstructed.</p> <p>Commands such as delete and format in the operating system may remove files from showing up in the file system. However, they can be reconstructed through forensic means as they are still represented on the physical media. Data Wipe prevents this reconstruction and is not recoverable.</p> <p>When enabled, the data wipe option will prompt to wipe any storage devices that are connected to the computer on the next boot.</p> <p>By default, the Start Data Wipe option is disabled.</p>
Absolute	<p>Absolute Software provides various cyber security solutions, some requiring software preloaded on Dell computers and integrated into the BIOS. To use these features, you must enable the Absolute BIOS setting and contact Absolute for configuration and activation.</p> <p>By default, the Absolute option is enabled.</p> <p>For additional security, Dell Technologies recommends keeping the Absolute option enabled.</p> <p> NOTE: When the Absolute features are activated, the Absolute integration cannot be disabled from the BIOS setup screen.</p>
UEFI Boot Path Security	<p>Enables or disables the computer to prompt the user to enter the Administrator password (if set) when booting to a UEFI boot path device from the F12 boot menu.</p> <p>By default, the Always Except Internal HDD option is enabled.</p>
Firmware Device Tamper Detection	<p>Allows you to control the firmware device tamper detection feature. This feature notifies the user when the firmware device is tampered. When enabled, a screen warning messages are displayed on the computer and a tamper detection event is logged in the BIOS Events log. The computer fails to reboot until the event is cleared.</p> <p>By default, the Silent option is enabled.</p> <p>For additional security, Dell Technologies recommends keeping the Silent option enabled.</p>

Table 36. System setup options—Passwords menu

Passwords	
Admin Password	<p>The Administrator Password prevents unauthorized access to the BIOS Setup options. Once the administrator password is set, the BIOS setup options can only be modified after providing the correct password.</p> <p>The following rules and dependencies apply to the Administrator Password -</p> <ul style="list-style-type: none"> • The administrator password cannot be set if computer and/or internal hard drive passwords are previously set.

Table 36. System setup options—Passwords menu (continued)

<p>Passwords</p>	<ul style="list-style-type: none"> • The administrator password can be used in place of the computer and/or internal hard drive passwords. • When set, the administrator password must be provided during a firmware update. • Clearing the administrator password also clears the computer password (if set). <p>Dell Technologies recommends using an administrator password to prevent unauthorized changes to BIOS setup options.</p>
<p>System Password</p>	<p>The System Password prevents the computer from booting to an operating system without entering the correct password.</p> <p>The following rules and dependencies apply when the System Password is used -</p> <ul style="list-style-type: none"> • The computer shuts down when idle for approximately 10 minutes at the computer password prompt. • The computer shuts down after three incorrect attempts to enter the computer password. • The computer shuts down when the Esc key is pressed at the System Password prompt. • The computer password is not prompted when the computer resumes from standby mode. <p>Dell Technologies recommends using the computer password in situations where it is likely that a computer may be lost or stolen.</p>
<p>M.2 PCIe SSD-0</p>	<p>The M.2 SSD Password can be set to prevent unauthorized access of the data stored on the M.2 SSD. The computer prompts for the hard drive password during boot in order to unlock the drive. A password-secured M.2 SSD stays locked even when removed from the computer or placed into another computer. It prevents an attacker from accessing data on the drive without authorization.</p> <p>The following rules and dependencies apply when the M.2 SSD Password is used -</p> <ul style="list-style-type: none"> • The M.2 SSD password option cannot be accessed when a hard drive is disabled in the BIOS setup. • The computer shuts down when idle for approximately 10 minutes at the M.2 SSD password prompt. • The computer shuts down after three incorrect attempts to enter the M.2 SSD password and treats the M.2 SSD as not available. • The M.2 SSD does not accept password unlock attempts after five incorrect attempts to enter the hard drive password from the BIOS Setup. The M.2 SSD password must be reset for the new password unlock attempts. • The computer treats the M.2 SSD as not available when the Esc key is pressed at the hard drive password prompt. • The M.2 SSD password is not prompted when the computer resumes from standby mode. When the M.2 SSD is unlocked by the user before the computer goes into standby mode, it remains unlocked after the computer resumes from standby mode. • If the computer and hard drive passwords are set to the same value, the hard drive unlocks after the correct computer password is entered. <p>Dell Technologies recommends using a M.2 SSD password to protect unauthorized data access.</p>
<p>Password Configuration</p>	<p>The Password configuration page includes several options for changing the requirements of BIOS passwords. You can modify the minimum and maximum length of the passwords and require passwords to contain certain character classes (upper case, lower case, digit, special character).</p> <p>Dell Technologies recommends setting the minimum password length to at least eight characters.</p>

Table 36. System setup options—Passwords menu (continued)

Passwords	
Password Bypass	<p>The Password Bypass option allows the computer to reboot from the operating system without entering the computer or hard drive password. If the computer has already booted to the operating system, it is presumed that the user has already entered the correct computer or hard drive password.</p> <p>NOTE: This option does not remove the requirement to enter the password after shutting down.</p> <p>By default, the Password Bypass option is disabled.</p>
Password Changes	
Allow Non-Admin Password Changes	<p>The Allow Non-Admin Password Changes option in BIOS setup allows an end user to set or change the computer or hard drive passwords without entering the administrator password. This gives an administrator control over the BIOS settings but enables an end user to provide their own password.</p> <p>By default, the option is disabled.</p> <p>For additional security, Dell Technologies recommends keeping the Allow Non-Admin Password Changes option enabled.</p>
Admin Setup Lockout	<p>The Admin Setup Lockout option prevents an end user from even viewing the BIOS setup configuration without first entering the administrator password (if set).</p> <p>By default, the Admin Setup Lockout option is disabled.</p> <p>For additional security, Dell Technologies recommends keeping the Admin Setup Lockout option disabled.</p>
Master Password Lockout	
Enable Master Password Lockout	<p>The Master Password Lockout setting allows you to disable the Recovery Password feature. If the computer, administrator, or hard drive password is forgotten, the computer becomes unusable.</p> <p>NOTE: When the owner password is set, the Master Password Lockout option is not available.</p> <p>NOTE: When an internal hard drive password is set, it must first be cleared before Master Password Lockout can be changed.</p> <p>By default, the Enable Master Password Lockout option is disabled.</p> <p>Dell does not recommend enabling the Master Password Lockout unless you have implemented your own password recovery computer.</p>
Allow Non-Admin PSID Revert	<p>This option controls access to the Physical Security ID (PSID) revert of NVMe storage drives from the Dell Security Manager prompt.</p> <p>When disabled: If a BIOS Admin password is set, PSID revert is protected by the BIOS Admin password and the user will be prompted to enter the BIOS Admin password before performing the revert.</p> <p>When enabled: PSID revert is allowed to proceed without providing the BIOS admin password.</p> <p>By default, the option is disabled.</p>

Table 37. System setup options—Update, Recovery menu

Update, Recovery	
UEFI Capsule Firmware Updates	
Enable UEFI Capsule Firmware Updates	<p>Enables or disables BIOS updates through UEFI capsule update packages.</p> <p>NOTE: Disabling this option blocks the BIOS updates from services such as Microsoft Windows Update and Linux Vendor Firmware Service (LVFS).</p>

Table 37. System setup options—Update, Recovery menu (continued)

Update, Recovery	
	By default, the Enable UEFI Capsule Firmware Updates option is enabled.
BIOS Recovery from Hard Drive	<p>Enables or disables the user to recover from certain corrupted BIOS conditions from a recovery file on the user primary hard drive or an external USB key.</p> <p>By default, the BIOS Recovery from Hard Drive option is enabled.</p> <p>i NOTE: BIOS Recovery from Hard Drive is not available for self-encrypting drives (SED).</p> <p>i NOTE: BIOS recovery is designed to fix the main BIOS block and cannot work if the Boot Block is damaged. In addition, this feature cannot work in the event of EC corruption, ME corruption, or a hardware issue. The recovery image must exist on an unencrypted partition on the drive.</p>
BIOS Downgrade	
Allow BIOS Downgrade	<p>Controls flashing of the computer firmware to previous revisions.</p> <p>By default, the Allow BIOS Downgrade option is enabled.</p>
SupportAssist OS Recovery	<p>Enables or disables the boot flow for SupportAssist OS Recovery tool in the event of certain computer errors.</p> <p>By default, the SupportAssist OS Recovery option is enabled.</p>
BIOSConnect	<p>Enables or disables cloud Service operating system recovery if the main operating system fails to boot with the number of failures equal to or greater than the value specified by the Auto operating system Recovery Threshold setup option and local Service operating system does not boot or is not installed.</p> <p>By default, the BIOSConnect option is enabled.</p>
Dell Auto OS Recovery Threshold	<p>Allows you to control the automatic boot flow for SupportAssist System Resolution Console and for Dell operating system Recovery Tool.</p> <p>By default, the Dell Auto OS Recovery Threshold value is set to 2.</p>

Table 38. System setup options—System Management menu

System Management	
Service Tag	Displays the Service Tag of the computer.
Asset Tag	<p>Creates a computer Asset Tag that can be used by an IT administrator to uniquely identify a particular computer.</p> <p>i NOTE: Once set in BIOS, the Asset Tag cannot be changed.</p>
Wake on LAN/WLAN	<p>Enables or disables the computer to turn on by a special LAN signal.</p> <p>By default, the Wake on LAN/WLAN option is disabled.</p>
Auto On Time	<p>Enable to set the computer to turn on automatically every day or on a preselected date and time. This option can be configured only if the Auto On Time is set to Everyday, Weekdays, or Selected Days.</p> <p>By default, the Auto On Time option is disabled.</p>
First Power on Date	
Set Ownership Date	<p>This option lets you set the ownership date of your computer.</p> <p>By default, this option is enabled.</p>
Diagnostics	
OS agent Requests	This option enables or disables Dell OS Agent(s) to schedule onboard diagnostics.

Table 38. System setup options—System Management menu (continued)

System Management	
	By default, this option is enabled.
Power-on-Self-Test Automatic Recovery	
Power-on-Self-Test Automatic Recovery	This option enables or disables the BIOS to attempt an automatic recovery of the computer- such as reverting BIOS Setup configuration settings to BIOS. By default, this option is enabled.

Table 39. System setup options—Keyboard menu

Keyboard	
Keyboard Errors	
Enable Keyboard Error Detection	Enables or disables report of keyboard-related errors when the computer boots. By default, this option is enabled.
Numlock LED	
Enable Numlock LED	Enables or disables Numlock when the computer boots. By default, this option is enabled.

Table 40. System setup options—Preboot Behavior menu

Preboot Behavior	
Adapter Warnings	
Enable Dock Warning Messages	Enables the warning messages during boot when the adapters with less power capacity are detected. By default, the Enable Dock Warning Messages option is enabled.
Warnings and Errors	Enables or disables the action to be taken when a warning or error is encountered. By default, the Prompt on Warnings and Errors option is selected. Stop, prompt, and wait for user input when warnings or errors are detected.  NOTE: Errors deemed critical to the operation of the computer hardware stop the functioning of the computer.
Fastboot	Allows you to configure the speed of the UEFI boot process. By default, the Thorough option is selected. Performs complete hardware and configuration initialization during boot.
Extend BIOS POST Time	Sets the BIOS POST (Power-On Self-Test) load time. By default, the 0 seconds option is selected.

Table 41. System setup options—Virtualization menu

Virtualization Support	
Intel Virtualization Technology	
Enable Intel Virtualization Technology (VT)	When enabled, the computer can run a Virtual Machine Monitor (VMM). By default, the Enable Intel Virtualization Technology (VT) option is enabled.
VT for Direct I/O	

Table 41. System setup options—Virtualization menu (continued)

Virtualization Support	
Enable Intel VT for Direct I/O	<p>When enabled, the computer can perform Virtualization Technology for Direct I/O (VT-d). VT-d is an Intel method that provides virtualization for memory map I/O.</p> <p>By default, the Enable Intel VT for Direct I/O option is enabled.</p>
DMA Protection	
Enable Pre-Boot DMA Support	<p>Allows you to control the Pre-Boot DMA protection for both internal and external ports. This option does not directly enable DMA protection in the operating system.</p> <p>i NOTE: This option is not available when the virtualization setting for IOMMU is disabled (VT-d/AMD Vi).</p> <p>By default, the Enable Pre-Boot DMA Support option is enabled.</p> <p>For additional security, Dell Technologies recommends keeping the Enable Pre-Boot DMA Support option enabled.</p> <p>i NOTE: This option is provided only for compatibility purposes, since some older hardware is not DMA capable.</p>
Enable OS Kernel DMA Support	<p>Allows you to control the Kernel DMA protection for both internal and external ports. This option does not directly enable DMA protection in the operating system. For operating systems that support DMA protection, this setting indicates to the operating system that the BIOS supports the feature.</p> <p>i NOTE: This option is not available when the virtualization setting for IOMMU is disabled (VT-d/AMD Vi).</p> <p>By default, the Enable OS Kernel DMA Support option is enabled.</p> <p>i NOTE: This option is provided only for compatibility purposes, since some older hardware is not DMA capable.</p>

Table 42. System setup options—Performance menu

Performance	
Multi-Core Support	
Multiple Atom Cores	<p>Enables to change the number of Atom cores available to the operating system. The default value is set to the maximum number of cores.</p> <p>By default, the All Cores option is selected.</p>
Intel SpeedStep	
Enable Intel SpeedStep Technology	<p>Enables the computer to dynamically adjust processor voltage and core frequency, decreasing average power consumption and heat production.</p> <p>By default, the Enable Intel SpeedStep Technology option is enabled.</p>
C-State Control	
Enable C-State Control	<p>Enables or disables the ability of the CPU to enter and exit low-power state. When disabled, it disables all C-states. When enabled, it enables all C-states that the chipset or platform allows.</p> <p>By default, the Enable C-State Control option is enabled.</p>
Intel Turbo Boost Technology	
Enable Intel Turbo Boost Technology	<p>Enables the Intel TurboBoost mode of the processor. When enabled, the Intel TurboBoost driver increases the performance of the CPU or graphics processor.</p> <p>By default, the Enable Intel Turbo Boost Technology option is enabled.</p>
Intel Hyper-Threading Technology	

Table 42. System setup options—Performance menu (continued)

Performance	
Enable Intel Hyper-Threading Technology	Enables the Intel Hyper-Threading mode of the processor. When enabled, the Intel Hyper-Threading increases the efficiency of the processor resources when multiple threads run on each core. By default, the Intel Hyper-Threading Technology option is enabled.

Table 43. System setup options—System Logs menu

System Logs	
BIOS Event Log	
Clear BIOS Event Log	Allows you to select option to keep or clear BIOS events logs. By default, the Keep Log option is selected.
Power Event Log	
Clear Power Event Log	Allows you to select option to keep or clear Power events logs. By default, the Keep Log option is selected.

Updating the BIOS

Updating the BIOS in Windows

Steps

1. Go to [Dell Support Site](#).
2. Click **Product support**. In the **Search support** box, enter the Service Tag of your computer, and then click **Search**.
 **NOTE:** If you do not have the Service Tag, use the SupportAssist to automatically identify your computer. You can also use the product ID or manually browse for your computer model.
3. Click **Drivers & Downloads**. Expand **Find drivers**.
4. Select the operating system installed on your computer.
5. In the **Category** drop-down list, select **BIOS**.
6. Select the latest version of BIOS, and click **Download** to download the BIOS file for your computer.
7. After the download is complete, browse the folder where you saved the BIOS update file.
8. Double-click the BIOS update file icon and follow the on-screen instructions.
For more information about how to update the system BIOS, search in the Knowledge Base Resource at [Dell Support Site](#).

Updating the BIOS using the USB drive in Windows

Steps

1. Follow the procedure from step 1 to step 6 in [Updating the BIOS in Windows](#) to download the latest BIOS setup program file.
2. Create a bootable USB drive. For more information, search the Knowledge Base Resource at [Dell Support Site](#).
3. Copy the BIOS setup program file to the bootable USB drive.
4. Connect the bootable USB drive to the computer that needs the BIOS update.
5. Restart the computer and press **F12** .
 **NOTE:** If you are connected to the Dell Pro Wireless Keyboard KM5221W, press Fn+F12.
6. Select the USB drive from the **One Time Boot Menu**.
7. Type the BIOS setup program filename and press **Enter**.

The **BIOS Update Utility** appears.

8. Follow the on-screen instructions to complete the BIOS update.

Updating the BIOS in Linux and Ubuntu

To update the system BIOS on a computer that is installed with Linux or Ubuntu, see the knowledge base article [000131486](#) at [Dell Support Site](#).

Updating the BIOS from the One Time Boot menu

Update your computer BIOS using the BIOS update.exe file that is copied to a FAT32 USB drive and booting from the **One Time Boot** menu.

About this task

BIOS Update

You can run the BIOS update file from Windows using a bootable USB drive or you can also update the BIOS from the **One Time Boot** menu on the computer.

Most of the Dell computers built after 2012 have this capability, and you can confirm by booting your computer to the **One Time Boot** Menu to see if BIOS FLASH UPDATE is listed as a boot option for your computer. If the option is listed, then the BIOS supports this BIOS update option.

 **NOTE:** Only computers with BIOS Flash Update option in the **One Time Boot** menu can use this function.

Updating from the One Time Boot menu

To update your BIOS from the **One Time Boot** menu, you need the following:

- USB drive formatted to the FAT32 file system (key does not have to be bootable)
- BIOS executable file that you downloaded from the Dell Support website and copied to the root of the USB drive
- AC power adapter that is connected to the computer
- Functional computer battery to flash the BIOS

Perform the following steps to perform the BIOS update flash process from the One Time Boot menu:

 **CAUTION: Do not turn off the computer during the BIOS update process. The computer may not boot if you turn off your computer.**

Steps

1. From a turn off state, insert the USB drive where you copied the flash into a USB port of the computer.
2. Turn on the computer and press F12 to access the **One Time Boot** Menu, select BIOS Update using the mouse or arrow keys then press Enter.

 **NOTE:** If you are connected to the Dell Pro Wireless Keyboard KM5221W, press Fn+F12.

The flash BIOS menu is displayed.

3. Click **Flash from file**.
4. Select external USB device.
5. Select the file and double-click the flash target file, and then click **Submit**.
6. Click **Update BIOS**. The computer restarts to flash the BIOS.
7. The computer will restart after the BIOS update is completed.

System and setup password

Table 44. System and setup password

Password type	Description
System password	Password that you must enter to log in to your system.
Setup password	Password that you must enter to access and make changes to the BIOS settings of your computer.

You can create a system password and a setup password to secure your computer.

 **CAUTION:** The password features provide a basic level of security for the data on your computer.

 **CAUTION:** Anyone can access the data that is stored on your computer, when left unattended.

 **NOTE:** System and setup password feature is disabled.

Assigning a system setup password

Prerequisites

You can assign a new **System or Admin Password** only when the status is in **Not Set**.

About this task

To enter the system setup, press F12 immediately after a power-on or reboot.

 **NOTE:** If you are connected to the Dell Pro Wireless Keyboard KM5221W, press Fn+F12.

Steps

1. In the **System BIOS** or **System Setup** screen, select **Security** and press Enter.
The **Security** screen is displayed.
2. Select **System/Admin Password** and create a password in the **Enter the new password** field.
Use the following guidelines to assign the system password:
 - A password can have up to 32 characters.
 - At least one special character: ! " # \$ % & ' () * + , - . / : ; < = > ? @ [\] ^ _ ` { | }
 - Numbers 0 through 9.
 - Upper case letters from A to Z.
 - Lower case letters from a to z.
3. Type the system password that you entered earlier in the **Confirm new password** field and click **OK**.
4. Press Esc and save the changes as prompted by the pop-up message.
5. Press Y to save the changes.
The computer restarts.

Deleting or changing an existing system setup password

Prerequisites

Ensure that the **Password Status** is Unlocked (in the System Setup) before attempting to delete or change the existing System and/or Setup password. You cannot delete or change an existing System or Setup password, if the **Password Status** is Locked.

About this task

To enter the System Setup, press F12 immediately after a power-on or reboot.

 **NOTE:** If you are connected to the Dell Pro Wireless Keyboard KM5221W, press Fn+F12.

Steps

1. In the **System BIOS** or **System Setup** screen, select **System Security** and press Enter. The **System Security** screen is displayed.
2. In the **System Security** screen, verify that **Password Status** is **Unlocked**.
3. Select **System Password**, update, or delete the existing system password, and press Enter or Tab.
4. Select **Setup Password**, update, or delete the existing setup password, and press Enter or Tab.
 **NOTE:** If you change the System and/or Setup password, reenter the new password when prompted. If you delete the System and/or Setup password, confirm the deletion when prompted.
5. Press Esc and a message prompts you to save the changes.
6. Press Y to save the changes and exit from System Setup. The computer restarts.

Clearing CMOS settings

About this task

 **CAUTION:** Clearing CMOS settings will reset the BIOS settings on your computer.

Steps

1. Turn off your computer, while keeping the AC adapter plugged in.
2. Press and hold the power button for around 25 to 40 seconds until the power LED shows blinking white light. When you release the power button, the CMOS settings are cleared and the computer restarts. A dialog box is displayed, with options to run **BIOS-Setup** and **Diagnostics**.

Clearing BIOS (System Setup) and System passwords

About this task

To clear the computer or BIOS passwords, contact Dell technical support as described at [Contact Support](#). For more information, go to [Dell Support Site](#).

 **NOTE:** For information about how to reset Windows or application passwords, see the documentation accompanying Windows or your application.

Troubleshooting

Dell SupportAssist Pre-boot System Performance Check diagnostics

About this task

SupportAssist diagnostics (also known as system diagnostics) performs a complete check of your hardware. The Dell SupportAssist Pre-boot System Performance Check diagnostics is embedded with the BIOS and launched by the BIOS internally. The embedded system diagnostics provides options for particular devices or device groups allowing you to:

- Run tests automatically or in an interactive mode.
- Repeat the tests.
- Display or save test results.
- Run thorough tests to introduce additional test options to provide extra information about one or more failed devices.
- View status messages that inform you the tests are completed successfully.
- View error messages that inform you of problems encountered during testing.

NOTE: Some tests for specific devices require user interaction. Always ensure that you are present at the computer when the diagnostic tests are performed.

For more information, see the knowledge base article [000180971](#).

Running the SupportAssist Pre-Boot System Performance Check

Steps

1. Turn on your computer.
2. As the computer boots, press the F12 key as the Dell logo appears.
3. On the boot menu screen, select the **Diagnostics** option.
4. Click the arrow at the bottom left corner.
Diagnostics page is displayed.
5. Click the arrow in the lower-right corner to go to the page listing.
The items that are detected are listed.
6. To run a diagnostic test on a specific device, press Esc and click **Yes** to stop the diagnostic test.
7. Select the device from the left pane and click **Run Tests**.
8. If there are any issues, error codes are displayed.
Note the error code and validation number and contact Dell.

System-diagnostic lights

This section lists the system-diagnostic lights of your Inspiron 27 7730 All-in-One.

Table 45. System-diagnostic lights

Blinking pattern		Problem description	Suggested resolution
Amber	White		
1	1	TPM detection failure	Replace the system board.
1	2	Unrecoverable SPI Flash Failure	Replace the system board.

Table 45. System-diagnostic lights (continued)

Blinking pattern		Problem description	Suggested resolution
Amber	White		
1	5	EC unable to program i-Fuse	Replace the system board.
1	6	Generic catch-all for ungraceful EC code flow errors	Disconnect all power source (AC, battery, coin cell) and drain flea power by pressing and holding down power button for 3~5 seconds.
2	1	CPU failure	<ul style="list-style-type: none"> Run the Dell Support Assist/Dell Diagnostics tool. If problem persists, replace the system board.
2	2	System board failure (included BIOS corruption or ROM error)	<ul style="list-style-type: none"> Flash latest BIOS version If problem persists, replace the system board.
2	3	No memory/RAM detected	<ul style="list-style-type: none"> Confirm that the memory module is installed properly. If problem persists, replace the memory module.
2	4	Memory/RAM failure	<ul style="list-style-type: none"> Reset and swap memory modules among the slots. If problem persists, replace the memory module.
2	5	Invalid memory installed	<ul style="list-style-type: none"> Reset and swap memory modules among the slots. If problem persists, replace the memory module.
2	6	System board/Chipset Error	Replace the system board.
2	7	LCD failure (SBIOS message)	Replace the LCD module.
2	8	LCD failure (EC detection of power rail failure)	Replace the system board.
3	1	CMOS battery failure	<ul style="list-style-type: none"> Reset the main battery connection. If problem persists, replace the main battery.
3	2	PCI or Video card/chip failure	Replace the system board.
3	3	BIOS Recovery image not found	<ul style="list-style-type: none"> Flash latest BIOS version If problem persists, replace the system board.
3	4	BIOS Recovery image found but invalid	<ul style="list-style-type: none"> Flash latest BIOS version If problem persists, replace the system board.
3	5	Power rail failure	Replace the system board.

Table 45. System-diagnostic lights (continued)

Blinking pattern		Problem description	Suggested resolution
Amber	White		
3	6	Flash corruption detected by SBIOS.	<ul style="list-style-type: none"> Press power button for over 25 seconds to do RTC reset. If problem persists, replace the system board. Disconnect all power source (AC, battery, coin cell) and drain flea power by pressing and holding down power button 3~5 seconds to ensure all power are drained. Run "BIOS recovery from USB", and the instructions are in the website Dell support. If problem persists, replace the system board.
3	7	Timeout waiting on ME to reply to HECI message.	Replace the system board.
4	1	Memory DIMM power rail failure	Replace the system board.
4	2	CPU power cable connection issue	Replace the system board.

NOTE: Blinking pattern 3-3-3 on Lock LED (Caps-Lock or Num-Lock), Power button LED (without Fingerprint reader), and Diagnostic LED indicates failure to provide input during LCD panel test on the "Dell SupportAssist Pre-boot System Performance Check" diagnostics.

Recovering the operating system

When your computer is unable to boot to the operating system even after repeated attempts, it automatically starts Dell SupportAssist OS Recovery.

Dell SupportAssist OS Recovery is a stand-alone tool that is preinstalled in Dell computers running Windows operating system. It consists of tools to diagnose and troubleshoot issues that may occur before your computer boots to the operating system. It enables you to diagnose hardware issues, repair your computer, back up your files, or restore your computer to its factory state.

You can also download it from the Dell Support website to troubleshoot and fix your computer when it fails to boot into the primary operating system due to software or hardware failures.

For more information about the Dell SupportAssist OS Recovery, see *Dell SupportAssist OS Recovery User's Guide* at [Serviceability Tools at the Dell Support Site](#). Click **SupportAssist** and then, click **SupportAssist OS Recovery**.

Backup media and recovery options

It is recommended to create a recovery drive to troubleshoot and fix problems that may occur with Windows. Dell provides multiple options for recovering the Windows operating system on your Dell computer. For more information, see [Dell Windows Backup Media and Recovery Options](#).

Wi-Fi power cycle

About this task

If your computer is unable to access the Internet due to Wi-Fi connectivity issues, reset your Wi-Fi device by performing the following steps:

Steps

1. Turn off the computer.
2. Turn off the modem.

 **NOTE:** Some Internet service providers (ISPs) provide a modem and router combo device.



3. Turn off the wireless router.
4. Wait for 30 seconds.
5. Turn on the wireless router.
6. Turn on the modem.
7. Turn on the computer.

Getting help and contacting Dell

Self-help resources

You can get information and help on Dell products and services using these self-help resources:

Table 46. Self-help resources

Self-help resources	Resource location
Information about Dell products and services	Dell Site
My Dell app	
Tips	
Contact Support	In Windows search, type <code>Contact Support</code> , and press Enter.
Online help for operating system	Windows Support Site Linux Support Site
Access top solutions, diagnostics, drivers and downloads, and learn more about your computer through videos, manuals, and documents.	Your Dell computer is uniquely identified using a Service Tag or Express Service Code. To view relevant support resources for your Dell computer, enter the Service Tag or Express Service Code at Dell Support Site . For more information about how to find the Service Tag for your computer, see Locate the Service Tag on your computer .
Dell knowledge base articles	<ol style="list-style-type: none"> 1. Go to Dell Support Site. 2. On the menu bar at the top of the Support page, select Support > Support Library. 3. In the Search field on the Support Library page, type the keyword, topic, or model number, and then click or tap the search icon to view the related articles.

Contacting Dell

To contact Dell for sales, technical support, or customer service issues, see [Contact Support at Dell Support Site](#).

 **NOTE:** Availability of the services may vary depending on the country or region, and product.

 **NOTE:** If you do not have an active Internet connection, you can find contact information about your purchase invoice, packing slip, bill, or Dell product catalog.