



PocketJet

PJ-722/PJ-723/PJ-762/PJ-763/PJ-763MFi/PJ-773

User's Guide English

Thank you for purchasing the Brother PocketJet PJ-722/PJ-723/PJ-762/PJ-763/PJ-763MFi/PJ-773 thermal mobile printer. We recommend that you keep this document nearby for future reference. To download the latest manuals, please visit the Brother Solutions Center (support.brother.com) where you can also download the latest drivers and applications for your printer, read FAQs and troubleshooting tips and learn about special printing solutions.

Available Manuals

You can download the latest manuals from the Brother Solutions Center at support.brother.com.

Product Safety Guide ^{1, 2}	This guide provides safety information; read it before you use the printer.
User's Guide ^{1, 2}	This guide provides basic information about using the printer along with detailed troubleshooting tips.
Online User's Guide ²	This guide includes the contents of the <i>User's Guide</i> , and additional information about the printer settings and operations, network connection and settings, troubleshooting tips, and maintenance instructions.
AirPrint Guide ²	This guide provides information for using AirPrint to print from a Mac or iOS device.
Google Cloud Print Guide ²	This guide provides details on how to use Google Cloud Print™ services for printing over the Internet.
Mobile Print/Scan Guide for Brother iPrint&Scan ²	This guide provides useful information about printing from your mobile device when the printer and the device are connected using Bluetooth or Wi-Fi®.
P-touch Template Manual ²	This manual provides information on P-touch Template.
Raster Command Reference ²	This manual provides information about printer control commands for controlling the printer directly.

¹ Printed manual in the box

² PDF manual on the Brother Solutions Center website

General Description

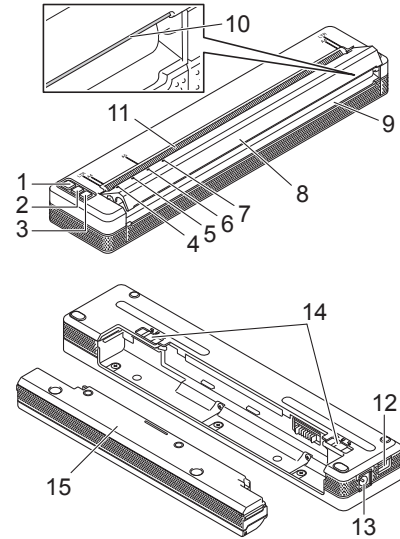

- 1 (Power) button
- 2 (Feed) button
- 3 (Bluetooth) button (PJ-762/PJ-763/PJ-763MFi only)
- 4 (Wi-Fi) button (PJ-773 only)
- 5 POWER indicator
- 6 DATA indicator
- 6 STATUS indicator
- 7 (Bluetooth) indicator (PJ-762/PJ-763/PJ-763MFi only)
- 7 (Wi-Fi) indicator (PJ-773 only)
- 8 Release cover
- 9 Paper outlet slot
- 10 Tear bar
- 11 Paper input slot
- 12 USB port
- 13 DC connector
- 14 Battery latches
- 15 Battery cavity mounting block

LED Indicators

PJ-722/PJ-723

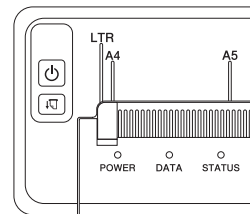

PJ-762/PJ-763/PJ-763MFi

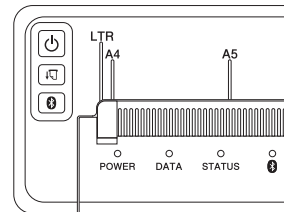

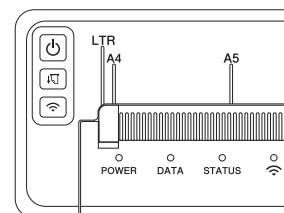

PJ-773





The indicators light and flash to indicate the printer's status. Each indicator may light or flash in green, red, orange or blue.

Button Functions

 (Power) button function	Operation
Turn the printer on	Press and hold the button for about one second until the POWER indicator turns on.
Turn the printer off	Press and hold the button for about one second or press it quickly two times depending on the printer setting (see the <i>Online User's Guide</i> for more information).

 (Feed) button function	Operation
Feed paper	Load the paper and press the button to feed the paper.
Print the printer settings	To print the printer settings without connecting the printer to a computer or mobile device: 1 Turn the printer on and make sure no paper is loaded. 2 Press and hold the button until the DATA indicator lights in red. 3 Load paper.

 (Bluetooth) button function (PJ-762/PJ-763/PJ-763MFi only)	Operation
Enable/disable the Bluetooth function	Press and hold the button for one second to enable or disable the Bluetooth function of the printer.

 (Wi-Fi) button function (PJ-773 only)	Operation
Enable/disable the Wi-Fi function	Press and hold the button for one second to enable or disable the Wi-Fi function of the printer.
Use WPS to configure Wi-Fi settings easily	Press and hold the button for about five seconds to configure the Wi-Fi settings using WPS.

Use the Rechargeable Li-ion Battery (Optional)

Installing the Rechargeable Li-ion Battery

1. Move battery latch 1 to the unlock position.
2. While holding battery latch 2 in the unlock position, remove the battery cavity mounting block.

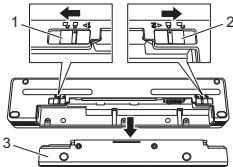

- 1 Battery latch 1
- 2 Battery latch 2
- 3 Battery cavity mounting block

3. Release battery latch 2. Battery latch 2 moves back to the lock position.
4. Insert the battery into the battery cavity until it locks into place.

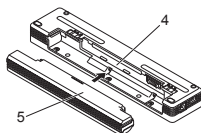

- 4 Battery cavity
- 5 Rechargeable Li-ion battery

5. Move battery latch 1 to the lock position.

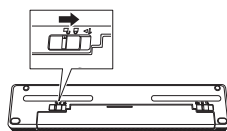

Removing the Rechargeable Li-ion Battery

1. Move the battery latches to the unlock position, and then remove the battery.

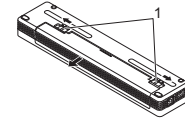

- 1 Battery latches

2. Insert the battery cavity mounting block into the battery cavity until it locks into place.
3. Move battery latch 1 to the lock position.

Charging the Rechargeable Li-ion Battery

NOTE

- Charge the battery immediately after purchase using the following procedure.
- Up to three hours are needed to fully charge the rechargeable Li-ion battery. When fully charged, the battery will print about 600 pages.

1. Turn the printer off and install the battery.
2. Use the AC adapter and AC power cord to connect the printer to an AC power outlet, or use the car adapter to connect the printer to a DC power outlet.

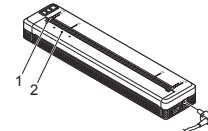

- 1 POWER indicator
- 2 STATUS indicator

3. When the battery is fully charged, the STATUS indicator turns off. Disconnect the AC adapter or car adapter from the DC connector.

Stopping Rechargeable Li-ion Battery Charging

To stop the battery charging, disconnect the AC adapter or car adapter from the DC connector.

Notes on Using the Rechargeable Li-ion Battery

- Fully charge the battery before use. Do not use it before it is fully charged.
- High density (dark) printing discharges the battery faster than low density printing. Adjust the print density setting in the printer driver's dialog box or Printer Setting Tool (see the *Online User's Guide*).
- The battery charging must take place in 32°F - 104°F (0°C - 40°C) environments, otherwise the battery will not be charged, and the STATUS indicator will remain lit.
- If you use the printer when both the battery is installed and the AC adapter or car adapter is connected, the STATUS indicator may turn off and charging may stop even if the battery has not been fully charged.

Rechargeable Li-ion Battery Characteristics

To ensure the highest performance and longest life from your the battery:

- Do not use or store the battery in a location exposed to extreme high or low temperatures as it may discharge more quickly. This may happen when using a rechargeable Li-ion battery with a high charge (charged 90% or more) in a location exposed to high temperatures.
- Remove the battery when storing the printer for long periods of time.
- Store batteries with less than a 50% charge in a cool dry place out of direct sunlight.
- Recharge the battery every six months if it is stored for long periods of time.

Connect the Printer to External Power

Connecting to an AC Power Outlet (Optional)

Connect the printer to a nearby AC power outlet to power the printer or charge the rechargeable Li-ion battery using AC power.

1. Connect the AC adapter to the printer.
2. Connect the AC power cord to the AC adapter.
3. Connect the AC power cord to a nearby AC power outlet (100 - 240 VAC, 50 - 60 Hz).

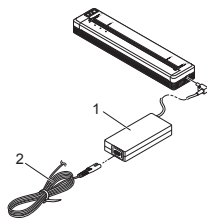

- 1 AC adapter
- 2 AC power cord

NOTE

The AC adapter and AC power cord are optional accessories. When purchasing, choose an adapter and power cord appropriate for the region where the printer will be used.

Connecting to a DC Power Outlet (Optional)

Connect the printer to your vehicle's 12 V DC power outlet (cigarette lighter or similar) to power the printer or charge the rechargeable Li-ion battery using the vehicle's DC power.

1. Connect the car adapter to the vehicle's 12 V DC power outlet.
2. Connect the car adapter to the printer.

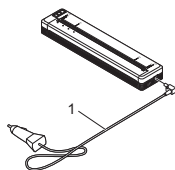

- 1 Car adapter

NOTE

- The car adapter is an optional accessory.
- The voltage supplied by a vehicle may fluctuate, and printing speed may vary.
- The maximum voltage is 12 V DC.
- The car adapter plug is not compatible with other outlets that are not the 12 V cigarette type.
- When the car adapter is connected to charge the rechargeable Li-ion battery, the amount of voltage required to fully charge the battery may not be supplied by the DC power outlet. If 9 hours have passed since charging started, the STATUS indicator turns off and charging stops even if the rechargeable Li-ion battery has not been fully charged.

Install Software to Your Computer or Mobile Device

Several printing methods are available depending on your printer model and the computer or mobile device you use to print from. Refer to the *Online User's Guide* for more information and install other applications to your computer or mobile device as needed.

Installing the Printer Driver and Applications (When Using a Windows® PC or Mac)

To print from your Windows® PC or Mac, install the printer driver, P-touch Editor and other applications to your computer.

1. Visit our website (www.brother.com/inst/) and download the installer for the software and documents.
2. Double-click the downloaded .exe file and follow the on-screen instructions to proceed with the installation. Select the software you want in the installer's software selection window.

Updating the Printer Drivers and Applications

You can download the latest versions from the Brother Solutions Center website (support.brother.com). We recommend you visit the website to make sure you have the latest version of the drivers and applications.

A software development kit (SDK) is available. Visit the Brother Developer Center (www.brother.com/product/dev/index.htm).

Connect the Printer to a Computer or Mobile Device

The printer can be connected to your computer or mobile device using a USB cable or via a Bluetooth connection (PJ-762/PJ-763/PJ-763MFi only) or Wi-Fi connection (PJ-773 only). For more information, see the *Online User's Guide*.

Connecting Using USB



1. Make sure the printer is turned off before connecting the USB cable.
2. Connect the printer end of the USB cable to the USB port on the side of the printer.
3. Connect the other end of the USB cable to the USB port on the computer.

Connecting Using Bluetooth (PJ-762/PJ-763/PJ-763MFi only)



NOTE

- Follow the recommendations of the manufacturer of your Bluetooth-equipped devices (computers and mobile devices) or Bluetooth adapter and install any necessary hardware and software.
- The Bluetooth connection settings are saved even after the printer is turned off.

Use this procedure to pair the printer with the computer or mobile device using the Bluetooth management software.

1. Press and hold the  (Power) button to turn the printer on, and then press and hold the  (Bluetooth) button.
2. Use your Bluetooth device management software to discover the printer.

Connecting Using Wi-Fi® (PJ-773 only)

1. Press and hold the  (Wi-Fi) button for one second.
The  (Wi-Fi) indicator on your printer starts flashing in blue once every three seconds.
2. Use your computer or mobile device to select the SSID of your printer ("DIRECT-*****_PJ-773"). If required, enter the password ("773*****").

NOTE

For more information about connecting using Wi-Fi, see the *Online User's Guide*.

Printing

1. Open the document to be printed on your computer or mobile device.
2. Make sure the printer is correctly powered. Use a fully charged battery, or connect the printer to an AC or DC power outlet.
3. Turn the printer on by pressing and holding the  (Power) button for about one second.
The POWER indicator lights in green (if the printer is connected to an AC or DC power outlet) or in orange (if the rechargeable Li-ion battery is used).

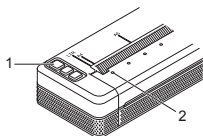

- 1  (Power) button
- 2 POWER indicator

4. Connect the printer to a computer or mobile device using USB, Bluetooth or Wi-Fi. For more information, see the *Online User's Guide*.
5. Load paper. Use both hands to hold the paper straight, and then carefully insert the paper into the printer's input slot until the roller pulls it into the starting position. For best results, use genuine Brother paper.

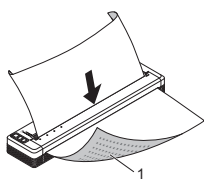

- 1 Print surface

NOTE

- The bottom edge of the paper must be parallel to the roller.
- Only one side of the paper can be printed on. Check the paper, and load it so that the smooth, thermal side faces down.

6. Print from the application.
The DATA indicator flashes in green to indicate that the printer is receiving data, and then the document is printed.

NOTE

If necessary, change the printer settings in the printer driver's dialog box or Printer Setting Tool. For more information, see the *Online User's Guide*.

Notes on Using Paper

You can set the paper type to **[Cut Sheet]**, **[Roll]** or **[Perforated Roll]** in the printer driver.

NOTE

Roll paper can be cut using the printer's tear bar. Pull one edge of the ejected paper up and toward the other edge diagonally.
*The tear bar is sharp. To avoid injury, do not touch the tear bar.

Clearing a Paper Jam

1. Carefully lift the release cover up to open it.

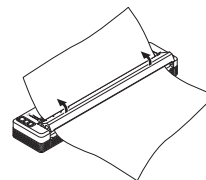

2. Carefully pull the paper out of the printer in either direction.

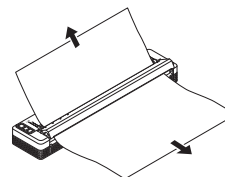



3. Close the release cover.
4. Insert paper and print again.

LED Indicators

The indicators light and flash to indicate the printer's status. The symbols used in this section explain the meaning of the different indicator colors and patterns:

 = Indicator is lit































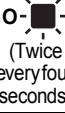



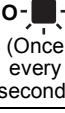





















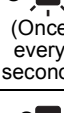













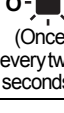
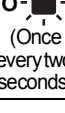

 = Indicator is flashing

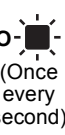
 = Indicator is lit or flashing in any color











(Off) = Indicator is off

G = Green
O = Orange
R = Red
B = Blue





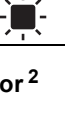

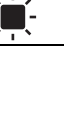



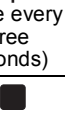

Example: **G**- = Indicator is flashing in green

POWER	DATA	STATUS	Bluetooth ¹	Wi-Fi ²	Description
G - 		(Off)			Battery charging completed with the AC adapter or car adapter connected
G - 		O - 			Battery charging
O - 		(Off)			Rechargeable Li-ion battery in use, battery charge is full
O - 		O -  (Once every four seconds)			Rechargeable Li-ion battery in use, battery charge is half-full
O - 		O -  (Twice every four seconds)			Rechargeable Li-ion battery in use, battery charge is low
R -  (Once every second)	(Off)	O -  (Once every second)			Rechargeable Li-ion battery in use, charge the battery
(Off)		O - 			Battery charging while printer is turned off
G/O -  ³	(Off)				Printer in idle mode
G/O -  ³	G - 				Receiving data
G/O -  ³	G - 				Printing, or buffer contains unprinted data
G/O -  ³	O -  (Once every second)	(Off)			Transferring data
G/O -  ³	O - 	(Off)			Updating a template or program
G/O -  ³	R - 				Maintenance mode/self printing/cleaning
G/O -  ³	R -  ³	R -  ³	(Off)	(Off)	Printer in boot mode
G/O -  ³	O -  (Once every two seconds)	O -  (Once every two seconds)			Printer cooling down
O -  (Once every second)	(Off)	O - 			Communication error No template error Memory full error Access point search error ² Access point connection error ² Security error ²
R -  ³	R -  ³	(Off)	(Off)	(Off)	Mass storage error
R -  ³	R -  ³	R -  ³	(Off)	(Off)	System error

Bluetooth indicator¹

POWER	DATA	STATUS	Bluetooth	Description
			B - 	Bluetooth on, connected
			B - 	Pairing with Bluetooth
R - 	R - 	R - 	B - 	Bluetooth module error

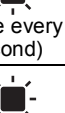
Wi-Fi indicator²

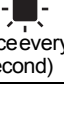
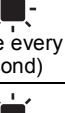
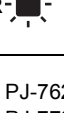
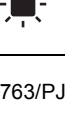
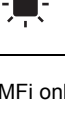
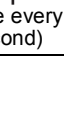
POWER	DATA	STATUS	Wi-Fi	Description
			B -  (Once every three seconds)	Wi-Fi on, not connected
			B - 	Wi-Fi on, connected
			B -  (Once every second)	WPS setup
		O -  (Once every second)	B -  (Once every second)	WPS setup failed
R - 	R - 	R - 	B -  (Once every second)	Wi-Fi module error

¹ PJ-762/PJ-763/PJ-763MFi only

² PJ-773 only

³ When the AC adapter or car adapter is used to power the printer, the indicator is lit in green; when the rechargeable Li-ion battery is installed to power the printer, the indicator is lit in orange.

Indicator Warnings

Problem	Solution
The POWER indicator does not light	The printer is receiving no power. If you are using AC or DC power, connect the AC adapter or car adapter correctly and turn the AC or DC power outlet on. If you are using a rechargeable Li-ion battery, make sure the battery is firmly installed in the printer and is fully charged.
Received data in buffer	Print data is saved in the buffer. If the printer receives incomplete data (for example because of a lost Wi-Fi connection), printing will not start. Turn the printer off, and then turn it on again.
Head or motor is cooling down	The thermal head or motor is too hot. Head: The printer stops and resumes printing only after the thermal head has cooled down. The head may become too hot if you are printing a large number of documents with high text content. If the thermal head becomes too hot, it may produce imaging on the paper in areas not intended to be printed. To avoid or delay overheating, use a lighter density setting, reduce the amount of black space being printed (for example, remove background shading and colors in graphs and presentation documents), and make sure the printer has adequate ventilation and is not located in an enclosed space. Motor: Continuously using the printer will cause the motor to heat up. If it becomes too hot, in this case, the printer will stop and resume printing after the motor has cooled down. NOTE This condition may occur more often when the printer is used at high altitude (more than 10,000 ft (3,048 m)) due to a lower air density available to cool the printer.
Data reception error	With unstable communication, it may not be possible to receive data correctly. Improve the communication conditions, and then establish the connection again.
Printer is in boot mode	To resolve the issue, contact your Brother dealer or Brother customer service for assistance.

Troubleshooting





Paper Problems

Problem	Solution
The paper is jammed in the printer	See <i>Clearing a Paper Jam</i> .
The paper feeds through the printer, but nothing appears on the paper	Make sure you are using thermal paper. The print surface must face the back, when looking from the front of the printer.
The paper does not feed even though the motor is running	The release cover must be completely closed. You must use genuine Brother thermal paper. Other paper may not feed through the printer correctly. If you still have problems, the printer may be damaged. Contact your Brother dealer or Brother customer service for assistance.

Printed Image Problems

Problem	Solution
The image is compressed and stretched in many places	Make sure the release cover was not left open during printing. If it is open, close it completely. You must use genuine Brother thermal paper. Before loading paper, make sure it is not wrinkled.

Pages Do Not Print

Problem	Solution
The DATA indicator remains lit in green but the printer does not print	<ul style="list-style-type: none"> ■ Printing of all received data is not completed. Wait until it is finished. ■ If paper is not loaded, load the paper. ■ If the printer does not print even though paper is loaded, remove the paper, and then load it again. ■ Try printing again after turning the printer off, and then on again. NOTE If the printer is connected via Wi-Fi (PJ-773 only), the connection is lost when the printer is turned off. When the printer is turned on again, it will take up to 15 seconds for Wi-Fi to become functional.
The application should be sending data to the printer, but the DATA indicator does not light in green	<ul style="list-style-type: none"> ■ There may be problems with sending simple ASCII text data to the printer. If the CR/LF command is not at the end of lines or the form feed command is not at the end of the last line, the printer may be waiting for this data to be sent. Print another page, or press the  (Feed) button to feed the paper. ■ The printer may have been started up in mass storage mode (see the <i>Online User's Guide</i> for more information). Turn the printer off, and then turn it on again. <ul style="list-style-type: none"> ■ With a USB connection: <ol style="list-style-type: none"> 1 Connect the USB cable firmly and correctly. 2 Try using another USB cable. ■ With a Bluetooth connection (PJ-762/PJ-763/PJ-763MFi only): <ol style="list-style-type: none"> 1 Check that the  (Bluetooth) indicator is lit in blue. If the  (Bluetooth) indicator is flashing or turned off, the Bluetooth connection is not established. To establish a Bluetooth connection, refer to <i>Connecting Using Bluetooth (PJ-762/PJ-763/PJ-763MFi only)</i>. 2 Specify the correct Bluetooth settings in the Printer Setting Tool (see the <i>Online User's Guide</i> for more information). ■ With a Wi-Fi connection (PJ-773 only): <ol style="list-style-type: none"> 1 Check that the  (Wi-Fi) indicator is lit in blue. If the  (Wi-Fi) indicator is flashing or turned off, the Wi-Fi connection is not established. To establish a Wi-Fi connection, refer to <i>Connecting Using Wi-Fi® (PJ-773 only)</i>. 2 Specify the correct Wi-Fi settings in the Printer Setting Tool (see the <i>Online User's Guide</i> for more information).

Pages Are Partially Printed

Problem	Solution
The DATA indicator turns off while a page remains in the printer	The computer or mobile device may not have sent a full page of data. Try printing the document again. The computer or mobile device may have sent the wrong page size information, or the size of the loaded paper is wrong.
The printer ejects a partially printed page, and the DATA indicator remains lit or flashing in green	Use the correct paper size setting.

Printer Maintenance

Cleaning the Platen Roller

Dirt and debris on the platen roller can cause the paper to be fed incorrectly (skewing the print image) and degrade the print quality (distorting the print image).

Follow the procedure below to clean the platen roller:

1. Turn the printer on and make sure no paper is loaded.
2. Insert the cleaning sheet into the paper input slot. The text "CLEANING SHEET" should be upright and face the front of the printer, as shown. The roller will pull the cleaning sheet into the starting position.

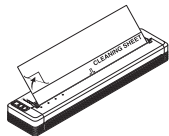

3. Remove the backing paper on the upper half of the cleaning sheet, as shown.

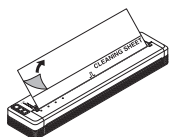

NOTE

Do not remove the backing paper from the lower half of the cleaning sheet.

4. Press the  (Feed) button for more than two seconds. The printer will feed and eject the cleaning sheet.

Cleaning the Printer's Surface

To clean the printer's surface, wipe it with a dry cloth.

Do not use a wet cloth or allow water to enter the printer.

Do not use benzene, alcohol, paint thinner, or cleaners that are abrasive, alkaline, or acidic. Such cleaners may damage the printer's surface.

Product Specifications

Model Name	PJ-722/PJ-723/PJ-762/PJ-763/PJ-763MFi/ PJ-773
Dimensions	Approximately 10.04 (W) x 2.17 (D) x 1.18 (H) in. / 255 (W) x 55 (D) x 30 (H) mm
Weight	Approximately 1.06 lb. / 480 g (excluding battery, paper) Approximately 1.34 lb. / 610 g (including battery, excluding paper)
Printing	
Method	Direct thermal printing
Interface	
USB	USB Ver. 2.0 (Full Speed) (mini-B, Peripheral) Printer class: Mass storage (2.5 MB of memory)
Bluetooth (PJ-762/PJ-763/PJ-763MFi only)	PJ-762/PJ-763 Ver 2.1 + EDR Class 1 Supported profiles: SPP, OPP, BIP, HCRP PJ-763MFi Ver 2.1 + EDR Class 1 Supported profiles: SPP, OPP, BIP, HCRP, iAP
Wi-Fi (PJ-773 only)	<ul style="list-style-type: none">• Wireless Direct: IEEE802.11g/n• Ad-hoc Mode: IEEE802.11b/g/n• Infrastructure Mode: IEEE802.11b/g/n• WPS 2.0
Environment	
Operating temperature	14°F - 122°F/-10°C - 50°C
Operating humidity	20 - 80% (No condensation)
Storage temperature	-4°F - 140°F/-20°C - 60°C
Storage humidity	20 - 80% (No condensation)

Confirm the Printer Settings

This feature is used to print a Letter-size report without connecting the printer to a computer or mobile device. (The report will fit on A4-size paper.)

NOTE

The printer report contains the following information: The program version, device setting information, serial number, Bluetooth setting information (for PJ-762, PJ-763 or PJ-763MFi) and Wi-Fi setting information (PJ-773 only).

To print the printer settings report:

1. Turn the printer on and make sure no paper is loaded.
2. Press and hold the  (Feed) button until the DATA indicator lights in red.
3. Insert a piece of genuine Brother thermal paper into the printer's paper input slot. The report will print automatically, and then the printer will return to idle mode.

Useful Internet Addresses

Brother Global website: www.brother.com

Brother Developer Center: www.brother.com/product/dev/

For frequently asked questions (FAQs), troubleshooting tips and driver and application updates, visit the Brother Solutions Center: support.brother.com