



Installation Guide

Indoor Access Point

CONTENTS

Deutsch	01
English	05
Español.....	09
Ελληνικά	13
Français	17
Italiano	21
Português.....	25
Suomi	29
Nederlands.....	33
Svenska.....	37
Norsk.....	41
Dansk	45

Hinweis: Die Bilder können vom tatsächlichen Aussehen des Produkts abweichen.

Netztopologie

Unten sehen Sie eine typische Netztopologie für den Einsatz eines APs.

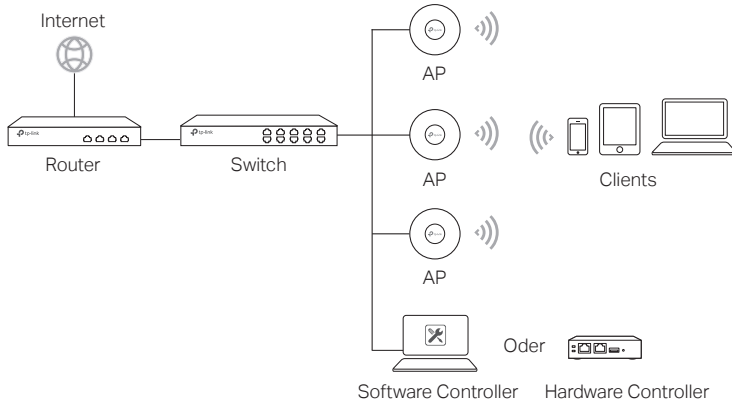

Die APs können über den Controller zentral konfiguriert und überwacht werden. Sie können den Controller über <https://www.tp-link.com> kaufen oder sich an das Verkaufspersonal wenden.

Hardwareinstallation

■ Option 1: Deckenmontage

Gehen Sie bitte wie folgt vor, um Ihren AP mit den beiliegenden Hilfsmitteln zu installieren:

Hinweis: Die Montagehalterung und das Zubehör (Anzahl und Größe) können je nach Produkt variieren.



Unterlegscheiben



Flachkopfschrauben



Flügelmutter

- 1 Entfernen Sie die Deckenkachel.

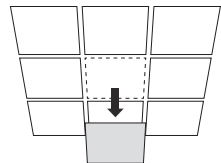

- 2 Platzieren Sie die Montagehalterung in der Mitte der Deckenplatte. Markieren Sie die Positionen für die Schraubenlöcher und eine Position für das Loch für das Ethernet-Kabel. Bohren Sie an den markierten Stellen Löcher mit 4 mm Durchmesser für die Schrauben und ein Loch mit 25 mm Durchmesser für das Ethernet-Kabel.

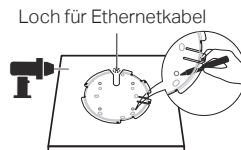

- 3 Fixieren Sie die Montageklammer mittels Flachkopfschrauben, Unterlegscheiben und Flügelmutter an der Decke.

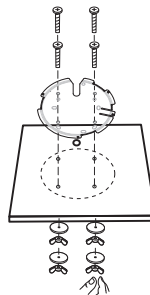

- 4 Schieben Sie das Ethernetkabel durch das Loch und bauen Sie die Deckenkachel wieder ein.

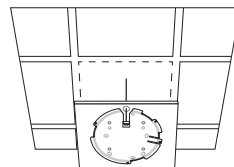

- 5 Verbinden Sie das Ethernetkabel mit dem Ethernet-Port. Bringen Sie den AP an der Montageklammer an, indem Sie die beiden Pfeile auf dem AP und auf der Montageklammer aneinander ausrichten und den AP dann drehen, bis er einrastet.

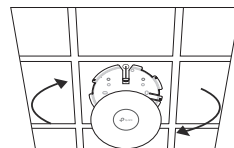

■ Option 2: Wandmontage

Gehen Sie bitte wie folgt vor, um den AP mit den beiliegenden Hilfsmitteln zu montieren:

Hinweis: Die Montagehalterung und das Zubehör (Anzahl und Größe) können je nach Produkt variieren.



Dübel



Schrauben

- 1** Wenn Ihr Ethernet-Kabel durch die Wand geführt wird, positionieren Sie die Halterung und führen Sie das Ethernet-Kabel ein. Markieren Sie die Positionen für die Schraublöcher und bohren Sie dann an den markierten Stellen Löcher mit 6 mm Durchmesser.

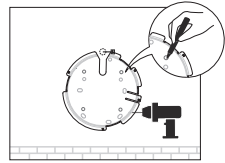

- 2** Führen Sie die Dübel in die 6 mm-Löcher ein.

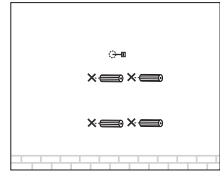

- 3** Fixieren Sie die Montageklammer an der Wand, indem Sie die Schrauben in die Dübel drehen. Stellen Sie sicher, dass die Haken der Montageklammer nach außen zeigen.

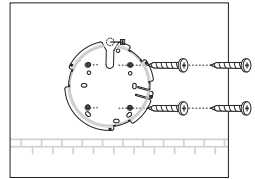

- 4** Verbinden Sie das Ethernetkabel mit dem Ethernet-Port des AP.

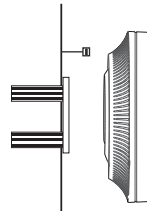

- 5** Bringen Sie den AP an der Montageklammer an, indem Sie die beiden Pfeile auf dem AP und auf der Montageklammer aneinander ausrichten und den AP dann drehen, bis er einrastet.

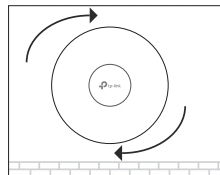

Spannungsversorgung

■ Versorgung mittels PSE-Gerät oder Spannungs-adapter

Einige APs können über das Netzteil oder das PSE-Gerät (z. B. einen PoE-Switch) mit Strom versorgt werden, das der Stromquellenklasse 2 (PS2) oder der begrenzten Stromquelle (LPS) der IEC 62368-1 entspricht.

Hinweis: Die Verfügbarkeit hängt von dem jeweiligen Produkt ab. Bitte beachten Sie die Produktspezifikationen.

Über PoE-Switch

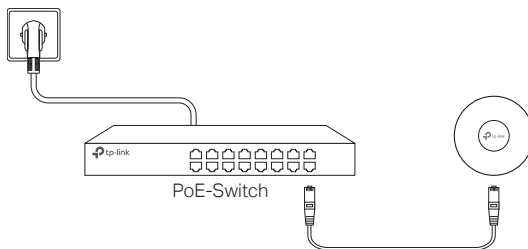

Via Power Adapter

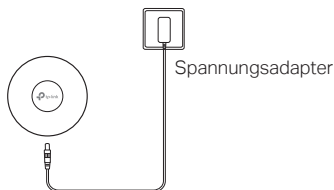

■ Mittels PoE-Adapter

Einige APs können über den PoE-Adapter mit Strom versorgt werden.

Hinweis: Die Verfügbarkeit hängt von dem jeweiligen Produkt ab. Bitte beachten Sie die Produktspezifikationen.

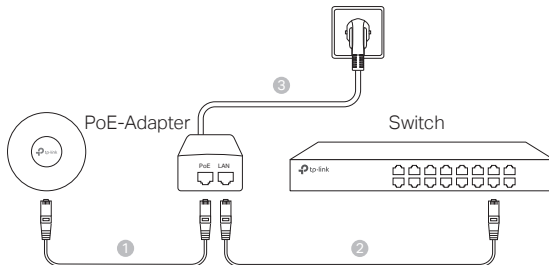

Note: Images may differ from your actual product.

Network Topology

A typical network topology for the AP is shown below.

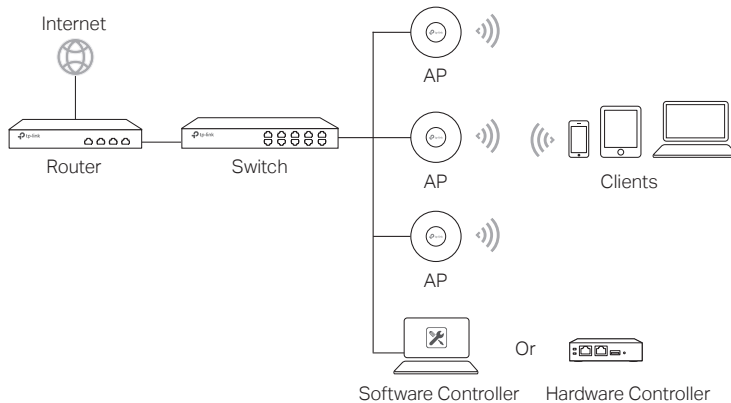

APs can be centrally configured and monitored via Controller. You can get the Controller from <https://www.tp-link.com> or contact the sales staff.

Hardware Installation

■ Option 1: Ceiling Mounting

Follow the steps below to install the AP with the provided accessories:

Note: The mounting bracket and the accessories (quantity and size) may vary by product.



Washers



Pan-head Screws



Wing Nuts

- 1 Remove the ceiling tile.

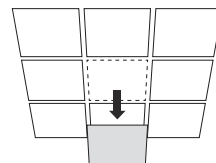

- 2 Place the mounting bracket in the center of the ceiling tile. Mark positions for the screw holes and a position for the Ethernet cable hole. Drill 4 mm diameter holes for the screws and a 25 mm diameter hole for the Ethernet cable at the marked positions.

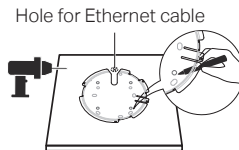

- 3 Secure the mounting bracket to the ceiling tile using pan-head screws, washers and wing nuts.

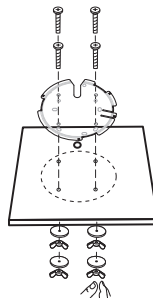

- 4 Feed the Ethernet cable through the hole and set the ceiling tile back into place.

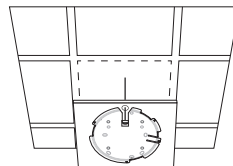

- 5 Connect the Ethernet cable to the Ethernet port. Attach the AP to the mounting bracket by aligning the arrow mark on the AP with the arrow mark on the mounting bracket, then rotate the AP until it is locked into place.

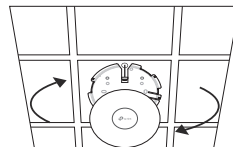

■ Option 2: Wall Mounting

Follow the steps below to install the AP with the provided accessories:

Note: The mounting bracket and the accessories (quantity and size) may vary by product.



Plastic Wall Anchors



Self-tapping Screws

- 1** If your Ethernet cable feeds through the wall, position the mounting bracket and feed the Ethernet cable. Mark positions for the screw holes and then drill 6 mm diameter holes at the marked positions.

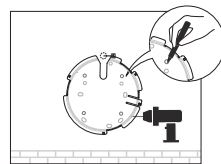

- 2** Insert the plastic wall anchors into the 6 mm diameter holes.

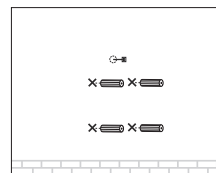

- 3** Secure the mounting bracket to the wall by driving the self-tapping screws into the anchors. Make sure that the shoulders of the mounting bracket are on the outside.

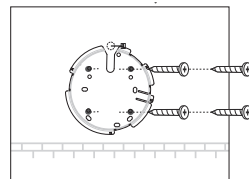

- 4** Connect the Ethernet cable to the Ethernet port on the AP.

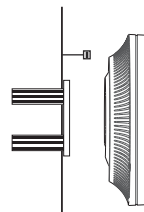

- 5** Attach the AP to the mounting bracket by aligning the arrow mark on the AP with the arrow mark on the mounting bracket, then rotate the AP until it is locked into place.

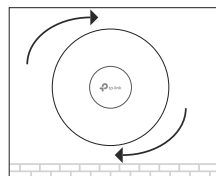

Power Supply

■ Power via PSE Device or Power Adapter

Some APs can be powered via the power adapter or the PSE device (such as a PoE switch) which complies with Power Source Class 2 (PS2) or Limited Power Source (LPS) of IEC 62368-1.

Note: Availability depends on the actual product. Please refer to the product specifications.

Via PoE Switch

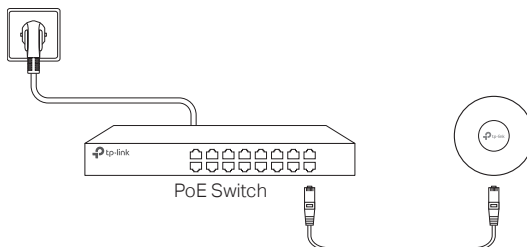

Via Power Adapter

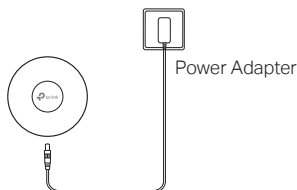

■ Power via PoE Adapter

Some APs can be powered via the PoE adapter.

Note: Availability depends on the actual product. Please refer to the product specifications.

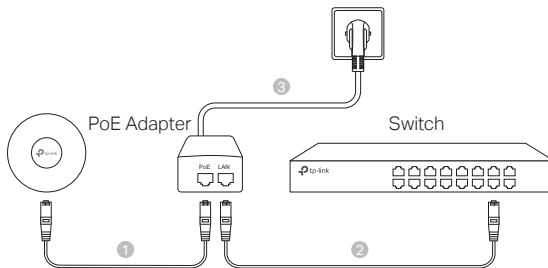

Nota: La imagen puede ser diferente respecto al producto actual.

Topología de Red

Una topología de red típica para el AP es la que se muestra a continuación.

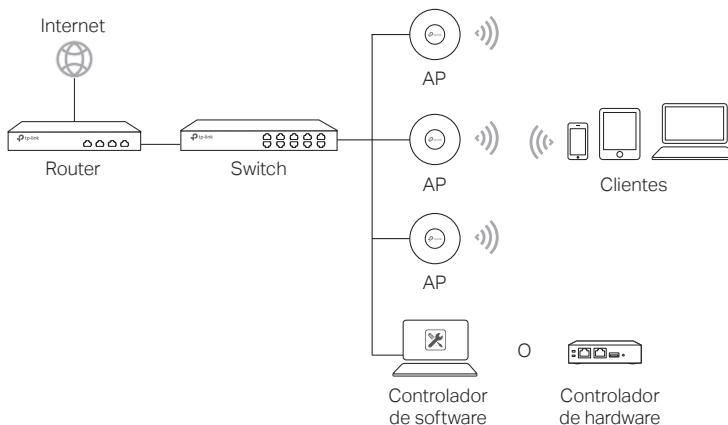

Los AP pueden configurarse y supervisarse de forma centralizada a través del Controller. Puede obtener el Controller en <https://www.tp-link.com> o ponerse en contacto con el personal de ventas.

Hardware: Instalación

■ Opción 1: Montaje de Techo

Siga los pasos de abajo para instalar el AP con los accesorios proporcionados:

Nota: El soporte de montaje y los accesorios (cantidad y tamaño) pueden variar según el producto.



Arandelas



Tornillos de cabeza plana



Tuercas de Mariposa

- 1 Quite las baldosas del techo.

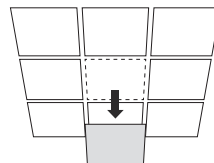

- 2** Coloque el soporte de montaje en el centro de la placa del techo. Marque las posiciones para los orificios de los tornillos y una posición para el orificio del cable Ethernet. Taladre orificios de 4 mm de diámetro para los tornillos y un orificio de 25 mm de diámetro para el cable Ethernet en las posiciones marcadas.

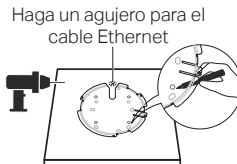

- 3** Fije el soporte de montaje al revestimiento del techo usando tornillos de cabeza plana, arandelas y tuercas de mariposa.

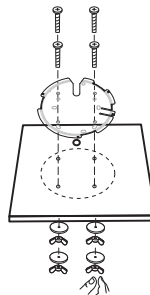

- 4** Pase el cable Ethernet a través del agujero y establezca de nuevo el panel de techo en su lugar.

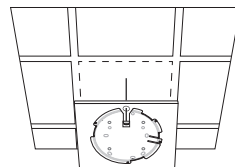

- 5** Conecte el cable Ethernet al puerto ETHERNET. Fije el AP a la abrazadera de montaje alineando la marca del arco en el AP con la marca del arco de la abrazadera de montaje, después gire el AP hasta que se cierre.

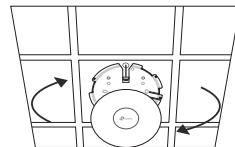

■ Opción 2: Montaje de Pared

Siga los pasos de abajo para instalar el AP con los accesorios proporcionados:

Nota: El soporte de montaje y los accesorios (cantidad y tamaño) pueden variar según el producto.



Anclajes de Pared de Plástico



Tornillos Autoenroscables

- 1** Si su cable Ethernet atraviesa la pared, coloque el soporte de montaje y pase el cable Ethernet. Marque las posiciones para los orificios de los tornillos y, a continuación, taladre orificios de 6 mm de diámetro en las posiciones marcadas.

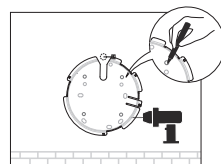

- 2** Inserte los anclajes de pared de plástico en los agujeros de 6 mm de diámetro.

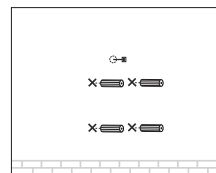

- 3** Fije la abrazadera de montaje con los tornillos autoenroscables en los anclajes. Asegúrese que los hombros de la abrazadera están fuera.

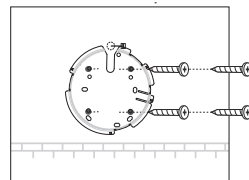

- 4** Conecte el cable Ethernet al puerto ETHERNET en el AP.

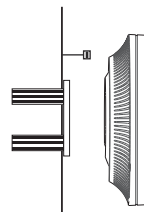

- 5** Inserte el AP en la abrazadera de montaje alineando las marcas de los arcos en el AP con las marcas de los arcos en la abrazadera de montaje, después gire el AP hasta que se cierre.

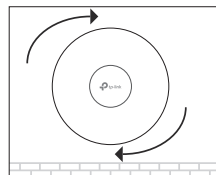

Fuente de Alimentación

■ Alimentación mediante Dispositivo PSE o Fuente de Alimentación

Algunos AP pueden alimentarse a través del adaptador de corriente o del dispositivo PSE (como un switch PoE) que cumple con la clase de fuente de alimentación 2 (PS2) o fuente de alimentación limitada (LPS) de IEC 62368-1.

Nota: La disponibilidad depende del producto real. Consulte las especificaciones del producto.

Mediante Switch PoE

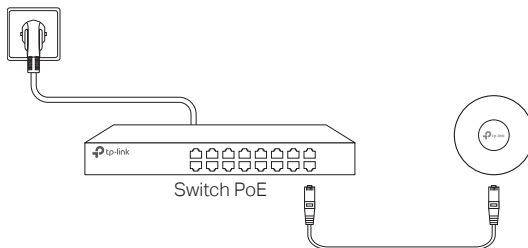

Mediante Fuente de Alimentación



■ Alimentación mediante Adaptador PoE

Algunos AP pueden alimentarse a través del adaptador PoE.

Nota: La disponibilidad depende del producto real. Consulte las especificaciones del producto.

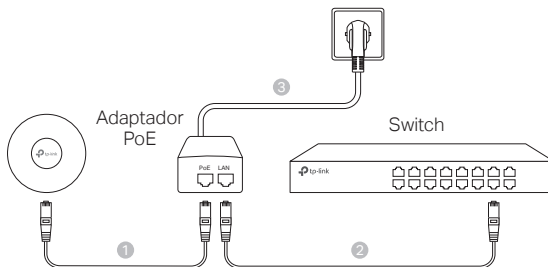

Σημείωση: Οι εικόνες μπορεί να διαφέρουν από το πραγματικό προϊόν

Τοπολογία Δικτύου

Παρακάτω φαίνεται μία τυπική τοπολογία δικτύου για το AP

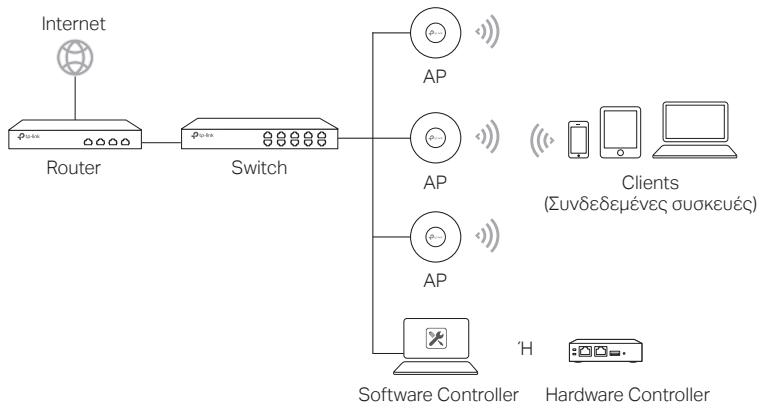

Τα AP μπορούν να ρυθμιστούν και να παρακολουθούνται κεντρικά μέσω του Controller. Μπορείτε να προμηθευτείτε το Controller από τη διεύθυνση <https://www.tp-link.com> ή να επικοινωνήσετε με το προσωπικό πωλήσεων.

Εγκατάσταση Συσκευής

■ Επιλογή 1: Εγκατάσταση σε Οροφή

Ακολουθήστε τα εξής βήματα για να εγκαταστήσετε το AP χρησιμοποιώντας τα παρεχόμενα εξαρτήματα:

Σημείωση: Η βάση στήριξης και τα εξαρτήματα (ποσότητα και μέγεθος) ενδέχεται να διαφέρουν ανάλογα με το προϊόν.



Ροδέλες



Βίδες για σταυροκατσάβιδο



Πεταλούδες

1 Αφαιρέστε το πλακίδιο οροφής.

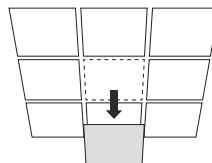

2

Τοποθετήστε τη βάση στήριξης στο κέντρο του πλακιδίου οροφής. Σημειώστε τις θέσεις για τις οπές των βιδών και μια θέση για την οπή του καλωδίου Ethernet. Ανοίξτε οπές διαμέτρου 4 mm για τις βίδες και μια οπή διαμέτρου 25 mm για το καλώδιο Ethernet στις σημειωμένες θέσεις.

Τρύπα για καλώδιο Ethernet

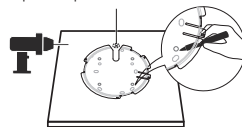

3

Στερεώστε τη βάση στήριξης στο πλακίδιο οροφής χρησιμοποιώντας βίδες για σταυροκατσάβιδο, ροδέλες και πεταλούδες.

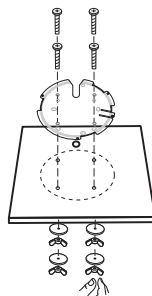

4

Περάστε το καλώδιο Ethernet μέσα από την τρύπα και τοποθετήστε το πλακίδιο πάλι στη θέση του στην οροφή.

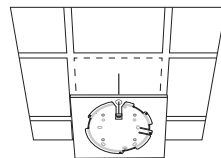

5

Συνδέστε το καλώδιο Ethernet στη θύρα ETHERNET. Προσαρμόστε το AP στη βάση στήριξης, ευθυγραμμίζοντας το βελάκι που βρίσκεται στο AP με το αντίστοιχο βελάκι που υπάρχει στη βάση στήριξης και στη συνέχεια περιστρέψτε το AP μέχρι να κλειδώσει στη θέση του.

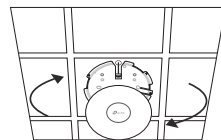

■ Επιλογή 2: Εγκατάσταση σε τοίχο

Ακολουθήστε τα εξής βήματα για να εγκαταστήσετε το AP χρησιμοποιώντας τα παρεχόμενα εξαρτήματα:

Σημείωση: Η βάση στήριξης και τα εξαρτήματα (ποσότητα και μέγεθος) ενδέχεται να διαφέρουν ανάλογα με το προϊόν.



Πλαστικά ούπα



Βίδες για ούπα

- 1** Εάν το καλώδιο Ethernet περνά διαμέσου του τοίχου, τοποθετήστε τη βάση στήριξης και περάστε το καλώδιο Ethernet. Σημειώστε τις θέσεις για τις οπές των βιδών και στη συνέχεια ανοίξτε οπές διαμέτρου 6 mm στις σημειωμένες θέσεις.

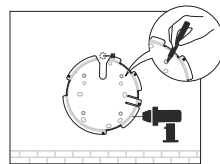

- 2** Εισάγετε τα πλαστικά ούπα στις οπές διαμέτρου 6mm.

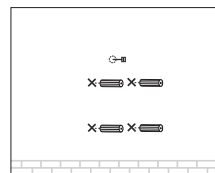

- 3** Στερεώστε τη βάση στήριξης στον τοίχο βιδώνοντας τις βίδες μέσα στα ούπα. Βεβαιωθείτε ότι οι προεξοχές της βάσης στήριξης βρίσκονται από την εξωτερική μεριά.

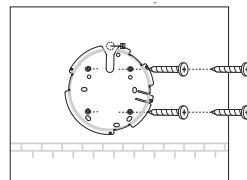

- 4** Συνδέστε το καλώδιο Ethernet στη θύρα ETHERNET του AP.

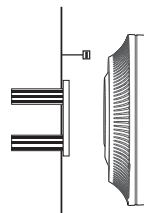

- 5** Προσαρμόστε το AP στη βάση στήριξης ευθυγραμμίζοντας το βέλος που βρίσκεται στο AP με το βέλος που υπάρχει στη βάση στήριξης και στη συνέχεια περιστρέψτε το AP μέχρι να κλειδώσει στη θέση του.

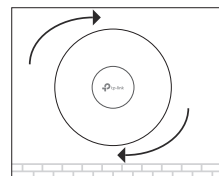

Τροφοδοτικό

■ Τροφοδοσία μέσω Συσκευής PSE ή Τροφοδοτικού Ρεύματος

Ορισμένα AP μπορούν να τροφοδοτηθούν μέσω ενός τροφοδοτικού ρεύματος ή μίας συσκευής PSE (όπως ένα PoE switch) που να συμμορφώνεται με τη προδιαγραφή Power Source Class 2 (PS2) ή την Limited Power Source (LPS) του IEC 62368-1.

Σημείωση: Η διαθεσιμότητα εξαρτάται από το πραγματικό προϊόν. Παρακαλώ ανατρέξτε στις προδιαγραφές του προϊόντος.

Μέσω PoE Switch

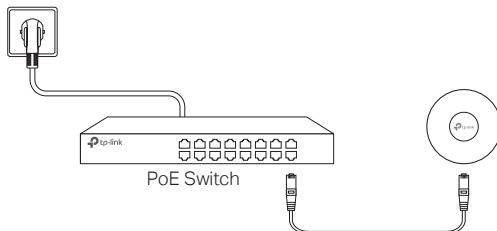

Μέσω Τροφοδοτικού Ρεύματος

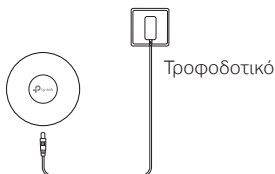

■ Τροφοδοσία μέσω Προσαρμογέα PoE

Ορισμένα AP μπορούν να τροφοδοτηθούν μέσω του προσαρμογέα PoE.

Σημείωση: Η διαθεσιμότητα εξαρτάται από το πραγματικό προϊόν. Παρακαλώ ανατρέξτε στις προδιαγραφές του προϊόντος.

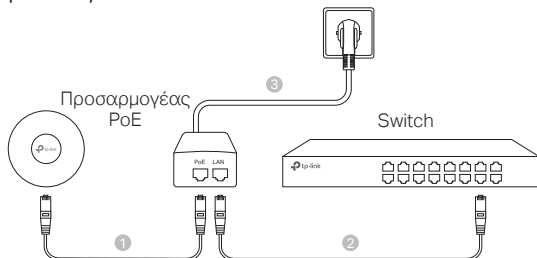

Remarque: illustrations non contractuelles.

Topologie réseau

Une topologie réseau typique est présentée ci-dessous.

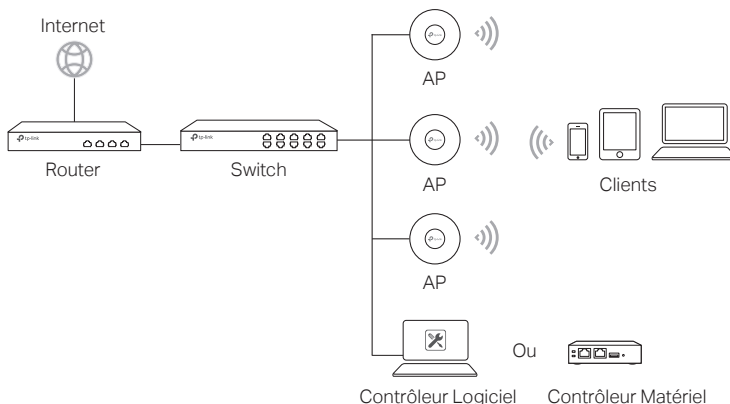

Les points d'accès peuvent être configurés et surveillés de manière centralisée via le contrôleur. Vous pouvez obtenir le contrôleur sur <https://www.tp-link.com> ou contacter l'équipe commerciale.

Installation matérielle

■ Option 1 : Montage au plafond

Suivre les étapes ci-après pour installer AP à l'aide des accessoires fournis :

Remarque : le support de montage et les accessoires (quantité et taille) peuvent varier selon le produit.



Rondelles



Vis CHC



Écrous papillon

1 Démontez la dalle du plafond

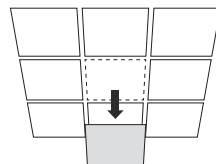

- 2** Placer le support de montage au centre de la dalle du plafond. Marquer les positions des trous de vis et une position pour le trou du câble Ethernet. Percer des trous de 4 mm de diamètre pour les vis et un trou de 25 mm de diamètre pour le câble Ethernet aux emplacements marqués.

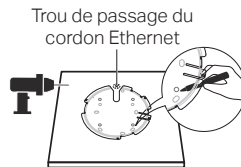

- 3** Fixer le support de montage au clip de fixation pour rails de plafond à l'aide des vis CHC.

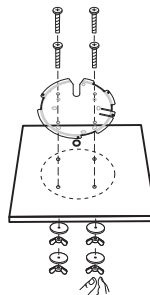

- 4** Passer le cordon Ethernet au travers du trou dédié et remettre la dalle de plafond à sa place.

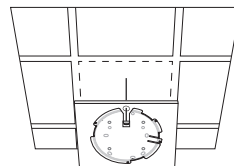

- 5** Connecter le cordon Ethernet au port Ethernet. Fixer AP au support de montage en alignant les flèches présentes sur AP avec celles du support de montage, par une rotation dans le sens des aiguilles d'une montre positionner AP jusqu'au dé clic de verrouillage.

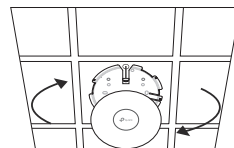

■ Option 2 : Montage en applique (mural)

Suivre les étapes ci-après pour installer AP à l'aide des accessoires fournis:

Remarque : le support de montage et les accessoires (quantité et taille) peuvent varier selon le produit.



Chevilles plastiques



Vis

- 1** Si votre câble Ethernet traverse le mur, positionnez le support de montage et faites passer le câble Ethernet. Marquez les positions des trous de vis, puis percez des trous de 6 mm de diamètre aux positions marquées.

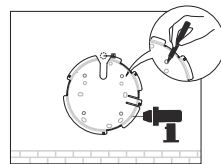

- 2** Insérer les chevilles dans les trous percés précédemment.

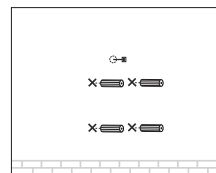

- 3** Fixer le support de montage en vissant les vis dans les chevilles. Assurez-vous que les saillies du support soient dirigées vers vous.

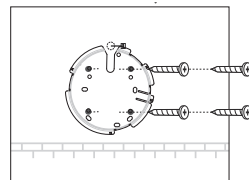

- 4** Connecter le cordon Ethernet au port Ethernet de l'AP.

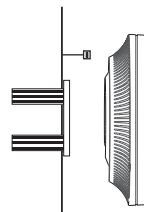

- 5** Fixer l'AP au support de montage en alignant les flèches sur l'AP avec celles sur le support de montage, par une rotation dans le sens des aiguilles d'une montre positionner l'AP jusqu'au dé clic de verrouillage.

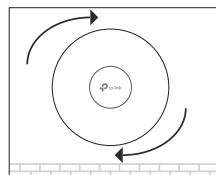

Alimentation

■ Alimentation PoE ou via un adaptateur secteur

Certains points d'accès peuvent être alimentés via l'adaptateur secteur ou le périphérique PSE (tel qu'un commutateur PoE) qui est conforme à la classe de source d'alimentation 2 (PS2) ou à la source d'alimentation limitée (LPS) de la norme CEI 62368-1.

Remarque : la disponibilité dépend du produit réel. Veuillez vous référer aux spécifications du produit.

Via un switch PoE

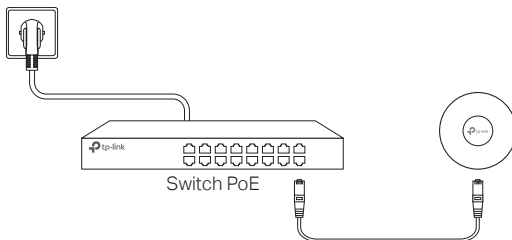

Via adaptateur secteur

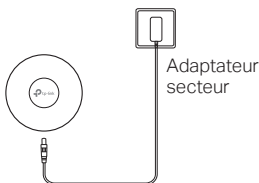

■ Alimenté via un injecteur PoE

Certains points d'accès peuvent être alimentés via l'adaptateur PoE.

Remarque : la disponibilité dépend du produit réel. Veuillez vous référer aux spécifications du produit.

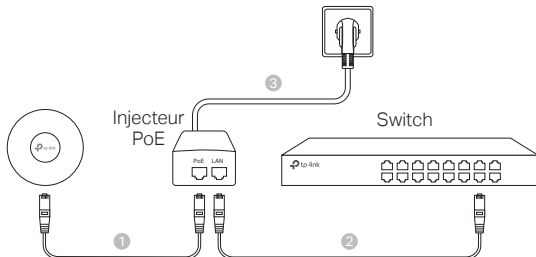

Nota: L'immagine può essere diversa dal prodotto attuale.

Topologia di Rete Tipica

Di seguito viene mostrata una tipica topologia di rete per gli AP.

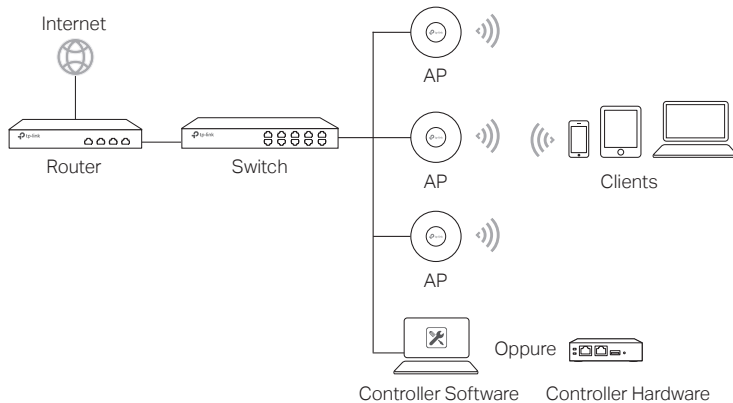

Gli AP possono essere configurati e monitorati centralmente tramite il Controller. Puoi ottenere il controller da <https://www.tp-link.com> o contattare lo staff commerciale.

Installazione Hardware

■ Opzione 1: Montaggio a soffitto

Seguire i seguenti passi per installare gli AP con gli accessori forniti:

Nota: la staffa di montaggio e gli accessori (quantità e dimensioni) possono variare a seconda del prodotto.



- 1 Rimuovete il pannello dal controsoffitto.

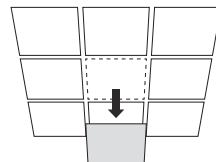

- 2** Posiziona la staffa di montaggio al centro della pannello del controsoffitto. Marca le posizioni per i fori delle viti e una posizione per il foro del cavo Ethernet. Pratica fori di 4 mm di diametro per le viti e un foro di 25 mm di diametro per il cavo Ethernet nelle posizioni contrassegnate.



- 3** Assicurate le staffe di montaggio al pannello usando viti a testa piatta, guarnizioni e dadi a farfalla.

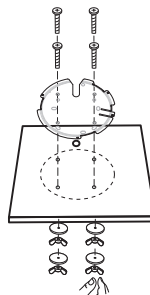

- 4** Infilate il cavo Ethernet nel foro e riposizionate il pannello nel suo posto.

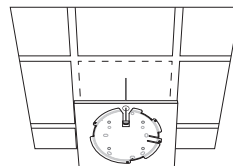

- 5** Connettete il cavo Ethernet alla porta ETHERNET. Attaccate lo AP alle staffe di montaggio allineando la freccia del AP alla freccia delle staffe di montaggio, quindi ruotate lo AP fino a quando si blocca nella corretta posizione.

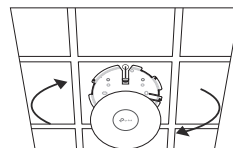

■ Opzione 2: Montaggio a muro

Seguite i seguenti passi per installare lo AP con gli accessori forniti:

Nota: la staffa di montaggio e gli accessori (quantità e dimensioni) possono variare a seconda del prodotto.



Fisher



Viti auto filettanti

- 1 Se il cavo Ethernet passa attraverso la parete, posiziona la staffa di montaggio e inserisci il cavo Ethernet. Segna le posizioni per i fori delle viti e poi pratica dei fori di 6 mm di diametro nelle posizioni segnate.
- 2 Inserite i fisher nei fori da 6 mm.
- 3 Assicurate le staffe di montaggio al muro avvitando le viti autofilettanti nei fisher. Assicuratevi che le spalle delle staffe di montaggio siano poste dietro.
- 4 Collegate il cavo Ethernet alla porta ETHERNET del AP.
- 5 Attaccate lo AP alle staffe di montaggio allineando la freccia del AP alla freccia delle staffe di montaggio, quindi ruotate lo AP fino a quando si blocca nella corretta posizione.

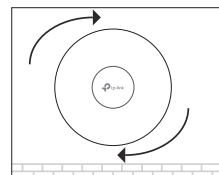
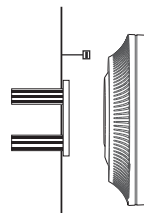
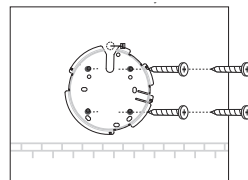
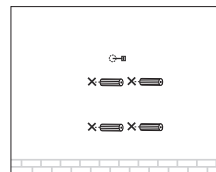
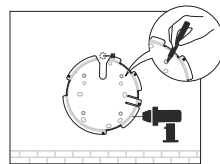

Alimentazione

■ Alimentazione tramite dispositivo PSE o alimentatore

Alcuni AP possono essere alimentati tramite l'alimentatore o il dispositivo PSE (ad esempio uno switch PoE) conforme agli standard Power Source Class 2 (PS2) o Limited Power Source (LPS) di IEC 62368-1.

Nota: la disponibilità dipende dal prodotto effettivo. Fai riferimento alle specifiche del prodotto.

Tramite switch PoE

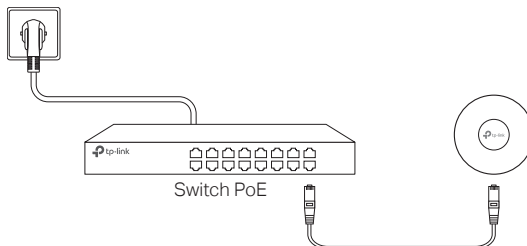

Tramite alimentatore

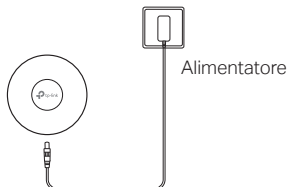

■ Alimentazione tramite adattatore PoE

Alcuni AP possono essere alimentati tramite adattatore PoE.

Nota: la disponibilità dipende dal prodotto effettivo. Fai riferimento alle specifiche del prodotto.

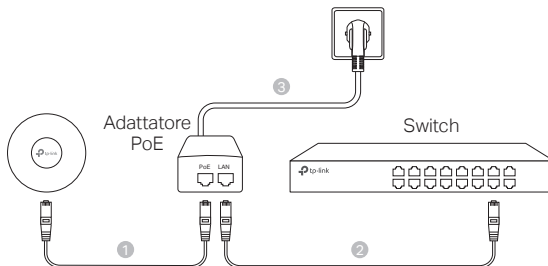

Nota: A imagem poderá ser diferente do produto atual.

Topologia de Rede

Uma topologia de rede típica para o AP demonstrada abaixo.

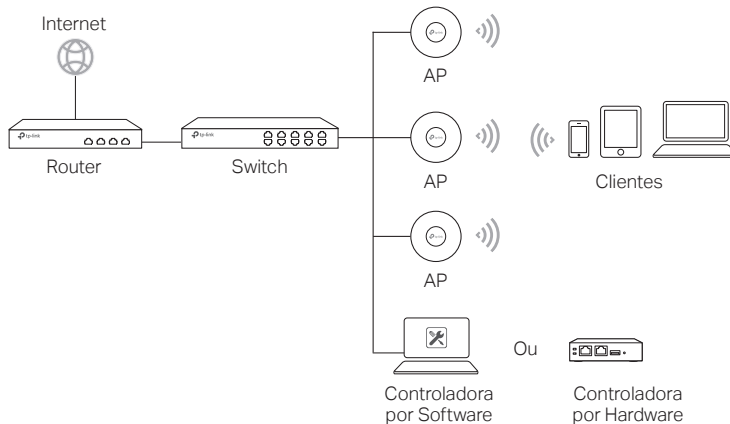

Os APs podem ser configurados e supervisionados centralmente através do Controller. Pode obter o Controller em <https://www.tp-link.com/pt> ou contactar a equipa de vendas.

Instalação Física

■ Opção 1: Instalação no Teto

Siga os passos abaixo indicados para instalar o AP com os acessórios fornecidos:

Nota: O suporte de montagem e os acessórios (quantidade e tamanho) podem variar de acordo com o produto.



Anilhas



Parafusos de cabeça cilíndrica



Porcas de orelhas

- 1 Remova a placa do Teto falso.

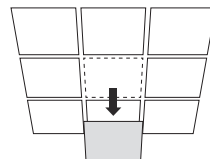

- 2** Colocar o suporte de montagem no centro do azulejo do tecto. Marcar posições para os furos dos parafusos e uma posição para o furo do cabo Ethernet. Fazer furos de 4 mm de diâmetro para os parafusos e um furo de 25 mm de diâmetro para o cabo Ethernet nas posições marcadas.

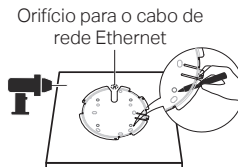

- 3** Fixe o suporte de montagem à placa do teto falso, utilizando parafusos de cabeça cilíndrica, as anilhas e porcas de orelhas.

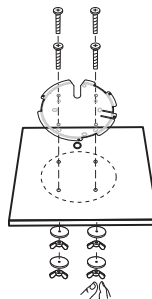

- 4** Passe o cabo rede Ethernet através do orifício e coloque a placa do teto falso na posição original.

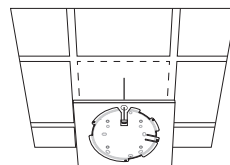

- 5** Conecte o cabo de rede Ethernet na porta Ethernet. Instale o AP no suporte, alinhando a marca da seta no AP com a marca de seta no suporte de montagem e em seguida, gire o AP até que ele fique fixo no lugar.

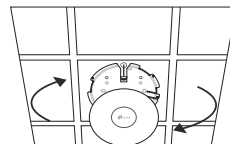

■ Opção 2: Instalação na parede

Siga os passos abaixo indicados para instalar o AP com os acessórios fornecidos:

Nota: O suporte de montagem e os acessórios (quantidade e tamanho) podem variar de acordo com o produto.



Buchas plásticas



Parafusos auto-roscentes

- 1** Se o seu cabo Ethernet passar através da parede, posicionar o suporte de montagem e alimentar o cabo Ethernet. Marque as posições para os furos dos parafusos e depois faça furos de 6 mm de diâmetro nas posições marcadas.

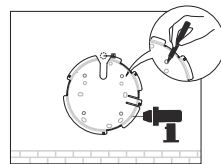

- 2** Insira as buchas plásticas nos orifícios de 6 mm.

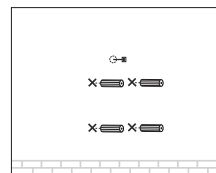

- 3** Fixe o suporte de montagem na parede, aparafusando os parafusos auto-roscentes nas buchas. Certifique-se de que as extremidades do suporte de montagem estão no lado de fora.

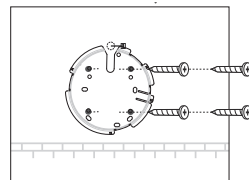

- 4** Conecte o cabo de rede Ethernet na porta de rede Ethernet.

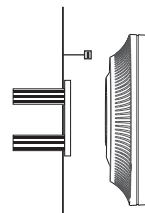

- 5** Fixe o AP ao suporte de montagem alinhando a marca da seta no AP com a seta no suporte de montagem e gire o AP até que encaixe no lugar.

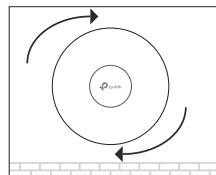

Fonte de Alimentação

■ Alimentação via dispositivo PSE ou adaptador de alimentação

Alguns APs podem ser alimentados através do adaptador de energia ou do dispositivo PSE (como um interruptor PoE) que cumpre com a Classe 2 (PS2) da Fonte de Energia ou Fonte de Energia Limitada (LPS) da IEC 62368-1.

Nota: A disponibilidade depende do produto. Por favor consulte as especificações do produto.

Via PoE Switch

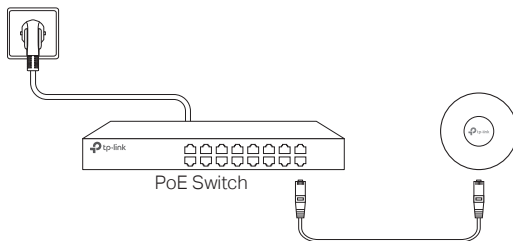

Via Adaptador de Energia

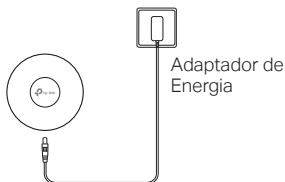

■ Power via PoE Adapter

Alguns APs podem ser alimentados através do adaptador PoE.

Nota: A disponibilidade depende do produto. Por favor consulte as especificações do produto.

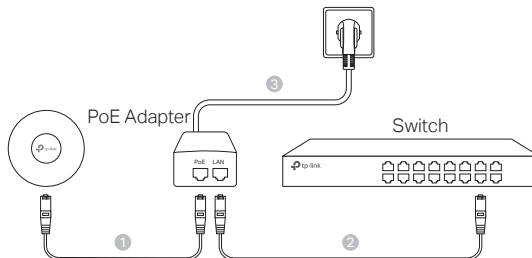

Huomio: Kuva saattaa poiketa itse tuotteesta.

Verkkokartta

AP:n tyypillinen verkkokartta näkyy alla.

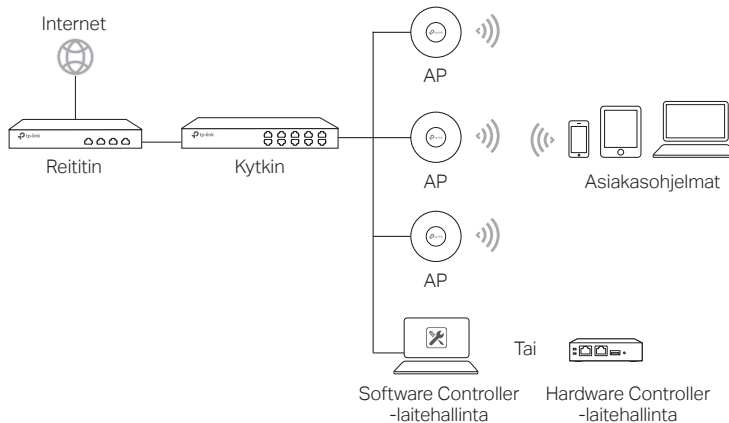

AP:t voidaan määrittää keskitetysti ja niitä voidaan hallita ohjaimella. Voit hankkia ohjaimen osoitteesta <https://www.tp-link.com> tai ottaa yhteyttä myyntiedustajaan.

Laitteistoasennus

■ Vaihtoehto 1: kattoasennus

Seuraa alla olevia ohjeita asentaaksesi AP:n mukana tulevilla lisävarusteilla:

Huomio: asennusteline ja lisäosat (määrä ja koko) voivat vaihdella tuotteen mukaan.



Aluslevyt



Kupukantaruuvit



Siipimutterit

1 Poista kattolaatta.

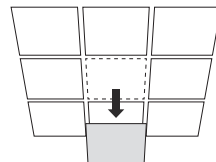

2

Aseta asennusteline kattolaatan keskelle. Merkitse ruuvien reikien ja Ethernet-kaapelin paikat. Poraa 4 mm reiät ruuveille ja 25 mm reikä Ethernet-kaapelille merkittyihin paikkoihin.

Reikä Ethernet-kaapelille

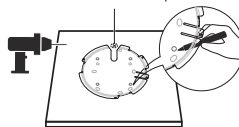

3

Kiinnitä kiinnike kattolaattaan kupukantaruuvia, aluslevy ja siipimutteria käyttämällä.

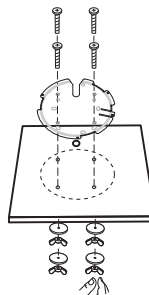

4

Syötä Ethernet-kaapeli reiän läpi ja aseta kattolaatta paikalleen.

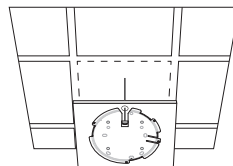

5

Yhdistä Ethernet-kaapeli ETHERNET-porttiin. Liitä AP kiinnikkeeseen asettamalla AP:n nuolimerkki kiinnikkeen nuolimerkin kanssa samansuuntaiseksi. Käännä sitten AP:tä, kunnes se lukittuu paikalleen.

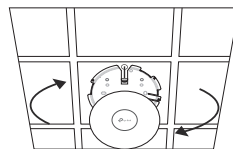

■ Vaihtoehto 2: seinäasennus

Seuraa alla olevia ohjeita asentaaksesi AP:n mukana tulevilla lisävarusteilla:

Huomio: asennusteline ja lisäosat (määrä ja koko) voivat vaihdella tuotteen mukaan.



Muoviset seinäankurit



Itsekierteittävät ruuvit

- 1 Jos Ethernet-kaapelisi syötetään seinän läpi, aseta asennusteline ja syötä Ethernet-kaapeli. Merkitse ruuvien reikien paikat ja poraa 6 mm reiät merkittyihin paikkoihin.

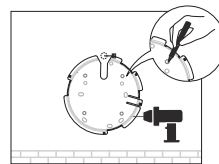

- 2 Aseta muoviset seinäankkurit 6 mm reikiin.

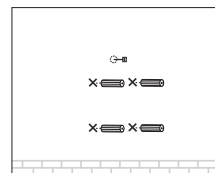

- 3 Kiinnitä kiinnike seinään ruuvaamalla itsekierteittävät ruuvit ankkureihin. Varmista, että kiinnikkeen lavat osoittavat ulospäin.

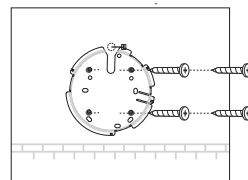

- 4 Yhdistä Ethernet-kaapeli AP:n ETHERNET-porttiin.

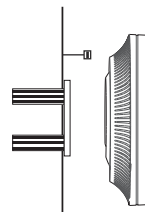

- 5 Liitä AP kiinnikkeeseen asettamalla AP:n nuolimerkki kiinnikkeen nuolimerkin kanssa samansuuntaiseksi. Käännä sitten AP:tä, kunnes se lukittuu paikalleen.

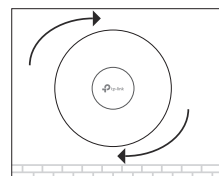

Virtalähde

■ Virta PSE-laitteen tai virtalaitteen kautta

Jotkut tukiasemat voivat toimia virta-adapterilla tai PSE-laitteella (kuten PoE-kytkin), jotka ovat virtalähdeluokan 2 (PS2) tai standardin IEC 62368-1 rajoitetun virtalähteen (LPS) mukaisia.

Huomio: saatavuus riippuu todellisesta tuotteesta. Lue tuotteen tekniset tiedot.

PoE-kytkimen kautta

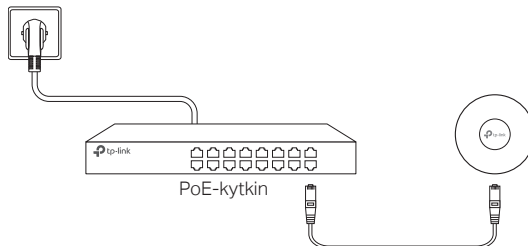

Virtalaitteen kautta

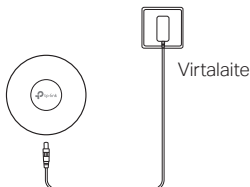

■ Virta PoE-sovittimen kautta

Jotkut tukiasemat voivat toimia PoE-adapterilla.

Huomio: saatavuus riippuu todellisesta tuotteesta. Lue tuotteen tekniset tiedot.

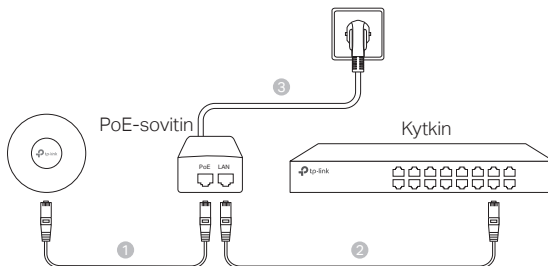

Opmerking: De afbeelding kan afwijken van het daadwerkelijke product.

Netwerktopologie

Een gebruikelijke netwerktopologie voor het AP wordt hieronder getoond.

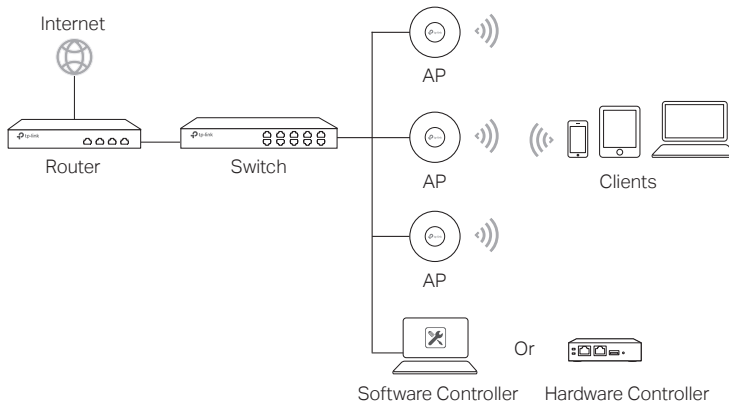

AP's kunnen centraal worden geconfigureerd en gemonitord via een Controller. U kunt de controller downloaden via <https://www.tp-link.com> of contact opnemen met het verkooppunt.

Hardware installeren

■ Optie 1: Plafondmontage

Volg onderstaande stappen om het AP te installeren met behulp van de meegeleverde onderdelen:

Opmerking: De bevestigingsbeugel en de accessoires (hoeveelheid en grootte) kunnen per product variëren.



Slutringen



Bolkopschroeven



Vleugelmoeren

- 1 Verwijder de plafondtegel.

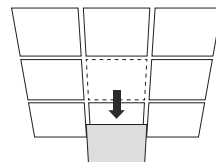

- 2 Plaats de bevestigingsbeugel in het midden van de plafondtegel. Teken markeringen voor de schroefgaten en een markering voor het gat voor de ethernetkabel. Boor op de getekende markeringen gaten van 4 mm voor de schroeven en een gat van 25 mm voor de ethernetkabel.

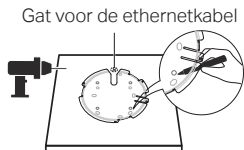

- 3 Draai de bevestigingsbeugel vast aan de plafondtegel met behulp van balkopschroeven, sluitringen en vleugelmoeren.

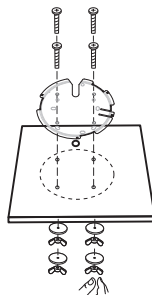

- 4 Haal de ethernetkabel door het gat en plaats de plafondtegel terug.

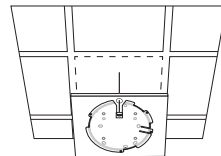

- 5 Sluit de ethernetkabel aan op de ethernetpoort. Bevestig het AP aan de bevestigingsbeugel door de pijl op het AP op een lijn te leggen met de pijl op de bevestigingsbeugel, draai vervolgens het AP totdat deze vastklikt.

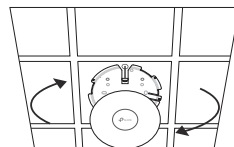

■ Optie 2: Plafondmontage

Volg onderstaande stappen om het AP te installeren met behulp van de meegeleverde onderdelen:

Opmerking: De bevestigingsbeugel en de accessoires (hoeveelheid en grootte) kunnen per product variëren.



Plastic pluggen



Zelftappende schroeven

- 1** Als uw ethernetkabel door de muur loopt, plaats dan de bevestigingsbeugel en voer de ethernetkabel erdoorheen. Teken markeringen voor de schroefgaten en boor vervolgens gaten van 6 mm op de gemarkeerde plekken.

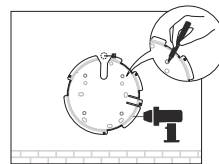

- 2** Plaats de plastic pluggen in de gaten van 6 mm.

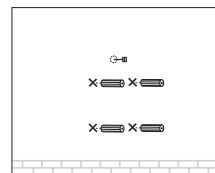

- 3** Draai de bevestigingsbeugel vast op de muur door de zelftappende schroeven in de pluggen te draaien. Zorg ervoor dat de uiteinden van de bevestigingsbeugel zich aan de buitenkant bevinden.

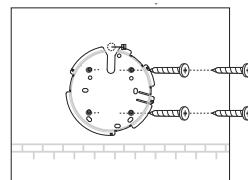

- 4** Sluit de ethernetkabel aan op de ethernetpoort van het AP.

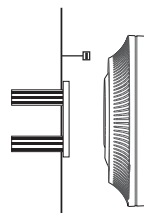

- 5** Bevestig het AP aan de bevestigingsbeugel door de pijl op het AP op een lijn te leggen met de pijl op de bevestigingsbeugel, draai vervolgens het AP totdat deze vastklikt.

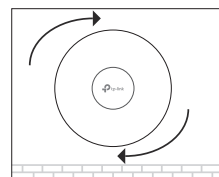

Stroomvoorziening

■ Van stroom voorzien via een PSE-apparaat of een stroomadapter

Sommige AP's kunnen worden gevoed via de voedingsadapter of het PSE-apparaat (zoals een PoE-switch) dat voldoet aan Power Source Class 2 (PS2) of Limited Power Source (LPS) van IEC 62368-1.

Opmerking: Beschikbaarheid hangt af van het werkelijke product. Raadpleeg de productspecificaties.

Via een PoE switch

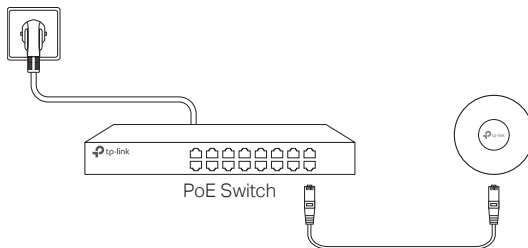

Via een stroomadapter

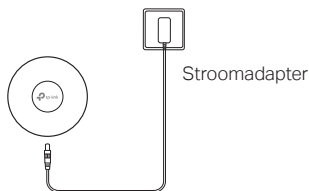

■ Van stroom voorzien via een PoE adapter

Sommige AP's kunnen worden gevoed worden via de PoE-adapter.

Opmerking: Beschikbaarheid hangt af van het werkelijke product. Raadpleeg de productspecificaties.

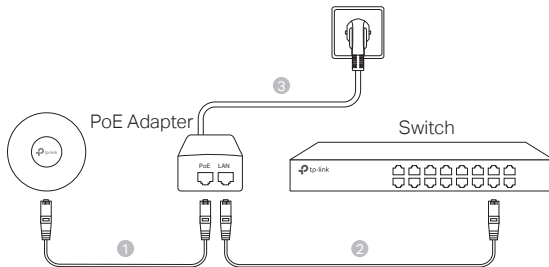

Obs: Bilden kan skilja sig från den faktiska produkten.

Nätverkstopologi

En typisk nätverkstopologi för AP visas nedan.

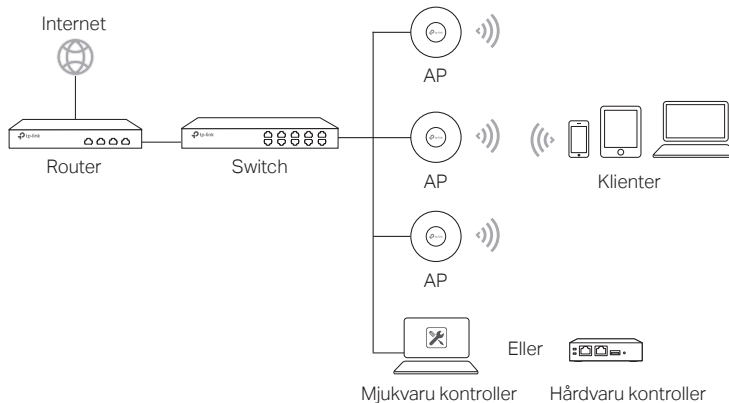

Accesspunktterna kan konfigureras och övervakas centralt via kontrollern. Du kan hämta kontrollern på <https://www.tp-link.com> eller kontakta försäljningspersonalen.

Hårdvaruinstallation

■ Alternativ 1: Takmontering

Följ stegen nedan för att installera AP med följande tillbehör:

OBS: Monteringsfästet och tillbehören (antal och storlek) kan variera beroende på produkt.



Brickor



Skrudar med rundad kant



Vingmuttrar

1 Ta bort takplattan.

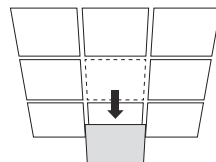

- 2 Placera monteringsfästet i mitten av takplattan. Gör markeringar för skruvhålen och den plats där hålet för Ethernet-kabeln ska vara. Borra hål med 4 mm diameter för skruvarna och ett hål med 25 mm diameter för Ethernetkabeln vid markeringarna.

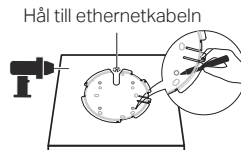

- 3 Sätt fast monteringsplattan i takplattan med skruvar med rundad kant, brickor och vingmuttrar.

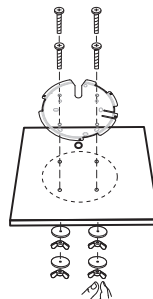

- 4 Trä in ethernetkabeln genom hålet och sätt takplattan på plats igen.

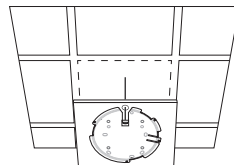

- 5 Sätt ethernetkabeln i ETHERNET-porten. Placera din AP i monteringsplattan genom att sätta pilmarkeringen på AP i linje med pilmarkeringen på monteringsplattan. Roter sedan AP medurs tills den låses på plats.

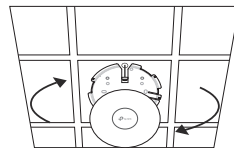

■ Alternativ 2: Vägghäring

Följ stegen nedan för att installera AP med följande tillbehör:

OBS: Monteringsfästet och tillbehören (antal och storlek) kan variera beroende på produkt.



Plastpluggar



Gängpressande skruvar

- 1** Om Ethernet-kabeln går igen väggen, placera monteringsfästet och för in Ethernet-kabeln. Gör markeringar för skruvhålen och borra sedan hål med 6 mm diameter vid markeringarna.

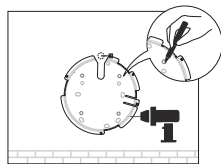

- 2** Sätt i plastpluggarna i 6 mm-hålen.

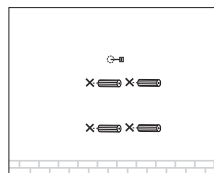

- 3** Sätt fast monteringsplattan i väggen genom att dra i de gängpressande skruvarna i plastpluggarna. Se till att axlarna på monteringsplattan sitter på utsidan.

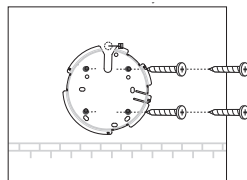

- 4** Sätt ethernetkabeln i ETHERNET-porten på AP.

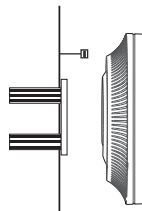

- 5** Placera din AP i monteringsplattan genom att sätta pilmarkeringen på AP i linje med pilmarkeringen på monteringsplattan. Rotera sedan AP medurs tills den låses på plats.

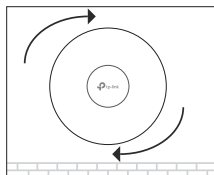

Strömkälla

■ Ström via PSE-enhet eller strömadapter

Vissa AP:er kan drivas via nätadaptern eller PSE-enheten (t.ex. en PoE-switch) som uppfyller kraven för Power Source Class 2 (PS2) eller Limited Power Source (LPS) i IEC 62368-1.

Obs: Tillgängligheten beror på den aktuella produkten. Se produktspecifikationerna.

Via PoE-switch

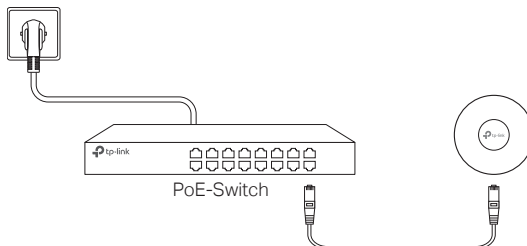

Via strömadapter

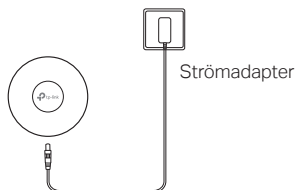

■ Ström via PoE-adapter

Vissa AP:er kan drivas via PoE-adaptern.

Obs: Tillgängligheten beror på den aktuella produkten. Se produktspecifikationerna.

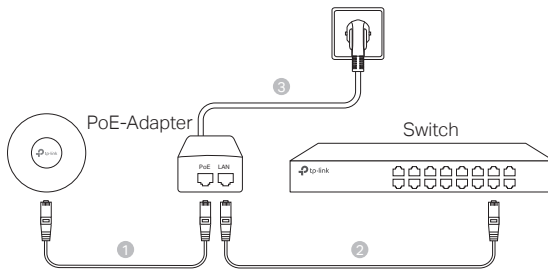

Merk: Bildet kan være annerledes enn det faktiske produktet.

Nettverkstopologi

En typisk nettverkstopologi for AP-en vises her.

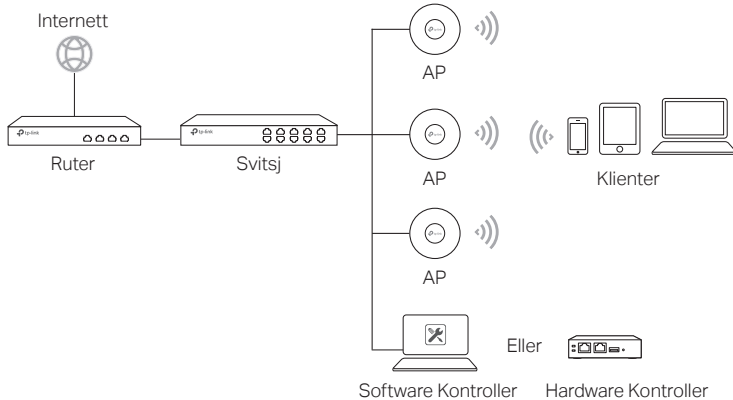

AP-er kan konfigureres og overvåkes sentralt via Kontrolleren. Du kan få Kontrolleren fra <https://www.tp-link.com> eller kontakte salgspersonalet.

Maskinvareinstallasjon

■ Alternativ 1: Montering i tak

Utfør følgende trinn for å montere AP med det medfølgende tilbehøret:

Merk: Monteringsbraketten og tilbehøret (mengde og størrelse) kan variere etter produkt.



Skive



Panhodeskruer



Vingemuttere

1 Ta av takplaten.

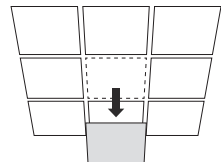

- 2 Plasser monteringsbraketten i midten av takflisen. Merk posisjoner for skruer og en posisjon for Ethernet-kabelhullet. Bor hull med 4 mm diameter for skruene og et hull på 25 mm diameter for Ethernet-kabelen i de markerte posisjonene.

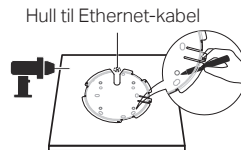

- 3 Fest festebraketten til takplaten med tre panhodeskruer, skiver og vingemuttere.

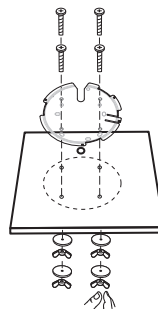

- 4 Stikk Ethernet-kabelen gjennom hullet og sett takplaten tilbake på plass.

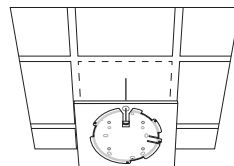

- 5 Koble Ethernet-kabelen til Ethernet-porten. Fest AP til festebraketten ved å rette inn pilmerket på AP med pilmerket på festebraketten, så roterer du AP til den låses på plass.

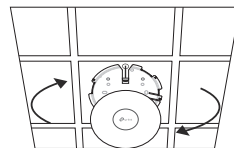

■ Alternativ 2: Montering på vegg

Utfør følgende trinn for å montere AP med det medfølgende tilbehøret:

Merk: Monteringsbraketten og tilbehøret (mengde og størrelse) kan variere etter produkt.



Vegganker i plast



Selvgjengende skruer

- 1 Hvis Ethernet-kabelen mates gjennom veggen, plasserer du monteringsbraketten og mater Ethernet-kabelen. Merk posisjoner for skruerullene, og bor deretter hull med en diameter på 6 mm i de merkede posisjonene.
- 2 Sett veggankerne i hullene på 6 mm i diameter.
- 3 Fest festebrakettene til veggen ved å kjøre de selvgjengende skruene inn i ankrene. Påse at skuldrene på festebrakettene er på utsiden.
- 4 Koble Ethernet-kabelen til Ethernet-porten på AP.
- 5 Fest AP til festebrakettene ved å rette inn pilmerket på AP med pilmerket på festebrakettene, så roterer du AP til den låses på plass.

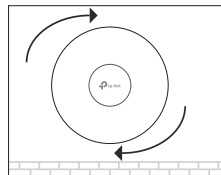
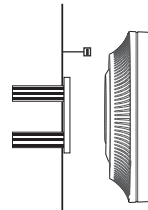
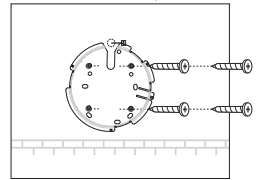
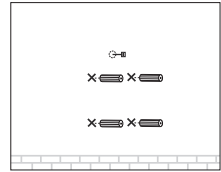
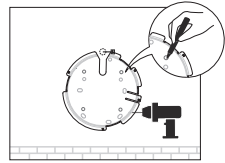

Strømforsyning

■ Strøm via PSE-enhet eller strømadapter

Noen tilgangspunkter kan drives via strømadapteren eller PSE-enheten (for eksempel en PoE-bryter) som overholder strømkildeklasse 2 (PS2) eller begrenset strømkilde (LPS) i IEC 62368-1.

Merk: Tilgjengeligheten avhenger av det faktiske produktet. Se produktspesifikasjonene.

Via PoE-svitsj

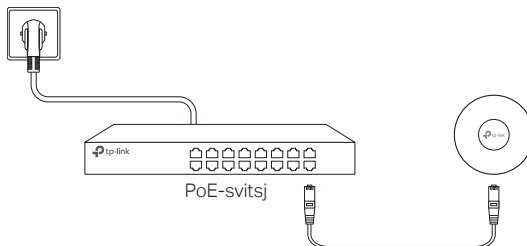

Via strømadapter

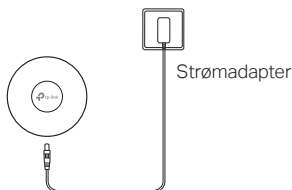

■ Strøm via PoE-adapter

Noen AP-er kan drives via PoE-adapteren.

Merk: Tilgjengeligheten avhenger av det faktiske produktet. Se produktspesifikasjonene.

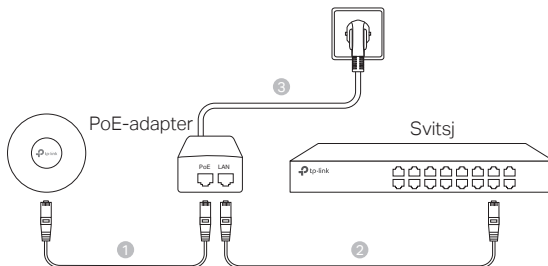

Bemærk: Billedet kan afvige fra det faktiske produkt.

Netværkstopologi

Du kan se en typisk netværkstopologi for AP nedenfor.

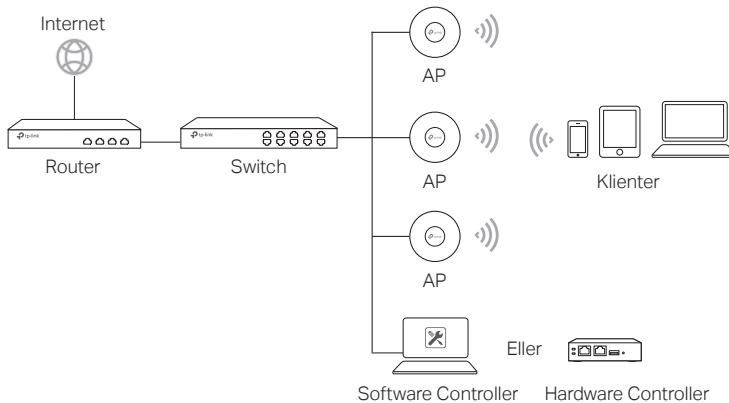

AP'er kan konfigureres og overvåges centralt via styringssoftwaren. Du kan hente styringssoftwaren fra <https://www.tp-link.com> eller kontakte salgspersonalet.

Hardwareinstallering

■ Mulighed 1: Montering på loft

Følg trinene nedenfor for at installere AP med det medfølgende tilbehør:

Bemærk: Monteringsbeslaget og tilbehøret (antal og størrelse) kan variere fra produkt til produkt.



1 Fjern loftspladen.

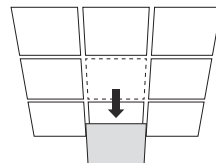

- 2 Placer monteringsbeslaget i midten af loftpladen. Marker positioner for skruehullerne og en position for Ethernet-kabelhullet. Bor huller med en diameter på 4 mm til skrueerne og et hul med en diameter på 25 mm til Ethernet-kablet på de markerede positioner.

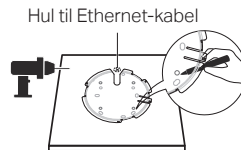

- 3 Fastgør beslaget til loftet med panhovedskruer, spændeskiver og vingemøtrikker.

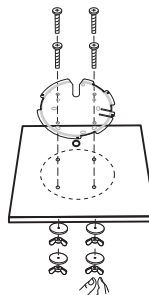

- 4 Før Ethernet-kablet gennem hullet, og sæt loftspladen på plads igen.

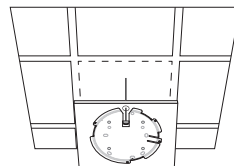

- 5 Forbind Ethernet-kablet til ETHERNET-porten. Fastgør AP til beslaget ved at bringe pilemærket på AP på linje med pilemærket på beslaget, og rotér så AP, til den låses fast.

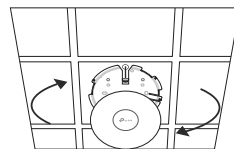

■ Mulighed 2: Vægmontering

Følg trinene nedenfor for at installere AP med det medfølgende tilbehør:

Bemærk: Monteringsbeslaget og tilbehøret (antal og størrelse) kan variere fra produkt til produkt.



Plastikmurankre



Selvskærende skrue

- 1** Hvis dit Ethernet-kabel føres gennem væggen, skal du placere monteringsbeslaget og føre Ethernet-kablet. Marker positioner for skruehullerne og bór derefter huller med en diameter på 6 mm på de markerede positioner.

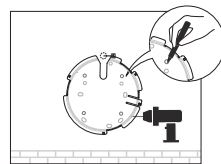

- 2** Indsæt plastikmurankrene i hullerne med diameter på 6 mm.

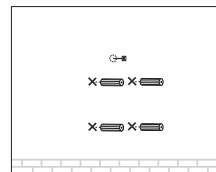

- 3** Fastgør beslaget på væggen ved at sætte de selvskærende skruer i ankrene. Sørg for, at beslagets ansatser vender udad.

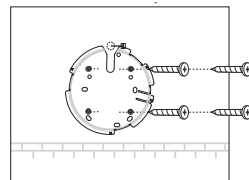

- 4** Forbind Ethernet-kablet til ETHERNET-porten på AP.

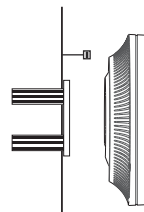

- 5** Fastgør AP til beslaget ved at bringe pilemærket på AP på linje med pilemærket på beslaget, og rotér så AP, til den låses fast.

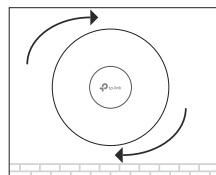

Strømforsyning

■ Strøm via PSE-enhed eller strømadapter

Nogle AP'er kan forsynes med strøm via strømadapteren eller PSE-enheden (såsom en PoE-switch), som overholder Power Source Class 2 (PS2) eller Limited Power Source (LPS) i IEC 62368-1.

Bemærk: Tilgængelighed afhænger af det faktiske produkt. Se venligst produktspecifikationerne.

Via PoE-switch

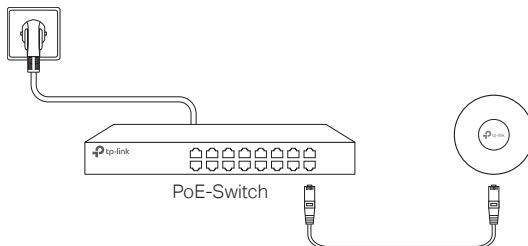

Via strømadapter

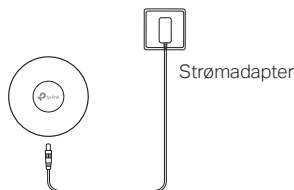

■ Strøm via PoE-adapter

Nogle AP'er kan forsynes med strøm via PoE-adapteren.

Bemærk: Tilgængelighed afhænger af det faktiske produkt. Se venligst produktspecifikationerne.

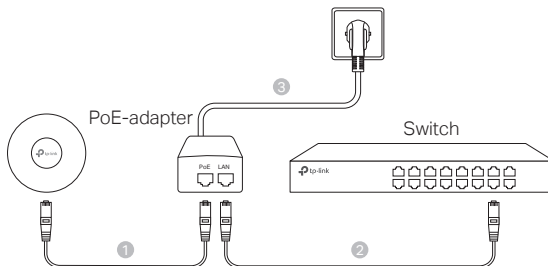

Deutsch

Sicherheitsinformation

- Halten Sie das Gerät fern von Wasser, Feuchtigkeit, Feuer oder sehr warmen Umgebungen.
- Versuchen Sie nicht, das Gerät auseinanderzunehmen oder zu manipulieren. Wenn Sie Service benötigen, kontaktieren Sie uns bitte.
- Verwenden Sie kein beschädigtes Ladegerät oder USB-Kabel, um Ihren Akku zu laden.
- Verwenden Sie ausschließlich das empfohlene Ladegerät.
- Betreiben Sie das Gerät nur an Orten, wo dies erlaubt ist.
- Der Adapter muss in eine Steckdose nah am Gerät gesteckt werden und leicht zugänglich sein.

Bitte folgen Sie diesen Anweisungen, wenn sie das Gerät betreiben. Bei unsachgemäßer Verwendung können wir nicht garantieren, dass keine Unfälle oder Schäden auftreten. Behandeln Sie das Gerät pfleglich und auf eigene Gefahr.

English

Safety Information

- Keep the device away from water, fire, humidity or hot environments.
- Do not attempt to disassemble, repair, or modify the device. If you need service, please contact us.
- Do not use damaged charger or USB cable to charge the device.
- Do not use any other chargers than those recommended.
- Do not use the device where wireless devices are not allowed
- Adapter shall be installed near the equipment and shall be easily accessible.

Please read and follow the above safety information when operating the device. We cannot guarantee that no accidents or damage will occur due to improper use of device. Please use this product with care and operate at your own risk.

Español

Información de seguridad

- Mantenga el dispositivo fuera del agua, fuego, humedad o entornos calurosos.
- No intente desmontarlo, repararlo o modificar el dispositivo. Si necesita servicio técnico, póngase en contacto con nosotros.
- No utilice para cargar el dispositivo cargadores o cables USB dañados.
- No utilice cualquier otro cargador diferente al recomendado.
- No utilice el dispositivo donde los dispositivos inalámbricos no están permitidos.
- El adaptador debe ser instalado cerca del equipo y en un lugar de fácil acceso.

Por favor lea y siga las indicaciones anteriores de seguridad cuando el dispositivo esté funcionando. No nos haremos responsables de posibles daños o accidentes que puedan ocurrir debido a un uso incorrecto del dispositivo. Por favor utilice este producto de manera correcta y bajo su propia responsabilidad.

Ελληνικά

Πληροφορίες ασφάλειας

- Κρατήστε τη συσκευή μακριά από νερό, φωτιά, υγρασία ή ζεστά περιβάλλοντα.
- Μην επιχειρήσετε να αποσυναρμολογήσετε, επισκευάσετε ή τροποποιήσετε τη συσκευή. Εάν χρειάζεστε service, παρακαλώ επικοινωνήστε μαζί μας.
- Αν ο φορτιστής ή το καλώδιο USB έχουν υποστεί βλάβη, μην τα χρησιμοποιήσετε για φόρτιση της συσκευής.
- Να μη χρησιμοποιήσετε άλλους φορτιστές εκτός από τους συνιστώμενους.
- Να μη χρησιμοποιήσετε τη συσκευή σε μέρη όπου απαγορεύεται η χρήση ασύρματων συσκευών.
- Το τροφοδοτικό θα πρέπει να συνδεθεί κοντά στη συσκευή και να είναι εύκολα προσβάσιμο.

Παρακαλούμε διαβάστε και ακολουθήστε τις παραπάνω πληροφορίες ασφάλειας κατά τη χρήση της συσκευής. Δεν μπορούμε να σας εγγυηθούμε ότι δεν θα υπάρξουν ατυχήματα ή βλάβες αν πραγματοποιήσετε λανθασμένη χρήση της συσκευής. Παρακαλούμε να χρησιμοποιείτε το προϊόν με προσοχή και με δική σας ευθύνη.

Français

Informations de sécurité

- Maintenir l'appareil à l'écart de l'eau du feu de l'humidité ou de tout environnement chaud.
- Ne pas tenter de démonter, réparer ou modifier l'appareil. Si vous avez besoin d'un service, veuillez nous contacter.
- Ne pas utiliser un chargeur ou un cordon USB endommagé pour recharger l'appareil.
- Ne pas utiliser un chargeur différent de ceux recommandés.
- Ne pas utiliser l'appareil dans les zones où les communications sans-fil sont interdites.
- L'adaptateur doit être facilement accessible et se trouver à proximité de l'équipement.

Merci de lire et de suivre les instructions de sécurité ci-dessus avant d'utiliser l'appareil. Nous ne pouvons garantir qu'aucun accident ou dommage ne se produira en raison d'un usage incorrect de l'appareil. Merci d'utiliser cet appareil avec précaution, le non respect des consignes de sécurité est à vos risques et périls.

Italiano

Informazioni sulla sicurezza:

- Tenete il dispositivo lontano da acqua, fuoco, umidità e ambienti troppo caldi.
- Non provate a disassemblare, riparare o modificare il dispositivo. Se hai bisogno di assistenza, contattaci.
- Non usate caricatori o cavi USB danneggiati per caricare il dispositivo.
- Non usate altri caricatori al di fuori di quelli consigliati.
- Non usate il dispositivo dove non è consentito l'uso di dispositivi wireless.
- L'adattatore dovrà essere installato vicino al dispositivo e facilmente accessibile.

Leggete e seguite le informazioni di sicurezza sopra indicate quando utilizzate il dispositivo. Non possiamo garantire che non accadano incidenti o danni se si usa in modo improprio il dispositivo. Utilizzate questo prodotto con cura e lo fate funzionare a vostro rischio.

Raccolta differenziata

Tipologia di imballaggio		Codice materiale
Scatola	Carta	PAP 21/PAP 20
Busta di Plastica	Plastica	PET 1/LDPE 4/HDPE 2/7 >PP+PE<
Cartoncino	Carta	PAP 22/PAP 20
Plastica Espansa	Plastica	7 EVA/LDPE 4
Guscio di Plastica	Plastica	PS 6/PVC 3
Pellicola Plastica	Plastica	LDPE 4/PET 1

Verifica le disposizioni del tuo Comune.

* Questa QIG è valida per più modelli. Si prega di fare riferimento al prodotto effettivamente acquistato.

Português

Informação de Segurança

- Mantenha o dispositivo afastado da água, fogo, humidade e ambientes quentes.
- Não tente abrir, reparar ou modificar o dispositivo. Se precisar de suporte, por favor contacte-nos.
- Não utilize um carregador ou cabo USB danificado para carregar o dispositivo.
- Não utilize carregadores que não sejam os recomendados.
- Não utilize este dispositivo em locais onde dispositivos Wi-Fi não são autorizados.
- O adaptador deve ser instalado perto do equipamento e estar acessível.

Por favor leia e siga as instruções de segurança acima quando operar o dispositivo. Não é garantido que acidentes ou estragos possam ocorrer devido à utilização incorreta do produto. Por favor utilize este produto corretamente.

Suomi

Turvallisuustiedot

- Pidä laite poissa vedestä, tulesta, kosteudesta ja kuumasta ympäristöstä.
- Älä yritä purkaa, korjata tai muuntaa laitetta. Jos tarvitset huoltoa, otathan meihin yhteyttä.
- Älä käytä vioittunutta laturia tai USB-kaapelia laitteen lataamiseen.
- Älä käytä muita kuin suositeltuja latureita.
- Älä käytä laitetta paikassa, missä ei sallita langattomia laitteita.
- Sovitin asennetaan laitteiden lähelle ja helposti saataville.

Lue yllä olevat turvallisuustiedot ja noudata niitä käyttäessäsi laitetta. Emme voi taata, että laitteen virheellinen käyttö ei aiheuta onnettomuuksia tai vaurioita. Käytä tätä tuotetta varoen ja omalla vastuullasi.

Nederlands

Veiligheidsinformatie

- Houdt het apparaat uit de buurt van water, vuur, vochtigheid of warme omgevingen.
- Probeer het apparaat niet te demonteren, repareren of aan te passen. Als u hulp nodig hebt, neem dan contact met ons op.
- Gebruik geen beschadigde lader of USB kabel om het apparaat op te laden.
- Gebruik geen andere laders dan de aanbevolen laders.
- Gebruik het apparaat niet waar draadloze apparaten niet toegestaan zijn.
- De adapter moet dicht bij de apparatuur worden geïnstalleerd en moet gemakkelijk toegankelijk zijn.

Lees en volg bovenstaande veiligheidsinformatie tijdens het gebruik van het apparaat. Wij kunnen niet garanderen dat er geen ongelukken of schade kan optreden als gevolg van onjuist gebruik van het apparaat. Gebruik dit product met zorg en gebruik op eigen risico.

Svenska

Säkerhetsinformation

- Håll enheten borta från vatten, eld, fukt eller varma miljöer.
- Försök inte att montera isär, reparera eller modifiera enheten. Kontakta oss om du behöver hjälp.
- Använd inte skadad laddare eller USB-kabel för laddning av enheten.
- Använd inte någon annan laddare än de rekommenderade.
- Använd inte enheten där trådlösa enheter inte är tillåtna.
- Adaptern måste installeras nära utrustningen och vara lättillgänglig.

Läs och följ ovanstående säkerhetsinformation när du använder enheten. Vi kan inte garantera att olyckor eller skador inte inträffar till följd av felaktig användning av enheten. Använd den här produkten med omsorg och på eget ansvar.

Norsk

Sikkerhetsinformasjon

- Hold enheten på trygg avstand fra vann, flammer og fuktige eller varme omgivelser.
- Ikke forsøk å demontere, reparere eller modifisere enheten. Hvis du trenger service, kan du kontakte oss.
- Ikke bruk en ødelagt lader eller USB-kabel for å lade enheten.
- Ikke bruk andre ladere enn dem som er anbefalt.
- Ikke bruk enheten i områder hvor trådløse enheter ikke er tillatt.
- Adapteren må installeres i nærheten av utstyret. Den må være lett tilgjengelig.

Les og følg den ovenstående sikkerhetsinformasjonen før du bruker enheten. Vi kan ikke garantere at ulykker eller skader ikke vil oppstå som følge av feil bruk av enheten. Bruk dette produktet med forsiktighet og på egen risiko.

Dansk

Sikkerhedsinformation

- Hold apparatet væk fra vand, brand, fugt eller varme miljøer.
- Forsøg ikke at skille enheden ad, reparere eller ændre enheden. Har du brug for service, så kontakt os venligst.
- Brug ikke en beskadiget strømadapter eller USB-kabel til at oplade enheden.
- Brug ikke andre opladere end de anbefalede.
- Brug ikke enheden, hvor trådløse enheder ikke er tilladt.
- Adapteren skal installeres tæt på udstyret og være let at komme til.

Følg ovenstående vejledning, når du betjener enheden. Vi kan ikke garantere, at ingen ulykker eller skader sker på grund af forkert brug af enheden. Brug dette produkt med forsigtighed og på egen risiko.

Deutsch

TP-Link erklärt hiermit, dass dieses Gerät die Grundanforderungen und andere relevante Vorgaben der Richtlinien (EU)2015/863, 2014/53/EU, 2009/125/EG und 2011/65/EU erfüllt.

Die Original-EU-Konformitätserklärung kann in englischer Sprache hier heruntergeladen werden: <https://www.tp-link.com/support/ce/>

English

TP-Link hereby declares that the device is in compliance with the essential requirements and other relevant provisions of directives (EU)2015/863, 2014/53/EU, 2009/125/EC and 2011/65/EU.

The original EU declaration of conformity may be found at <https://www.tp-link.com/support/ce/>

Español

Por la presente TP-Link declara que este dispositivo cumple con los requisitos esenciales y otras disposiciones relevantes de las directivas (UE)2015/863, 2014/53/UE, 2009/125/CE y 2011/65/UE.

La declaración original CE de la conformidad puede encontrarse en:

<https://www.tp-link.com/support/ce/>

Ελληνικό

Δια του παρόντος η TP-Link διακηρύσσει ότι αυτή η συσκευή συμμορφώνεται με τις απαιτήσεις και άλλους σχετικούς κανονισμούς των οδηγιών (ΕΕ)2015/863, 2014/53/ΕΕ, 2009/125/ΕΚ και 2011/65/ΕΕ.

Μπορείτε να δείτε την αρχική δήλωση συμμόρφωσης με τους κανονισμούς της Ε.Ε. στην ιστοσελίδα <https://www.tp-link.com/support/ce/>

Français

TP-Link par la présente déclare que cet appareil est conforme aux exigences essentielles et autres dispositions pertinentes des directives (UE)2015/863, 2014/53/UE, 2009/125/CE et

2011/65/UE.

La déclaration CE de conformité originelle peut être trouvée à l'adresse
<https://www.tp-link.com/support/ce/>

Italiano

TP-Link dichiara che questo dispositivo è conforme ai requisiti fondamentali e alle altre disposizioni delle direttive (UE)2015/863, 2014/53/UE, 2009/125/CE e 2011/65/UE.

La dichiarazione di conformità EU originale si trova in <https://www.tp-link.com/support/ce/>

Português

A TP-Link declara que este dispositivo está em conformidade com os requisitos essenciais e outras disposições das diretivas (UE)2015/863, 2014/53/UE, 2009/125 /CE e 2011/65 /UE.

A declaração original de conformidade UE pode ser encontrada em
<https://www.tp-link.com/support/ce/>

Suomi

TP-Link ilmoittaa täten, että tämä laite noudattaa direktiivien 2014/53/EU, 2009/125/EY, 2011/65/EU ja (EU)2015/863 olennaisia vaatimuksia ja muita asianmukaisia ehtoja.

Alkuperäinen EU-säästöstenmukaisuusilmoitus on osoitteessa
<https://www.tp-link.com/support/ce/>

Nederlands

TP-Link verklaart hierbij dat dit apparaat in overeenstemming is met de essentiële eisen en andere relevante bepalingen van de richtlijnen (EU)2015/863, 2014/53/EU, 2009/125/EG en 2011/65/EU.

De oorspronkelijke EU verklaring van overeenstemming is te vinden op
<https://www.tp-link.com/support/ce/>

Svenska

TP-Link deklarerar att denna enhet är i överensstämmelse med de grundläggande kraven och andra relevanta bestämmelser i direktiv (EU)2015/863, 2014/53/EU, 2009/125/EG och 2011/65/EU.

Den ursprungliga EU-försäkran om överensstämmelse kan hittas på
<https://www.tp-link.com/support/ce/>

Norsk

TP-Link erklærer herved at denne enheten er i samsvar med de nødvendige kravene og andre relevante bestemmelser fra direktivene (EU)2015/863, 2014/53/EU, 2009/125/EC og 2011/65/EU.

Den opprinnelige EU-samsvarserklæringen er tilgjengelig på
<https://www.tp-link.com/support/ce/>

Dansk

TP-Link erklærer hermed, at denne enhed er i overensstemmelse med de væsentlige krav og andre relevante bestemmelser i direktiverne (EU)2015/863, 2014/53/EU, 2009/125/EF og 2011/65/EU.

Den oprindelige EU-overensstemmelseserklæringen kan findes på <https://www.tp-link.com/support/ce/>

Warranty

Deutsch

Nur für Original-TP-Link-Produkte. Informationen über die Garantiezeit, Regelungen und Verfahrensweisen finden Sie unter <https://www.tp-link.com/de/support>

DIESE GARANTIE VERLEIHT IHNEN BESTIMMTE RECHTE, DIE VON DEM VERKAUFSLAND ABHÄNGIG SEIN KÖNNEN.

BIS ZU DEN GESETZLICHEN GRENZEN ERSETZEN DIESE GARANTIE UND DIESE HILFESTELLUNGEN ANDERSARTIGE GARANTIEEN, HILFESTELLUNGEN UND KONDITIONEN.

TP-Link garantiert für einen einwandfreien Zustand von originalverpackten TP-Link-Geräten hinsichtlich Funktion und Materialverarbeitung, normale Benutzung vorausgesetzt.

English

For TP-Link Branded Products Only. For the information about warranty period, policy and procedures, please visit <https://www.tp-link.com/en/support>

THIS WARRANTY GIVES YOU SPECIFIC LEGAL RIGHTS, AND YOU MAY HAVE OTHER RIGHTS THAT VARY FROM STATE TO STATE (OR BY COUNTRY OR PROVINCE).

TO THE EXTENT ALLOWED BY LOCAL LAW, THIS WARRANTY AND THE REMEDIES SET FORTH ARE EXCLUSIVE AND IN LIEU OF ALL OTHER WARRANTIES, REMEDIES AND CONDITIONS.

TP-Link warrants the TP-Link branded hardware product contained in the original packaging against defects in materials and workmanship when used normally in according with TP-Link's guidelines for some period which depends on the local service from the date of original retail purchase by the end-user purchaser.

Español

Sólo para productos que porten la marca TP-Link. Para obtener información sobre el período de garantía, política y procedimientos, visitar <https://www.tp-link.com/es/support>

ESTA GARANTÍA LE CONFIERE DERECHOS LEGALES ESPECÍFICOS, Y ES POSIBLE QUE USTED DISPONGA DE OTROS DERECHOS, LOS CUALES PUEDEN VARIAR SEGÚN EL ESTADO (O SEGÚN EL PAÍS O PROVINCIA).

EN LA MEDIDA QUE LO PERMITA LA JURISDICCIÓN LOCAL, ESTA GARANTÍA Y LOS RECURSOS ESTABLECIDOS EN ELLA SON EXCLUSIVOS EN LUGAR DE CUALQUIER OTRA GARANTÍA, RECURSO Y CONDICIÓN.

TP-Link garantiza el producto de hardware que porta la marca TP-Link contenido en la caja original contra defectos en los materiales y mano de obra bajo condiciones normales de uso de acuerdo con las directrices de TP-Link por un periodo que depende del servicio local desde la

fecha original de compra en la tienda por parte del usuario final adquirente.

Ελληνικά

Μόνο για προϊόντα TP-Link. Για πληροφορίες σχετικά με την περίοδο, την πολιτική και τις διαδικασίες της εγγύησης, παρακαλούμε επισκεφθείτε: <https://www.tp-link.com/gr/support>

ΑΥΤΗ Η ΕΓΓΥΗΣΗ ΣΑΣ ΠΑΡΕΧΕΙ ΣΥΓΚΕΚΡΙΜΕΝΑ ΝΟΜΙΚΑ ΔΙΚΑΙΩΜΑΤΑ ΚΑΙ ΕΝΔΕΧΕΤΑΙ ΝΑ ΕΧΕΤΕ ΑΛΛΑ ΔΙΚΑΙΩΜΑΤΑ ΠΟΥ ΔΙΑΦΕΡΟΥΝ ΑΝΑΛΟΓΑ ΜΕ ΤΗ ΝΟΜΟΘΕΣΙΑ ΤΟΥ ΤΟΠΟΥ ΔΙΑΜΟΝΗΣ ΣΑΣ (ΧΩΡΑΣ Η΄ ΠΕΡΙΟΧΗΣ).

ΣΤΟ ΜΕΓΙΣΤΟ ΕΠΙΤΡΕΠΤΟ ΒΑΘΜΟ ΑΠΟ ΤΗΝ ΚΕΙΜΕΝΗ ΝΟΜΟΘΕΣΙΑ, Η ΠΑΡΟΥΣΑ ΕΓΓΥΗΣΗ ΚΑΙ ΟΙ ΔΙΑΤΑΞΕΙΣ ΤΗΣ ΕΙΝΑΙ ΑΠΟΚΛΕΙΣΤΙΚΗ ΚΑΙ ΥΠΕΡΚΕΙΤΑΙ ΟΛΩΝ ΤΩΝ ΑΛΛΩΝ ΕΓΓΥΗΣΕΩΝ, ΟΡΩΝ ΚΑΙ ΔΙΑΤΑΞΕΩΝ.

Η TP-Link παρέχει εγγύηση των προϊόντων, με την επωνυμία TP-Link, που περιέχονται στην αρχική τους συσκευασία έναντι ελαττωμάτων στο υλικό και την κατασκευή, υπό κανονική χρήση και σύμφωνα με τις οδηγίες της TP-Link, για συγκεκριμένο χρονικό διάστημα που εξαρτάται από την ημερομηνία αγοράς του προϊόντος από το τελικό καταναλωτή.

Français

Concerner les produits de marque TP-Link uniquement. Pour plus d'informations sur la période de garantie, les conditions et les procédures, veuillez visiter <https://www.tp-link.com/fr/support>

CETTE GARANTIE VOUS DONNE DES DROITS SPECIFIQUES, ET VOUS POUVEZ AVOIR D'AUTRES DROITS QUI PEUVENT VARIER D'UN ETAT, D'UN PAYS OU D'UNE PROVINCE A UNE AUTRE.

DANS LES LIMITES DU DROIT LOCAL, CETTE GARANTIE ET LES VOIES DE RECOURS SONT EXCLUSIVES ET REMPLACENT TOUT AUTRES GARANTIES RECOURS ET CONDITIONS.

TP-Link garanti les matériels marqués TP-Link, conditionnés dans un emballage original : contre les défauts matériels et les malfaçons, s'ils sont utilisés normalement et selon les prescriptions de TP-Link, pour une durée : inscrite sur l'emballage du produit ; à compter de la date d'achat par l'utilisateur final.

Italiano

Esclusivamente per prodotti marchiati TP-Link. Per le informazioni relative a periodo di garanzia, policy e procedure, visita il sito <https://www.tp-link.com/it/support>

LA PRESENTE GARANZIA CONFERISCE SPECIFICI DIRITTI LEGALI, IN AGGIUNTA AI DIRITTI PREVISTI DALLA LOCALE LEGISLAZIONE.

NEI LIMITI CONSENTITI DALLA LEGGE, LA PRESENTE GARANZIA ED I RIMEDI INDICATI SONO ESCLUSIVI ED IN LUOGO A TUTTE LE ALTRE GARANZIE, RIMEDI E CONDIZIONI.

TP-Link garantisce i soli prodotti hardware marchiati TP-Link venduti nella rispettiva confezione originale non compromessa ed utilizzati secondo le linee guida illustrate: il periodo di tempo di validità della garanzia, nel rispetto delle normative vigenti, vale a partire dalla data riportata sulla prova d'acquisto da parte dell'utente finale.

Português

Apenas para Produtos da Marca TP-Link. Para obter informações sobre o período de garantia,

política e procedimentos, visite <https://www.tp-link.com/pt/support>

ESTA GARANTIA DÁ-LHE DIREITOS LEGAIS ESPECÍFICOS E PODERÁ TER OUTROS DIREITOS QUE VARIAM ENTRE ESTADOS (OU ENTRE PAÍSES OU PROVÍNCIAS).

ATÉ AO LIMITE PERMITIDO PELA LEI LOCAL, ESTA GARANTIA E OS RECURSOS ESTABELECIDOS SÃO EXCLUSIVOS E SUBSTITUEM TODAS AS OUTRAS GARANTIAS, RECURSOS E CONDIÇÕES.

A TP-Link fornece garantia a qualquer produto da marca TP-Link contido na embalagem original do produto, contra qualquer defeito nos materiais e construção, quando o mesmo é utilizado em condições normais e de acordo com as orientações fornecidas pela TP-Link, por um período definido pelo do serviço de apoio local a partir da data de compra pelo utilizador final.

Suomi

Koskee vain TP-Link-merkisiä tuotteita. Lisätietoa takuujasta, -käytännöstä ja -toimenpiteistä löydät osoitteesta <https://www.tp-link.com/fi/support>

TÄMÄ TAKUU MYÖNTÄÄ KÄYTTÄJÄLLE TIETTYJÄ LAILLISIA OIKEUKSIA, JA HÄNELÄ VOI OLLA MUITA OIKEUKSIA, JOTKA VAIHTELEVAT MAAKOHTAISESTI.

SIINÄ MÄÄRIN KUIN LAKI SEN SALLII, TÄMÄ TAKUU JA SEN MUKAISETKORJAUSKEINOT OVAT YKSINOMAISIA JA KORVAAVAT KAIKKI MUUT TAKUUT, KORJAUSKEINOT JA EHDOT.

TP-Link takaa, että TP-Link-merkkinen laitteistotuote, joka saapui

alkuperäisessä pakkauksessa, ei sisällä materiaali- tai valmistusvirheitä normaalissa TP-Linkin ohjeiden mukaisessa käytössä tietyssä paikallisesta palvelusta riippuvana aikana siitä päivämäärästä lukien, jona loppukäyttäjä sen alun perin hankki.

Nederlands

Geldt alleen voor producten van het merk TP-Link. Voor meer informatie over de garantieperiode, voorwaarden en procedures kijk op: <https://www.tp-link.com/nl/support>

DEZE GARANTIE GEEFT U SPECIFIEKE WETTELIJKE RECHTEN EN U KUNT NOG ANDERE RECHTEN HEBBEN, DIE PER LAND (OF PER PROVINCIE) KUNNEN VERSCHILLEN.

VOOR ZOVER TOEGESTAAN DOOR DE PLAATSELIJKE WETGEVING ZIJN DEZE GARANTIE EN HET VERMELDE VERHAAL EXCLUSIEF EN KOMEN DIE IN DE PLAATS VAN ALLE ANDERE GARANTIES, VERHALEN EN VOORWAARDEN.

TP-Link geeft garantie op het hardware product van het merk TP-Link in de originele verpakking voor gebreken in materialen en fabricage indien normaal gebruikt in overeenstemming met de richtlijnen van TP-Link gedurende een bepaalde periode afhankelijk van de service ter plaatse vanaf de oorspronkelijke datum van aanschaf via de detailhandel door de eindgebruiker-koper.

Svenska

Enbart för produkter av märket TP-Link. För information om garantitid, policy och förfaranden, gå till <https://www.tp-link.com/se/support>

DEN HÄR GARANTIN GER DIG SPECIFIKA FORMELLA RÄTTIGHETER OCH DU KAN HA ANDRA RÄTTIGHETER SOM VARIERAR FRÅN LAND TILL LAND (ELLER STAT ELLER PROVINNS).

I DEN OMFATTNING SOM LOKALA LAGAR TILLÅTER ÄR DENNA GARANTI OCH GOTTGÖRANDE

EXKLUSIVA OCH I STÄLLET FÖR ALLA ANDRA GARANTIER, GOTTGÖRANDE OCH VILLKOR. TP-Link garanterar maskinvara av märket TP-Link i sin originalförpackning mot defekter i material eller sammansättning vid normal användning enligt TP-Links riktlinjer och under en period beroende på lokal underhållsservice baserat från ursprungliga inköpsdatumet för slutanvändaren.

Norsk

Gjelder kun for produkter merket TP-Link. For informasjon om garantiperiode, retningslinjer og prosedyrer, vennligst besøk <https://www.tp-link.com/no/support/>

DENNE GARANTIEN GIR DEG SPESIFISERTE, RETTSLIGE RETTIGHETER, OG I TILLEGG KAN DU HA ANDRE RETTIGHETER SOM VARIERER MED JURISDIKSJON (ETTER LAND).

I DEN UTSTREKNING DET ER TILLATT I HENHOLD TIL LOKAL LOV ER DENNE GARANTIEN OG LØSNINGENE SOM HER ER FREMSATT EKSKLUSIVE OG ERSTATTER ALLE ANDRE GARANTIER, LØSNINGER OG BETINGELSER.

TP-Link garanterer at det TP-Link-merkede maskinwareproduktet som ligger i den originale emballasjen er fri for feil i materialer og utførelse når det brukes på normal måte i samsvar med TP-Links retningslinjer i en periode som avhenger av lokale forhold fra den datoen sluttbrukeren opprinnelig kjøpte produktet fra en forhandler.

Dansk

Gælder kun TP-Link mærkevarer. For mere information om garanti og procedurer, gå venligst til <https://www.tp-link.com/dk/support>

DENNE GARANTI GIVER DIG SPECIFIKKE JURIDISKE RETTIGHEDER OG DU KAN HAVE ANDRE RETTIGHEDER SOM VARIERER FRA STAT TIL STAT (ELLER FRA LAND ELLER PROVINS).

INDENFOR LOVENS RAMMER ER GARANTIEN OG RETSMIDLERNE DER FREMGÅR EKSKLUSIVE OG I STEDET FOR ALLE ANDRE RETTIGHEDER, RETSMIDLER OG BETINGELSER.

TP-Link garanterer at alle TP-Link hardware produkter indeholdt i den originale emballage ikke er behæftede med fejl på materialer og håndværk såfremt de bruges efter hensigten og i overensstemmelse med TP-Link's retningslinjer, indenfor en periode som afhænger af den lokale service, fra købsdatoen af den oprindelige slutbruger/køber.



For technical support, the user guide and other information, please visit <https://www.tp-link.com/support/>, or simply scan the QR code.