

# Installation Guide

## Smart-UPS<sup>™</sup> C 1000/1500 VA 120/230 Vac 2000/3000 VA 230 Vac Tower

### Important Safety Messages

Read the instructions carefully to become familiar with the equipment before trying to install, operate, service or maintain it. The following special messages may appear throughout this manual or on the equipment to warn of potential hazards or to call attention to information that clarifies or simplifies a procedure.



The addition of this symbol to a Caution product safety label indicates that a hazard exists that can result in injury and product damage if the instructions are not followed.

The following safety messages may appear throughout this manual to warn of potential hazards.

 <b>CAUTION</b>
<b>CAUTION</b> indicates a potentially hazardous situation which, if not avoided, <b>can result in</b> equipment damage and minor or moderate injury.

<b>CAUTION</b>
<b>CAUTION</b> indicates a potentially hazardous situation which, if not avoided, <b>can result in</b> equipment damage.

### Safety and General Information

**Inspect the package contents upon receipt. Notify the carrier and dealer if there is any damage.**

**Read the Safety Guide supplied with this unit before installing the UPS.**

- Adhere to all local and national electrical codes.
- This UPS is intended for indoor use only.
- Do not operate this UPS in direct sunlight, in contact with fluids, or where there is excessive dust or humidity.
- Be sure the air vents on the UPS are not blocked. Allow adequate space for proper ventilation.
- The battery typically lasts for two to five years. Environmental factors impact battery life. Elevated ambient temperatures, poor quality utility power, and frequent short duration discharges will shorten battery life.
- Connect the UPS power cable directly to a wall outlet. Do not use surge protectors or extension cords.

 <b>WARNING</b>
<b>This is a category C2 UPS product.</b>
In a residential environment, this product may cause radio interference, in which case the user may be required to take additional measures.

# Inventory

## All models



(2)

Documentation CD x 1  
PowerChute Software CD x 1

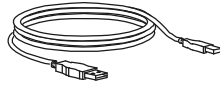

(1)



(1)

Installation Guide

### 1000/1500/2000/3000 VA 230 Vac models

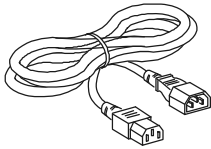

(2)

### 2000/3000 VA 230 Vac models

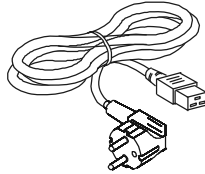

(1)

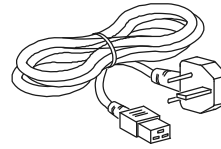

(1)

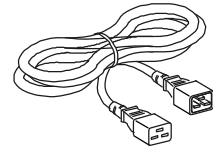

(1)

# Product Overview

## 1000/1500 VA 120 Vac models

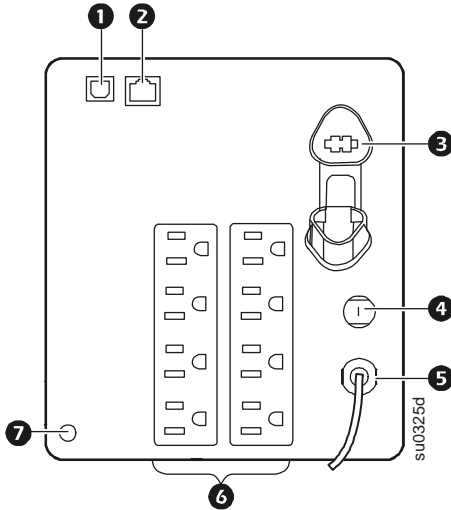

- 1 USB port
- 2 Serial data port
- 3 Battery connector

## 1000/1500 VA 230 Vac models

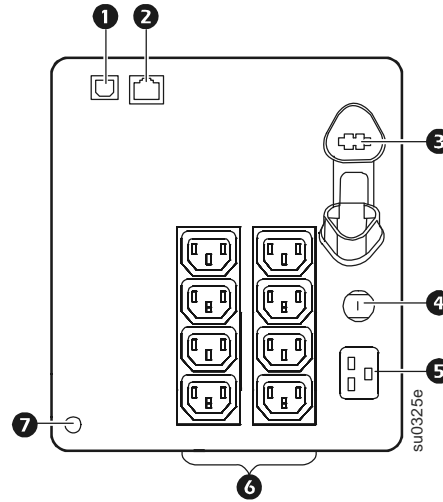

- 4 Circuit breaker/Overload protection
- 5 UPS input
- 6 Outlets
- 7 Chassis ground screw

### 2000 VA 230 Vac model

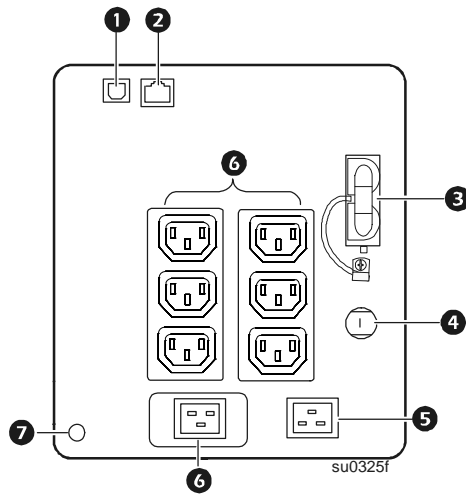

### 3000 VA 230 Vac model

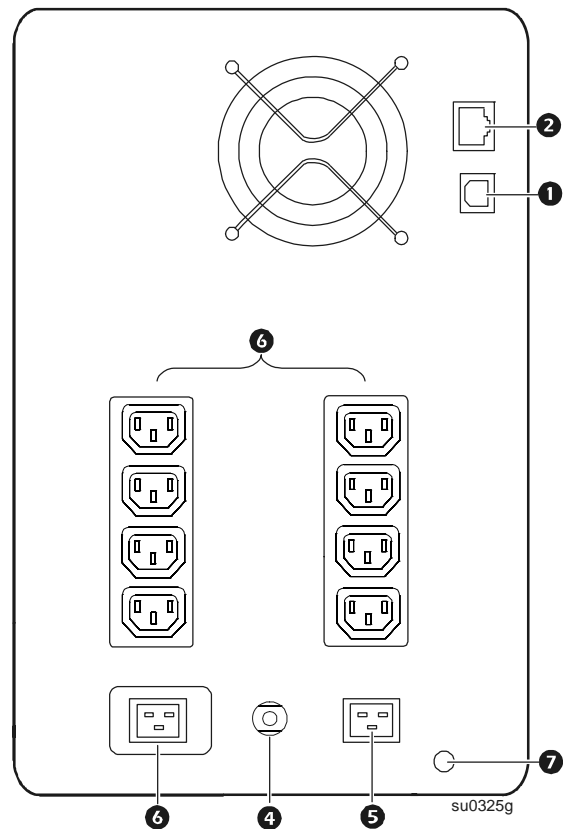

- 1 USB port
- 2 Serial data port
- 3 Battery connector

- 4 Circuit breaker/Overload protection
- 5 UPS input
- 6 Outlets
- 7 Chassis ground screw

### Front panel features

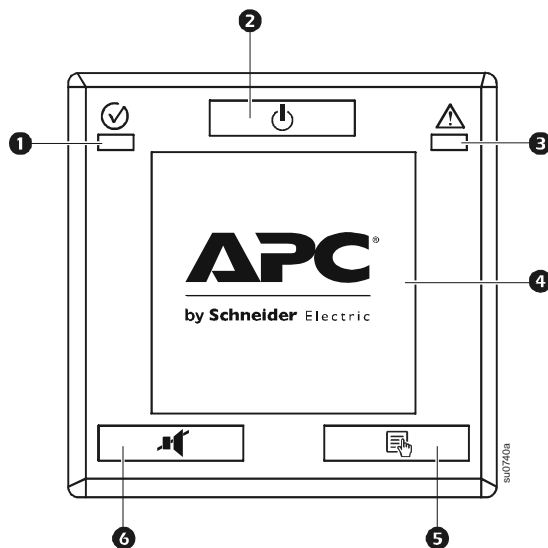

- 1 Online/On Battery LED
- 2 POWER ON/OFF button
- 3 Site Wiring Fault/System Fault LED
- 4 Display interface
- 5 DISPLAY button
- 6 MUTE button

# Installation

## Connect the Battery

### 1000/1500 VA models

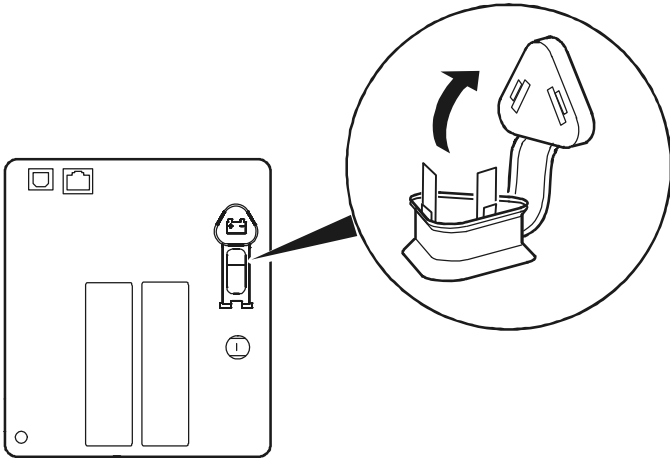

### 3000 VA model

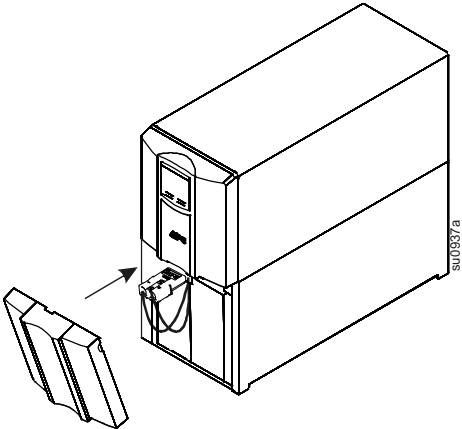

### 2000 VA model

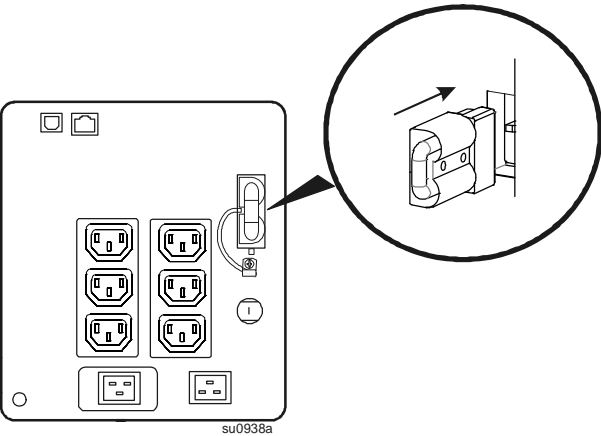

## Connect equipment to the UPS and connect the UPS to utility power

### CAUTION

#### RISK OF EQUIPMENT DAMAGE

- Adhere to all local and national electrical codes.
- Wiring should be performed by qualified electrician.
- Always connect the UPS to a grounded outlet.

Failure to follow these instructions can result in equipment damage

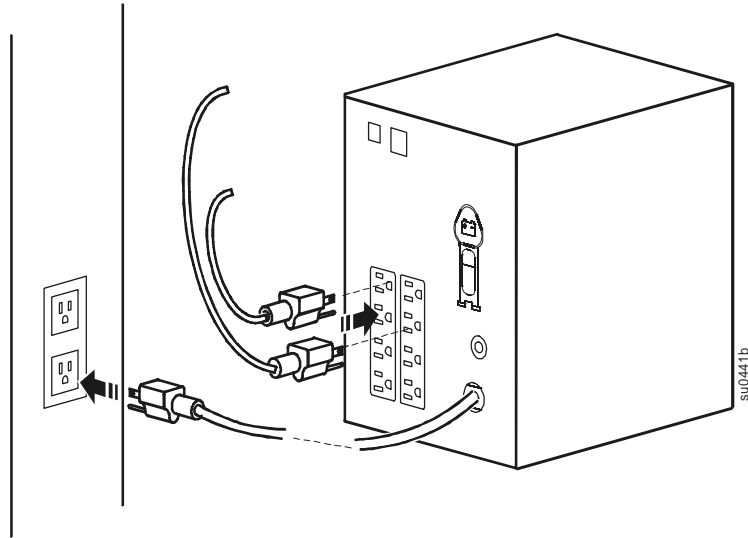



Select models are ENERGY STAR<sup>®</sup> qualified.  
For more information go to [www.apc.com/site/recycle/index.cfm/energy-efficiency/energy-star/](http://www.apc.com/site/recycle/index.cfm/energy-efficiency/energy-star/).