

USER MANUAL

ProLite

LCD Monitor

ENGLISH

ProLite XUB3493WQSU

Thank you very much for choosing the iiyama LCD monitor.

We recommend that you take a few minutes to read carefully through this brief but comprehensive manual before installing and switching on the monitor. Please keep this manual in a safe place for your future reference.



Dear user, we congratulate you on the purchase of your iiyama LCD.

For details on warranty and locally used pixel policies that apply directly after installation of your product please check the iiyama website.

To report a fault, please contact your local support centre found at <https://iiyama.com>

Things to check before you call the iiyama information line

- | if the power cable is connected securely and turned on?
- | if the display has been turned on?
- | if the signal cable is connected securely and the correct input selected?
- | if the computer has been restarted with the display connected?
- | if the graphics card is correctly installed with the latest drivers possible?
- | if the correct native resolution has been selected via 'Display Properties'?
- | If the R/G/B signal configuration is correct?
- | if the displays On Screen Menu is shown?
- | if the correct brightness and contrast settings have been set?
- | if given display tolerances and compatibility have been considered?
- | if via the On Screen Menu you have performed a Factory Reset/Recall?



Before reporting the screen defect, please prepare the following information/evidence:

- | model number *
- | purchase receipt and serial number *
- | name and address for collection
- | telephone/fax number, for availability during the day
- | convenient collection date (date, time)
- | short description of the defect

Important Note:

If there is no fault found in the collected equipment after inspection, the transferring party shall incur charges for transport and administration.

If you have checked all of the above and there is still no picture, call our information line for assistance in your country.

* see the identification plate on the back of the case.

CE MARKING DECLARATION OF CONFORMITY

This LCD monitor complies with the requirements of the EC/EU Directive 2014/30/EU "EMC Directive", 2014/35/EU "Low Voltage Directive", 2009/125/EC "ErP Directive" and 2011/65/EU "RoHS Directive".

The electro-magnetic susceptibility has been chosen at a level that gives correct operation in residential areas, business and light industrial premises and small-scale enterprises, inside as well as outside of the buildings. All places of operation are characterized by their connection to the public low voltage power supply system.

IYAMA CORPORATION: Wijkmeerstraat 8, 2131 HA Hoofddorp, The Netherlands

Model No. : PL3493WQ



We recommend recycling of used product. Please contact your dealer or iiyama service center. Recycle information is obtained via the Internet, using the address: <https://iiyama.com>

You can access the Web page of different countries from there.

- We reserve the right to change specifications without notice.
- All trademarks used in this user manual are the property of their respective owners.
- Eprel registration number XUB3493WQSU-B5 : 1384863

TABLE OF CONTENTS

FOR YOUR SAFETY.....	1
SAFETY PRECAUTIONS.....	1
SPECIAL NOTES ON LCD MONITORS.....	3
CUSTOMER SERVICE.....	3
CLEANING.....	3
BEFORE YOU OPERATE THE MONITOR.....	4
FEATURES.....	4
CHECKING THE CONTENTS OF THE PACKAGE.....	4
USING ARM OR STAND.....	5
FITTING AND REMOVAL OF STAND.....	6
CONTROLS AND CONNECTORS.....	7
CONNECTING YOUR MONITOR.....	8
COMPUTER SETTING.....	9
ADJUSTING THE HEIGHT AND THE VIEWING ANGLE.....	9
OPERATING THE MONITOR.....	10
ADJUSTMENT MENU CONTENTS.....	11
STANDBY FEATURE.....	20
TROUBLE SHOOTING.....	21
RECYCLING INFORMATION.....	22
APPENDIX.....	23
SPECIFICATIONS : ProLite XUB3493WQSU-B5.....	23
DIMENSIONS.....	24
COMPLIANT TIMING.....	24

FOR YOUR SAFETY

SAFETY PRECAUTIONS

WARNING

STOP OPERATING THE MONITOR IF YOU ARE AWARE OF ANY PROBLEMS

If you notice any abnormal phenomena such as smoke, strange sounds or fumes, unplug the monitor and contact your dealer or iiyama service center immediately. Further use may be dangerous and can cause fire or electric shock.

NEVER REMOVE THE CABINET

High voltage circuits are inside the monitor. Removing the cabinet may expose you to the danger of fire or electric shock.

DO NOT PUT ANY OBJECT INTO THE MONITOR

Do not put any solid objects or liquids such as water into the monitor. In case of an accident, unplug your monitor immediately and contact your dealer or iiyama service center. Using the monitor with any object inside may cause fire, electric shock or damage.

INSTALL THE MONITOR ON A FLAT, STABLE SURFACE

The monitor may cause an injury if it falls or is dropped.

DO NOT USE THE MONITOR NEAR WATER

Do not use where water may be splashed or spilt onto the monitor as it may cause fire or electric shock.

OPERATE UNDER THE SPECIFIED POWER SUPPLY

Be sure to operate the monitor only with the specified power supply. Use of an incorrect voltage will cause malfunction and may cause fire or electric shock.

PROTECT THE CABLES

Do not pull or bend the power cable and signal cable. Do not place the monitor or any other heavy objects on the cables. If damaged, the cables may cause fire or electric shock.

ADVERSE WEATHER CONDITIONS

It is advisable not to operate the monitor during a heavy thunder storm as the continual breaks in power may cause malfunction. It is also advised not to touch the plug in these circumstances as it may cause electric shock.

CAUTION

INSTALLATION LOCATION

Do not install the monitor where sudden temperature changes may occur, or in humid, dusty or smoky areas as it may cause fire, electric shock or damage. You should also avoid areas where the sun shines directly on the monitor.

DO NOT PLACE THE MONITOR IN A HAZARDOUS POSITION

The monitor may topple and cause injury if not suitably located. Please also ensure that you do not place any heavy objects on the monitor, and that all cables are routed such that children may not pull the cables and possibly cause injury.

MAINTAIN GOOD VENTILATION

Ventilation slots are provided to keep the monitor from overheating. Covering the slots may cause fire. To allow adequate air circulation, place the monitor at least 10cm (or 4 inches) from any walls.

When removing the tilt stand, the ventilation slots on the back side of the monitor can be blocked. This may overheat the monitor and may cause fire or damage. Make sure to allow enough ventilation when removing the tilt stand. Operating the monitor on its back, side, upside down or on a carpet or any other soft material may also cause damage.

DISCONNECT THE CABLES WHEN YOU MOVE THE MONITOR

When you move the monitor, turn off the power switch, unplug the monitor and be sure the signal cable is disconnected. If you do not disconnect them, it may cause fire or electric shock.

UNPLUG THE MONITOR

If the monitor is not in use for a long period of time it is recommended that it is left unplugged to avoid accidents.

HOLD THE PLUG WHEN DISCONNECTING

To disconnect the power cable or signal cable, always pull it by the plug. Never pull on the cable itself as this may cause fire or electric shock.

DO NOT TOUCH THE PLUG WITH WET HANDS

Pulling or inserting the plug with wet hands may cause electric shock.

WHEN YOU INSTALL THE MONITOR ON YOUR COMPUTER

Be sure the computer is strong enough to hold the weight of the monitor, otherwise, you may damage your computer.

CAREFUL! PROTECT YOUR HANDS AND FINGERS

- Be careful not to hurt your fingers or hands when you change the height or the angle.
- Injury can occur if care is not taken to avoid finger contact with the displays base when adjusting the height.

REMARK FOR 24/7 USAGE

This product is not specifically designed for 24/7 usage in all environments.

REMARK FOR WALL MOUNTING

This product is not designed for digital signage (electronic signboard) applications such as wall mounting.

OTHERS

ERGONOMIC RECOMMENDATIONS

To eliminate eye fatigue, do not operate the monitor against a bright background or in a dark room. For optimal viewing comfort, the monitor should be just below eye level and 40-60 cm (16-24 inches) away from your eyes. When using the monitor over a prolonged time, a ten minute break every hour is recommended as looking at the screen continuously can cause eye strain.

SPECIAL NOTES ON LCD MONITORS

The following symptoms are normal with LCD monitors and do not indicate a problem.

NOTE

- When you first turn on the LCD monitor, the picture may not fit in the display area because of the type of computer that is used. In this case, adjust the picture position to the correct position.
- You may find slightly uneven brightness on the screen depending on the desktop pattern you use.
- Due to the nature of the LCD screen, an afterimage of the previous screen may remain after switching the image, when the same image is displayed for hours. In this case, the screen can be recovered slowly by changing the image or turning off the Power Switch for some hours.

CUSTOMER SERVICE

NOTE

- If you have to return your unit for service and the original packaging has been discarded, please contact your dealer or iiyama service center for advice or replacement packaging.

CLEANING

WARNING

- If you drop any materials or liquids such as water into the monitor when cleaning, unplug the power cable immediately and contact your dealer or iiyama service center.

CAUTION

- For safety reasons, turn off the power switch and unplug the monitor before you clean it.

NOTE

- To protect the LCD panel, do not scratch or rub the screen with a hard object.
- Never use any of the following strong solvents. These will damage the cabinet and the LCD screen.

Thinner	Spray-type cleaner
Benzine	Wax
Abrasive cleaner	Acid or Alkaline solvent

- Touching the cabinet with any product made from rubber or plastic for a long time may cause degeneration or loss of paint on the cabinet.

CABINET

Stains can be removed with a cloth lightly moistened with a mild detergent solvent. Then wipe the cabinet with a soft dry cloth.

LCD

Periodic cleaning with a soft dry cloth is recommended.

SCREEN

Don't use tissue paper etc. because these will damage the LCD screen.

BEFORE YOU OPERATE THE MONITOR

FEATURES

- ◆ Supports Resolutions up to 3440 × 1440
- ◆ High Contrast 1000:1 (Typical), Adv. Contrast Function Available / Brightness 400cd/m² (Typical) / Quick Response Time 4ms (Gray to Gray)
- ◆ Supports AMD FreeSync™ Technology
- ◆ Flicker - Free
- ◆ Blue Light Reducer
- ◆ Digital Character Smoothing
- ◆ 2 × 5W Stereo Speakers
- ◆ Standby Feature
- ◆ VESA Mounting Standard (100mm×100mm) Compliant
- ◆ Keyhole for Security Lock

CHECKING THE CONTENTS OF THE PACKAGE

The following accessories are included in your package. Check to see if they are enclosed with the monitor. If anything is missing or damaged, please contact your local iiyama dealer or regional iiyama office.

- | | | |
|----------------|----------------|---------------------------|
| ■ Power Cable* | ■ HDMI Cable | ■ DisplayPort Cable |
| ■ USB Cable | ■ Stand-Neck | ■ Stand-Base with a screw |
| ■ Screwdriver | ■ Safety Guide | ■ Quick Start Guide |

CAUTION

* The rating of the Power Cable enclosed in 120V area is 10A/125V. If you are using a power supply higher than this rating, then a power cable with a rating of 10A/250V must be used. However, all guarantees and warranties are void for any problems or damage caused by a power cable not supplied by iiyama.

An approved power cable greater or equal to H05VVVF, 3G, 0.75mm² must be used.

USING ARM OR STAND

CAUTION

- Before installation, make sure the display arm or desk arm stand is strong enough to hold the necessary weight of the monitor and the mount.
- Panel angle adjustment range : 23° upward and 5° downward

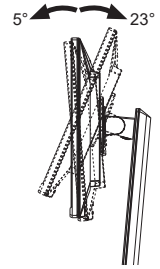

[DISPLAY ARM OR DESK ARM STAND]

CAUTION

- When you use with the display arm or desk arm stand, in consideration of thickness of the mounting stage, tighten the M4 Screws (4pcs) which "L" length is 10mm to fasten the monitor. Using the screw longer than this may cause electric shock or damage because it may contact with the electrical parts inside the monitor.

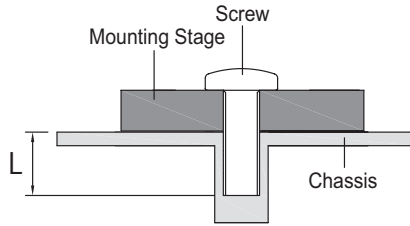

[LANDSCAPE MODE]

This monitor can only be used in landscape. Do not rotate or operate the monitor in any other orientation than landscape.

Available

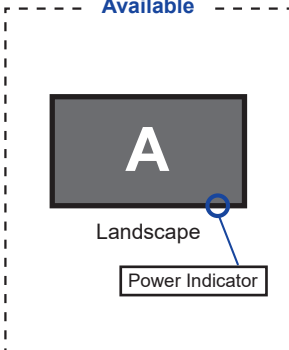

Not Available

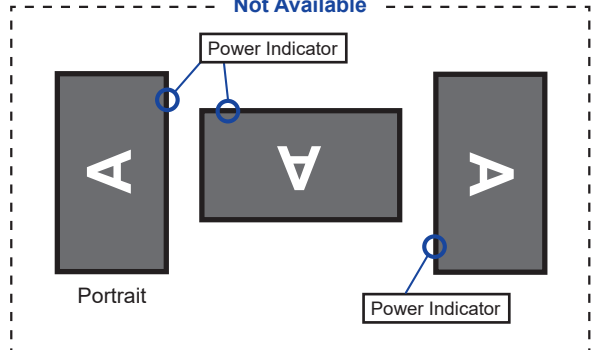

FITTING AND REMOVAL OF STAND

CAUTION

- Put the monitor on a stable surface. The monitor may cause injury or damage if it falls or is dropped.
- Do not give a strong impact to the monitor. It may cause damage.
- Unplug the monitor before removal or installation to avoid an electric shock or a damage.

<Installation>

- ① Put a piece of soft cloth on the table beforehand to prevent the monitor from being scratched. Lay the monitor flat on a table with front face down.
- ② Install the Stand-Neck to the monitor and then tighten the 'thumb screw' with the provided screwdriver to secure them.

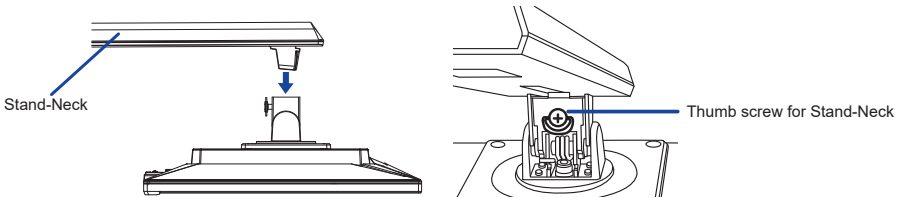

- ③ Install the Stand-Base to the Stand-Neck and then tighten the 'thumb screw' to secure them.

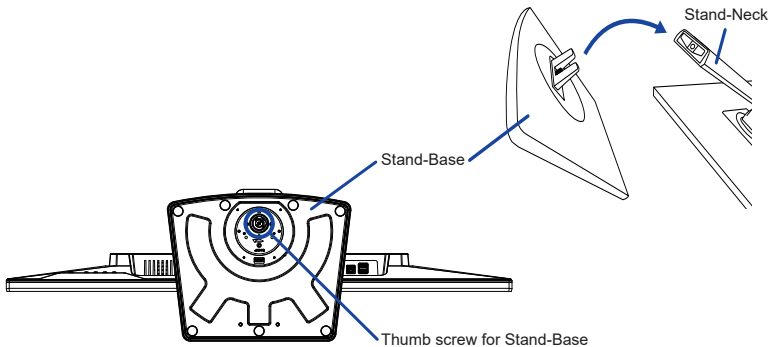

<Removal>

- ① Put a piece of soft cloth on the table beforehand to prevent the monitor from being scratched. Lay the monitor flat on a table with front face down.
- ② Loosen the 'thumb screw' to remove the Stand-Base from the Stand-Neck.
- ③ Loosen the 'thumb screw' with the provided screwdriver to remove the Stand-Neck from the monitor.

CONTROLS AND CONNECTORS

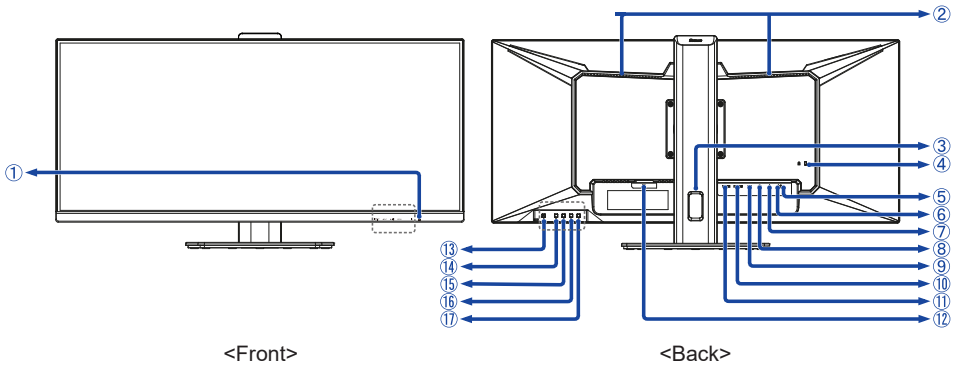

① Power Indicator

NOTE Blue: Normal operation
Orange: Standby mode

② Speakers

③ Cable Hole

④ Keyhole for Security Lock

NOTE You can fasten a security lock and cable to prevent the monitor from being removed without your permission.

⑤ USB Downstream Connector (: 5V, 900mA)

⑥ USB Downstream (Battery Charger) Connector (: 5V, 900mA)

⑦ USB Upstream Connector ()

⑧ Headphone Connector ()

⑨ DisplayPort Connector (DP)

⑩ HDMI Connector (HDMI-2)

⑪ HDMI Connector (HDMI-1)

⑫ AC Connector (~ : Alternating current)

⑬ Power Switch ()

⑭ Menu Button (MENU)

⑮ Right / Volume Button (/) *

⑯ Left / ECO Mode Button (/) *

⑰ Input Select / Exit Button (INPUT/EXIT) *

* You can skip the Menu items and directly display an option setting screen or an adjustment scale.

CONNECTING YOUR MONITOR

- ① Ensure that both the computer and the monitor are switched off.
- ② Connect the computer to the monitor with the signal cable.
- ③ Connect the computer to the monitor with the USB Cable.
- ④ Connect the Power Cable to the monitor first and then to the power source.
- ⑤ Turn on your monitor and computer.

NOTE

- Make sure that the building installation has a circuit breaker of 120/240V, 20A (maximum).
- The signal cables used for connecting the computer and monitor may vary with the type of computer used. An incorrect connection may cause serious damage to both the monitor and the computer. The cable supplied with the monitor is for a standard connector. If a special cable is required please contact your local iiyama dealer or regional iiyama office.
- The Class I pluggable equipment Type A must be connected to protective earth.
- The socket-outlet shall be installed near the equipment and shall be easily accessible.
- Excessive sound pressure from ear-/headphones can cause hearing damage/hearing loss.

[Example of Connection]

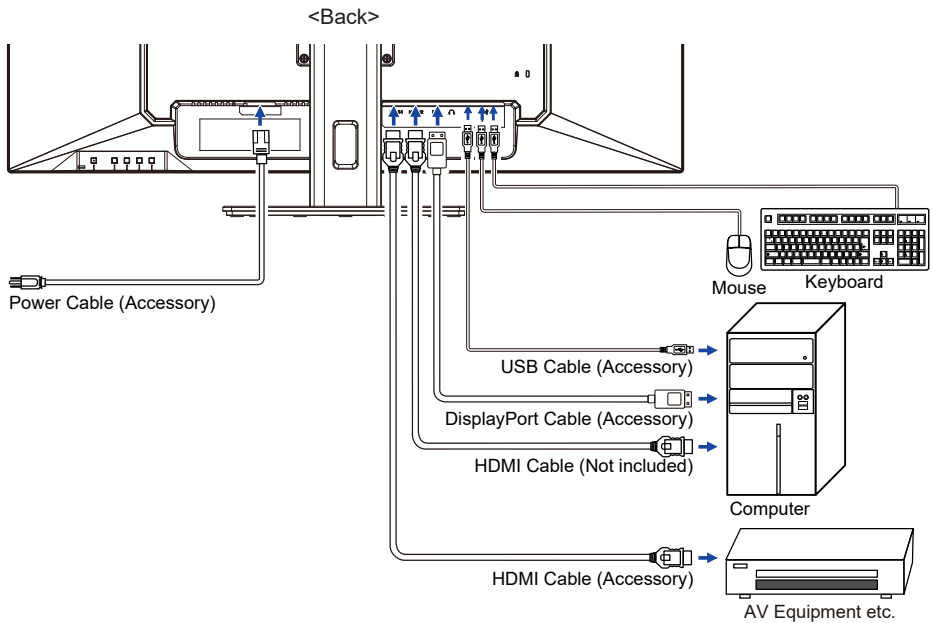

[Collect Cables]

Put the cables through the Cable Hole to bundle them.

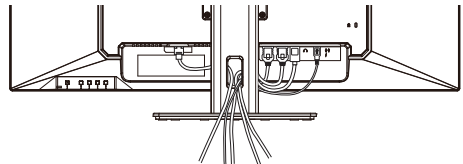

COMPUTER SETTING

■ Signal Timing

Change to the desired signal timing listed on page 24: COMPLIANT TIMING.

ADJUSTING THE HEIGHT AND THE VIEWING ANGLE

- For optimal viewing it is recommended to position yourself directly opposite to the full face of the monitor, then adjust the monitor's height and angle to your own preference.
- Hold the panel so that the monitor does not topple when you change the monitor's height or angle.
- You are able to adjust the monitor's height up to 150mm, angle up to 45 degrees right and left, 23 degrees upward and 5 degrees downward.

NOTE

- Do not touch the LCD screen when you change the height or the angle. It may cause damage or break the LCD screen.
- Careful attention is required not to pinch your fingers or hands into the moving part of the stand when you change the angle.
- Injury can occur if care is not taken to avoid finger contact with the displays base when adjusting the height.

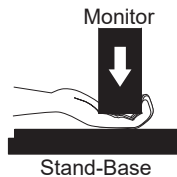
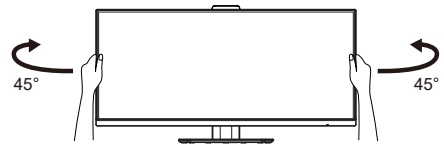
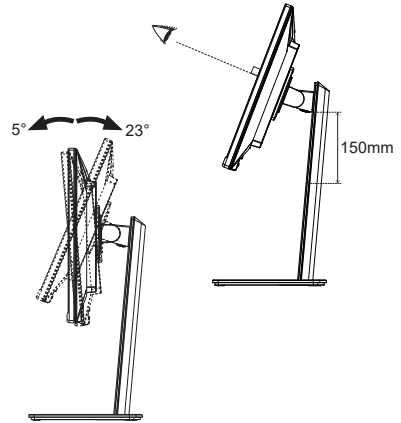

OPERATING THE MONITOR

To create the best picture, your iiyama LCD monitor has been preset at the factory with the COMPLIANT TIMING shown on page 24. You are also able to adjust the picture by following the button operation shown below.

- ① Press the MENU Button to start the On Screen Display (OSD) feature. There are additional Menu items which can be switched by using the ◀ / ▶ Buttons.



- ② Select the Menu item which contains the adjustment icon relating to the adjustment you want to make. Press the MENU Button. Then, use the ◀ / ▶ Buttons to highlight the desired adjustment icon.
- ③ Press the MENU Button again. Use the ◀ / ▶ Buttons to make the appropriate adjustment or setting.
- ④ Press the EXIT Button to leave the menu, and the settings you just made would be automatically saved.

For example, to correct for OSD vertical position, select Menu item of OSD Settings and press the MENU Button. Then, select OSD V. Position by using the ◀ / ▶ Buttons and press the MENU Button. Use the ◀ / ▶ Buttons to change the OSD vertical position settings. The OSD vertical position should be changing accordingly while you are doing this.

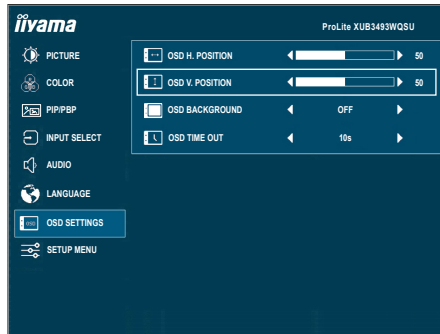

When you press the EXIT Button to end the adjustment, all changes are saved in the memory.

NOTE

- When button operations are aborted during adjustment, On-Screen Display disappears when the time set for the OSD Time Out has passed. Also, the EXIT Button can be used to return previous menu and turn off the On-Screen Display.
- Any changes are automatically saved in the memory when the On Screen Display disappears. Turning off the power should be avoided while using the Menu.

ADJUSTMENT MENU CONTENTS

Picture

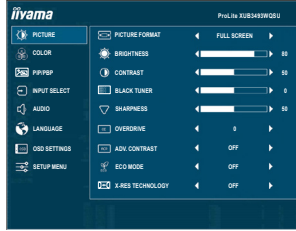

Adjustment Item	Problem / Option	Button to Press
Picture Format *1	Full Screen	Full screen display
	Aspect Ratio *2	Expansion display of Aspect
	Dot By Dot *2	Display the picture dot by dot.
	17 inch	Display the picture as 17 inch screen (5 : 4)
	19 inch	Display the picture as 19 inch screen (5 : 4)
	19.5 inch	Display the picture as 19.5 inch screen (16 : 9)
	21.5 inch	Display the picture as 21.5 inch screen (16 : 9)
	23 inch	Display the picture as 23 inch screen (16 : 9)
	24 inch	Display the picture as 24 inch screen (16 : 9)
27 inch	Display the picture as 27 inch screen (16 : 9)	
Brightness *3,4	Too dark	▶
	Too bright	◀
Contrast *4	Too dull	▶
	Too intense	◀
Black Tuner	From -5 to +5	▶
	You can adjust Dark shades.	◀
Sharpness *1	You can change the picture quality from 0 to 100 (sharp to soft).	▶
	Press the ▶ Button to change the picture quality in numerical order. Press the ◀ Button to change the picture quality in reverse numerical order. Adjust the picture quality at resolutions of less than 3440 × 1440.	◀
Overdrive *1,4	Off / -2 / -1 / 0 / +1 / +2	▶
	Improve the gray level response time of the LCD panel. A higher level results in a faster response time.	◀
Adv. Contrast *1,4	On	Increase Contrast Ratio
	Off	Typical Contrast Ratio



Picture

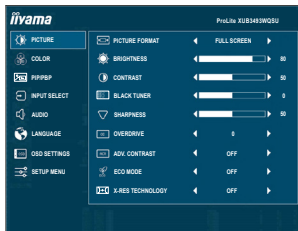

Adjustment Item	Problem / Option	
ECO Mode ^{*4} Direct	Off	Normal
	1	Brightness of back-light is reduced.
	2	Brightness of back-light is reduced more than 1.
	3	Brightness of back-light is reduced more than 2.
X-Res Technology	Off	Normal
	Soft	Enhance the picture edge.
	Middle	Enhance the picture edge more than the Soft option.
	Hard	Enhance the picture edge more than the Middle option.

^{*1} Picture Format, Sharpness, Overdrive and Adv. Contrast are disabled when PiP/PbP Mode is activated.

^{*2} Selectable only at resolutions less than 3440 × 1440.

^{*3} Adjust the Brightness when you are using the monitor in a dark room and feel the screen is too bright.

^{*4} Adjustable / settable items depend on which item is activated. See page 19 Function Correlation Matrix for more details.

Direct

You can skip the Menu items and directly display an option setting screen by using the following button operations.

- ECO Mode: Press the  Button when the Menu is not displayed.



Color *1

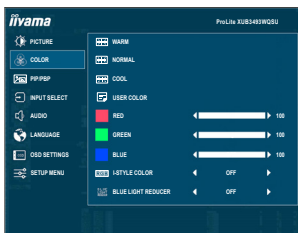

Adjustment Item	Problem / Option		Button to Press
Warm	Warm color		
Normal	Normal color		
Cool	Cool color		
User Color	Red	Too weak	
	Green	Too strong	
	Blue		
i-Style Color *2	Standard	For general windows environment and monitor default setting	
	Game	For PC game environment	
	Cinema	For movie and video environment	
	Scenery	For displaying outdoor scenery images	
	Text	For text editing and viewing in a word processing environment	
	Off	Return to a state set by color adjustment except i-Style Color.	
Blue Light Reducer *2	Off	Typical	
	1	Blue light is reduced.	
	2	Blue light is reduced more than 1.	
	3	Blue light is reduced more than 2.	

*1 Functions other than Blue Light Reducer is disabled when Blue Light Reducer is activated.

*2 Adjustable / settable items depend on which item is activated. See page 19 Function Correlation Matrix for more details.



PiP/PbP



Adjustment Item	Option	
PiP/PbP Mode *	Off	PiP/PbP Mode is turned off.
	PiP	Display the sub screen in the main screen.
	PbP	Display the main screen on the left and the sub screen on the right.
Sub Win Input	HDMI1	Select the HDMI1 input.
	HDMI2	Select the HDMI2 input.
	DisplayPort	Select the DisplayPort input.
PiP Size	Small	Reduce the size of the Sub screen.
	Middle	Normal size
	Large	Increase the size of the Sub screen.
PiP Position	Top-Right	Move the sub screen to the top right corner.
	Top-Left	Move the sub screen to the top left corner.
	Bottom-Right	Move the sub screen to the bottom right corner.
	Bottom-Left	Move the sub screen to the bottom left corner.
Swap	Swap the Main/Sub screens when PiP/PbP mode is active.	

* PiP = Picture in Picture

With this function, you can display two different pictures.

PbP = Picture by Picture

With this function, display images from two sources side by side.

PiP/PbP Input Matrix

PiP/PbP		Main Screen		
		HDMI1	HDMI2	DisplayPort
Sub Screen	HDMI1	✓	—	✓
	HDMI2	—	✓	✓
	DisplayPort	✓	✓	✓

✓ : Available

— : Not available

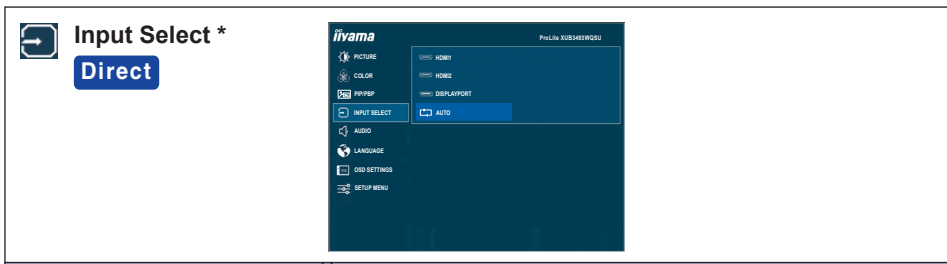

Adjustment Item	Option	
Input Select	HDMI1	Select the HDMI1 input.
	HDMI2	Select the HDMI2 input.
	DisplayPort	Select the DisplayPort input.
	AUTO	Search for an available input source and select automatically.

NOTE "AUTO" function enables automatic selection of the input sources available. The input source from the computer in standby mode can not be selected. If you manually select one of the input sources, the other source is not automatically selected.



* "Input Select" including direct operation below is disabled when PiP/PbP function is activated.

Direct

You can skip the Menu items and directly display an option setting screen by using the following button operations.

- Input Select: Press the INPUT Button when the Menu is not displayed.





Adjustment Item		Problem / Option	Button to Press
Volume	Direct	Too soft Too loud	 
Mute	Direct	On	Turn off the sound temporarily.
		Off	Return the sound volume to the previous level.
Audio Input *		HDMI1	Select the HDMI1 input.
		HDMI2	Select the HDMI2 input.
		DisplayPort	Select the DisplayPort input.

* "Audio Input" selection is available only when PiP/PbP function is activated.

Direct

You can skip the Menu items and directly display an adjustment scale or an option setting screen by using the following button operations.

- Volume: Press the  Button when the Menu is not displayed.
- Mute: Keep pressing the  Button for about 2 seconds when the Menu is not displayed.
Mute and Unmute are switched by repeating the above button operation.



Language

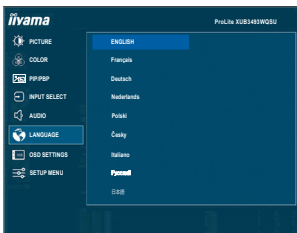









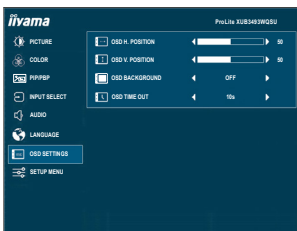







Adjustment Item	Option			
Language	English	English	Česky	Czech
	Français	French	Italiano	Italian
	Deutsch	German	Русский	Russian
	Nederlands	Dutch	日本語	Japanese
	Polski	Polish		

ENGLISH



OSD Settings



Adjustment Item	Problem / Option	Button to Press
OSD H. Position	OSD is too left OSD is too right	   
OSD V. Position	OSD is too low OSD is too high	   
OSD Background	The background of OSD is made transparent. Off / 1 / 2 / 3 / 4	   
OSD Time Out	You can set the OSD display duration time. 5 / 10 / 30 / 60 seconds	   



Setup Menu

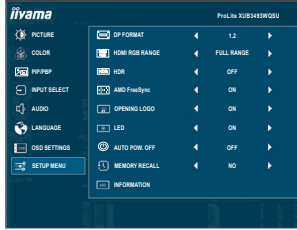

Adjustment Item	Option	
DP Format *1	1.2	Standard
	1.1	If any abnormal picture visible, you can change the setting to 1.1.
HDMI RGB Range *2	Full Range	For full-range color scale signal
	Limited Range	For limited color scale signal
HDR	On	For HDR (High Dynamic Range) signal
	Off	For normal signal
AMD FreeSync	On	Enable the Freesync function.
	Off	The Freesync function is turned off.
Opening Logo	On	iivama Logo is displayed when the monitor is turned on.
	Off	iivama Logo is not displayed when the monitor is turned on.
LED	On	The Power Indicator is turned On.
	Off	The Power Indicator is turned Off.

NOTE Turn Off the Power Indicator when you are bothered by the light.

Auto Pow. Off	On	Enable the Auto Pow. Off function.
	Off	Auto Pow. Off function is turned Off.

NOTE The Auto Pow. Off function is enabled as default setting. The monitor turns off automatically 3 hours after the key operation stops.
Disable Auto Pow. Off function when you use the monitor continuously for more than 3 hours.

Memory Recall	Yes	Factory-preset data is restored.
	No	Return to Menu.

Information	Display the information regarding the current input signal coming from the graphic card in your computer. <Example>	
		<p>NOTE</p> <p>See your graphic card user guide for more information about changing the resolution and refresh rate.</p>

*1 To display 3440 × 1440 at 75Hz, the DisplayPort setting must be enabled as 1.2, and the source graphic card must be capable of supporting 3440 × 1440 resolution at 75Hz.

*2 Available for HDMI input only.

■ Function Correlation Matrix

		Item to be selected						
		Adv. Contrast	ECO Mode	i-Style Color	Blue Light Reducer	Brightness	Contrast	Overdrive
Item activated	Adv. Contrast	–	–	✓	–	–	✓	✓
	ECO Mode	–	–	✓	–	–	✓	✓
	i-Style Color	–	–	–	–	–	–	–
	Blue Light Reducer	–	–	–	–	✓	✓	✓

✓ : Available

– : Not available

● Lock Mode

<OSD Menu>

1. The OSD lock will be activated by pressing the ◀ Button for 5 seconds. If you try to access the OSD by pressing any of the buttons, message "OSD Locked" will appear on the screen.
2. The OSD lock will be deactivated by pressing the ◀ Button again for 5 seconds.

<Power Switch>

1. The power switch lock will be activated by pressing the INPUT/EXIT Button for 5 seconds. Locking the power switch means that won't be able to turn off the Monitor while the power switch is locked. If you press the power switch, message "Power Button Locked" will appear on the screen.
2. The power switch lock will be deactivated by pressing the INPUT/EXIT Button again for 5 seconds.

STANDBY FEATURE

This product features the standby function. When activated, it automatically reduces unnecessary power consumption of the monitor when your computer is not in use.

There is a standby step the monitor takes as described below. The standby function, including any timer settings is configured by the operating system. Check your operating system manual for information on how this can be configured.

■ Standby Mode

When the video signal from the computer is off, the monitor enters into Standby Mode which reduces the power consumption to less than 0.5W*. The screen becomes dark, and the power indicator turns to orange. From Standby Mode, the image reappears in several seconds when either the keyboard or the mouse are touched again.

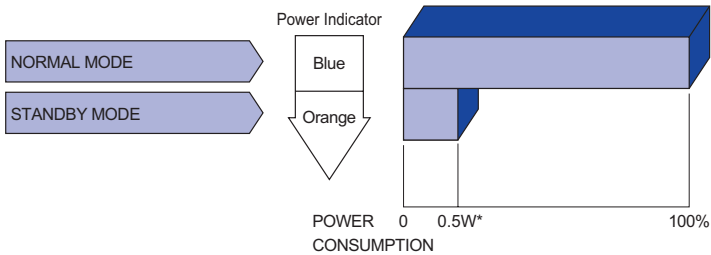

* When the USB devices are not connected.

TROUBLE SHOOTING

If the monitor fails to operate correctly, please follow the steps below for a possible solution.

1. Perform the adjustments described in OPERATING THE MONITOR, depending on the problem you have. If the monitor does not get a picture, skip to 2.
2. Consult the following items if you cannot find an appropriate adjustment item in OPERATING THE MONITOR or if the problem persists.
3. If you are experiencing a problem which is not described below or you cannot correct the problem, discontinue using the monitor and contact your dealer or iiyama service center for further assistance.

Problem	Check
① The picture does not appear. (Power indicator does not light up.) (Power indicator is blue.) (Power indicator is orange.)	<input type="checkbox"/> The Power Cable is firmly seated in the socket. <input type="checkbox"/> The Power Switch is turned ON. <input type="checkbox"/> The AC socket is live. Please check with another piece of equipment. <input type="checkbox"/> If the blank screen saver is in active mode, touch the keyboard or the mouse. <input type="checkbox"/> Increase the Contrast and/or Brightness. <input type="checkbox"/> The computer is ON. <input type="checkbox"/> The Signal Cable is properly connected. <input type="checkbox"/> The signal timing of the computer is within the specification of the monitor. <input type="checkbox"/> If the monitor is in standby mode, touch the keyboard or the mouse. <input type="checkbox"/> The computer is ON. <input type="checkbox"/> The Signal Cable is properly connected. <input type="checkbox"/> The signal timing of the computer is within the specification of the monitor.
② The screen is not synchronized.	<input type="checkbox"/> The Signal Cable is properly connected. <input type="checkbox"/> The signal timing of the computer is within the specification of the monitor.
③ The screen position is not in the center.	<input type="checkbox"/> The signal timing of the computer is within the specification of the monitor.
④ The screen is too bright or too dark.	<input type="checkbox"/> The video output level of the computer is within the specification of the monitor.
⑤ The screen is shaking.	<input type="checkbox"/> The power voltage is within the specification of the monitor. <input type="checkbox"/> The signal timing of the computer is within the specification of the monitor.
⑥ No sound.	<input type="checkbox"/> The audio equipment (computer etc.) is ON. <input type="checkbox"/> The Volume is turned up. <input type="checkbox"/> The Mute is OFF. <input type="checkbox"/> The audio output level of the audio equipment is within the specification of the monitor.
⑦ The sound is too loud or too quiet.	<input type="checkbox"/> The audio output level of the audio equipment is within the specification of the monitor.

RECYCLING INFORMATION

For better environment protection please don't dispose your monitor.
Please visit our web site: <https://iiyama.com> for monitor recycling.

APPENDIX

Design and specifications are subject to change without prior notice.

SPECIFICATIONS : ProLite XUB3493WQSU-B5

Size Category	34"	
LCD Panel	Panel technology	IPS (In-Plane-Switching)
	Size	Diagonal: 34" (86.7cm)
	Pixel pitch	0.233mm H × 0.233mm V
	Brightness	400cd/m ² (Typical), 230cd/m ² (Default / Energy Saving)
	Contrast ratio	1000 : 1 (Typical), Adv. Contrast Function Available
	Viewable angle	Right / Left : 89 degrees each, Up / Down: 89 degrees each (Typical)
	Response time	4ms (Gray to Gray)
Display Colors	16,777,216	
Sync Frequency	HDMI (without FreeSync): Horizontal: 30.0-115.0kHz, Vertical: 55-75Hz HDMI (with FreeSync): Horizontal: 30.0-115.0kHz, Vertical: 48-75Hz DisplayPort (without FreeSync): Horizontal: 30.0-115.0kHz, Vertical: 55-75Hz DisplayPort (with FreeSync): Horizontal: 30.0-115.0kHz, Vertical: 48-75Hz	
Native Resolution	3440 × 1440, 4.9 MegaPixels	
Supported max. resolution	3440 × 1440, 75Hz	
Input Connector	HDMI × 2, DisplayPort	
Input Video Signal	HDMI, DisplayPort	
USB Standard	USB3.0 (DC5V, 900mA)	
Number of USB Ports	1 Upstream : Series B	
Connector shape	2 Downstream : Series A	
Headphone Connector	ø 3.5mm mini jack (Stereo)	
Speakers	5W × 2 (Stereo speakers)	
Maximum Screen Size	799.8mm W × 334.8mm H / 31.5" W × 13.2" H	
Power Source	100-240VAC, 50/60Hz, 1.2A	
Power Consumption*1	43W typical Standby mode: 0.5W maximum, Off mode: 0.3W maximum	
Dimensions*2 / Net Weight	817.0 × 422.5 - 572.5 × 245.5(239.5)mm / 32.2 × 16.6 - 22.5 × 9.7(9.4)" (W×H×D) 9.4kg / 20.7lbs	
Angle	Tilt: Upward: 23 degrees, Downward: 5 degrees Swivel: Left/Right: 45 degrees each	
Environmental Considerations	Operating: Temperature 5 to 35°C / 41 to 95°F Humidity 10 to 80% (No condensation) Storage: Temperature -20 to 60°C / -4 to 140°F Humidity 5 to 85% (No condensation)	
Approvals	CE, UKCA, TÜV-Bauart, VCCI, PSE, EAC	

NOTE

*1 When the USB devices are not connected.

*2 () : Depth of the Stand-Base

DIMENSIONS

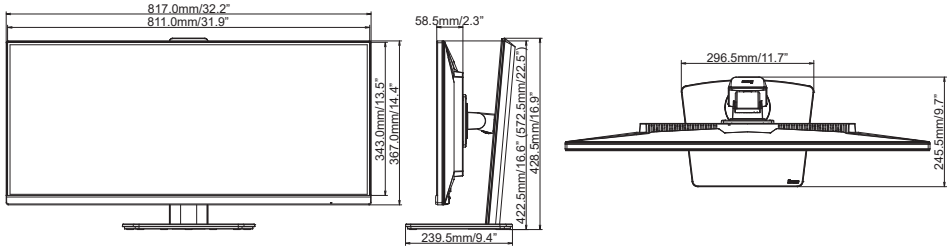

() : Maximum adjustment range

COMPLIANT TIMING

Video Mode	Horizontal Frequency	Vertical Frequency	Dot Clock
800 × 600	37.879kHz	60.317Hz	40.000MHz
	46.875kHz	75.000Hz	49.500MHz
1024 × 768	48.363kHz	60.004Hz	65.000MHz
	60.023kHz	75.029Hz	78.750MHz
1280 × 1024	63.981kHz	60.020Hz	108.000MHz
	79.976kHz	75.025Hz	135.000MHz
1680 × 1050	65.290kHz	60.000Hz	146.250MHz
1920 × 1080	66.590kHz	59.930Hz	138.500MHz
2560 × 1440	88.787kHz	59.951Hz	241.500MHz
3440 × 1440	88.800kHz	60.000Hz	319.800MHz
	113.030kHz	75.050Hz	438.540MHz
1720 × 1440	112.950kHz	75.000Hz	219.120MHz

NOTE *¹ The source graphic card must be capable of supporting 3440 × 1440 resolution at 60Hz / 75Hz.

*² The DisplayPort setting has to be enabled as 1.2.

*³ Recommended to use on PbP mode.