

使用说明书

技术参数

尺寸	/
材质	/
工艺	/
成型方式	/
特殊说明	

公差设定

		公差表 (此处为默认公差, 单独标注的公差范围除外) 单位: mm					
纸本类	尺寸范围	0-60	>60-100	>100-150	>150-200	>200-600	>600
	尺寸公差	±1.0	±1.5	±2.0	±2.5	±3	±4
	图文位置偏移公差	±2.0					±3

*此页非印刷&刻录页



广州视源电子科技股份有限公司
GUANGZHOU SHIYUAN ELECTRONIC CO.,LTD.

文件图号 CEXXWA-G05-T06305-V1.0 使用说明书-PHILIPS 适用于 CEXXWA

制作人 刘雅静 审核人 罗艳霞 批准人 /

变更履历：

版本	更新内容	日期	创建人
V1.0	第一版	2024-02-07	刘雅静

*此页非印刷&刻录页

PHILIPS

Collaboration Display

3000 Series

65BDL3152E

75BDL3152E

86BDL3152E



User Manual (English)

www.philips.com/welcome

Table Of Contents

1. Safety Instructions	1	6.1.1. Network & Internet	35
2. Unpacking and Installation.....	8	6.1.2. Signage Display.....	35
2.1. Unpacking	8	6.1.3. Security.....	41
2.2. Package Contents.....	10	6.1.4. System	41
2.3. Installation Notes	10	7. OSD Menu	42
2.4. Mounting on a Wall	11	7.1. Navigating the OSD Menu	42
2.4.1. VESA Grid	11	7.1.1. Navigating the OSD menu using the display's control buttons.....	42
3. Parts and Functions	12	7.2. OSD Menu Overview	42
3.1. Control Panel.....	12	7.2.1. Picture menu	42
3.2. Input/Output Terminals.....	13	7.2.2. Screen menu	42
3.3. Inserting the batteries in the remote control	14	7.2.3. Audio menu	43
3.4. Handling the remote control.....	14	7.2.4. Configuration menu	43
3.5. Operating range of the remote control	14	7.2.5. Advanced Option menu.....	44
3.6. Remote Control.....	15	7.3. Android Settings.....	45
3.6.1. General functions.....	15	7.4. ANNOTATION	45
4. Connecting External Equipment	16	7.5. Whiteboard	45
4.1. Connecting External Equipment (Multimedia Player)	16	7.5.1. Main page	45
4.1.1. Using HDMI video input.....	16	7.5.2. WHITEBOARD MENU.....	45
4.2. Connecting a PC.....	16	7.5.3. WRITING	46
4.2.1. Using DVI input.....	16	7.5.4. ERASING	46
4.2.2. Using HDMI input	16	7.5.5. SELECT	46
4.3. Connecting Audio Equipment.....	17	7.5.6. PAGE MANAGEMENT	47
4.3.1. Connecting an external audio device.....	17	7.5.7. INSERTING DOCUMENTS.....	47
4.4. Touch Operation.....	17	7.5.8. NAVIGATION MAP.....	47
5. Operation	20	7.5.9. SAVE & TAKE AWAY VIA QR CODE CODE.....	47
5.1. Watch the Connected Video Source.....	20	7.5.10. MIND MAP.....	47
5.2. Launcher	20	7.5.11. SMART TABLE.....	48
5.3. Media Player	20	7.5.12. SMALL TOOLS.....	48
5.3.1. OSD menu interaction with media player:.....	20	8. Supported Media Formats.....	49
5.3.2. Media Player introduction:	20	9. Input Mode	50
5.4. Browser	24	10. Pixel Defect Policy	51
5.4.1. Brower introduction:	24	10.1. Pixels and Sub-Pixels.....	51
5.5. PDF Player	27	10.2. Types of Pixel Defects + Dot Definition.....	51
5.5.1. OSD menu interaction with PDF player:.....	27	10.3. Bright Dot Defects.....	51
5.5.2. PDF Player introduction:	28	10.4. Dark Dot Defects	52
5.6. Kiosk	30	10.5. Proximity of Pixel Defects	52
5.6.1. Kiosk interaction	30	10.6. Pixel Defect Tolerances.....	52
5.7. Floating Bar	34	10.7. MURA.....	52
6. Setting UI.....	35	11. Cleaning and Troubleshooting	53
6.1. Settings.....	35	11.1. Cleaning	53
		11.2. Troubleshooting	54
		12. Technical Specifications.....	55
		Warranty policy for Philips Professional Display Solutions.....	57
		Index.....	59

1. Safety Instructions

Safety precautions and maintenance



WARNING: Use of controls, adjustments or procedures other than those specified in this documentation may result in exposure to shock, electrical hazards and/or mechanical hazards.

Read and follow these instructions when connecting and using your display:

Operation:

- Keep the display out of direct sunlight and away from stoves or any other heat sources.
- Keep the display away from oil, otherwise the plastic cover may be damaged.
- It is recommended to set the display up in the well-ventilated place.
- If the product will be used in extreme conditions such as high temperature, humidity, display patterns or operation time etc... It is strongly recommended to contact Philips for Application engineering advice. Otherwise, its reliability and function may not be guaranteed. Extreme conditions are commonly found at Airports, Transit Stations, Banks, Stock market, and Controlling systems.
- Remove any object that could fall into ventilation holes or prevent proper cooling of the display's electronics.
- Do not block the ventilation holes on the cabinet.
- When positioning the display, make sure the power plug and outlet are easily accessible.
- When turning off the display by detaching the power cord, wait 6 seconds before re-attaching the power cord for normal operation.
- Ensure the use of an approved power cord provided by Philips at all times. If your power cord is missing, please contact your local service center.
- Do not subject the display to severe vibration or high impact conditions during operation.
- Do not knock or drop the display during operation or transportation.

Maintenance:

- To protect your display from possible damage, do not put excessive pressure on the LCD panel. When moving your display, grasp the frame to lift; do not lift the display by placing your hand or fingers on the LCD panel.
- Unplug the display if you are not going to use it for an extensive period of time.
- Unplug the display if you need to clean it with a slightly damp cloth. The screen may be wiped with a dry cloth when the power is off. However, never use organic solvent, such as, alcohol, or ammonia-based liquids to clean your display.
- To avoid the risk of shock or permanent damage to the set, do not expose the display to dust, rain, water or an excessively moist environment.
- If your display becomes wet, wipe it with dry cloth as soon as possible.
- If a foreign substance or water gets in your display, turn the power off immediately and disconnect the power cord. Then remove the foreign substance or water, and send the unit to the maintenance center.
- Do not store or use the display in locations exposed to heat, direct sunlight or extreme cold.
- In order to maintain the best performance of your display and ensure a longer lifetime, we strongly recommend using the display in a location that falls within the following temperature and humidity ranges.

Environmental absolute ratings

Item	Min.	Max.	Unit
Storage temperature	-20	60	°C
Operation temperature	0	40	°C
Glass Surface temperature (Operation)	0	65	°C
Storage humidity	10	90	% RH
Operating humidity	10	90	% RH

- LCD panel temperature need to be 25 degrees Celsius at all time for better luminance performance.

- Only the lifetime of the display stated in this specification is guaranteed if the display is used under the proper operation conditions.

IMPORTANT: Always activate a moving screen saver program when you leave your display unattended. Always activate a periodic screen refresh application if the unit will display unchanging static content. Uninterrupted display of still or static images over an extended period may cause “burn in”, also known as “after-imaging” or “ghost imaging”, on your screen. This is a well-known phenomenon in LCD panel technology. In most cases, the “burned in” or “after-imaging” or “ghost imaging” will disappear gradually over a period of time after the power has been switched off.

WARNING: Severe “burn-in” or “after-image” or “ghost image” symptoms will not disappear and cannot be repaired. This is also not covered under the terms of your warranty.

Service:

- The casing cover should be opened only by qualified service personnel.
- If there is any need for repair or integration, please contact your local service center.
- Do not leave your display under direct sunlight.



If your display does not operate normally, having followed the instructions set out in this document, please contact a technician or your local service center.

Stability Hazard.

The device may fall, causing serious personal injury or death. To prevent injury, this device must be securely attached to the floor/wall in accordance with the installation instructions.

Read and follow these instructions when connecting and using your display:



- Unplug the display if you are not going to use it for an extensive period of time.
- Unplug the display if you need to clean it with a slightly damp cloth. The screen may be wiped with a dry cloth when the power is off. However, never use alcohol, solvents or ammonia-based liquids.
- Consult a service technician if the display does not operate normally when you have followed the instructions in this manual.
- The casing cover should be opened only by qualified service personnel.
- Keep the display out of direct sunlight and away from stoves or any other heat sources.
- Remove any object that could fall into the vents or prevent proper cooling of the display’s electronics.
- Do not block the ventilation holes on the cabinet.
- Keep the display dry. To avoid electric shock, do not expose it to rain or excessive moisture.
- When turning off the display by detaching the power cable or DC power cord, wait for 6 seconds before re-attaching the power cable or DC power cord for normal operation..
- To avoid the risk of shock or permanent damage to the set do not expose the display to rain or excessive moisture.
- When positioning the display, make sure the power plug and outlet are easily accessible.
- **IMPORTANT:** Always activate a screen saver program during your application. If a still image in high contrast remains on the screen for an extended period of time, it may leave an ‘after-image’ or ‘ghost image’ on the front of the screen. This is a well-known phenomenon that is caused by the shortcomings inherent in LCD technology. In most cases the afterimage will disappear gradually over a period of time after the power has been switched off. Be aware that the after-image symptom cannot be repaired and is not covered under warranty.
- If provided with a 3-pin attachment plug on the power cord, plug the cord into a grounded (earthed) 3-pin outlet. Do not disable the power cord grounding pin, for example, by attaching a 2-pin adapter. The grounding pin is an important safety feature.

EU Declaration of Conformity

This device complies with the requirements set out in the Council Directive on the Approximation of the Laws of the Member States relating to Electromagnetic Compatibility (2014/30/EU), Low-voltage Directive (2014/35/EU), RoHS directive (2011/65/EU), ErP directive (2009/125/EC).

This product has been tested and found to comply with the harmonized standards for Information Technology Equipment, these harmonized standards published under Directives of Official Journal of the European Union.

ESD Warnings

When user close to the monitor may cause the equipment discharge and reboot to the display of main menu.

Federal Communications Commission (FCC) Notice (U.S. Only)



Note: This equipment has been tested and found to comply with the limits for a Class B digital device, pursuant to part 15 of the FCC Rules. These limits are designed to provide reasonable protection against harmful interference in a residential installation. This equipment generates, uses and can radiate radio frequency energy and, if not installed and used in accordance with the instructions, may cause harmful interference to radio communications. However, there is no guarantee that interference will not occur in a particular installation. If this equipment does cause harmful interference to radio or television reception, which can be determined by turning the equipment off and on, the user is encouraged to try to correct the interference by one or more of the following measures:

- Reorient or relocate the receiving antenna.
- Increase the separation between the equipment and receiver.
- Connect the equipment into an outlet on a circuit different from that to which the receiver is connected.
- Consult the dealer or an experienced radio/TV technician for help.



Changes or modifications not expressly approved by the party responsible for compliance could void the user's authority to operate the equipment.

Use only an RF shielded cable that was supplied with the display when connecting this display to a computer device.

To prevent damage which may result in fire or shock hazard, do not expose this appliance to rain or excessive moisture.

This device complies with Part 15 of the FCC Rules. Operation is subject to the following two conditions: (1) This device may not cause harmful interference, and (2) this device must accept any interference received, including interference that may cause undesired operation.

Envision Peripherals Inc.
490 N McCarthy Blvd, Suite #120
Milpitas, CA 95035
USA

Polish Center for Testing and Certification Notice

The equipment should draw power from a socket with an attached protection circuit (a three-prong socket). All equipment that works together (computer, display, printer, and so on) should have the same power supply source.

The phasing conductor of the room's electrical installation should have a reserve short-circuit protection device in the form of a fuse with a nominal value no larger than 16 amperes (A).

To completely switch off the equipment, the power supply cable must be removed from the power supply socket, which should be located near the equipment and easily accessible.

A protection mark "B" confirms that the equipment is in compliance with the protection usage requirements of standards PN-93/T-42107 and PN-89/E-06251.

Wymagania Polskiego Centrum Badań i Certyfikacji

Urządzenie powinno być zasilane z gniazda z przyłączonym obwodem ochronnym (gniazdo z kolkiem). Współpracujące ze sobą urządzenia (komputer, monitor, drukarka) powinny być zasilane z tego samego źródła.

Instalacja elektryczna pomieszczenia powinna zawierać w przewodzie fazowym rezerwową ochronę przed zwarciami, w postaci bezpiecznika o wartości znamionowej nie większej niż 16A (amperów).

W celu całkowitego wyłączenia urządzenia z sieci zasilania, należy wyjąć wtyczkę kabla zasilającego z gniazdka, które powinno znajdować się w pobliżu urządzenia i być łatwo dostępne.

Znak bezpieczeństwa "B" potwierdza zgodność urządzenia z wymaganiami bezpieczeństwa użytkownika zawartymi w PN-93/T-42107 i PN-89/E-06251.

Pozostałe instrukcje bezpieczeństwa

- Nie należy używać wtyczek adapterowych lub usuwać kolka obwodu ochronnego z wtyczki. Jeżeli konieczne jest użycie przedłużacza to należy użyć przedłużacza 3-żyłowego z prawidłowo połączonym przewodem ochronnym.
- System komputerowy należy zabezpieczyć przed nagłymi, chwilowymi wzrostami lub spadkami napięcia, używając eliminatora przepięć, urządzenia dopasowującego lub bezzakłóceńowego źródła zasilania.
- Należy upewnić się, aby nic nie leżało na kablach systemu komputerowego, oraz aby kable nie były umieszczone w miejscu, gdzie można byłoby na nie nadeptywać lub potykać się o nie.
- Nie należy rozlewać napojów ani innych płynów na system komputerowy.
- Nie należy wpychać żadnych przedmiotów do otworów systemu komputerowego, gdyż może to spowodować pożar lub porażenie prądem, poprzez zwarcie elementów wewnętrznych.
- System komputerowy powinien znajdować się z dala od grzejników i źródeł ciepła. Ponadto, nie należy blokować otworów wentylacyjnych. Należy unikać kładzenia luźnych papierów pod komputer oraz umieszczania komputera w ciasnym miejscu bez możliwości cyrkulacji powietrza wokół niego.

Information for U.K. only

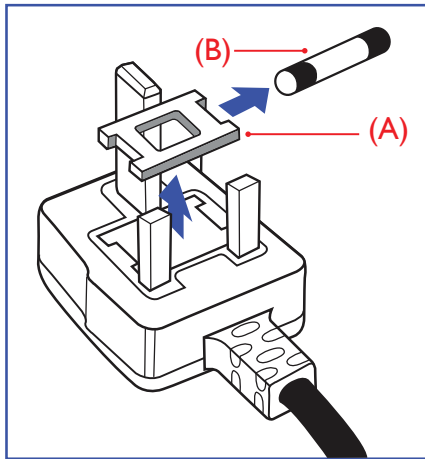

WARNING - THIS APPLIANCE MUST BE EARTHED.

Important:

This apparatus is supplied with an approved moulded 13A plug. To change a fuse in this type of plug proceed as follows:+

1. Remove fuse cover and fuse.
2. Fit new fuse which should be a BS 1362 5A, A.S.T.A. or BSI approved type.
3. Refit the fuse cover.

If the fitted plug is not suitable for your socket outlets, it should be cut off and an appropriate 3-pin plug fitted in its place.

If the mains plug contains a fuse, this should have a value of 5A. If a plug without a fuse is used, the fuse at the distribution board should not be greater than 5A.

NOTE: The severed plug must be destroyed to avoid a possible shock hazard should it be inserted into a 13A socket elsewhere.

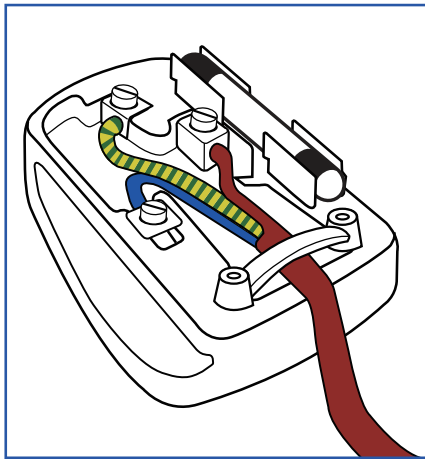

How to connect a plug

The wires in the mains lead are coloured in accordance with the following code:

BLUE - "NEUTRAL" ("N")

BROWN - "LIVE" ("L")

GREEN & YELLOW - "EARTH" ("E")

1. The GREEN & YELLOW wire must be connected to the terminal in the plug which is marked with the letter "E" or by the Earth symbol or coloured GREEN or GREEN & YELLOW.
2. The BLUE wire must be connected to the terminal which is marked with the letter "N" or coloured BLACK.
3. The BROWN wire must be connected to the terminal which marked with the letter "L" or coloured RED.

Before replacing the plug cover, make certain that the cord grip is clamped over the sheath of the lead - not simply over the three wires.

North Europe (Nordic Countries) Information

Placering/Ventilation

VARNING:

FÖRSÄKRA DIG OM ATT HUVUDBRYTARE OCH UTTAG ÄR LÄTÅTKOMLIGA, NÄR DU STÄLLER DIN UTRUSTNING PÅPLATS.

Placering/Ventilation

ADVARSEL:

SØRG VED PLACERINGSFOR, AT NETLEDNINGENS STIK OG STIKKONTAKT ER NEMT TILGÆNGLIGE.

Paikka/Ilmankierto

VAROITUS:

SIIJOITA LAITE SITEN, ETTÄ VERKKOJOHTO VOIDAAN TARVITTAESSA HELPOSTI IRROTTAA PISTORASIESTA.

Plassering/Ventilasjon

ADVARSEL:

NÅR DETTE UTSTYRET PLASSERES, MÅ DU PASSE PÅ AT KONTAKTENE FOR STØMTILFØRSEL ER LETTE Å NÅ.

Waste Electrical and Electronic Equipment-WEEE

Attention users in European Union private households



This marking on the product or on its packaging illustrates that, under European Directive 2012/19/EU governing used electrical and electronic appliances, this product may not be disposed of with normal household waste. You are responsible for disposal of this equipment through a designated waste electrical and electronic equipment collection. To determine the locations for dropping off such waste electrical and electronic, contact your local government office, the waste disposal organization that serves your household or the store at which you purchased the product.

Attention users in United States:

Please dispose of according to all Local, State and Federal Laws. For the disposal or recycling information, contact: www.mygreenelectronics.com or www.eiae.org.

End of Life Directives-Recycling



Your new Public Information Display contains several materials that can be recycled for new users.

Please dispose of according to all Local, State, and Federal laws.

65BDL3152E/75BDL3152E/86BDL3152E:



ENERGY STAR is a program run by the U.S. Environmental Protection Agency (EPA) and U.S. Department of Energy (DOE) that promotes energy efficiency.

This product qualifies for ENERGY STAR in the "factory default" settings and this is the setting in which power savings will be achieved.

Changing the factory default picture settings or enabling other features will increase power consumption that could exceed the limits necessary to qualify for ENERGY STAR rating.

For more information on the ENERGY STAR program, refer to energystar.gov.

Restriction on Hazardous Substances statement (India)

This product complies with the "E-Waste (Management) Rules, 2016" CHAPTER V, rule 16, sub-rule (1) . Whereas New Electrical and Electronic Equipment and their components or consumables or parts or spares do not contain Lead, Mercury, Cadmium, Hexavalent Chromium, polybrominated biphenyls and polybrominated diphenyl ethers beyond a maximum concentration value of 0.1% by weight in homogenous materials for lead, mercury, hexavalent chromium, polybrominated biphenyls and polybrominated diphenyl ethers and of 0.01% by weight in homogenous materials for cadmium. except of exemptions set in Schedule 2 of the Rule.

E-Waste Declaration for India

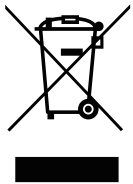

This symbol on the product or on its packaging indicates that this product must not be disposed of with your other household waste. Instead it is your responsibility to dispose of your waste equipment by handing it over to a designated collection point for the recycling of waste electrical and electronic equipment . The separate collection and recycling of your waste equipment at the time of disposal will help to conserve natural resources and ensure that it is recycled in a manner that protects human health and the environment. For more information about E -waste please visit <http://www.india.philips.com/about/sustainability/recycling/index.page> and to know where you can drop off your waste equipment for recycling in India please contact on below given contact details.

Helpline number: 1800-425-6396 (Monday to Saturday, 9 a.m. to 5:30 pm)

E-mail: india.callcentre@tpv-tech.com



NOTICE:

The terms HDMI, HDMI High-Definition Multimedia Interface, HDMI Trade Dress and the HDMI Logos are trademarks or registered trademarks of HDMI Licensing Administrator, Inc.

Batteries



For EU: The crossed-out wheeled bin implies that used batteries should not be put to the general household waste! There is a separate collection system for used batteries, to allow proper treatment and recycling in accordance with legislation.

Please contact your local authority for details on the collection and recycling schemes.

For Switzerland: The used battery is to be returned to the selling point.

For other non-EU countries: Please contact your local authority for correct method of disposal of the used battery.

According to EU Regulation (EU) 2023/1542, the battery can't be disposed improperly. The battery shall be separated to collect by local service.

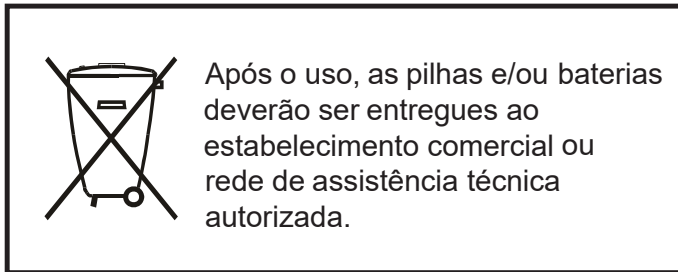

警語：使用過度恐傷害視力。

注意事項：

- (1) 使用30分鐘請休息10分鐘。
- (2) 未滿2歲幼兒不看螢幕，2歲以上每天看螢幕不要超過1小時。

Turkey RoHS:

Türkiye Cumhuriyeti: EEE Yönetmeliğine Uygundur

Ukraine RoHS:

Обладнання відповідає вимогам Технічного регламенту щодо обмеження використання деяких небезпечних речовин в електричному та електронному обладнанні, затвердженого постановою Кабінету Міністрів України від 3 грудня 2008 № 1057

End-of-Life Disposal

Your new Public Information Display contains materials that can be recycled and reused. Specialized companies can recycle your product to increase the amount of reusable materials and to minimize the amount to be disposed of.

Please find out about the local regulations on how to dispose of your old display from your local Philips dealer.

(For customers in Canada and U.S.A.)

This product may contain lead and/or mercury. Dispose of in accordance to local-state and federal regulations. For additional information on recycling contact www.eia.org (Consumer Education Initiative)

Where a plug on the power supply cord is used as the disconnect device.

2. Unpacking and Installation

2.1. Unpacking

- This product is packed in a carton, together with the standard accessories.
- Any other optional accessories will be packed separately.
- As this product is high and heavy, the operation of moving the device is recommended to be performed by two technicians.
- After opening the carton, ensure that the contents is complete and in good condition.

■ Before Unpacking

- Please read and fully understand unpacking notice before installation.
- Please check the packing, there should be no any abnormality such as creak, dent mark...etc.
- Please do necessary inspection before you move the display out of the carton.
- Always install the display by experienced technician to prevent any damage.

■ Notice

- Take the display out of the carton box by two or four adults with both hands.
- Please hold on handles.

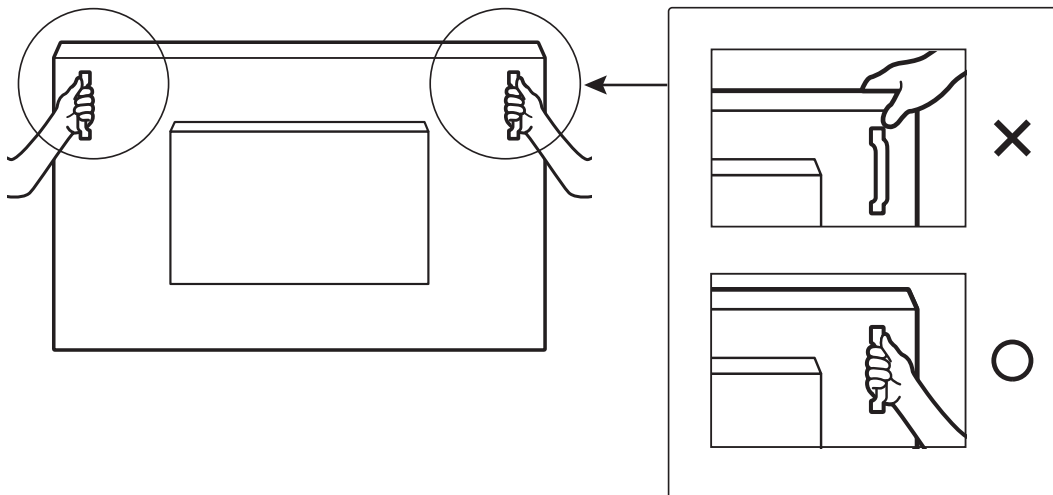

- Please keep the display vertically when moving it.

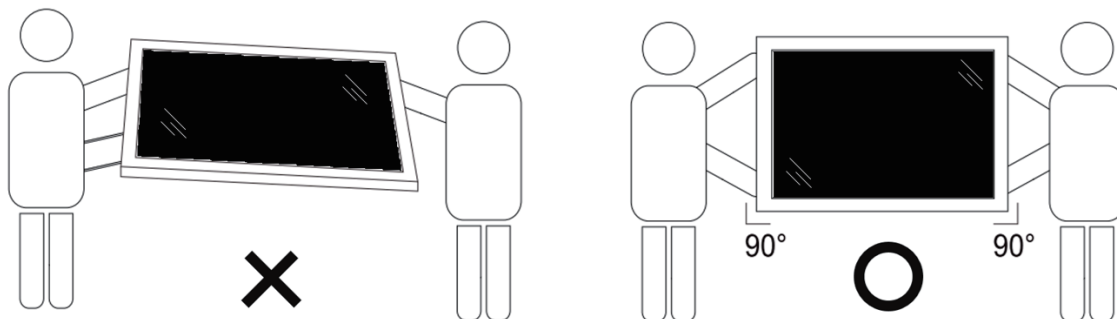

- Place the display vertically and its weight should spread evenly on the surface.

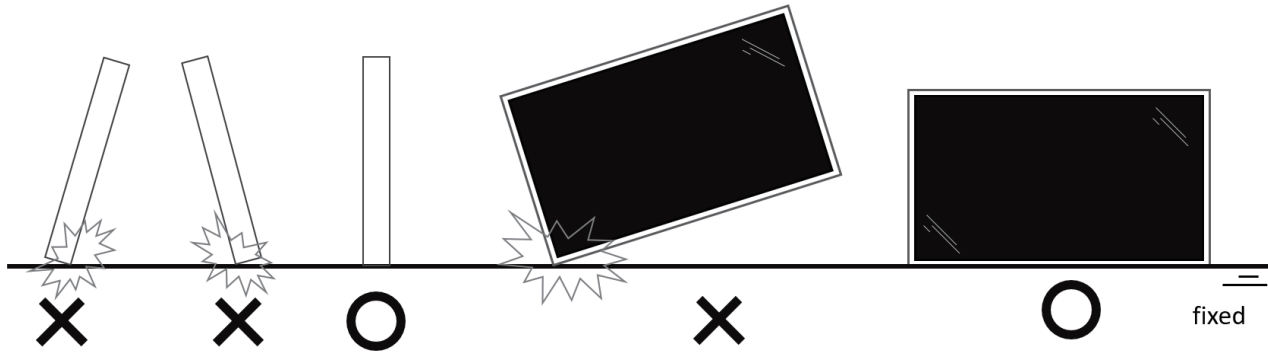

- Please keep vertically, no bending and torsion during moving the display.

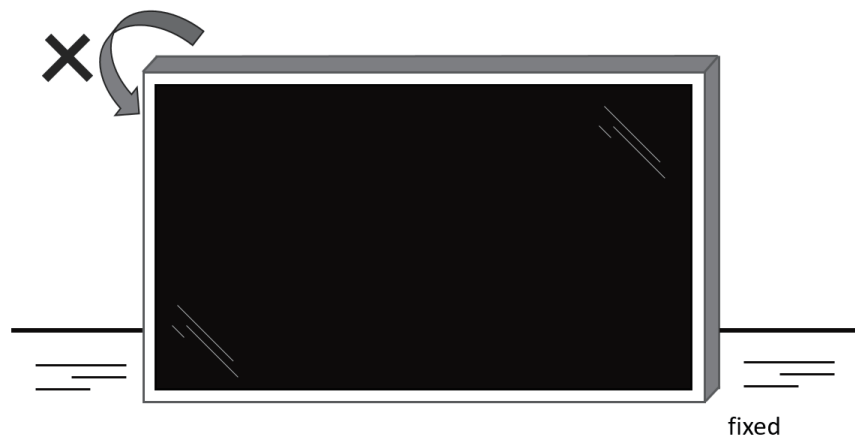

2.2. Package Contents

Please verify that you received the following items with your package content:

- LCD Display
- Quick start guide
- Remote Control and AAA batteries x 2 PCS
- Power cables x 3 PCS
- Wall Mount
- Touch pen
- Touch Usb Cable
- WiFi Module

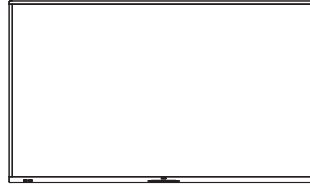

LCD display

* The supplied power cord varies depending on destination.



Remote Control and AAA Batteries



Quick start guide



Power Cord

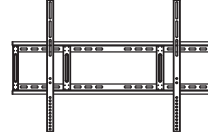

Wall Mount



Touch pen

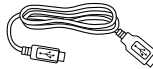

Touch Usb Cable



WiFi Module

* Items may differ in different locations

* Display design and accessories may differ from the images shown.

NOTES:

- For all other regions, apply a power cord that conforms to the AC voltage of the power socket and has been approved by and complies with the safety regulations of the particular country (Type H05W-F, 2G or 3G, 0.75 or 1 mm² should be used).
- Keep the packaging materials appropriately after unpacking the product.

2.3. Installation Notes

- Only use the power cable provided with this product. If an extension cord is required, please consult your service agent.
- The product should be installed on a flat surface, or the product may tip over. Leave a space between the rear of the product and the wall for proper ventilation. Do not install the product in a kitchen, bathroom or a place exposed to moisture, failure to do so may shorten the life of the internal parts.
- Do not install the product where it is 3000m and higher in altitude. Failure to do so may result in malfunctions.

2.4. Mounting on a Wall

To mount this display on a wall, a standard wall-mounting kit (commercially available) is required. It is recommended that you use a mounting interface that complied with TUV-GS and /or UL1678 standard in North America.

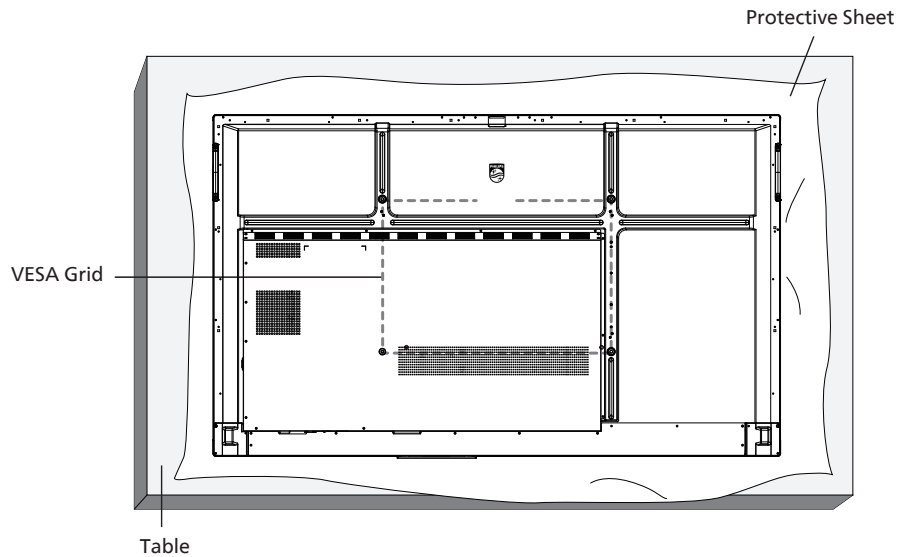

1. Prepare a flat and horizontal surface that is larger than the display and spread a thick protective sheet on it to facilitate your operation without scratching the screen.
2. Ensure you have all accessories for all types of mounting (wall mount, ceiling mount, table stand, etc).
3. Follow the instructions that came with the base mounting kit. Failure to follow the correct mounting procedures could result in damage to the equipment, or injury to the user or installer. The product warranty does not cover the damage caused by improper installation.
4. For the wall-mounting kit, use the M8 mounting screws (with a length 15 mm longer than the thickness of the mounting bracket) and tighten them securely.

2.4.1. VESA Grid

65BDL3152E	600(H) x 400(V) /M8
75BDL3152E	800(H) x 400(V) /M8
86BDL3152E	800(H) x 600(V) /M8

Caution:

To prevent the display from falling:

- For wall or ceiling mounting, we recommend that you install the display with metal brackets which are commercially available. For detailed instructions about the installation, refer to the guide provided with the bracket.
- To prevent the display from falling in case of earthquake or other natural disaster, please consult the manufacturer of the bracket for the mounting location.
- As this product is high and heavy, the installation of this product is recommended to be performed by four technicians.

Required space for ventilation

Leave a space of 100 mm at the top, rear, right and left of the display for ventilation.

Note: We recommend you contact a professional technician when installing the display on a wall. We are not responsible for any damage to the product if the installation is not performed by a professional technician.

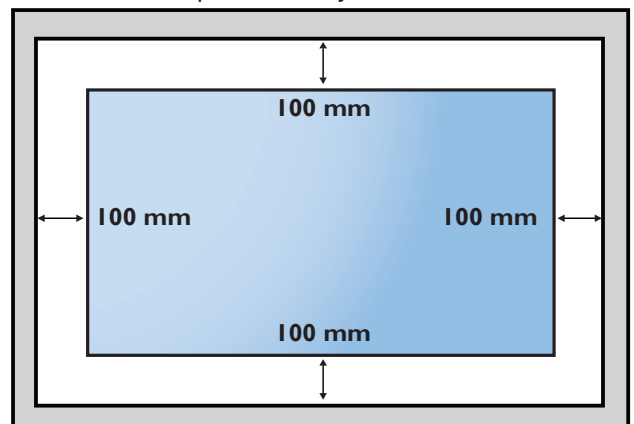

3. Parts and Functions

3.1. Control Panel

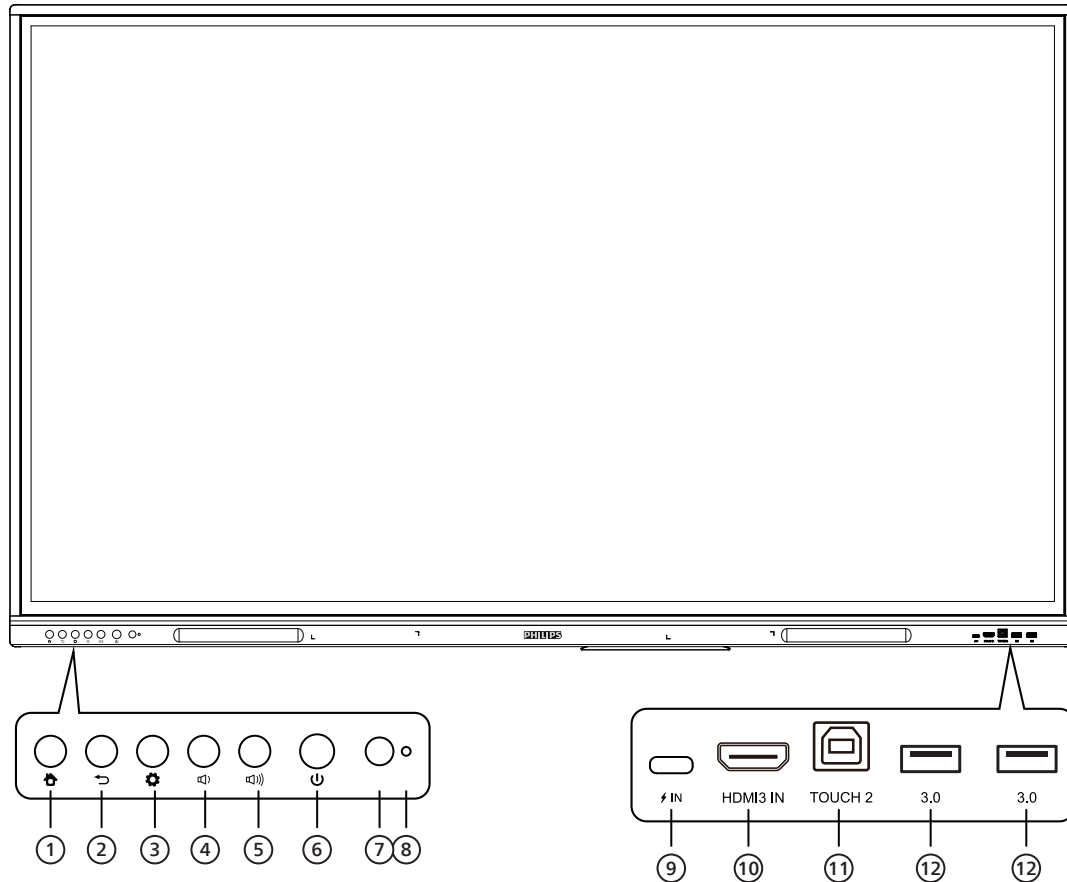

- ① HOME button
Back to the main interface.
- ② BACK button
Return to the previous page, or exit the current app.
- ③ Menu button
Call up [General Setting] menu.
- ④ Volume down button
Turn down the volume.
- ⑤ Volume up button
Turn up the volume.
- ⑥ Power button
Tap to enter energy saving function; press for at least 2 seconds to enter standby mode.
- ⑦ Remote control signal receiver
Receive remote control signal.
- ⑧ Light sensor
Ambient light to adjust backlight for appropriate brightness It can be switched on or off in the menu.
- ⑨ ⚡ IN
USB Type C: Support charging, data transmission, extension for audio and video output interface, etc.
Note: The maximum rated power of the USB Type-C port for this product is 65W. When using this port to charge electronic devices, the charging power of the electronic device cannot exceed the rated power of this port. If the charging power of the electronic device exceeds the rated charging power of this port, please refrain from directly using this port for charging.
- ⑩ HDMI IN
High-definition multimedia interface signal input, for connecting to devices with HDMI output interface (personal computer with HDMI output, set-top box, or other video device).
- ⑪ TOUCH
Touch signal output to the external computer.
- ⑫ 3.0
Connect USB devices such as mobile hard disk, U disk, USB keyboard, mouse, USB drives, etc.

3.2. Input/Output Terminals

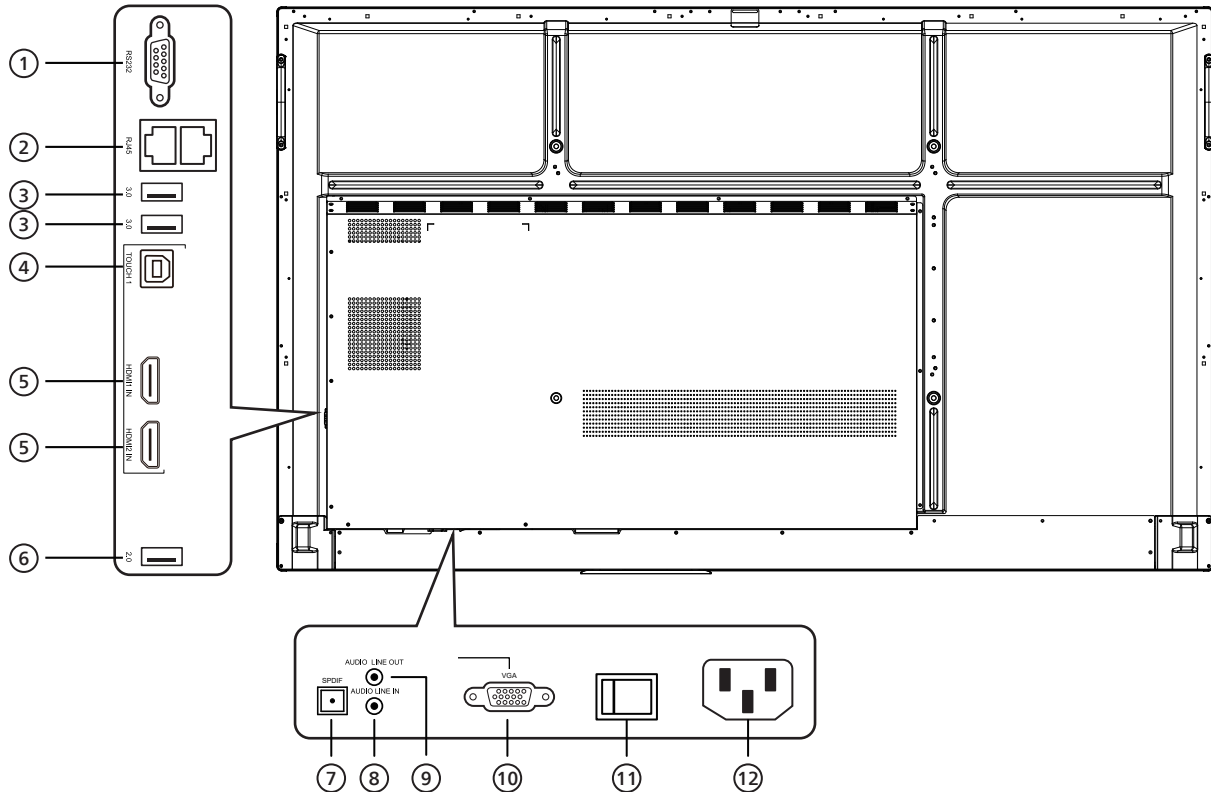

- ① RS232
Serial interface, used for mutual transfer of data between devices.
- ② RJ45
Wired network interface, for connecting to Ethernet
- ③ 3.0
Connect USB devices such as mobile hard disk, U disk, USB keyboard, mouse, USB drives, etc.
- ④ TOUCH
Touch signal output to the external computer.
- ⑤ HDMI IN
High-definition multimedia interface signal input, for connecting to devices with HDMI output interface (personal computer with HDMI output, set-top box, or other video device).
- ⑥ 2.0
Connect USB devices such as mobile hard disk, U disk, USB keyboard, mouse, USB drives, etc.
- ⑦ SPDIF
Carry multichannel sound via optical signals.
- ⑧ AUDIO LINE IN
Input for external audio sources (typically used as the sound input for the VGA interface).
- ⑨ AUDIO LINE OUT
Audio output to the external speaker.
- ⑩ VGA
External input for computer image.
- ⑪ AC SWITCH
To open or shut down AC power supply. "I" means power on, "O" means power off.
- ⑫ AC IN
Input for AC power supply.

3.3. Inserting the batteries in the remote control

The remote control is powered by two 1.5V AAA batteries.

To install or replace the batteries:

1. Press and then slide the cover to open it.
2. Insert the batteries with the correct polarity (+) and (-).
3. Replace the cover.

Caution:

Incorrect use of batteries may cause leakage or explosion. Be sure to follow the instructions below:

- Insert "AAA" batteries with the correct polarity (+ and -).
- Do not mix battery types.
- Do not use a new battery with a used one together. Otherwise, it may cause leakage or shorten the life of the batteries.
- Remove the dead batteries immediately to avoid battery leakage in the battery compartment. Do not touch exposed battery acid, as it may cause injury to your skin.
- Disposal of a battery into fire or a hot oven, or mechanically crushing or cutting of a battery, that can result in an explosion; leaving a battery in an extremely high temperature surrounding environment that can result in an explosion or the leakage of flammable liquid or gas; and a battery subjected to extremely low air pressure that may result in an explosion or the leakage of flammable liquid or gas.

Note: Remove the batteries from the battery compartment when not using for an extended period of time.

3.4. Handling the remote control

- Do not drop or apply shock to the remote control.
- Do not allow any liquid to get inside the remote control. If water has entered the remote control, wipe the remote control with a dry cloth immediately.
- Do not place the remote control near heat and steam sources.
- Do not attempt to disassemble the remote control, unless you need to place batteries in the remote control.

3.5. Operating range of the remote control

Point the top front of the remote control at the remote sensor on the display when you press the buttons.

Use the remote control within a distance of less than 4m/16ft from the display's sensor, and a horizontal and vertical angle of less than 20°.

Note: The remote control may not function properly when the remote control sensor on the display is under direct sunlight or strong illumination, or when there is an object between the remote control and the remote sensor of the display.

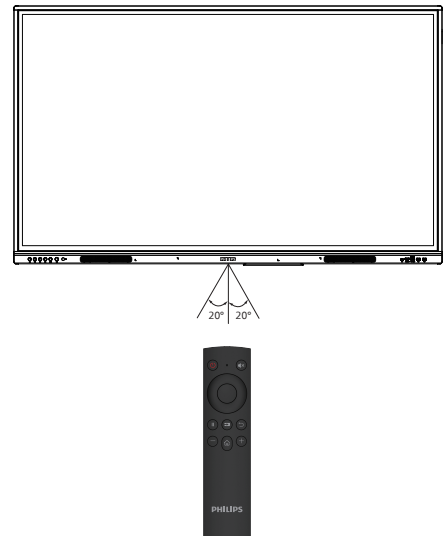

3.6. Remote Control

3.6.1. General functions

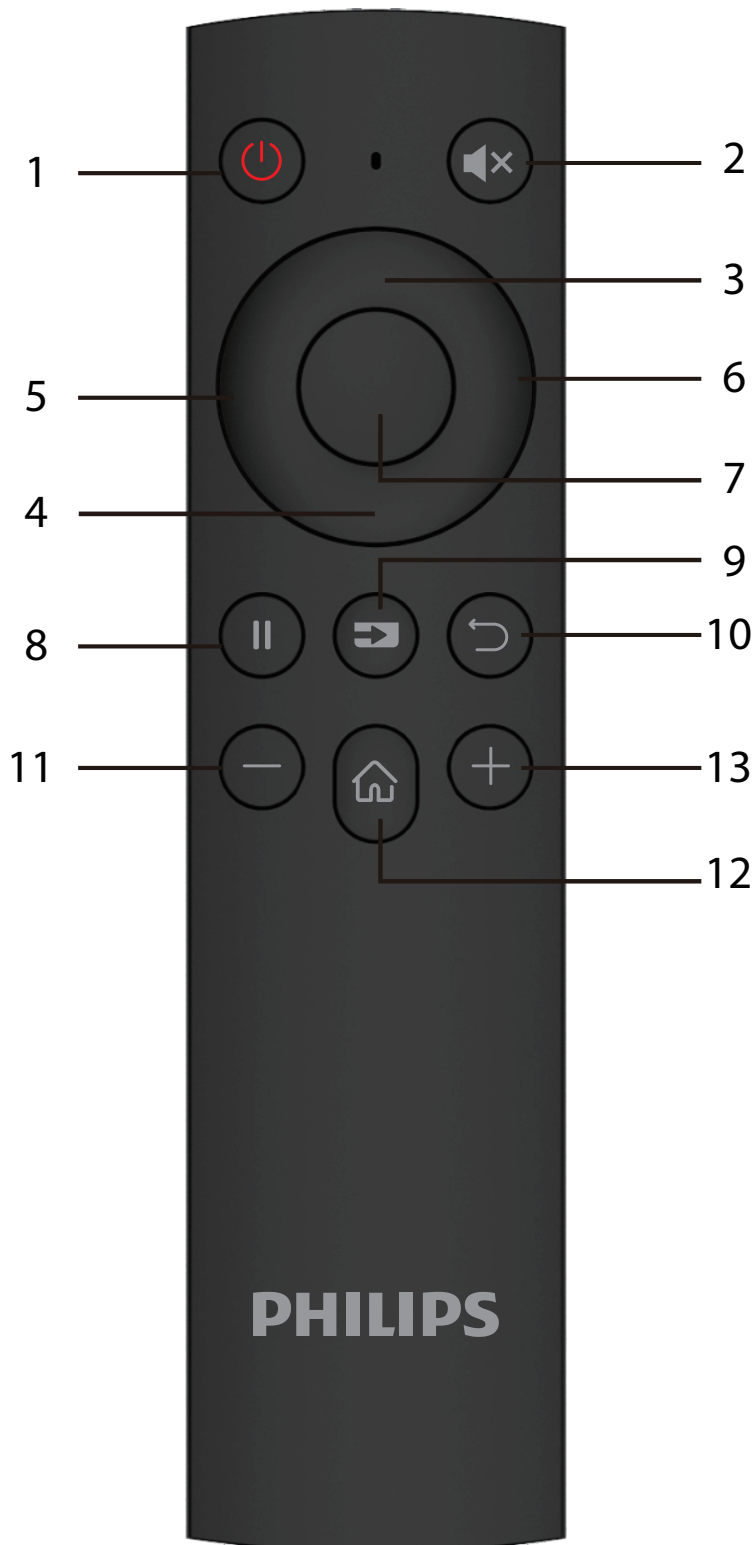

- ① **POWER button**
Power on/off.
- ② **[🔊] MUTE button**
Mute or unmute the sound.
- ③ **UP button**
Press this button for upward selection.
- ④ **DOWN button**
Press this button for downward selection.
- ⑤ **LEFT button**
Press this button for left selection.
- ⑥ **RIGHT button**
Press this button for right selection.
- ⑦ **ENTER button**
Confirm selection state.
- ⑧ **[⏸] FREEZE button**
Freeze the screen.
- ⑨ **[📺] SOURCE button**
Open input source menu.
- ⑩ **[↶] BACK button**
Return to previous page, or exit current app.
- ⑪ **[—] REDUCE button**
Reduce the volume.
- ⑫ **[🏠] HOME button**
Return to Android home page.
- ⑬ **[+] INCREASE button**
Increase the volume.

4. Connecting External Equipment

4.1. Connecting External Equipment (Multimedia Player)

4.1.1. Using HDMI video input

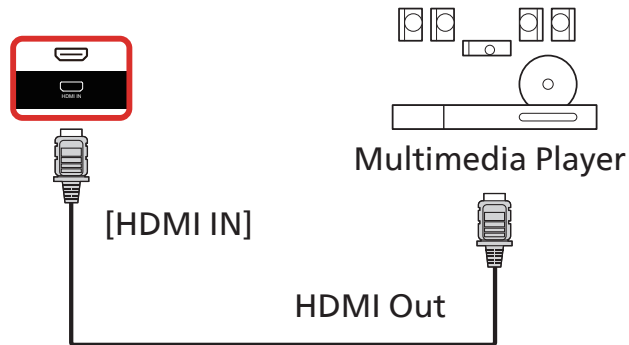

4.2. Connecting a PC

4.2.1. Using HDMI input with USB-B (touch connector to pc)

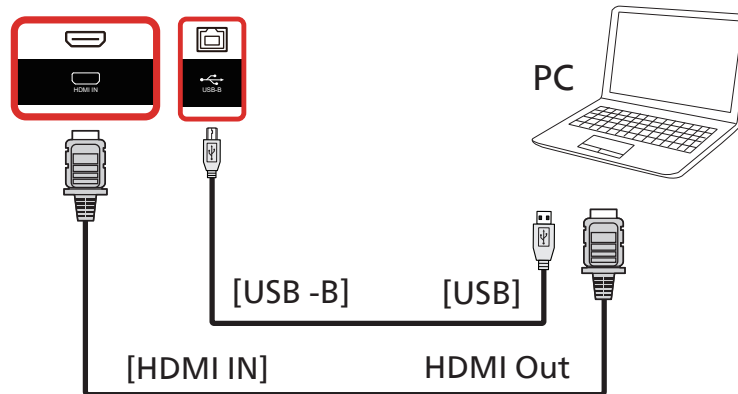

4.2.2. Using VGA

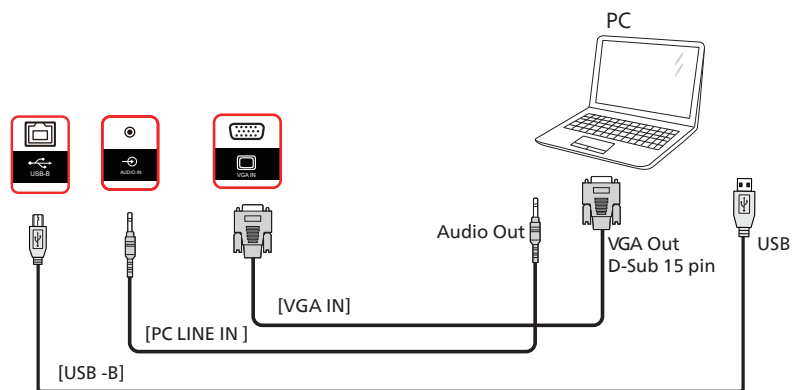

4.3. Connecting Audio Equipment

4.3.1. Connecting an external audio device

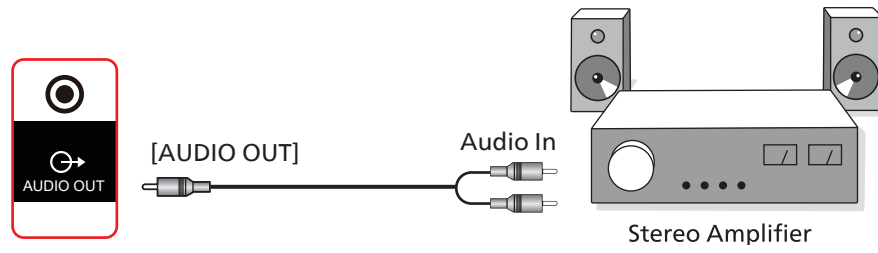

4.4. Touch Operation

This display is equipped with a touch-sensitive screen and supports the Windows Touch features either by single touch or multi-touch operation. You can touch the pictures or text on the display gently with your fingers, and the system will react.

This section explains about the touch operation on the display. For further detail on how to run the touch operation, please refer to the Windows operation instruction.

Single Tap

Touch the target on the screen with one fingertip for one quick tap, then release.

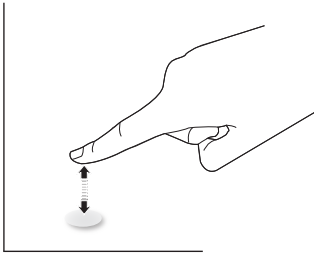

Please note that a touch screen will respond to a light touch from your fingertip when tapping on touch screen.

Double Tap

Touch the target on the screen with one fingertip for two quick taps, then release.



Pan

Touch the target on the screen with one fingertip and move across the target without losing direct contact, then release.

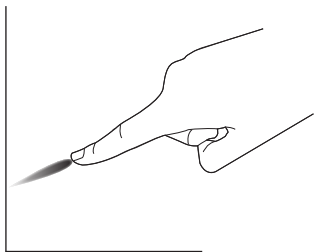

Flick

Touch the target on the screen with one fingertip and brush the surface quickly.

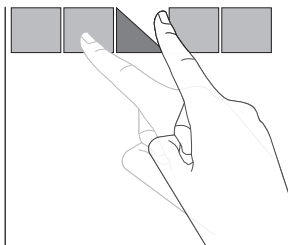

Zoom in

Touch the target on the screen with two fingertips held together and move them apart to zoom in (magnify) the screen image.

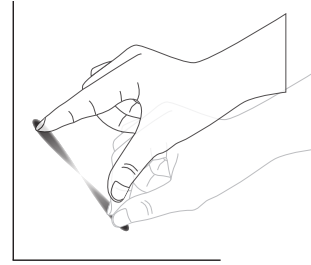

Zoom out

Touch the target on the screen with two fingertips stretched apart and move them closer to zoom out (shrink) the screen image.

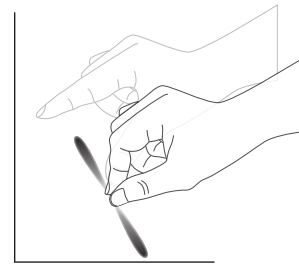

Touch and Hold

Touch and hold the target on the screen with one fingertip for a while to display a context menu or options page for an item.

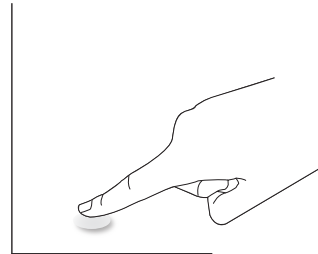

Avoid

- Avoid scratching with sharp object on the screen. Only use your fingertips or provided styli to perform touch operation.
- Do not expose the screen to intensive light, spotlight, or wide-spread light.
- Do not install the product to a location where is close to the windows or glass-doors as the direct sunlight may affect the touch-control performance.
- To avoid screen interference with each other, do not place 2 touch screens side by side as shown below.

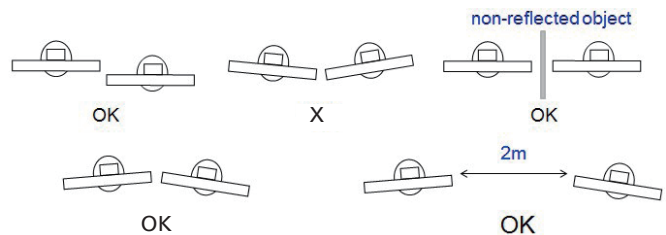

Fig. Touch screens interference

The multi Touch function is not supported by Mac OS. The OS supported is listed below.

Item	Description		
Operating Systems Supported by Plug-and-Play	Windows 7, 8/8.1, 10, 11		
Supported Modes of Operation by the Operating System	OS	Single Touch	Multi Touch
	Windows 7, 8/8.1, 10, 11	O	O*
	Mac OSX before (include) 10.15	O	X
	Mac OSX after (include) 10.10	O	X
	Chrome 38+	O	O**
	Android 4.0, Kernel after (include) 3.6	O	O***
	Linux	O****	O*****
	* Support multi-touch. ** Kernel 3.15 upward. *** Support 10-point touch. **** CentOS, Debian, Fedora, Gentoo, Mandrake(Mandriva), Meego, Red Hat, Slackware, SuSE(OpenSuSE), Ubuntu(Xubuntu), and Yellow Dog etc. *****Kernel 3.15 upward.		

1. We highly recommend that you use the latest Service Pack with all Windows 7 OS.
2. Digitizer input to Windows refers to touch digitizer as opposed to touch stylus in tablet PCs.
3. Set as default by Microsoft.

5. Operation

Note: The control button described in this section is mainly on the remote control unless specified otherwise.

5.1. Watch the Connected Video Source

1. Press the [↔] SOURCE button.
2. Press arrow buttons to select a device, then press [Enter] button.

5.2. Launcher

Launcher:

- You can press "Home" on the Navigation bar to start up.
- Multiple Home shortcut items can be added to the Launcher.
- Swipe up can open all apps list.

1) Whiteboard page:

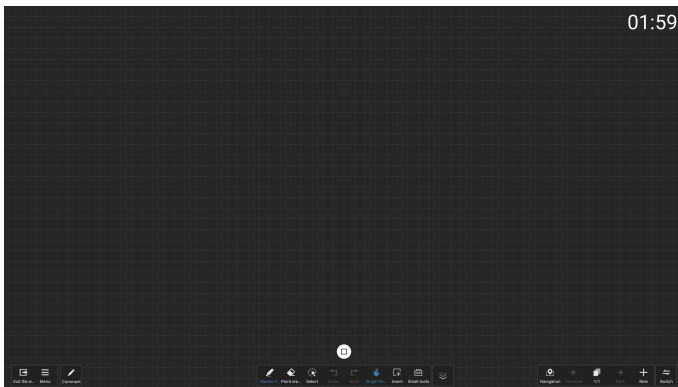

2) File Manager:

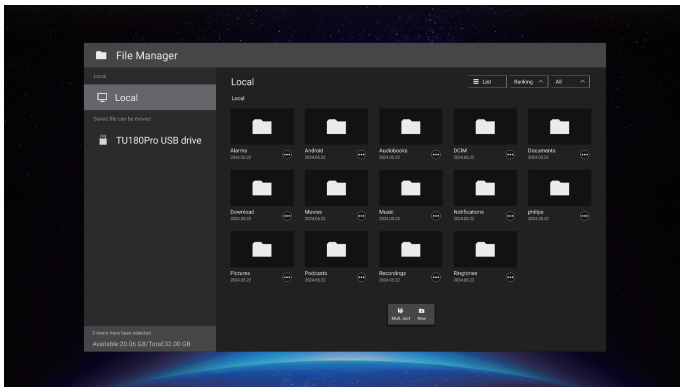

5.3. Media Player

5.3.1. OSD menu interaction with media player:

1. Boot on source:
 - Input:
 - If you select Media player as the source, the system will enter media player automatically after the boot process is completed.
 - Playlist:
 - 0: go to the main page of media player.
 - 1 - 7: go to media player and playback File1 - File7 of playlist automatically.
2. Schedule:
 - Today:
 - Show date and time.
 - 1 - 7:
 - Set up to 7 schedules.
 - On/Off:
 - Set start time and end time.
 - Input:
 - Select Media player as the source, the PD will launch the media player automatically at end time.
 - MON, TUE, WED, THU, FRI, SAT,SUN, Every week :
 - Set life cycle.
 - Play list :
 - 0: go to the main page of media player.
 - 1 - 7: go to media player and playback File1 - File7 of the playlist automatically.
 - Clear all

5.3.2. Media Player introduction:

1. Main page of Media Player app, this App consists of three items: "Play", "Compose" and "Settings".

Play: select a playlist to play.

Compose: edit playlist.

Settings: set play properties.

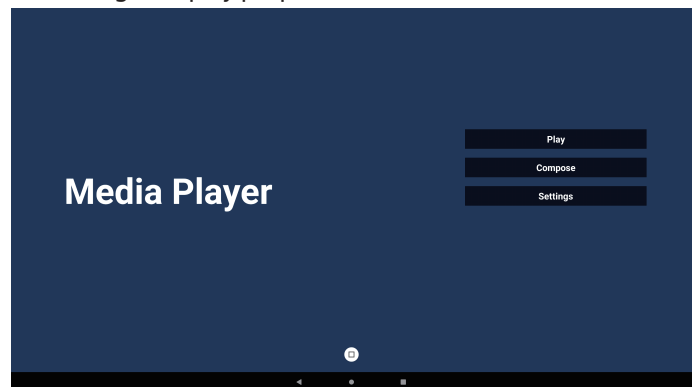

2. Select "Play" on the main page, first you should choose one playlist to play between FILE 1 and FILE 7. The pencil icon means the playlist is non-empty.

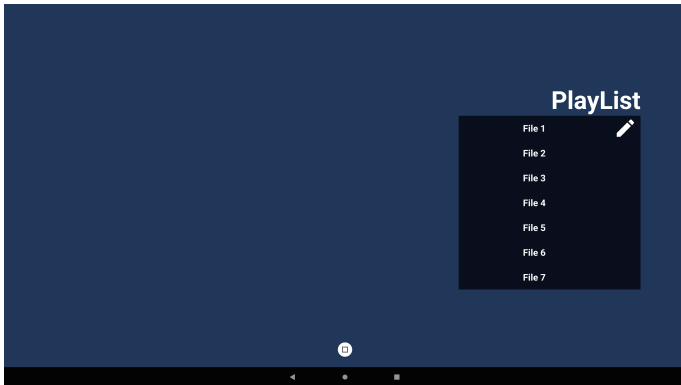

3. Select "Compose" on the main page, first you should choose one playlist to edit between FILE 1 and FILE 7. The pencil icon means the playlist is non-empty.

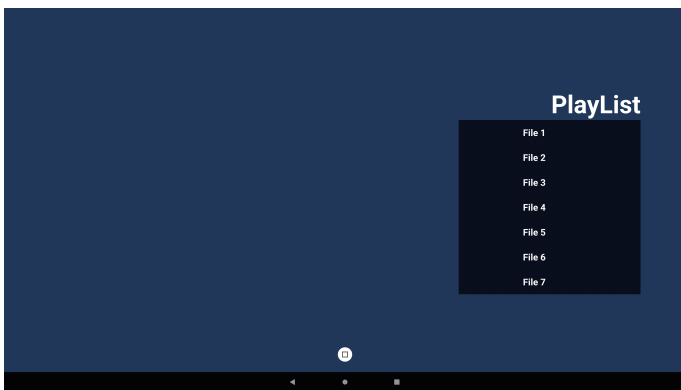

4. If an empty playlist is chosen, the app will guide you through selecting the media source.

All media files should be placed in /philips/ of root directory.

For example,

- videos in /philips/video/
- photos in /philips/photo/
- music in /philips/music/

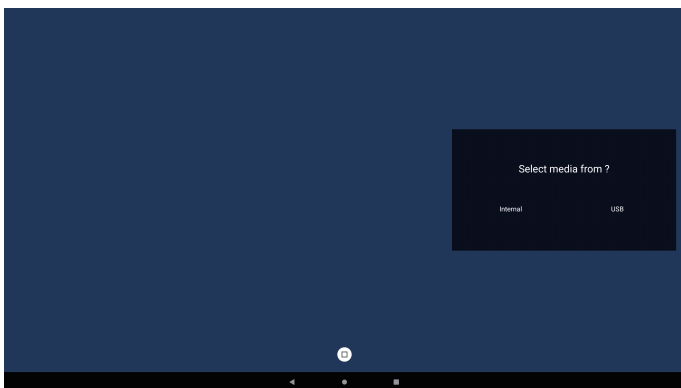

5. If you select "USB" storage, the app will guide you through selecting the USB device.

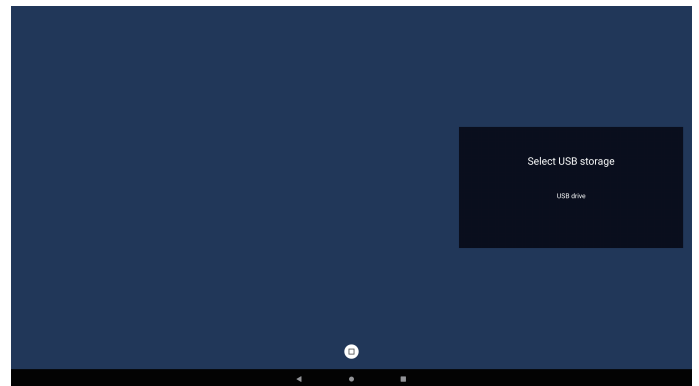

6. To edit or delete a non-empty playlist, select the desired playlist that shows a pencil icon on right side of the file.

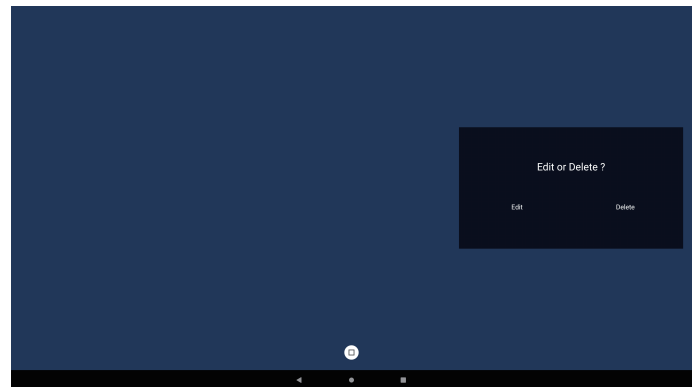

7. Once you start to edit a playlist, a menu is displayed as below:

Source - files in storage.

Playlist - files in playlist.

Toolbar - launch sidebar.

Play - play media file.

Info - show media info.

Touch file - select/deselect a file.

Note: When long press on one of the directory in Source, full path will be displayed.

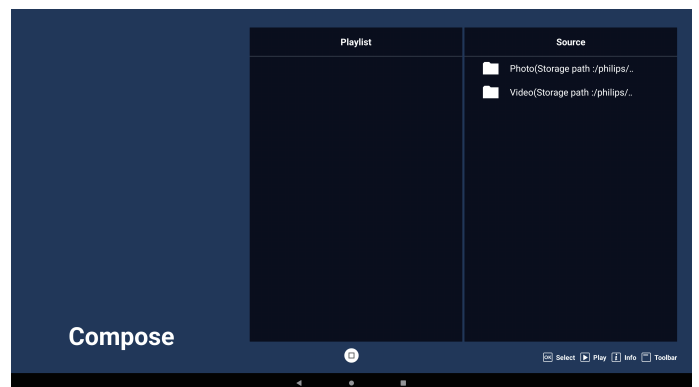

- 7.1 In the sidebar, the following functions are available:

- Select all: select all storage files.
- Delete all: delete all playlist files.
- Add/Remove: update playlist from source.
- Sort: sort playlist.
- Save/abort: save or abort playlist.
- Back: return.

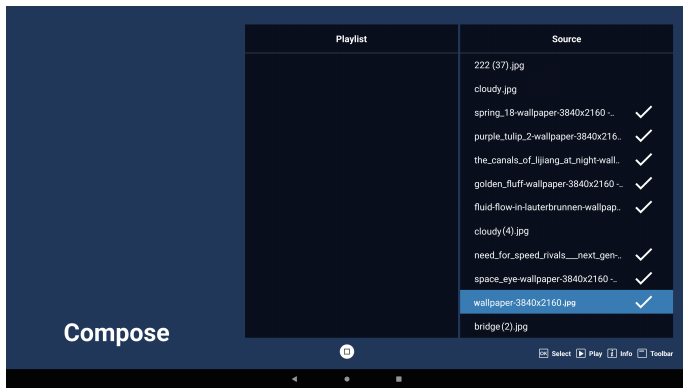

8. If "Sort" is selected, you can customize the file order severally.

Note: When leaving from this page, all data will be saved automatically.

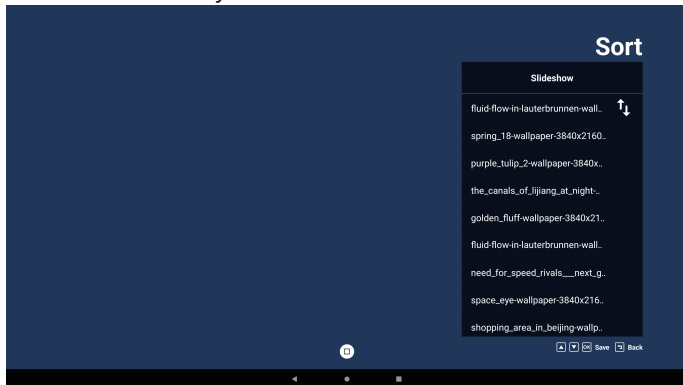

9. After selecting the desired file, press "Info" key to get detailed information.



10. After selecting the desired file, press "Play" key to play the media file immediately.

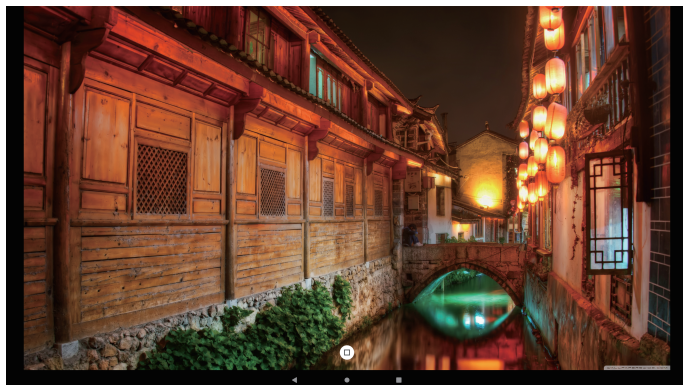

11. If you created a playlist with all image files, you will be asked to add a background music to the slideshow before saving.

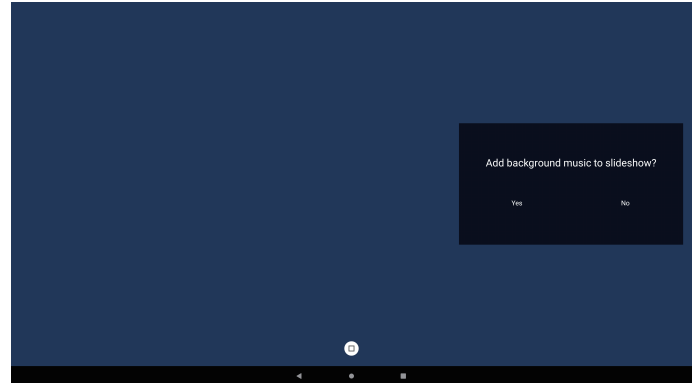

12. Select "Settings" in the main page, there are five options available: "Repeat Mode", "Slideshow Effect", "Effect Duration", "Software Decode" and "Autoplay".

Repeat Mode: select repeat once or repeat all.

Slideshow Effect: photo slideshow effect (right to left, fold corner or none).

Effect Duration: photo effect duration (5 seconds, 10 seconds, 15 seconds or 20 seconds).

Software Decode: no black screen between videos play (enable, disable).

Autoplay: Plug in the USB and it will automatically play files from USB root path. (enable and disable autoplay, photo only, video only, photo and video, help).

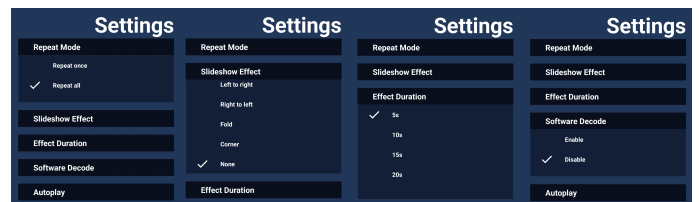

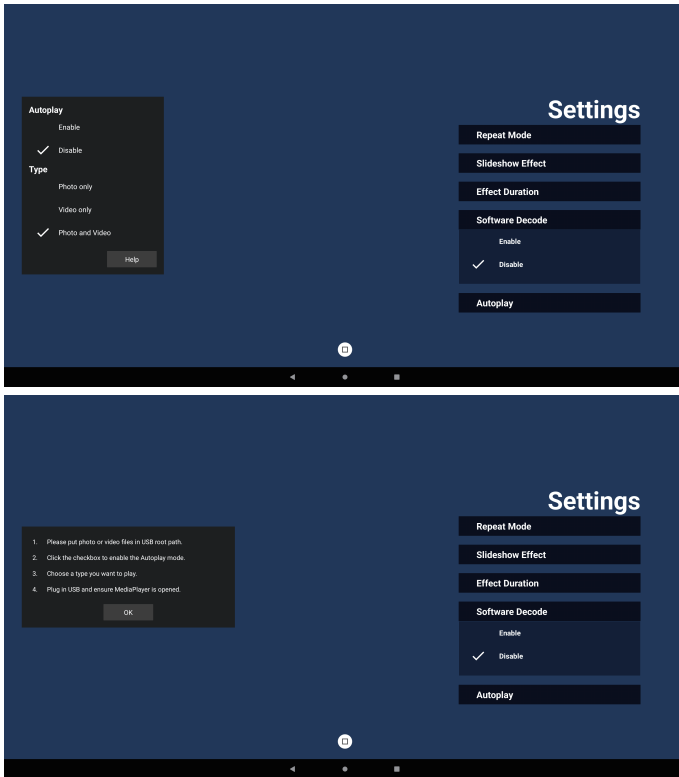

Step 4. Start media player app, it will automatically import media player text file.

Note: Once the playlist file (text) is imported, if user changes playlist via remote control, this change will not be reflected in the playlist text file.

13. Media Player import text file

Step 1. Create media player text file.

- File name : mppplaylistX.txt, "X" means playlist number(1,2,3,4,5,6,7).

Ex. mppplaylist1.txt, mppplaylist2.txt

- Content :

```

1 photo/xxx.jpg
2 video/yyy.mp4
3 music/zzz.mp3
  
```

Note: If the playlist contains video and music files, the screen becomes black when playing music file.

Step 2. Copy "mppplaylistX.txt" to "philips" folder of internal storage. You may use FTP to do this.

- File path : /storage/emulated/legacy/philips (for DL, PL)
Ex. /storage/emulated/legacy/philips/mppplaylist1.txt

Step 3. Prepare media files to "photo", "video" and "music" folder under "philips" folder, internal storage only.

- Ex. /storage/emulated/legacy/philips/photo/xxx.jpg
/storage/emulated/legacy/philips/video/yyy.mp4
/storage/emulated/legacy/philips/photo/zzz.mp3

5.4. Browser

5.4.1. Brower introduction:

1. Main page of "Browser" App which allows you to make related settings.

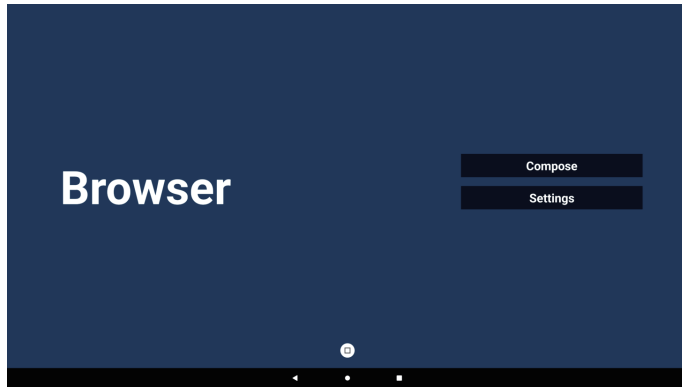

2. Press "Compose" then enter the next page. Users can choose between 1~7. A dialog box appears after the selection is made.

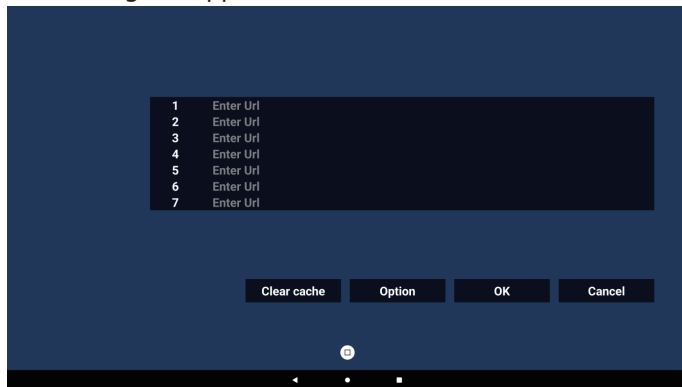

3. Enter URL and press the OK button, the data will be saved in the List.

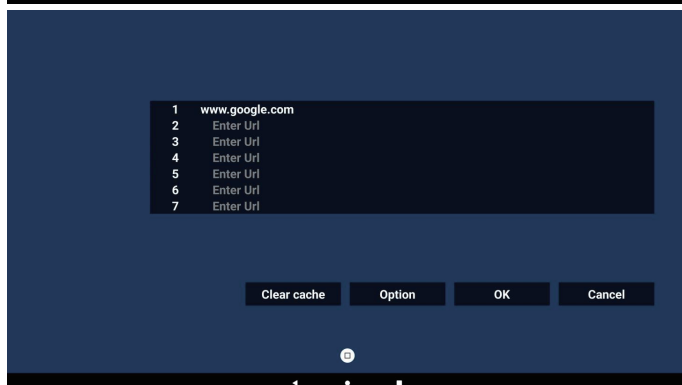
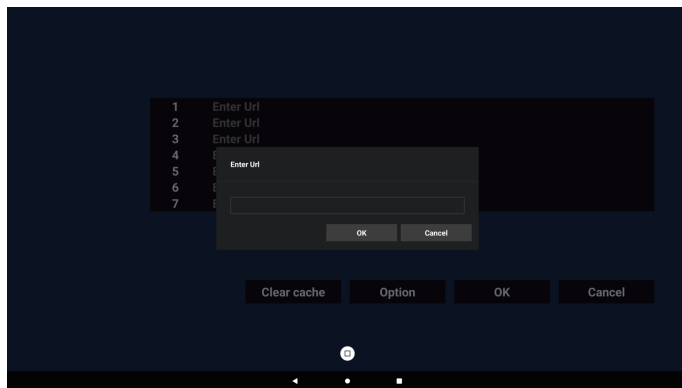

4. Press "Option" and a list will appear on the left side.
 - Import: Import Url list file.
 - Export: Export Url list file.
 - Delete all: Delete all Url record on the right side.
 - Back: Close the side menu bar.

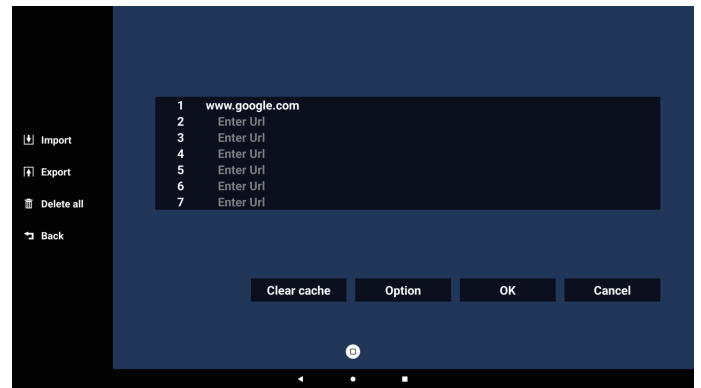

- 4-1. Import :
 - a. Select the storage from which the file will be imported.

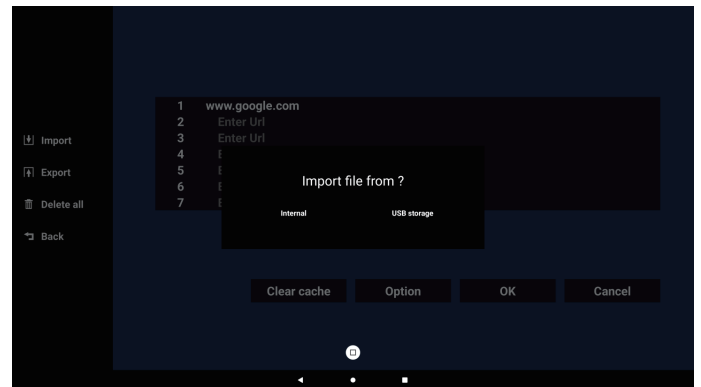

- b. Select a browser file.

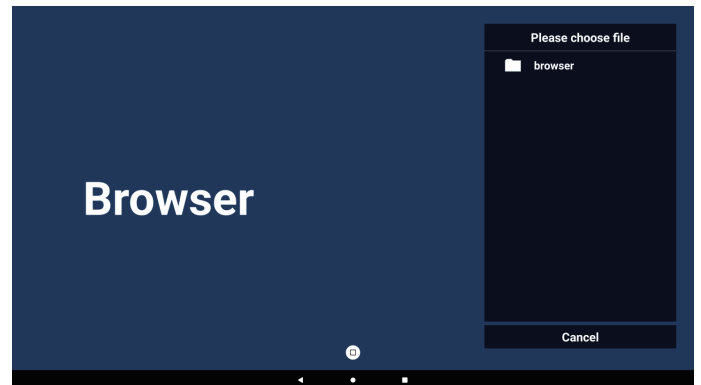

- c. Import the browser file and the URL will be listed on the screen.

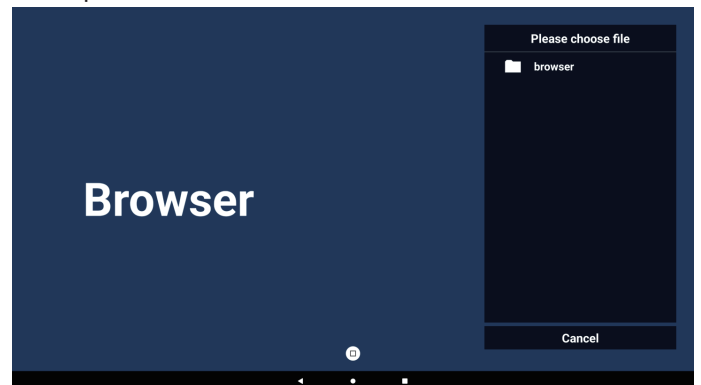

d. The file format supported for import is “.txt”.

```

uris.txt
1 http://www.abc.com
2 http://www.baidu.com
3 http://www.bbc.com
4 http://www.bbc.com.tw
5 http://www.cnn.com
6 http://www.youtube.com
7 http://www.yahoo.com.tw

```

4-2. Export:

a. Select the storage where the file will be exported to.

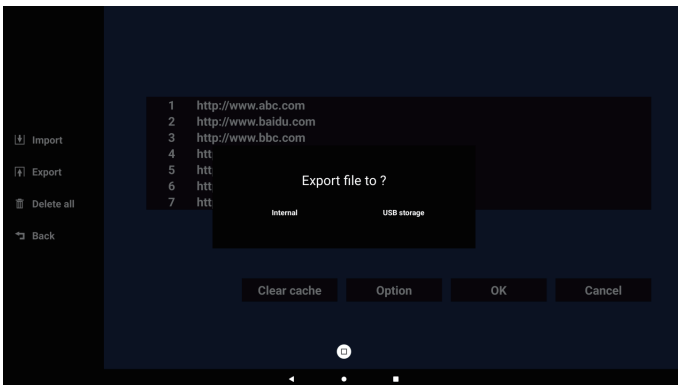

b. A dialog box displays the path of the file to be saved as well as the file name. Press the “Save” button to save the URL.

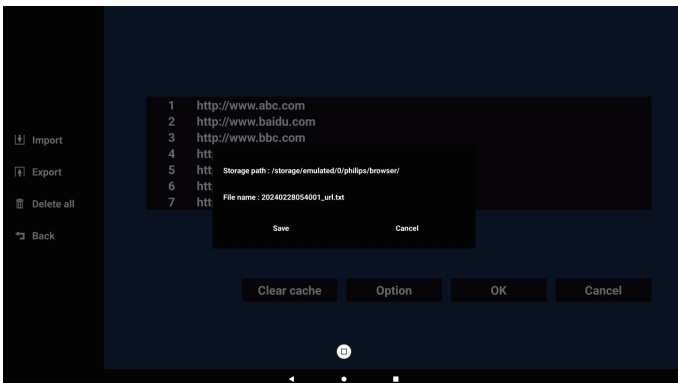

5. Press the “OK” button to save the URL record.

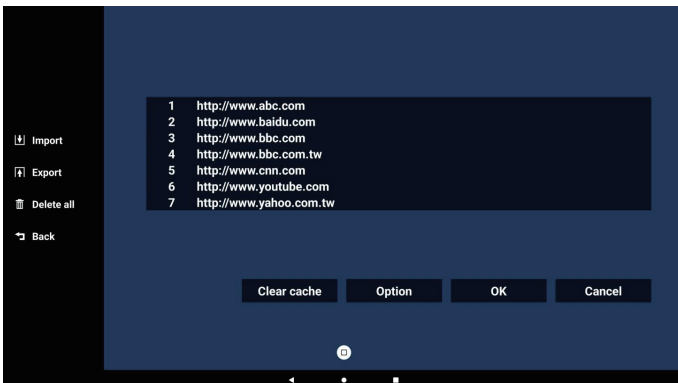

6. If you select a non-empty item from the URL list, a message will appear asking if you want to edit or play the URL. If you select “Edit” a dialog box allows you to edit the URL. If you select “Play”, a web page of the selected URL appears.

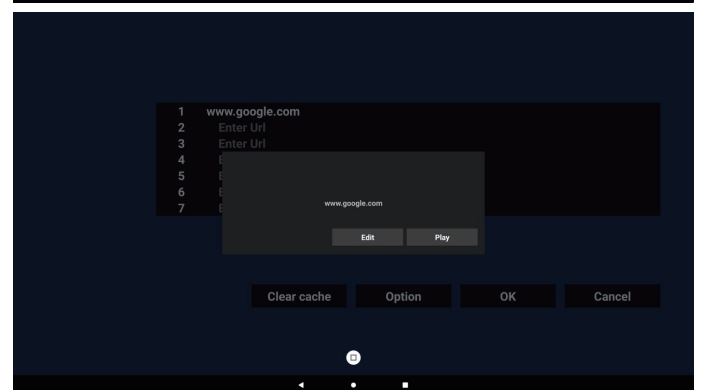
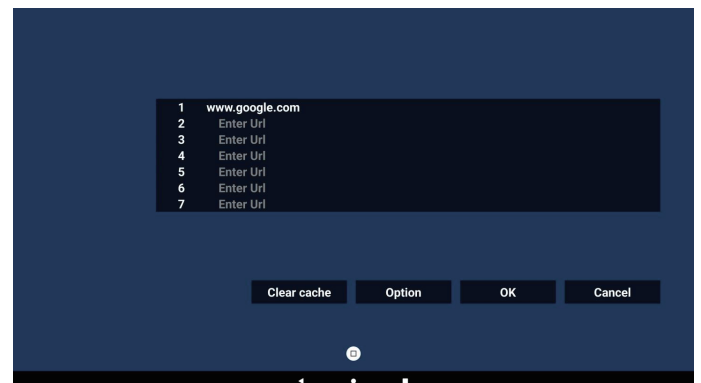

7. Press “Settings” then enter the next page.

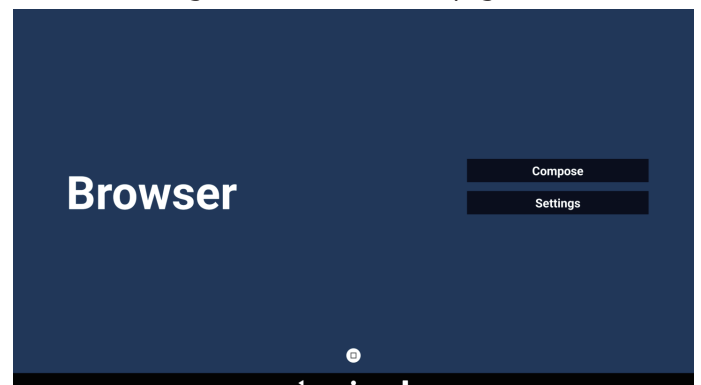

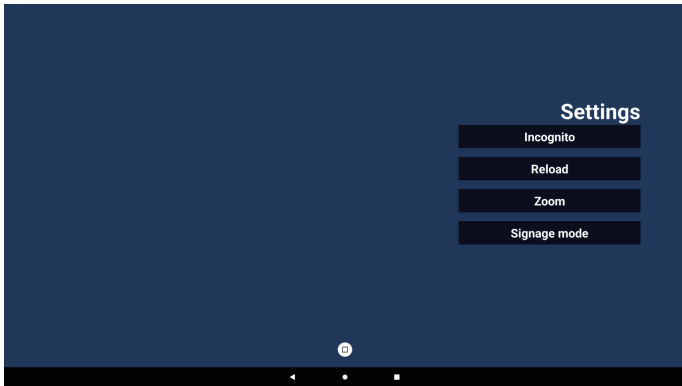

7-1. Incognito

- a. Enable : Display webpages using incognito mode.
- b. Disable: Display webpages using non-incognito mode.

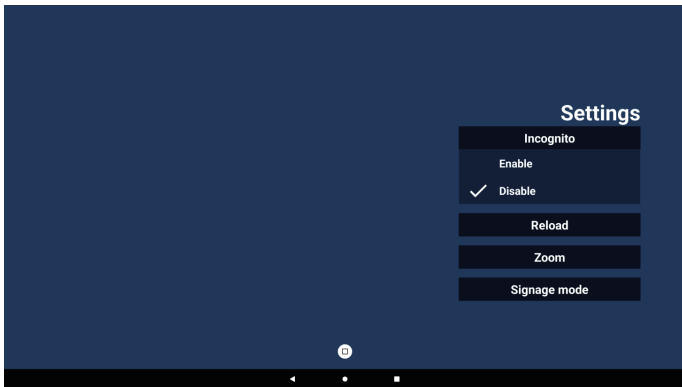

7-2. Reload

Allow users to set the webpage reload time.

- a. If the enable check box is unchecked, reload will not work.

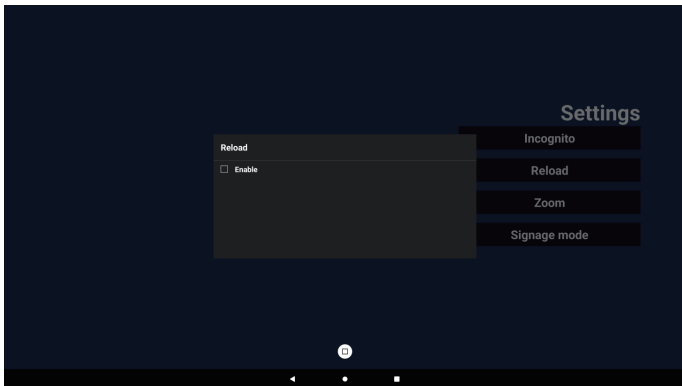

- b. if the enable check box is checked, you can set the reload time.

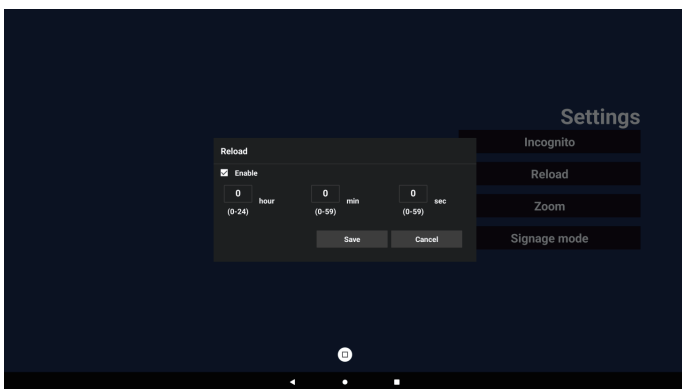

7-3. Zoom

Allow user to zoom in or out of a web page using two fingers. The webpage MUST also support this option. This option is enabled by default.

For example:

Zoom in and out on www.google.com home page.

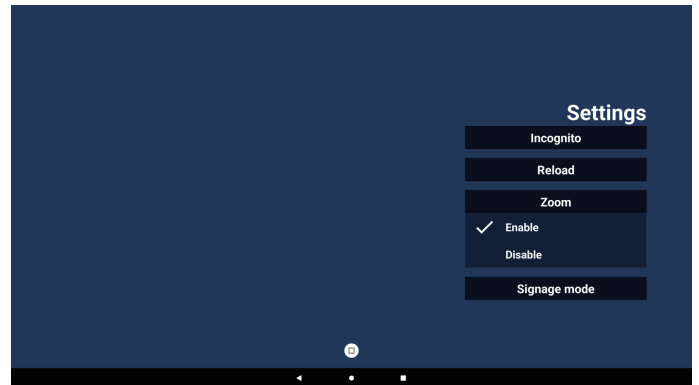

7-4. Signage mode

Enable going back to the Browser Compose page when the user returns from another app's activity. Disable keeping the Browser screen on the latest webpage. The option is enabled by default.

Open www.google.com and search for "PDF demo file". Click one PDF file in search result, the PDF file will be downloaded and opened. When user press "Back" button, the screen goes back to Browser Compose page if the option is enabled. The screen goes back to the search result if disabled.

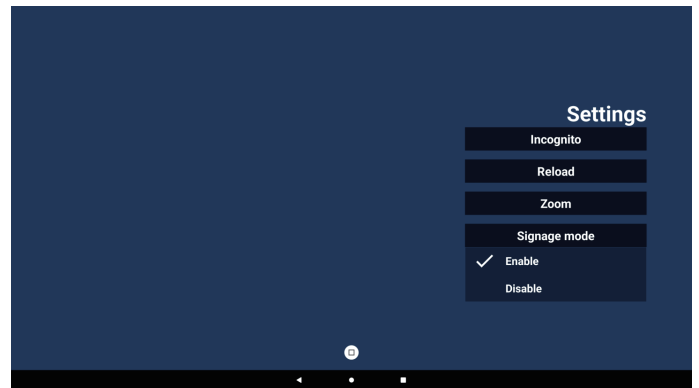

8. OSD menu interaction with Browser

8-1. Boot on source

- a. Set OSD menu => Configuration => Boot on source => set BROWSER Play List to 0. Then PD will show Browser after rebooting.
- b. Set OSD menu => Configuration => Boot on source => set BROWSER Play List to 1. Then PD will show the web page with 1st Url in Browser app.

8-2. Schedule

Set OSD menu => Advanced option => Schedule => On time1, Off time2, Input be Browser, any day of the week, and Play List. Finally check the right box. Then PD will show the web page with Url in Browser app at time1 and finish at time2.

9. Offline browsing

When URL 1 has set address, and use OSD schedule to open URL 1 web page, browser app will auto save URL 1 screenshot to local storage. The screenshot frequency is every 5 seconds and only 12 times.

If network is disconnect and OSD schedule open browser app, browser app will auto open URL 1 screenshot in local storage.

Note:

- Browser app only can save URL 1 screenshot, other URL 2 to URL 7 are not going to save.
- Local storage : /storage/emulated/0/Download/
The compose page will show "Clear cache" button, press this button can clear URL 1 address home page data and screenshot in local storage.

10. Import a Text File

Step 1. Create a text file of media player.

- File name : bookmarklist.txt.
- Content :



Step 2. Copy bookmarklist.txt to "philips" folder of internal storage. You may use FTP to do this.

- File path : /storage/emulated/legacy/philips (for DL, PL)
Ex. /storage/emulated/legacy/philips/bookmarklist.txt

Step 3. Start browserapp, it will import the text file of Browser automatically.

Note. Once the playlist file (text) is imported, any changes made through the remote control will not be recorded in the playlist text file.

5.5. PDF Player

5.5.1. OSD menu interaction with PDF player:

1. Boot on source:

- Input:
 - If you select PDF player as the source, the system will enter PDF player automatically after the boot process is completed.
- Playlist:
 - Main page : go to the main page of PDF player.
 - Playlist 1 - Playlist 7 : go to PDF player and playback File1 - File7 of playlist automatically.

2. Schedule:

- Schedule list:
 - Set up to 7 schedules.
- Enable:
 - Enable/disable schedule.
- Start time:
 - Set start time.
- End time:
 - Set end time.
- Play list :
 - 1 - 7 : go to PDF player and playback File1 - File7 of playlist automatically.
- Days of the week :
 - Set Sunday, Monday, Tuesday, Wednesday, Thursday, Friday, Saturday.
- Every week :
 - Set a weekly schedule.

5.5.2. PDF Player introduction:

- Home page of PDF Player app, this page has three items: "Play", "Compose" and "Settings".
Play : select playlist to play.
Compose: edit playlist.
Settings: setting play properties.

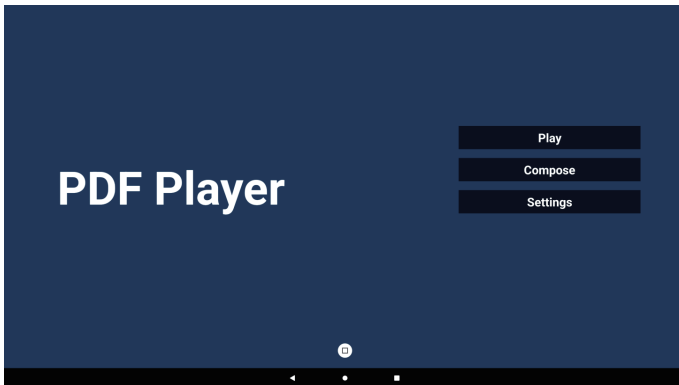

- Select "Play" on home page, first you should choose one playlist to play between FILE 1 and FILE 7. The pencil icon means the playlist is non-empty.

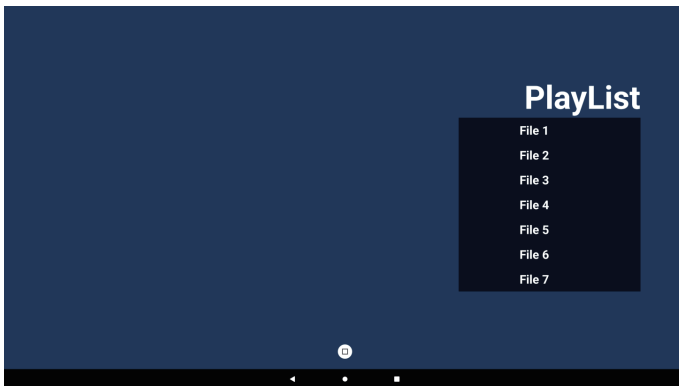

- Select "Compose" on home page, first you should choose one playlist to edit between FILE 1 and FILE 7. The pencil icon means the playlist is non-empty.

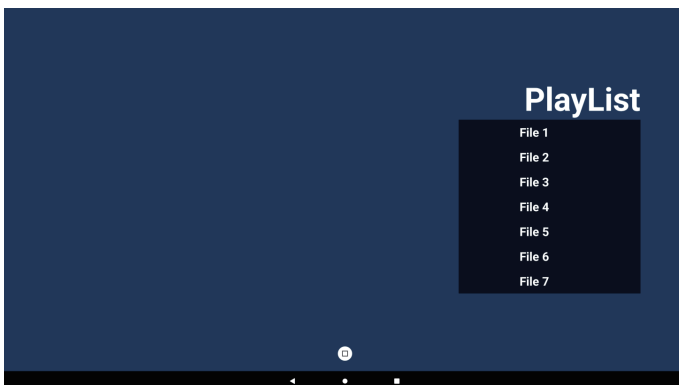

- If an empty playlist is chosen, the app will guide you to select the media source.
All media files should be placed in /philips/ of root directory.
For example,
 - pdfs in /root/philips/pdf/

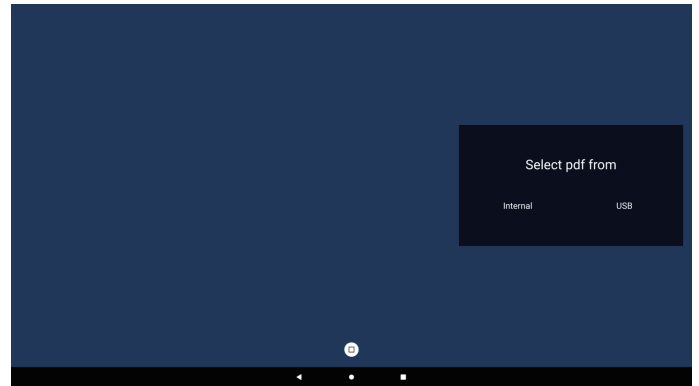

Note:

- If the USB disk cannot be found, the following message will be displayed. "Please plug in USB storage".
 - Internal storage is always available, so it can navigate to the next page.
- To edit or delete a non-empty playlist, select the desired playlist that has a pencil icon on right side of the file.

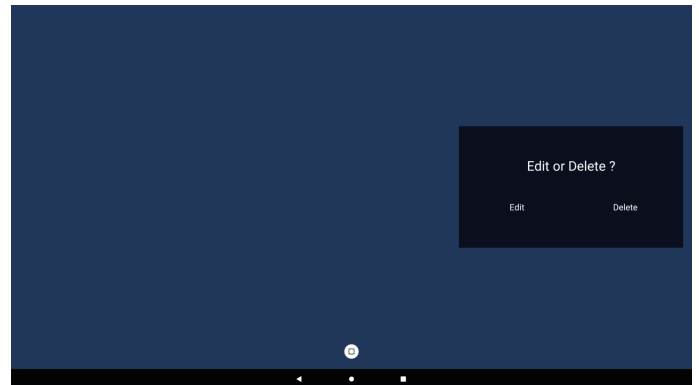

- Once you start to edit a playlist, you will see below screen.
Source - files in storage.
Playlist – files in playlist.
Toolbar – launch sidebar.
Play key – play media file.
Info key – show media info.
Ok key – select/deselect a file.

- From the side menu bar, the following functions are available:

- Select all : select all storage files.
- Delete all : delete all playlist files.
- Add/Remove : update playlist from source.
- Sort : sort playlist.
- Save/Abort : save or abort playlist.
- Back : return.



7. if you choose "Sort" in the sidebar, you can change the order of files one by one.

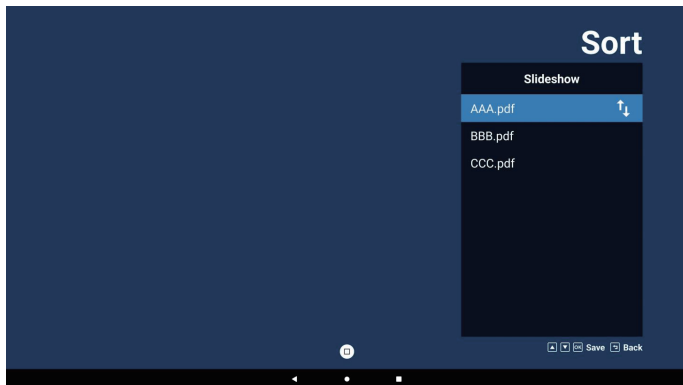

8. Select "Settings" on home page, this page has three options, "Repeat Mode", "Effect Duration" and "View Mode".

Repeat Mode : Set the repeat mode.

Effect Duration : Photo effect duration.

View Mode : Read or Full Screen mode.

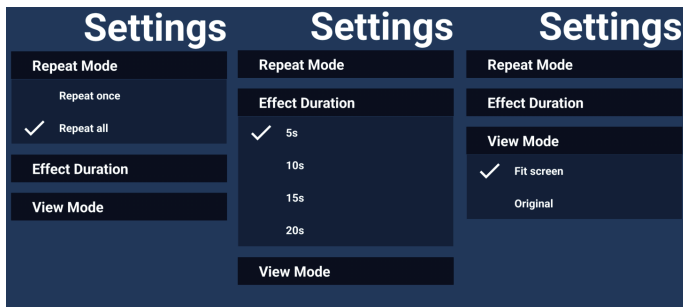

Arrow keys:

Up/Down/Left/Right : Adjust page. (When the page is zoomed in/out)

Left : Previous Page. (When the page is not zoomed in/out)

Right : Next Page. (When the page is not zoomed in/out)

Import a Text File:

Step 1. Create a text file of PDF player.

- File name : pdfplaylistX.txt, "X" means playlist number(1,2,3,4,5,6,7).
Ex. pdfplaylist1.txt, pdfplaylist2.txt
- Content :

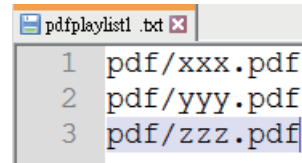

Step 2. Copy pdfplaylistX.txt to "philips" folder of internal storage. You may use FTP to do this.

- File path : /storage/emulated/legacy/philips (for DL, PL)
Ex. /storage/emulated/legacy/philips/pdfplaylist1.txt

Step 3. Prepare pdf files to "pdf" folder under "philips" folder, internal storage only.

- Ex. /storage/emulated/legacy/philips/pdf/xxx.pdf
/storage/emulated/legacy/philips/pdf/yyy.pdf
/storage/emulated/legacy/philips/pdf/zzz.pdf

Step 4. Start pdf player app, it will import the text file of PDF player automatically.

PS. Once the playlist file (text) is imported, any changes made through the remote control will not be recorded in the playlist text file.

Note:

If you plug in two or more USB disks to edit the playlist, playback from the playlist cannot be guaranteed after powering on/off, due to the USB storage path may be changed. It is strongly recommended to use only one USB disk when editing the playlist.

5.6. Kiosk

5.6.1. Kiosk interaction

1. Home page of Kiosk app, this page has two options: "Compose" and "Settings".

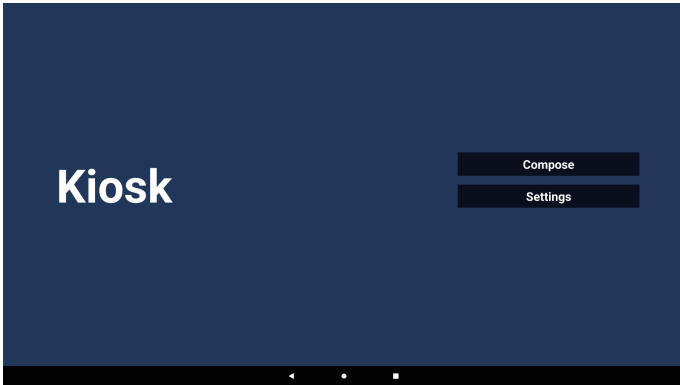

2. Press "Compose" then enter the next page. Choose from the list to edit the URL. A dialog box appears after the selection is made.

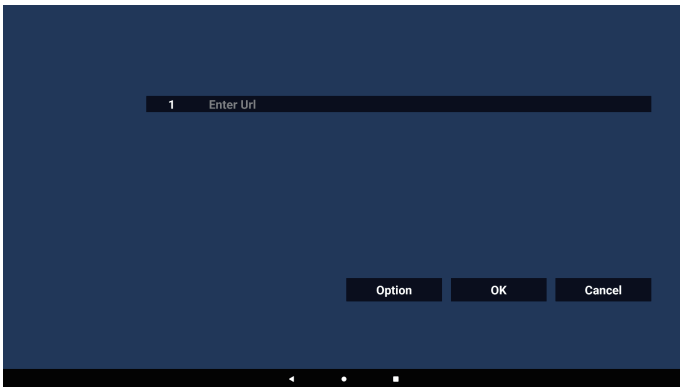

3. Enter URL and press the OK button, the data will be saved in the List.

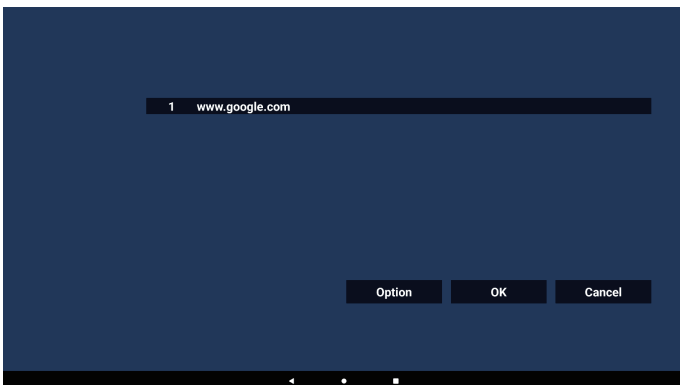
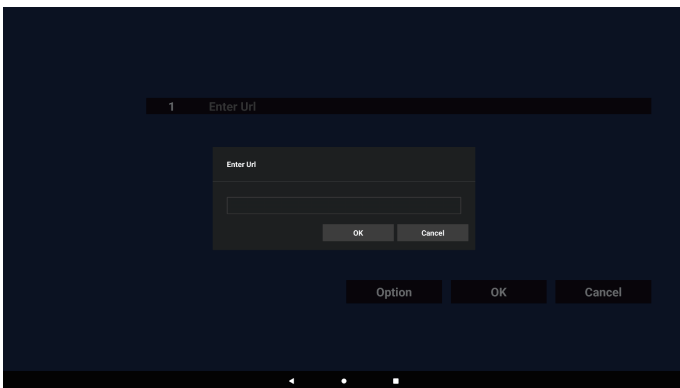

4. Press "Option" and a list will appear on the left.
 - Import : Import Url list file
 - Export : Export Url list file
 - Delete all : Delete all records of URLs on the right side.
 - Back : Close the list from the left side.

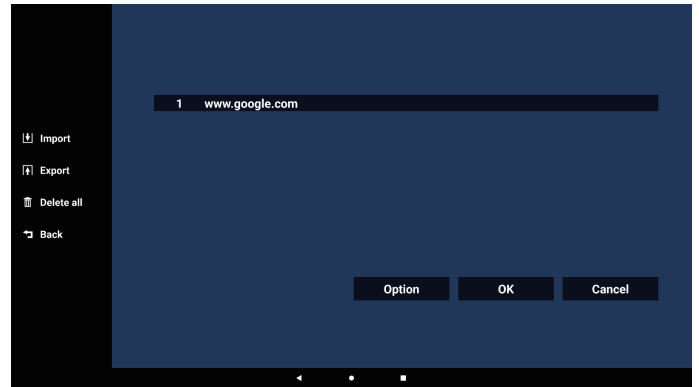

- 4-1. Import :
 - a. Choose storage

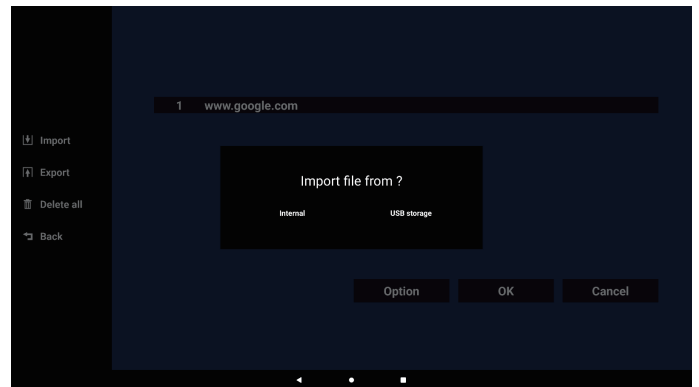

- b. Choose a file that contains URLs.

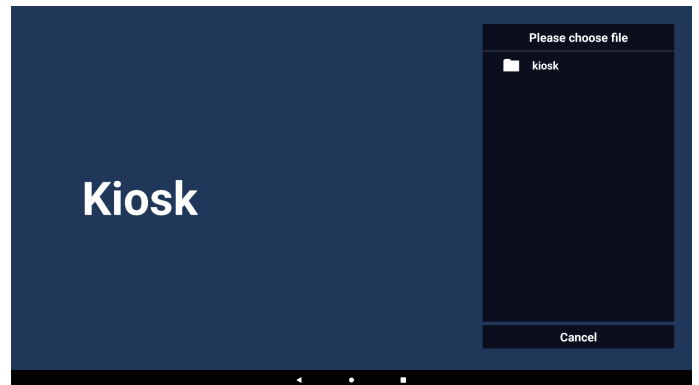

- c. Import a file and the URL will be displayed on the list.

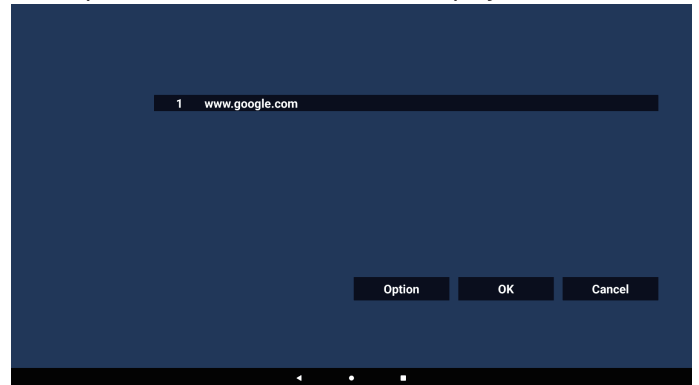

- d. File format for import
The file format should look like the example below, with the file extension ".txt".

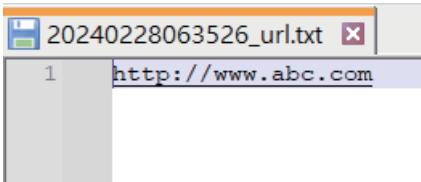

4-2. Export:

- a. Choose storage

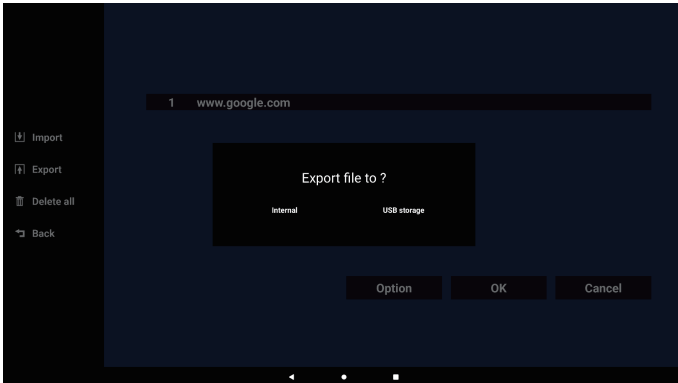

- b. The file format should look like the example below, with the file extension ".txt".

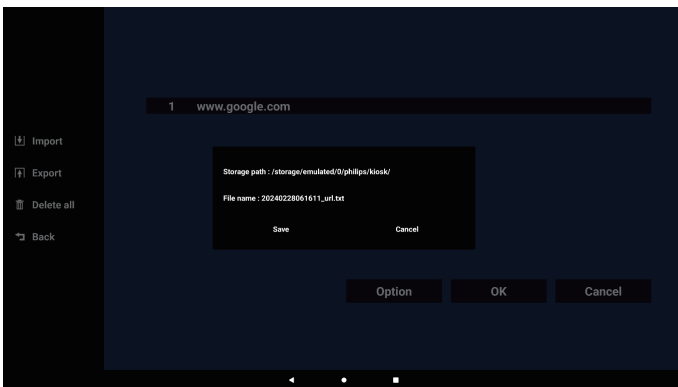

5. Press OK then Url records will be saved

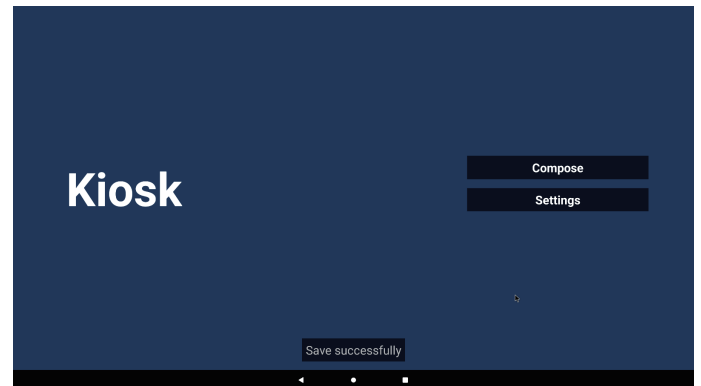
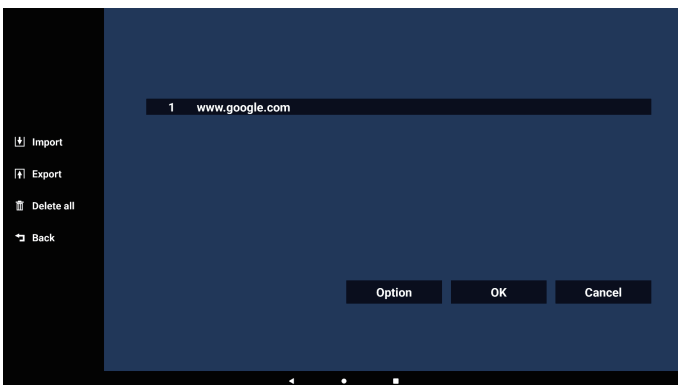

6. In the URL list page, if you select a non-empty item, a dialog will appear asking whether you would like to edit or play the URL. If you press "Edit," a URL edit dialog will appear. If you press "Play," the web page of the item's URL will be shown.

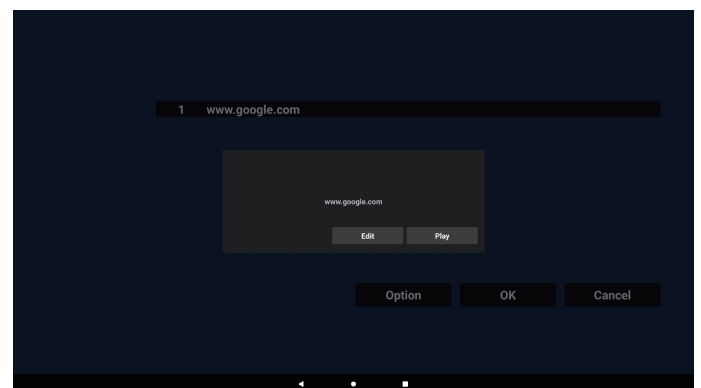
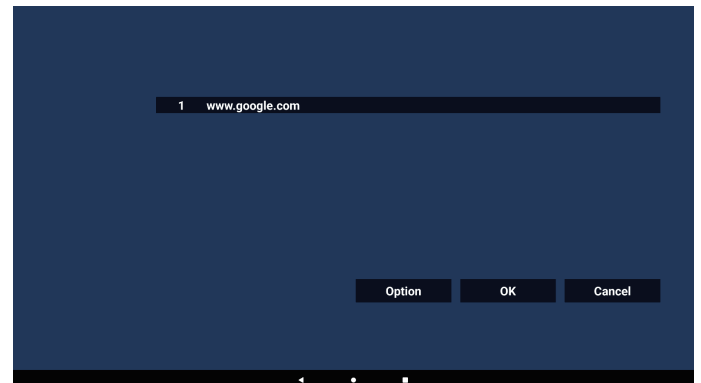

7. Press "Settings" to enter the next page.

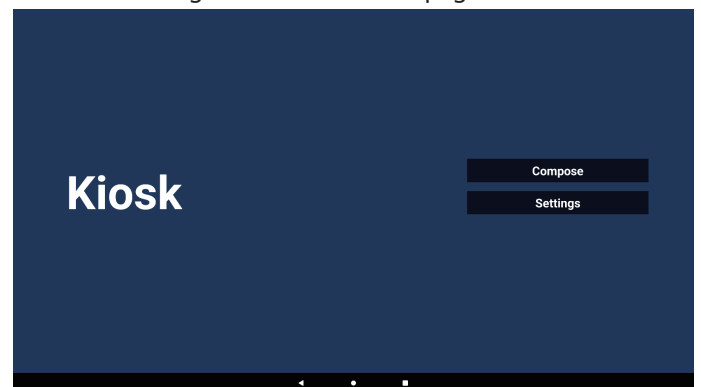



7-1. Incognito

- a. Enable : Display webpages using incognito mode.
- b. Disable: Display webpages using non-incognito mode.

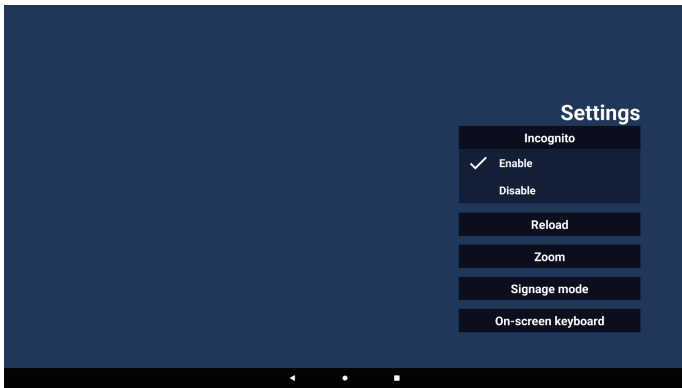

7-2. Reload

Allow users to set the webpage reload time.

- a. If the enable check box is unchecked, reload will not work.

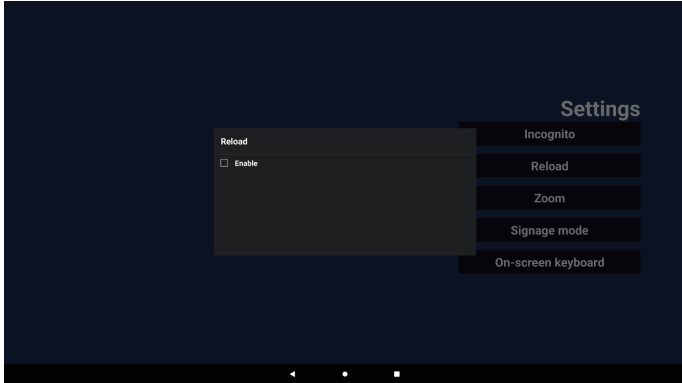

- b. If the enable check box is checked, you can set the reload time.

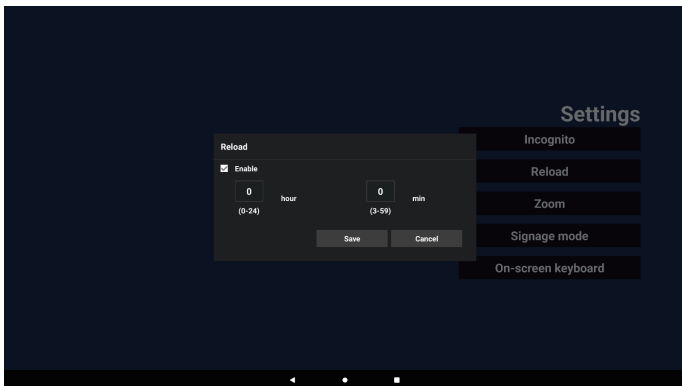

7-3. Zoom

Allow user to zoom in or out of a web page using two fingers. The webpage must support this option. This option is enabled by default.

For example:

Zoom in and out on www.google.com home page.

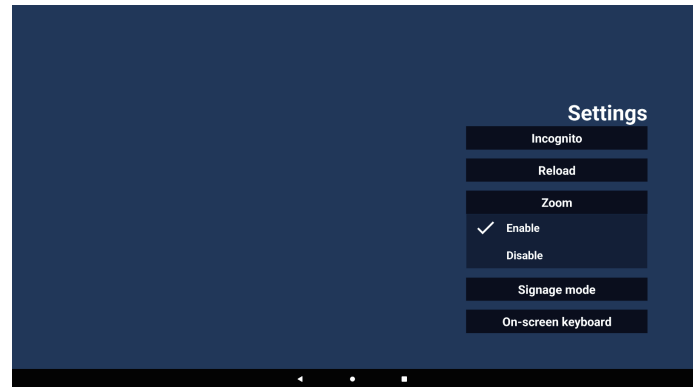

7-4. Signage mode

Return to Kiosk home page while user is back from other App's activity. With this option disabled, the kiosk screen will keep on the latest webpage. This option is enabled by default.

Open www.google.com and search for "PDF demo file". Click one PDF file in the search result, the PDF file will be downloaded and opened. When user presses the "Back" button, the screen goes back to Kiosk home page if the option is enabled. The screen goes back to the search result if disabled.

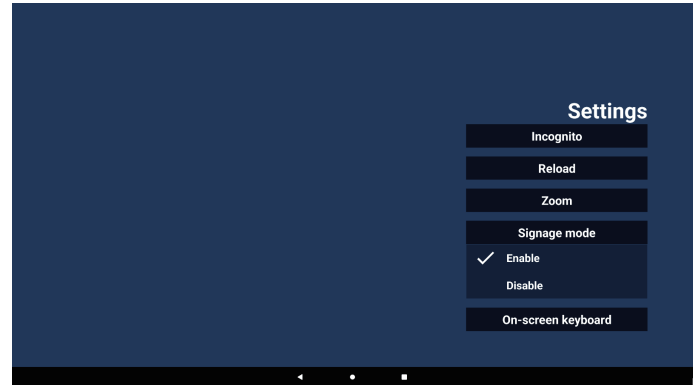

7-5. On-screen keyboard

This option is used to enable/disable the display of the Input Method Editor (IME) on the webpage. If the user disables this option is used, the IME will not appear when clicking on the input text area.

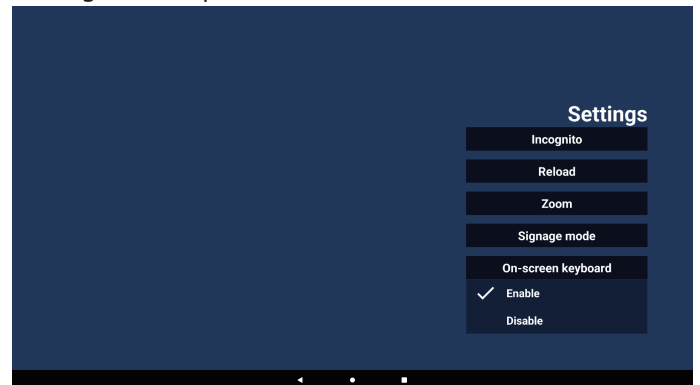

8. OSD menu interaction with Kiosk

8-1. Boot on source

- a. Set OSD menu => Configuration => Boot on source => Input is Kiosk
Then it will show the Kiosk URL in Chromium after booting up.

8-2. Schedule

Set OSD menu => Advanced option => Schedule =>

On time1, Off time2, Input is Kiosk, any day of the week, and Play List.

Finally check the right box.

It will show the web page with URL in Kiosk app at time1 and finish at time2.

9. Offline browsing

When URL 1 has set address and is scheduled to open via OSD, the browser app will automatically save the home page data of URL 1 to local storage.

If the network is disconnected and OSD schedules the opening of the Kiosk app, the Kiosk app will automatically open the home page of URL 1 from local storage. If the Kiosk cannot find the home page data for URL 1 in local storage, the screen will be black.

Note:

- a. Kiosk app can only save Url 1 address home page data.
- b. Local storage : /storage/emulated/0/Download/Offline-Browsing

5.7. Floating Bar

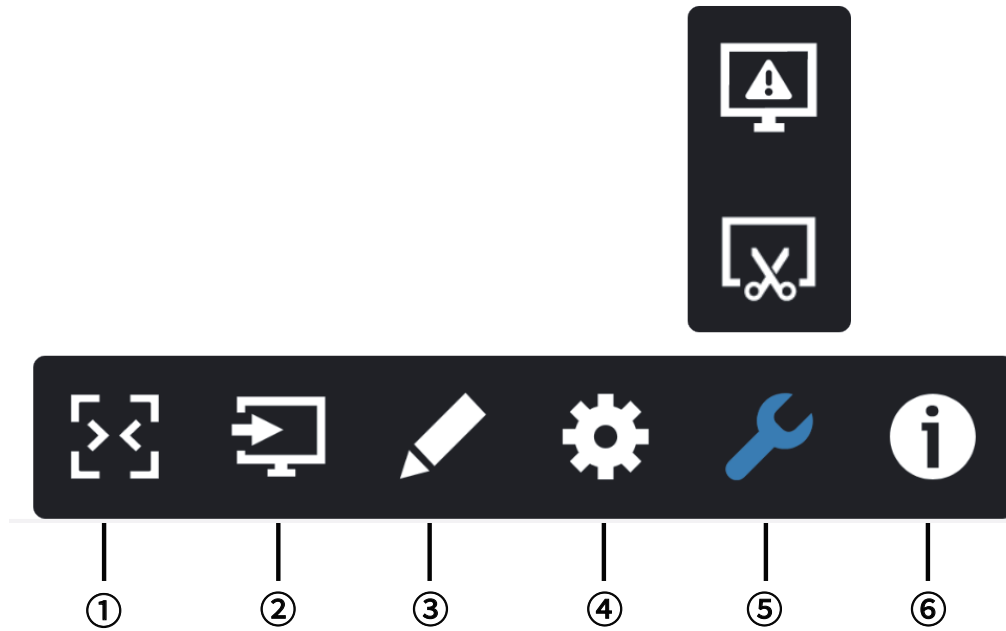

- ① **Hide**
Hide the side bar.
- ② **Source menu**
Open the source menu.
- ③ **Annotation**
Open the Annotation.
- ④ **OSD menu**
Open the OSD menu.
- ⑤ **Tool**
(5-1) Freeze/Unfreeze the screen.
(5-2) Screenshot.
- ⑥ **Quick info**
Open the Quick menu.

6. Setting UI

6.1. Settings

Setting menu consists of the following items:

- (1).Network & Internet
- (2).Signage Display
- (3).Apps
- (4).Display
- (5).Security
- (6).System

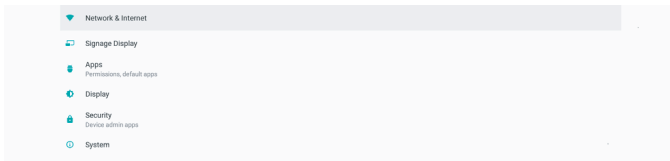

6.1.1. Network & Internet

User can set WiFi, Ethernet or Hotspot.



6.1.2. Signage Display

Settings -> Signage Display, to setup most features of signage display. See below for more detailed information about Signage Display settings.

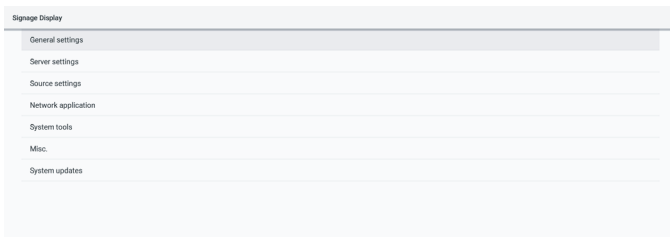

6.1.2.1. General Settings

Settings -> Signage Display -> General Settings Set up Signage Display name, User logo, Screenshot, Floating menu.



Signage Display Name

Settings -> Signage Display -> General Settings -> Signage Display Name

Set up Signage Display name, the default name is Ethernet MAC address with prefix "PD_". For example, "PD_000b12223398". The maximum length of name is 36 characters in UTF8 format. Click to rename it.

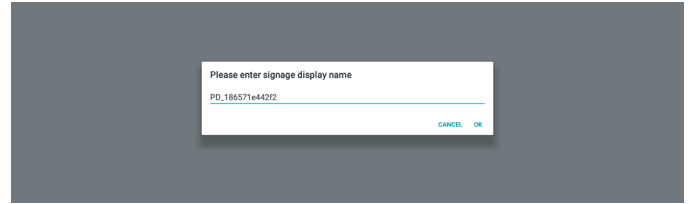

Boot Logo

Settings -> Signage Display -> General Settings -> Boot Logo

User can set up device boot up logo (boot animation) when OSD Menu -> Configuration -> Logo is set to "User" mode.

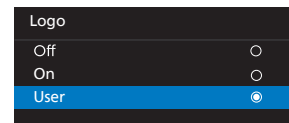
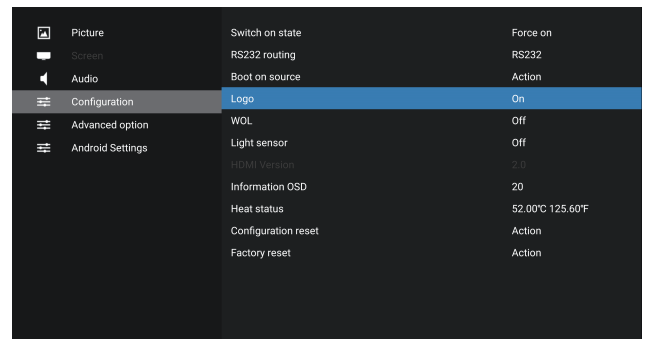

If "Logo" is not set to "User" mode, user cannot customize boot animation.

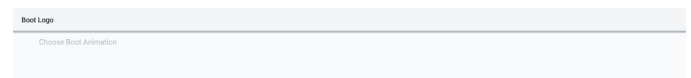

When it is set to "User" mode, the option "Choose Boot Animation" becomes available.

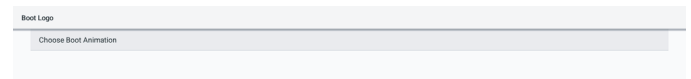

When Logo is set to "User" mode, the default Philips logo will be replaced by user selected boot animation file.

Click "Choose Boot Animation" and a pop-up menu appears for user to select boot animation file. Content saved on a USB memory card will be scanned automatically.

Boot animation file name must be set as "bootanimation.zip", any other format is invalid.

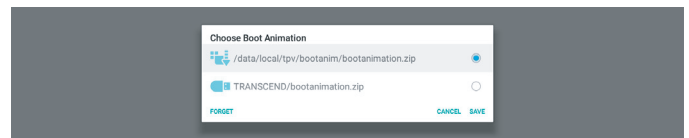

All available boot animation files can be found in the following folder:

1. File under /data/local/bootanimation/:
The boot animation file that are copied from USB
2. File under {USB_STORAGE_VOLUME_NAME}/:
The boot animation file saved on the USB storage.

Dialog options:

1. FORGET
Clear "bootanimation.zip" under /data/local/bootanimation/.
Customized boot animation will not be used during system boot up.
2. CANCEL
Cancel and close the dialog box.
3. SAVE
Copy selected file to /data/local/bootanimation/. After doing this, user can remove their external storage (USB).
System uses the boot animation file under /data/local/bootanimation.

If the system cannot find any bootanimation.zip file under external storage (USB) and /data, the file list is empty. The "SAVE" and "FORGET" buttons are grayed out, user should check content saved on the USB memory. Click "CANCEL" button to close the dialog box, and plug in the USB memory again.

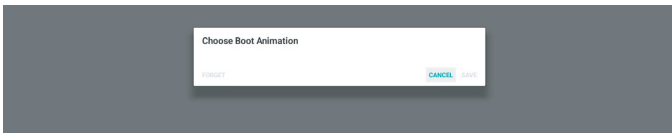

If /data/local/bootanimation/ folder is empty, it means that "bootanimation.zip" has not been saved yet by user. The Default Philips logo appears during system boot up.

When "bootanimation.zip" is found under external storage, a dialog box of the file list will appear.

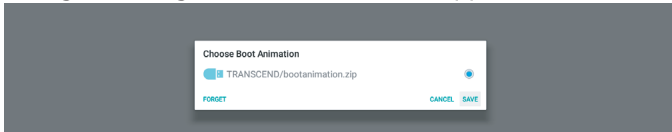

If the file "bootanimation.zip" can be found in the folder "/data/local/bootanimation/", the pop-up dialog box will show that file as the first option. It simply means that user has previously copied (saved) the file "bootanimation.zip" and that the system will boot up with boot animation from /data/local/bootanimation/bootanimation.zip.

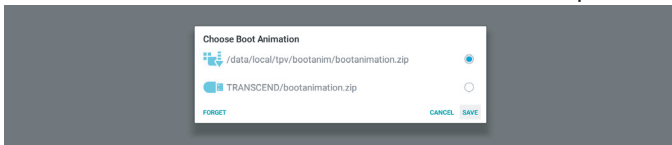

Boot animation file can be replaced by using the "SAVE" button.

Floating menu

Customize the functions of the floating menu during touch gesture. These options are only available when the platform supports touch devices.

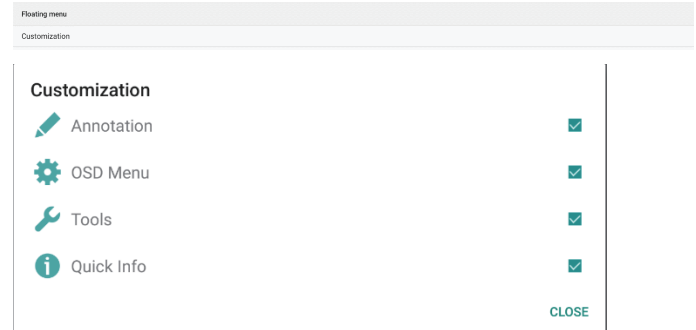

6.1.2.2. Server Settings

Settings -> Signage Display -> Server Settings

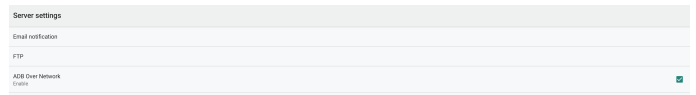

Email Notification

Settings -> Signage Display -> Server Settings -> Email Notification

Click the checkbox to enable/disable E-mail notification feature. Set SMTP and manager E-mail after enabling the E-mail notification feature.

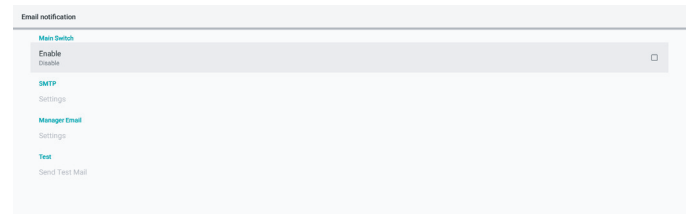

SMTP

Setup sender E-mail address and SMTP server information. There are two types of SMTP server for user to set up: "Gmail" and "Other". By using "Other" option, user can manually setup SMTP server, security type and server port.

Note:

1. The password should be in UTF8 format with 6 to 20 characters.

2. User cannot set port 5000 (SICP default port) and 2121 (FTP server default port).

SICP network port setting in “Settings -> Signage Display -> Network Application -> SICP network port”.

FTP network port settings in “Settings -> Signage Display -> Server settings -> FTP -> Port”.

Gmail: (SMTP server, Security type and Port are grayed out)

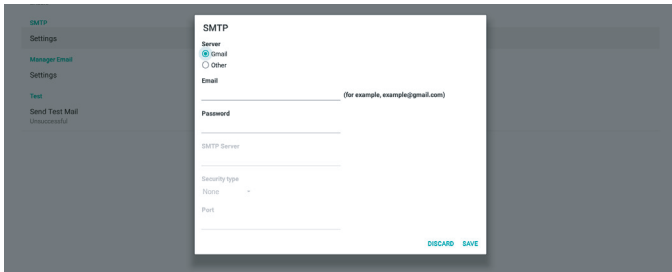

Other:

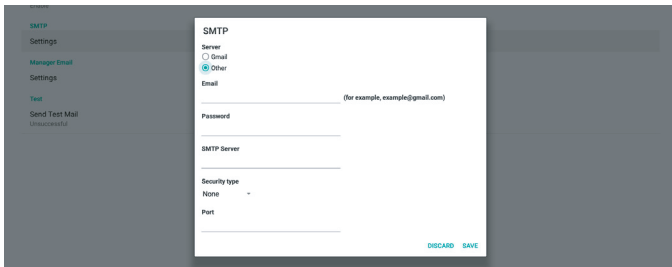

Gmail Security Settings

Gmail requires two-stage authentication.

Manager Email

Specify the destination address to receive the e-mail.



Test

To check if your e-mail settings are correct, select ‘Send Test Mail’ to send a test e-mail.

FTP

Settings -> Signage Display -> Server Settings -> FTP

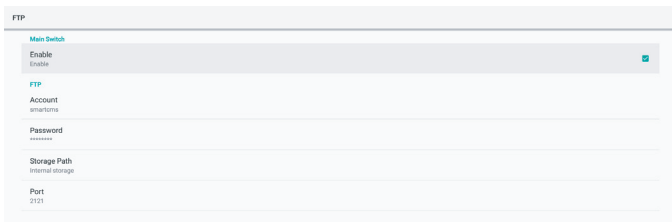

Click the checkbox to enable/disable FTP server feature. After enabling this feature, user can setup account, password and port number.

- (1).Account: The user name to log in the FTP server. The length of the account name should be ranged from 4 to 20 characters, only [a-z], [A-Z] and [0-9] are allowed to use.
- (2).Password: The password to log in the FTP server. The length of the password should be ranged from 6 to 20 characters, only [a-z], [A-Z] and [0-9] are allowed to use. The password are covered by asterisks after setting.

- (3).Storage path: The FTP server has access to the internal storage only. The storage path is unchangeable.
- (4).Port: The port number for FTP server. Available port number ranges from 1025 to 65535, the default setting is 2121. The following port number cannot be used: 8000 / 9988 / 15220 / 28123 / 28124 and SICP network port (default 5000).

Finally, manually reboot the system to apply FTP settings.

Bind status:

- (1).If the device does not have appropriate network connection, a message “Network is disconnected” will appear.
- (2).If the device is equipped with network function, but is not connected to the remote control server, a message “Server is disconnected” will appear.
- (3).If a server is connected, but not bound, a message “Server is unbinded” will appear.
- (4).If the device is bound with the server successfully, a message “Server is binded” will appear.
- (5).If the PIN code is not correct, a message “Error PIN code” will appear.

ADB over Network

You can access ADB over a network connection with port 5555.

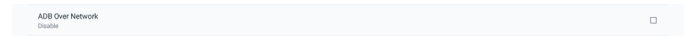

6.1.2.3. Source Settings

6.1.2.3.1. Android Source

Settings -> Signage Display -> Source Settings



User can configure source APK’s detailed options.

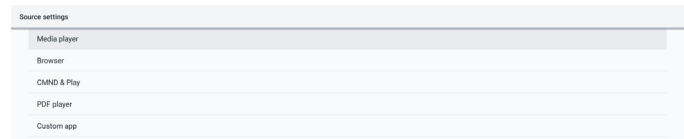

Media Player

Settings -> Signage Display -> Source Settings -> Media Player
Open Media Player APK’s edit play list activity and edit effect settings activity.

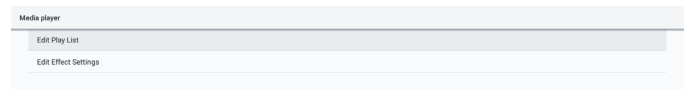

Browser

Settings -> Signage Display -> Source Settings -> Browser
Open Browser APK’s bookmark editor activity.

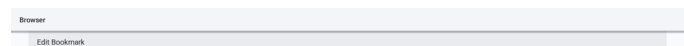

Kiosk

Settings -> Signage Display -> Source Settings -> Kiosk
Open Kiosk APK’s bookmark editor activity.

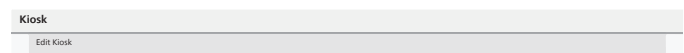

PDF Player

Settings -> Signage Display -> Source Settings -> PDF Player
 Open PDF Player APK's edit play list activity and edit effect settings activity.

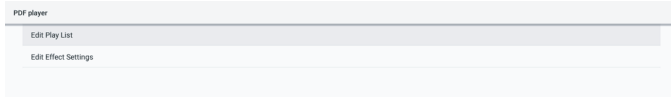

Custom app

Settings -> Signage Display -> Source settings -> Custom app
 User can set up customer source APK. The selected APK will be launched when switching to the custom input source. If custom source APK is not set, the system shows a black screen when switching to customer input source.

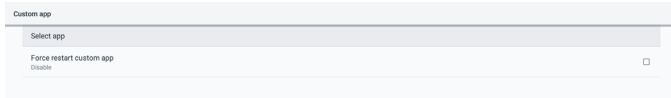

If a custom source APK is set, the APK name will be displayed. Otherwise, it means that the custom App has not been set.

Select APP

Select a specific APP for custom APP source.



Note:

The APKs pre-installed by the system will not be shown on the list. Only the APKs that were installed manually will be listed.

- (1).FORGET button
Clear the custom source application. It will be shown in gray if the customer source application has not been set.
- (2).CANCEL button
Quit without saving changes.
- (3).SAVE button
Click the "Save" button to select the APS as the custom source application. It will be shown in gray if no available application can be selected.

Force Restart Custom APP

When this feature is enabled, the system can monitor the status of a custom APP. If the custom APP doesn't exist and the boot on source is set to "Custom app", the system will then try to launch the custom APP again.

Default setting is Disable.

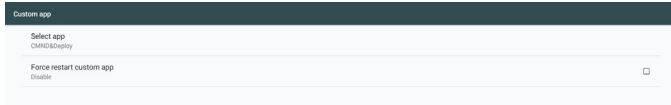

6.1.2.3.2. Source label/enable

Enable/Disable and rename the inputs visible in the source menu of the remote control and floating menu.

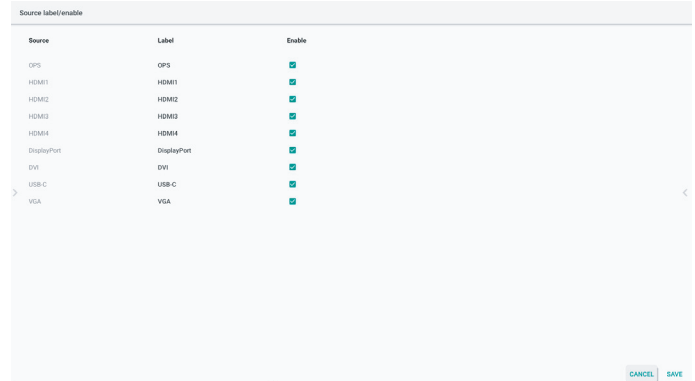

6.1.2.4. Network Application

Settings -> Signage Display -> Network Application

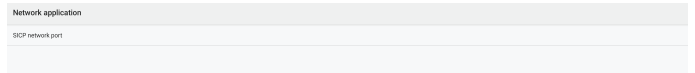

SICP Network Port

Settings -> Signage Display -> Network Application -> SICP Network Port

Set up the default port of SICP and enable/disable the network SICP. The default SICP is enabled with the port 5000.

Note:

Port number ranges from 1025 ~ 65535.

The following ports are already occupied and cannot be assigned: 8000, 9988, 15220, 28123, 28124. The default FTP port is 2121.

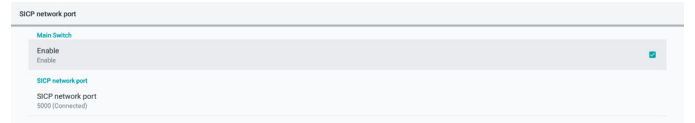

6.1.2.5. System Tools

Settings -> Signage Display -> System Tools

There are six major features in signage display system tools:

- (1).Reset
- (2).Auto restart
- (3).Import & Export
- (4).Clone
- (5).Security
- (6).Admin Password

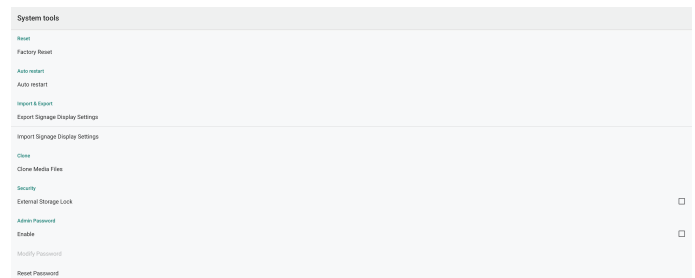

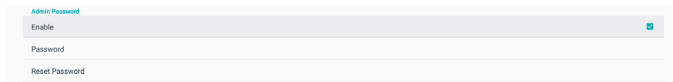

Clear Storage

Settings -> Signage Display -> System Tools -> Clear Storage

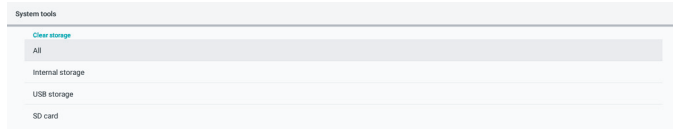

Clear data under {storage}/philips/folder of the internal and external storage.

- (1).All
Clear the folder "Philips" from the internal storage, and USB.
- (2).Internal Storage
Clear the folder "Philips" from the internal storage only.
- (3).USB Storage
Clear the folder "Philips" from the USB storage only.

A dialog box lists all folders that the system is going to clear. Press "RESET" to clear all data under the listed folder, or press back key to quit without saving.



Reset

Settings -> Signage Display -> System Tools -> Reset

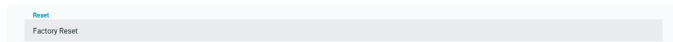

Factory Reset

This function allows you to clear all user data and settings. The system will auto reboot and jump to OOB after rebooting.

Important Note:

1. Only the data stored in the internal storage will be cleared and cannot be recovered, the data includes the device settings, installed APPs, APPs' data, downloaded files, music, photos and all data under "/data". However, the data stored on the USB will not be cleared.
2. Make sure that the AC adapter and power are always present during the factory reset process. User can only power off after seeing OOB on the screen.



Click "Factory Reset" to perform factory reset. Press "OK" to confirm when the dialog box appears. Please note this action clears all data in the internal storage and it is not recoverable.

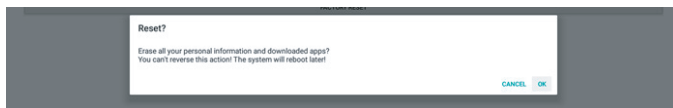

Auto Restart

Auto Restart function allows the device to restart automatically at the time you specify.

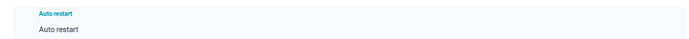

Select Disable/Enable auto restart feature from the Main Switch.

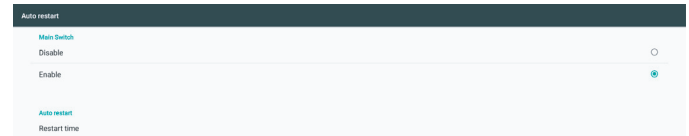

Use the time picker to set auto restart time.



Click "Save" button and the time you set for auto restart will display.

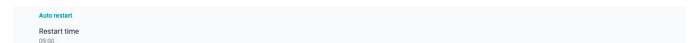

Import & Export

Settings -> Signage Display -> System Tools -> Import & Export

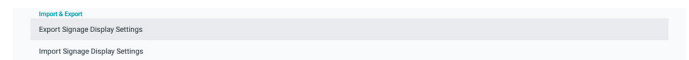

This function allows you to import/export the settings and 3rd party APK from/to other device. Please note that:

- (1).Export data to BDL3152E-clone.zip file under {storage}/philips/clone folder.
- (2).Support old clone files method, and put files under {storage}/philips/sys_backup:
AndroidPDMediaPlayerData.db
AndroidPDPdfData.db
menu_settings.db
settings_global.xml
settings_secure.xml
settings_system.xml
signage_settings.db
Note that latest export data will archive all files into ZIP file.
- (3)."Signage Display Name" will not be imported/exported.

Export Signage Display Settings

System exports database data and third party APKs into {storage}/philips/clone/BDL3152E-clone.zip file of the selected storage (internal storage or USB storage).

Note:

If the selected storage (internal storage and USB) does not contain Philips/folder, then the system will create it automatically.

A list of all available storage (internal storage and USB storage):

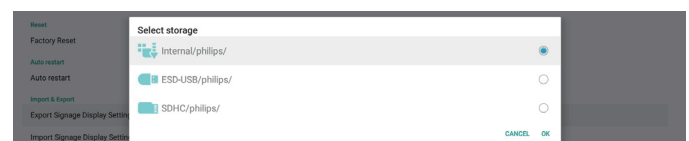

Import Signage Display Settings

Import database data from philips/clone/BDL3152E-clone.zip file of the selected storage (internal Storage, USB import the following

- (1). Import Database in BDL3152E-clone.zip
- (2). Import 3rd party APK in BDL3152E.clone.zip

A list of all available storage (internal storage and USB storage):



A confirmation dialog box is displayed before importing the settings and APKs. Click the "OK" button to start importing the data.

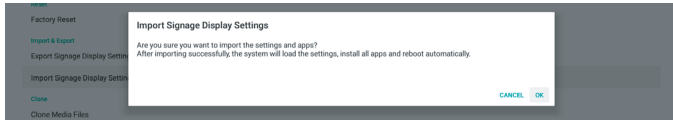

Clone

Settings -> Signage Display -> System Tools -> Clone

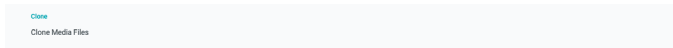

Clone Media Files

This function allows you to copy the media files from the selected source storage to the target storage.

- (1). System clone files are under the following folder:
 - philips/photo
 - philips/music
 - philips/video
 - philips/cms
 - philips/pdf
 - philips/browser

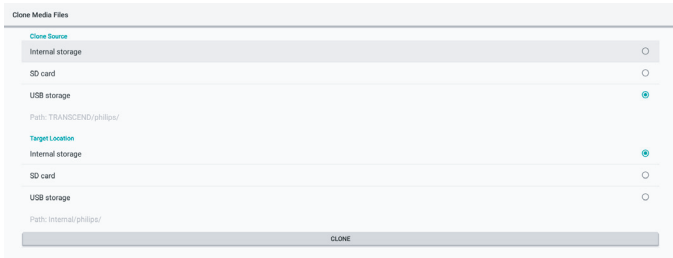

Security

Settings -> Signage Display -> System tools -> Security

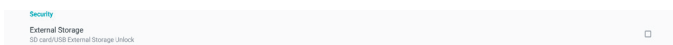

External Storage

Click the checkbox to lock or unlock external storage (USB storage). Default is unlocked.

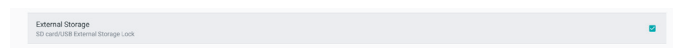

- (1). Unchecked (Disable): USB External Storage Unlock.
- (2). Checked (Enable): USB External Storage Lock.

Note:

When you disable the external storage lock to enable state, please unplug and plugin the external storage again. After that, the system can detect the external storage again.

Admin Password

Settings -> Signage Display -> System tools -> Admin Password.

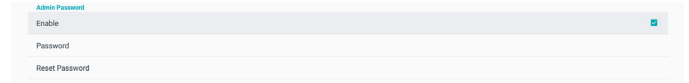

Enable:

If Enable checkbox is not checked, it means the password is empty now.

You can click the checkbox and input the new password.

Note:

The password rule is 6-digits, no consecutive, no repeating numbers.

- Ex: 112233, 123457, 654322 (ok)
- 112233, 123457, 654322 (ok)



- (1) Unchecked: Disable.
- (2) Checked: Enable.

Note:

When enabled, you need a password to login Admin Mode.

Modify Password

User can change the password for logging into Admin Mode. Follow below steps:

- (1) Enter the current password first.



If the current password is not correct, you will see an "Incorrect password" toast message.

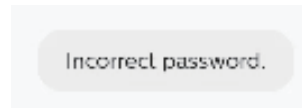

- (2) Enter a new password.



(3) Enter the new password again.

Try again if the new password is not correct.

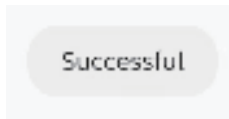

Reset Password

Settings -> Signage Display -> System tools -> Admin Password -> Reset Password.

Password:

Change the password if needed.

Reset Password:

Reset the password. If succeed, you will see a "Successful" toast message.

6.1.2.7. System updates

Local update

Settings -> Signage Display -> System updates -> Local update
The System will automatically search "update.zip" in the root folder of USB disk.

If "update.zip" is found on the external storage, a list will be shown for user to select the file to update.

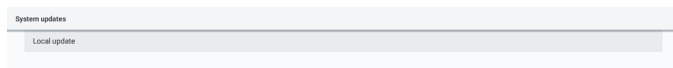

Once the file is selected from the list, the system starts rebooting and updating.

Please note that:

- (1). Do not turn off the power or remove the power adapter until the update is complete.
- (2). Current system only supports full Android update.
- (3). The update file must be named as "update.zip" only.
- (4). The "update.zip" file must be stored in the root folder of your external storage.

6.1.3. Security

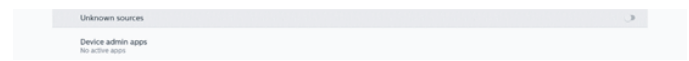

Unknown sources

Enable this option to allow 3rd party application installation.

Device admin apps

Enable or disable the device admin apps.

6.1.4. System

The following options are listed in Settings -> System.

- (1). Keyboard & inputs
- (2). Developer options
- (3). About

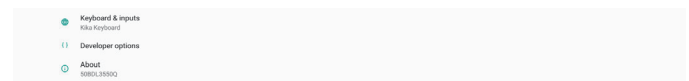

6.1.4.1. About

Settings -> System -> About

View the following information about the system.

- (1). Status
- (2). Legal information
- (3). Model (model name of this device)
- (4). Android version
- (5). Android security patch level
- (6). Kernel version
- (7). Build number (release version)

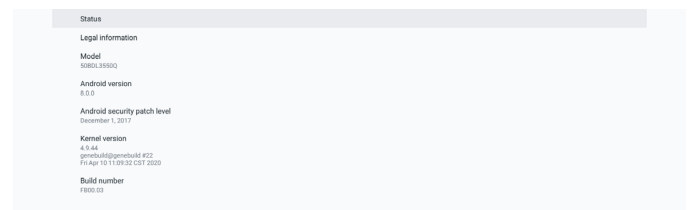

Status

Display device serial number and total time for the device to boot up.

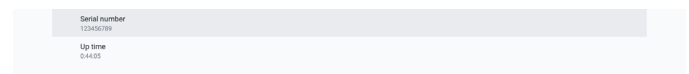

Legal Information

Legal information and licenses of all open source projects will be listed.

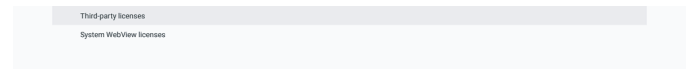

7. OSD Menu

An overview of the On-Screen Display (OSD) structure is shown below. You can use it as a reference for further adjustment of your display.

7.1. Navigating the OSD Menu

7.1.1. Navigating the OSD menu using the display's control buttons

1. Select [] in the floating bar or press setting button on the front control buttons.
2. Press the arrow button to select the item to adjust.

7.2. OSD Menu Overview

7.2.1. Picture menu

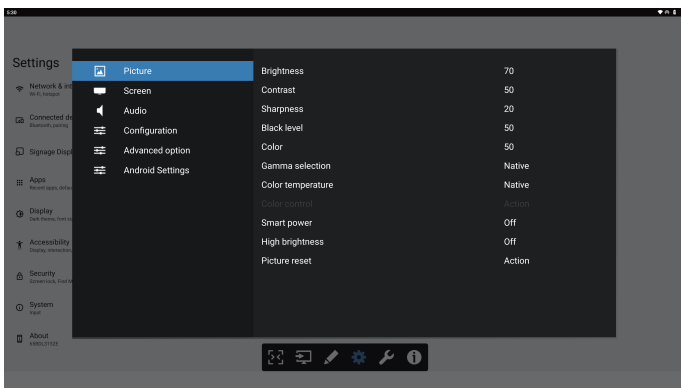

Brightness

Adjust the brightness of this display's backlight.

Contrast

Adjust the contrast ratio for the input signal.

Note: VIDEO source only

Sharpness

This function is digitally capable to keep a distinct image at all times.

Adjust the sharpness of the picture for each picture mode.

Note: VIDEO source only

Black level

Adjust the image brightness for the background.

Note: VIDEO source only. sRGB picture mode is standard and cannot be changed.

Color (Saturation)

Adjust the color of the screen.

Press + button to increase color depth.

Press - button to decrease color depth.

Note: VIDEO source only

Gamma selection

Select a display gamma. It refers to the brightness performance curve of signal input. Choose from {Native} / {2.2} / {2.4} / {s gamma}.

Note: VIDEO source only. sRGB picture mode is standard and cannot be changed.

Color temperature

Adjust the color temperature.

The image becomes reddish as the color temperature decreases, and becomes bluish as the color temperature increases.

Note: VIDEO source only.

Color Control

The color levels of red, green, and blue can be adjusted by the color bars.

R: Red gain, G: Green gain, B: Blue gain.

Smart power

Control lower power consumption based on brightness setting.

- {OFF}: no adaptation
- {MEDIUM}: 80% of power consumption relative to current settings
- {HIGH}: 65% of power consumption relative to current settings

High Brightness

Choose to set High Brightness mode on or off.

Choose (On), the screen brightness will be increased to maximum brightness.

Picture reset

Reset all settings in the Picture menu.

Select "RESET" to restore factory preset data.

Press "CANCEL" button to cancel and then return to the previous menu.

7.2.2. Screen menu

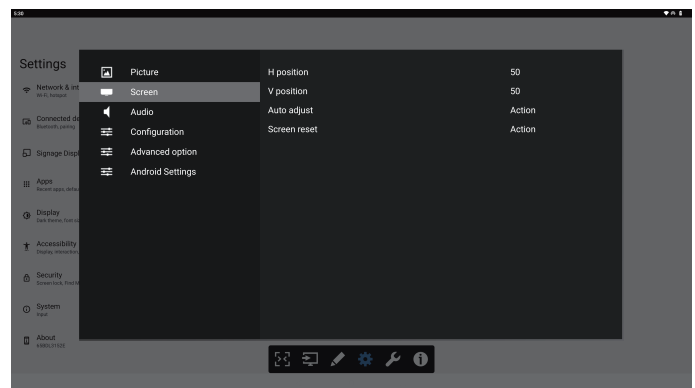

H position

Control Horizontal Image position within the display area of the LCD.

Press + button to move the screen to the right.

Press - button to move the screen to the left.

Note: VGA input only.

V position

Control Vertical Image position within the display area of the LCD.

Press + button to move the screen up.

Press - button to move the screen down.

Note: VGA input only.

Auto adjust

Press "Set" to detect and adjust H position, V position, Clock, Phase automatically.

Note: VGA input only.

Screen reset

Reset all settings in the Screen menu to factory preset values.

7.2.3. Audio menu

Balance

Adjust to emphasize left or right audio output balance.

Treble

Adjust to increase or decrease higher-pitched sounds.

Bass

Adjust to increase or decrease lower-pitched sounds.

Volume

Adjust the volume.

Mute

Turn the mute function on/off.

Audio reset

Reset all settings in the Audio menu to factory preset values.

Speaker Setting

Turn internal speaker {On}/{Off}.

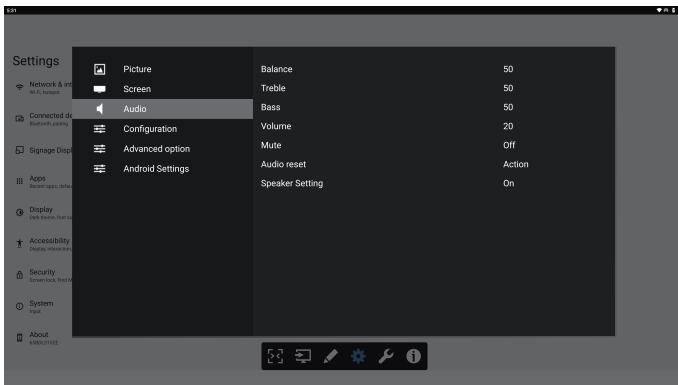

7.2.4. Configuration menu

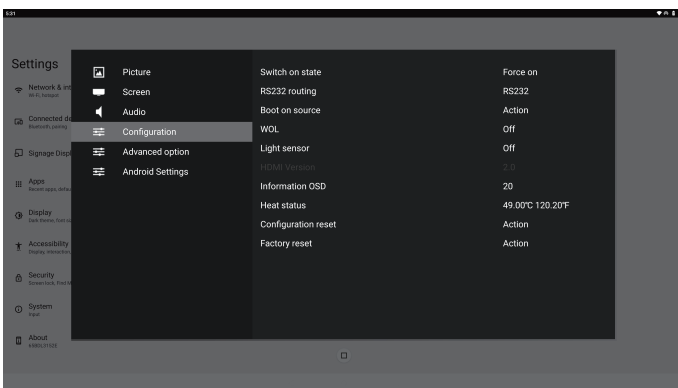

Switch on state

Select the display status when you connect the power cord next time.

- {Power off} - The display will remain off when the power cord is connected.
- {Forced on} - The display will turn on when the power cord is connected.
- {Last status} - The display will return to the previous power status (on/off/standby mode) when the power cord is connected.

RS232 routing

Select RS232 routing path

- {RS232} – RS232 is routed from 2.5mm phone jack
- {OPS RS232} – RS232 is routed from OPS

Boot on source

Choose to select a source when booting up.

- {Input} – Select input source when booting up.
- {Playlist} – Select playlist index for Media Player, Browser. 0 indicates there is no playlist.

Logo

Choose to enable or disable the picture of Logo when turning on your display.

- {Off} – Both static Philips logo and Android boot animation will not be shown.
- {On} – Default value. Both Philips logo and Android boot animation will be shown.
- {User} – Static Philips logo will not be shown, only user-selected boot animation will be shown in Android settings.

Note: Logo will not be rotated even though rotation setting is set.

WOL (Wake on LAN)

Allow the display to be turned on by a network message.

Note: This function only works in power mode 1 and mode 2.

Light sensor

Choose to turn on or off the light sensor function.

Configuration reset

Reset all settings in Configuration 1 menu to factory preset values.

Factory Reset

Reset all customized settings in Picture, Screen, Audio, Configuration 1, Configuration 2 and Advanced Option to the factory default values.

Information OSD

Set the period of time the information OSD display on the upper left corner of the screen. The information OSD will display when input source and signal are changed.

The options are {Off, 1 - 60} seconds.

Heat Status

Current thermal status.

HDMI version

Set the HDMI version to 1.4 or 2.0.

7.2.5. Advanced Option menu

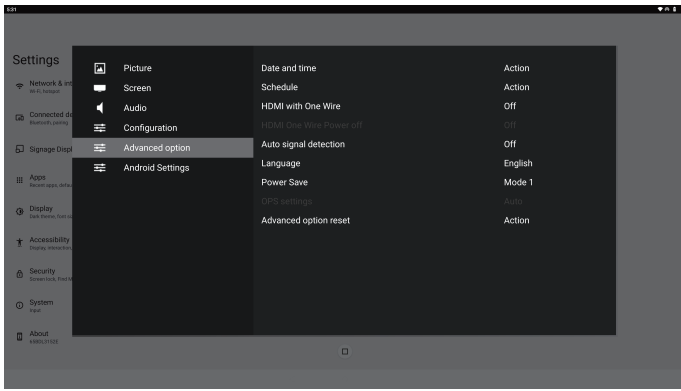

Off timer

Set automatic power off time (in hours).

Date and time

Adjust the current date and time for the display's internal clock.

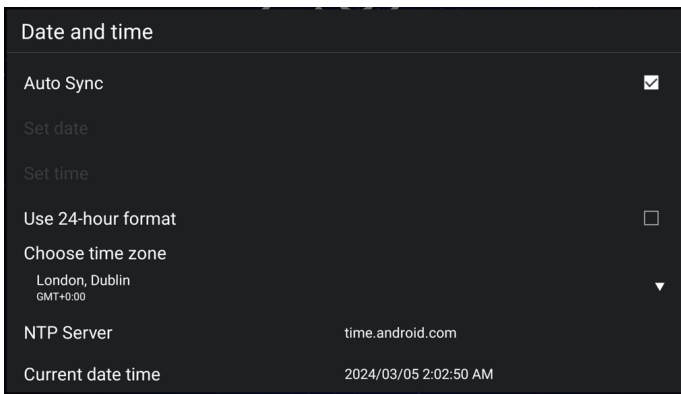

- {Auto Sync} - Auto sync display's clock with NTP server.

Schedule

Allow user setup up to seven different scheduled intervals of display activity.

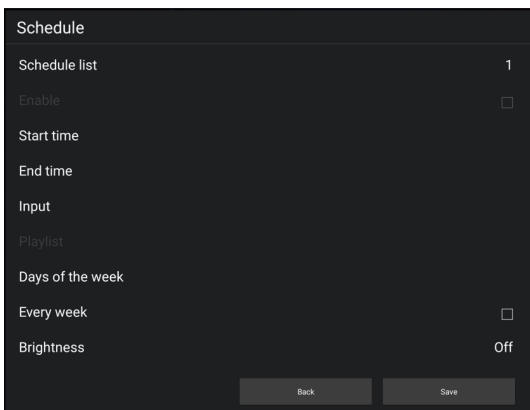

- {Schedule list} – Select 1-7 schedules to edit.
- {Enable} – Enable/disable selected schedule. If time conflict with other schedule or start/end time, input source are empty, user cannot enable this schedule.
- {Start time} – Set start time.
- {End time} – Set end time.
- {Input} – Set input source, system will go to selected source automatically at start time.
- {Play list} – Set playlist 1-7 for Media Player and Browser sources.
- {Days of the week} – Set Sunday, Monday, Tuesday, Wednesday, Thursday, Friday and Saturday.
- {Every week} – Set lifecycle.
- {Back} – Cancel and do not change schedule data.
- {SAVE} – Save schedule data.

HDMI with One Wire

Enable or disable HDMI CEC.

HDMI One Wire Power Off

Allow user to set multiple devices to standby mode by pressing the power button. This function is only available when HDMI CEC is enabled.

Auto signal detection

OPTION:

{Off}, {All}, {Failover}

{Off}: Disable Auto signal detection

{All}: HDMI1 -> HDMI2 -> HDMI3* -> TYPE-C* -> VGA* -> OPS* -> Media Player -> Browser -> Kiosk -> Custom -> Home

* Not all modules have all sources in this list. DVI can be DVI-I or DVI-D

* Media Player, Browser will only try playlist index 1

{Failover}:

Failover 1: Home (default)

Failover 2: Home (default)

Failover 3: Home (default)

Failover 4: Home (default)

Failover 5: Home (default)

Failover 6: Home (default)

Failover 7: Home (default)

Failover 8: Home (default)

Failover 9: Home (default) *

Failover 10: Home (default) *

Failover 11: Home (default) *

* Not all modules have all 11 failover list, depends on total source of module

Language

Select the language used in the OSD menu.

The options are: English/Deutsch/ 简体中文 /Français/Italiano/ Español/Русский/PolSKI/Türkçe/ 繁體中文 / 日本語 /Português/ العربية/ Danish/Swedish/Finnish/Norwegian/Dutch/Czech/ Lithuanian/Latvian/Estonian.

Power Save

Mode 1 [TCP off, WOL on, auto off]

Mode 2 Not support

Mode 3 [TCP on, WOL off, auto on/off]

Mode 4 [TCP on, WOL off, no auto on/off]

Power Save	RCU Power Button Off	No Signal	WOL	Android (ARM)
Mode 1	DC OFF	DC OFF	V	ARM off
Mode 3	Backlight OFF	when signal is back, system wake up	X	ARM on
Mode 4	Backlight OFF	Backlight always on, show no signal	X	ARM on

Power mode	Mode 1	Mode 3, Mode 4
DC off	System shutdown	1. Media Player, Browser, PDF Player will close. 2. Android system goes to default black launcher.
DC on	System boot up	Android system reboot. If Logo settings is off, system directly turn backlight on without rebooting.

OPS settings

Set the OPS configuration under each power condition.

- {Auto} - After selecting {Card OPS} for video source input, the OPS will be set to off when the display power is set to off, or vice versa. If you set to other video source inputs, the OPS will always be set to on.
- {Always off} - The OPS will always be set to off.
- {Always on} - The OPS will always be set to on.

Advanced option reset

Reset all settings except {Date and Time} in the advanced option menu to factory preset values.

7.3. Android Settings

Open Android Settings

1. When enabled admin password from Android Setting -> System tools, it must enter the password before entering the android settings.

7.4. ANNOTATION

Annotation mode can be activated in any interface, supporting multi-page annotations, allowing you to record fleeting inspirations at any time. You can freely write, draw, and sketch.

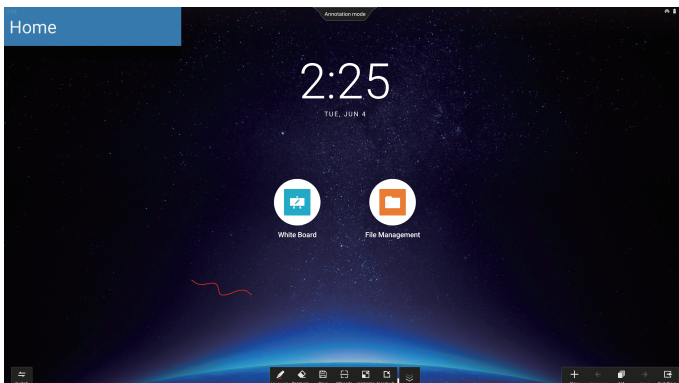

7.5. Whiteboard

7.5.1. Main page

The whiteboard page is mainly divided into four sections: the toolbar at the bottom center, the menu bar on the bottom left, the page management bar on the bottom right, and the whiteboard canvas editing area in the middle.

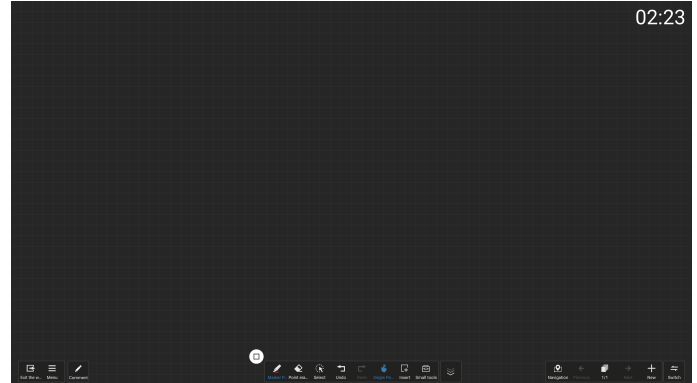

7.5.2. WHITEBOARD MENU

- New: Click to create a new whiteboard file.
- Open: Access file manager, focus on the whiteboard folder, and select any whiteboard file to open.
- Save: Click to save the whiteboard file locally by default, or switch to saving it to a USB drive.

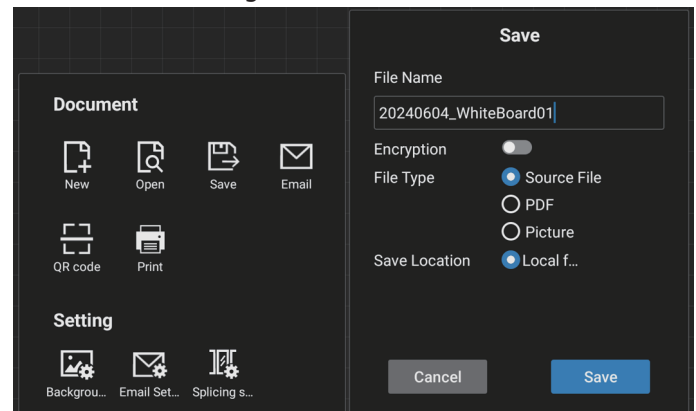

- QR Code: Click to reveal a QR code that allows mobile devices to scan and take away the whiteboard file.
- Email: By default, choose the public sender email address for email delivery; if opting for a custom sending email, it requires setting up the sender's email address, email password/authorization code, SMTP server address, port number, and encryption method before selecting the sender for email delivery. Supports sending to up to 10 recipients at once.

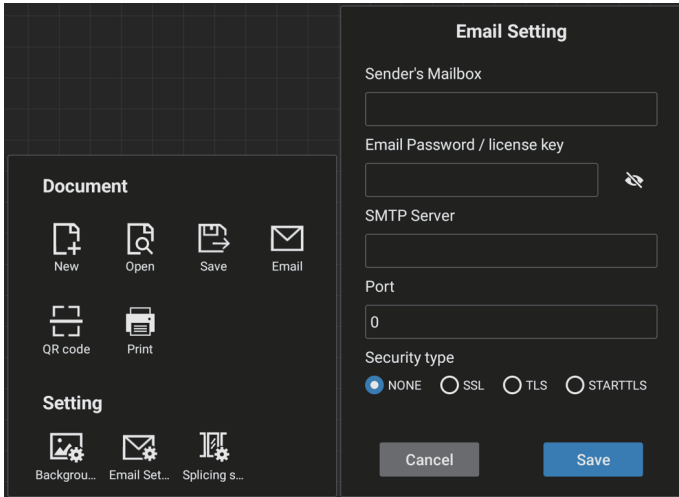

- **Print:** Click to generate a print file and proceed to the preview interface. From there, select an available printer, and execute the printing task.
- **Email Setting:** Input the sender's email address, email password/authorization code, SMTP server address, port number, and encryption method. Once these settings are configured, you will be able to send custom emails.
- **Background:** Click to set the canvas color and texture, and also allows for customizing the background.

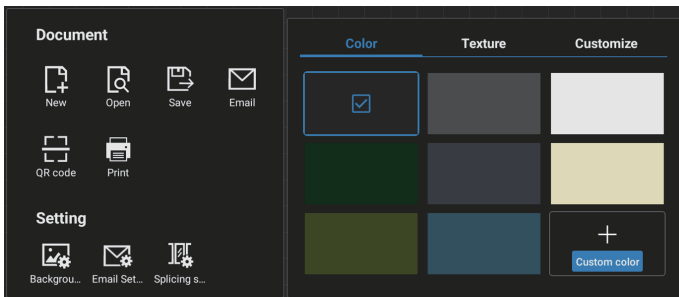

- **Splicing setting**

Through protocol extensions to integrate the functions of multiple IWB devices, we have created an interactive meeting scenario featuring multi-screen splicing, offering a novel multi-screen whiteboard writing experience. This innovation provides enlarged display space for meetings, more versatile display configurations, and more efficient content presentation, thereby empowering enterprises to conduct highly immersive and productive office meetings.

- **Write Setting:** Supports both 2-color stylus writing and 4-color stylus writing.
Note: The 2-color stylus is standard, while the 4-color stylus is optional.
- **Exit:** Click to exit the whiteboard.
- **Annotation:** Switch to Annotations.

7.5.3. WRITING

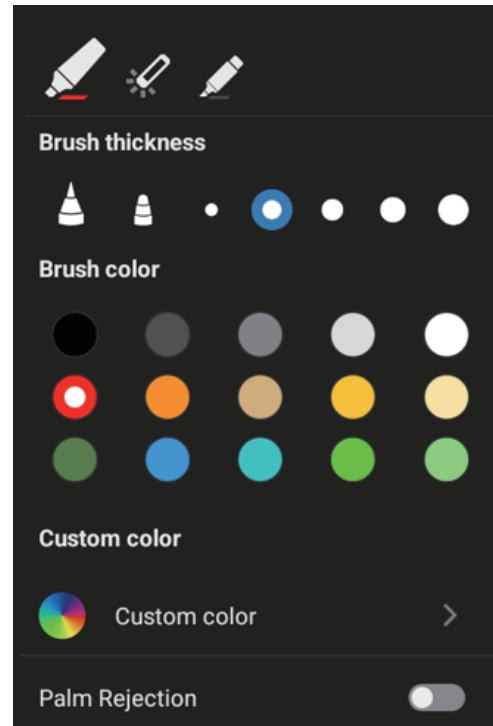

- **New:** Click to create a new whiteboard file.
- **Brush Thickness:** You can switch among different brush thickness options (there are a total of 5 thickness sizes available) for whitening on the whiteboard.
- **Brush Color:** You can switch among different brush colors or customize colors for writing on the whiteboard.
- **Type:** Support Marker Pen, Laser Pen and Highlighter pen as the writing pen.

7.5.4. ERASING

Depending on the size of the erasure area, different erasure methods can be selected or a one-click clear screen can be used.



7.5.5. SELECT

Click on "Select" to encircle and select objects. Once selected, you can perform operations such as changing layers, moving, or deleting them. The operations vary depending on the selected type.

7.5.8. NAVIGATION MAP

With the whiteboard navigation map, you can gain an overview of the entire whiteboard canvas and easily navigate to different areas within it.

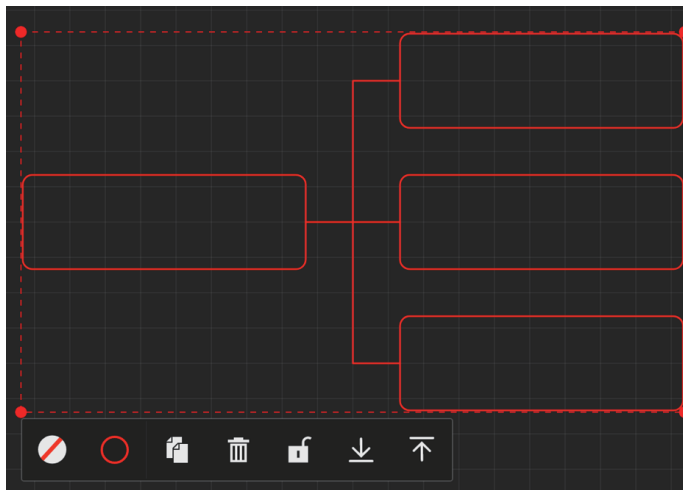
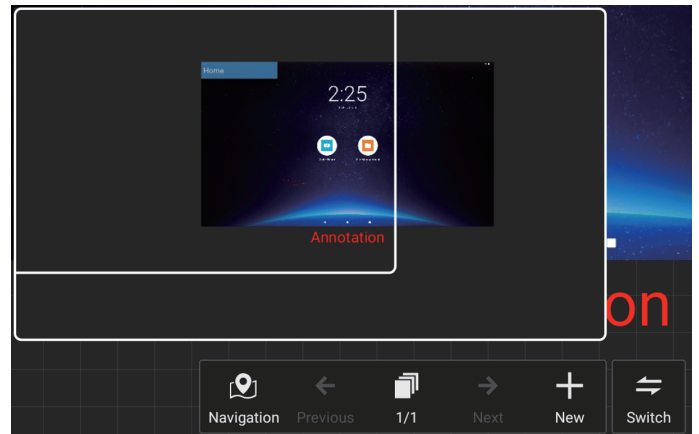

7.5.6. PAGE MANAGEMENT

Manage Whiteboard Pages where you can perform operations such as creating new pages, switching between them, and previewing whiteboard pages.

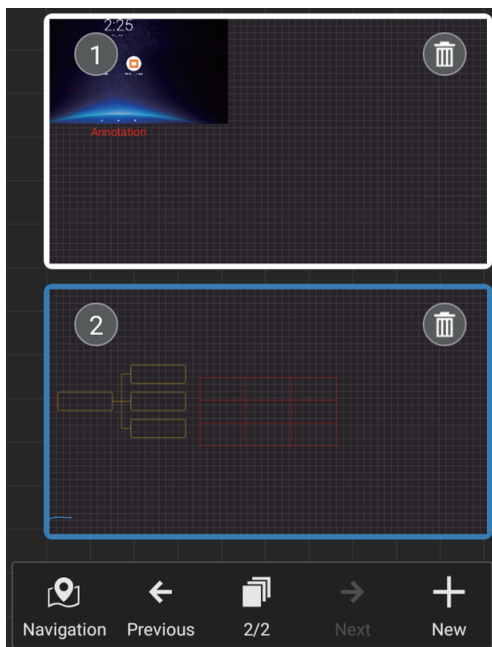

7.5.9. SAVE & TAKE AWAY VIA QR CODE

Two storage methods are supported: local/USB and also taking away via scanning QR code with a mobile phone.

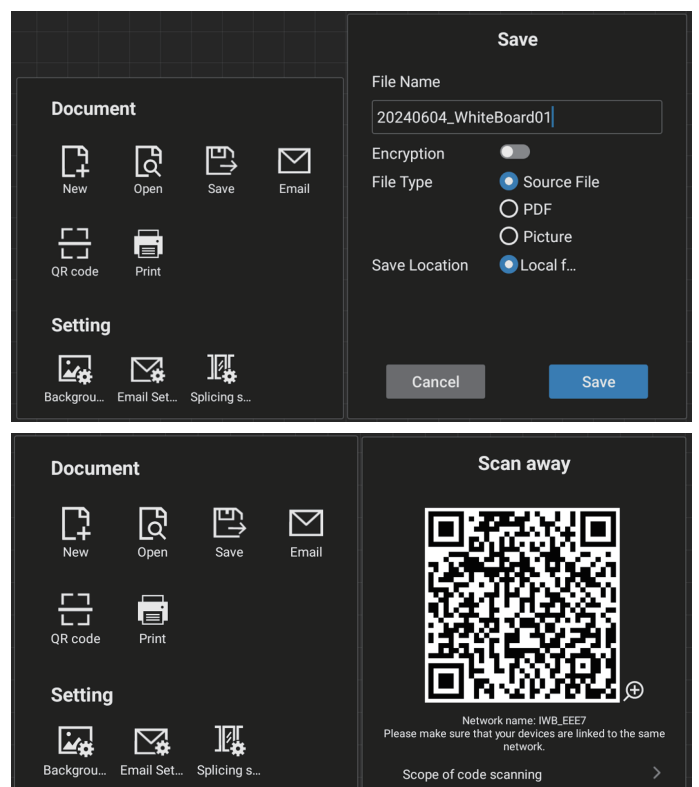

7.5.7. Inserting Documents

Supports inserting PDF documents.



7.5.10. MIND MAP

The whiteboard supports inserting mind maps.

Entry: Open any whiteboard -> Whiteboard Toolbar -> Insert -> Mind Map.

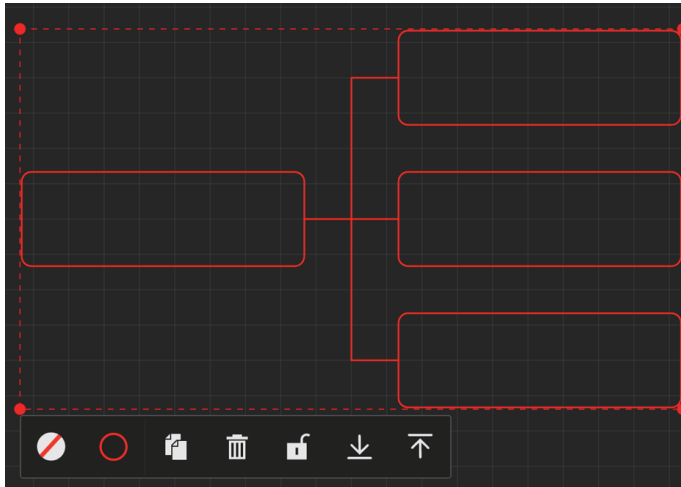

7.5.11. SMART TABLE

The whiteboard supports inserting smart tables.

Entry: Open any whiteboard - [Whiteboard Toolbar] - [Insert] - [Smart Table].

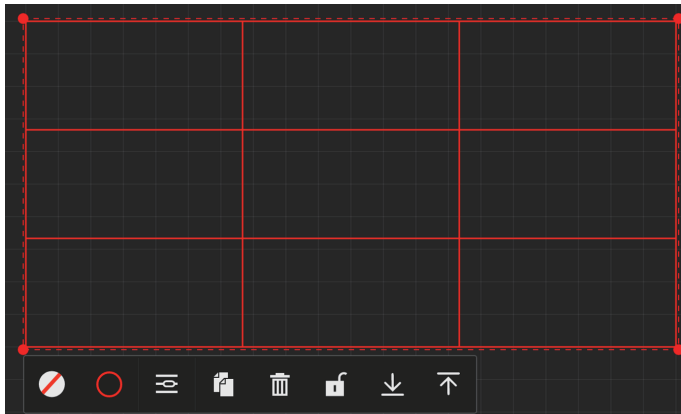

7.5.12. SMALL TOOLS

The whiteboard comes with a convenient toolbox, allowing you to swiftly and easily access the small tools you need from the toolbox while writing on the whiteboard.

Operating Instructions

- Entry: Open any whiteboard - [Whiteboard Toolbar] - [Small tools].

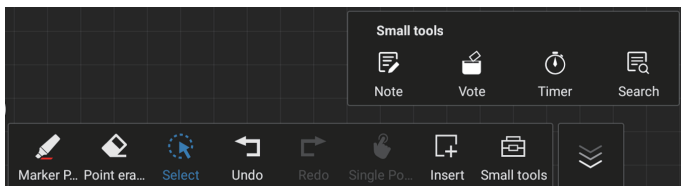

- The small tools include: Note, Vote, Timer, and Search. You can easily access and use the widgets you need within the whiteboard at any time.

7.6. FILE MANAGEMENT

- Entry: Click on the "Applications" - "File Management" icon to enter the file manager page.

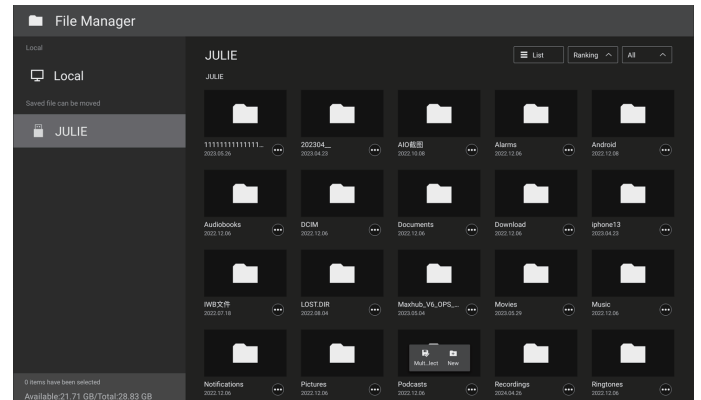

- Storage Path Selection: Divided into Local and Removable Storage.
- Operation Management: Long-press on a file (or folder) to show folder selection boxes, enabling you to select files (or folders) for copying, pasting, cutting, deleting, or renaming.

8. Supported Media Formats

USB Multimedia Formats

Video format		
Video Codec	Resolution	Bit Rate
MPEG1/2	1080P@30fps	40Mbps
MPEG4	1080P@30fps	40Mbps
H.263	1080P@30fps	40Mbps
H.264	4K2K@60fps	135Mbps
H.265	4K2K@60fps	100Mbps
VP8	1920x1080@30fps	50Mbps

Audio format			
Audio Codec	Sampling Rate:	Channel	Bit Rate
MPEG1/2/2.5 Layer3	8KHz-48KHz	2	8Kbps-320Kbps
MPEG1/2 Layer1	16KHz-48KHz	2	32Kbps-448Kbps
MPEG1/2 Layer2	16KHz-48KHz	2	8Kbps-384Kbps
AAC, HEAAC	8KHz-48KHz	5.1	AAC-LC: 12Kbps-576Kbps V1:6Kbps-288Kbps V2:3Kbps-144Kbps

Photo format	
Image	Resolution
JPEG	3840 x 2160
PNG	3840 x 2160
BMP	3840 x 2160

NOTES:

- Sound or video may not work if the contents have a standard bit rate/frame rate above the compatible Frame/sec listed in the table above.
- Video content with a Bit rate or Frame rate larger than the rate specified in the table above can cause choppy video during playback.

9. Input Mode

Timing support:

Item	Resolution	H.Freq. (KHz)	V.Freq. (Hz)
1	720x400 @70Hz DOS	31.469	70.087
2	640x480 @60Hz DMT	31.469	59.94
3	640x480 @67Hz MAC	35	66.667
4	640x480 @75Hz DMT	37.5	75
5	800x600 @60Hz DMT	37.879	60.317
6	832x624 @75Hz MAC	49.725	74.5
7	1024x768 @60Hz DMT	48.363	60.004
8	1152x870 @75Hz MAC	68.681	75.062
9	1280x720 @60Hz CVT16:9	44.772	59.855
10	1280x1024 @60Hz DMT	63.981	60.02
11	1440x900 @60Hz CVT16:10 R	55.469	59.901
12	1440x900 @60Hz CVT16:10	55.935	59.887
13	1600x900 @60Hz	60	60
14	1680x1050 @60Hz CVT16:9 R	64.674	59.883
15	1680x1050 @60Hz CVT16:9	65.29	59.954
16	1920x1080 @60Hz CVT-RB / XBOX360	66.7	60
17	1920x1080 @60Hz DMT-RB	67.5	60
18	480i@60Hz	15.734	59.94
19	480P@60Hz	31.469	59.94
20	720P@60Hz	44.955	59.94
21	1080I@60Hz	33.716	59.94
22	1080P@60Hz	67.433	59.94
23	576i@50Hz	15.625	50
24	576P@50Hz	31.25	50
25	720P@50Hz	37.5	50
26	1080I@50Hz	28.125	50.08
27	1080P@50Hz	56.25	50
28	3840x2160@30	67.5	30
29	3840x2160@60	135	60

- The PC text quality is optimum in UHD mode (3840 x 2160, 60Hz).
- Your PC display screen might appear different depending on the manufacturer (and your particular version of Windows).
- Check your PC instruction book for information about connecting your PC to a display.
- If a vertical and horizontal frequency-select mode exists, select 60Hz (vertical) and 31.5KHz (horizontal). In some cases, abnormal signals (such as stripes) might appear on the screen when the PC power is turned off (or if the PC is disconnected). If so, press the [INPUT] button to enter the video mode. Also, make sure that the PC is connected.
- When horizontal synchronous signals seem irregular in RGB mode, check PC power saving mode or cable connections.
- The display settings table complies to the IBM/VESA standards, and based on the analog input.
- The DVI support mode is regarded as same to the PC support mode.
- The best timing for the vertical frequency to each mode is 60Hz.
- In UHD mode (3840 x 2160, 60Hz), Pixel Rate HDMI:594 , TYPE-C:533.25.

10. Pixel Defect Policy

We strive to deliver the highest quality products and use some of the industry's most advanced manufacturing processes whilst practicing stringent quality control. However, pixel or sub-pixel defects on the PDP / TFT panels used in Plasma- & LCD- displays are sometimes unavoidable. No manufacturer can guarantee that all panels will be free from pixel defects, but Philips guarantees that any Plasma- & LCD- displays with an unacceptable number of defects will be repaired during the warranty period in line with your local guarantee conditions.

This notice explains the different types of pixel defects and defines the acceptable defect level for the LCD screen. In order to qualify for repair under warranty, the number of pixel defects must exceed a certain level as shown in the reference table. If the LCD screen is within specification a warranty exchange / claim back will be refused. Additionally, because some types or combinations of pixel defects are more noticeable than others, Philips sets even higher quality standards for those.

10.1. Pixels and Sub-Pixels

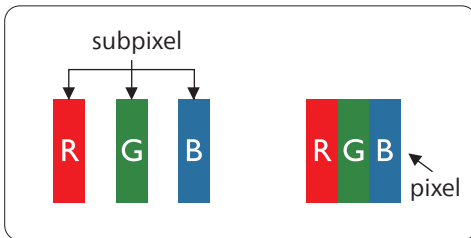

A pixel, or picture element, is composed of three sub-pixels in the primary colors of red, green and blue. Many pixels together form an image. When all sub-pixels of a pixel are lit, the three colored sub-pixels together appear as a single white pixel. When all are dark, the three colored sub-pixels together appear as a single black pixel. Other combinations of lit and dark sub-pixels appear as single pixels of other colors.

10.2. Types of Pixel Defects + Dot Definition

Pixel and sub-pixel defects appear on the screen in different ways. There are three categories of pixel defects and several types of sub-pixel defects within each category.

Dot definition = What is a defective "Dot"?:

One or more defective, adjacent sub-pixel are defined as one "dot". The no. of defective sub-pixels are not relevant to define a defective dot. This means that a defective dot can consist of one, two or three defective sub-pixels which can be dark or lit.

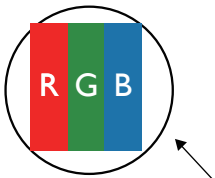

One dot = One Pixel; consists of three sub-pixels of Red, Green, and Blue.

10.3. Bright Dot Defects

Bright dot defects appear as pixels or sub-pixels that are always lit or "on". These are the examples of bright dot defects:

<p>One lit red, green or blue sub pixel</p>	<p>Two adjacent lit sub pixels: Red + Blue = Purple Red + Green = Yellow Green + Blue = Cyan (Light Blue)</p>	<p>Three adjacent lit sub pixels (one white pixel)</p>

10.4. Dark Dot Defects

Black dot defects appear as pixels or sub-pixels that are always dark or "off". These are the examples of black dot defects:

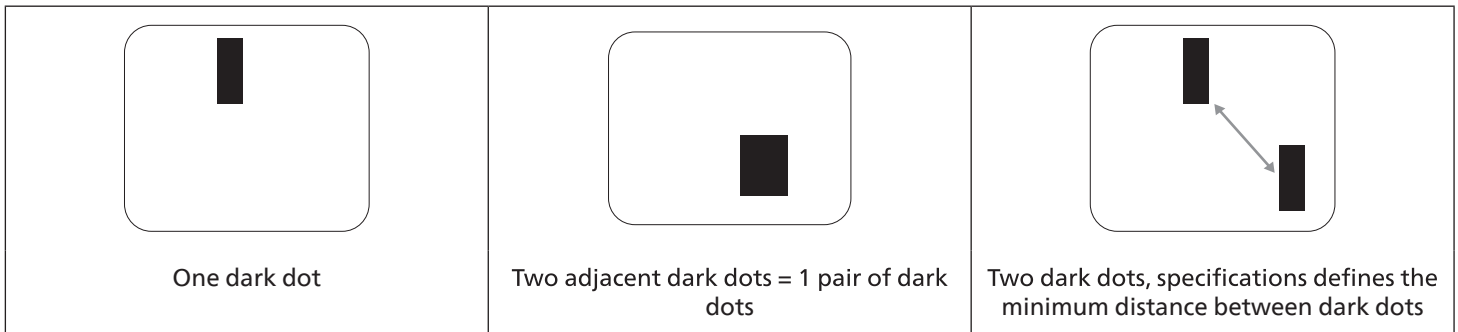

10.5. Proximity of Pixel Defects

Because pixel and sub-pixels defects of the same type that are nearby one another may be more noticeable, Philips also specifies tolerances for the proximity of pixel defects. In the table below you can find specifications about:

- Allowed amount of adjacent dark dots = (adjacent dark dots = 1 pair of dark dots)
- Minimum distance between dark dots
- Total no. of all defective dots

10.6. Pixel Defect Tolerances

In order to qualify for repair due to pixel defects during the warranty period, a PDP / TFT panel in a Philips Plasma / LCD- display must have pixel or sub-pixel defects exceeding the tolerances listed in the following table.

BRIGHT DOT EFFECT	ACCEPTABLE LEVEL
1 lit sub pixel	2
BLACK DOT EFFECT	ACCEPTABLE LEVEL
1 dark sub pixel	10
TOTAL DOT DEFECTS OF ALL TYPES	12

Note: * 1 or 2 adjacent sub pixel defects = 1 dot defect

10.7. MURA

Dark spots or patches may occasionally appear on some liquid crystal display (LCD) panels. This is known within the industry as Mura, which is a Japanese term for "unevenness." It is used to describe an irregular pattern or area in which uneven screen uniformity appears under certain conditions. Mura is a result of the deterioration of the liquid crystal alignment layer and is most commonly caused by long-term operation under high ambient temperatures. It is an industry- wide phenomenon and Mura is not repairable. It is also not covered by our warranty terms.

Mura has been around since the introduction of LCD technology and with screens getting bigger and in operation 16/7, many displays are running in low light conditions. This all adds to the possibility of Mura affecting displays.

HOW TO SPOT MURA

There are many symptoms of Mura and also multiple causes. Several of these are listed below:

- Impurities or foreign particles in the crystal matrix
- Uneven distribution of LCD matrix during manufacturing
- Non-uniform luminance distribution of the backlight
- Panel assembly induced stress
- Flaws within the LCD cells
- Thermal induced stress - high temperature operation over long periods of time

HOW TO AVOID MURA

Although we can not guarantee the complete eradication of Mura every time, in general the appearance of Mura can be minimized by these methods:

- Lower the backlight brightness
- Use a screen saver
- Reduce the ambient temperature around the unit

11. Cleaning and Troubleshooting

11.1. Cleaning

Caution When Using the Display

- Do not bring your hands, face or objects close to the ventilation holes of the display. The top of the display is usually very hot due to the high temperature of exhaust air being released through the ventilation holes. Burns or personal injuries may occur if any body parts are brought too close. Placing any object near the top of the display could also result in heat related damage to the object as well as the display itself.
- Be sure to disconnect all cables before moving the monitor. Moving the monitor with its cables attached may damage the cables and thus cause fire or electric shock.
- Disconnect the power plug from the wall outlet as a safety precaution before carrying out any type of cleaning or maintenance procedure.

Front Panel Cleaning Instructions

- The front of the display has been specially treated. Wipe the surface gently using only a cleaning cloth or a soft, lint-free cloth.
- If the surface becomes dirty, soak a soft, lint-free cloth in a mild detergent solution. Wring the cloth to remove excess liquid. Wipe the surface of the display to remove dirt. Then use a dry cloth of the same type to dry.
- Do not scratch or hit the surface of the panel with fingers or hard objects of any kind.
- Do not use volatile substances such as insert sprays, solvents and thinners.

Cabinet Cleaning Instructions

- If the cabinet becomes dirty, wipe the cabinet with a soft, dry cloth.
- If the cabinet is extremely dirty, soak a lint-free cloth in a mild detergent solution. Wring the cloth to remove as much moisture as possible. Wipe the cabinet. Use another dry cloth to wipe over until the surface is dry.
- Do not use solution that contains oil to clean the plastic parts. Such product damage the plastic parts and void the warranty.
- Do not allow any water or detergent to come into contact with the surface of the display. If water or moisture gets inside the unit, operating problems, electrical and shock hazards may result.
- Do not scratch or hit the cabinet with fingers or hard objects of any kind.
- Do not use volatile substances such as insert sprays, solvents and thinners on the cabinet.
- Do not place anything made from rubber or PVC near the cabinet for any extended periods of time.

11.2. Troubleshooting

Symptom	Possible Cause	Remedy
No picture is displayed	<ol style="list-style-type: none"> 1. The power cord is disconnected. 2. The main power switch on the back of the display is not switched on. 3. The selected input has no connection. 4. The display is in the standby mode. 	<ol style="list-style-type: none"> 1. Plug in the power cord. 2. Make sure that the power switch is switched on. 3. Connect a signal connection to the display.
Interference displayed on the display or an audible noise is heard	Caused by surrounding electrical appliances or fluorescent lights.	Move the display to another location to see if the interference is reduced.
Color is abnormal	The signal cable is not connected properly.	Make sure that the signal cable is attached firmly to the back of the display.
Picture is distorted with abnormal patterns	<ol style="list-style-type: none"> 1. The signal cable is not connected properly. 2. The input signal is beyond the capabilities of the display. 	<ol style="list-style-type: none"> 1. Make sure that the signal cable is attached firmly. 2. Check the video signal source to see if it is beyond the range of the display. Please verify its specifications with this display's specification section.
Display image doesn't fill up the full size of the screen	<ol style="list-style-type: none"> 1. The zoom mode is not set correctly. 2. Scan Mode may be set incorrectly to underscan. 3. If the image exceeds the screen size, Scan Mode may need to be set to Underscan. 	Use the Zoom mode or Custom zoom function in the Screen menu to fine tune display geometry and time frequency parameter.
Can hear sound, but no picture	Source signal cable is connected improperly.	Make sure that both video inputs and sound inputs are correctly connected.
Can see picture but no sound is heard	<ol style="list-style-type: none"> 1. Source signal cable is connected improperly. 2. Volume is turned all the way down. 3. {Mute} is turned on. 4. No external speaker is connected. 	<ol style="list-style-type: none"> 1. Make sure that both video inputs and sound inputs are connected correctly. 2. Press [+] or [-] button to hear sound. 3. Switch MUTE off by using the [MUTE] button. 4. Connect external speakers and adjust the volume to a suitable level.
Some picture elements do not light up	Some pixels of the display are off.	This display is designed using an extremely high level of precision technology, however, sometimes some pixels of the display may not display. This is not a malfunction.
After-Images can still be seen on the display after the display is powered off. (Examples of still pictures include logos, video games, computer images, and images displayed in 4:3 normal mode)	A still picture is displayed for an over extended period of time	Do not allow a still image to be displayed for an extended period of time as this can cause a permanent after-image to remain on the display.

12. Technical Specifications

Display:

Item	Specifications		
	65BDL3152E	75BDL3152E	86BDL3152E
Screen Size (Active Area)	163.9 cm / 65 inches	189.3 cm / 75 inches	217.4 cm / 86 inches
Aspect Ratio	16:9	16:9	16:9
Resolution	0.372 (H) x 0.372(V) [mm]	0.42975 (H) x 0.42975 (V) [mm]	0.4935 (H) x 0.4935(V) [mm]
Pixel pitch	3840 (H) x 2160 (V)	3840 (H) x 2160 (V)	3840 (H) x 2160 (V)
Displayable colors	1.07B(10bit)	1.07B(10bit)	1.07B(10bit)
Brightness (typical)	400 cd/m ²	400 cd/m ²	400 cd/m ²
Contrast ratio (typical)	5000:1	5500:1	5000:1
Viewing angle	178° (H/V)	178° (H/V)	178° (H/V)

In/Out Terminals:

Item		Specifications
Speaker Output	Internal Speakers	16W(L)+16W(R)[RMS]/6Ω 78dB/W/M/260Hz-20KHz
Audio Output	3.5mm phone jack x 1	0.5V [rms] (Normal) / 2Channel (L+R)
Audio Input	3.5mm phone jack x 1	0.5V [rms] (Normal) / 2Channel (L+R)
RS232	DB9	RS232
RJ-45	RJ-45 jack x2	10M/100M/1000Mbps LAN port
HDMI Input	HDMI jack x3 (Type A) (19 pin)	Digital RGB: TMDS (Video + Audio) MAX: Video-3840x2160/60Hz
VGA Input	DB15	MAX:1920x1080/60Hz(FHD)
USB-B	USB-B x 2	Connect touch function to external PC
USB Input	USB3.0 TypeA x 4 USB2.0 TypeA x 1	USB3.0/2.0,Multimedia play and service port USB2.0: 5V $\overline{=}$ 0.5A;USB3.0: 5V $\overline{=}$ 0.9A
USB3.1 C	Type C: 65W (Front)	Power Delivery: 5V/3A , 9V/3A , 15V/3A , 20V/3.25A Type C: 20V $\overline{=}$ 3.25A

General:

Item	Specifications		
	65BDL3152E	75BDL3152E	86BDL3152E
Power Input	100 - 240V~, 50/60Hz	100 - 240V~, 50/60Hz	100 - 240V~, 50/60Hz
Power Consumption (typ.)	140 W	155 W	180 W
Power Consumption (Max)	410 W	425 W	445 W
Power Consumption (Standby mode & Off mode)	≤0.5 W	≤0.5 W	≤0.5 W
AC Switch Off Mode (W)	0 W	0 W	0 W
Dimensions (Without Stand) [W x H x D]	1488.4 × 896.6 × 86.2 mm	1709.4 × 1020.2 × 85.4 mm	1957 × 1159.9 × 95.5 mm
Weight (Without Stand)	35.45 kg	51.4 kg	59.2 kg
Gross Weight (Without Stand)	47.00 kg	62.5 kg	75.0 kg

Environmental Condition:

Item		Specifications
Temperature	Operational	0 - 40°C
	Storage	-20 - 60°C
Humidity	Operational	10 - 90% RH
	Storage	10 - 90% RH
Altitude	Operational	Below 5000 meters

Note: This IWB device does not support rotation function.

Warranty policy for Philips Professional Display Solutions

Thank you for purchasing this Philips product. Philips products are designed and manufactured with high standards and deliver high quality performance, ease of use and ease of installation. If you encounter any difficulties while using your product, we recommend that you first consult the user manual or the information in the support section of the website, where (depending on the product type) you may find a downloadable user manual, frequently asked questions, instruction videos or a support forum.

LIMITED WARRANTY

In the unlikely event the product requires service, we will arrange for your Philips product to be serviced free-of-charge within the warranty period, provided that the product was used in accordance with the user manual (e.g. in the intended environment).

For these product categories, a partner company of Philips is the warrantor of the product. Please check the documentation supplied with your product.

WHO IS COVERED?

Your Warranty coverage begins from the first date of purchase of the product. You need to provide proof of purchase to receive warranty service. A valid sales receipt or other valid document showing that you purchased the product is considered proof of purchase.

WHAT IS COVERED?

If any defect due to faulty materials and/or workmanship occurs within the warranty period, we will make arrangements for a free of charge service. Where a repair is not possible or not commercially viable, we may replace the product with a new or equivalent refurbished product with similar functionality. Replacement will be offered at our discretion and the warranty will continue from the date of original purchase of the first date of purchase of the product. Please note that all parts, including repaired and replaced parts, are covered only for the duration of the original warranty period.

WHAT IS EXCLUDED? Your warranty does not cover:

- Consequential damages (including but not limited to loss of data or loss of income), nor compensation for activities done by yourself, such as regular maintenance, installing firmware updates or saving or restoring data (Some states do not allow the exclusion of incidental or consequential damages, so the above exclusion may not apply to you. This includes, but is not limited to, prerecorded material, whether copyrighted or not copyrighted.)
- Labor charges for installation or setup of the product, adjustment of customer controls on the product, and installation or repair of various types of external devices (e.g., WiFi, antenna, USB dongles, OPS type devices) and other systems outside of the product.
- Reception problems caused by signal conditions or cable or antenna systems outside the unit.
- A product that requires modification or adaptation to enable it to operate in any country other than the country for which it was designed, manufactured, approved and/or authorized, or repair of products damaged by these modifications.
- If the model or production number on the product has been altered, deleted, removed or made illegible.

The warranty applies on condition that the product has been handled properly for its intended use and in accordance with the operating instructions

To Obtain Warranty Service And Information

For detailed warranty coverage information and additional support requirement and help line, please contact the seller and/or system integrator you purchased the product from. Please note in the USA, this limited warranty is only valid for Products purchased in the Continental United States, Alaska, and Hawaii.

Before Requesting Service

Please check your user's manual before requesting service. Adjustments of the controls discussed there may save you a service call.

WARRANTY PERIOD

Warranty period for PHILIPS signage display is listed as below, for areas not covered in this table, please follow their warranty statement.

Standard warranty period for PHILIPS signage display is listed as below, for areas not covered in this table, please follow the local warranty statement.

Region	Standard Warranty Period
USA, Canada	3 years
China	1 year
Japan	3 years
Rest of world	3 years
Mexico	3 years
Brazil	3 years
Chile	3 years
Peru	3 years

Note that for professional products, the specific warranty terms of the sale- or purchase agreement may apply.

Index

A

AC Switch Cover 22
Android Settings 51

C

Change Picture Format 28
Cleaning and Troubleshooting 56
CMND & Play 32
Connecting a PC 23
Connecting Audio Equipment 24
Connecting External Equipment 23
Connecting External Equipment (Multimedia Player) 23
Connecting Multiple Displays in a Daisy-chain
Configuration 24
Control Panel 14

H

Handling the remote control 16

I

Input Mode 53
Input/Output Terminals 15
Inserting the batteries in the remote control 16
Installation Notes 12
IR connection 25
IR Pass-through Connection 25

L

Launcher 28

M

Media Player 29
Mounting on a Wall 13

N

Navigating the OSD Menu 46

O

Operating range of the remote control 16
Operation 28
OSD Menu 46
OSD Menu Overview 46

P

Package Contents 12
Parts and Functions 14
Pixel Defect Policy 54

R

Remote Control 17

S

Safety Instructions 1
Settings 34
Setting UI 34
Side Bar 33
Supported Media Formats 52

T

Technical Specifications 59
Touch Operation 26

U

Unpacking 10
Unpacking and Installation 10
USB Cover 21

W

Warranty policy for Philips Professional Display Solutions
61
Watch the Connected Video Source 28



2024 © TOP Victory Investments Ltd. All rights reserved.

This product has been manufactured by and is sold under the responsibility of Top Victory Investments Ltd., and Top Victory Investments Ltd. is the warrantor in relation to this product. Philips and the Philips Shield Emblem are registered trademarks of Koninklijke Philips N.V. and are used under license.

Specifications are subject to change without notice.
Version : V1.00 2024-04-09