



**THE DISPLAY CHOICE
OF PROFESSIONALS™**

displays.agneovo.com

TBX-2201 LCD Monitor
User Manual

TABLE OF CONTENTS

Safety Information

WEEE	4
------------	---

Precautions

Notice	5
Cautions When Setting Up	5
Cleaning and Maintenance.....	6
Cautions When Using.....	6
Notice for the LCD Monitor.....	7

Chapter 1: Product Description

1.1 Package Contents	8
1.2 Wall Mounting Installation Preparation	9
1.2.1 Wall Mounting.....	9
1.3 LCD Monitor Overview	10
1.3.1 Front View and Keypad Buttons.....	10
1.3.2 Rear View.....	11
1.4 Managing Cables	12

Chapter 2: Making Connections

2.1 Connecting the Power	13
2.2 Connecting Input Source Signals	14
2.2.1 Connecting a Computer	14
Connecting to Wired Network	14
Using RS232 Cables.....	14
Using HDMI Cables.....	15
2.3 Connecting a USB Storage Device (For Firmware Update).....	15

Chapter 3: Using the LCD Monitor

3.1 Turning on the Power	16
3.2 Adjusting the Volume.....	17
3.2.1 Muting the Audio.....	17
3.3 Locking the OSD Menu	17

Chapter 4: On Screen Display Menu

4.1 Using the OSD Menu	18
4.2 OSD Menu Tree	20

Chapter 5: Adjusting the LCD Monitor

5.1 Brightness	22
5.2 Colour Temp.	24
5.3 Image Setting	25
5.4 Aspect Ratio	27
5.5 Anti-Burn-in.....	28
5.6 OSD Setting	29
5.7 Audio Setting	30
5.8 System	31

TABLE OF CONTENTS

5.9 EcoSmart Sensor	32
5.10 Network	34

Chapter 6: Appendix

6.1 Warning Messages	35
6.2 Supported Resolutions	36
6.3 Troubleshooting	37
6.4 Transporting the LCD Monitor	39

Chapter 7: Specifications

7.1 Monitor Specifications	40
7.2 Monitor Dimensions	41
7.2.1 TBX-2201 Dimensions	41

SAFETY INFORMATION

WEEE

Information for users applicable in European Union countries.

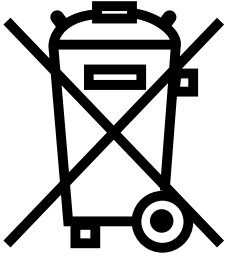

The symbol on the product or its packaging signifies that this product has to be disposed separately from ordinary household wastes at its end of life. Please kindly be aware that this is your responsibility to dispose electronic equipment at recycling centers so as to help conserve natural resources. Each country in the European Union should have its collection centers for electrical and electronic equipment recycling. For information about your recycling drop off area, please contact your local related electrical and electronic equipment waste management authority or the retailer where you bought the product.

PRECAUTIONS

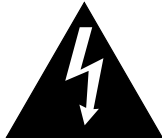

CAUTION
RISK OF ELECTRIC SHOCK
DO NOT OPEN



Symbols used in this manual

	This icon indicates the existence of a potential hazard that could result in personal injury or damage to the product.
	This icon indicates important operating and servicing information.

Notice

- Read this User Manual carefully before using the LCD monitor and keep it for future reference.
- The product specifications and other information provided in this User Manual are for reference only. All information is subject to change without notice. Updated content can be downloaded from our web site at displays.agneovo.com.
- To register online, go to displays.agneovo.com.
- To protect your rights as a consumer, do not remove any stickers from the LCD monitor. Doing so may affect the determination of the warranty period.

Cautions When Setting Up



Do not place the LCD monitor near heat sources, such as a heater, exhaust vent, or in direct sunlight.



Do not cover or block the ventilation holes in the housing.



Place the LCD monitor on a stable area. Do not place the LCD monitor where it may be subject to vibration or shock.



Place the LCD monitor in a well-ventilated area.



Do not place the LCD monitor outdoors.



Do not place the LCD monitor in a dusty or humid environment.



Do not spill liquid or insert sharp objects into the LCD monitor through the ventilation holes. Doing so may cause accidental fire, electric shock or damage the LCD monitor.

PRECAUTIONS

Cautions When Using

- ◆ Ensure that the source voltage matches the voltage of the power supply specified for the LCD monitor.
Failure to comply may cause the electric shock or damage to the device.
- ◆ To avoid fire or electric shocks, do not overload the electrical circuit.
- ◆ The power source should be installed near the LCD monitor and be easily accessible.
- ◆ Disconnect the power source when the LCD monitor is not going to be used for an indefinite period of time.

Cleaning and Maintenance



The LCD monitor comes with NeoV™ Optical Hard Glass. Use a soft cloth lightly moistened with a mild detergent solution to clean the glass surface and the housing.



Do not rub or tap the surface of the glass with sharp or abrasive items such as a pen or screwdriver. This may result in scratching the surface of the glass.



Do not attempt to service the LCD monitor yourself, refer to qualified service personnel. Opening or removing the covers may expose you to dangerous voltage or other risks.



Warning:



Disconnect the power source and refer to qualified service personnel under the following conditions:

- ◆ If the LCD monitor has been dropped or the housing has been damaged.
- ◆ If the LCD monitor emits smoke or a distinct odor.



Warning:



Ceiling mount or mount on any other horizontal surface overhead are not advisable.

Installation in contravention of the instructions may result in undesirable consequences, particularly hurting people and damaging property. Users who have already mounted the monitor on the ceiling or any other horizontal surface overhead are strongly advised to contact AG Neovo for consultations and solutions to help ensure a most pleasurable and monitor experience.

PRECAUTIONS

Notice for the LCD Monitor

In order to maintain the stable luminous performance, it is recommended to use low brightness setting.

Due to the lifespan of the lamp, it is normal that the brightness quality of the LCD monitor may decrease with time.

When static images are displayed for long periods of time, the image may cause an imprint on the LCD monitor. This is called image retention or burn-in.

To prevent image retention, do any of the following:

- Set the LCD monitor to turn off after a few minutes of being idle.
- Use a screen saver that has moving graphics or a blank white image.
- Switch desktop backgrounds regularly.
- Adjust the LCD monitor to low brightness settings.
- Turn off the LCD monitor when the system is not in use.

Things to do when the LCD monitor shows image retention:

- Turn off the LCD monitor for extended periods of time. It can be several hours or several days.
 - Use a screen saver and run it for extended periods of time.
 - Use a black and white image and run it for extended periods of time.
-

When the LCD monitor is moved from one room to another or there is a sudden change from low to high ambient temperature, dew condensation may form on or inside the glass surface. When this happens, do not turn on the LCD monitor until the dew disappears.

Due to humid weather conditions, it is normal for mist to form inside the glass surface of the LCD monitor. The mist will disappear after a few days or as soon as the weather stabilizes.

There are millions of micro transistors inside the LCD monitor. It is normal for a few transistors to be damaged and to produce spots. This is acceptable and is not considered a failure.

CHAPTER 1: PRODUCT DESCRIPTION

1.1 Package Contents

When unpacking, check if the following items are included in the package. If any of them is missing or damaged, contact your dealer.

LCD Monitor

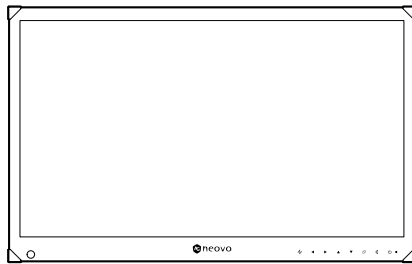

Quick Start Guide

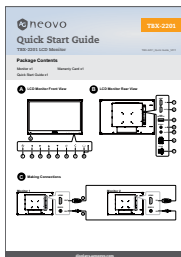

Warranty card

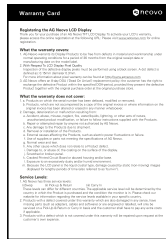

Note:

- ◆ The pictures are for reference only. Actual items may vary upon shipment.

PRODUCT DESCRIPTION

1.2 Wall Mounting Installation Preparation

1.2.1 Wall Mounting

Screw the mounting bracket to the VESA holes at the rear of the LCD monitor.

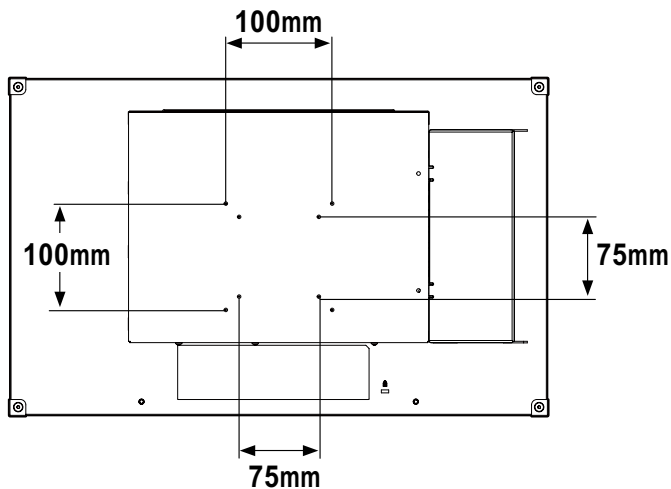

Warning:



Ceiling mount or mount on any other horizontal surface overhead are not advisable.

Installation in contravention of the instructions may result in undesirable consequences, particularly hurting people and damaging property. Users who have already mounted the monitor on the ceiling or any other horizontal surface overhead are strongly advised to contact AG Neovo for consultations and solutions to help ensure a most pleasurable and fulfilling monitor experience.

Note:

Take measures to prevent the LCD monitor from falling down and lessen possible injury and damage to the monitor in case of earthquakes or other disasters.

- ◆ Use only the 75 x 75 mm and 100 x 100 mm wall mount kit recommended by AG Neovo.
- ◆ Secure the LCD monitor on a solid wall strong enough to bear its weight.

PRODUCT DESCRIPTION

1.3 LCD Monitor Overview

1.3.1 Front View and Keypad Buttons

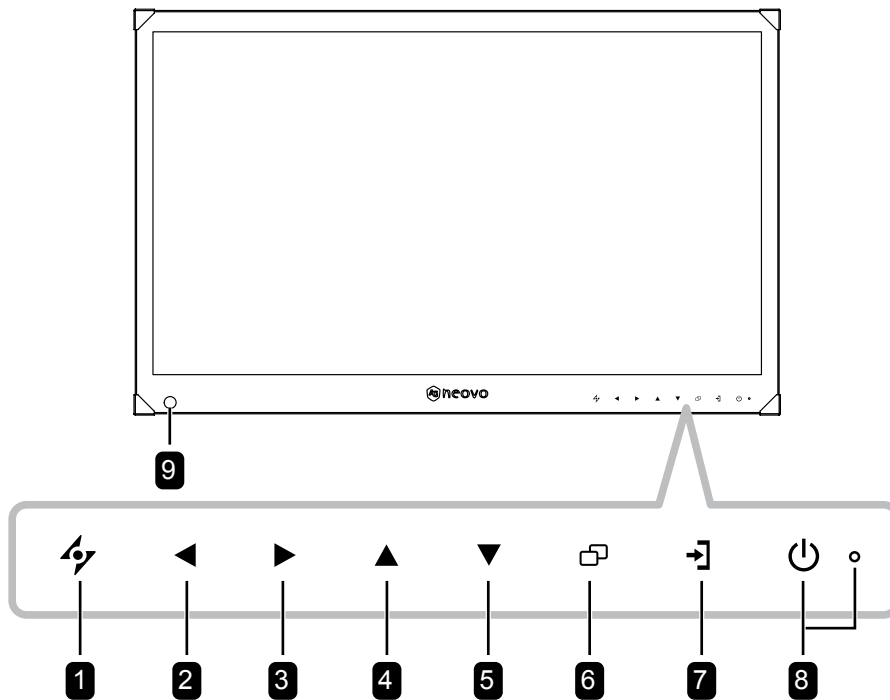

1 AUTO

Press to close the OSD menu or exit a submenu.

2 LEFT

Hot Key: Volume Down

- Press to display the volume screen. Then press again to decrease the volume.
- During OSD menu selection, press to select an option or adjust the settings.

3 RIGHT

Hot Key: Aspect Ratio

Note: This function only works when the **PICTURE MODE** setting is set to **VIVID/ CINEMA**.

- Press to increase the volume.
- During OSD menu selection, press to select an option, adjust the settings, or enter the submenu.

4 UP

During OSD menu selection, press to select an option or adjust the settings.

5 DOWN

Hot Key: Picture Mode

- During OSD menu selection, press to select an option or adjust the settings.

6 MENU

Press to display/close the OSD menu or exit a submenu.

7 ADDRESS SETUP Key

During NETWORK address selection, press to switch to the next field.

8 POWER / LED Indicator:

- Press to turn the power on or off.
- Green - Power on
- Amber - Standby mode
- Off - Power off

9 ECOSMART SENSOR

Automatically adjust the LCD screen brightness according to the ambient light.

PRODUCT DESCRIPTION

1.3.2 Rear View

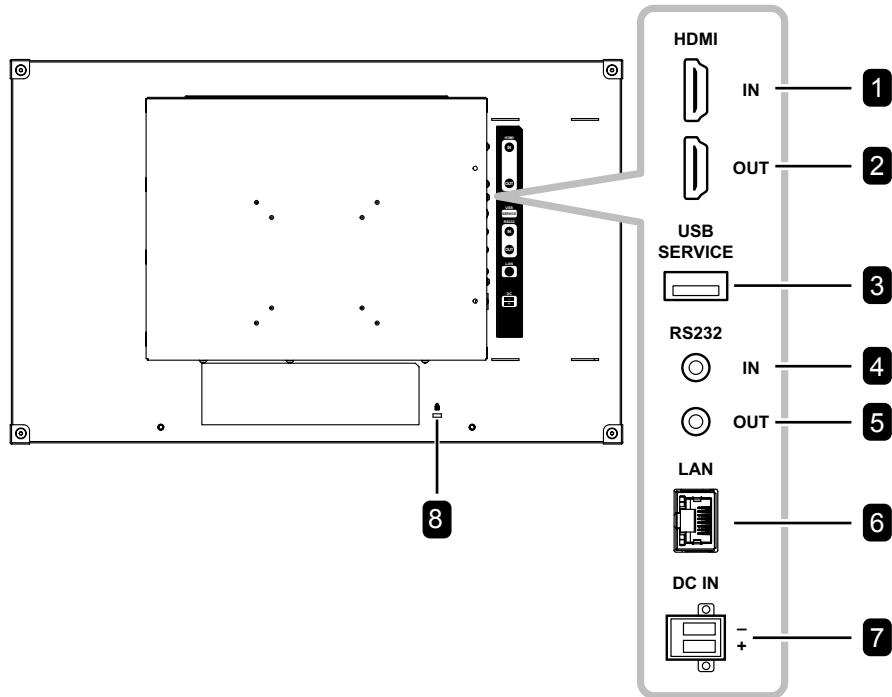

- 1 HDMI IN**
Connect HDMI signals input.
- 2 HDMI OUT**
Connect HDMI signals output.
- 3 USB 2.0 Port (Service)**
Connect USB 2.0 for service.
- 4 RS232 IN**
Connect RS232 input from external equipment.
- 5 RS232 OUT**
Connect RS232 output to additional displays.
- 6 LAN**
For remote control systems with an Ethernet cable.
- 7 DC IN**
Connect with an applicable power source.
- 8 KENSINGTON SECURITY SLOT**
Used for security and theft prevention.

PRODUCT DESCRIPTION

1.4 Managing Cables

When shipped, the cable cover is installed on the rear of the LCD monitor. Before making any device connection, you have to remove first the screws securing the cable cover. Then remove the cable cover.

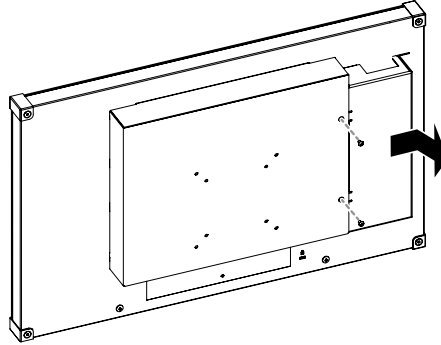

After performing the necessary connection, collect the cables together and replace the cable cover back onto its compartment. Then secure the cable cover with the screws.

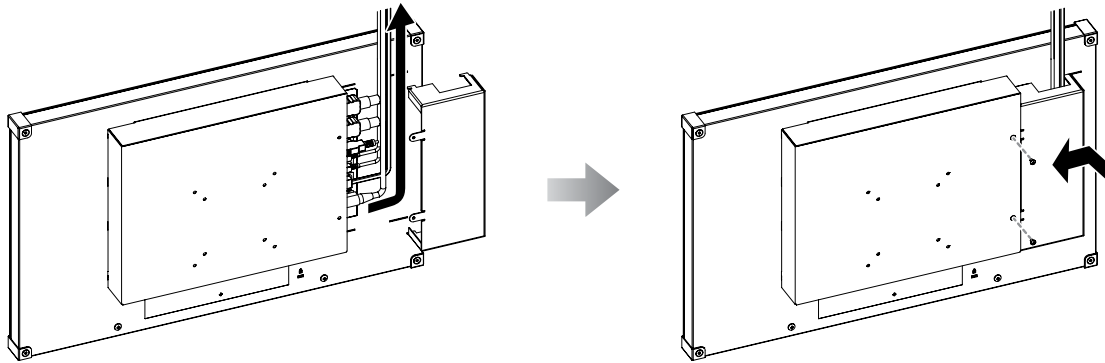

CHAPTER 2: MAKING CONNECTIONS

2.1 Connecting the Power

Connect the power source to the DC power input at the rear of the LCD monitor.

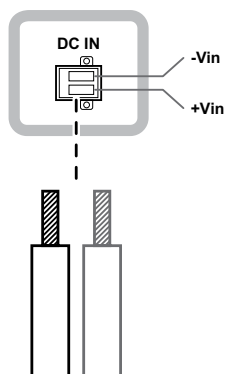
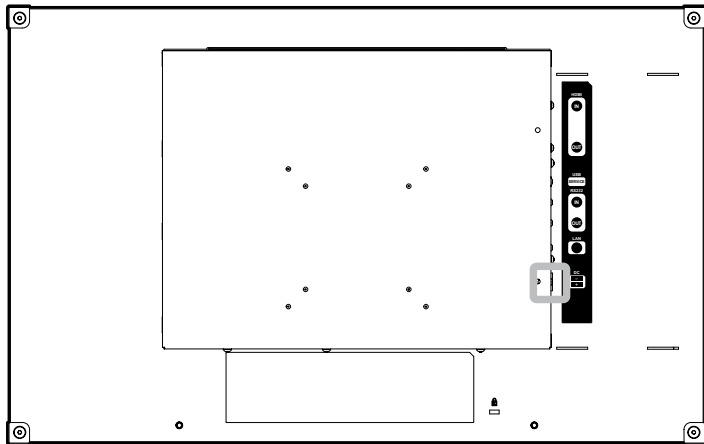

Caution:

- ◆ Make sure that the LCD monitor is not connected to the power source before making any connections.

Use a slotted screwdriver for M3 screws to tighten the screws of the 2-pin terminal block.

Phoenix Contact Terminal Block

Connector header and plug:

Header - 1776508

Plug - 1777989

MAKING CONNECTIONS

2.2 Connecting Input Source Signals

2.2.1 Connecting a Computer

Connecting to Wired Network

Connect one end of a LAN cable to the LAN connector of the LCD monitor and the other end to the LAN connector of the computer.

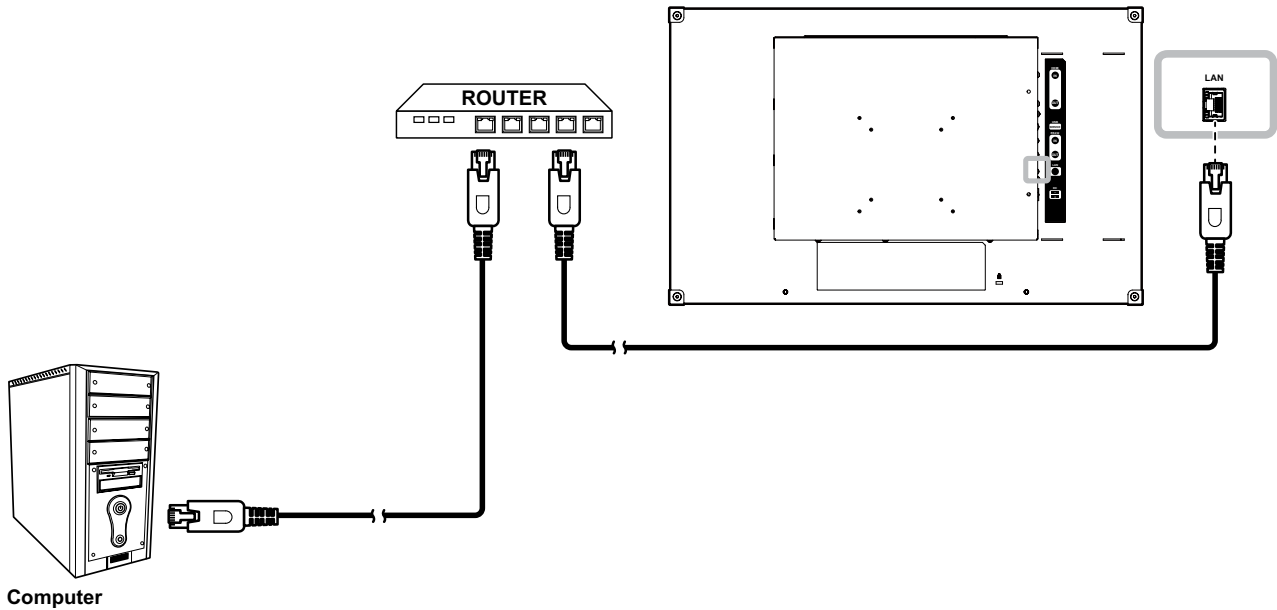

Using RS232 Cables

Connect one end of a RS232 cable to the RS232 IN connector of the LCD monitor and the other end to the RS232 connector of the computer.

To create a daisy-chain configuration for applications, connect one end of a RS232 cable to the RS232 OUT connector of the Monitor 1 and the other end to the RS232 IN connector of the Monitor 2.

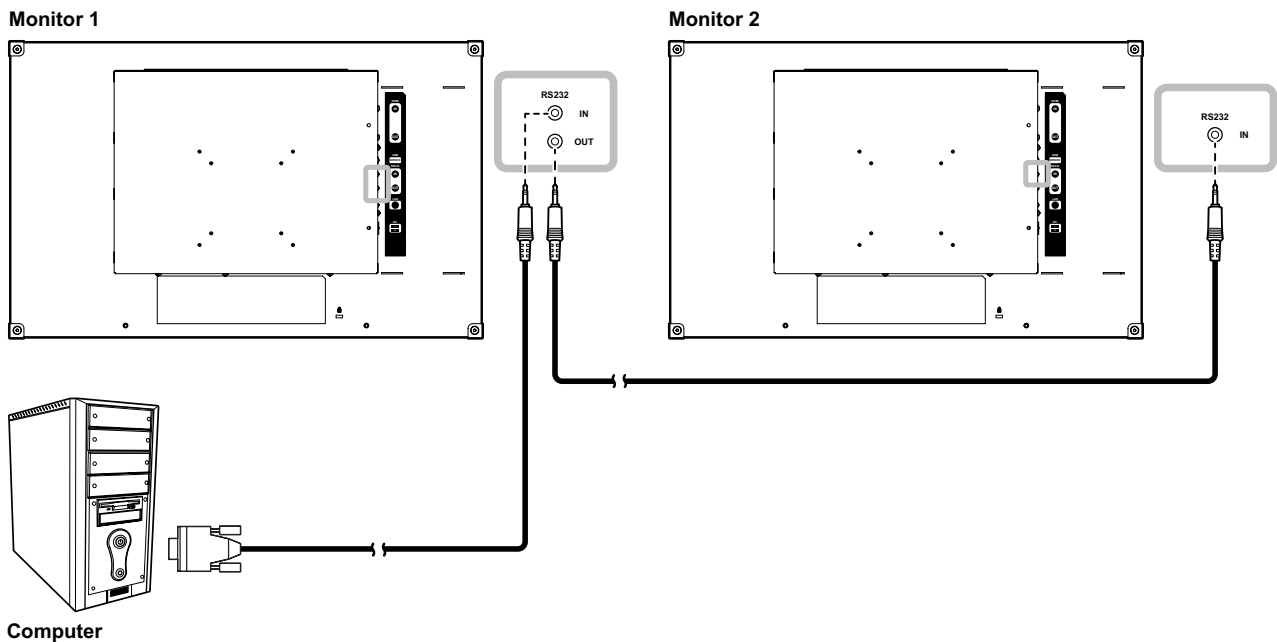

MAKING CONNECTIONS

Using HDMI Cables

Connect one end of an HDMI cable to the HDMI IN connector of the LCD monitor and the other end to the HDMI connector of your device.

To create a daisy-chain configuration for applications, connect one end of an HDMI cable to the HDMI OUT connector of the Monitor 1 and the other end to the HDMI IN connector of the Monitor 2.

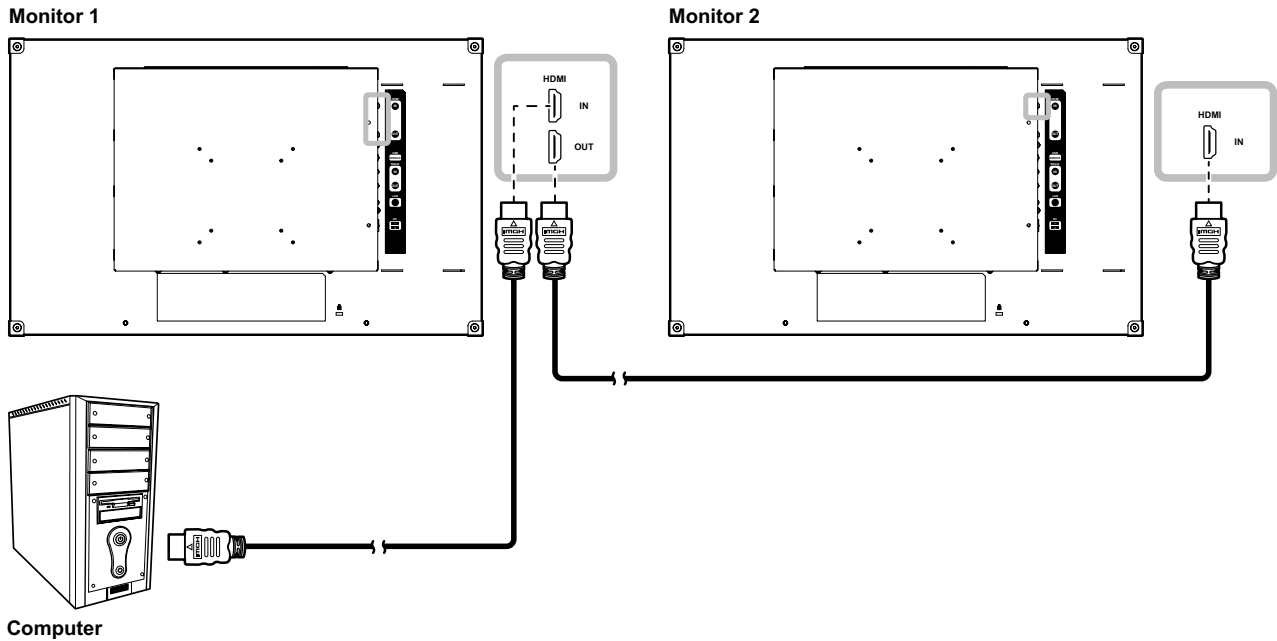

2.3 Connecting a USB Storage Device (For Firmware Update)

Connect the USB storage device directly to the USB connector of the LCD monitor.

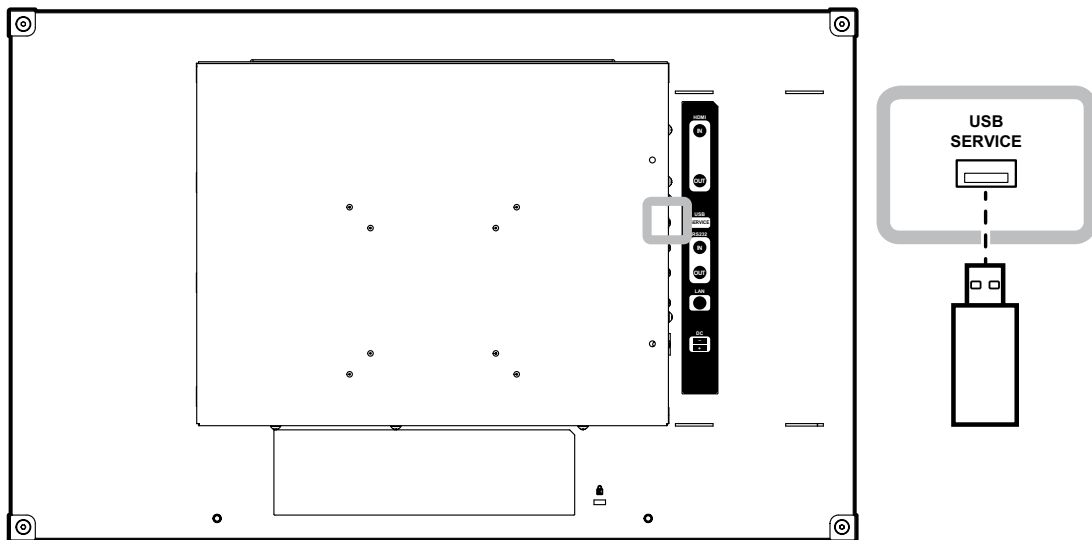

CHAPTER 3: USING THE LCD MONITOR

3.1 Turning on the Power

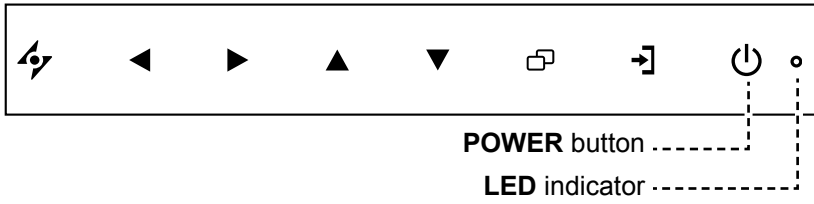

- 1 Connect the power source to the DC power input at the rear of the LCD monitor.
- 2 Press the **POWER** button to turn the LCD monitor on.
The LED indicator turns GREEN.
When the LCD monitor is turned on, press the POWER button to turn off the LCD monitor.
The LED indicator turns off.

Note:

- ◆ Disconnect the power source to completely cut off power.

USING THE LCD MONITOR

3.2 Adjusting the Volume

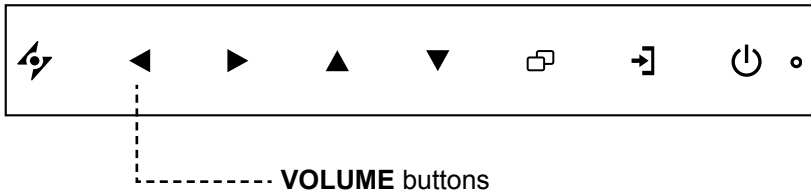

- 1 Press the ◀ button to call out the volume bar.

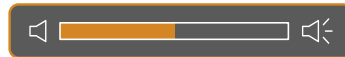

- 2 Press the ▶ button to increase volume or the ◀ button to decrease volume.

3.2.1 Muting the Audio

Press the ◀ and ▶ buttons simultaneously to mute or unmute the audio.

3.3 Locking the OSD Menu

Lock the OSD menu to protect the LCD monitor from unauthorised users or from accidentally pressing the keypad.

To lock the OSD, press and hold the keypad buttons listed below for at least 5 seconds or until the





message appears.

When the OSD is locked, all keypad buttons are inactivated.

Type of OSD Lock	Lock Operation	Unlock Operation
Lock all buttons	Press and hold the ▶, ▲, and ▼ buttons simultaneously for 5 seconds.	Press and hold the ▶, ▲, and ▼ buttons simultaneously for 5 seconds or until the OSD menu appears.
Lock all buttons except the POWER button.	Press and hold the ◀, ▲, and ▼ buttons simultaneously for 5 seconds.	Press and hold the ◀, ▲, and ▼ buttons simultaneously for 5 seconds or until the OSD menu appears.

CHAPTER 4: ON SCREEN DISPLAY MENU

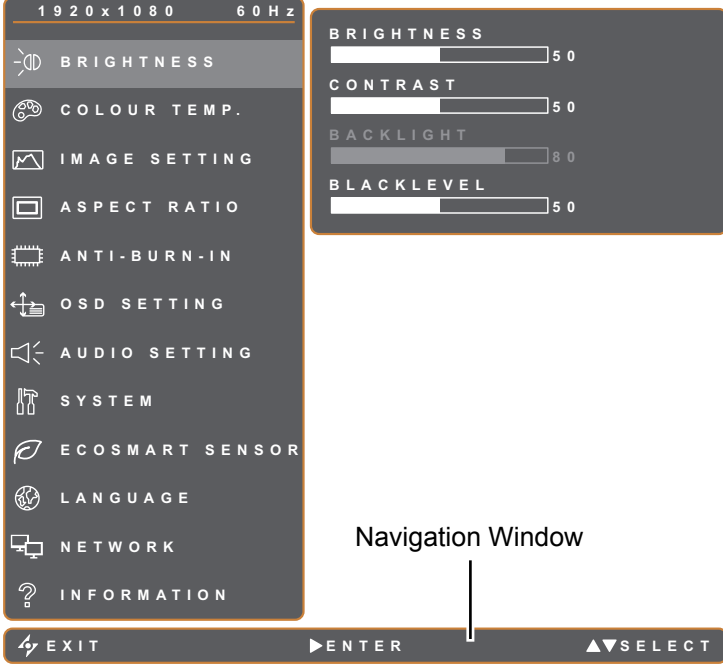
4.1 Using the OSD Menu

		Operation
1	Display the main menu screen.	Press the  button.
		
2	Select the menu.	<ol style="list-style-type: none">1 Press the ▲ or ▼ button.2 Press the ► button to enter the submenu.
		

ON SCREEN DISPLAY MENU

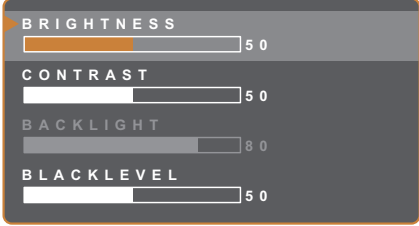
		Operation
<p>3 Select the submenu item.</p>  <p>The highlighted item with an orange arrow indicates the active submenu.</p>	<p>Press the ▲ or ▼ button.</p>	
<p>4 Adjust the settings.</p>	<p>Press the ◀ or ▶ button.</p>	
<p>5 Exit the submenu.</p>	<p>Press the ⚡ or ◻ button to return to the previous menu.</p>	
<p>6 Close the OSD window.</p>	<p>Press the ⚡ or ◻ button again.</p>	

When settings are modified, all changes are saved when the user does the following:

- Proceeds to the another menu.
- Exits the OSD menu.
- Waits for the OSD menu to disappear.

Note: Availability of some menu items depend on the Picture Mode or other OSD settings. If the menu is not available, it is disabled and grayed out.

ON SCREEN DISPLAY MENU

4.2 OSD Menu Tree

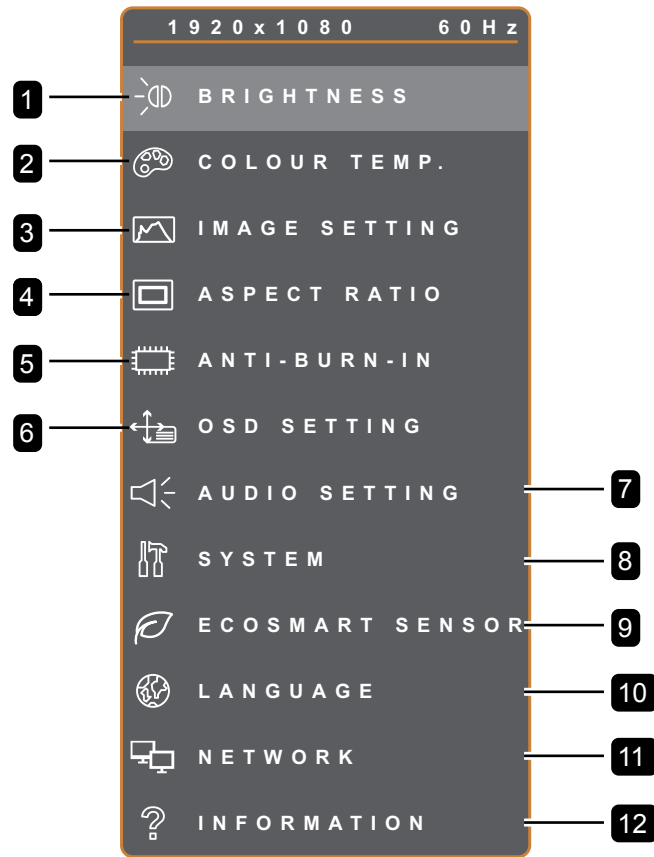

Main Menu	Submenu	Remarks
1. BRIGHTNESS	<ul style="list-style-type: none"> • BRIGHTNESS • CONTRAST • BACKLIGHT • BLACK LEVEL 	See page 22.
2. COLOUR TEMP.	<ul style="list-style-type: none"> • NEUTRAL • WARM • COOL • USER 	See page 24.
3. IMAGE SETTING	<ul style="list-style-type: none"> • SHARPNESS • SATURATION • TINT • GAMMA • COLOUR RANGE • NOISE REDUCTION • PICTURE MODE 	See page 25.





ON SCREEN DISPLAY MENU



Main Menu	Submenu	Remarks
4. ASPECT RATIO	<ul style="list-style-type: none"> • FULL • REAL • NATIVE • ZOOM • OVERSCAN 	See page 27.
5. ANTI-BURN-IN	<ul style="list-style-type: none"> • ENABLE • INTERVAL (HOURS) • MODE 	See page 28.
6. OSD SETTING	<ul style="list-style-type: none"> • TRANSPARENCY • OSD H. POSITION • OSD V. POSITION • OSD TIMER 	See page 29.
7. AUDIO SETTING	<ul style="list-style-type: none"> • VOLUME • AUDIO 	See page 30.
8. SYSTEM	<ul style="list-style-type: none"> • POWER SAVING • DCR • BLUE SCREEN • SIGNAL INFO • LOGO • LED • MONITOR-ID • RECALL 	See page 31.
9. ECOSMART SENSOR	<ul style="list-style-type: none"> • ENABLE • MODE • LEVEL 	See page 32.
10. LANGUAGE	Select the OSD language: EN (English) / FR (Français) / DE (Deutsch) / ES (Español) / IT (Italiano) / PY (Русский) / RO (Română) / PL (Polski) / CS (Česky) / NL (Nederlands) / 简中 (简体中文) / 繁中 (繁體中文)	
11. NETWORK	<ul style="list-style-type: none"> • NETWORK CONFIGURATION • IP ADDRESS • NETMASK • GATEWAY • DNS 1 • DNS 2 • NETWORK NAME 	See page 34.
12. INFORMATION	Displays settings information such as Input, Resolution, Horizontal Frequency, Vertical Frequency, Timing Mode, Firmware Version, Network Mode, IP Address, Netmask, Gateway, DNS 1/2, MAC address, and Network Name.	

CHAPTER 5: ADJUSTING THE LCD MONITOR

5.1 Brightness





1. Press the  button to call out the OSD window.
2. Select **BRIGHTNESS** menu, then press the  button.
3. Press the  or  button to select an option.

Item	Function	Operation	Range
BRIGHTNESS	Adjusts the luminance of the screen image.	Press the  or  button to adjust the value.	0 to 100
CONTRAST	Adjusts the difference between the black level and the white level.		
BACKLIGHT	Adjusts the luminance of the screen image. Note: This menu option is not available if the DCR and ECOSMART SENSOR functions are enabled.		
BLACK LEVEL	Adjusts the black level of the screen image. Low brightness setting makes black colour darker.		

See comparison illustrations on page 23.

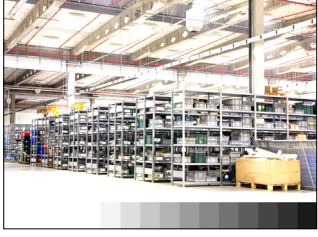
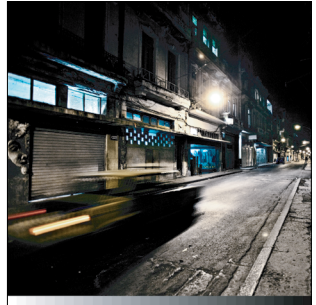
ADJUSTING THE LCD MONITOR

	Original Setting	High Setting	Low Setting
BRIGHTNESS			
CONTRAST			
BLACK LEVEL			

ADJUSTING THE LCD MONITOR

5.2 Colour Temp.

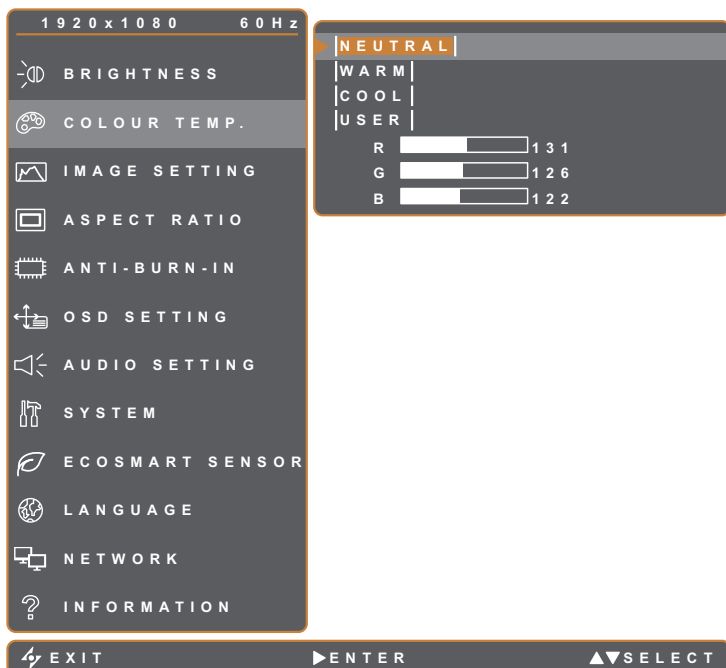

1. Press the button to call out the OSD window.
2. Select **COLOUR TEMP.** menu, then press the button.
3. Press the or button to select an option.

Item	Function	Operation	Range
COLOUR TEMP.	Provides several colour settings.	Press the or button to select the setting.	NEUTRAL WARM COOL USER
	Colour setting can be set to: <ul style="list-style-type: none"> • NEUTRAL - commonly used for normal lighting conditions. • WARM - Applies a reddish tint for warmer colours. • COOL - Applies a bluish tint for cooler colours. • USER - This allows users to set the colour temperature by adjusting the R, G, B settings according to one's preference. <ol style="list-style-type: none"> 1 Select USER, and press the button. 2 Press the or button to select the colour you want to adjust. 3 Press the or button to adjust the values between 0 ~ 255. <p>Note: Activate RECALL to return the colour to its default setting.</p>		

ADJUSTING THE LCD MONITOR

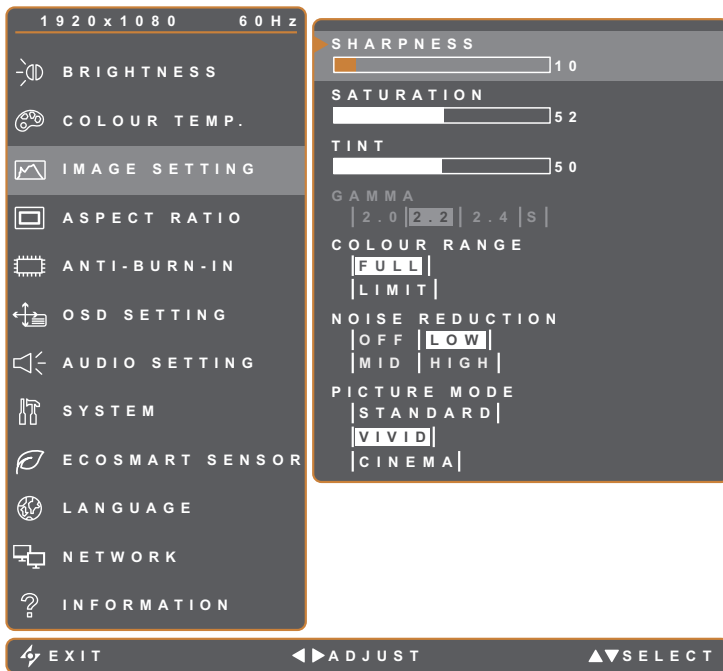

5.3 Image Setting



1. Press the button to call out the OSD window.
2. Select **IMAGE SETTING** menu, then press the button.
3. Press the or button to select an option.

Item	Function	Operation	Range
SHARPNESS	Adjusts the clarity and focus of the screen image.	Press the or button to adjust the value.	0 to 100
SATURATION	Adjusts the colour saturation.		
TINT	Adjusts the colour tint.		
GAMMA	Adjust the Gamma value based on users' viewing environment to improve visual perception.	Press the or button to select the setting.	2.0 2.2 2.4 S
	<div style="display: flex; justify-content: space-around; text-align: center;"> <div>Display Gamma 2.0 </div> <div>Display Gamma 2.2 </div> <div>Display Gamma 2.4 </div> <div>Display Gamma S </div> </div>		

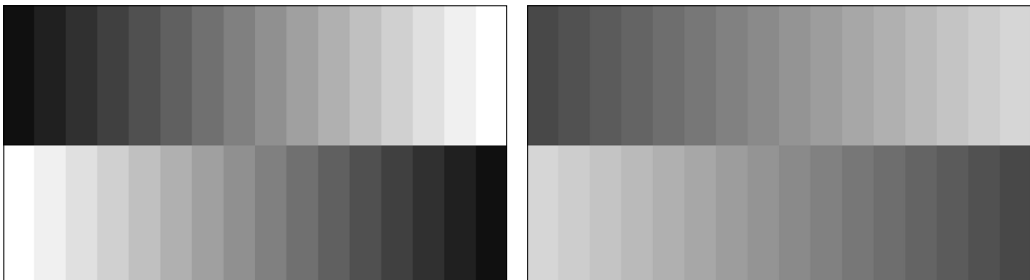



ADJUSTING THE LCD MONITOR





Item	Function	Operation	Range
COLOUR RANGE	Adjusts black and white levels for video. Note: This menu option is only available if the input source is HDMI.	Press the ◀ or ▶ button to select the setting.	FULL LIMIT
	Signal source from PC - PC signal at a full range (Grayscale 0-255) state:		
			
	Monitor OSD colour range: Full *Please select Monitor OSD colour range: Limit		
NOISE REDUCTION	Adjusts the noise reduction to help remove noise from images. This helps produce clearer and crisper images.	Press the ◀ or ▶ button to select the setting.	OFF LOW MID HIGH
	Signal source from Video - Video signal at a limited range (Grayscale 16~235) state:		
			
	Monitor OSD colour range: Limit *Please select Monitor OSD colour range: Full		
PICTURE MODE	Selects a predefined picture mode setting.	Press the ◀ or ▶ button to select the setting.	STANDARD VIVID CINEMA
			

ADJUSTING THE LCD MONITOR

5.4 Aspect Ratio







1. Press the  button to call out the OSD window.
2. Select **ASPECT RATIO** menu, then press the  button.
3. Press the  or  button to select an option.



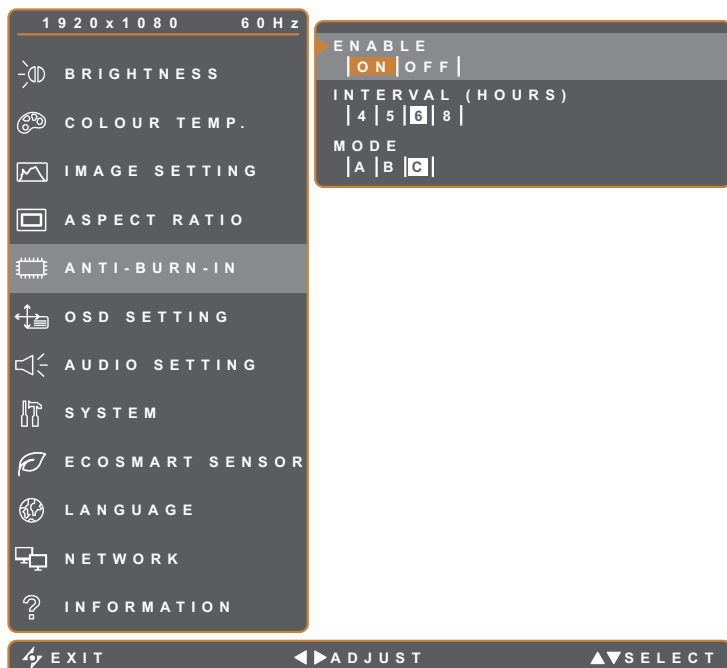



Item	Function	Operation	Range
ASPECT RATIO	Adjusts the aspect ratio of the screen image.	Press the  or  button to select the setting.	FULL REAL NATIVE ZOOM
H. ZOOM (Horizontal Zoom)	Adjusts the horizontal zoom. Note: This menu option is only available if the ASPECT RATIO setting is set to ZOOM .	Press the  or  button to adjust the value.	0 to 100
V. ZOOM (Vertical Zoom)	Adjusts the horizontal zoom. Note: This menu option is only available if the ASPECT RATIO setting is set to ZOOM .		
OVERSCAN	Adjusts the overscan setting to fix the cut-off screen edges.		

ADJUSTING THE LCD MONITOR

5.5 Anti-Burn-in







1. Press the  button to call out the OSD window.
2. Select **ANTI-BURN-IN** menu, then press the  button.
3. Press the  or  button to select an option.



Item	Function	Operation	Range
ENABLE	Enables or disables Anti-Burn-In function.	Press the  or  button to select the setting.	ON OFF
INTERVAL (HOURS)	Sets the interval time (hour) between activating the Anti-Burn-In function.	Press the  or  button to adjust the value.	4 5 6 8
MODE	Selects the Anti-Burn-In mode.	Press the  or  button to select the setting.	A B C
	Anti-Burn-In mode can be set to: <ul style="list-style-type: none"> • A - Executes fast. • B - Slower but more precise than mode A. • C - Slowest but the most precise anti-burn-in mode. 		

ADJUSTING THE LCD MONITOR

5.6 OSD Setting







1. Press the  button to call out the OSD window.
2. Select **OSD SETTING** menu, then press the  button.
3. Press the  or  button to select an option.





Item	Function	Operation	Range
TRANSPARENCY	Adjusts the transparency level of the OSD screen.	Press the  or  button to adjust the value.	0 to 100
OSD H. POSITION (Horizontal Position)	Moves the OSD window to the left or right of the screen.		
OSD V. POSITION (Vertical Position)	Moves the OSD window up or down the screen.		
OSD TIMER	Sets the length of time (in seconds) the OSD screen is displayed. When the time elapses, the OSD screen is automatically inactivated.		5 to 100

ADJUSTING THE LCD MONITOR

5.7 Audio Setting







1. Press the  button to call out the OSD window.
2. Select **AUDIO SETTING** menu, then press the  button.
3. Press the  or  button to select an option.





Item	Function	Operation	Range
VOLUME	Adjusts the volume level of the built-in speaker. Note: If volume is adjusted but AUDIO is set to OFF , no sound comes out from the speaker.	Press the  or  button to adjust the value.	0 to 100
AUDIO	Turns the audio speaker ON or OFF.	Press the  or  button to select the setting.	ON OFF

ADJUSTING THE LCD MONITOR

5.8 System



1. Press the  button to call out the OSD window.
2. Select **SYSTEM** menu, then press the  button.
3. Press the  or  button to select an option.

Item	Function	Operation	Range
POWER SAVING	Enables or disables power saving mode. If the setting is set to ON , the screen turns black and the LED indicator lights AMBER when no signal is available.	Press the  or  button to select the setting.	ON OFF
DCR (Dynamic Contrast Ratio)	Activates DCR. This feature provides the ability to maximize the range of the darkest blacks and the brightest whites by automatically adjusting the backlight. DCR is suitable for indoor viewing. Note: If the setting is set to ON , the BACKLIGHT option in the BRIGHTNESS menu will be disabled.		
BLUE SCREEN	Enables or disables the blue screen feature. If the setting is set to ON , it displays a blue screen when no signal is available. On the contrary, the screen turns black if the setting is set to OFF .		
SIGNAL INFO	Enables or disables the signal information to be displayed on the screen.		
LOGO	Enables or disables the logo feature. If the setting is set to ON , the AG Neovo logo is briefly displayed after the monitor is powered on.		
LED	Sets the monitor LED indicator on or off.		
MONITOR-ID	Sets the monitor ID.	Press the  or  button to set the ID.	1 to 255

ADJUSTING THE LCD MONITOR

Item	Function	Operation	Range
RECALL	Use to reset all to default settings, except Language and NETWORK related settings.	Press the ► button to execute the function.	-

5.9 EcoSmart Sensor

With the built-in EcoSmart sensor, users can enable the Eco Smart feature to automatically adjust the LCD screen brightness according to the ambient light. This feature comforts the eyes and helps optimise energy efficiency.

Note: Please make sure the EcoSmart sensor is not covered when enabling this function.

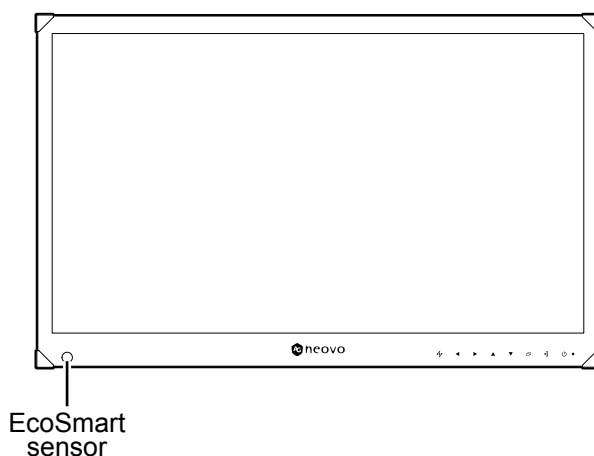

1. Press the  button to call out the OSD window.
2. Select **ECOSMART SENSOR** menu, then press the ► button.
3. Press the ▲ or ▼ button to select an option.

Item	Function	Operation	Value
ENABLE	Enables or disables the Eco Smart feature. Note: If the setting is set to ON , the BACKLIGHT option in the BRIGHTNESS menu will be disabled.	Press the ◀ or ▶ button to select the setting.	ON OFF





ADJUSTING THE LCD MONITOR

Item	Function	Operation	Value
MODE	Sets the auto brightness mode.	Press the ◀ or ▶ button to select the setting.	AUTO USER
	The mode can be set to: <ul style="list-style-type: none"> • AUTO - This mode is the default mode. The LCD brightness automatically adjusts to the ambient brightness. • USER - Allows you to manually adjust the LCD brightness. 		
LEVEL	Allows you to set the level of LCD brightness. Note: This menu option is only available if the MODE setting is to USER .	Press the ◀ or ▶ button to adjust the value.	0 to 100

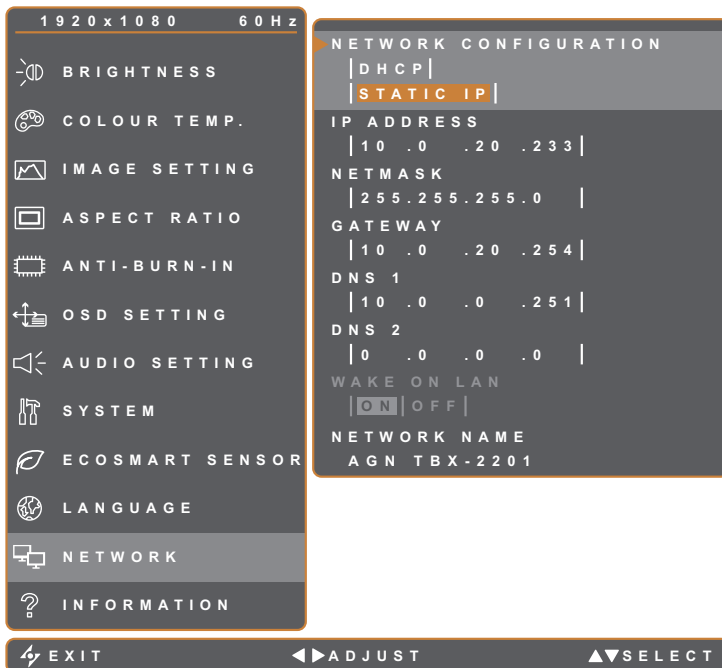











ADJUSTING THE LCD MONITOR

5.10 Network







1. Press the  button to call out the OSD window.
2. Select **NETWORK** menu, then press the  button.
3. Press the  or  button to select an option.

Note: The monitor does not support the **WAKE ON LAN** function. So this menu option is disabled and grayed out.

Item	Function	Operation	Value
NETWORK CONFIGURATION	Choose how the LCD monitor should assign addresses to the network resources.	Press the  or  button to select the setting.	DHCP STATIC IP
IP ADDRESS	Manually configure the network parameters. This option can only be configured when the NETWORK CONFIGURATION setting is set to STATIC IP .	<ul style="list-style-type: none"> • Press the  or  button to select the item. • Press the  or  button to configure the network parameter. Then press the  button to switch to the next field. • When the setting is complete, press the  button to save the setting. 	0 . 0 . 0 . 0 (0 to 255)
NETMASK			
GATEWAY			
DNS 1			
DNS 2			
NETWORK NAME	In the multiple-display connection, you can rename each monitor for easy identification.	<ul style="list-style-type: none"> • Press the  or  button to select the character. Then press the  button to switch to the next field. • When the setting is complete, press the  button to save the setting. 	x x x x x x x x x x x x x x x (0~9, A~Z, Space, +, -, /, :)

CHAPTER 6: APPENDIX

6.1 Warning Messages

Warning Messages	Cause	Solution
	The resolution or the refresh rate of the graphics card of the computer is set too high.	<ul style="list-style-type: none"> • Change the resolution or the refresh rate of the graphics card.
	The LCD monitor cannot detect the input source signal.	<ul style="list-style-type: none"> • Check if the input source is turned ON. • Check if the signal cable is properly connected. • Check if any pin inside the cable connector is twisted or broken.
	The OSD has been locked by the user.	<ul style="list-style-type: none"> • Unlock the OSD. Refer to page 17.
	The Anti-Burn-In function has been enabled by the user.	<ul style="list-style-type: none"> • Disable the Anti-Burn-In function. Refer to page 28.
	The Anti-Burn-In function has been disabled by the user.	<ul style="list-style-type: none"> • Enable the Anti-Burn-In function. Refer to page 28.

APPENDIX

6.2 Supported Resolutions

PC Mode	Resolution		Refresh Rate
	Horizontal	Vertical	
IBM VGA	720	400	70
IBM VGA	640	480	60
Apple Mac II	640	480	67
VESA	640	480	72
VESA	640	480	75
VESA	800	600	56
VESA	800	600	60
VESA	800	600	72
VESA	800	600	75
Apple Mac II	832	624	75
VESA	1024	768	60
VESA	1024	768	70
VESA	1024	768	75
VESA	1280	1024	60
VESA	1280	1024	75
Apple Mac II	1152	870	75
VESA	1152	864	75
VESA	1280	800	60
VESA	1280	800	75
VESA	1280	960	60
VESA	1440	900	60
VESA	1680	1050	60
VESA	1920	1080	60

Video Mode	Resolution		Refresh Rate
	Horizontal	Vertical	
EDTV	720	480	60i
EDTV	720	480	60
EDTV	720	576	50i
EDTV	720	576	50
HDTV	1280	720	50
EDTV	1280	720	60
HDTV	1920	1080	50i
HDTV	1920	1080	50
HDTV	1920	1080	60i

APPENDIX

Video Mode	Resolution		Refresh Rate
	Horizontal	Vertical	
HDTV	1920	1080	60
HDTV	1920	1080	24
HDTV	1920	1080	25
HDTV	1920	1080	30

6.3 Troubleshooting

Problem	Possible Cause and Solution
<p>No picture.</p> <ul style="list-style-type: none"> LED indicator is OFF. 	<ul style="list-style-type: none"> Check if the LCD monitor is turned ON. Check if the power source is properly connected to the LCD monitor.
<ul style="list-style-type: none"> LED indicator is AMBER. 	<ul style="list-style-type: none"> Check if the computer is turned ON. Check if the computer is in standby mode, move the mouse or press any key to wake up the computer.
The displayed texts are blurry.	<ul style="list-style-type: none"> Adjust the IMAGE SETTING (see page 25).
The OSD menu can't be called out.	<ul style="list-style-type: none"> The OSD is locked. To unlock the OSD, see page 17.
Red, blue, green, white dots appear on screen.	<ul style="list-style-type: none"> There are millions of micro transistors inside the LCD monitor. It is normal for a few transistors to be damaged and to produce spots. This is acceptable and is not considered a failure.
No audio output.	<ul style="list-style-type: none"> Check if the volume is set to 0 (see page 17 or 30). Check if the AUDIO SETTING > AUDIO setting is set to OFF (see page 30).
Cannot adjust the backlight setting.	<ul style="list-style-type: none"> The DCR and ECOSMART SENSOR functions are enabled. To disable both functions, set the SYSTEM > DCR and ECOSMART SENSOR > ENABLE setting to OFF (see page 31 and 32).
The displayed picture looks distorted.	<ul style="list-style-type: none"> Adjust the aspect ratio (see page 27).
Dew formed on or inside the LCD monitor.	<ul style="list-style-type: none"> This normally happens when the LCD monitor is moved a cold room to a hot room temperature. Do not turn ON the LCD monitor, wait for the dew condensation to disappear.
Mist formed inside the glass surface.	<ul style="list-style-type: none"> This happens due to humid weather conditions. This is a normal occurrence. The mist will disappear after a few days or as soon as the weather stabilizes.

APPENDIX

Problem	Possible Cause and Solution
Faint shadows from a static image appear on the screen.	<ul style="list-style-type: none">• Turn off the LCD monitor for extended periods of time.• Use a screen saver or a black and white image and run it for extended periods of time.

APPENDIX

6.4 Transporting the LCD Monitor

To transport the LCD monitor for repair or shipment, place the monitor in its original packaging carton.

- 1 Place the two foam cushions on each side of the LCD monitor for protection.**
- 2 Place the LCD monitor down in the box.**
- 3 Place the accessories box on the designated area (if necessary).**
- 4 Close and tape the box.**

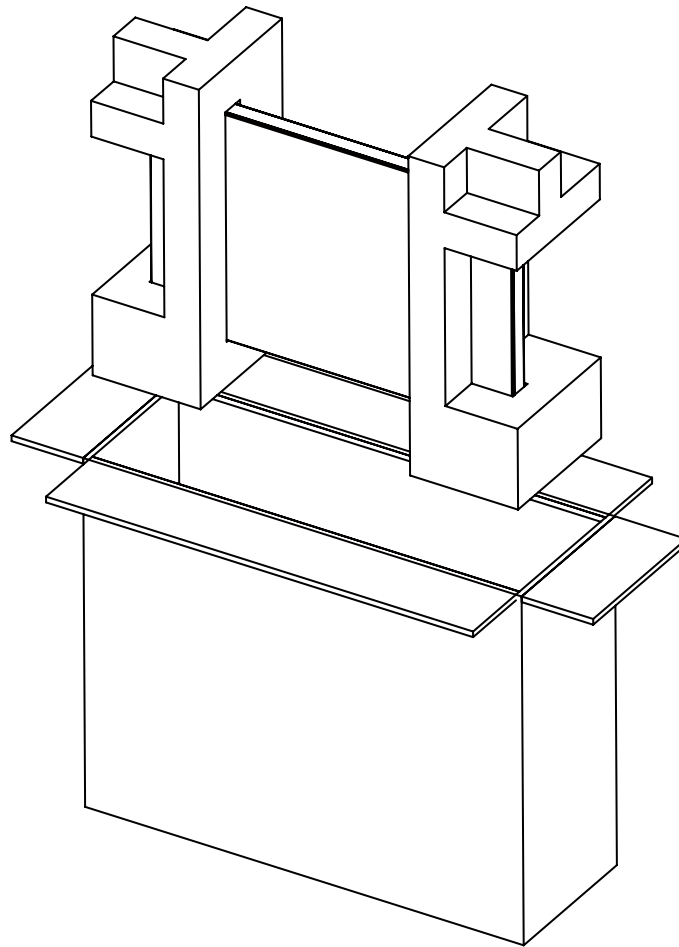

CHAPTER 7: SPECIFICATIONS

7.1 Monitor Specifications

TBX-2201		
Panel	Panel Type	LED-Backlit TFT LCD (VA Technology)
	Panel Size	21.5"
	Max. Resolution	FHD 1920 x 1080
	Pixel Pitch	0.248 mm
	Brightness	250 cd/m ²
	Contrast Ratio	20,000,000:1 (DCR)
	Viewing Angle (H/V)	178°/178°
	Display Colour	16.7M
	Response Time	5ms
	Surface Treatment	High resolution adaptable AG, 3H hard coating, Haze 25%
Frequency	H Freq.	24 kHz-83 kHz
	V Freq.	50 Hz-85 Hz
Signal Input	HDMI	1.4 x 1
Signal Output	HDMI	1.4 x 1
External Control	RS232 In	2.5 mm Phone Jack
	RS232 Out	2.5 mm Phone Jack
	LAN	RJ45 x 1
Other Connectivity	USB	2.0 x 1 (Service Port)
Audio	Internal Speakers	2W x 2
Power	Power Requirements	DC 8V ~ 36V/ 50W
	On Mode	19W (On)
	Stand-by Mode	< 2.8W
	Off Mode	< 2.8W
Glass	Thickness	3.0 mm (0.12")
	Reflection Rate	< 1%
	Transmission Rate	> 97%
	Hardness	> 9H
Operating Conditions	Temperature	0°C-40°C (32°F-104°F)
	Humidity	10%-90% (non-condensing)
Storage Conditions	Temperature	-20°C-60°C (-4°F-140°F)
	Humidity	5%-95% (non-condensing)
Mounting	VESA FPMPMI	Yes (100 x 100 mm & 75 x 75 mm)
Security	Kensington Security Slot	Yes
Dimensions	Product w/o Base (W x H x D)	507.6 x 318.7 x 68.3 mm (20.0" x 12.6" x 2.7")
	Packaging (W x H x D)	613.0 x 488.0 x 213.0 mm (24.1" x 19.2" x 8.4")
Weight	Product w/o Base	6.8 kg (15.0 lb)
	Packaging	8.2 kg (18.1 lb)

Note:

- ◆ All specifications are subject to change without prior notice.

SPECIFICATIONS

7.2 Monitor Dimensions

7.2.1 TBX-2201 Dimensions

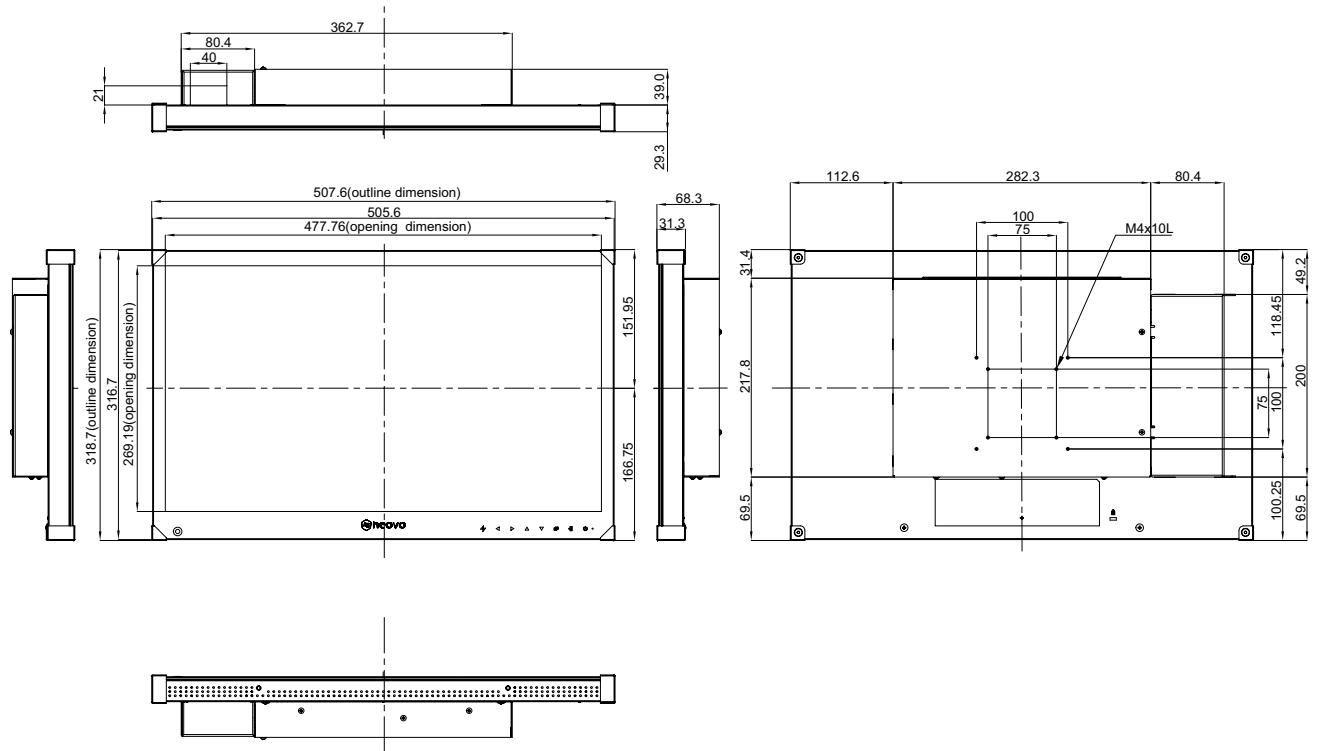

AG Neovo

Company Address: 5F-1, No. 3-1, Park Street, Nangang District, Taipei, 11503, Taiwan.

Copyright © 2020 AG Neovo. All rights reserved.

TBX210_UM_V010