

# USER MANUAL

# *ProLite*

## LCD Monitor

ENGLISH

### *ProLite T2254MSC*

Thank you very much for choosing the iiyama LCD monitor.

We recommend that you take a few minutes to read this comprehensive manual carefully before installing and switching on the monitor. Please keep this manual in a safe place for your future reference.



**Dear user, we congratulate you on the purchase of your iiyama LCD.**

For details on warranty and locally used pixel policies that apply directly after installation of your product please check the iiyama website.

**To report a fault, please contact your local support centre found at [www.iiyama.com/service](http://www.iiyama.com/service)**

**Things to check before you call the iiyama information line**

- | if the power cable is connected securely and turned on?
- | if the display has been turned on?
- | if the signal cable is connected securely and the correct input selected?
- | if the computer has been restarted with the display connected?
- | if the graphics card is correctly installed with the latest drivers possible?
- | if the correct native resolution has been selected via 'Display Properties'?
- | If the R/G/B signal configuration is correct?
- | if the displays On Screen Menu is shown?
- | if the correct brightness and contrast settings have been set?
- | if given display tolerances and compatibility have been considered?
- | if via the On Screen Menu you have performed a Factory Reset/Recall?

**Before reporting the screen defect, please prepare the following information/evidence:**

- | model number \*
- | purchase receipt and serial number \*
- | name and address for collection
- | telephone/fax number, for availability during the day
- | convenient collection date (date, time)
- | short description of the defect

**Important Note:**

If there is no fault found in the collected equipment after inspection, the transferring party shall incur charges for transport and administration.

If you have checked all of the above and there is still no picture, call our information line for assistance in your country.

\* see the identification plate on the back of the case.

## CE MARKING DECLARATION OF CONFORMITY

This LCD monitor complies with the requirements of the EC/EU Directive 2014/30/EU "EMC Directive", 2014/35/EU "Low Voltage Directive", 2009/125/EC "ErP Directive" and 2011/65/EU "RoHS Directive".

The electro-magnetic susceptibility has been chosen at a level that gives correct operation in residential areas, business and light industrial premises and small-scale enterprises, inside as well as outside of the buildings. All places of operation are characterised by their connection to the public low voltage power supply system.

IYYAMA CORPORATION: Wijkmeerstraat 8, 2131 HA Hoofddorp, The Netherlands

Model No. : PLT2254M



We recommend recycling of used product. Please contact your dealer or iiyama service center. Recycle information is obtained via the Internet, using the address: <http://www.iiyama.com>

You can access the Web page of different countries from there.

- We reserve the right to change specifications without notice.
- All trademarks used in this user manual are the property of their respective owners.
- As an ENERGY STAR® Partner, iiyama has determined that this product meets the ENERGY STAR® guidelines for energy efficiency.
- This product qualifies for ENERGY STAR® in the "factory default" setting and this is the setting in which power saving will be achieved. Changing the factory default picture settings or enabling other features will increase power consumption that could exceed the limits necessary to qualify for ENERGY STAR® rating.
- Eprel registration number T2254MSC-B1AG : 1339100

# TABLE OF CONTENTS

FOR YOUR SAFETY.....	1
SAFETY PRECAUTIONS.....	1
SPECIAL NOTES ON LCD MONITORS.....	3
CUSTOMER SERVICE.....	3
CLEANING.....	3
BEFORE YOU OPERATE THE MONITOR.....	4
FEATURES.....	4
CHECKING THE CONTENTS OF THE PACKAGE.....	4
INSTALLATION.....	5
CONTROLS AND CONNECTORS.....	6
CONNECTING YOUR MONITOR.....	7
COMPUTER SETTING.....	8
ADJUSTING THE VIEWING ANGLE.....	10
OPERATING THE MONITOR.....	11
ADJUSTMENT MENU CONTENTS.....	12
STANDBY FEATURE.....	18
TROUBLE SHOOTING.....	19
RECYCLING INFORMATION.....	20
APPENDIX.....	21
SPECIFICATIONS.....	21
DIMENSIONS.....	22
COMPLIANT TIMING.....	22

# FOR YOUR SAFETY

## SAFETY PRECAUTIONS

### WARNING

#### **STOP OPERATING THE MONITOR WHEN YOU SENSE TROUBLE**

If you notice any abnormal phenomena such as smoke, strange sounds or fumes, unplug the monitor and contact your dealer or iiyama service center immediately. Further use may be dangerous and can cause fire or electric shock.

#### **NEVER REMOVE THE CABINET**

High voltage circuits are inside the monitor. Removing the cabinet may expose you to the danger of fire or electric shock.

#### **DO NOT PUT ANY OBJECT INTO THE MONITOR**

Do not put any solid objects or liquids such as water into the monitor. In case of an accident, unplug your monitor immediately and contact your dealer or iiyama service center. Using the monitor with any object inside may cause fire, electric shock or damage.

#### **INSTALL THE MONITOR ON A FLAT, STABLE SURFACE**

The monitor may cause an injury if it falls or is dropped.

#### **DO NOT USE THE MONITOR NEAR WATER**

Do not use where water may be splashed or spilt onto the monitor as it may cause fire or electric shock.

#### **OPERATE UNDER THE SPECIFIED POWER SUPPLY**

Be sure to operate the monitor only with the specified power supply. Use of an incorrect voltage will cause malfunction and may cause fire or electric shock.

#### **CORRECT USE OF THE AC ADAPTER**

Use only the AC Adapter provided by iiyama. Any deviation from this by using another type of adapter may result in damage to the accessory and the monitor by fire or electric shock.

#### **DO NOT DISASSEMBLE THE AC ADAPTER**

Disassembling the AC Adapter may expose you to the danger of fire or electric shock.

#### **PROTECT THE CABLES**

Do not pull or bend the AC adapter, the power cable and signal cable. Do not place the monitor or any other heavy objects on the cables. If damaged, the cables may cause fire or electric shock.

#### **ADVERSE WEATHER CONDITIONS**

It is advisable not to operate the monitor during a heavy thunder storm as the continual breaks in power may cause malfunction. It is also advised not to touch the plug in these circumstances as it may cause electric shock.

## CAUTION

### INSTALLATION LOCATION

Do not install the monitor where sudden temperature changes may occur, or in humid, dusty or smoky areas as it may cause fire, electric shock or damage. You should also avoid areas where the sun shines directly on the monitor.

### DO NOT PLACE THE MONITOR IN A HAZARDOUS POSITION

The monitor may topple and cause injury if not suitably located. Please also ensure that you do not place any heavy objects on the monitor, and that all cables are routed such that children may not pull the cables and possibly cause injury.

### MAINTAIN GOOD VENTILATION

Ventilation slots are provided to keep the monitor from overheating. Covering the slots may cause fire. To allow adequate air circulation, place the monitor at least 10cm (or 4 inches) from any walls.

When removing the tilt stand, the ventilation slots on the back side of the monitor can be blocked. This may overheat the monitor and may cause fire or damage. Make sure to allow enough ventilation when removing the tilt stand. Operating the monitor on its back, side, upside down or on a carpet or any other soft material may also cause damage.

### DISCONNECT THE CABLES WHEN YOU MOVE THE MONITOR

When you move the monitor, turn off the power switch, unplug the monitor and be sure the signal cable is disconnected. If you do not disconnect them, it may cause fire or electric shock.

### UNPLUG THE MONITOR

If the monitor is not in use for a long period of time it is recommended that it is left unplugged to avoid accidents.

### HOLD THE PLUG WHEN DISCONNECTING

To disconnect the AC adapter, the power cable or signal cable, always pull it by the plug. Never pull on the cable itself as this may cause fire or electric shock.

### DO NOT TOUCH THE PLUG WITH WET HANDS

Pulling or inserting the plug with wet hands may cause electric shock.

### WHEN YOU INSTALL THE MONITOR ON YOUR COMPUTER

Be sure the computer is strong enough to hold the weight of the monitor, otherwise, you may damage your computer.

### CAREFUL! PROTECT YOUR HANDS AND FINGERS

- Be careful not to hurt your fingers or hands when you change the height or the angle.
- Injury can occur if care is not taken to avoid finger contact with the displays base when adjusting the height. (Just for height adjustable model.)

### REMARK FOR 24/7 USAGE

This product is not specifically designed for 24/7 usage in all environments.

### REMARK FOR WALL MOUNTING

This product is not designed for digital signage (electronic signboard) applications such as wall mounting.

## OTHERS

### ERGONOMIC RECOMMENDATIONS

To eliminate eye fatigue, do not operate the monitor against a bright background or in a dark room. For optimal viewing comfort, the monitor should be just below eye level and 40-60 cm (16-24 inches) away from your eyes. When using the monitor over a prolonged time, a ten minute break every hour is recommended as looking at the screen continuously can cause eye strain.

## SPECIAL NOTES ON LCD MONITORS

The following symptoms are normal with LCD monitors and do not indicate a problem.

- NOTE**
- When you first turn on the LCD monitor, the picture may not fit in the display area because of the type of computer that is used. In this case, adjust the picture position to the correct position.
  - You may find slightly uneven brightness on the screen depending on the desktop pattern you use.
  - Due to the nature of the LCD screen, an afterimage of the previous screen may remain after switching the image, when the same image is displayed for hours. In this case, the screen can be recovered slowly by changing the image or turning off the Power Switch for some hours.

## CUSTOMER SERVICE

- NOTE**
- If you have to return your unit for service and the original packaging has been discarded, please contact your dealer or iiyama service center for advice or replacement packaging.

## CLEANING

- WARNING**
- If you drop any materials or liquids such as water into the monitor when cleaning, unplug the power cable immediately and contact your dealer or iiyama service center.

- CAUTION**
- For safety reasons, turn off the power switch and unplug the monitor before you clean it.

- NOTE**
- To protect the LCD panel, do not scratch or rub the screen with a hard object.
    - Do not touch the screen with any item harder than a HB pencil lead.
    - Avoid using towels, paper towels, tissue paper and abrasive cloths.
    - Do not rub the screen using dust wipes with cleaning agents.
  - Never use any of the following strong solvents.  
Spraying or pouring liquids directly on the surface on the LCD screen and cabinet can cause damage to them.
 

Thinner	Spray-type cleaner	Bleach
Benzine	Wax	Peroxides (including hydrogen peroxide)
Abrasive cleaner	Acid or Alkaline solvent	Acetone
Ammonia	Ethyl alcohol	Toluene
  - Wipe off saliva and water drops as soon as possible as prolonged contact with polarizer causes deformations and color fading.
  - Touching the cabinet with any product made from rubber or plastic for a long time may cause degeneration or loss of paint on the cabinet.

**CABINET**     Stains can be removed with a cloth lightly moistened with a mild detergent solvent. The wipe the cabinet with a soft dry cloth.

**LCD**             Periodic cleaning with a soft dry cloth is recommended.

**SCREEN**        Remove dust and other particles using a clean microfiber cloth.

1. Moisten a microfiber cloth with a non-ammonia, non-alcohol based, mild non-abrasive detergent.
2. Wipe the screen gently with the moistened cloth.

# BEFORE YOU OPERATE THE MONITOR

## FEATURES

- ◆ Supports Resolutions up to 1920 × 1080
- ◆ High Contrast 1000:1 (Typical) / Brightness 250cd/m<sup>2</sup> (Typical)
- ◆ Quick Response Time 5ms (Gray to Gray)
- ◆ Digital Character Smoothing
- ◆ Stereo Speakers  
2 × 2.5W Stereo Speakers
- ◆ Standby Feature
- ◆ ENERGY STAR® Compliant
- ◆ VESA Mounting Standard (100mm×100mm) Compliant
- ◆ Keyhole for Security Lock
- ◆ 10point Touch

## CHECKING THE CONTENTS OF THE PACKAGE

The following accessories are included in your package. Check to see if they are enclosed with the monitor. If anything is missing or damaged, please contact your local iiyama dealer or regional iiyama office.

- Power Cable\*
- HDMI Cable
- USB Cable
- Safety Guide
- Quick Start Guide

## CAUTION

\* The rating of the Power Cable enclosed in 120V area is 10A/125V. If you are using a power supply higher than this rating, then a power cable with a rating of 10A/250V must be used. However, all guarantees and warranties are void for any problems or damage caused by a power cable not supplied by iiyama.

An approved power cable greater or equal to H05VVF, 3G, 0.75mm<sup>2</sup> must be used.



# INSTALLATION

## CAUTION

- Before installation, make sure the display arm or desk arm stand is strong enough to hold the necessary weight of the display and the mount.
- Angle adjustment range :  
89 degrees upward and 3.5 degrees downward

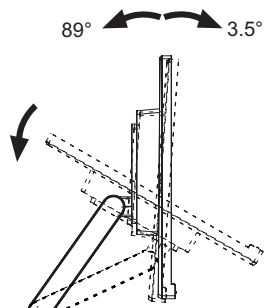

## < DISPLAY ARM OR DESK ARM STAND >

## CAUTION

When you use with the display arm or desk arm stand, in consideration of thickness of the mounting stage, tighten the M4 Screws (4pcs) which "L" length is 8mm to fasten the monitor. Using the screw longer than this may cause electric shock or damage because it may contact with the electrical parts inside the monitor.

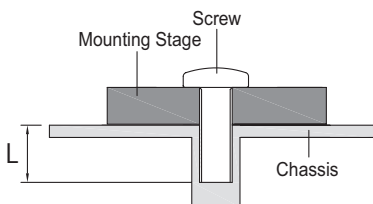

## < ROTATING THE MONITOR >

The monitor is designed to be compatible only with the landscape mode.

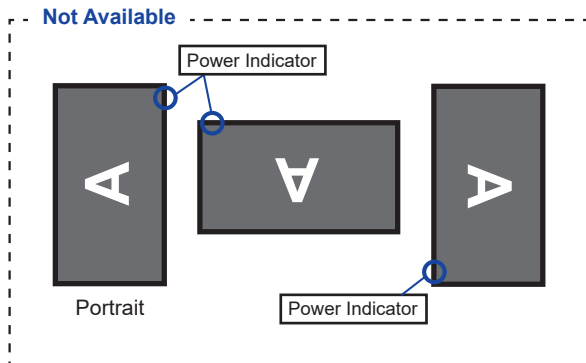
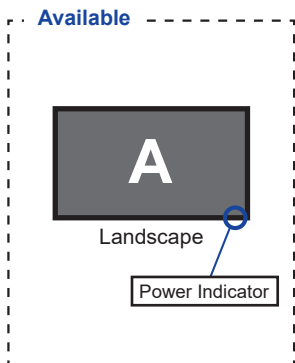

## CONTROLS AND CONNECTORS

<Front>

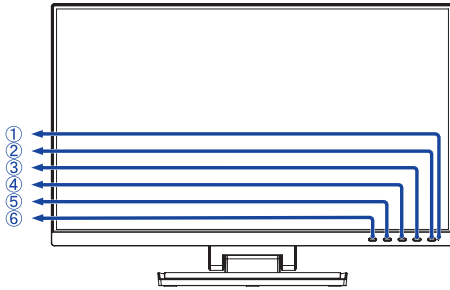

<Back>

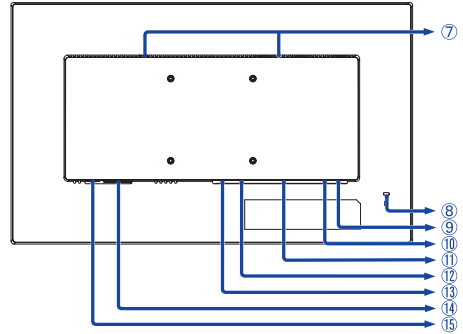

- ① Power Indicator

**NOTE** Blue: Normal operation  
Orange: Standby mode

- ② Power Switch (  )
- ③ Menu Button (MENU)
- ④ + Button ( + )
- ⑤ - Button ( - )
- ⑥ Exit Button (EXIT)

- ⑦ Speakers

- ⑧ Keyhole for Security Lock

**NOTE** You can fasten a security lock and cable to prevent the monitor from being removed without your permission.

- ⑨ USB Downstream Connector (USB 5V, 900mA)
- ⑩ USB Upstream / Touch I/F Connector (USB UP)
- ⑪ Headphone connector (AUDIO OUT)
- ⑫ HDMI Connector (HDMI)
- ⑬ DisplayPort Connector (  )
- ⑭ AC Connector ( ~ : Alternating current ) ( ~ )
- ⑮ Main Power Switch

## CONNECTING YOUR MONITOR

- ① Ensure that both the computer and the monitor are switched off.
- ② Connect the computer to the monitor with the signal cable.
- ③ Connect the computer to the monitor with the USB Cable.
- ④ Connect the Power Cable to the monitor first and then to the power source.
- ⑤ Turn on your monitor (Main Power Switch and Power Switch) and computer.

### NOTE

- Make sure that the building installation has a circuit breaker of 120/240V, 20A (maximum).
- The signal cables used for connecting the computer and monitor may vary with the type of computer used. An incorrect connection may cause serious damage to both the monitor and the computer. The cable supplied with the monitor is for a standard connector. If a special cable is required please contact your local iiyama dealer or regional iiyama office.
- Make sure you tighten the finger screws at each end of the Signal Cable.
- The Class I pluggable equipment Type A must be connected to protective earth.
- The socket-outlet shall be installed near the equipment and shall be easily accessible.
- Excessive sound pressure from ear-/headphones can cause hearing damage/hearing loss.

[Example of Connection]

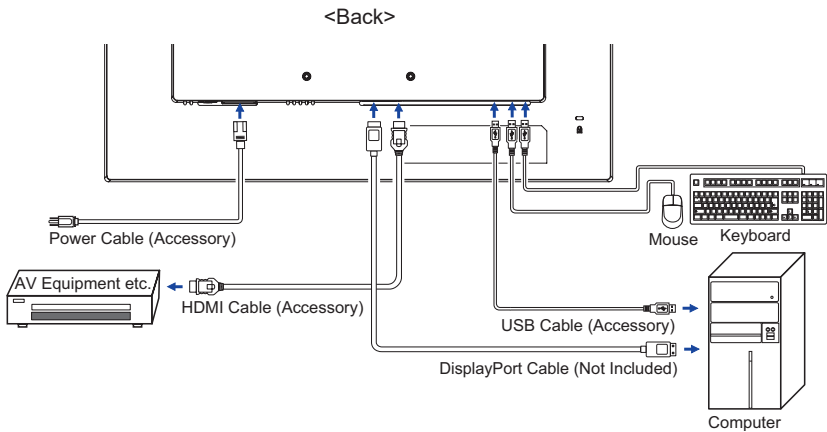

## COMPUTER SETTING

### ■ Signal Timing

Change to the desired signal timing listed on page 22: COMPLIANT TIMING.

### ■ TOUCH support operation system

	Mouse	Digitizer	Gestures* <sup>1</sup>
Windows8/8.1/10/11	○	○	○
Mac OS/OS X	×	×	×
Linux/Android	×	×	×
Functions	Click Drag Double-Click	Mouse function Right-Click Flick Visual feedback	Mouse & Digitizer functions Press & Tap, Rotate, Zoom-in/out

The other OS Versions not listed are not supported.

○ : Supported × : Not supported

\*<sup>1</sup> Gestures can be supported by application programs.

### ● PALM REJECTION FUNCTION:

Palm rejection is a way to disregard touch made with "a large contact area" while finger modes.

A large contact area : palm, clenched fist, elbow, arm, etc. 30mm<sup>2</sup> or more.

When you touch the screen with a finger, palm rejection is activated and the screen does not recognize touch made with the large contact area.

## ■ Touch Input Settings in Dual Screen Mode

① Connect the primary monitor to the computer first.

Set Control Panel > Hardware and Sound > Tablet PC Settings > Display > Setup.

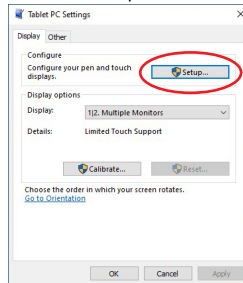
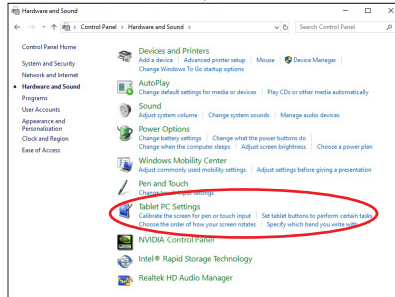
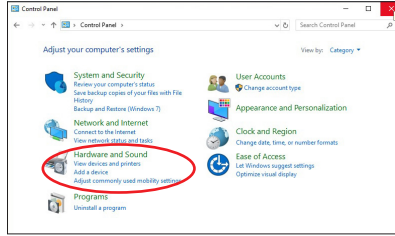

The following message will appear on the screen. Please follow the instructions.

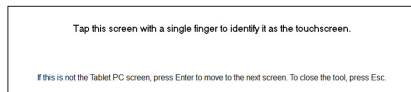

② After setting ①, connect a second monitor and perform the setup as in ①.

**NOTE** The monitors are recognized as dual-display, and touch operation cannot be performed on two monitors at the same time.

You can perform touch operation on only one of the monitors.

## ADJUSTING THE VIEWING ANGLE

- NOTE**
- Do not touch the Touch screen when you change the angle. It may cause damage or break the Touch screen and LCD screen.
  - Careful attention is required not to pinch your fingers or hands when you change the angle.

- For optimal viewing it is recommended to look at the full face of the monitor.
- You are able to adjust the monitor's height up to 343mm - 110mm, angle up to 89 degrees upward and 3.5 degrees downward.
- Hold the stand so that the monitor does not topple when you change the monitor's angle.
  - ① Put the monitor on a flat surface.
  - ② Hold the panel so that the monitor does not topple.
  - ③ We recommend that you adjust the stand to its lowest position when using the monitor in the 89 degree upward tilt position.

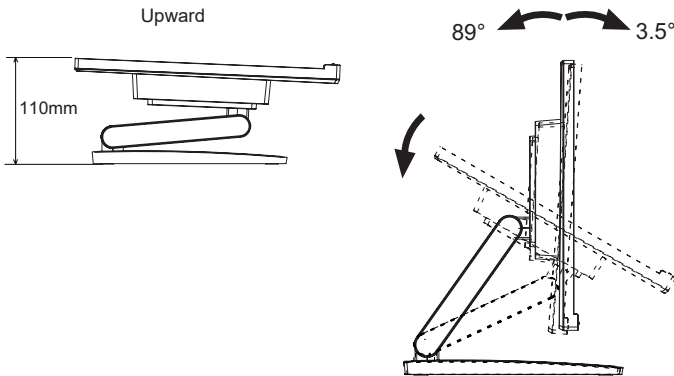

# OPERATING THE MONITOR

To create the best picture, your iiyama LCD monitor has been preset at the factory with the COMPLIANT TIMING shown on page 22. You are also able to adjust the picture by following the button operation shown below. For more detailed adjustments, see page 19 for SCREEN ADJUSTMENTS.

- ① Press the MENU Button to start the On Screen Display feature. There are additional Menu items which can be switched by using the + / – Buttons.



- ② Select the Menu item which contains the adjustment icon relating to the adjustment you want to make. Press the MENU Button. Then, use the + / – Buttons to highlight the desired adjustment icon.
- ③ Press the MENU Button again. Use the + / – Buttons to make the appropriate adjustment or setting.
- ④ Press the EXIT Button to leave the menu, and the settings you just made would be automatically saved.

For example, to correct for OSD vertical position, select Menu item of OSD and then press the MENU Button. Then, select OSD Vertical Position by using the + / – Buttons.

An adjustment page appears after you press the MENU Button. Then, use the + / – Buttons to change the OSD vertical position settings. The OSD vertical position of the overall display should be changing accordingly while you are doing this.

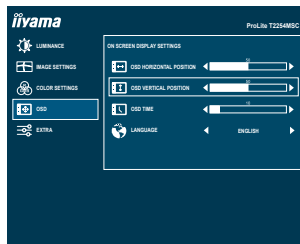





Press the EXIT Button lastly, it ends, all changes are saved in the memory.

## NOTE

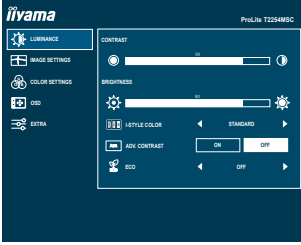
- When button operations are aborted during adjustment, On-Screen Display disappears when the time set for the OSD Time has passed. Also, the EXIT button can be used to return previous menu and turn off the On-Screen Display.
- Any changes are automatically saved in the memory when the On Screen Display disappears. Turning off the power should be avoided while using the Menu.
- All adjustments have only one setting which applies to all signal timings.

# ADJUSTMENT MENU CONTENTS

 <b>Luminance</b>			
Adjustment Item	Problem / Option		Button to Press
Contrast	Too dull Too intense		 <b>+</b>  <b>-</b>
Brightness* <sup>1</sup>	Too dark Too bright		 <b>+</b>  <b>-</b>
i-Style Color* <sup>2</sup>	Standard	For general windows environment and monitor default setting.	
	Text	For text editing and viewing in a word processing environment.	
	Internet	For internet environment.	
	Game	For PC game environment.	
	Movie	For movie and video environment.	
Adv. Contrast	On	Increased Contrast Ratio	
	Off	Typical Contrast Ratio	
<p><b>NOTE</b> Adv. Contrast adjusts brightness according to the image, and improve the contrast ratio during movie playing.          Contrast, Brightness, Gamma, Color Temp., Eco and i-Style Color cannot be adjusted and selected while Adv. Contrast is active.</p>			
Eco	<b>Direct</b>	Off	Normal
		Mode1	Brightness of back-light is reduced.
		Mode2	Brightness of back-light is reduced more than Mode 1.
		Mode3	Brightness of back-light is reduced more than Mode2.

\*<sup>1</sup> Adjust the Brightness when you are using the monitor in a dark room and feel the screen is too bright.

\*<sup>2</sup> i-Style Color is disabled when Blue Light Reducer is activated.

## Direct

You can skip the Menu items and display an adjustment scale directly by using the following button operations.

- Eco: Press the – Button when the Menu is not displayed.





## Image Settings\*



Adjustment Item	Problem / Option		Button to Press
Aspect Ratio	Full	Expansion display	
	Aspect	Expansion display of Aspect	

\* This feature will be enabled when the 4:3/5:4/16:10 aspect ratio resolution is changed and the display/ scaling of the display setting is preserved.



### Color Settings\*

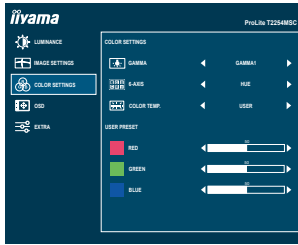

Adjustment Item	Problem / Option		Button to Press	
Gamma	Gamma1	Normal		
	Gamma2	High contrast		
	Gamma3	Dark		
6 Axis	Hue	Red	Too weak Too strong	<input type="button" value="+"/> <input type="button" value="-"/>
		Yellow		
		Green		
		Cyan		
		Blue		
		Magenta		
	Saturation	Red	Too weak Too strong	<input type="button" value="+"/> <input type="button" value="-"/>
		Yellow		
		Green		
		Cyan		
Blue				
Color Temp.	Warm	Warm color		
	Normal	Normal color		
	Cool	Cool color		
	User	Red	Too weak Too strong	<input type="button" value="+"/> <input type="button" value="-"/>
		Green		
		Blue		
		sRGB		

**NOTE**

- sRGB is an international standard which defines and unifies the difference of color appearance between equipment.
- You can not adjust the Brightness, Contrast, i-Style Color, Adv. Contrast, Gamma, Blue Light Reducer and Eco during sRGB mode because those settings are locked.

\* Color Settings adjustments is disabled when Blue Light Reducer is activated.



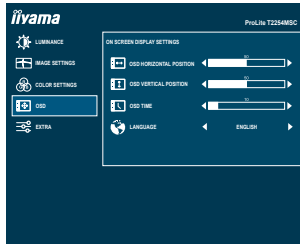

# OSD

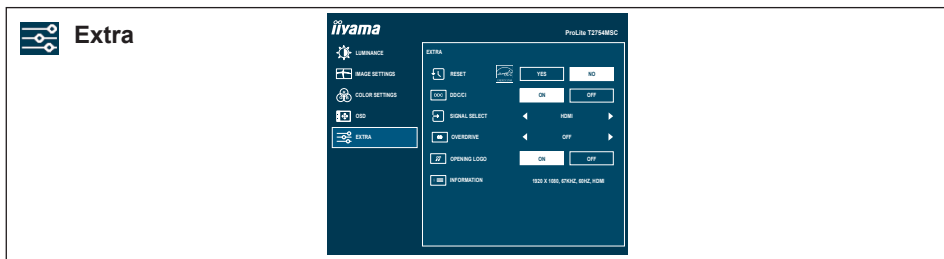

Adjustment Item	Problem / Option		Button to Press	
OSD Horizontal Position	OSD is too left OSD is too right			
OSD Vertical Position	OSD is too low OSD is too high			
OSD Time	You can set the OSD display duration time between 5 and 100 seconds.			
Language	English	English	Polski	Polish
	Français	French	Русский	Russian
	Deutsch	German	日本語	Japanese
	Nederlands	Dutch		



Adjustment Item	Problem / Option		Button to Press
Reset	Yes	Factory-preset data is restored.	
	No	Return to Menu.	
DDC / CI	On	DDC/CI is On.	
	Off	DDC/CI is Off.	
Signal Select <b>Direct</b>	Auto	Select the signal input automatically.	
	HDMI	Select the Digital (HDMI) input.	
	DP	Select the Digital (DisplayPort) input.	
<p><b>NOTE</b> At selected the AUTO, it will automatically be selected when just one source is available. If there are more input sources available and you select one of them, the AUTO option is not available. If multiple inputs are connected, the monitor may not recover the last one used after turning it off and on again. It is only possible when you set a specific source.</p>			
OverDrive*	Off / -2 / -1 / 0 / +1 / +2 It will improve the gray level response time of the LCD panel.  A higher level results in a faster response time.		 
Opening Logo	On	Opening Logo is On.	
	Off	Opening Logo is Off.	
Information	Displays information regarding the current input signal coming from the graphic card in your computer.		
	<p><b>NOTE</b> See your graphic card user guide for more information about changing the resolution and refresh.</p>		

\* When OverDrive is activated, some level of image retention will be caused.

## Direct

You can skip the Menu items and display an adjustment scale directly by using the following button operations.



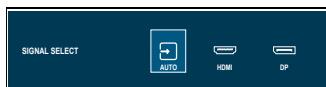

- Signal Select: Press the EXIT button when the Menu is not displayed, it shows following Menu. Press the EXIT button again to select input source and then press the MENU button.



## Direct

You can skip the Menu items and display an adjustment scale directly by using the following button operations.

- Volume: Press the + Button when the Menu is not displayed.

Adjustment Item	Problem / Option	Button to Press
Volume	Too soft Too loud	   

- Blue Light Reducer \* : Pressing and holding of the + Button for 3-4 seconds when the Menu is not displayed.  
Off : Normal  
Mode1 : Blue light is reduced.  
Mode2 : Blue light is reduced more than Mode1.  
Mode3 : Blue light is reduced more than Mode2.

\* Blue Light Reducer cannot be enabled if i-Style Color, Adv.Contrast or sRGB colour are enabled.

- Lock Mode:

### <OSD>

Hold the MENU button and turn on the monitor when the monitor is power-off, it will lock/unlock the OSD Key Lock function.

### <Power/OSD>

Pressing and holding the MENU button for 10 seconds when Menu is not displayed, will lock/unlock the Power/OSD Key Lock function.

## STANDBY FEATURE

This product features the standby function. When activated, it automatically reduces unnecessary power consumption of the monitor when your computer is not in use.

There is a standby step the monitor takes as described below. The standby function, including any timer settings is configured by the operating system. Check your operating system manual for information on how this can be configured.

### ■ Standby Mode

When the video signal from the computer is off, the monitor enters into Standby Mode which reduces the power consumption to less than 0.5W\*. The screen becomes dark, and the power indicator turns to orange. From Standby Mode, the image reappears in several seconds when either the keyboard or the mouse are touched again.

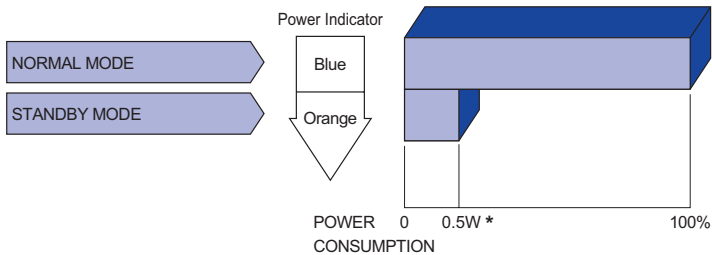

\* When the USB devices are not connected.

# TROUBLE SHOOTING

If the monitor fails to operate correctly, please follow the steps below for a possible solution.

1. Perform the adjustments described in OPERATING THE MONITOR, depending on the problem you have. If the monitor does not get a picture, skip to 2.
2. Consult the following items if you cannot find an appropriate adjustment item in OPERATING THE MONITOR or if the problem persists.
3. If you are experiencing a problem which is not described below or you cannot correct the problem, discontinue using the monitor and contact your dealer or iiyama service center for further assistance.

<b>Problem</b>	<b>Check</b>
① The picture does not appear. (Power indicator does not light up.)  (Power indicator is blue.)  (Power indicator is orange.)	<input type="checkbox"/> The Power Cable is firmly seated in the socket. <input type="checkbox"/> The Power Switch is turned ON. <input type="checkbox"/> The AC socket is live. Please check with another piece of equipment. <input type="checkbox"/> If the blank screen saver is in active mode, touch the keyboard or the mouse. <input type="checkbox"/> Increase the Contrast and/or Brightness. <input type="checkbox"/> The computer is ON. <input type="checkbox"/> The Signal Cable is properly connected. <input type="checkbox"/> The signal timing of the computer is within the specification of the monitor. <input type="checkbox"/> If the monitor is in standby mode, touch the keyboard or the mouse. <input type="checkbox"/> The computer is ON. <input type="checkbox"/> The Signal Cable is properly connected. <input type="checkbox"/> The signal timing of the computer is within the specification of the monitor.
② The screen is not synchronized.	<input type="checkbox"/> The Signal Cable is properly connected. <input type="checkbox"/> The signal timing of the computer is within the specification of the monitor.
③ The screen position is not in the center.	<input type="checkbox"/> The signal timing of the computer is within the specification of the monitor.
④ The screen is too bright or too dark.	<input type="checkbox"/> The video output level of the computer is within the specification of the monitor.
⑤ The screen is shaking.	<input type="checkbox"/> The power voltage is within the specification of the monitor. <input type="checkbox"/> The signal timing of the computer is within the specification of the monitor.
⑥ No sound.	<input type="checkbox"/> The audio equipment (computer etc.) is ON. <input type="checkbox"/> The Audio Cable is properly connected. <input type="checkbox"/> The Volume is turned up. <input type="checkbox"/> The Mute is OFF. <input type="checkbox"/> The audio output level of the audio equipment is within the specification of the monitor.
⑦ The sound is too loud or too quiet.	<input type="checkbox"/> The audio output level of the audio equipment is within the specification of the monitor.

## Problem

## Check

- ⑧ A strange noise is heard.  The Audio Cable is properly connected.
- ⑨ The touch screen shows no response.  The USB Cable is firmly seated in the socket.  
 Touch screen driver software is installed.
- ⑩ The touch position does not deviate.  The calibration function set up correctly.

## RECYCLING INFORMATION

For better environment protection please don't dispose your monitor.  
Please visit our web site: [www.iiyama.com](http://www.iiyama.com) for monitor recycling.



# APPENDIX

Design and specifications are subject to change without prior notice.

## SPECIFICATIONS

Touch Screen	Technology	Projected capacitive 10pts
	Communication system	USB 2.0
	Surface finish	Anti-glare treatment
Size Category		21.5"
LCD Panel	Panel technology	IPS
	Size	Diagonal: 21.5" (54.61cm)
	Pixel pitch	0.24795mm H × 0.24795mm V
	Brightness	250cd/m <sup>2</sup> (Typical), 160cd/m <sup>2</sup> (Default / Energy Saving)
	Contrast ratio	1000 : 1 (Typical: with Touch Panel)
	Viewable angle	Horizontal : 178 degrees, Vertical: 178 degrees (Typical)
	Response time	4ms (Gray to Gray) <sup>*1</sup>
Display Colors		Approx.16.7M
Sync Frequency		Horizontal: 30.0-83.0kHz, Vertical: 48-75Hz
Native Resolution		1920 × 1080, 2.1 MegaPixels
Support max. resolution		HDMI: 1920 × 1080 75Hz DisplayPort: 1920 × 1080 75Hz
Input Connector		HDMI, DisplayPort
Input Video Signal		Digital: HDMI, DisplayPort
USB Standard		USB3.0 (DC5V, 900mA)
Number of USB Ports		1 Upstream : Series B
Connector shape		2 Downstream : Series A
Headphone Connector		ø 3.5mm mini jack (Stereo)
Speakers		2.5W × 2 (Stereo speakers)
Maximum Screen Size		476.06mm W × 267.79mm H / 18.7" W × 10.5" H
Power Source		100-240VAC, 50/60Hz, 1.5A
Power Consumption <sup>*2</sup>		19W typical, Standby mode: 0.5W maximum, Off mode: 0.3W maximum
Dimensions / Net Weight		488.5 × 343.0 - 110.0 × 238.5mm / 19.2 × 13.5 - 4.3 × 9.4" (W×H×D) 4.9kg / 10.8lbs
Tilt Angle		Upward: 89 degrees Downward: 3.5 degrees
Environmental Considerations		Operating: Temperature 5 to 35°C / 41 to 95°F Humidity 10 to 85% (No condensation) Storage: Temperature -20 to 60°C / -4 to 140°F Humidity 10 to 90% (No condensation)
Approvals		CE, UKCA, EAC, ENERGY STAR®

### NOTE

<sup>\*1</sup> When OverDrive is set to +2.

<sup>\*2</sup> When the USB devices are not connected.

## DIMENSIONS

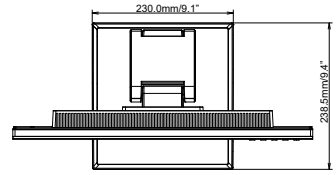
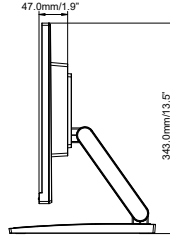
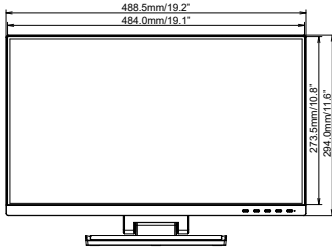

ENGLISH

## COMPLIANT TIMING

Video Mode	Horizontal Frequency	Vertical Frequency	Dot Clock
640 × 480	31.469kHz	59.940Hz	25.175MHz
	37.500kHz	75.000Hz	31.500MHz
800 × 600	35.156kHz	56.250Hz	36.000MHz
	37.879kHz	60.317Hz	40.000MHz
	46.875kHz	75.000Hz	49.500MHz
1024 × 768	48.363kHz	60.004Hz	65.000MHz
	56.476kHz	70.069Hz	75.000MHz
	60.023kHz	75.029Hz	78.750MHz
1280 × 1024	63.981kHz	60.020Hz	108.000MHz
	79.976kHz	75.025Hz	135.000MHz
1440 × 900	55.935kHz	59.887Hz	106.500MHz
1680 × 1050	65.290kHz	59.954Hz	146.250MHz
1920 × 1080	67.500kHz	60.000Hz	148.500MHz