

# PA700S\_PA700X\_PA700W PS502X\_PS502W

## DLP Projector User Guide

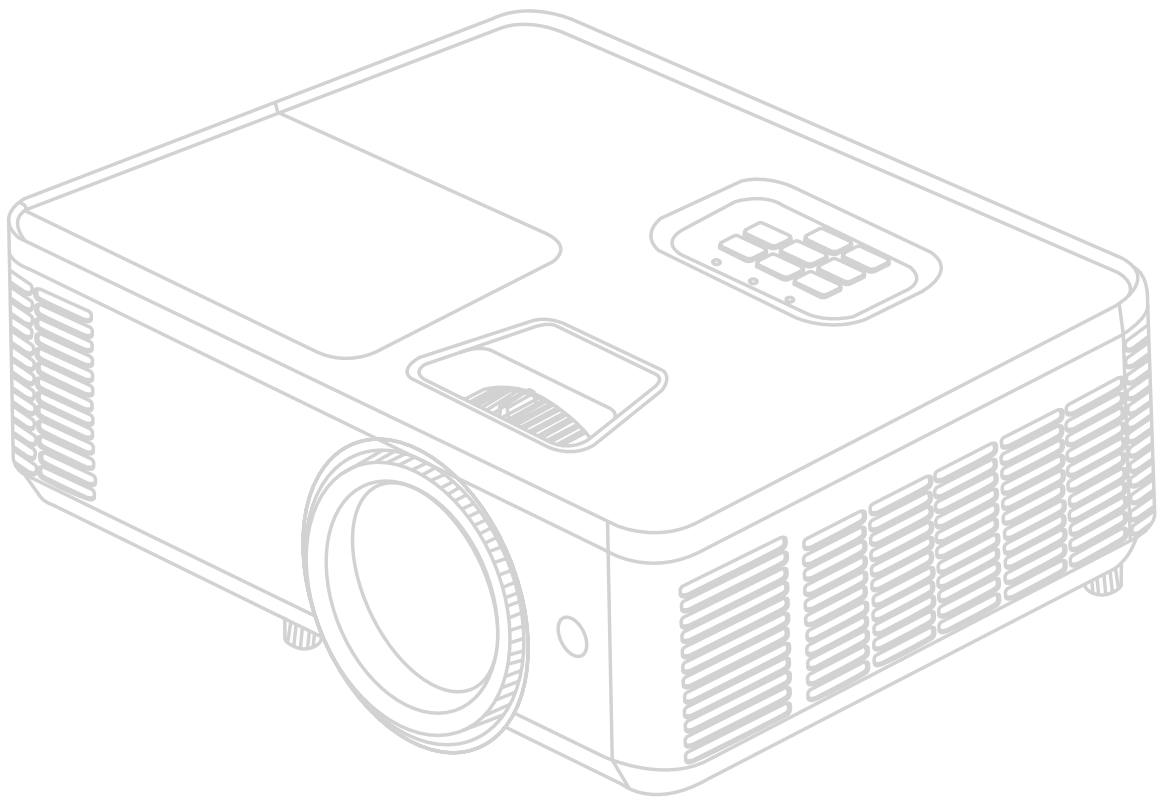

**IMPORTANT:** Please read this User Guide to obtain important information on installing and using your product in a safe manner, as well as registering your product for future service. Warranty information contained in this User Guide will describe your limited coverage from ViewSonic® Corporation, which is also found on our web site at <http://www.viewsonic.com> in English, or in specific languages using the Regional selection box of our website.

Model No. VS19341 | VS19343 | VS19342 | VS19344 | VS19345  
P/N: PA700S | PA700X | PA700W | PS502X | PS502W

## **Thank you for choosing ViewSonic®**

As a world-leading provider of visual solutions, ViewSonic® is dedicated to exceeding the world's expectations for technological evolution, innovation, and simplicity. At ViewSonic®, we believe that our products have the potential to make a positive impact in the world, and we are confident that the ViewSonic® product you have chosen will serve you well.

Once again, thank you for choosing ViewSonic®!

# Safety Precautions

Please read the following **Safety Precautions** before you start using the projector.

- Keep this user guide in a safe place for later reference.
- Read all warnings and follow all instructions.
- Allow at least 20" (50 cm) clearance around the projector to ensure proper ventilation.
- Place the projector in a well-ventilated area. Do not place anything on the projector that prevents heat dissipation.
- Do not place the projector on an uneven or unstable surface. The projector may fall over, causing personal injury or projector malfunction.
- Do not look straight at the projector lens during operation. The intense light beam may damage your eyes.
- Always open the lens shutter or remove the lens cap when the projector lamp is on.
- Do not block the projection lens with any objects when the projector is under operation as this could cause objects to become heated and deformed or even cause a fire.
- The lamp becomes extremely hot during operation. Allow the projector to cool for approximately 45 minutes prior to removing the lamp assembly for replacement.
- Do not use lamps beyond the rated lamp life. Excessive use of lamps beyond the rated life could cause them to break on rare occasions.
- Never replace the lamp assembly or any electronic component unless the projector is unplugged.
- Do not attempt to disassemble the projector. There are dangerous high voltages inside which may cause death if you should come into contact with live parts.
- When moving the projector, be careful not to drop or bump the projector on anything.
- Do not place any heavy objects on the projector or connection cables.
- Do not stand the projector on end vertically. Doing so may cause the projector to fall over, causing personal injury or projector malfunction.
- Avoid exposing the projector to direct sunlight or other sources of sustained heat. Do not install near any heat sources such as radiators, heat registers, stoves, or other devices (including amplifiers) that may increase the temperature of the projector to dangerous levels.

- Do not place liquids near or on the projector. Liquids spilled into the projector may cause it to fail. If the projector does become wet, disconnect it from the power supply and call your local service center to have the projector serviced.
- When the projector is under operation, you may sense some heated air and odor from its ventilation grill. It is a normal operation and not a defect.
- Do not attempt to circumvent the safety provisions of the polarized or grounding-type plug. A polarized plug has two blades with one wider than the other. A grounding-type plug has two blades and a third grounding prong. The wide and third blade are provided for your safety. If the plug does not fit into your outlet, obtain an adapter and do not attempt to force the plug into the outlet.
- When connecting to a power outlet, DO NOT remove the grounding prong. Please ensure grounding prongs are NEVER REMOVED.
- Protect the power cord from being treaded upon or pinched, particularly at the plug, and at the point where it emerges from the projector.
- In some countries, the voltage is NOT stable. This projector is designed to operate safely within a voltage between 100 to 240 volts AC, but could fail if power cuts or surges of  $\pm 10$  volts occur. In areas where voltage may fluctuate or cut out, it is recommended that you connect your projector through a power stabilizer, surge protector, or uninterruptable power supply (UPS).
- If smoke, an abnormal noise, or a strange odor is present, immediately switch the projector off and call your dealer or ViewSonic®. It is dangerous to continue using the projector.
- Use only attachments/accessories specified by the manufacturer.
- Disconnect the power cord from the AC outlet if the projector is not being used for a long period of time.
- Refer all servicing to qualified service personnel.



**CAUTION:** Possibly hazardous optical radiation is emitted from this product. As with any bright light source, do not stare into the beam, RG2 IEC 62471-5:2015.

# Safety Precautions - Ceiling Mounting

Please read the following **Safety Precautions** before you start using the projector.

If you intend to mount the projector on the ceiling, it is strongly recommended that you use a proper fitting projector ceiling mount kit and that you ensure it is securely and safely installed.

If you use an inappropriate projector ceiling mount kit, there is a safety risk that the projector may fall from the ceiling due to an improper attachment through the use of the wrong gauge or length screws.

# Contents

<b>Safety Precautions.....</b>	<b>3</b>
<b>Introduction .....</b>	<b>9</b>
Package Contents - PA700S   PA700X   PA700W .....	9
Package Contents - PS502X   PS502W .....	10
Product Overview .....	11
Projector.....	11
Keypad.....	12
Indicator Lights.....	13
I/O Ports .....	14
Remote Control .....	15
<b>Initial Setup.....</b>	<b>19</b>
Choosing a Location - Projection Orientation.....	19
Projection Dimensions - PA700S   PA700X .....	20
Projection Dimensions - PA700W.....	22
Projection Dimensions - PS502X.....	24
Projection Dimensions - PS502W .....	26
Mounting the Projector .....	28
Using the Security Bar .....	28
<b>Making Connections.....</b>	<b>29</b>
Connecting to Power .....	29
Connecting to External Devices .....	30
HDMI Connection .....	30
Audio Connection.....	31
USB Type A Connection.....	32
RS-232 Connection .....	33
PC/Notebook and Monitor Connection .....	34
<b>Using the Projector.....</b>	<b>35</b>
Starting Up the Projector.....	35
Selecting an Input Source .....	36
Help Menu.....	37
Adjusting the Projected Image .....	40
Adjusting the Projector’s Height and Projection Angle.....	40
Adjusting the Focus, Keystone, and Zoom .....	41
Shutting Down the Projector .....	42

<b>Operating the Projector.....</b>	<b>43</b>
On-Screen Display (OSD) Menu .....	43
Menu Navigation .....	44
On-Screen Display (OSD) Menu Tree.....	45
Menu Operation .....	50
Image Menu .....	50
Display Menu.....	52
Setup Menu.....	55
Options Menu .....	57
<b>Appendix.....</b>	<b>60</b>
Specifications - PA700 .....	60
Specifications - PS502.....	61
Projector Dimensions .....	62
Timing Chart .....	63
Analog RGB.....	63
HDMI 3D.....	65
Troubleshooting .....	66
LED Indicators.....	68
Maintenance.....	69
General Precautions.....	69
Cleaning the Lens .....	69
Cleaning the Case .....	69
Storing the Projector .....	69

<b>Regulatory and Service Information .....</b>	<b>70</b>
Compliance Information.....	70
FCC Compliance Statement.....	70
Industry Canada Statement.....	70
CE Conformity for European Countries.....	71
Declaration of RoHS2 Compliance.....	72
Indian Restriction of Hazardous Substances .....	73
Product Disposal at End of Product Life .....	73
Copyright Information .....	74
Customer Service .....	75
Limited Warranty .....	76
Mexico Limited Warranty.....	79



# Introduction

## Package Contents - PA700S | PA700X | PA700W

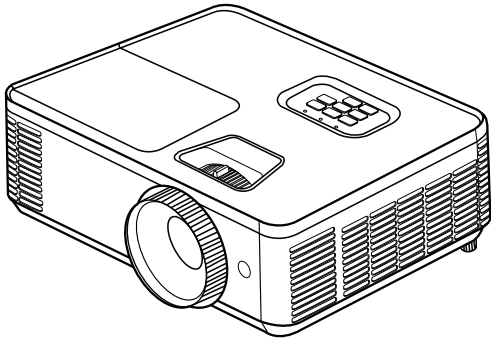

①



②

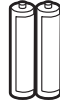

③



④

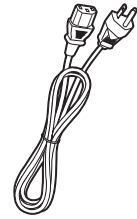

⑤

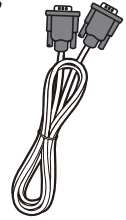

⑥

Number	Description
1	Projector
2	Remote Control
3	Batteries
4	Quick Start Guide
5	Power Cord
6	VGA Cable

**NOTE:** The power cord and remote control included in your package may vary depending on your country. Please contact your local reseller for more information.

# Package Contents - PS502X | PS502W

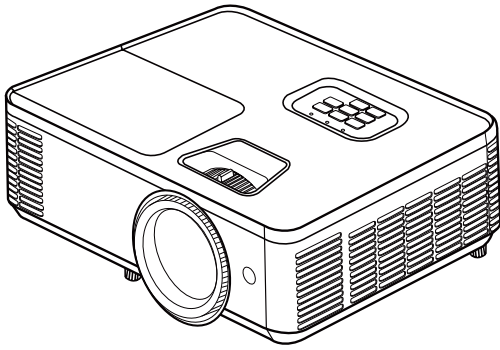

①

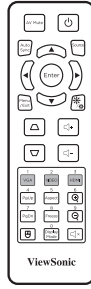

②

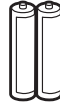

③



④

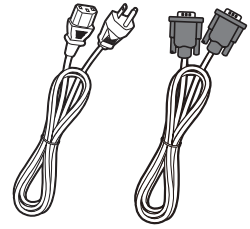

⑤

⑥

Number	Description
1	Projector
2	Remote Control
3	Batteries
4	Quick Start Guide
5	Power Cord
6	VGA Cable

**NOTE:** The power cord and remote control included in your package may vary depending on your country. Please contact your local reseller for more information.

# Product Overview

## Projector

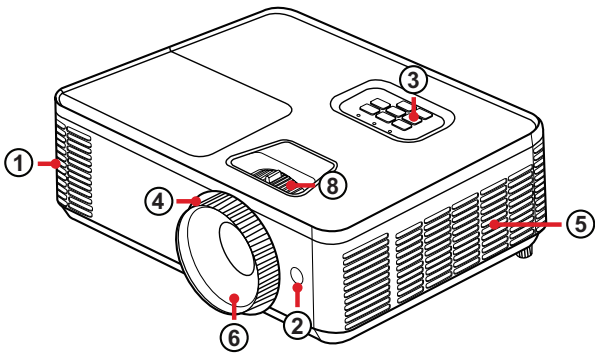

PA700 Series

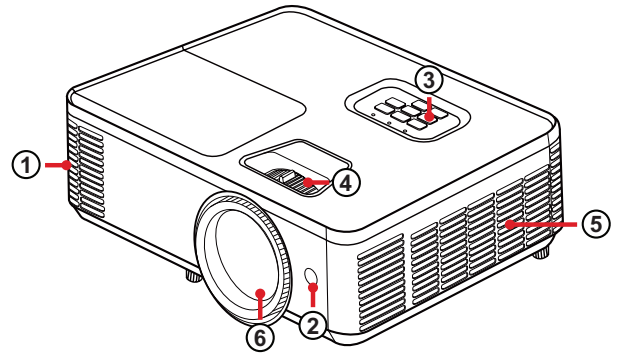

PS502 Series

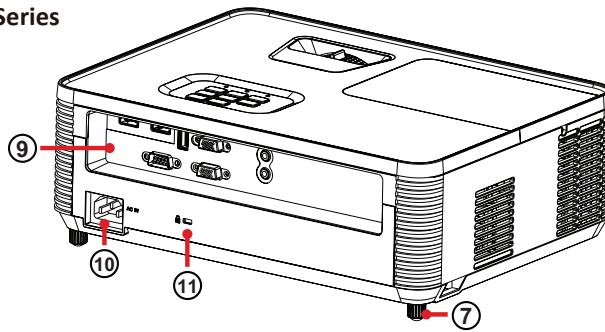





Number	Description
1	Vent (outlet)
2	IR Receiver
3	Keypad
4	Focus Ring
5	Vent (inlet)
6	Projection Lens
7	Adjuster Foot
8	Zoom Ring
9	I/O Ports
10	AC IN
11	Security Lock

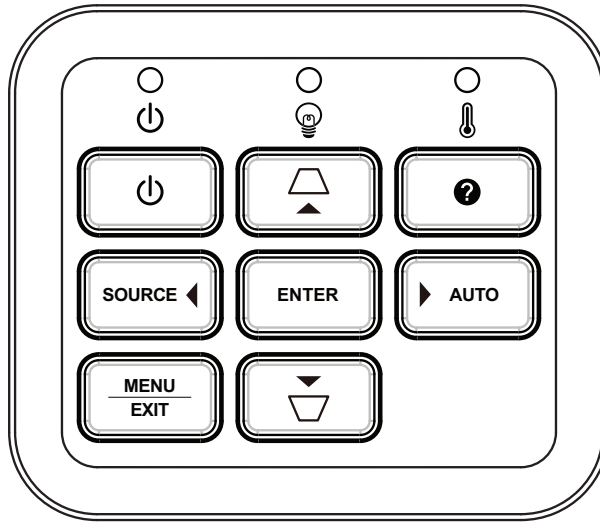

**NOTE:** Do not block projector intake and exhaust vents.

# Keypad



Key		Description
	<b>Power</b>	Toggles the projector between standby mode and Power On.
	<b>Keystone</b>	Manually corrects distorted images resulting from an angled projection when the On-Screen Display (OSD) Menu is activated.
	<b>Navigation</b>	Selects the desired menu items and makes adjustments when the On-Screen Display (OSD) Menu is activated.
	<b>Menu/Exit</b>	<ul style="list-style-type: none"> <li>• Activate the On-Screen Display (OSD) Menu.</li> <li>• Go back to previous level in the OSD Menu.</li> <li>• Exit and save menu settings.</li> </ul>
<b>SOURCE</b>	<b>Source</b>	Toggle to the next input source.
	<b>Help</b>	Displays the Help menu.
<b>ENTER</b>	<b>Enter</b>	Confirm the selection when the On-Screen Display (OSD) Menu is activated.
<b>AUTO</b>	<b>Auto</b>	Automatically synchronize the projector to the input source.

## Indicator Lights

Indicator Light	Description
	Power indicator light
	Light source indicator light
	Temperature indicator light

## I/O Ports

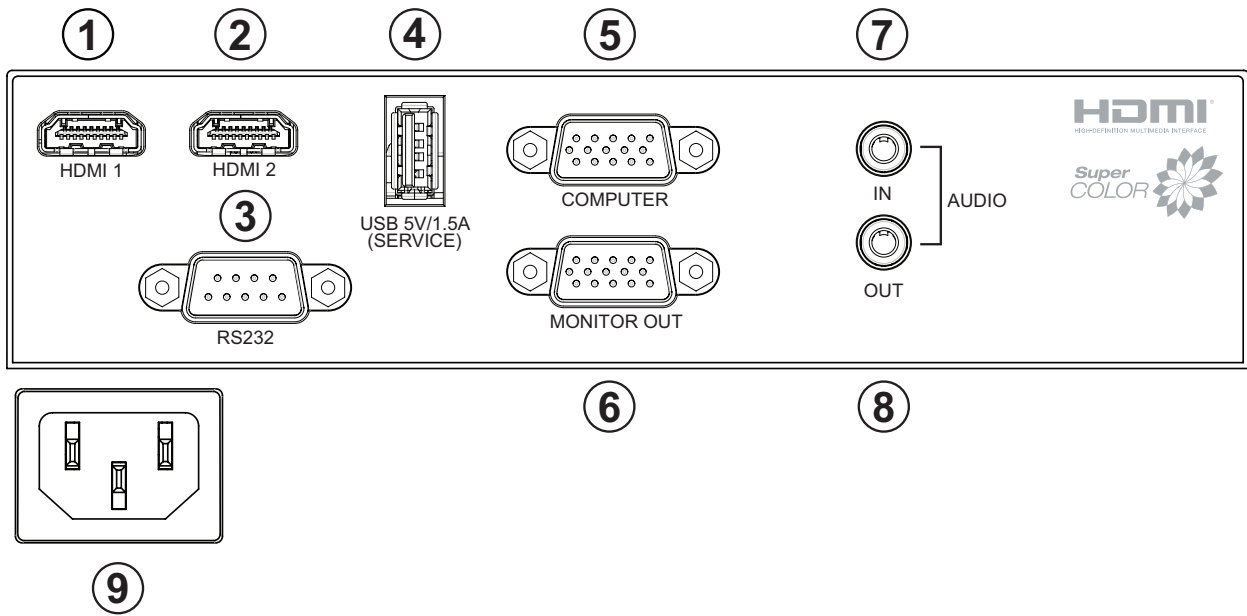





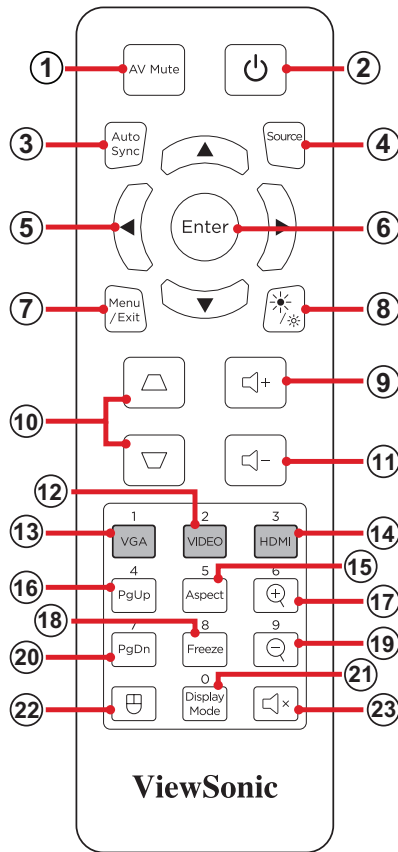









Port		Description
1	HDMI 1	HDMI port.
2	HDMI 2	HDMI port.
3	RS-232	RS-232 control port.
4	USB (5V/1.5A Out) (Service)	USB Type A port for power and service.
5	COMPUTER	RGB (PC) signal input socket.
6	MONITOR OUT	RGB (PC) signal output socket.
7	AUDIO IN	Audio signal input socket.
8	AUDIO OUT	Audio signal output socket.
9	AC IN	AC IN socket.

# Remote Control



Button		Description
1	<b>AV Mute</b>	Hide and recover the screen picture and volume mute.
2	<b>Power</b>	Turns the projector On or Off
3	<b>Auto Sync</b>	Automatically synchronize the projector to the input source.
4	<b>Source</b>	Toggle to the next input source.
5	<b>Navigation Buttons</b>	Navigates and selects the desired menu items and make adjustments when the On-Screen Display (OSD) Menu is activated.
6	<b>Enter</b>	Confirm the selection when the On-Screen Display (OSD) Menu is activated.
7	<b>Menu/Exit</b>	<ul style="list-style-type: none"> <li>Turns the On-Screen Display (OSD) Menu On or Off.</li> <li>Go back to a previous OSD Menu.</li> <li>Exit and Save menu settings.</li> </ul>
8	<b>Brightness</b>	Displays the brightness selection bar.
9	<b>Volume Up</b>	Increase the volume level.

Button			Description
10	Keystone		Manually correct distorted images.
11	Volume Down		Decrease the volume level.
12	Video		<i>Unsupported Button</i>
13	VGA		Selects Computer IN port for display.
14	HDMI		Selects the <b>HDMI 1</b> or <b>HDMI 2</b> input source.
15	Aspect		Displays the format selection bar.
16	Page Up		Operates your display software program (on a connected PC) which responds to page up commands (like Microsoft PowerPoint). <b>NOTE:</b> Only available when a PC input source is selected and the PC and projector are connected via USB.
17	Zoom In		Increase the projected image size.
18	Freeze		Freeze/un-freeze the projected image.
19	Zoom Out		Reduce the projected image size.
20	Page Down		Operates your display software program (on a connected PC) which responds to page down commands (like Microsoft PowerPoint). <b>NOTE:</b> Only available when a PC input source is selected and the PC and projector are connected via USB.
21	Display Mode		Displays the display mode selection bar.
22	Mouse Mode		Enable/Disable the mouse function.
23	Mute		Mute/Unmute.

### Using the Remote Control Mouse Mode and Page Up/Down Function

1. Connect the PC/Notebook to the projector via the **COMPUTER** and **USB** ports.
2. Set the input source to PC.
3. Now you can operate your display software program which responds to page up/down commands (like Microsoft PowerPoint).



## Remote Control - Receiver Range

To ensure proper function of the remote control follow the steps below:

1. The remote control must be held at an angle within 30° perpendicular to the projector's IR remote control sensor(s).
2. The distance between the remote control and the sensor(s) should not exceed 10 m (32.8 ft.).

**NOTE:** Refer to the illustration for the location of the infrared (IR) remote control sensor(s).

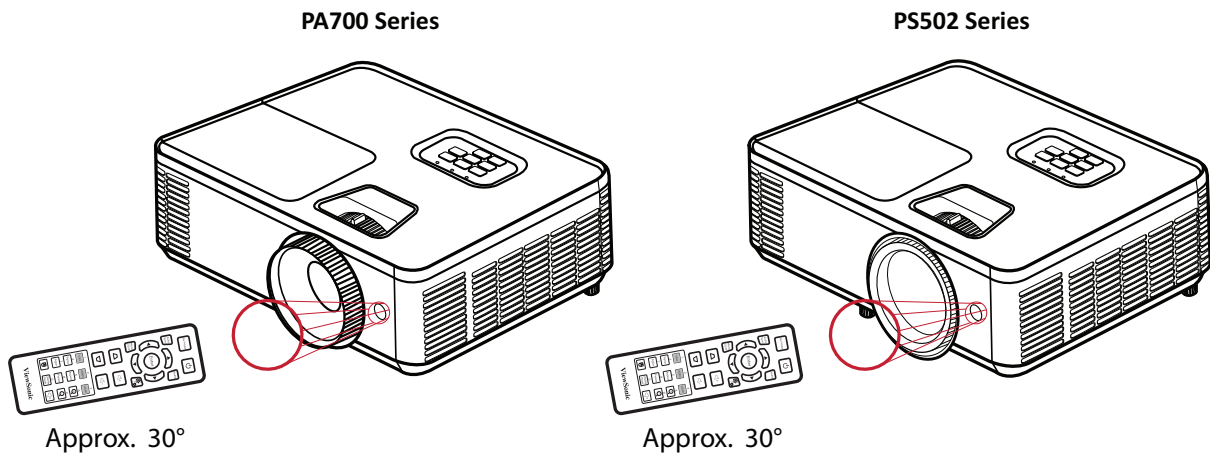

## Remote Control - Replacing the Batteries

1. Remove the battery cover from the bottom of the remote control by pressing the finger grip and sliding it across.
2. Remove any existing batteries (if necessary) and install two AAA batteries.

**NOTE:** Observe the battery's polarities as indicated.

3. Replace the battery cover by aligning it with the base and pushing it back into position.

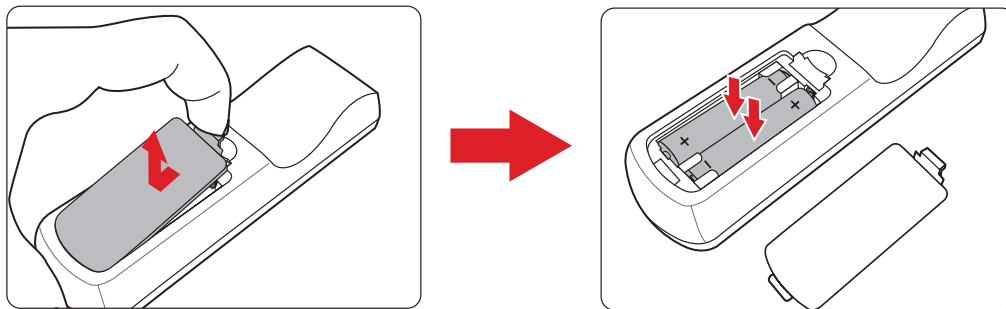

### **NOTE:**

- Avoid leaving the remote control and batteries in excessive heat or a humid environment.
- Replace only with the same or equivalent type recommended by the battery manufacturer.
- If the batteries are drained or if you will not be using the remote control for an extended period of time, remove the batteries to avoid damage to the remote control.
- Dispose of the used batteries according to the manufacturer's instructions and local environment regulations for your region.

# Initial Setup

This section provides detailed instructions for the initial set up your projector.

## Choosing a Location - Projection Orientation

Personal preference and room layout will decide the installation location. Consider the following:

- Size and position of your screen.
- Location of a suitable power outlet.
- Location and distance between the projector and other equipment.

The projector is designed to be installed in one of the following locations:

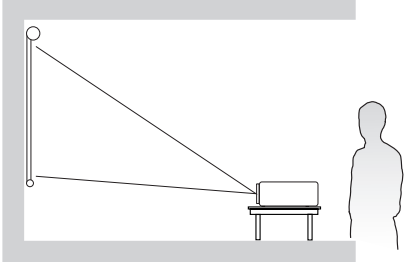
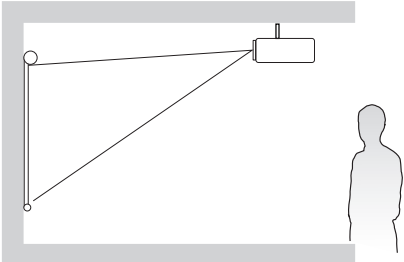
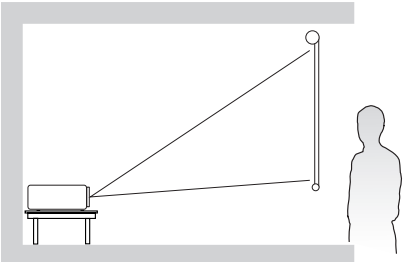
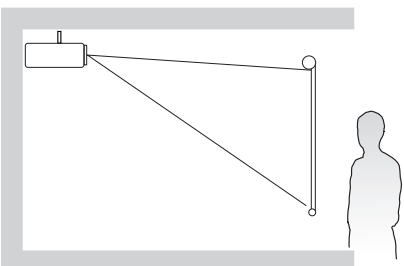
Location	
<p><b>Front Table</b></p> <p>The projector is placed near the floor in front of the screen.</p>	
<p><b>Front Ceiling</b></p> <p>The projector is suspended upside-down from the ceiling in front of the screen.</p>	
<p><b>Rear Table<sup>1</sup></b></p> <p>The projector is placed near the floor behind the screen.</p>	
<p><b>Rear Ceiling<sup>1</sup></b></p> <p>The projector is suspended upside-down from the ceiling behind the screen.</p>	

<sup>1</sup> A rear projection screen is required.

# Projection Dimensions - PA700S | PA700X

- 4:3 Image on a 4:3 Screen

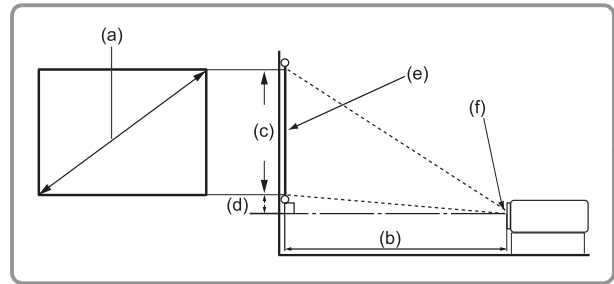
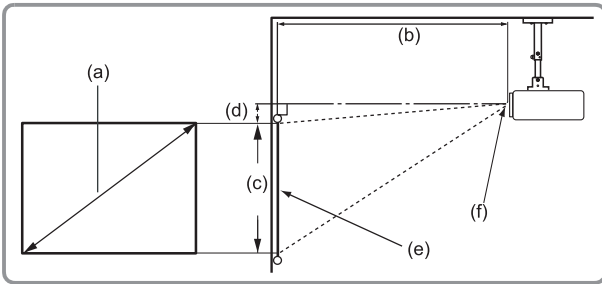

**NOTE:**

- (e) = Screen
- (f) = Center of Lens

## 4:3 Image on a 4:3 Screen

(a) Screen Size		(b) Projection Distance				(c) Image Height		(d) Vertical Offset	
		Minimum		Maximum					
in.	mm	in.	mm	in.	mm	in.	mm	in.	mm
30	762	46.56	1183	51.84	1317	18	457	2.70	69
60	1524	93.12	2365	103.68	2633	36	914	5.40	137
70	1778	108.64	2759	120.96	3072	42	1067	6.30	160
80	2032	124.16	3154	138.24	3511	48	1219	7.20	183
100	2540	155.20	3942	172.80	4389	60	1524	9	229
120	3048	186.24	4730	207.36	5267	72	1829	10.80	274
150	3810	232.80	5913	259.20	6584	90	2286	13.50	343
200	5080	310.40	7884	345.60	8778	120	3048	18	457
250	6350	388	9855	432	10973	150	3810	22.50	572
300	7620	465.60	11826	518.40	13167	180	4572	27	686

**NOTE:**

- These figures are for reference purposes only. Please refer to the actual projector for the precise dimensions.
- It is recommended that if you intend to permanently install the projector to physically test the projection size and distance using the actual projector before you permanently install it.

• 4:3 Image on a 16:10 Screen

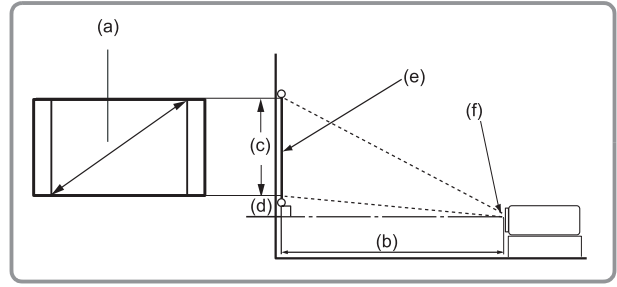
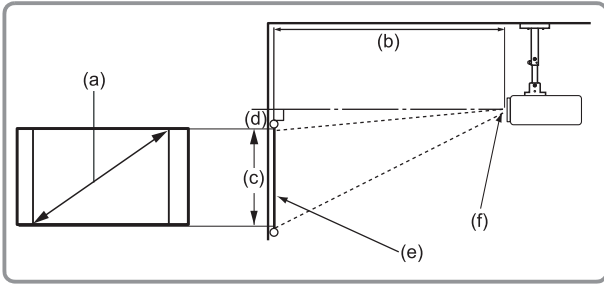

**NOTE:**

- (e) = Screen
- (f) = Center of Lens

**4:3 Image on a 16:10 Screen**

(a) Screen Size		(b) Projection Distance				(c) Image Height		(d) Vertical Offset	
		Minimum		Maximum					
in.	mm	in.	mm	in.	mm	in.	mm	in.	mm
30	762	41.13	1045	45.79	1163	15.90	404	2.38	61
60	1524	82.26	2089	91.58	2326	31.80	808	4.77	121
70	1778	95.97	2438	106.85	2714	37.10	942	5.56	141
80	2032	109.67	2786	122.11	3102	42.40	1077	6.36	162
100	2540	137.09	3482	152.64	3877	53	1346	7.95	202
120	3048	164.51	4179	183.17	4652	63.60	1615	9.54	242
150	3810	205.64	5223	228.96	5816	79.50	2019	11.92	303
200	5080	274.19	6964	305.28	7754	106	2692	15.90	404
250	6350	342.73	8705	381.60	9693	132.5	3365	19.87	505
300	7620	411.28	10446	457.92	11631	159	4039	23.85	606

**NOTE:**

- These figures are for reference purposes only. Please refer to the actual projector for the precise dimensions.
- It is recommended that if you intend to permanently install the projector to physically test the projection size and distance using the actual projector before you permanently install it.

# Projection Dimensions - PA700W

- 16:10 Image on a 16:10 Screen

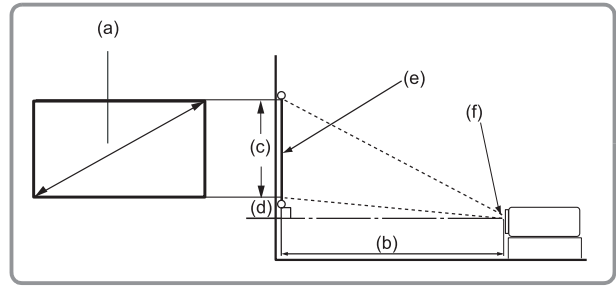
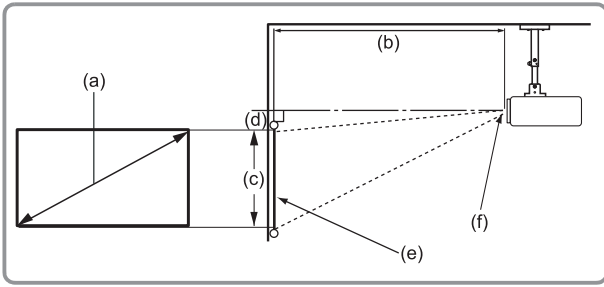

**NOTE:**

- (e) = Screen
- (f) = Center of Lens

## 16:10 Image on a 16:10 Screen

(a) Screen Size		(b) Projection Distance				(c) Image Height		(d) Vertical Offset	
		Minimum		Maximum					
in.	mm	in.	mm	in.	mm	in.	mm	in.	mm
30	762	39.20	995	43.80	1111	15.90	404	1.90	48
60	1524	78.36	1990	87.51	2223	31.80	808	3.94	100
80	2032	104.47	2654	116.68	2964	42.40	1077	5.26	134
90	2286	117.53	2985	131.27	3334	47.70	1212	5.91	150
100	2540	130.59	3317	145.86	3705	53	1346	6.57	167
120	3048	156.71	3980	175.03	4446	63.60	1615	7.89	200
150	3810	195.89	4976	218.78	5557	79.50	2019	9.86	250
200	5080	261.18	6634	291.71	7409	106	2692	13.14	334
250	6350	326.48	8293	364.64	9262	132.50	3365	16.43	417
300	7620	391.77	9951	437.57	11114	159	4039	19.70	500

**NOTE:**

- These figures are for reference purposes only. Please refer to the actual projector for the precise dimensions.
- It is recommended that if you intend to permanently install the projector to physically test the projection size and distance using the actual projector before you permanently install it.

- 16:10 Image on a 4:3 Screen

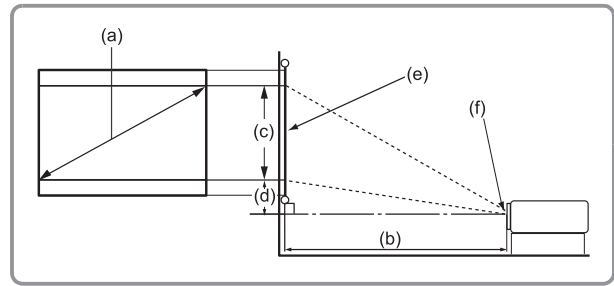
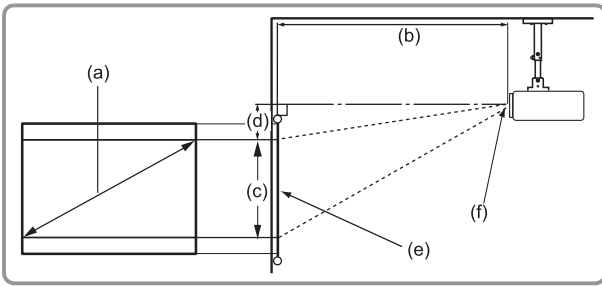

**NOTE:**

- (e) = Screen
- (f) = Center of Lens

**16:10 Image on a 4:3 Screen**

(a) Screen Size		(b) Projection Distance				(c) Image Height		(d) Vertical Offset	
		Minimum		Maximum					
in.	mm	in.	mm	in.	mm	in.	mm	in.	mm
30	762	36.90	937	41.30	1049	15	381	1.80	46
60	1524	73.92	1878	82.56	2097	30	762	3.72	94
80	2032	98.56	2503	110.08	2796	40	1016	4.96	126
90	2286	110.88	2816	123.84	3146	45	1143	5.58	142
100	2540	123.20	3129	137.60	3495	50	1270	6.20	157
120	3048	147.84	3755	165.12	4194	60	1524	7.44	189
150	3810	184.80	4694	206.40	5243	75	1905	9.30	236
200	5080	246.40	6259	275.20	6990	100	2540	12.40	315
250	6350	308	7823	344	8738	125	3175	15.50	394
300	7620	369.60	9388	412.80	10485	150	3810	18.60	472

**NOTE:**

- These figures are for reference purposes only. Please refer to the actual projector for the precise dimensions.
- It is recommended that if you intend to permanently install the projector to physically test the projection size and distance using the actual projector before you permanently install it.

# Projection Dimensions - PS502X

- 4:3 Image on a 4:3 Screen

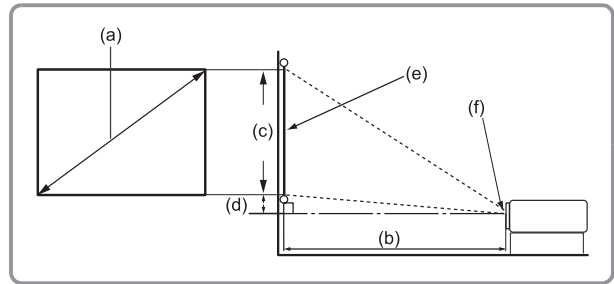
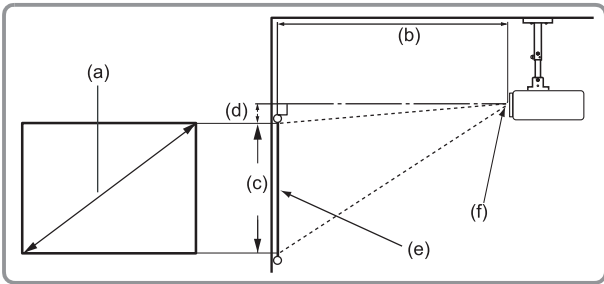

**NOTE:**

- (e) = Screen
- (f) = Center of Lens

## 4:3 Image on a 4:3 Screen

(a) Screen Size		(b) Projection Distance				(c) Image Height		(d) Vertical Offset	
		Minimum		Maximum					
in.	mm	in.	mm	in.	mm	in.	mm	in.	mm
40	1016	19.74	501	19.74	501	24.02	610	3.60	91
60	1524	29.62	752	29.62	752	35.98	914	5.40	137
70	1778	34.55	878	34.55	878	42.01	1067	6.30	160
80	2032	39.49	1003	39.49	1003	47.99	1219	7.20	183
100	2540	49.36	1254	49.36	1254	60	1524	9	229
120	3048	59.23	1504	59.23	1504	72.01	1829	10.80	274
150	3810	74.04	1881	74.04	1881	90	2286	13.50	343
200	5080	98.72	2507	98.72	2507	120	3048	18	457
250	6350	123.40	3134	123.40	3134	150	3810	22.50	572
300	7620	148.08	3761	148.08	3761	180	4572	27	686

**NOTE:**

- These figures are for reference purposes only. Please refer to the actual projector for the precise dimensions.
- It is recommended that if you intend to permanently install the projector to physically test the projection size and distance using the actual projector before you permanently install it.



- 4:3 Image on a 16:10 Screen

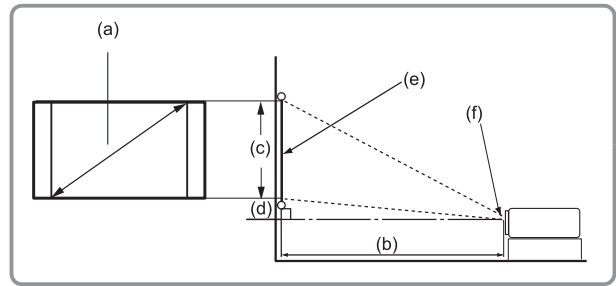
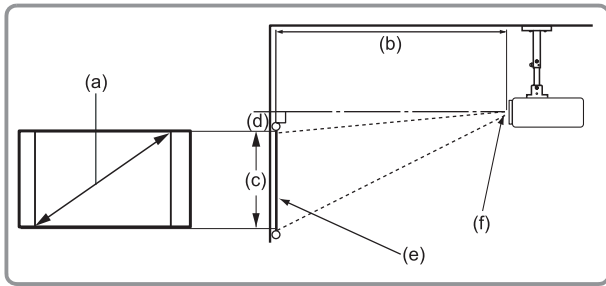

**NOTE:**

- (e) = Screen
- (f) = Center of Lens

**4:3 Image on a 16:10 Screen**

(a) Screen Size		(b) Projection Distance				(c) Image Height		(d) Vertical Offset	
		Minimum		Maximum					
in.	mm	in.	mm	in.	mm	in.	mm	in.	mm
40	1016	17.44	443	17.44	443	21.20	538	3.18	81
60	1524	26.16	664	26.16	664	31.80	808	4.77	121
70	1778	30.52	775	30.52	775	37.10	942	5.56	141
80	2032	34.88	886	34.88	886	42.40	1077	6.36	162
100	2540	43.60	1107	43.60	1107	53	1346	7.95	202
120	3048	52.32	1329	52.32	1329	63.60	1615	9.54	242
150	3810	65.40	1661	65.40	1661	79.50	2019	11.92	303
200	5080	87.20	2215	87.20	2215	106	2692	15.90	404
250	6350	109	2769	109	2769	132.50	3365	19.87	505
300	7620	130.80	3322	130.80	3322	159	4039	23.85	606

**NOTE:**

- These figures are for reference purposes only. Please refer to the actual projector for the precise dimensions.
- It is recommended that if you intend to permanently install the projector to physically test the projection size and distance using the actual projector before you permanently install it.

# Projection Dimensions - PS502W

- 16:10 Image on a 16:10 Screen

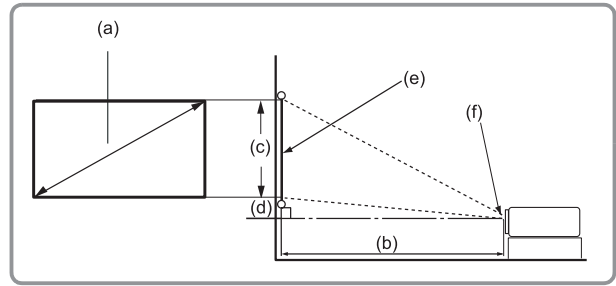
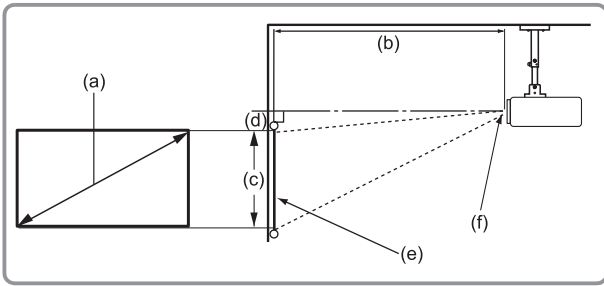

**NOTE:**

- (e) = Screen
- (f) = Center of Lens

## 16:10 Image on a 16:10 Screen

(a) Screen Size		(b) Projection Distance				(c) Image Height		(d) Vertical Offset	
		Minimum		Maximum					
in.	mm	in.	mm	in.	mm	in.	mm	in.	mm
40	1016	17.67	449	17.67	449	21.20	538	2.63	67
60	1524	26.51	673	26.51	673	31.80	808	3.94	100
80	2032	35.34	898	35.34	898	42.40	1077	5.26	134
90	2286	39.76	1010	39.76	1010	47.70	1212	5.91	150
100	2540	44.18	1122	44.18	1122	53	1346	6.57	167
120	3048	53.02	1347	53.02	1347	63.60	1615	7.89	200
150	3810	66.27	1683	66.27	1683	79.50	2019	9.86	250
200	5080	88.36	2244	88.36	2244	106	2692	13.14	334
250	6350	110.45	2805	110.45	2805	132.50	3365	16.43	417
300	7620	132.30	3360	132.30	3360	159	4039	19.70	500

**NOTE:**

- These figures are for reference purposes only. Please refer to the actual projector for the precise dimensions.
- It is recommended that if you intend to permanently install the projector to physically test the projection size and distance using the actual projector before you permanently install it.

- 16:10 Image on a 4:3 Screen

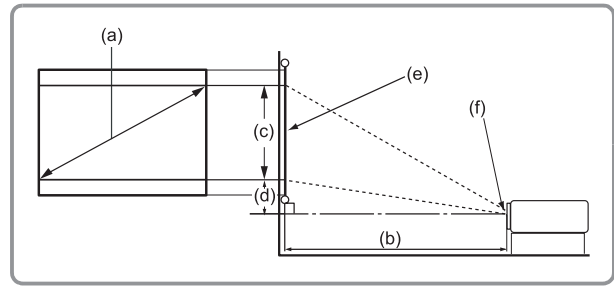
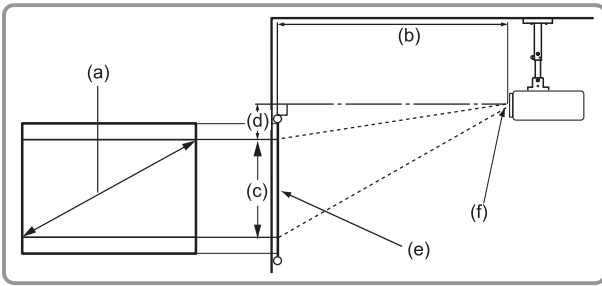

**NOTE:**

- (e) = Screen
- (f) = Center of Lens

**16:10 Image on a 4:3 Screen**

(a) Screen Size		(b) Projection Distance				(c) Image Height		(d) Vertical Offset	
		Minimum		Maximum					
in.	mm	in.	mm	in.	mm	in.	mm	in.	mm
40	1016	16.67	423	16.67	423	20	508	2.48	63
60	1524	25.01	635	25.01	635	30	762	3.72	94
80	2032	33.34	847	33.34	847	40	1016	4.96	126
90	2286	37.51	953	37.51	953	45	1143	5.58	142
100	2540	41.68	1059	41.68	1059	50	1270	6.20	157
120	3048	50.02	1270	50.02	1270	60	1524	7.44	189
150	3810	62.52	1588	62.52	1588	75	1905	9.30	236
200	5080	83.36	2117	83.36	2117	100	2540	12.40	315
250	6350	104.20	2647	104.20	2647	125	3175	15.50	394
300	7620	125.04	3176	125.04	3176	150	3810	18.60	472

**NOTE:**

- These figures are for reference purposes only. Please refer to the actual projector for the precise dimensions.
- It is recommended that if you intend to permanently install the projector to physically test the projection size and distance using the actual projector before you permanently install it.

## Mounting the Projector

**NOTE:** If you buy a third party mount, please use the correct screw size. Screw size can vary depending on the thickness of the mounting plate.

1. To ensure the most secure installation, please use a ViewSonic® wall or ceiling mount.
2. Ensure the screws used to attach the mount to the projector meet the following specifications:
  - Screw type: M4 x 7
  - Maximum Screw Length: 7 mm

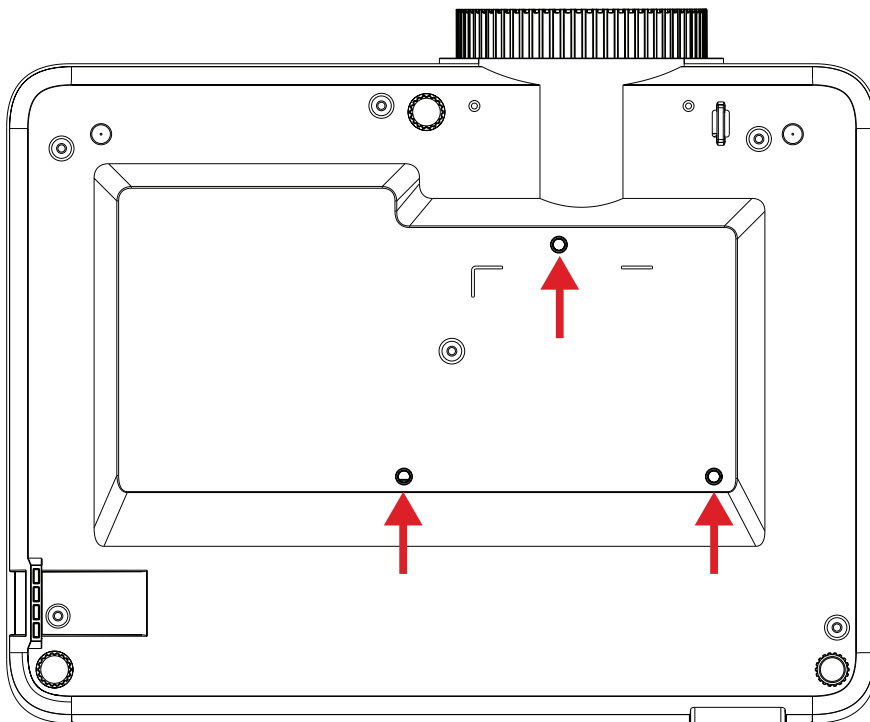

### CAUTION:

- Avoid installing the projector near a heat source or air conditioner.
- Keep at least a 10 cm (3.9 in.) gap between the ceiling and the bottom of the projector.

## Using the Security Bar

To help prevent the projector from being stolen, use a security slot locking device to secure the projector to a fixed object.

# Making Connections

## Connecting to Power

1. Connect the power cord to the AC IN jack at the rear of the projector.
2. Plug the power cord into a power outlet.

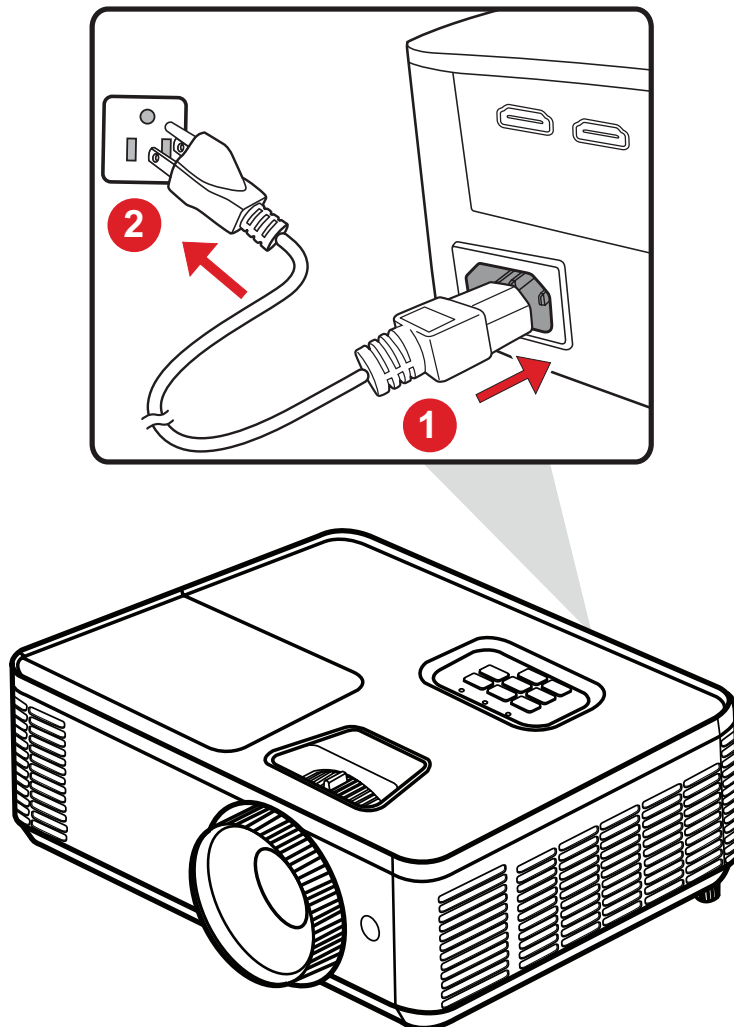

**NOTE:** When installing the projector, incorporate a readily accessible disconnect device in the fixed wiring, or connect the power plug to an easily accessible outlet near the unit. If a fault should occur during operation of the projector, use the disconnect device to switch off the power supply, or disconnect the power plug.

# Connecting to External Devices

## HDMI Connection

Connect one end of an HDMI cable to the HDMI port of your video device. Then connect the other end of the cable to the **HDMI 1/2** port of your projector.

**NOTE:** iPhone/iPad users will need to use an additional adapter.

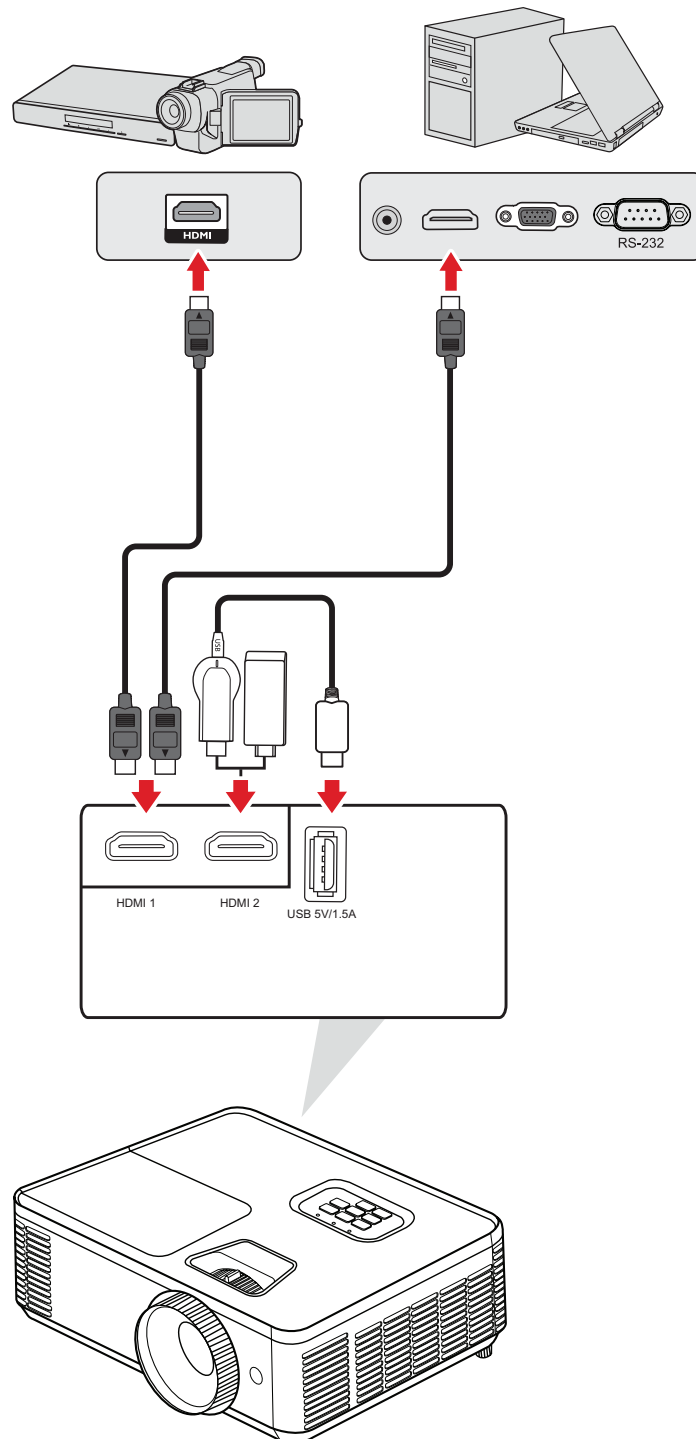

## Audio Connection

You can connect to various external sound delivery devices via the **AUDIO OUT** port.

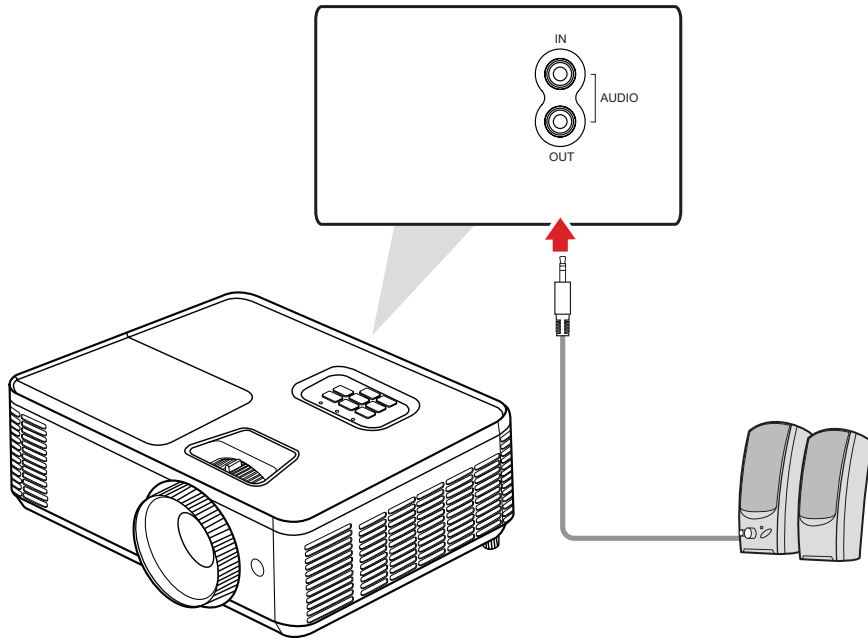

Additionally, you can connect to the **AUDIO IN** port with your device to use the projector's audio output.

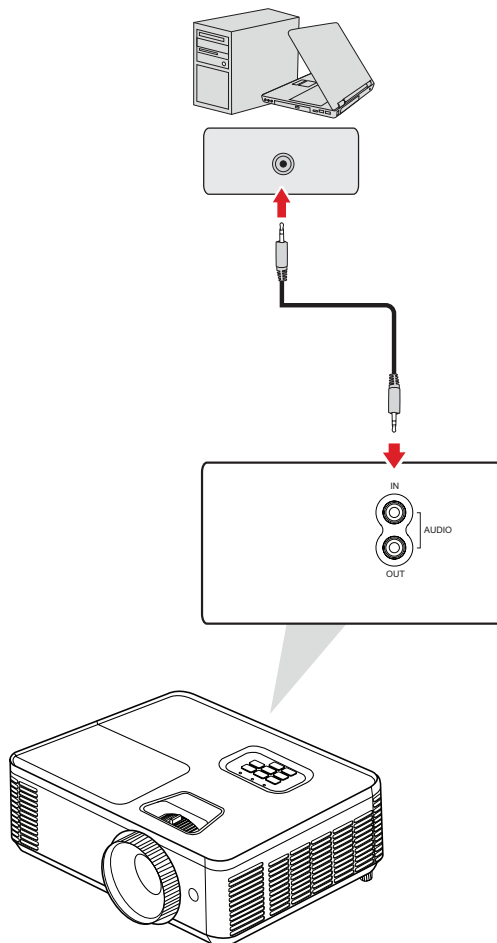

## USB Type A Connection

The USB port is for: Service and HDMI devices.

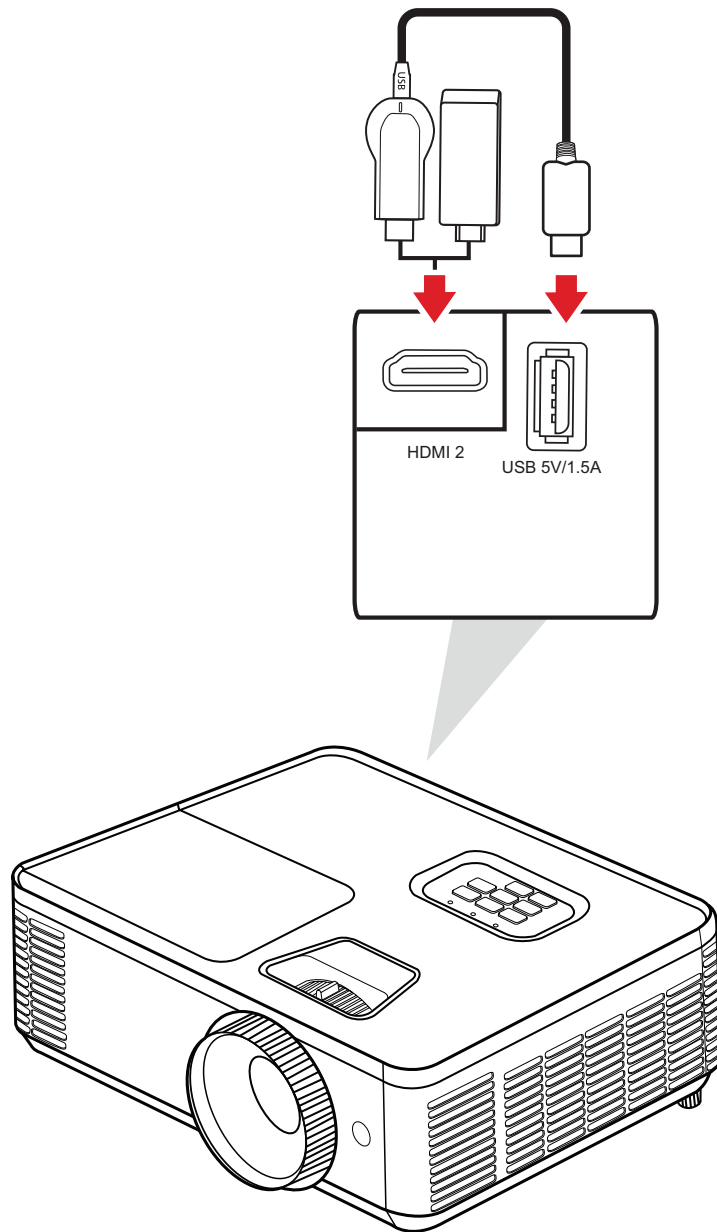

### NOTE:

- PA700S/PA700X/PA700W/PS502X/PS502W USB Type A supports 5V/1.5A power output for HDMI dongle charging.



## RS-232 Connection

When you use a RS-232 serial port cable to connect the projector to an external computer certain functions can be controlled remotely by the PC, including Power On/Off, Volume adjustment, Input select, and more.

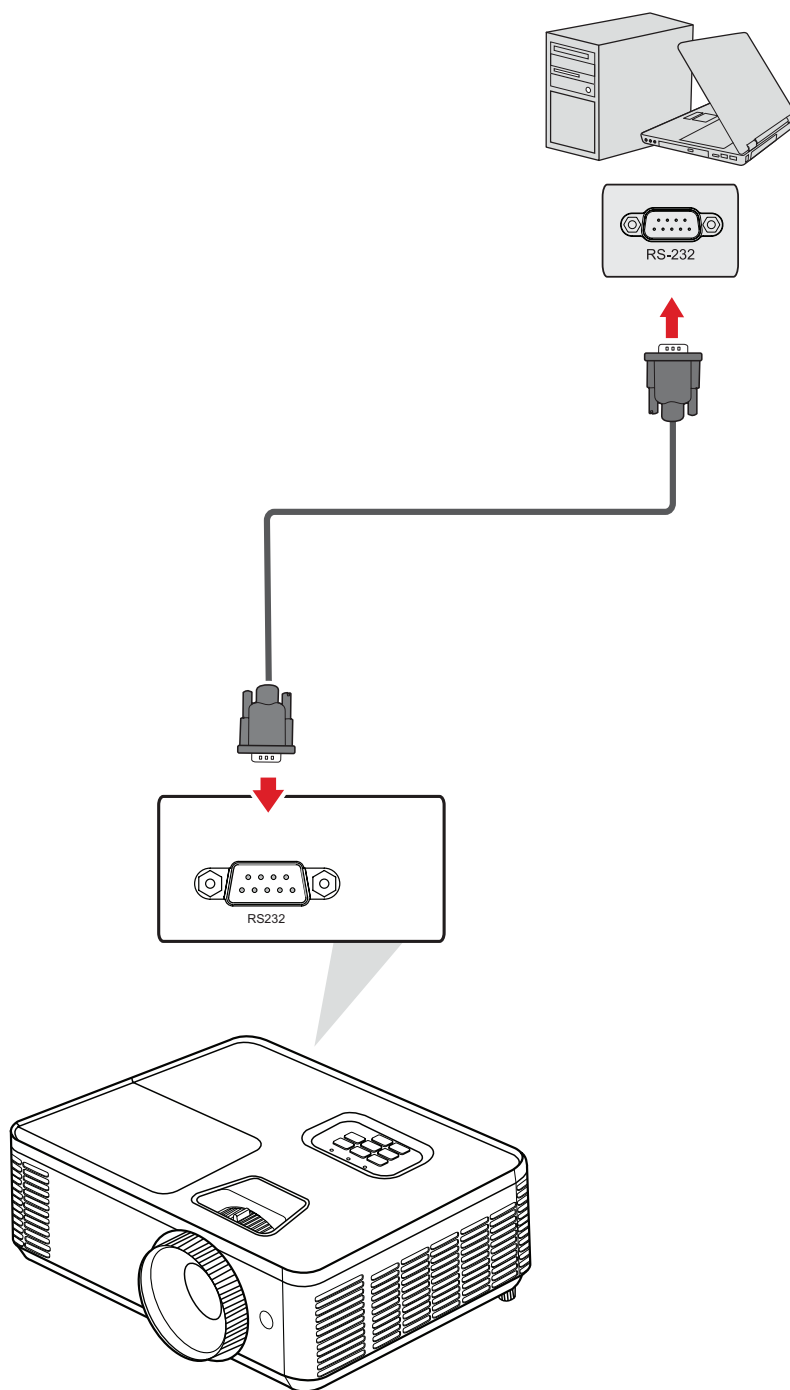

## PC/Notebook and Monitor Connection

### Connecting a PC/Notebook

Connect one end of a VGA cable to the VGA port of the PC/Notebook. Then connect the other end of the cable to the **COMPUTER** port of the projector.

**NOTE:** To use the remote mouse control function, take a USB cable and connect one end to the USB port of the computer, and the other end to the **USB** port on the projector.

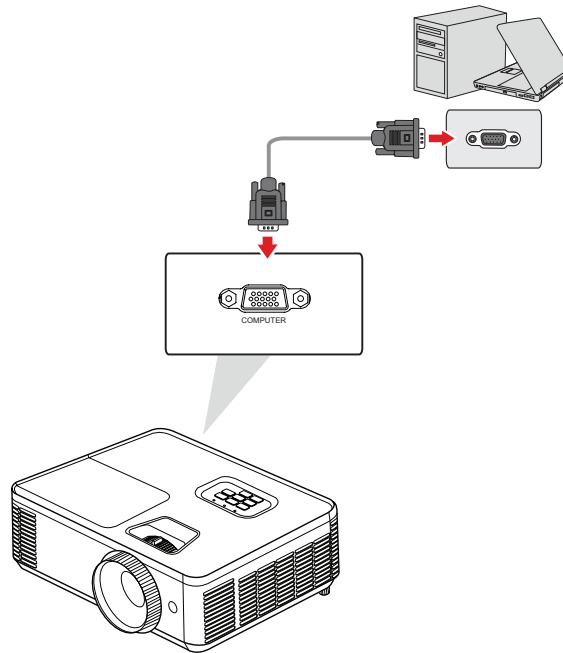

### Monitor Connection

To view the projected content up close on a monitor as well as project it, a monitor can be connected to the **MONITOR OUT** port of the projector. Connect one end of a VGA cable to the VGA port of the monitor. Then connect the other end of the cable to the **MONITOR OUT** port of the projector.

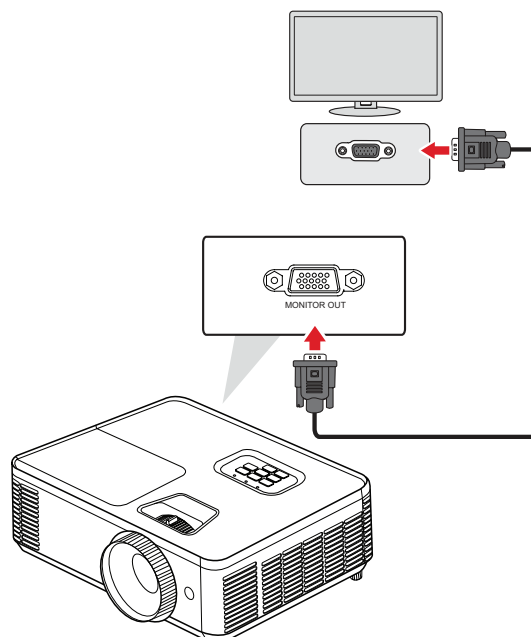

# Using the Projector

## Starting Up the Projector

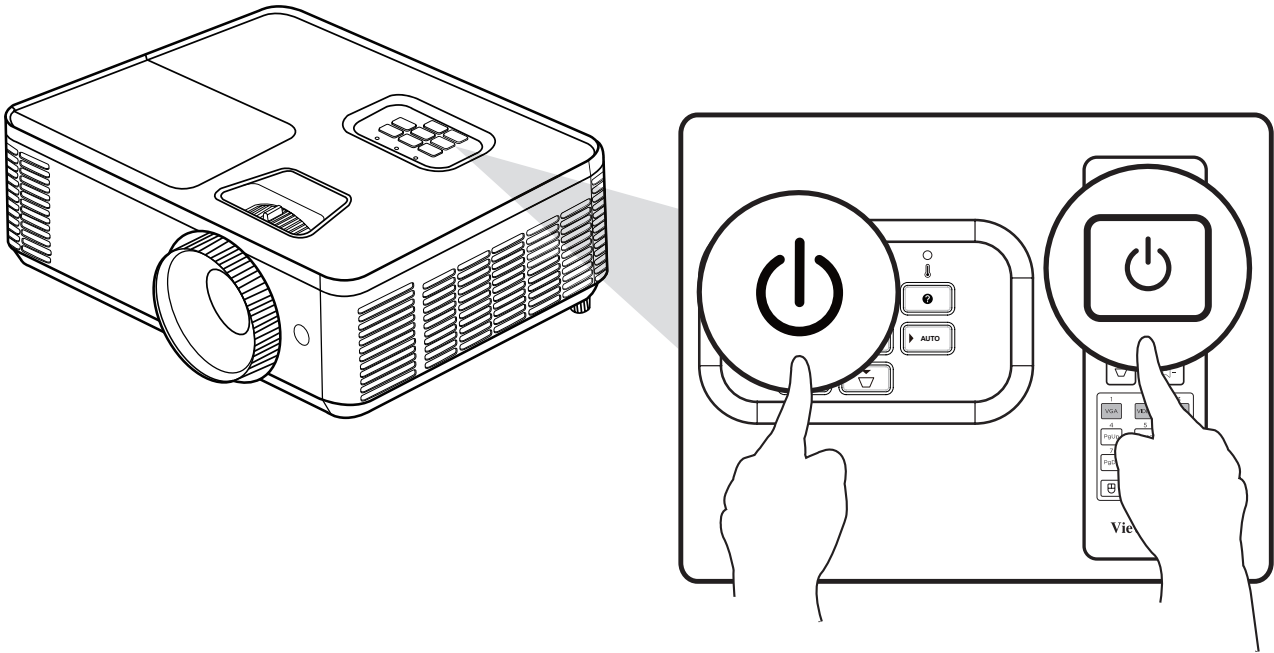

1. Ensure the projector's power cord is properly connected to a power outlet.
2. Press the **Power** button on the projector or remote control to turn on the projector.

### NOTE:

- The Power Indicator Light will be flashing blue during startup.
- The projector cannot be turned off within one minute after starting.

## Selecting an Input Source

The projector can be connected to multiple devices at the same time. However, it can only display one full screen at a time.

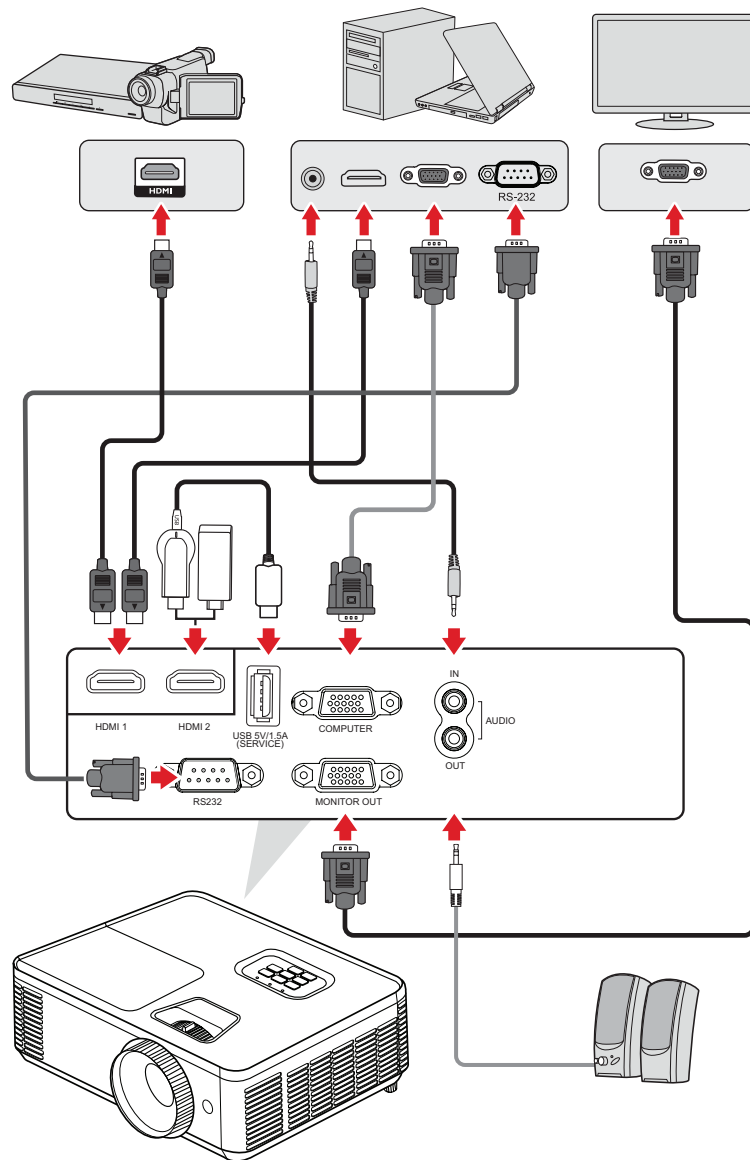

The projector will automatically search for input sources. If multiple sources are connected, press the **Source** button on the projector or remote control to select the desired input.

**NOTE:** Ensure the connected sources are also turned on.

## Help Menu

If no input source is detected, the below “Help Menu” will be displayed.

The image shows three sequential screenshots of a 'HELP' menu displayed on a screen. The menu is titled 'HELP' and 'No Image appears on-screen'. The first screenshot shows the title and a single bullet point: '▶ No Image appears on-screen'. The second screenshot shows three bullet points: '▶ Ensure all the cables and power connections are correctly and securely connected as described in the Installation section of User Manual.', '▶ Ensure all the pins of connectors are not bent or broken.', and '▶ Ensure that the [AV MUTE] feature is not turned on.' Below these are navigation options: '[NEXT]', '[EXIT]', and a bottom bar with 'UpDown', 'Select', and 'Menu Exit'. The third screenshot shows two numbered steps: '1. First, follow the steps above to adjust resolution of the computer.' and '2. Press the toggle output settings. Example : [Fn]+[F4]'. Below the steps is a table of manufacturer-specific toggle keys, followed by 'Mac Apple : System Preference => Display => Arrangement => Mirror display'. Navigation options and the bottom bar are also present.

HELP

No Image appears on-screen

- ▶ No Image appears on-screen

No Image appears on-screen

- ▶ Ensure all the cables and power connections are correctly and securely connected as described in the Installation section of User Manual.
- ▶ Ensure all the pins of connectors are not bent or broken.
- ▶ Ensure that the [AV MUTE] feature is not turned on.

[NEXT]  
[EXIT]

UpDown Select Menu Exit

No Image appears on-screen

- ▶ If you are using a Notebook:
  1. First, follow the steps above to adjust resolution of the computer.
  2. Press the toggle output settings. Example : [Fn]+[F4]

Acer	⇒	[Fn]+[F5]	IBM/Lenovo	⇒	[Fn]+[F5]
Asus	⇒	[Fn]+[F8]	HP/Compaq	⇒	[Fn]+[F5]
Dell	⇒	[Fn]+[F8]	NEC	⇒	[Fn]+[F5]
Gateway	⇒	[Fn]+[F4]	Toshiba	⇒	[Fn]+[F5]

Mac Apple :  
System Preference => Display => Arrangement => Mirror display

[PREV]  
[EXIT]

UpDown Select Menu Exit

If an input source is detected, the below “Help Menu” will be displayed.

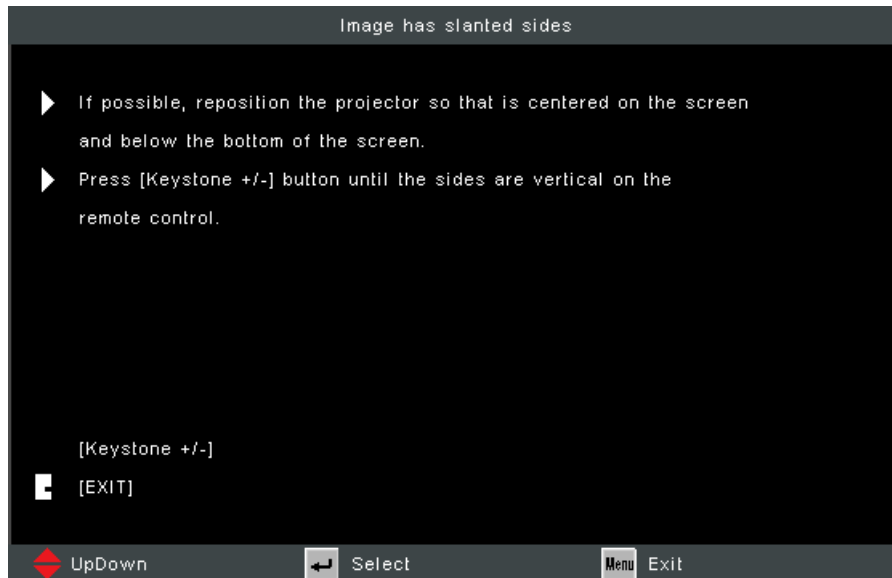
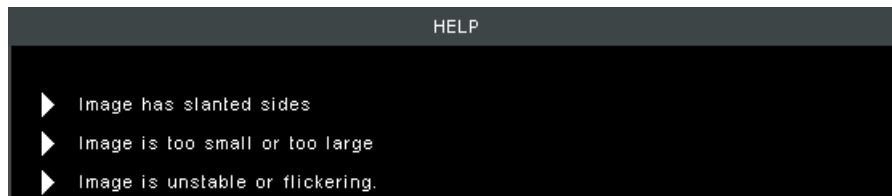

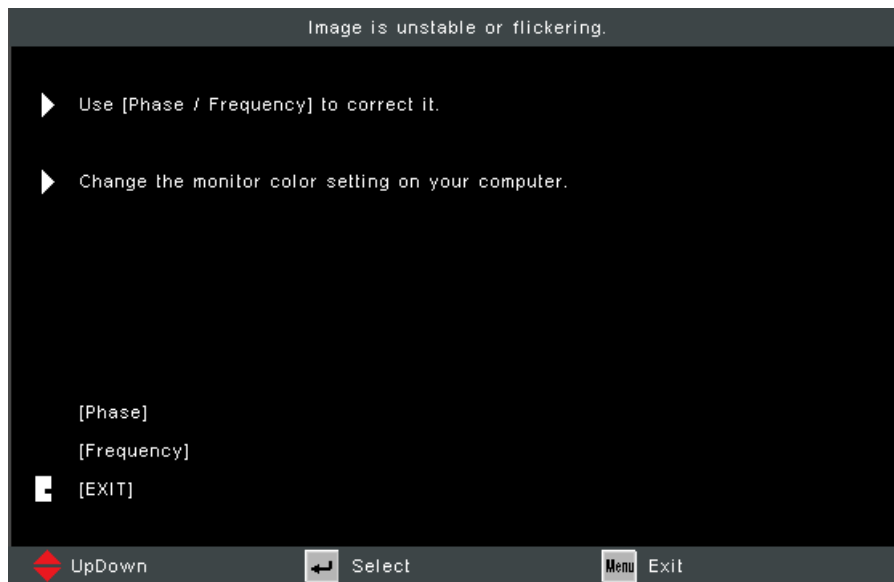

# Adjusting the Projected Image

## Adjusting the Projector's Height and Projection Angle

The projector is equipped with two (2) adjustment feet. Adjusting the feet will change the projector's height and the vertical projection angle.

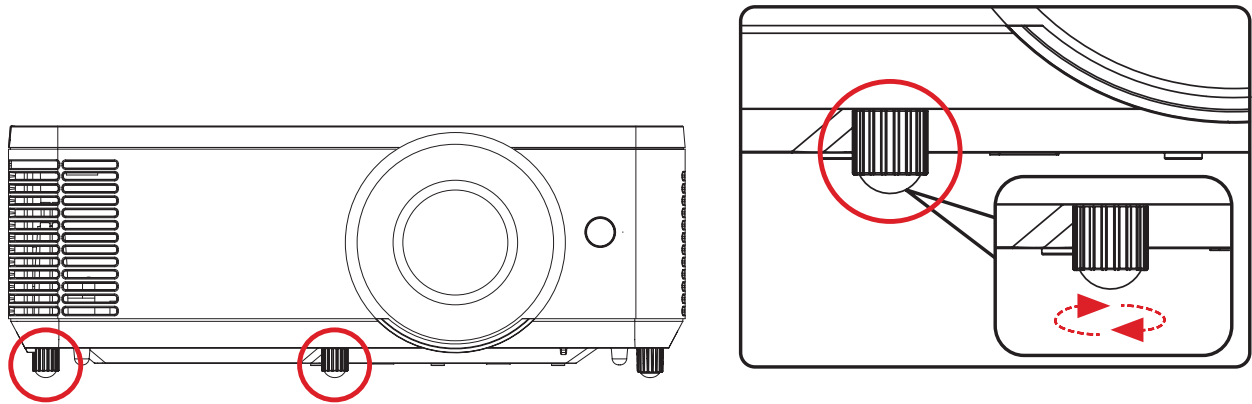



## Adjusting the Focus, Keystone, and Zoom

You can improve and adjust the clarity and position of the image by adjusting the **Focus Ring**, **Keystone Keys**, or **Zoom Ring**<sup>1</sup>.

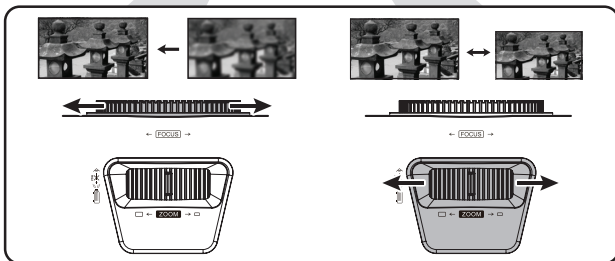
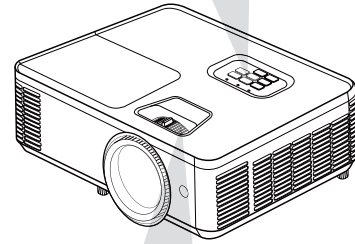
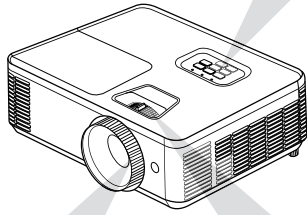
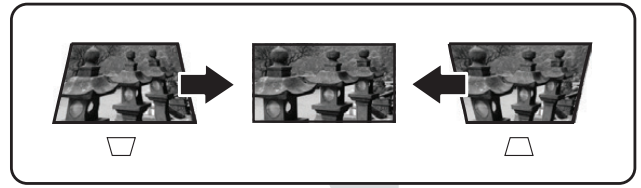
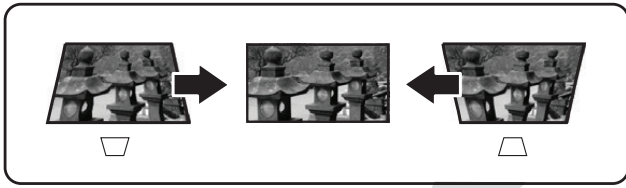

PA700 Series

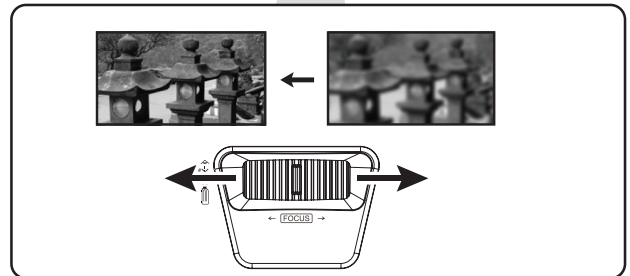

PS502 Series

<sup>1</sup> PA700 series only

## Shutting Down the Projector

1. Press the **Power** button on the projector or remote control and a “power off message” will appear.

**NOTE:** The projector cannot be turned off within one minute after starting.

2. Press the **Power** button again to confirm and shut down the projector.

**NOTE:** The cooling fans will continue to operate for about 10 seconds for the cooling cycle and the Power Indicator Light will flash blue.

3. The Power Indicator Light will turn solid red and enter standby mode.

**NOTE:** If you wish to turn the projector back on, you must wait until the cooling cycle has finished and the projector has entered standby mode. When the projector is in standby mode, simply press the **Power** button again to turn on the projector.

# Operating the Projector

## On-Screen Display (OSD) Menu

The projector has multilingual on-screen display menus that allow you to make image adjustments and change a variety of settings.

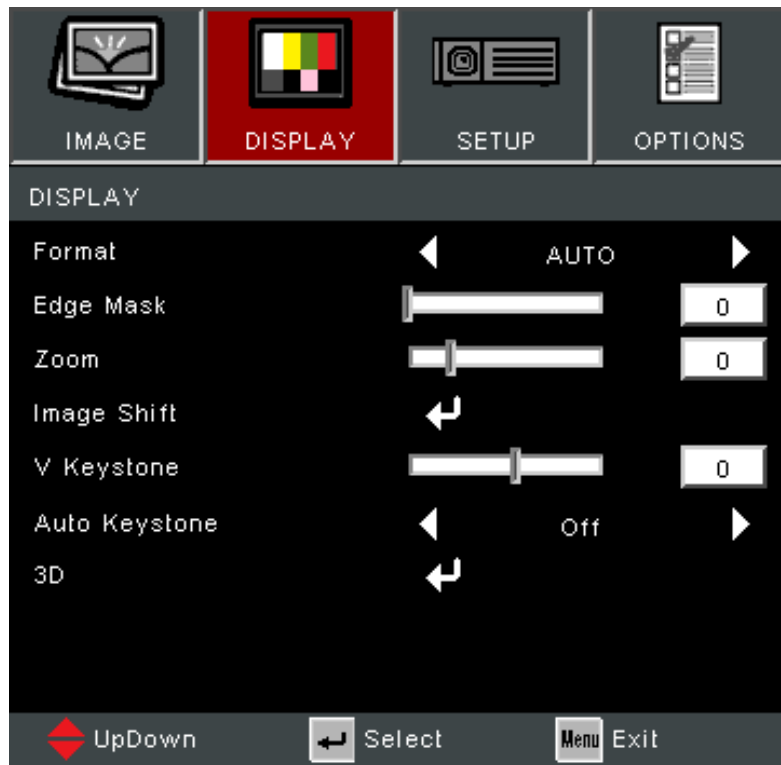

Menu	Description
Image	Adjust the Display Mode, Brightness, Contrast, and other image related settings.
Display	Adjust the aspect ratio, Zoom, Keystone, and 3D settings.
Setup	Adjust Language, Projection, Screen Type, Security, Audio Settings, and HDMI CEC settings.
Options	Select the Input Source and adjust several projector settings.

## Menu Navigation

The projector has multilingual on-screen display menus that allow for image and settings adjustment.

1. To open the On-Screen Display (OSD) Menu, press the **Menu/Exit** button on the projector or the remote control.
2. When the OSD is displayed, use the **Navigation** buttons (**▲▼**) to select any item in the main menu. While making a selection on a particular page, press the **Enter** button on the projector or the remote control to enter a sub-menu.
3. Use the **Navigation** buttons (**◀▶**) to select the desired item in the sub-menu and then press **Enter** to view further settings. Adjust the settings by using the **Navigation** buttons (**◀▶**).
4. Select the next item to be adjusted in the sub-menu and adjust as described above.
5. Press **Enter** to confirm, and the screen will return to the previous menu.
6. To exit, press the **Menu/Exit** button again. The OSD menu will close and the projector will automatically save the new settings.

# On-Screen Display (OSD) Menu Tree

Main Menu	Sub-menu	Menu Option		
Image	Display Mode	Standard		
		Bright		
		Movie		
		Presentation		
		Blackboard		
		User		
		3D		
	Brightness	(-/+ , -50~50)		
	Contrast	(-/+ , -50~50)		
	Sharpness	(-/+ , 1~15)		
	Color	(-/+ , -50~50)		
	Tint	(-/+ , -50~50)		
	Advanced	Gamma	Film	
			Video	
			Graphics	
			Standard	
		BrilliantColor™	(-/+ , 1~10)	
		Color Temp	Warm	
			Medium	
			Cold	
		Color Settings	Red/Green/Blue/Cyan/ Magenta/Yellow/White	
		Color Space <sup>1</sup>	Auto	
			RGB (0~255)	
			RGB (16~235)	
			YUV	
	Signal	Automatic		
		Phase		
Frequency				
H. Position				
V. Position				

<sup>1</sup> For HDMI signal, select Auto, RGB (0~255), RGB (16~235), and YUV color space. For VGA signal, select Auto, RGB, and YUV color space.

Main Menu	Sub-menu	Menu Option	
Display	Format <sup>2</sup>	4:3	
		16:9 (or 16:10)	
		Native	
		Auto	
		LBX	
	Edge Mask	(-/+ , 0~10)	
	Zoom	(-/+ , -5~25)	
	Image Shift	H (Horizontal)	(-/+ , -100~100)
		V (Vertical)	(-/+ , -100~100)
	V. Keystone	(-/+ , -40~40) <sup>3</sup> (-/+ , -20~20) <sup>4</sup>	
	Auto Keystone	On	
		Off	
	3D	3D Mode	Off
			DLP-Link
		3D - 2D	3D
			L
			R
		3D Format	Auto
			Side by Side
			Top and Bottom
Frame Sequential			
3D Sync Invert		On	
		Off	

<sup>2</sup> For PA700S/PA700X/PS502X: 4:3, 16:9, Native, Auto. For PA700W/PS502W: 4:3, 16:10, Native, Auto, LBX

<sup>3</sup> For PA700S/PA700X/PA700W

<sup>4</sup> For PS502X/PS502W

Main Menu	Sub-menu	Menu Option
Setup	Language	English
		Deutsch
		Français
		Italiano
		Español
		Português
		Polski
		Nederlands
		Svenska
		Suomi
		ελληνικά
		繁體中文
		簡體中文
		한국어
		Русский
		Magyar
		Čeština
		عربي
		ไทย
		Türkçe
	Tiếng Việt	
	Indonesia	
	Projection	Front Table
		Front Ceiling
		Rear Table
		Rear Ceiling
	Menu Location	Top-Left
		Top-Right
		Center
		Bottom-Left
		Bottom-Right
	Screen Type <sup>5</sup>	16:10
		16:9

<sup>5</sup> Screen Type selection only for PA700W/PS502W

Main Menu	Sub-menu	Menu Option	
Setup	Security	On	
		Off	
		Security Timer	Month
			Day
			Hour
	Change Password		
	Audio Settings	Mute	On
			Off
		Volume	(-/+ , 0~10)
		Audio Input	Default
	AUDIO		
	Advanced	Logo	Default
			Neutral
	HDMI CEC	On	
Off			
Options	Input Source	VGA	
		HDMI 1	
		HDMI 2	
	Source Lock	On	
		Off	
	High Altitude	On	
		Off	
	Information Hide	On	
		Off	
	Keypad Lock	On	
		Off	
	Test Pattern	Grid	
		White	
	IR Function	On	
Off			



Main Menu	Sub-menu	Menu Option		
Options	Background Color	Black		
		Red		
		Blue		
		Green		
		White		
	Advanced	Direct Power On	On	
			Off	
		Auto Power Off (min)	(-/+ , 0~180) minutes	
		Power Mode (Standby)	Active	
			Eco.	
		Signal Power On	On	
			Off	
	Lamp Settings	Lamp Hour		
		Lamp Reminder	On	
			Off	
		Brightness Mode	Bright	
			Eco	
			Dynamic	
		Lamp Reset	Yes	
	No			
	Optional Filter Settings	Optional Filter Installed	Yes	
			No	
		Filter Usage Hours	0~99999	
		Filter Reminder	Off	
			300 Hr	
			500 Hr	
			800 Hr	
			1000 Hr	
	Filter Reset			
	Reset			

# Menu Operation

## Image Menu

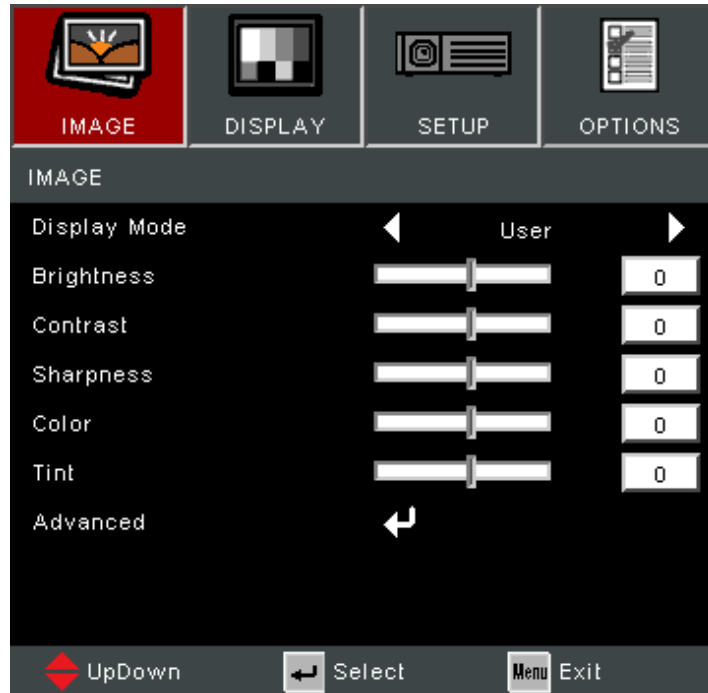

Menu	Description																
<b>Display Mode</b>	<p>There are several predefined display modes that you can choose from to suit your viewing preference.</p> <table border="1" style="width: 100%; border-collapse: collapse;"> <thead> <tr> <th style="background-color: #ff0000; color: white;">Mode</th> <th style="background-color: #ff0000; color: white;">Description</th> </tr> </thead> <tbody> <tr> <td style="text-align: center;"><b>Standard</b></td> <td>Suitable for daily circumstances in a daylight environment.</td> </tr> <tr> <td style="text-align: center;"><b>Bright</b></td> <td>Suitable for bright, well-lit environments.</td> </tr> <tr> <td style="text-align: center;"><b>Movie</b></td> <td>Provides the best balance of detail and colors for watching movies.</td> </tr> <tr> <td style="text-align: center;"><b>Presentation</b></td> <td>Suitable for most presenting needs for business and education environments.</td> </tr> <tr> <td style="text-align: center;"><b>Blackboard</b></td> <td>Achieve optimum color settings when projecting onto a blackboard.</td> </tr> <tr> <td style="text-align: center;"><b>User</b></td> <td>User's custom settings.</td> </tr> <tr> <td style="text-align: center;"><b>3D</b></td> <td>Optimized for 3D content. <b>NOTE:</b> 3D glasses are needed.</td> </tr> </tbody> </table>	Mode	Description	<b>Standard</b>	Suitable for daily circumstances in a daylight environment.	<b>Bright</b>	Suitable for bright, well-lit environments.	<b>Movie</b>	Provides the best balance of detail and colors for watching movies.	<b>Presentation</b>	Suitable for most presenting needs for business and education environments.	<b>Blackboard</b>	Achieve optimum color settings when projecting onto a blackboard.	<b>User</b>	User's custom settings.	<b>3D</b>	Optimized for 3D content. <b>NOTE:</b> 3D glasses are needed.
	Mode	Description															
	<b>Standard</b>	Suitable for daily circumstances in a daylight environment.															
	<b>Bright</b>	Suitable for bright, well-lit environments.															
	<b>Movie</b>	Provides the best balance of detail and colors for watching movies.															
	<b>Presentation</b>	Suitable for most presenting needs for business and education environments.															
	<b>Blackboard</b>	Achieve optimum color settings when projecting onto a blackboard.															
	<b>User</b>	User's custom settings.															
<b>3D</b>	Optimized for 3D content. <b>NOTE:</b> 3D glasses are needed.																
<b>Brightness</b>	The higher the value, the brighter the image. Lower values will result in a darker image.																
<b>Contrast</b>	Use this to set the peak white level after you have previously adjusted the <b>Brightness</b> setting to suit your selected input and viewing environment.																
<b>Sharpness</b>	A high value results in a sharper picture; a low value softens the picture.																
<b>Color</b>	Adjust an image from black and white to fully saturated color.																

Menu	Description
<b>Tint</b>	The higher the value, the more greenish the picture becomes. The lower the value, the more reddish the picture becomes.
<b>Advanced</b>	<p><u>Gamma</u> Reflects the relationship between input source and picture brightness.</p> <p><u>BrilliantColor™</u> A color-processing algorithm and enhancements to enable higher brightness while providing true, more vibrant colors in picture.</p> <p><u>Color Temperature</u> Select from Warm, Medium, or Cold.</p> <p><u>Color Setting</u> Only in permanent installations with controlled lighting levels such as boardrooms, lecture theaters, or home theaters, should color management be considered. Color management provides fine color control adjustment to allow for more accurate color reproduction. Select Primary Color first and adjust its range/values in Hue, Saturation and Gain.</p> <p><u>Color Space</u> For HDMI signal, select Auto, RGB (0~255), RGB (16~235), and YUV color space. For VGA signal, select Auto, RGB, and YUV color space.</p> <p><u>Signal</u> Adjust the Phase, Frequency, Horizontal and Vertical position values of the input source.</p> <p><u>Exit</u> Exit the Advanced menu.</p>

## Display Menu



Menu	Description														
<p align="center"><b>Format</b></p>	<p>Select the aspect ratio of the projected image.</p> <table border="1" data-bbox="608 226 1396 1653"> <thead> <tr> <th data-bbox="608 226 884 271">Aspect Ratio</th> <th data-bbox="884 226 1396 271">Description</th> </tr> </thead> <tbody> <tr> <td data-bbox="608 271 884 546"> <p align="center"><b>4:3</b></p> </td> <td data-bbox="884 271 1396 546"> <p>Scales an image so that it is displayed in the center of the screen with a 4:3 aspect ratio. This is most suitable for 4:3 images like computer monitors, standard definition TV, and 4:3 aspect DVD movies, as it displays them without aspect alteration.</p> </td> </tr> <tr> <td data-bbox="608 546 884 781"> <p align="center"><b>16:9</b></p> </td> <td data-bbox="884 546 1396 781"> <p>Scales an image so that it is displayed in the center of the screen with a 16:9 aspect ratio. This is most suitable for images which are already in a 16:9 aspect, like high definition TV.</p> </td> </tr> <tr> <td data-bbox="608 781 884 1016"> <p align="center"><b>Native</b></p> </td> <td data-bbox="884 781 1396 1016"> <p>Projects the image as its original resolution and resizes it to fit within the display area. For input signals with lower resolutions, the projected image will be displayed in its original size.</p> </td> </tr> <tr> <td data-bbox="608 1016 884 1292"> <p align="center"><b>Auto</b></p> </td> <td data-bbox="884 1016 1396 1292"> <p>Scales an image proportionally to fit the projector's native resolution in its horizontal width. This is suitable for the incoming image which is neither 4:3 nor 16:9 and you want to make the most use of the screen without altering the image's aspect ratio.</p> </td> </tr> <tr> <td data-bbox="608 1292 884 1491"> <p align="center"><b>16:10<sup>6</sup></b></p> </td> <td data-bbox="884 1292 1396 1491"> <p>Scales an image so that it is displayed in the center of the screen with a 16:10 aspect ratio. This is most suitable for images which are already in a 16:10 aspect.</p> </td> </tr> <tr> <td data-bbox="608 1491 884 1653"> <p align="center"><b>LBX<sup>7</sup></b></p> </td> <td data-bbox="884 1491 1396 1653"> <p>For non-16:9 letterbox source and if you use an external 16:9 lens to display 2.35:1 aspect ratio in full resolution.</p> </td> </tr> </tbody> </table>	Aspect Ratio	Description	<p align="center"><b>4:3</b></p>	<p>Scales an image so that it is displayed in the center of the screen with a 4:3 aspect ratio. This is most suitable for 4:3 images like computer monitors, standard definition TV, and 4:3 aspect DVD movies, as it displays them without aspect alteration.</p>	<p align="center"><b>16:9</b></p>	<p>Scales an image so that it is displayed in the center of the screen with a 16:9 aspect ratio. This is most suitable for images which are already in a 16:9 aspect, like high definition TV.</p>	<p align="center"><b>Native</b></p>	<p>Projects the image as its original resolution and resizes it to fit within the display area. For input signals with lower resolutions, the projected image will be displayed in its original size.</p>	<p align="center"><b>Auto</b></p>	<p>Scales an image proportionally to fit the projector's native resolution in its horizontal width. This is suitable for the incoming image which is neither 4:3 nor 16:9 and you want to make the most use of the screen without altering the image's aspect ratio.</p>	<p align="center"><b>16:10<sup>6</sup></b></p>	<p>Scales an image so that it is displayed in the center of the screen with a 16:10 aspect ratio. This is most suitable for images which are already in a 16:10 aspect.</p>	<p align="center"><b>LBX<sup>7</sup></b></p>	<p>For non-16:9 letterbox source and if you use an external 16:9 lens to display 2.35:1 aspect ratio in full resolution.</p>
	Aspect Ratio	Description													
	<p align="center"><b>4:3</b></p>	<p>Scales an image so that it is displayed in the center of the screen with a 4:3 aspect ratio. This is most suitable for 4:3 images like computer monitors, standard definition TV, and 4:3 aspect DVD movies, as it displays them without aspect alteration.</p>													
	<p align="center"><b>16:9</b></p>	<p>Scales an image so that it is displayed in the center of the screen with a 16:9 aspect ratio. This is most suitable for images which are already in a 16:9 aspect, like high definition TV.</p>													
	<p align="center"><b>Native</b></p>	<p>Projects the image as its original resolution and resizes it to fit within the display area. For input signals with lower resolutions, the projected image will be displayed in its original size.</p>													
	<p align="center"><b>Auto</b></p>	<p>Scales an image proportionally to fit the projector's native resolution in its horizontal width. This is suitable for the incoming image which is neither 4:3 nor 16:9 and you want to make the most use of the screen without altering the image's aspect ratio.</p>													
	<p align="center"><b>16:10<sup>6</sup></b></p>	<p>Scales an image so that it is displayed in the center of the screen with a 16:10 aspect ratio. This is most suitable for images which are already in a 16:10 aspect.</p>													
<p align="center"><b>LBX<sup>7</sup></b></p>	<p>For non-16:9 letterbox source and if you use an external 16:9 lens to display 2.35:1 aspect ratio in full resolution.</p>														
<p align="center"><b>Edge Mask</b></p>	<p>Remove the video encoding noise on the edge of the video source.</p>														
<p align="center"><b>Zoom</b></p>	<p>Reduce or magnify the projected image.</p>														
<p align="center"><b>Image Shift</b></p>	<p>Adjust the projected image horizontally or vertically.</p>														
<p align="center"><b>V. Keystone</b></p>	<p>Adjust image distortion vertically.</p>														
<p align="center"><b>Auto Keystone</b></p>	<p>Automatically correct the keystone.</p>														

<sup>7</sup> WXGA models

Menu	Description																		
<b>3D</b>	<p><u>3D Mode</u> Enable or disable the 3D function.</p> <p><u>3D-2D</u> Select how the 3D content should appear on screen.</p> <table border="1" style="width: 100%; border-collapse: collapse;"> <thead> <tr> <th style="background-color: #ff0000; color: white;">Option</th> <th style="background-color: #ff0000; color: white;">Description</th> </tr> </thead> <tbody> <tr> <td style="text-align: center;"><b>3D</b></td> <td>Display the 3D signal.</td> </tr> <tr> <td style="text-align: center;"><b>L (Left)</b></td> <td>Display the left frame of the 3D content.</td> </tr> <tr> <td style="text-align: center;"><b>R (Right)</b></td> <td>Display the right frame of the 3D content.</td> </tr> </tbody> </table> <p><u>3D Format</u> Select the 3D content format.</p> <p style="text-align: center;"><b>NOTE:</b> A Blu-ray 3D source will be detected automatically, and options will not be selectable.</p> <table border="1" style="width: 100%; border-collapse: collapse;"> <thead> <tr> <th style="background-color: #ff0000; color: white;">Option</th> <th style="background-color: #ff0000; color: white;">Description</th> </tr> </thead> <tbody> <tr> <td style="text-align: center;"><b>Auto</b></td> <td>When a 3D identification signal is detected, the 3D format is selected automatically.</td> </tr> <tr> <td style="text-align: center;"><b>Side by Side</b></td> <td>Display in Side-by-Side format.</td> </tr> <tr> <td style="text-align: center;"><b>Top and Bottom</b></td> <td>Display in Top and Bottom format.</td> </tr> <tr> <td style="text-align: center;"><b>Frame Sequential</b></td> <td>Display in Frame Sequential format.</td> </tr> </tbody> </table> <p><u>3D Sync Invert</u> Enable or disable the 3D Sync Invert function.</p>	Option	Description	<b>3D</b>	Display the 3D signal.	<b>L (Left)</b>	Display the left frame of the 3D content.	<b>R (Right)</b>	Display the right frame of the 3D content.	Option	Description	<b>Auto</b>	When a 3D identification signal is detected, the 3D format is selected automatically.	<b>Side by Side</b>	Display in Side-by-Side format.	<b>Top and Bottom</b>	Display in Top and Bottom format.	<b>Frame Sequential</b>	Display in Frame Sequential format.
Option	Description																		
<b>3D</b>	Display the 3D signal.																		
<b>L (Left)</b>	Display the left frame of the 3D content.																		
<b>R (Right)</b>	Display the right frame of the 3D content.																		
Option	Description																		
<b>Auto</b>	When a 3D identification signal is detected, the 3D format is selected automatically.																		
<b>Side by Side</b>	Display in Side-by-Side format.																		
<b>Top and Bottom</b>	Display in Top and Bottom format.																		
<b>Frame Sequential</b>	Display in Frame Sequential format.																		

**NOTE:** This projector is a 3D ready projector with DLP-Link 3D solution. Please make sure your 3D glasses are for DLP-Link 3D. This projector supports frame sequential (page-flip) 3D via the **HDMI 1/HDMI 2** ports. For the best performance, 1920 x 1080 resolution is recommended. Please note that 4K (3840 x 2160) resolution is not supported in 3D mode.

## Setup Menu



Menu	Description
<b>Language</b>	Select the On-Screen Display (OSD) Menu language.
<b>Projection</b>	Select the preferred projection position.
<b>Menu Location</b>	Select the location for the On-Screen Display (OSD) Menu.
<b>Screen Type</b>	Select between a 16:10 or 16:9 aspect ratio.
<b>Security</b>	<p><u>Security</u> Enable or disable a password prompt before using the projector. <b>NOTE:</b> The default password is: 1234</p> <p><u>Security Timer</u> Set the amount of time the projector can be used. Once this time has elapsed you will be requested to enter your password again.</p> <p><u>Change Password</u> Set or modify the password.</p>
<b>Audio Settings</b>	<p><u>Mute</u> Temporarily turn off the sound.</p> <p><u>Volume</u> Adjust the volume level.</p> <p><u>Audio Input</u> Select the audio input source.</p>
<b>Advanced</b>	<p><u>Logo</u> Set the “startup screen”. If changes are made, they will take effect the next time the projector is powered on.</p>

Menu	Description
<p style="text-align: center;"><b>HDMI CEC</b></p>	<p>When you connect HDMI CEC-compatible devices to the projector with HDMI cables, you can control them on the same power on or power off status using the HDMI CEC control feature in the projector's OSD. This lets one device or multiple devices in a group power on or power off via HDMI CEC in a typical configuration.</p> <p><b>NOTE:</b></p> <ul style="list-style-type: none"> <li>• In order for the CEC function to work properly, make sure that the device is correctly connected to the <b>HDMI</b> input of the projector via an HDMI cable, and its CEC function is turned on.</li> <li>• Depending on the connected device, the CEC function may not work.</li> <li>• The CEC function supports the projector powering off the device and the device powering on the projector.</li> </ul>



# Options Menu

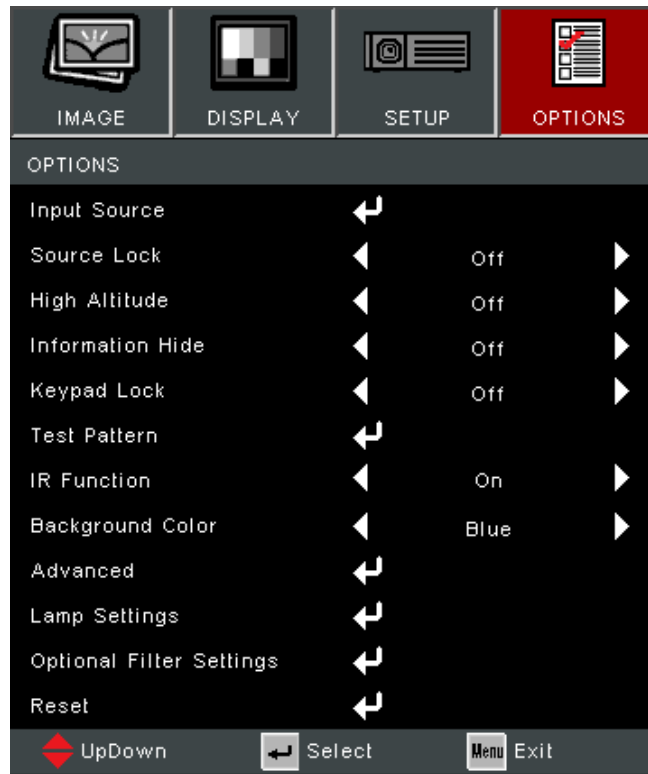

Menu	Description
<b>Input Source</b>	Use this option to enable / disable input sources.
<b>Source Lock</b>	<p><u>On</u> The projector will only search the current input selection.</p> <p><u>Off</u> The projector will search for other signals if the current input signal is lost.</p>
<b>High Altitude</b>	When “On” is selected, the fans will spin faster. This feature is useful in high altitude areas where the air is thin.
<b>Information Hide</b>	Choose “On” to hide the info message. Choose “Off” to show source message.
<b>Keypad Lock</b>	<p>When the keypad lock function is “On”, the control panel will be locked however, the projector can be operated by the remote control. By selecting “Off”, you will be able to use the control panel once more.</p> <p><b>NOTE:</b> To turn off the keypad lock, press and hold “Enter” key on top of the projector for 5 seconds.</p>
<b>Test Pattern</b>	Select the test pattern from grid and white.
<b>IR Function</b>	Enable/disable remote control operation.
<b>Background Color</b>	Display a black, red, blue, green, or white screen when no input source is available.

Menu	Description								
<b>Advanced</b>	<p><u>Direct Power On</u> Automatically power on the projector when AC power is supplied, without pressing the <b>Power</b> button on the projector or the remote control.</p> <p><u>Auto Power Off</u> A countdown timer will start when there is no signal being sent to the projector. The projector will automatically power off when the countdown has finished (in minutes).</p> <p><u>Power Mode (Standby)</u></p> <table border="1" data-bbox="584 586 1370 797"> <thead> <tr> <th data-bbox="584 586 858 631">Option</th> <th data-bbox="858 586 1370 631">Description</th> </tr> </thead> <tbody> <tr> <td data-bbox="584 631 858 714">Active</td> <td data-bbox="858 631 1370 714">Normal standby (&gt; 0.5W) with VGA available.</td> </tr> <tr> <td data-bbox="584 714 858 797">Eco</td> <td data-bbox="858 714 1370 797">Reduce power use (&lt; 0.5W) with no VGA available.</td> </tr> </tbody> </table> <p><u>Signal Power On</u> Automatically power on the projector when a signal is detected from the input source, without pressing the <b>Power</b> button on the projector or on the remote control.</p> <p style="text-align: center;"><b>NOTE:</b> The projector will not power on automatically by HDMI if there is only one HDMI cable connected.</p> <p><u>Exit</u> Exit the Advanced menu.</p>	Option	Description	Active	Normal standby (> 0.5W) with VGA available.	Eco	Reduce power use (< 0.5W) with no VGA available.		
Option	Description								
Active	Normal standby (> 0.5W) with VGA available.								
Eco	Reduce power use (< 0.5W) with no VGA available.								
<b>Lamp Settings</b>	<p><u>Lamp Hour</u> Displays the lamp hours of the current lamp.</p> <p><u>Lamp Reminder</u> Show or to hide a warning message when the “change lamp message” is displayed.</p> <p><u>Brightness Mode</u></p> <table border="1" data-bbox="584 1464 1370 1800"> <thead> <tr> <th data-bbox="584 1464 858 1509">Option</th> <th data-bbox="858 1464 1370 1509">Description</th> </tr> </thead> <tbody> <tr> <td data-bbox="584 1509 858 1592">Bright</td> <td data-bbox="858 1509 1370 1592">Highest brightness and power consumption.</td> </tr> <tr> <td data-bbox="584 1592 858 1675">Eco</td> <td data-bbox="858 1592 1370 1675">Dim the light output, lowering power consumption.</td> </tr> <tr> <td data-bbox="584 1675 858 1800">Dynamic</td> <td data-bbox="858 1675 1370 1800">Automatically adjust the picture brightness in order to give optimum contrast performance.</td> </tr> </tbody> </table> <p><u>Lamp Reset</u> Resets the Lamp Hour counter. Should be used after replacing the lamp.</p> <p><u>Exit</u> Exit Lamp Settings.</p>	Option	Description	Bright	Highest brightness and power consumption.	Eco	Dim the light output, lowering power consumption.	Dynamic	Automatically adjust the picture brightness in order to give optimum contrast performance.
Option	Description								
Bright	Highest brightness and power consumption.								
Eco	Dim the light output, lowering power consumption.								
Dynamic	Automatically adjust the picture brightness in order to give optimum contrast performance.								

Menu	Description
<p><b>Optional Filter Settings</b></p>	<p><u>Optional Filter Installed</u>  Select “Yes” to display warning message after a specified number of hours. Select “No” to turn off warning message.  <b>NOTE:</b> The default setting is “No”. After installing a filter, please turn on the projector then press <b>Menu</b>, go to <b>Options &gt; Optional Filter Settings &gt; Optional Filter Installed</b> and select <b>Yes</b>.</p> <p><u>Filter Usage Hours</u>  Displays the filter hours.</p> <p><u>Filter Reminder</u>  Select the number of hours until the filter message is displayed.  <b>NOTE:</b> Factory default is 500 hours.</p> <p><u>Filter Reset</u>  Reset the dust filter counter after replacing or cleaning the dust filter.</p> <p><u>Exit</u>  Exit the Optional Filter Settings menu.</p>
<p><b>Reset</b></p>	<p>Return the settings to default.  <b>NOTE:</b> When resetting, the following settings will still remain: Auto Keystone, Filter Usage Hours, High Altitude, Lamp hours, Language, Optional Filter installed, Password, Power Mode (Standby), Projection, Security, Security Timer, V Keystone.</p>

**NOTE:**

- Acoustic noise level of the projector may increase after installing a dust filter.
- For high temperature (> 35°C) or high attitude (> 1524 m) operation conditions, it is recommended to switch to “High Altitude” cooling mode when the dust filter is installed.
- It is recommended to clean the dust filter every 100 hours after the dust filter is installed.
- Turn off the projector and unplug it from its power source before installing or detaching the filter.

# Appendix

## Specifications - PA700

Item	Category	Specifications		
		PA700S	PA700X	PA700W
Projector	Type	Lamp (RLC-128)		
	Display Size	30"~300"		
	Throw Ratio	1.94~2.16 (100"@ 3.94 m)		1.54~1.72 (100" @ 3.33 m)
	Lens	F=2.42~2.53, f=21.85~24.01 mm		
	Display System	1-CHIP DMD		
Resolution	Native	800 x 600	1024 x 768	1280 x 800
Input Signal	HDMI	f <sub>h</sub> : 15~102 kHz, f <sub>v</sub> : 23~120 Hz, Pixel rate: 170 MHz		
Power <sup>1</sup>	Input Voltage	AC 100-240V, 50/60 Hz (auto switch)		
Operating Conditions	Temperature	0°C to 40°C (32°F to 104°F)		
	Humidity	10% to 80% (non-condensing)		
	Altitude	0 to 1,524 m (0 to 5,000 ft.) at 0°C to 35°C 1,525 to 3,657 m (5,000 to 12,000 ft.) at 0°C to 30°C		
Storage Conditions	Temperature	-30°C to 65°C (-22°F to 149°F)		
	Humidity	10% to 90% (non-condensing)		
	Altitude	0 to 12,192 km (0 to 40,000 ft.)		
Dimensions	Physical (W x H x D)	309 x 115 x 234 mm (12.2" x 4.5" x 9.21")		
Weight	Physical	2.70 kg (5.95 lbs)		
Power Consumption	On <sup>2</sup>	295W (Typical)		
	Off	< 0.5W (Standby)		

<sup>1</sup> Please use the power adapter from ViewSonic® or an authorized source only.

<sup>2</sup> The test condition follows EEI standards.

## Specifications - PS502

Item	Category	Specifications	
		PS502X	PS502W
Projector	Type	Lamp (RLC-128)	
	Display Size	60"~300"	
	Throw Ratio	0.616 (77" @ 0.96 m)	0.52 (87" @ 0.97 m)
	Lens	F=2.7, f=7.15 mm	F=2.8, f=7.51 mm
	Display System	1-CHIP DMD	
Resolution	Native	1024 x 768	1280 x 800
Input Signal	HDMI	$f_h$ : 15~102 kHz, $f_v$ : 23~120 Hz, Pixel rate: 170 MHz	
Power <sup>3</sup>	Input Voltage	AC 100-240V, 50/60 Hz (auto switch)	
Operating Conditions	Temperature	0°C to 40°C (32°F to 104°F)	
	Humidity	10% to 80% (non-condensing)	
	Altitude	0 to 1,524 m (0 to 5,000 ft.) at 0°C to 35°C 1,525 to 3,657 m (5,000 to 12,000 ft.) at 0°C to 30°C	
Storage Conditions	Temperature	-30°C to 65°C (-22°F to 149°F)	
	Humidity	10% to 90% (non-condensing)	
	Altitude	0 to 12.1 km (0 to 40,000 ft.)	
Dimensions	Physical (W x H x D)	309 x 115 x 234 mm (12.2" x 4.5" x 9.21")	
Weight	Physical	2.87 kg (6.32 lbs)	
Power Consumption	On <sup>4</sup>	295W (Typical)	
	Off	< 0.5W (Standby)	

<sup>3</sup> Please use the power adapter from ViewSonic® or an authorized source only.

<sup>4</sup> The test condition follows EEI standards.

# Projector Dimensions

309 mm (W) x 115 mm (H) x 234 mm (D)

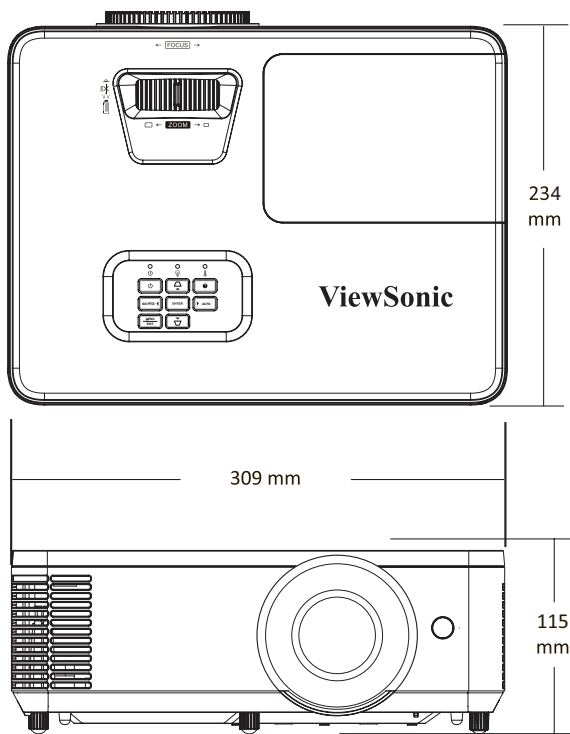

**PA700 Series**

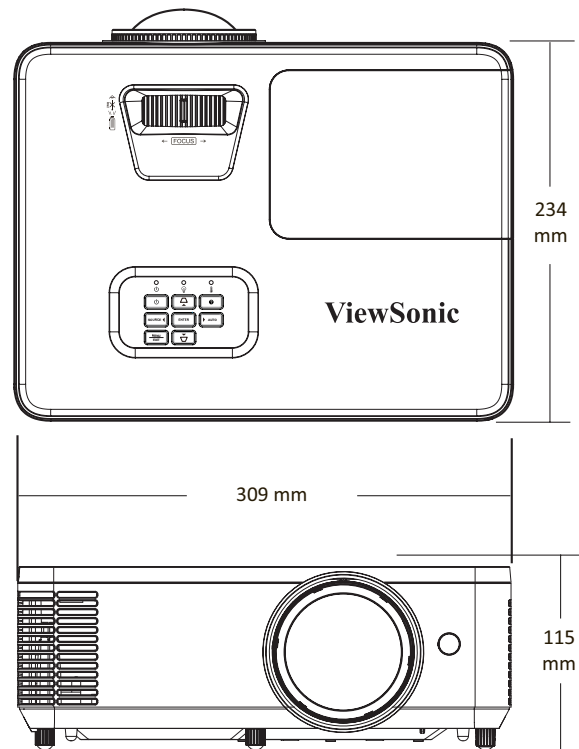

**PS502 Series**

# Timing Chart

## Analog RGB

<b>Signal</b>	<b>Resolution</b>	<b>Refresh Rate (Hz)</b>
VGA	640 x 480	60/67/72/75
SVGA	800 x 600	56/60/72/75
XGA	1024 x 768	60/70/75
	1152 x 864	75
WXGA	1280 x 800	60
Quad-VGA	1280 x 960	60
SXGA	1280 x 1024	60/75
WXGA	1366 x 768	60
WXGA+	1440 x 900	60
UXGA	1600 x 1200	60
WSXGA+	1680 x 1050	60
HD	1280 x 720	60/120
MAC 13"	640 x 480	67
MAC 16"	832 x 624	75
MAC 19"	1024 x 768	75
MAC 21"	1152 x 870	75
HDTV(1080p)	1920 X 1080	60

## HDMI PC

Signal	Resolution	Refresh Rate (Hz)
VGA	640 x 480	60/67/72/75
SVGA	800 x 600	56/60/72/75
XGA	1024 x 768	60/70/75
	1152 x 864	75
WXGA	1280 x 800	60
Quad-VGA	1280 x 960	60
SXGA	1280 x 1024	60/75
WXGA+	1440 x 900	60
UXGA	1600 x 1200	60
WSXGA+	1680 x 1050	60
MAC 16"	832 x 624	75
MAC 21"	1152 x 870	75
Full HD	1920 x 1080	60

## HDMI Video

Signal	Resolution	Refresh Rate (Hz)
HDTV(1080p)	1920 x 1080	50/60
HDTV(1080i)	1920 x 1080	50/60
HDTV(720p)	1280 x 720	50/60
SDTV(480p)	720 X 480	60
SDTV(576p)	720 x 576	50
SDTV(480i)	720 X 480	60
SDTV(576i)	720 x 576	50



## HDMI 3D

Signal	Resolution	Refresh Rate (Hz)
<b>Frame Packing</b>		
<b>1080p</b>	1920 x 1080	24
<b>720p</b>	1280 x 720	50/60
<b>Side by Side</b>		
<b>1080i</b>	1920 x 1080	50/60
<b>Top and Bottom</b>		
<b>1080p</b>	1920 x 1080	24
<b>720p</b>	1280 x 720	50/60

### NOTE:

- 1080i@25hz and 720p@50hz will run in 100 Hz; other 3D timing will run in 120 Hz.
- 1080P@24hz will run 144Hz (XGA, WXGA, 1080p)/96Hz (WUXGA).
- If the input frame rate is 48 Hz or greater, the output frame rate is set to twice the input frame rate (FRC = 2X mode).
- If the 3D input frame rate is 25Hz or greater, the output frame rate is set to four times the input frame rate (FRC = 4X mode).
- If the 3D input frame rate is 24Hz (includes 23.9Hz), the output frame rate is set to six times the input frame rate (FRC = 6X mode).

## Troubleshooting

This section describes some common problems that you may experience when using the projector.

Problem or Issue	Possible Solutions
The projector does not turn on	<ul style="list-style-type: none"><li>• Ensure the power cord is properly attached to the projector and to the power outlet.</li><li>• If the cooling process has not completed, please wait until it has finished then try to turn on the projector again.</li><li>• If the above does not work, try another power outlet or another electrical device with the same power outlet.</li></ul>
There is no picture	<ul style="list-style-type: none"><li>• Ensure the video source cable is connected properly, and that the video source is turned on.</li><li>• If the input source is not selected automatically, select the correct source with the “Source Input” on either the projector or the remote control.</li></ul>
The image is blurred	<ul style="list-style-type: none"><li>• Adjusting focus with the Focus Ring will help correctly focus the projection lens.</li><li>• Ensure the projector and screen are aligned properly. If necessary, adjust the height of the projector as well as the projection angle and direction.</li></ul>
The image is reversed	<ul style="list-style-type: none"><li>• Open the OSD Menu and go to: <b>Setup &gt; Projection</b> and adjust the projection option.</li></ul>
The image is stretched when projecting a 16:9 DVD	<ul style="list-style-type: none"><li>• When you play an anamorphic DVD or 16:9 DVD, the projector will show the best image in 16:9.</li><li>• If you play a 4:3 format DVD title, please change the format as 4:3 in projector OSD Menu.</li><li>• Please setup the display format as 16:9 (wide) aspect ratio on the DVD player.</li></ul>

<b>Problem or Issue</b>	<b>Possible Solutions</b>
The remote control does not work	<ul style="list-style-type: none"><li>• Ensure there are no obstacles between the remote control and projector; and that they are within range.</li><li>• The batteries may be out of power, please check and replace if necessary.</li></ul>
The projector stops responding to all controls	<ul style="list-style-type: none"><li>• Turn off the projector and unplug the power cord. Wait at least 20 seconds then reconnect and try again.</li></ul>

## LED Indicators

When the warning indicators (see below) light up or flash, the projector will automatically shutdown. Unplug the power cord from the projector, wait for 30 seconds and try again. If the warning indicators light up or flash, please contact your nearest service center for assistance.

Status and Description	Power Indicator Light		Temperature Indicator Light	Light Source Indicator Light
	Red	Blue	Red	Red
<b>Standby State (Power cord input)</b>	Steady Light			
<b>Power On (Warming)</b>		Flashing (0.5 sec off/0.5 sec on)		
<b>Power On and Lamp Lighting</b>		Steady Light		
<b>Power Off (Cooling)</b>		Flashing (0.5 sec off/0.5 sec on)  Back to red steady light when the cooling fan turns off.		
<b>Error (Lamp failure)</b>	Flashing			Steady Light
<b>Error (Fan failure)</b>	Flashing		Flashing	
<b>Error (Overheat)</b>	Flashing		Steady Light	

# Maintenance

## General Precautions

- Make sure the projector is turned off and the power cable is unplugged from the power outlet.
- Never remove any parts from the projector. Contact ViewSonic® or a reseller when any part of the projector needs replacing.
- Never spray or pour any liquid directly onto the case.
- Handle the projector with care, as a darker-colored projector, if scuffed, may show marks more clearly than a lighter-colored projector.

## Cleaning the Lens

- Use a canister of compressed air to remove dust.
- If the lens is still not clean, use lens-cleaning paper or moisten a soft cloth with lens cleaner and gently wipe the surface.

**CAUTION:** Never rub the lens with abrasive materials.

## Cleaning the Case

- Use a soft, lint-free, dry cloth to remove dirt or dust.
- If the case is still not clean, apply a small amount of non-ammonia, non-alcohol based, mild non-abrasive detergent onto a clean, soft, lint-free cloth, then wipe the surface.

**CAUTION:** Never use wax, alcohol, benzene, thinner, or other chemical detergents.

## Storing the Projector

If you intend to store the projector for an extended period of time:

- Ensure the temperature and humidity of the storage area are within the recommend range.
- Retract the adjuster foot completely.
- Remove the batteries from the remote control.
- Pack the projector in its original packaging or equivalent.

## Disclaimer

- ViewSonic® does not recommend the use of any ammonia or alcohol-based cleaners on the lens or case. Some chemical cleaners have been reported to damage the lens and/or case of the projector.
- ViewSonic® will not be liable for damage resulting from use of any ammonia or alcohol-based cleaners.

# Regulatory and Service Information

## Compliance Information

This section addresses all connected requirements and statements regarding regulations. Confirmed corresponding applications shall refer to nameplate labels and relevant markings on the unit.

### FCC Compliance Statement

This device complies with part 15 of FCC Rules. Operation is subject to the following two conditions: (1) this device may not cause harmful interference, and (2) this device must accept any interference received, including interference that may cause undesired operation. This equipment has been tested and found to comply with the limits for a Class B digital device, pursuant to part 15 of the FCC Rules.

These limits are designed to provide reasonable protection against harmful interference in a residential installation. This equipment generates, uses, and can radiate radio frequency energy, and if not installed and used in accordance with the instructions, may cause harmful interference to radio communications. However, there is no guarantee that interference will not occur in a particular installation. If this equipment does cause harmful interference to radio or television reception, which can be determined by turning the equipment off and on, the user is encouraged to try to correct the interference by one or more of the following measures:

- Reorient or relocate the receiving antenna.
- Increase the separation between the equipment and receiver.
- Connect the equipment into an outlet on a circuit different from that to which the receiver is connected.
- Consult the dealer or an experienced radio/TV technician for help.

**Warning:** You are cautioned that changes or modifications not expressly approved by the party responsible for compliance could void your authority to operate the equipment.

### Industry Canada Statement

CAN ICES-003(B) / NMB-003(B)

## CE Conformity for European Countries

**CE** The device complies with the EMC Directive 2014/30/EU and Low Voltage Directive 2014/35/EU. Ecodesign Directive 2009/125/EC.

### The following information is only for EU-member states:

The mark shown to the right is in compliance with the Waste Electrical and Electronic Equipment Directive 2012/19/EU (WEEE). The mark indicates the requirement NOT to dispose of the equipment as unsorted municipal waste, but use the return and collection systems according to local law.



## Declaration of RoHS2 Compliance

This product has been designed and manufactured in compliance with Directive 2011/65/EU of the European Parliament and the Council on restriction of the use of certain hazardous substances in electrical and electronic equipment (RoHS2 Directive) and is deemed to comply with the maximum concentration values issued by the European Technical Adaptation Committee (TAC) as shown below:

Substance	Proposed Maximum Concentration	Actual Concentration
Lead (Pb)	0.1%	< 0.1%
Mercury (Hg)	0.1%	< 0.1%
Cadmium (Cd)	0.01%	< 0.01%
Hexavalent Chromium (Cr6 <sup>+</sup> )	0.1%	< 0.1%
Polybrominated biphenyls (PBB)	0.1%	< 0.1%
Polybrominated diphenyl ethers (PBDE)	0.1%	< 0.1%
Bis (2-ethylhexyl) phthalate (DEHP)	0.1%	< 0.1%
Butyl benzyl phthalate (BBP)	0.1%	< 0.1%
Dibutyl phthalate (DBP)	0.1%	< 0.1%
Diisobutyl phthalate (DIBP)	0.1%	< 0.1%

**Certain components of products as stated above are exempted under the Annex III of the RoHS2 Directives as noted below. Examples of exempted components are:**

- Mercury in cold cathode fluorescent lamps and external electrode fluorescent lamps (CCFL and EEFL) for special purposes not exceeding (per lamp):
  - » Short length (500 mm): maximum 3.5 mg per lamp.
  - » Medium length (> 500 mm and 1,500 mm): maximum 5 mg per lamp.
  - » Long length (> 1,500 mm): maximum 13 mg per lamp.
- Lead in glass of cathode ray tubes.
- Lead in glass of fluorescent tubes not exceeding 0.2% by weight.
- Lead as an alloying element in aluminum containing up to 0.4% lead by weight.
- Copper alloy containing up to 4% lead by weight.
- Lead in high melting temperature type solders (i.e. lead-based alloys containing 85% by weight or more lead).
- Electrical and electronic components containing lead in a glass or ceramic other than dielectric ceramic in capacitors, e.g. piezoelectronic devices, or in a glass or ceramic matrix compound.



## **Indian Restriction of Hazardous Substances**

Restriction on Hazardous Substances statement (India). This product complies with the “India E-waste Rule 2011” and prohibits use of lead, mercury, hexavalent chromium, polybrominated biphenyls or polybrominated diphenyl ethers in concentrations exceeding 0.1 weight % and 0.01 weight % for cadmium, except for the exemptions set in Schedule 2 of the Rule.

## **Product Disposal at End of Product Life**

ViewSonic® respects the environment and is committed to working and living green. Thank you for being part of Smarter, Greener Computing. Please visit the ViewSonic® website to learn more.

### **USA & Canada:**

<https://www.viewsonic.com/us/go-green-with-viewsonic>

### **Europe:**

<https://www.viewsonic.com/eu/go-green-with-viewsonic>

### **Taiwan:**

<https://recycle.epa.gov.tw/>

## Copyright Information

Copyright© ViewSonic® Corporation, 2023. All rights reserved.

Macintosh and Power Macintosh are registered trademarks of Apple Inc.

Microsoft, Windows, and the Windows logo are registered trademarks of Microsoft Corporation in the United States and other countries.

ViewSonic®, the three birds logo, OnView, ViewMatch, and ViewMeter are registered trademarks of ViewSonic® Corporation.

VESA is a registered trademark of the Video Electronics Standards Association. DPMS, DisplayPort, and DDC are trademarks of VESA.

ENERGY STAR® is a registered trademark of the U.S. Environmental Protection Agency (EPA).

As an ENERGY STAR® partner, ViewSonic® Corporation has determined that this product meets the ENERGY STAR® guidelines for energy efficiency.

**Disclaimer:** ViewSonic® Corporation shall not be liable for technical or editorial errors or omissions contained herein; nor for incidental or consequential damages resulting from furnishing this material, or the performance or use of this product.

In the interest of continuing product improvement, ViewSonic® Corporation reserves the right to change product specifications without notice. Information in this document may change without notice.

No part of this document may be copied, reproduced, or transmitted by any means, for any purpose without prior written permission from ViewSonic® Corporation.

## Customer Service

For technical support or product service, see the table below or contact your reseller.

**NOTE:** You will need the product's serial number.

Country/ Region	Website	Country/ Region	Website
<b>Asia Pacific &amp; Africa</b>			
Australia	<a href="http://www.viewsonic.com/au/">www.viewsonic.com/au/</a>	Bangladesh	<a href="http://www.viewsonic.com/bd/">www.viewsonic.com/bd/</a>
中国 (China)	<a href="http://www.viewsonic.com.cn">www.viewsonic.com.cn</a>	香港 (繁體中文)	<a href="http://www.viewsonic.com/hk/">www.viewsonic.com/hk/</a>
Hong Kong (English)	<a href="http://www.viewsonic.com/hk-en/">www.viewsonic.com/hk-en/</a>	India	<a href="http://www.viewsonic.com/in/">www.viewsonic.com/in/</a>
Indonesia	<a href="http://www.viewsonic.com/id/">www.viewsonic.com/id/</a>	Israel	<a href="http://www.viewsonic.com/il/">www.viewsonic.com/il/</a>
日本 (Japan)	<a href="http://www.viewsonic.com/jp/">www.viewsonic.com/jp/</a>	Korea	<a href="http://www.viewsonic.com/kr/">www.viewsonic.com/kr/</a>
Malaysia	<a href="http://www.viewsonic.com/my/">www.viewsonic.com/my/</a>	Middle East	<a href="http://www.viewsonic.com/me/">www.viewsonic.com/me/</a>
Myanmar	<a href="http://www.viewsonic.com/mm/">www.viewsonic.com/mm/</a>	Nepal	<a href="http://www.viewsonic.com/np/">www.viewsonic.com/np/</a>
New Zealand	<a href="http://www.viewsonic.com/nz/">www.viewsonic.com/nz/</a>	Pakistan	<a href="http://www.viewsonic.com/pk/">www.viewsonic.com/pk/</a>
Philippines	<a href="http://www.viewsonic.com/ph/">www.viewsonic.com/ph/</a>	Singapore	<a href="http://www.viewsonic.com/sg/">www.viewsonic.com/sg/</a>
臺灣 (Taiwan)	<a href="http://www.viewsonic.com/tw/">www.viewsonic.com/tw/</a>	ประเทศไทย	<a href="http://www.viewsonic.com/th/">www.viewsonic.com/th/</a>
Việt Nam	<a href="http://www.viewsonic.com/vn/">www.viewsonic.com/vn/</a>	South Africa & Mauritius	<a href="http://www.viewsonic.com/za/">www.viewsonic.com/za/</a>
<b>Americas</b>			
United States	<a href="http://www.viewsonic.com/us">www.viewsonic.com/us</a>	Canada	<a href="http://www.viewsonic.com/us">www.viewsonic.com/us</a>
Latin America	<a href="http://www.viewsonic.com/la">www.viewsonic.com/la</a>		
<b>Europe</b>			
Europe	<a href="http://www.viewsonic.com/eu/">www.viewsonic.com/eu/</a>	France	<a href="http://www.viewsonic.com/fr/">www.viewsonic.com/fr/</a>
Deutschland	<a href="http://www.viewsonic.com/de/">www.viewsonic.com/de/</a>	Қазақстан	<a href="http://www.viewsonic.com/kz/">www.viewsonic.com/kz/</a>
Россия	<a href="http://www.viewsonic.com/ru/">www.viewsonic.com/ru/</a>	España	<a href="http://www.viewsonic.com/es/">www.viewsonic.com/es/</a>
Türkiye	<a href="http://www.viewsonic.com/tr/">www.viewsonic.com/tr/</a>	Україна	<a href="http://www.viewsonic.com/ua/">www.viewsonic.com/ua/</a>
United Kingdom	<a href="http://www.viewsonic.com/uk/">www.viewsonic.com/uk/</a>		

## Limited Warranty

### ViewSonic® Projector

#### What the warranty covers:

ViewSonic® warrants its products to be free from defects in material and workmanship, under normal use, during the warranty period. If a product proves to be defective in material or workmanship during the warranty period, ViewSonic® will, at its sole option, repair or replace the product with a like product. Replacement product or parts may include remanufactured or refurbished parts or components.

#### Limited Three (3) year General Warranty:

Subject to the more limited one (1) year warranty set out below, North and South America: Three (3) years warranty for all parts excluding the lamp, three (3) years for labor, and one (1) year for the original lamp from the date of the first consumer purchase.

Other regions or countries: Please check with your local dealer or local ViewSonic® office for the warranty information.

#### Limited One (1) year Heavy Usage Warranty:

Under heavy usage settings, where a projector's use includes more than fourteen (14) hours average daily usage, North and South America: One (1) year warranty for all parts excluding the lamp, one (1) year for labor, and ninety (90) days for the original lamp from the date of the first consumer purchase; Europe: One (1) year warranty for all parts excluding the lamp, one (1) year for labor, and ninety (90) days for the original lamp from the date of the first consumer purchase. Other regions or countries: Please check with your local dealer or local ViewSonic® office for the warranty information. Lamp warranty subject to terms and conditions, verification and approval. Applies to manufacturer's installed lamp only. All accessory lamps purchased separately are warranted for 90 days.

#### Who the warranty protects:

This warranty is valid only for the first consumer purchaser.

#### What the warranty does not cover:

1. Any product on which the serial number has been defaced, modified, or removed.

## 2. Damage, deterioration, or malfunction resulting from:

- » Accident, misuse, neglect, fire, water, lightning, or other acts of nature, unauthorized product modification, or failure to follow instructions supplied with the product.
- » Operation outside of product specifications.
- » Operation of the product for other than the normal intended use or not under normal conditions.
- » Repair or attempted repair by anyone not authorized by ViewSonic®.
- » Any damage of the product due to shipment.
- » Removal or installation of the product.
- » Causes external to the product, such as electric power fluctuations or failure.
- » Use of supplies or parts not meeting Viewsonic's specifications.
- » Normal wear and tear.
- » Any other cause which does not relate to a product defect.

## 3. Removal, installation, and set-up service charges.

### **How to get service:**

1. For information about receiving service under warranty, contact ViewSonic® Customer Support (Please refer to the "Customer Support" page). You will need to provide your product's serial number.
2. To obtain warranted service, you will be required to provide: (a) the original dated sales slip, (b) your name, (c) your address, (d) a description of the problem, and (e) the serial number of the product.
3. Take or ship the product, freight prepaid, in the original container to an authorized ViewSonic® service center or ViewSonic®.
4. For additional information or the name of the nearest ViewSonic® service center, contact ViewSonic®.

### **Limitation of implied warranties:**

There are no warranties, express or implied, which extend beyond the description contained herein including the implied warranty of merchantability and fitness for a particular purpose.

**Exclusion of damages:**

ViewSonic's liability is limited to the cost of repair or replacement of the product. ViewSonic® shall not be liable for:

1. Damage to other property caused by any defects in the product, damages based upon inconvenience, loss of use of the product, loss of time, loss of profits, loss of business opportunity, loss of goodwill, interference with business relationships, or other commercial loss, even if advised of the possibility of such damages.
2. Any other damages, whether incidental, consequential or otherwise.
3. Any claim against the customer by any other party.

**Effect of state law:**

This warranty gives you specific legal rights, and you may also have other rights which vary from local authority. Some local governments do not allow limitations on implied warranties and/or do not allow the exclusion of incidental or consequential damages, so the above limitations and exclusions may not apply to you.

**Sales outside the U.S.A. and Canada:**

For warranty information and service on ViewSonic® products sold outside of the U.S.A. and Canada, contact ViewSonic® or your local ViewSonic® dealer.

The warranty period for this product in mainland China (Hong Kong, Macao, and Taiwan Excluded) is subject to the terms and conditions of the Maintenance Guarantee Card.

For users in Europe and Russia, full details of warranty provided can be found at: <http://www.viewsonic.com/eu/> under "Support/Warranty Information".

# Mexico Limited Warranty

## ViewSonic® Projector

### What the warranty covers:

ViewSonic® warrants its products to be free from defects in material and workmanship, under normal use, during the warranty period. If a product proves to be defective in material or workmanship during the warranty period, ViewSonic® will, at its sole option, repair or replace the product with a like product. Replacement product or parts may include remanufactured or refurbished parts or components & accessories.

### How long the warranty is effective:

3 years for all parts excluding the lamp, 3 years for labor, 1 year for the original lamp from the date of the first consumer purchase.

Lamp warranty subject to terms and conditions, verification and approval. Applies to manufacturer's installed lamp only.

All accessory lamps purchased separately are warranted for 90 days.

### Who the warranty protects:

This warranty is valid only for the first consumer purchaser.

### What the warranty excludes and does not cover:

1. Any product on which the serial number has been defaced, modified or removed.
2. Damage, deterioration, or malfunction resulting from:
  - » Accident, misuse, neglect, fire, water, lightning, or other acts of nature, unauthorized product modification, unauthorized attempted repair, or failure to follow instructions supplied with the product.
  - » Any damage of the product due to shipment.
  - » Causes external to the product, such as electrical power fluctuations or failure.
  - » Use of supplies or parts not meeting ViewSonic®'s specifications.
  - » Normal wear and tear.
  - » Any other cause which does not relate to a product defect.
3. Any product exhibiting a condition commonly known as "image burn-in" which results when a static image is displayed on the product for an extended period of time.
4. Removal, installation, insurance, and set-up service charges.

**How to get service:**

For information about receiving service under warranty, contact ViewSonic® Customer Support (Please refer to the attached “Customer Service” page). You will need to provide your product’s serial number, so please record the product information in the space provided below on your purchase for your future use. Please retain your receipt of proof of purchase to support your warranty claim.

**For Your Records**

Product Name: \_\_\_\_\_ Model Number: \_\_\_\_\_

Document Number: \_\_\_\_\_ Serial Number: \_\_\_\_\_

Purchase Date: \_\_\_\_\_ Extended Warranty Purchase? \_\_\_\_\_ (Y/N)

If so, what date does warranty expire? \_\_\_\_\_

1. To obtain warranty service, you will be required to provide (a) the original dated sales slip, (b) your name, (c) your address, (d) a description of the problem, and (e) the serial number of the product.
2. Take or ship the product, in the original container packaging, to an authorized ViewSonic® service center.
3. Round trip transportation costs for in-warranty products will be paid by ViewSonic®.

**Limitation of implied warranties:**

There are no warranties, express or implied, which extend beyond the description contained herein including the implied warranty of merchantability and fitness for a particular purpose.

**Exclusion of damages:**

ViewSonic®’s liability is limited to the cost of repair or replacement of the product. ViewSonic® shall not be liable for:

1. Damage to other property caused by any defects in the product, damages based upon inconvenience, loss of use of the product, loss of time, loss of profits, loss of business opportunity, loss of goodwill, interference with business relationships, or other commercial loss, even if advised of the possibility of such damages.
2. Any other damages, whether incidental, consequential or otherwise.
3. Any claim against the customer by any other party.
4. Repair or attempted repair by anyone not authorized by ViewSonic®.



Contact Information for Sales & Authorized Service (Centro Autorizado de Servicio) within Mexico:	
<b>Name, address, of manufacturer and importers:</b> México, Av. de la Palma #8 Piso 2 Despacho 203, Corporativo Interpalmas, Col. San Fernando Huixquilucan, Estado de México Tel: (55) 3605-1099 <a href="http://www.viewsonic.com/la/soporte/index.htm">http://www.viewsonic.com/la/soporte/index.htm</a>	
NÚMERO GRATIS DE ASISTENCIA TÉCNICA PARA TODO MÉXICO: 001.866.823.2004	
<b>Hermosillo:</b> Distribuciones y Servicios Computacionales SA de CV. Calle Juárez 284 local 2 Col. Bugambilias C.P: 83140 Tel: 01-66-22-14-9005 E-Mail: <a href="mailto:disc2@hmo.megared.net.mx">disc2@hmo.megared.net.mx</a>	<b>Villahermosa:</b> Compumantenimientos Garantizados, S.A. de C.V. AV. GREGORIO MENDEZ #1504 COL, FLORIDA C.P. 86040 Tel: 01 (993) 3 52 00 47 / 3522074 / 3 52 20 09 E-Mail: <a href="mailto:compumantenimientos@prodigy.net.mx">compumantenimientos@prodigy.net.mx</a>
<b>Puebla, Pue. (Matriz):</b> RENTA Y DATOS, S.A. DE C.V. Domicilio: 29 SUR 721 COL. LA PAZ 72160 PUEBLA, PUE. Tel: 01(52).222.891.55.77 CON 10 LINEAS E-Mail: <a href="mailto:datos@puebla.megared.net.mx">datos@puebla.megared.net.mx</a>	<b>Veracruz, Ver.:</b> CONEXION Y DESARROLLO, S.A DE C.V. Av. Americas # 419 ENTRE PINZÓN Y ALVARADO Fracc. Reforma C.P. 91919 Tel: 01-22-91-00-31-67 E-Mail: <a href="mailto:gacosta@qplus.com.mx">gacosta@qplus.com.mx</a>
<b>Chihuahua:</b> Soluciones Globales en Computación C. Magisterio # 3321 Col. Magisterial Chihuahua, Chih. Tel: 4136954 E-Mail: <a href="mailto:Cefeo@soluglobales.com">Cefeo@soluglobales.com</a>	<b>Cuernavaca:</b> Compusupport de Cuernavaca SA de CV Francisco Leyva # 178 Col. Miguel Hidalgo C.P. 62040, Cuernavaca Morelos Tel: 01 777 3180579 / 01 777 3124014 E-Mail: <a href="mailto:aquevedo@compusupportcva.com">aquevedo@compusupportcva.com</a>
<b>Distrito Federal:</b> QPLUS, S.A. de C.V. Av. Coyoacán 931 Col. Del Valle 03100, México, D.F. Tel: 01(52)55-50-00-27-35 E-Mail : <a href="mailto:gacosta@qplus.com.mx">gacosta@qplus.com.mx</a>	<b>Guadalajara, Jal.:</b> SERVICRECE, S.A. de C.V. Av. Niños Héroes # 2281 Col. Arcos Sur, Sector Juárez 44170, Guadalajara, Jalisco Tel: 01(52)33-36-15-15-43 E-Mail: <a href="mailto:mmiranda@servicrece.com">mmiranda@servicrece.com</a>
<b>Guerrero Acapulco:</b> GS Computación (Grupo Sesicomp) Progreso #6-A, Colo Centro 39300 Acapulco, Guerrero Tel: 744-48-32627	<b>Monterrey:</b> Global Product Services Mar Caribe # 1987, Esquina con Golfo Pérsico Fracc. Bernardo Reyes, CP 64280 Monterrey N.L. México Tel: 8129-5103 E-Mail: <a href="mailto:aydeem@gps1.com.mx">aydeem@gps1.com.mx</a>
<b>MERIDA:</b> ELECTROSER Av Reforma No. 403Gx39 y 41 Mérida, Yucatán, México CP97000 Tel: (52) 999-925-1916 E-Mail: <a href="mailto:rrrb@sureste.com">rrrb@sureste.com</a>	<b>Oaxaca, Oax.:</b> CENTRO DE DISTRIBUCION Y SERVICIO, S.A. de C.V. Murguía # 708 P.A., Col. Centro, 68000, Oaxaca Tel: 01(52)95-15-15-22-22 Fax: 01(52)95-15-13-67-00 E-Mail: <a href="mailto:gpotai2001@hotmail.com">gpotai2001@hotmail.com</a>
<b>Tijuana:</b> STD Av Ferrocarril Sonora #3780 L-C Col 20 de Noviembre Tijuana, Mexico	<b>FOR USA SUPPORT:</b> ViewSonic® Corporation 381 Brea Canyon Road, Walnut, CA. 91789 USA Tel: 800-688-6688 E-Mail: <a href="http://www.viewsonic.com">http://www.viewsonic.com</a>

