

USER MANUAL

Pro Lite

LCD Monitor

ENGLISH

Pro Lite LH3260HS
Pro Lite LH4360UHS
Pro Lite LH5560UHS
Pro Lite LH6560UHS

Thank you very much for choosing the iiyama LCD monitor for signage. We recommend that you take a few minutes to read this comprehensive manual carefully before installing and switching on the monitor. Please keep this manual in a safe place for your future reference.



Dear user, we congratulate you on the purchase of your iiyama LCD.

For details on warranty and locally used pixel policies that apply directly after installation of your product please check the iiyama website.

To report a fault, please contact your local support centre found at <https://iiyama.com>

Things to check before you call the iiyama information line

- | if the power cable is connected securely and turned on?
- | if the display has been turned on?
- | if the signal cable is connected securely and the correct input selected?
- | if the computer has been restarted with the display connected?
- | if the graphics card is correctly installed with the latest drivers possible?
- | if the correct native resolution has been selected via 'Display Properties'?
- | If the R/G/B signal configuration is correct?
- | if the displays On Screen Menu is shown?
- | if the correct brightness and contrast settings have been set?
- | if given display tolerances and compatibility have been considered?
- | if via the On Screen Menu you have performed a Factory Reset/Recall?

Before reporting the screen defect, please prepare the following information/evidence:

- | model number *
- | purchase receipt and serial number *
- | name and address for collection
- | telephone/fax number, for availability during the day
- | convenient collection date (date, time)
- | short description of the defect

Important Note:

If there is no fault found in the collected equipment after inspection, the transferring party shall incur charges for transport and administration.

If you have checked all of the above and there is still no picture, call our information line for assistance in your country.

* see the identification plate on the back of the case.

CE MARKING DECLARATION OF CONFORMITY

This LCD monitor complies with the requirements of the EC/EU Directive 2014/53/EU "RED Directive", 2009/125/EC "ErP Directive" and 2011/65/EU "RoHS Directive".

The electro-magnetic susceptibility has been chosen at a level that gives correct operation in residential areas, business and light industrial premises and small-scale enterprises, inside as well as outside of the buildings. All places of operation are characterised by their connection to the public low voltage power supply system.

Radiation Exposure Statement:

This equipment complies with CE radiation exposure limits set forth for an uncontrolled environment. This equipment should be installed and operated with minimum distance 20cm between the radiator & body.

Operating Frequency range and the maximum output power (EIRP) are listed below:

PL3260, PL4360U, PL5560U, PL6560U

| Function | Frequency | Maximum Output Power (EIRP) |
|----------|---------------|-----------------------------|
| WiFi | 2412-2472 MHz | 19.28 dBm |
| | 5180-5320 MHz | 20.88 dBm |
| | 5500-5700 MHz | 19.26 dBm |
| | 5745-5825 MHz | 13.49 dBm |

IYYAMA CORPORATION: Wijkmeerstraat 8, 2131 HA Hoofddorp, The Netherlands

Model No. : PL3260, PL4360U, PL5560U, PL6560U



mark: Equipment protected throughout by Double insulation or Reinforced insulation.



We recommend recycling of used product. Please contact your dealer or iiyama service center. Recycle information is obtained via the Internet, using the address: <https://iiyama.com>

You can access the Web page of different countries from there.

- We reserve the right to change specifications without notice.
- All trademarks used in this user manual are the property of their respective owners.
- Eprel registration number
LH3260HS-B1AG : 1589639, LH4360UHS-B1AG : 1605470, LH5560UHS-B1AG : 1594947,
LH6560UHS-B1AG : 1596053

TABLE OF CONTENTS

| | |
|---|----|
| FOR YOUR SAFETY..... | 1 |
| SAFETY PRECAUTIONS..... | 1 |
| SPECIAL NOTES ON LCD MONITORS | 3 |
| CUSTOMER SERVICE | 5 |
| CLEANING | 5 |
| BEFORE YOU OPERATE THE MONITOR | 6 |
| FEATURES..... | 6 |
| CHECKING THE CONTENTS OF THE PACKAGE | 7 |
| UNPACKING | 7 |
| CONTROLS AND CONNECTORS : MONITOR..... | 8 |
| INSTALLATION | 11 |
| FUNCTIONS OF THE REMOTE CONTROL | 13 |
| PREPARING THE REMOTE CONTROL..... | 14 |
| ID REMOTE CONTROL..... | 15 |
| BASIC OPERATION..... | 16 |
| CONNECTING YOUR MONITOR..... | 19 |
| COMPUTER SETTING | 21 |
| OPERATING THE MONITOR..... | 22 |
| ADJUSTMENT MENU CONTENTS | 24 |
| STANDBY FEATURE | 44 |
| TROUBLE SHOOTING | 45 |
| RECYCLING INFORMATION..... | 46 |
| APPENDIX | 47 |
| SPECIFICATIONS : ProLite LH3260HS-B1AG..... | 47 |
| SPECIFICATIONS : ProLite LH4360UHS-B1AG | 48 |
| SPECIFICATIONS : ProLite LH5560UHS-B1AG | 49 |
| SPECIFICATIONS : ProLite LH6560UHS-B1AG | 50 |
| DIMENSIONS : ProLite LH3260HS..... | 51 |
| DIMENSIONS : ProLite LH4360UHS | 51 |
| DIMENSIONS : ProLite LH5560UHS | 52 |
| DIMENSIONS : ProLite LH6560UHS | 52 |
| COMPLIANT TIMING | 53 |

FOR YOUR SAFETY

SAFETY PRECAUTIONS

WARNING

STOP OPERATING THE MONITOR WHEN YOU SENSE TROUBLE

If you notice any abnormal phenomena such as smoke, strange sounds or fumes, unplug the monitor and contact your dealer or iiyama service center immediately. Further use may be dangerous and can cause fire or electric shock.

NEVER REMOVE THE CABINET

High voltage circuits are inside the monitor. Removing the cabinet may expose you to the danger of fire or electric shock.

DO NOT PUT ANY OBJECT INTO THE MONITOR

Do not put any solid objects or liquids such as water into the monitor. In case of an accident, unplug your monitor immediately and contact your dealer or iiyama service center. Using the monitor with any object inside may cause fire, electric shock or damage.

INSTALL THE MONITOR ON A FLAT, STABLE SURFACE

The monitor may cause an injury if it falls or is dropped.

DO NOT USE THE MONITOR NEAR WATER

Do not use where water may be splashed or spilt onto the monitor as it may cause fire or electric shock.

OPERATE UNDER THE SPECIFIED POWER SUPPLY

Be sure to operate the monitor only with the specified power supply. Use of an incorrect voltage will cause malfunction and may cause fire or electric shock.

PROTECT THE CABLES

Do not pull or bend the power cable and signal cable. Do not place the monitor or any other heavy objects on the cables. If damaged, the cables may cause fire or electric shock.

ADVERSE WEATHER CONDITIONS

It is advisable not to operate the monitor during a heavy thunder storm as the continual breaks in power may cause malfunction. It is also advised not to touch the plug in these circumstances as it may cause electric shock.

CAUTION

INSTALLATION LOCATION

Do not install the monitor where sudden temperature changes may occur, or in humid, dusty or smoky areas as it may cause fire, electric shock or damage. You should also avoid areas where the sun shines directly on the monitor.

DO NOT PLACE THE MONITOR IN A HAZARDOUS POSITION

The monitor may topple and cause injury if not suitably located. Please also ensure that you do not place any heavy objects on the monitor, and that all cables are routed such that children may not pull the cables and possibly cause injury.

MAINTAIN GOOD VENTILATION

Ventilation slots are provided to keep the monitor from overheating. Covering the slots may cause fire. To allow adequate air circulation, place the monitor at least 10 cm (or 4 inches) from any walls. Operating the monitor on its back, side, upside down or on a carpet or any other soft material may also cause damage.

DISCONNECT THE CABLES WHEN YOU MOVE THE MONITOR

When you move the monitor, turn off the power switch, unplug the monitor and be sure the signal cable is disconnected. If you do not disconnect them, it may cause fire or electric shock.

UNPLUG THE MONITOR

If the monitor is not in use for a long period of time it is recommended that it is left unplugged to avoid accidents.

HOLD THE PLUG WHEN DISCONNECTING

To disconnect the power cable or signal cable, always pull it by the plug. Never pull on the cable itself as this may cause fire or electric shock.

DO NOT TOUCH THE PLUG WITH WET HANDS

Pulling or inserting the plug with wet hands may cause electric shock.

WHEN YOU INSTALL THE MONITOR ON YOUR COMPUTER

Be sure the computer is strong enough to hold the weight of the monitor, otherwise, you may damage your computer.

OTHERS

ERGONOMIC RECOMMENDATIONS

To eliminate eye fatigue, do not operate the monitor against a bright background or in a dark room. For optimal viewing comfort, the monitor should be just below eye level and 40-60 cm (16-24 inches) away from your eyes. When using the monitor over a prolonged time, a ten minute break every hour is recommended as looking at the screen continuously can cause eye strain.

SPECIAL NOTES ON LCD MONITORS

- The following symptoms are normal with LCD monitors and do not indicate a problem.

NOTE

- When you first turn on the LCD monitor, the picture may not fit in the display area because of the type of computer that is used. In this case, adjust the picture position to the correct position.
 - You may find slightly uneven brightness on the screen depending on the desktop pattern you use.
 - Due to the nature of the LCD screen, an afterimage of the previous screen may remain after switching the image, when the same image is displayed for hours. In this case, the screen is recovered slowly by changing the image or turning off the Power Switch for hours.
- This LCD cannot be used outdoors.
 - This LCD cannot be used with the screen facing upwards.
 - If you use a cable longer than the supplied one, the picture quality is not guaranteed.

USAGE CONFIRMATION

This product is designed for optimum usage at 24hours per day.
The monitor is compatible for usage in Landscape/Portrait applications.

IMAGE PERSISTENCE / IMAGE STICKING

Please be aware that all LCD screens can experience Image Persistence or Image Sticking. This occurs when a residual image remains visible on a screen when static images are displayed for long periods of time. LCD Image Persistence is not permanent but constant images being displayed for a long period of time should be avoided.

To counteract Image Persistence, turn off the monitor for as long as the previous image was displayed, so if an image was on the monitor for 1 hour and there is evidence of a residual or “ghost” image, you should turn off the monitor for 1 hour in order to clear the residual image.

For all LFD products, iiyama recommends displaying moving images and utilising a moving screen saver at regular intervals whenever the screen is idle. You could also turn off the monitor when not in use to assist the prevention.

Other ways to reduce the risk of Image Persistence will be to utilise the FAN-on function (if available), Low Backlight and Low Brightness settings.

FOR EXTENDED USE AS A PUBLIC MONITOR

■ Image Sticking on LCD Panel

When a static image is displayed for hours, an electric charge trace remains near the electrode inside the LCD producing a “ghost” image. (Image Persistence).

Image Persistence is not a permanent feature.

■ Recommendations

To prevent Image Sticking and promote longer life expectancy of monitor, we recommend the following:

1. Avoid static images displayed for long periods – change static images on continuous loop.
2. Turn off monitor when not in use, either by remote control or use Standby or Schedule functions.
3. Check the Monitor Menu Settings for "Pixel Shift" etc. and activate it when available. This will reduce the Image Sticking Effect.
4. When monitor is installed in high ambient temperature environment(s) or in an enclosed position, utilise the Cooling Fan, Screen Saver and Low Brightness functions.
5. Suitable ventilation for any monitor is an expectation of any installation – climate control systems may need to be employed.
6. We strongly recommend utilisation of active cooling with fans for long operation times or high ambient temperature environments.

CUSTOMER SERVICE

NOTE

- If you have to return your unit for service and the original packaging has been discarded, please contact your dealer or iiyama service center for advice or replacement packaging.

CLEANING

WARNING

- If you drop any materials or liquids such as water into the monitor when cleaning, unplug the power cable immediately and contact your dealer or iiyama service center.

CAUTION

- For safety reasons, turn off the power and unplug the monitor before you clean it.

NOTE

- To protect the LCD panel, do not scratch or rub the screen with a hard object.
- Never use any of the following strong solvents. These will damage the cabinet and the LCD screen.

| | | |
|--------------------|---------|--------------------------|
| Thinner | Benzine | Abrasive cleaner |
| Spray-type cleaner | Wax | Acid or Alkaline solvent |

- Touching the cabinet with any product made from rubber or plastic for a long time may cause degeneration or loss of paint on the cabinet.

CABINET

Stains can be removed with a cloth lightly moistened with a mild detergent solvent. Then wipe the cabinet with a soft dry cloth.

LCD

Periodic cleaning with a soft dry cloth is recommended.

SCREEN

Don't use tissue paper etc. because these will damage the LCD screen.

BEFORE YOU OPERATE THE MONITOR

FEATURES

- ◆ Supports Resolutions up to 1920 × 1080 : ProLite LH3260HS
- ◆ Supports Resolutions up to 3840 × 2160 :
ProLite LH4360UHS / ProLite LH5560UHS / ProLite LH6560UHS
- ◆ High Contrast 4000:1 (Typical) / Brightness 500cd/m² (Typical) :
ProLite LH3260HS / ProLite LH5560UHS
- ◆ High Contrast 5000:1 (Typical) / Brightness 500cd/m² (Typical) :
ProLite LH4360UHS / ProLite LH6560UHS
- ◆ Digital Character Smoothing
- ◆ Automatic Set-up
- ◆ Stereo Speakers
2 × 10W Stereo Speakers
- ◆ Standby Feature
- ◆ VESA Mounting Standard (150mm×200mm) Compliant : ProLite LH3260HS
- ◆ VESA Mounting Standard (400mm×300mm) Compliant : ProLite LH4360UHS
- ◆ VESA Mounting Standard (300mm×400mm) Compliant : ProLite LH5560UHS
- ◆ VESA Mounting Standard (400mm×400mm) Compliant : ProLite LH6560UHS

CHECKING THE CONTENTS OF THE PACKAGE

The following accessories are included in your package. Check to see if they are enclosed with the monitor. If anything is missing or damaged, please contact your local iiyama dealer or regional iiyama office.

- Power Cable*
- Remote Control
- Serial Number Stickers
- HDMI Cable
- Battery (2pcs)
- Safety Guide
- RS-232C Cable
- Wall Mounting Kit
- Quick Start Guide

CAUTION

* The rating of the Power Cable enclosed in 120V area is 10A/125V. If you are using a power supply higher than this rating, then a power cable with a rating of 10A/250V must be used. However, all guarantees and warranties are void for any problems or damage caused by a power cable not supplied by iiyama. An approved power cable greater or equal to H05VVF, 3G, 0.75mm² must be used.

UNPACKING

CAUTION

Moving the monitor requires at least two people. If not, it may drop and could result in a serious injury.

CONTROLS AND CONNECTORS : MONITOR

<Front>

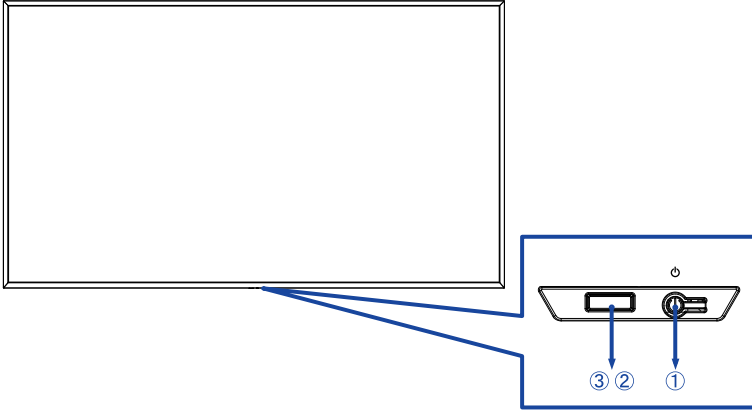

| | | | |
|---|--|---------------|------------------|
| ① | Power Button  | Power Button | |
| ② | Power Indicator | Transparent | Normal Operation |
| | | Red | Standby Mode |
| ③ | Remote Sensor | Remote Sensor | |

ENGLISH

■ ProLite LH3260HS / ProLite LH4360UHS

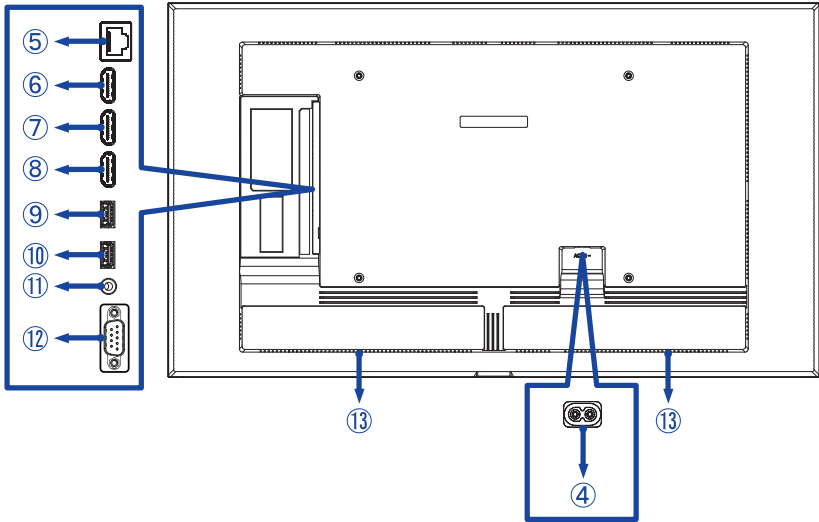

■ ProLite LH5560UHS / ProLite LH6560UHS

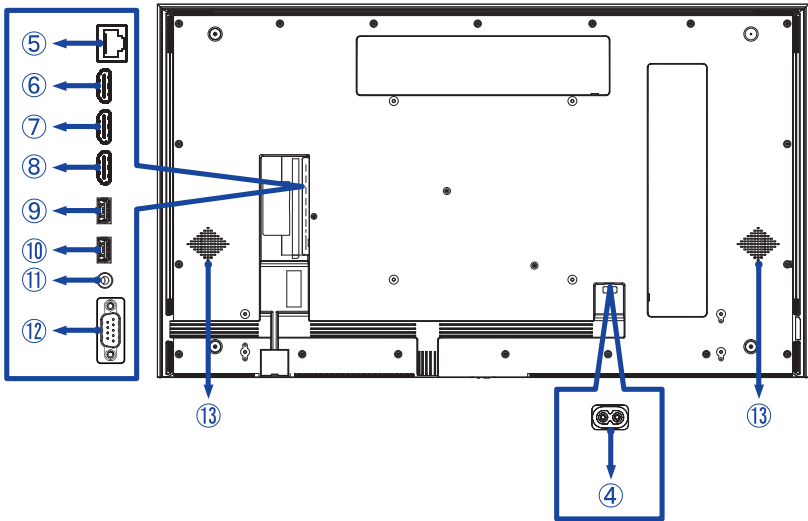

| | | | |
|---|-----------|--------------------|---|
| ④ | AC IN | AC-INLET | AC Connector(~ : Alternating current) (~) (AC-IN) |
| ⑤ | LAN | RJ45 | RJ45 Connector |
| ⑥ | HDMI1 | HDMI | HDMI Connector |
| ⑦ | HDMI2 | HDMI | HDMI Connector |
| ⑧ | HDMI3 | HDMI | HDMI Connector |
| ⑨ | USB | USB2.0 (5V, 500mA) | USB Connector |
| ⑩ | USB | USB2.0 (5V, 500mA) | USB Connector |
| ⑪ | AUDIO OUT | Mini Jack | Audio Connector |
| ⑫ | RS232C | RS232C 9pin | RS232C Connector |
| ⑬ | Speakers | | Speakers |

INSTALLATION

CAUTION

- Follow the manual instructions for the type of mount you have selected. Refer all servicing to qualified service personnel.
- Moving the monitor requires at least two people.
- Before installing, please make sure the wall is strong enough to hold the necessary weight of the monitor and the mount.

[WALL MOUNTING]

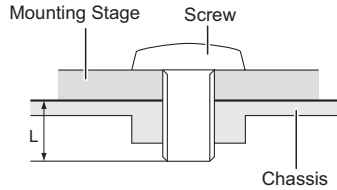

CAUTION

When using the wall mounting, consideration of thickness of the mounting stage needs to be taken. Tighten the M6* Screws (4pcs) which "L" length is 12/18mm* to fasten the monitor. Using a screw longer than this may cause electric shock or damage because it may contact with the electrical parts inside the monitor.

- * M6(L=12mm) : ProLite LH3260HS, Load capacity: max. weight 15kg
- M6(L=18mm) : ProLite LH4360UHS / LH5560UHS / LH6560UHS, Load capacity: max. weight 40kg

[ROTATING THE MONITOR]

This monitor is designed to be compatible in both landscape and portrait modes.

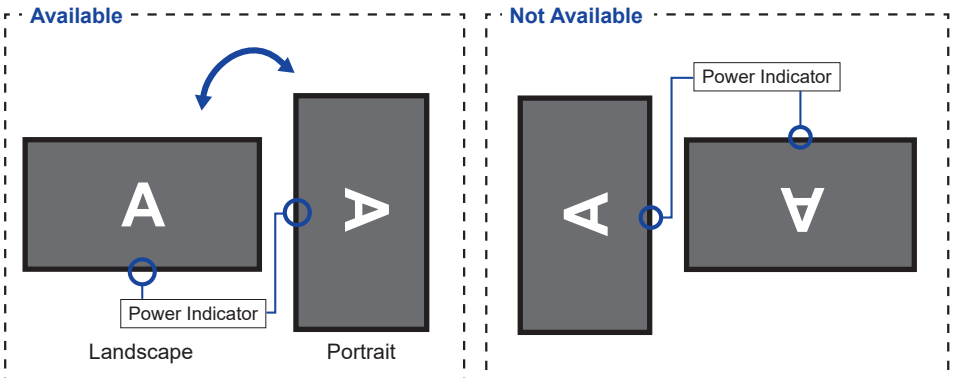

[PLACING THE STICKERS]

If you feel the screw holes are too visible in portrait mode, please use the stickers to cover them.

■ ProLite LH5560UHS

Screw holes : 9



■ ProLite LH6565UHS

Screw holes : 9



FUNCTIONS OF THE REMOTE CONTROL

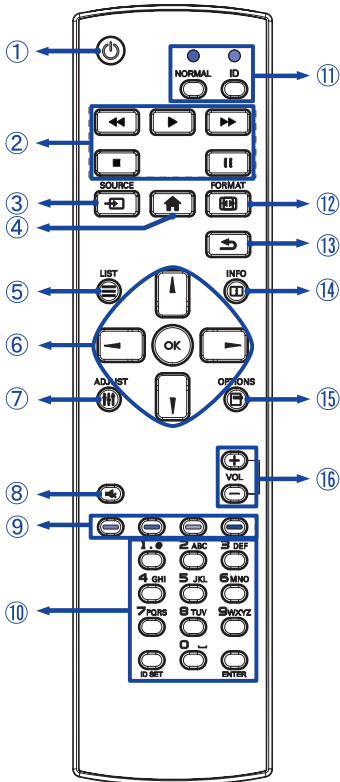

| | | |
|---|-----------------------------|---|
| ① | | Turns the monitor ON and OFF. |
| ② | [PLAY] | Control playback of media files. ▶ : Play ■ : Stop ⏸ : Pause ◀◀ : Quick-Return ▶▶ : Fast-Forward |
| ③ | SOURCE | Selects the source. Press ▲ or ▼ button to select from HDMI1, HDMI2, HDMI3, Browser, CMS, File Manager, Media Player, PDF Player or Custom. Press [OK] button to confirm and exit. |
| ④ | | Opens the display's on-screen menu systems. |
| ⑤ | LIST | Not available on this model. |
| ⑥ | | Navigates through submenus and settings. ▲ : Up Button ▼ : Down Button ◀ : Left Button ▶ : Right Button In Media Player: ◀ : Previous file ▶ : Next file In PDF Player: ◀ : Previous page ▶ : Next page |
| | OK | Confirms your selection or save changes. |
| ⑦ | | Not available on this model. |
| ⑧ | | Turns on or off the mute function. |
| ⑨ | COLOR | Not available on this model. |
| ⑩ | NUMBER/ ID SET/ ENTER | Enter text for network setting or ID setting. |
| ⑪ | ID Mode | ID: To enter ID Mode NORMAL: To leave ID Mode |
| ⑫ | | Change picture format. |
| ⑬ | | Returns to a previous menu or closes the OSD Menu. |
| ⑭ | | Provides source and resolution information. Press the button for 6 seconds to unlock the remote control. |
| ⑮ | | Display edit bar. Only Browser, Media Player and PDF Player inputs. |
| ⑯ | VOLUME - / + | VOLUME- : Decreases the sound volume. VOLUME+ : Increases the sound volume. |

PREPARING THE REMOTE CONTROL

To use the remote control, insert the two dry batteries.

CAUTION

- Do not use any other batteries other than those specified in this manual for the Remote Control.
- Do not insert old and new batteries together in the Remote Control.
- Make sure that the terminals match the "+" and "-" indications in the battery compartment.
- Remove the dead batteries immediately to prevent them from liquid leaking into the battery compartment.
- Burst batteries or the electrolyte from these batteries may cause stains, fire or injury.

- ① Press and then slide the battery cover to open it.

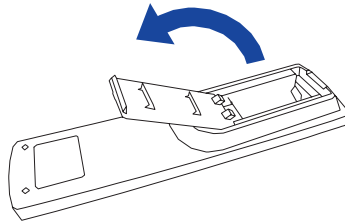

- ② Align and insert two AAA batteries according to their plus and minus ports (as indicated in the remote control).

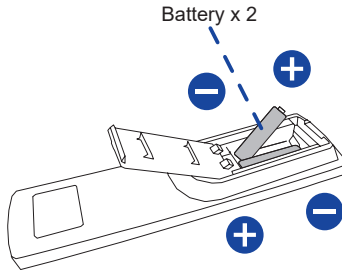

- ③ Replace the battery cover.

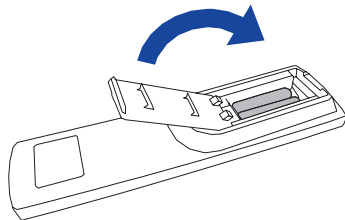

NOTE

- Refer to the above instructions when taking out the batteries.
- Replace with new batteries when the Remote Control does not work close to the monitor. Use AAA dry batteries. Risk of explosion if battery is replaced by an incorrect type.
- Operate the Remote Control by pointing it toward the Remote Sensor on the monitor.
- Other manufacturers remote control will not work with this monitor. Use the provided Remote Control ONLY.
- Used batteries needed to follow the city rule to be discarded. (suggestion: to dispose of used batteries please follow correct policy as per your council regulations)
- Batteries shall not be exposed to excessive heat such as sunshine, fire or the like.
- If you do not intend to use the remote control for a long period, remove the batteries.

ID REMOTE CONTROL

You can set the remote control ID when you want to use the remote control on specific monitors.

ID Mode (To enter ID Mode) : Press and hold the ID button until the red LED blinks twice.

Normal Mode (To leave ID Mode) : Press and hold the Normal button until the green LED blinks twice.

■ Programming ID Mode

To assign an ID to a remote control.

1. Enter ID Mode.
2. Press and hold the ID SET button until the red LED turned on.
3. Using the number button, input the desired ID. (01 - 255)
4. Press the ENTER button to confirm ID.
5. The red LED will blink twice when ID has been confirmed.

NOTE

- Not pressing any button within 10 seconds will exit the ID Mode.
- If an error pressing of buttons other than the digits occurred, wait 1 second after the red LED lights off and then lights up again, then press the correct digits again.
- To cancel or stop programming an ID, press the ID SET button.
- It is necessary to set up the ID number for each monitor before selecting its ID number.

■ Use ID Mode

1. Enter ID Mode.
2. Input the ID of the monitor which would like to control by number button.
3. Press the INPUT button.

BASIC OPERATION

■ Turning the monitor ON

The monitor is turned On and the Power Indicator turns to Transparent when you press the POWER button on the monitor or the Remote Control. The monitor is in standby and the Power Indicator turns to Red when you press the POWER button on the monitor or the Remote Control. Press again to turn On the monitor.

NOTE

Even when using the standby mode, the monitor will consume a small amount of electricity. Disconnect the Power Cable from the power supply whenever the monitor is not in use or during the night, to avoid unnecessary power consumption.

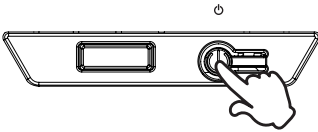

[Monitor]

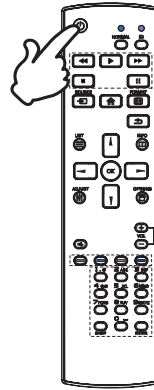

[Remote Control]



■ Display the adjustment menu page

The menu page appears on the screen when you press the  HOME button on the Remote Control. The menu page disappears when you press the  BACK button on the Remote Control again.

[Remote Control]

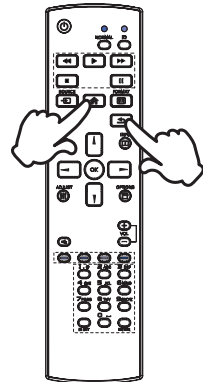

■ **Move the cursor vertically**

Select adjustment by pressing the ▲ / ▼ button on the remote control while the menu page is displayed on the screen.

[Remote Control]

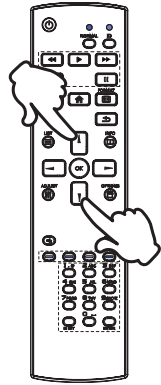

■ **Move the cursor horizontally**

Select menu or setting, or perform the adjustment by pressing the ◀ / ▶ button on the remote control while the menu page is displayed on the screen.

[Remote Control]

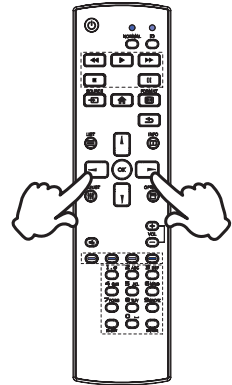

■ Adjust the volume of sound

Press the + / - button on the monitor or the remote control to adjust the volume of sound when the menu page is not displayed on the screen.

[Remote Control]

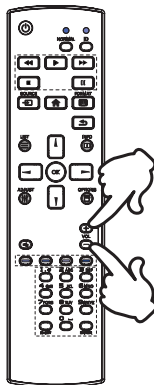

■ Switch the input signal

This is activated when you successively press the SOURCE button on the remote control.

[Remote Control]

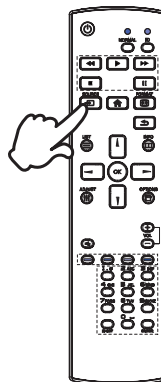

CONNECTING YOUR MONITOR

- ① Ensure that both the computer and the monitor are switched off.
- ② Connect the computer to the monitor with the signal cable.
- ③ Connect the computer with the RS-232C Cable from the monitor.
- ④ Connect the Power Cable to the monitor first and then to the power source.
- ⑤ Turn on your monitor and computer.

NOTE

- Make sure that the building installation has a circuit breaker of 120/240V, 20A (maximum).
- The signal cables used for connecting the computer and monitor may vary with the type of computer used. An incorrect connection may cause serious damage to both the monitor and the computer. The cable supplied with the monitor is for a standard connector. If a special cable is required please contact your local iiyama dealer or regional iiyama office.
- The Class I pluggable equipment Type A must be connected to protective earth.
- The socket-outlet shall be installed near the equipment and shall be easily accessible.
- Excessive sound pressure from ear-/headphones can cause hearing damage/hearing loss.

[Example of Connection]

<Back>

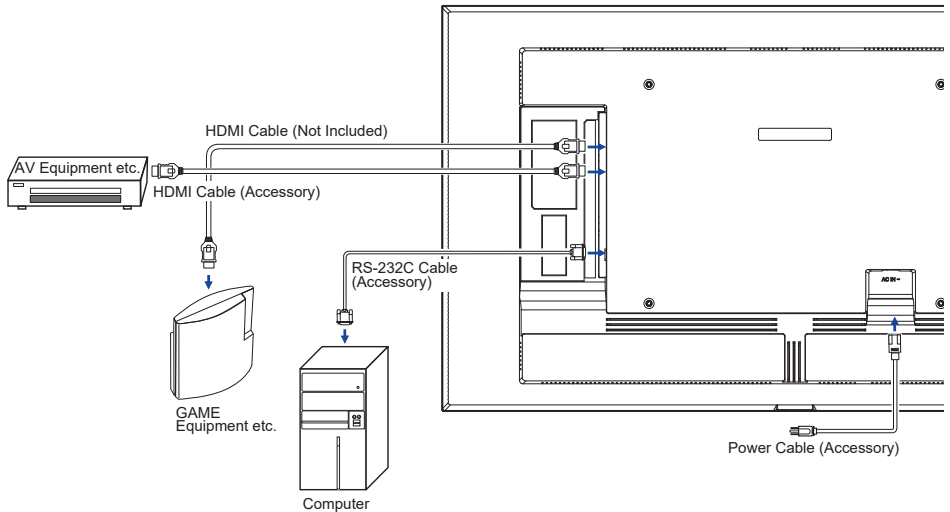

[Connection example with the peripheral device]

CAUTION

Turn off the power and unplug the monitor and peripherals before connection to avoid electric shock or damage.

NOTE

- Refer to the user manual of peripherals at the same time.
- Ensure you have the necessary cables as required.

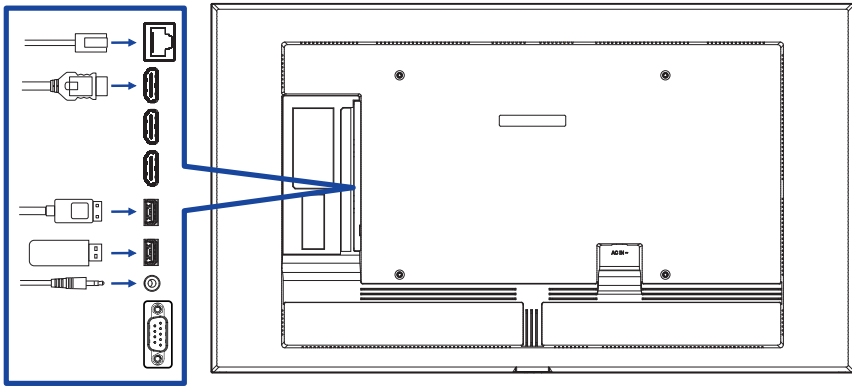

[To setup the network]

1. Switch on the router and switch on its DHCP setting.
2. Connect the router to this monitor with an Ethernet cable.
3. Press  HOME button and 1688 on the remote control, then select Settings.
4. Select "Network & internet", then press OK button.
5. Select "Ethernet", then press OK button.
6. Follow the on-screen instructions to install the network.

NOTE Connecting with a shielded CAT-5 Ethernet cable to comply with the EMC directive.

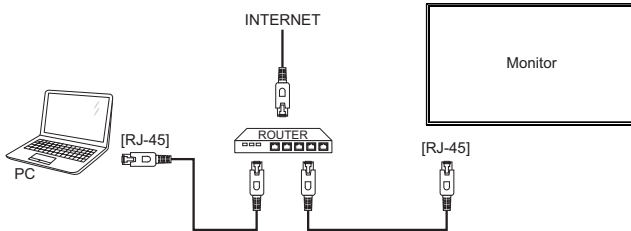

COMPUTER SETTING

■ Signal Timing

Change to the desired signal timing listed on page 53: COMPLIANT TIMING.

OPERATING THE MONITOR

To create the best picture, your iiyama LCD monitor has been preset at the factory with the COMPLIANT TIMING shown on page 53. You are also able to adjust the picture by following the button operation shown below.

- ① Press the **HOME** button on the remote control to start the On Screen Display feature. There are additional Menu items which can be switched by using the **▲/▼/◀/▶** buttons on the remote control.

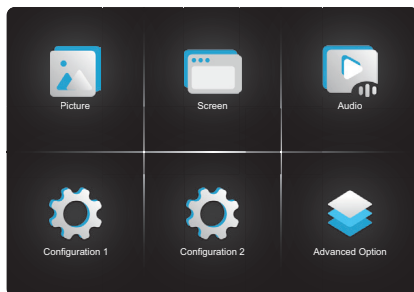

- ② Select the Menu item of the adjustment you want to make. Press the OK button on the remote control to enter the menu page. Then, use the **▲/▼** buttons on the remote control to highlight the desired adjustment item.
- ③ Use the **◀/▶** buttons on the remote control to make the appropriate adjustment or setting.
- ④ Press the **BACK** button on the remote control to leave the menu, and the settings you just made would be automatically saved.

For example, to correct for OSD vertical position, select Menu item of "Configuration2". Press the OK button on the remote control. Then, select "OSD V Position" by using the **▲/▼** buttons on the remote control. Use the **◀/▶** buttons on the remote control to change the OSD vertical position settings. The OSD vertical position of the overall monitor should be changing accordingly while you are doing this.

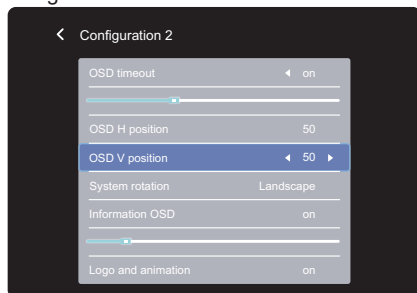

Press the **BACK** button on the remote control, all changes are saved in the memory.

NOTE

- The  BACK button on the remote control can be used to return previous menu item.
- Any changes are automatically saved in the memory when the On Screen Display disappears. Turning off the power should be avoided while using the Menu.

ADJUSTMENT MENU CONTENTS



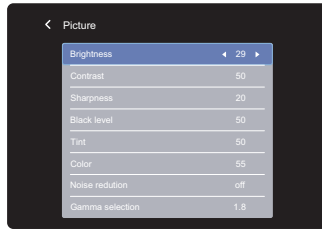

Picture

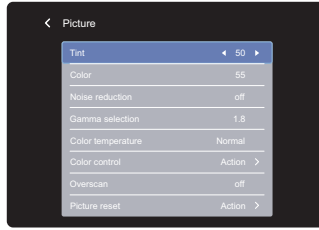

| Adjustment Item | Problem / Option | | Button to Press | |
|-------------------------------|---|---|----------------------------|--|
| Brightness* ¹ | Too dark Too bright | | | |
| Contrast* ² | Too dull Too intense | | | |
| Sharpness* ² | Too soft Too sharp | | | |
| Black level* ² | Black is too dark Black is too bright | | | |
| Tint* ² | Purplish Greenish | | | |
| Color* ² | Too weak Too strong | | | |
| Noise reduction* ² | Off | Noise Reduction is turned off. | | |
| | Low | Electronic image noise caused by different media players is reduced. | | |
| | Middle | Electronic image noise caused by different media players is reduced more than Low. | | |
| | High | Electronic image noise caused by different media players is reduced more than Medium. | | |
| Gamma selection* ² | You can set the Gamma. Native / 2.2 / 2.4 / Sgamma / D-image | | | |
| Color temperature | 3000°K | 9300°K | | |
| | 4000°K | 10000°K | | |
| | 5000°K | Native | Original color temperature | |
| | 6500°K | User1 | User preset 1 | |
| | 7500°K | User2 | User preset 2 | |

Picture



| Adjustment Item | Problem / Option | | Button to Press |
|-----------------------------|------------------|--|--|
| Color control* ³ | Set user color. | | |
| | User1 | R | Too weak Too strong |
| | | G | |
| | | B | |
| User2 | 2000K-10000K | | |
| Overscan* ² | Off | Over scan is turned off. |     |
| | On | Display area about 95%. | |
| Picture reset | Cancel | Return to Menu. | |
| | OK | Picture setting will be restored to factory-preset data. | |

*¹ Adjust the Brightness when you are using the monitor in a dark room and feel the screen is too bright. Brightness adjustment is disabled when Brightness of Panel saving is on.

*² Not available for Media Player, Browser, CMS, PDF Player and Custom inputs.

*³ It can be choose only when Color temperature is set to "User1/User2".

Screen

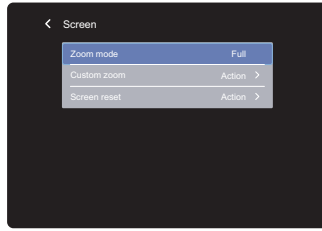

| Adjustment Item | Problem / Option | | Button to Press |
|---------------------------|--------------------------|--|-----------------|
| Zoom mode* ¹ | Full | Enlarge the picture horizontally to fill the screen if the picture source is 4:3 (standard definition). When the picture source is 16:9 (high definition), it is not scaled. | |
| | 4:3 | Display all pictures in 4:3 aspect ratio. | |
| | Real | Display the picture dot by dot. | |
| | 21:9 | Display all pictures in 21:9 aspect ratio. | |
| | Custom | Customize zoom screen. | |
| Custom zoom* ² | Zoom | Zoom the horizontal and vertical size of the image simultaneously. | |
| | H zoom | Zoom the horizontal size of the image. | |
| | V zoom | Zoom the vertical size of the image. | |
| | H position* ³ | Zoom / H Zoom values. | |
| | V position* ³ | Zoom / V Zoom values. | |
| Screen reset | Cancel | Return to Menu. | |
| | OK | Screen setting will be restored to factory-preset data. | |









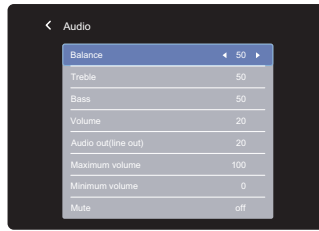





*¹ Not available for Media Player, Browser, CMS, PDF Player and Custom inputs.

*² It can be choose only when Zoom mode is set to "Custom".

*³ When the value of Zoom, H zoom and V zoom is "0", H position and V position cannot be adjusted.

Audio



| Adjustment Item | Problem / Option | | Button to Press |
|----------------------|---|--|---|
| Balance | Left side speaker is louder. Right side speaker is louder. | |   |
| Treble | Too weak | |  |
| | Too strong | |  |
| Bass | Too weak | |  |
| | Too strong | |  |
| Volume | Too soft | |  |
| | Too loud | |  |
| Audio out (line out) | Adjust audio output volume. | |  |
| | Too soft | |  |
| | Too loud | |  |
| Maximum volume | Set the maximum volume. | |   |
| Minimum volume | Set the minimum volume. | |   |
| Mute | Off | Return the sound volume to the previous level. | |
| | On | Turn off the sound temporarily. | |
| Audio out sync | Off | The speaker volume is different from the audio out (line-out) volume. | |
| | On | The speaker volume is consistent with the audio out (line-out) volume. | |
| Speaker Setting | Off | Disable the built-in speaker. | |
| | On | Enable the built-in speaker. | |
| Audio reset | Cancel | Return to Menu. | |
| | OK | Audio setting will be restored to factory-preset data. | |

Configuration1









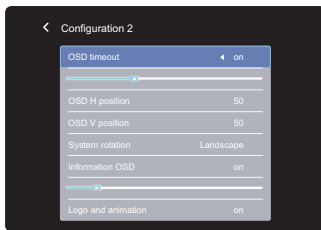

| Adjustment Item | Problem / Option | | |
|------------------------------|---|--|---|
| Switch on state | Forced on | The monitor will turn on when the power cord is connected to a wall outlet. | |
| | Power off | The monitor will remain off when the power cord is connected to a wall outlet. | |
| | Last status | The monitor will return to the previous power status (on/off/standby) when removing and replacing the power cord. | |
| Panel saving | Brightness | Off | Backlight adjustment is off. |
| | | On | The image brightness will be reduced |
| | Pixel shift | For the monitor to slightly shift the position of pixels in four directions (up, down, left or right). | |
| | | Auto | Move the position of the image automatically. |
| | | Off | Pixel shift is turned off. |
| On | Move the position of the image at set intervals. 10 - 900 seconds | | |
| RS232 routing | Select the RS232 control port. RS232 / LAN RS232 | | |
| Boot on source* ¹ | Last input | When the power is turned on, it starts with the same setting as when the power was last turned off. Off / On | |
| | Input | Select input source when boot up. HDMI1 / HDMI2 / HDMI3 / Browser / CMS / File Manager / Media Player / PDF Player / Custom | |
| | Playlist | Select playlist index for Browser, Mediaplayer and PDF player. | |
| WOL | Off | Disable wake on LAN function. | |
| | On | Enable wake on LAN function. | |
| Configuration1 reset | Cancel | Return to Menu. | |
| | OK | Configuration1 setting will be restored to factory-preset data. | |
| Factory reset | Cancel | Return to Menu. | |
| | OK | Factory-preset data is restored. | |

*¹ No failover function, system will keep source even the source is no signal input.

Configuration2



| Adjustment Item | Problem / Option | | Button to Press |
|---------------------------------|--|---|---|
| OSD timeout | You can set the OSD display duration time between 5 and 120 seconds. Off / 5 - 120 seconds | |   |
| OSD H position | OSD is too left | |  |
| | OSD is too right | |  |
| OSD V position | OSD is too low | |  |
| | OSD is too high | |  |
| System rotation | Landscape | Display the OSD in Landscape mode. | |
| | Portrait | Display the OSD in Portrait mode. | |
| Information OSD | Set the period of time the information OSD is displayed on the upper right corner of the screen. Off / 1 - 60 seconds | |   |
| Logo and animation | Off | iiyama Logo and animation does not display when the monitor is turned on. | |
| | On | iiyama Logo and animation display when the monitor is turned on. | |
| | User | Custom logo option in android is set, there will be only custom logo when the monitor is turned on. | |
| Logo setting* ¹ | Select boot logo. | | |
| Animation setting* ¹ | Select boot animation. | | |
| Monitor ID | Set ID to the monitor. 1 - 255 | | |
| Monitor information | Shows information about your monitor, including Model name, Serial No., Operation hours and SW version. | | |
| HDMI version* ² | Set the version of the HDMI. 2.0 / 1.4 / Auto | | |
| Configuration2 reset | Cancel | Return to Menu. | |
| | OK | Configuration2 setting will be restored to factory-preset data. | |

*¹ The Logo setting and Animation setting are only available when you select "User" of Logo and animation function.

*² Suitable for HDMI input only.

Advanced option

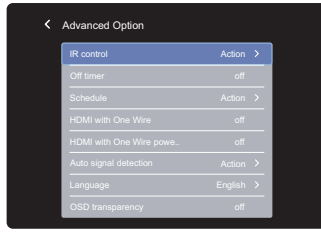

| Adjustment Item | Problem / Option | | Button to Press |
|-----------------|--|---|-----------------|
| IR control | Select the operation mode of the remote control when multiple monitors are connected via an RS232C connection. | | |
| | Unlock* ¹ | Unlock the remote control. | |
| | Lock All | Lock all of the remote control. | |
| | Lock all but Power | Lock all except the power of the remote control. | |
| | Lock all but Volume | Lock all except the volume of the remote control. | |
| | Lock all except PWR & VOL | Lock all except the volume and power of the remote control. | |

Advanced option

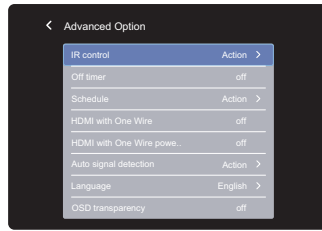

| Adjustment Item | Problem / Option | |
|--------------------------------------|--|--|
| Off Timer | Set when turn off the monitor. Off / 1 - 24 hours | |
| Schedule | Schedule list | Up to 7 schedules can be set. |
| | Start time * ² | Set start time. |
| | End time * ² | Set end time. |
| | Input | Select default input source to use when the monitor is automatically turned on next time. HDMI1 / HDMI2 / HDMI3 / Browser / CMS / File Manager / Media Player / PDF Player / Custom |
| | Playlist | Choose playlist for the mediaplayer, PDF player and browser. |
| | Days of the week | Set the day of the week. SUN / MON / TUE / WED / THU / FRI / SAT |
| | Every week | Set whether to repeat every week. Off / On |
| | Enable* ³ | Enable / disable schedule. |
| HDMI with One Wire | Off | HDMI with One Wire is turned off. |
| | On | Control all devices connected by HDMI cable with one remote control. |
| HDMI with One Wire Power Off | Off | HDMI with One Wire Power Off is turned off. |
| | On | Use the power button on the device connected with the HDMI cable to switch to standby mode. |
| Auto signal detection * ⁴ | Off | Disable the Auto signal detection. |
| | All * ⁵ | Detects all sources automatically if there is no signal on the default input and selects the available signal automatically. |
| | Failover | Detects sources automatically with user-defined order if there is no signal on the default input and selects the available signal automatically. |

*¹ To unlock, press and hold the INFO button on the remote control for 6 seconds.

*² The start time in the Schedule must be less than the end time.

*³ Adjustments to "Enable" should be made only after Start time, End time, Input and week have been correctly set.



*⁴ The display detects and select available signal source automatically.

*⁵ Order of detection: HDMI1 → HDMI2 → HDMI3 → Browser → CMS → File Manager → Media Player → PDF Player → Custom

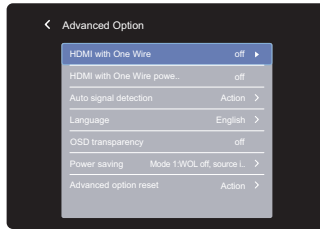
Advanced option



ENGLISH

| Adjustment Item | Problem / Option | | | Button to Press |
|-----------------------|--|---|--------------|--|
| Language | English | English | Deutsch | German |
| | Français | French | Italiano | Italian |
| | Español | Spanish | Русский | Russian |
| | Polski | Polish | Nederlands | Dutch |
| | Dansk | Danish | Svenska | Swedish |
| | Suomi | Finnish | Norsk bokmål | Norwegian |
| | Čeština | Czech | | |
| OSD Transparency | The background of OSD is made transparent. Off / 5 - 100 | | |   |
| Power saving | Mode1: WOL off, source input wake-up off, Backlight off Mode2: WOL off, source input wake-up on, Backlight off Mode3: WOL on, source input wake-up off, Backlight off Mode4: WOL on, source input wake-up on, Backlight off | | | |
| Advanced option reset | Cancel | Return to Menu. | | |
| | OK | Advanced option setting will be restored except "Date and Time" in the Advanced option menu to factory-preset data. | | |

APPLICATION

Press the  HOME button and number 1668 on the remote control.

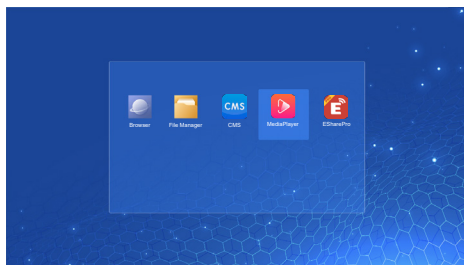
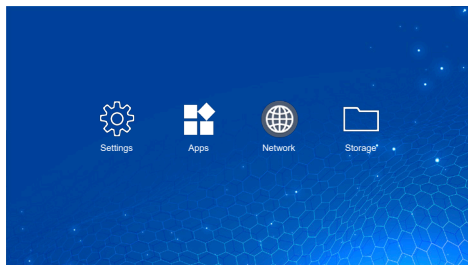

<Settings>

Network & internet



| Adjustment Item | Problem / Option | | |
|----------------------------|--|---|--|
| Wi-Fi | Set the wifi function Enable / disable and pairing to WiFi device. | | |
| | Wifi list | Display a list of WiFi networks | |
| | Add network | Network name | |
| | | Security | |
| | | Advanced options | |
| | Wifi preferences | Turn on wifi automatically | |
| Notify for public networks | | | |
| Advanced | | | |
| Saved networks | Save wifi networks on this monitor. | | |
| Ethernet | Set the wired network. On / Off | | |
| | IP address | Assign IP address for this monitor. | |
| | Netmask | Assign Netmask for this monitor. | |
| | Gateway | Assign Gateway for this monitor. | |
| | DNS1 | Assign DNS server address. | |
| | DNS2 | | |
| | Ethernet IP mode | Static | |
| DHCP | | | |
| Hotspot | Wifi hotspot | Set the Hotspot function. Disable / Enable (Hotspot name / security / hotspot password / AP Band / Turn off hotspot automatically) | |

Apps & Notification

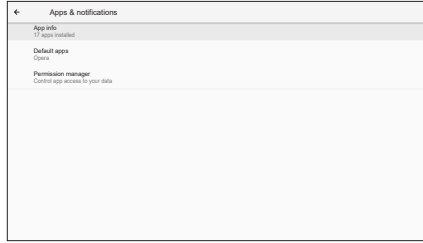

| Adjustment Item | Problem / Option | |
|--------------------|---------------------------|-----------------------|
| App info | Display all applications. | |
| Default apps | Browser app | Set the default apps. |
| | Home app | |
| | Opening links | |
| Permission manager | App permissions | Set app permissions. |

Display

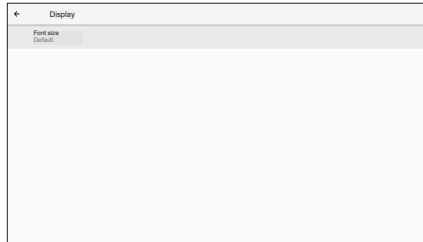

| Adjustment Item | Problem / Option | |
|-----------------|------------------|--------------------|
| Font size | Small | Set the font size. |
| | Default | |
| | Large | |
| | Largest | |

Signage display

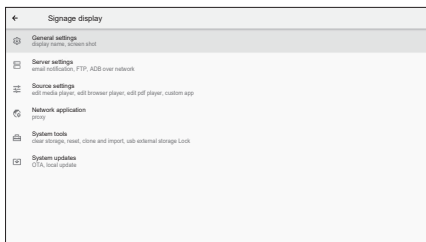

| Adjustment Item | Problem / Option | | | |
|---------------------|---------------------------|---|--|--|
| General settings | Signage display name | Set the monitor name. | | |
| | Screenshot | Disable / Enable(Interval, Start time, End time, Repeat, Save to, Purge Screenshots, Send screenshots via email) | | |
| Server settings | Email Notification | Disable / Enable(SMTP, Manager Email, Test) | | |
| | FTP | Disable / Enable(Account, Password, Storage Path, Port) | | |
| | ADB over network | Access network connection with port 5555. | | |
| Source settings | Edit Media Player | Edit Media Player playlist and effect settings. | | |
| | Edit Browser Player | Edit Browser list and effect settings. | | |
| | Edit PDF Player | Edit PDF Player playlist and effect settings. | | |
| | Storage path | Set the Media player, PDF player, Browser storage location. | | |
| | Custom app | Edit the Custom app. | | |
| Network application | Proxy | Set the proxy server. Disable / Enable (Hostname: Proxy server IP Adress, Port: Proxy server port number, Type: Proxy server type) Authentication / Username / Password | | |
| System tools | Clear Storage | Clear all data in signage folders. All / Internal storage / USB storage | | |
| | Reset | Erase all data | Factory-preset data is restored. | |
| | Clone and Import | Clone | Copy the media file from internal, USB. | |
| | | Import | Import from signage folder under USB. Internal storage | |
| | USB external storage Lock | Disable | USB External Storage unlock. | |
| Enable | | USB External Storage lock. | | |
| System updates | OTA | Firmware update. | | |
| | Local update | | | |

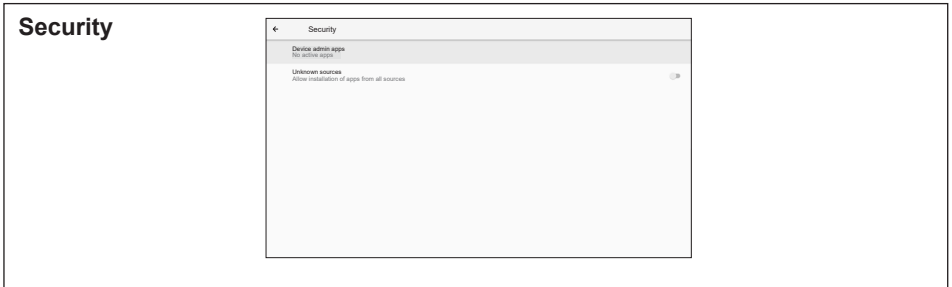

| Adjustment Item | Problem / Option |
|-------------------|---|
| Device admin apps | Display credential storage information. |
| Unknown sources | Disable / Enable installation of apps from unknown sources. |

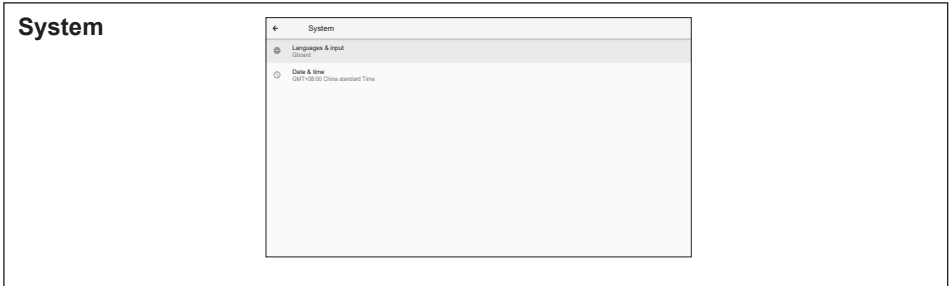

| Adjustment Item | Problem / Option | |
|------------------|---------------------------|--|
| Language & Input | Languages | Set display language, keyboard and input method. Language: English / Deutsch / Français / Italiano / Español / Русский / Polski / Nederlands / Český / Dansk / Svenska / Suomi / Norsk bokmål |
| | On-screen keyboard | |
| | Physical keyboard | |
| Date & time | Use network-provided time | Set the Date and Time. Use 24-Hour Format, Automatic Date & Time, Date Format, Timezone. |
| | Ntp server | |

About device

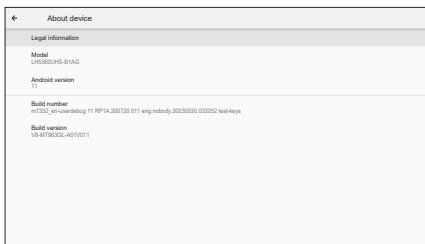

| Adjustment Item | Problem / Option | |
|-------------------|-------------------------|--|
| Legal information | Third-party licenses | Main info in About: Legal / Model / Android version / Build number / Build version Automatically search update .zip from USB. When you select the updated .zip file, the monitor will restart and the update will start. |
| | System Webview licenses | |
| Model | Model | |
| | Serial number | |
| | Hardware version | |
| Android version | Android version | |
| | Android security update | |
| | Kernel version | |
| | Build number | |
| Build number | | |
| Build version | | |

■ Quick Info

Press the Info button and number 77 on the remote control.
Display the Network and Monitor etc. information.

<Android> * Android upgrade is not available on this model.

- Settings : Go to settings app.
- Apps : Show all apps. (Browser/File Manager/CMS/Media Player/ESharePro)
- Network : Set Ethernet.
- Storage : Display current Android storage information.

NOTE

- Supported file system:
 - FAT32
- Supported file format:
 - Music: MP3, M4A, AAC, LPCM
 - Video: 3GP, AVI, FLV, MP4, MKV, MOV, MPEG, MTS, TP, TS, VOB, WEBM
 - Photo: JPG, JPEG, BMP, PNG, GIF

[Media Player]

- Play file: Select the file to play
- Play order: Set the play order of the files
- Play mode: Set the playback mode
- Picture style: Set the picture size
- Create list: Create a new playlist
- Play list: Edit playlist

● Play file

1. Select "Play file" on the page.
2. Select the file and press OK button.
Multiple files can be selected.
3. Press the "Open" button to play.

■ Media Hotkey

- ► **Play:** To play the media file.
- || **Pause:** To pause the media file.
- ►► **Fast forward:** To skip forward 10 seconds.
- ◀◀ **Rewind:** To skip backward 10 seconds.
- ■ **Stop:** To stop the playing file and return to Menu.

■ Arrow key

- ◀ : Previous file
- ▶ : Next file

● Play order

Select "Play order" on the page.

- **Sequences:** Play files in sequences.
- **Reverse:** Play files in reverse.
- **Random:** All files in the list play randomly.
- **Cycle:** All files in the list play repeatedly.

● Play mode

Select "Play mode" on the page.

- **Auto:** Autoplay duration(s). 5s / 15s / 30s / 60s
- **Manual:** Play the file manually.





● Picture style

Select "Picture style" on the page.





- **Scale:** Display the image in its original aspect ratio.
- **Full:** Enlarge the image to full screen

● Create list

1. Select "Create list" on the page.
2. Select "Add file".
3. Select the file and add to the list.

- Edit bar
 - **Move up:** Move the files to the top of the list.
 - **Move down:** Move the files to the bottom of the list.
 - **Delete:** Delete files.
 - **Delete all:** Delete all playlist files.
 - **Back:** Return.
- Remote control
 -  **Option key:** Display edit bar
 -  **OK key:** Select / deselect file
- **Play list**
 1. Select "Play list" on the page.
 2. Press the  Option button on the remote control to open the edit bar.
 3. Add the file or edit the file.
- Edit bar
 - **Move up:** Move the files to the top of the list.
 - **Move down:** Move the files to the bottom of the list.
 - **Delete:** Delete files.
 - **Delete all:** Delete all playlist files.
 - **Back:** Return.
- Remote control
 -  **Option key:** Display edit bar
 -  **OK key:** Select / deselect file

[Browser]

- **New tab**
 1. Select "New tab" on the page.
 2. Enter URL and press OK to access.
- **Create list**
 1. Select "Create list" on the page.
 2. Enter URL and add to the list.
- **Play list**
 1. Select URL on the page.
 2. Press the  Option button on the remote control to open the edit bar.
 3. Edit URL
- Edit bar
 - **Delete:** Delete a URL.
 - **Delete all:** Delete all URL record.
 - **Back:** Return.
- Remote control
 -  **Option key:** Display edit bar
 -  **Play key:** Open the web page
 -  **OK key:** Select / deselect

[PDF Player]

● Play file

1. Select "Play file" on the page.
2. Select the file and press OK button.
Multiple files can be selected.
3. Press the "Open" button to play.

■ Media Hotkey

- **▶ Play:** To play the PDF file.
- **⏸ Pause:** To pause the PDF file.
- **■ Stop:** Return.

■ Arrow key

- **◀** : Previous page
- **▶** : Next page

● Play order

Select "Play order" on the page.

- **Sequences:** Play files in sequences.
- **Reverse:** Play files in reverse.
- **Random:** All files in the list play randomly.
- **Cycle:** All files in the list play repeatedly.

● Play mode

Select "Play mode" on the page.

- **Auto:** Autoplay duration(s). 5s / 15s / 30s / 60s
- **Manual:** Adjust the file manually.



● Create list

1. Select "Create list" on the page.
2. Select "Add file".
3. Select the file and add to the list.

■ Edit bar



- **Move up:** Move the files to the top of the list.
- **Move down:** Move the files to the bottom of the list.
- **Delete:** Delete files.
- **Delete all:** Delete all playlist files.
- **Back:** Return.

■ Remote control

-  **Option key:** Display edit bar
-  **OK key:** Select / deselect file

● Play list

1. Select "Play list" on the page.
2. Press the  Option button on the remote control to open the edit bar.
3. Add the file or edit the file.

- Edit bar
 - **Move up:** Move the files to the top of the list.
 - **Move down:** Move the files to the bottom of the list.
 - **Delete:** Delete files.
 - **Delete all:** Delete all playlist files.
 - **Back:** Return.
- Remote control
 -  **Option key:** Display edit bar
 -  **OK key:** Select / deselect file

[File Manager]

Browse the files stored in the internal storage, USB.

[CMS]

Manage the digital signage content.

To be able to use the functionality , please download the CMS Software and User Manual from our Website <https://iiyama.com/iisignage>

CMS software is using the network Port: 9989 , future information are available in the iiSignage User Manual

[EShare Pro]

EShare is a multiscreen interaction application which makes the user experience natural and enjoyable for home entertainment, business presentation, and educational training.

STANDBY FEATURE

This product features the standby function. When activated, it automatically reduces unnecessary power consumption of the monitor when your computer is not in use.

There is a standby step the monitor takes as described below. The standby function, including any timer settings is configured by the operating system. Check your operating system manual for information on how this can be configured.

■ Standby Mode

When the video signal from the computer is off, the monitor enters into Standby Mode which reduces the power consumption to less than 0.5W*. The screen becomes dark, and the power indicator turns to red. From Standby Mode, the image reappears in several seconds when the source input reconnected.

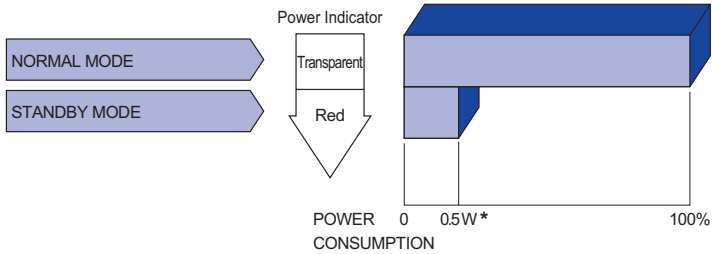

* When the USB devices are not connected.

TROUBLE SHOOTING

If the monitor fails to operate correctly, please follow the steps below for a possible solution.

1. Perform the adjustments described in OPERATING THE MONITOR, depending on the problem you have. If the monitor does not get a picture, skip to 2.
2. Consult the following items if you cannot find an appropriate adjustment item in OPERATING THE MONITOR or if the problem persists.
3. If you are experiencing a problem which is not described below or you cannot correct the problem, discontinue using the monitor and contact your dealer or iiyama service center for further assistance.

| Problem | Check |
|---|--|
| <p>① The picture does not appear. (Power indicator does not turn off.)</p> <p>(Power indicator is red.)</p> | <p><input type="checkbox"/> The Power Cable is firmly seated in the socket.</p> <p><input type="checkbox"/> The Power is turned ON.</p> <p><input type="checkbox"/> The AC socket is live. Please check with another piece of equipment.</p> <p><input type="checkbox"/> If the monitor is in standby mode, touch the keyboard or the mouse.</p> <p><input type="checkbox"/> The computer is ON.</p> <p><input type="checkbox"/> The Signal Cable is properly connected.</p> <p><input type="checkbox"/> The signal timing of the computer is within the specification of the monitor.</p> |
| <p>② The screen is not synchronized.</p> | <p><input type="checkbox"/> The Signal Cable is properly connected.</p> <p><input type="checkbox"/> The signal timing of the computer is within the specification of the monitor.</p> |
| <p>③ The screen position is not in the center.</p> | <p><input type="checkbox"/> The signal timing of the computer is within the specification of the monitor.</p> |
| <p>④ The screen is too bright or too dark.</p> | <p><input type="checkbox"/> The video output level of the computer is within the specification of the monitor.</p> |
| <p>⑤ The screen is shaking.</p> | <p><input type="checkbox"/> The power voltage is within the specification of the monitor.</p> <p><input type="checkbox"/> The signal timing of the computer is within the specification of the monitor.</p> |
| <p>⑥ No sound.</p> | <p><input type="checkbox"/> The audio equipment (computer etc.) is ON.</p> <p><input type="checkbox"/> The Audio Cable is properly connected.</p> <p><input type="checkbox"/> The Volume is turned up.</p> <p><input type="checkbox"/> The Mute is OFF.</p> <p><input type="checkbox"/> The audio output level of the audio equipment is within the specification of the monitor.</p> |
| <p>⑦ The sound is too loud or too quiet.</p> | <p><input type="checkbox"/> The audio output level of the audio equipment is within the specification of the monitor.</p> |
| <p>⑧ A strange noise is heard.</p> | <p><input type="checkbox"/> The Audio Cable is properly connected.</p> |

RECYCLING INFORMATION

For better environment protection please don't dispose your monitor.
Please visit our web site: <https://iiyama.com> for monitor recycling.

APPENDIX

Design and specifications are subject to change without prior notice.

SPECIFICATIONS : ProLite LH3260HS-B1AG

| | | |
|------------------------------|--|--|
| Size Category | 32" | |
| LCD Panel | Panel technology | VA (Vertical Alignment) |
| | Size | Diagonal: 31.5" (80cm) |
| | Pixel pitch | 0.12125mm H × 0.36375mm V |
| | Brightness | 500/m ² (Typical), 480cd/m ² (Default / Energy Saving) |
| | Contrast ratio | 4000 : 1 (Typical) |
| | Viewable angle | Horizontal : 178 degrees, Vertical: 178 degrees (Typical) |
| Response time | 8ms (Typical, Gray to Gray) | |
| Surface Treatment | Anti-Glare, Haze 25%, Hard Coating(3H) | |
| Display Colors | 8bit (Approx.16.7M) | |
| Sync Frequency | Horizontal: 28.0-160.0kHz, Vertical: 23-85Hz | |
| Native Resolution | 1920 × 1080, 2.1 MegaPixels | |
| Support Max. Resolution | 1920 × 1080 60Hz | |
| Input Connector | HDMI × 3 | |
| Input Audio Connector | ø 3.5mm mini jack (Stereo) | |
| LAN | RJ45 | |
| Serial Port | RS-232C In ø 2.5mm sub-mini jack | |
| Input Video Signal | Digital: HDMI | |
| Input Audio Signal | 0.5Vrms maximum | |
| USB Connector | USB2.0(DC5V, 500mA) (USB Media Player) × 2 | |
| Headphone Connector | ø 3.5mm mini jack (Stereo) | |
| Speakers | Internal: 10W×2 (Stereo speakers) | |
| Maximum Screen Size | 698.40mm W × 392.85mm H / 27.5" W × 15.5" H | |
| Power Source | 100-240VAC, 50-60Hz, 1.0A | |
| Power Consumption* | 40W typical, Standby mode: 0.5W maximum | |
| Dimensions / Net Weight | 724.5 × 420.0 × 40.0mm / 28.5 × 16.5 × 1.5" (W×H×D) 5.4kg / 11.9lbs | |
| Environmental Considerations | Operating: | Temperature 0 to 40°C / 32 to 104°F Humidity 20 to 80% (No condensation) |
| | Storage: | Temperature -20 to 60°C / 4 to 140°F Humidity 10 to 90% (No condensation) |
| Approvals | CE, UKCA, EAC, TÜV-Bauart | |

NOTE * When the USB devices are not connected.

SPECIFICATIONS : ProLite LH4360UHS-B1AG

| | | |
|------------------------------|--|--|
| Size Category | 43" | |
| LCD Panel | Panel technology | VA (Vertical Alignment) |
| | Size | Diagonal: 42.5" (108cm) |
| | Pixel pitch | 0.0871mm H × 0.2451mm V |
| | Brightness | 500cd/m ² (Typical), 470cd/m ² (Default / Energy Saving) |
| | Contrast ratio | 5000 : 1 (Typical) |
| | Viewable angle | Horizontal : 178 degrees, Vertical: 178 degrees (Typical) |
| | Response time | 8.5ms (Typical, Gray to Gray) |
| Surface Treatment | Anti-Glare, Haze 25%, Hard Coating(3H) | |
| Display Colors | Approx.1.07G | |
| Sync Frequency | Horizontal: 28.0-160.0kHz, Vertical: 23-85Hz | |
| Native Resolution | 3840 × 2160, 8.3 MegaPixels | |
| Support Max. Resolution | 3840 × 2160 60Hz | |
| Input Connector | HDMI × 3 | |
| Input Audio Connector | ø 3.5mm mini jack (Stereo) | |
| LAN | RJ45 | |
| Serial Port | RS-232C In ø 2.5mm sub-mini jack | |
| Input Video Signal | Digital: HDMI | |
| Input Audio Signal | 0.5Vrms maximum | |
| USB Connector | USB2.0(DC5V, 500mA) (USB Media Player) × 2 | |
| Headphone Connector | ø 3.5mm mini jack (Stereo) | |
| Speakers | Internal: 10W×2 (Stereo speakers) | |
| Maximum Screen Size | 941.184mm W × 529.416mm H / 37.1" W × 20.8" H | |
| Power Source | 100-240VAC, 50-60Hz, 1.5A | |
| Power Consumption* | 73W typical, Standby mode: 0.5W maximum | |
| Dimensions / Net Weight | 967.5 × 556.0 × 40.0mm / 38.0 × 21.8 × 1.5" (W×H×D) 9.1kg / 20.0lbs | |
| Environmental Considerations | Operating: | Temperature 0 to 40°C / 32 to 104°F Humidity 20 to 80% (No condensation) |
| | Storage: | Temperature -20 to 60°C / 4 to 140°F Humidity 10 to 90% (No condensation) |
| Approvals | CE, UKCA, EAC, TÜV-Bauart | |

NOTE * When the USB devices are not connected.

SPECIFICATIONS : ProLite LH5560UHS-B1AG

| | | |
|------------------------------|---|--|
| Size Category | 55" | |
| LCD Panel | Panel technology | VA (Vertical Alignment) |
| | Size | Diagonal: 54.6" (139cm) |
| | Pixel pitch | 0.105mm H × 0.315mm V |
| | Brightness | 500cd/m ² (Typical), 415cd/m ² (Default / Energy Saving) |
| | Contrast ratio | 4000 : 1 (Typical) |
| | Viewable angle | Horizontal : 178 degrees, Vertical: 178 degrees (Typical) |
| | Response time | 6.5ms (Typical, Gray to Gray) |
| Surface Treatment | Anti-Glare, Haze 25%, Hard Coating(3H) | |
| Display Colors | Approx.1.07G | |
| Sync Frequency | Horizontal: 28.0-160.0kHz, Vertical: 23-85Hz | |
| Native Resolution | 3840 × 2160, 8.3 MegaPixels | |
| Support Max. Resolution | 3840 × 2160 60Hz | |
| Input Connector | HDMI × 3 | |
| Input Audio Connector | ø 3.5mm mini jack (Stereo) | |
| LAN | RJ45 | |
| Serial Port | RS-232C In ø 2.5mm sub-mini jack | |
| Input Video Signal | Digital: HDMI | |
| Input Audio Signal | 0.5Vrms maximum | |
| USB Connector | USB2.0(DC5V, 500mA) (USB Media Player) × 2 | |
| Headphone Connector | ø 3.5mm mini jack (Stereo) | |
| Speakers | Internal: 10W×2 (Stereo speakers) | |
| Maximum Screen Size | 1209.6mm W × 680.4mm H / 47.6" W × 26.8" H | |
| Power Source | 100-240VAC, 50-60Hz, 1.8A | |
| Power Consumption* | 89W typical, Standby mode: 0.5W maximum | |
| Dimensions / Net Weight | 1240.0 × 712.5 × 38.5mm / 48.8 × 28.0 × 1.5" (W×H×D) 17.6kg / 38.8lbs | |
| Environmental Considerations | Operating: Temperature 0 to 40°C / 32 to 104°F Humidity 20 to 80% (No condensation) Storage: Temperature -20 to 60°C / 4 to 140°F Humidity 10 to 90% (No condensation) | |
| Approvals | CE, UKCA, EAC, TÜV-Bauart | |

NOTE * When the USB devices are not connected.

SPECIFICATIONS : ProLite LH6560UHS-B1AG

| | | |
|------------------------------|--|--|
| Size Category | 65" | |
| LCD Panel | Panel technology | VA (Vertical Alignment) |
| | Size | Diagonal: 64.5" (164cm) |
| | Pixel pitch | 0.124mm H × 0.372mm V |
| | Brightness | 500cd/m ² (Typical), 365cd/m ² (Default / Energy Saving) |
| | Contrast ratio | 5000 : 1 (Typical) |
| | Viewable angle | Horizontal : 178 degrees, Vertical: 178 degrees (Typical) |
| | Response time | 6.5ms (Typical, Gray to Gray) |
| Surface Treatment | Anti-Glare, Haze 25%, Hard Coating(3H) | |
| Display Colors | Approx.1.07G | |
| Sync Frequency | Horizontal: 28.0-160.0kHz, Vertical: 23-85Hz | |
| Native Resolution | 3840 × 2160, 8.3 MegaPixels | |
| Support Max. Resolution | 3840 × 2160 60Hz | |
| Input Connector | HDMI × 3 | |
| Input Audio Connector | ø 3.5mm mini jack (Stereo) | |
| LAN | RJ45 | |
| Serial Port | RS-232C In ø 2.5mm sub-mini jack | |
| Input Video Signal | Digital: HDMI | |
| Input Audio Signal | 0.5Vrms maximum | |
| USB Connector | USB2.0(DC5V, 500mA) (USB Media Player) × 2 | |
| Headphone Connector | ø 3.5mm mini jack (Stereo) | |
| Speakers | Internal: 10W×2 (Stereo speakers) | |
| Maximum Screen Size | 1428.48mm W × 803.52mm H / 56.2" W × 31.6" H | |
| Power Source | 100-240VAC, 50-60Hz, 2.0A | |
| Power Consumption* | 100W typical, Standby mode: 0.5W maximum | |
| Dimensions / Net Weight | 1459.0 × 837.0 × 39.0mm / 57.4 × 32.9 × 1.5" (W×H×D) 25.3kg / 55.8lbs | |
| Environmental Considerations | Operating: | Temperature 0 to 40°C / 32 to 104°F Humidity 20 to 80% (No condensation) |
| | Storage: | Temperature -20 to 60°C / 4 to 140°F Humidity 10 to 90% (No condensation) |
| Approvals | CE, UKCA, EAC, TÜV-Bauart | |

NOTE * When the USB devices are not connected.

DIMENSIONS : ProLite LH3260HS

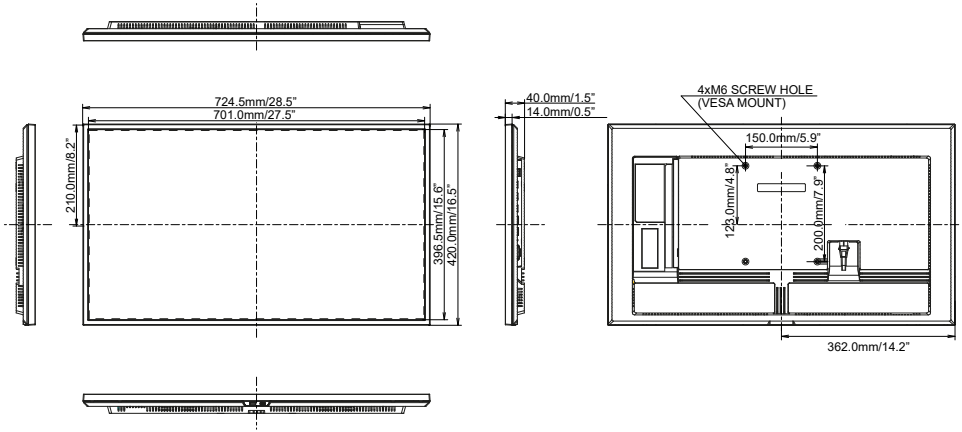

ENGLISH

DIMENSIONS : ProLite LH4360UHS

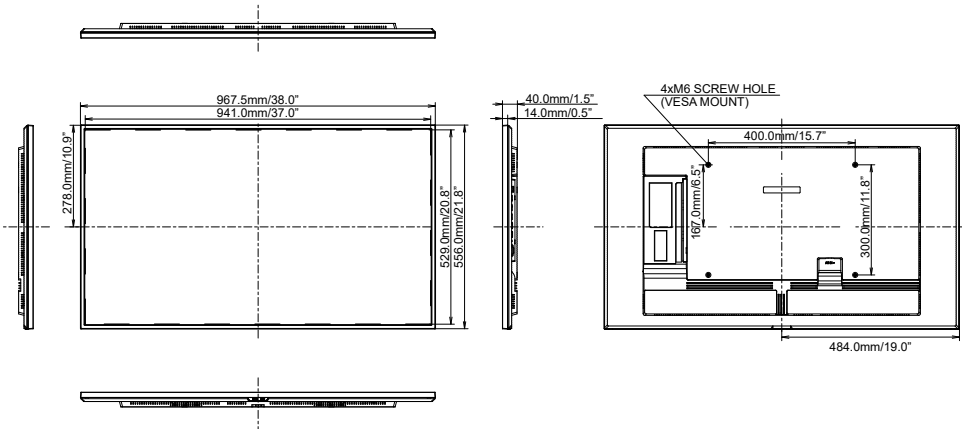

DIMENSIONS : ProLite LH560UHS

ENGLISH

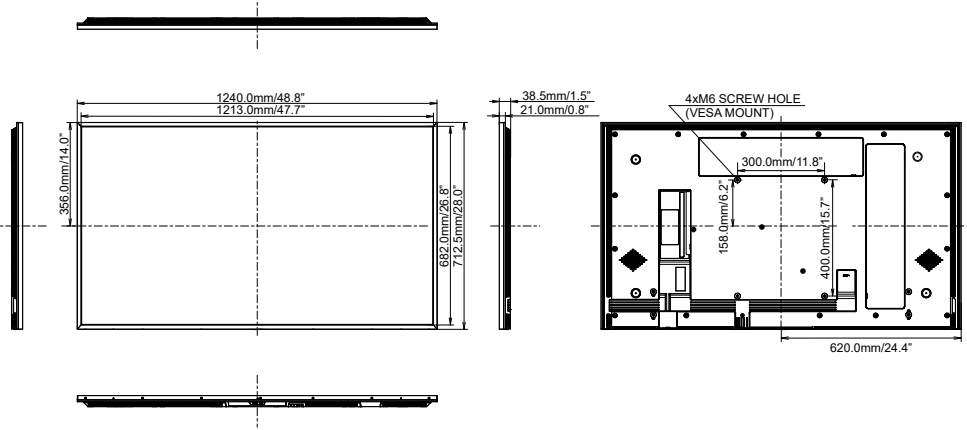

DIMENSIONS : ProLite LH6560UHS

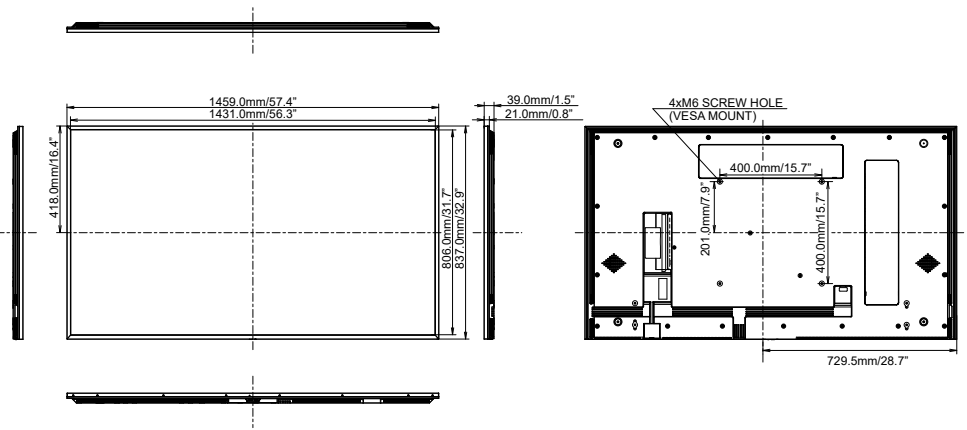

COMPLIANT TIMING

| Timing | | fH (kHz) | V (Hz) | Dot clock (MHz) | HDMI1 | HDMI2 | HDMI3 |
|--------------|----------------|----------|--------|-----------------|---------|-------|-------|
| VESA | VGA 640x480 | 31.5 | 60.0 | 25.175 | ○ | ○ | ○ |
| | SVGA 800x600 | 37.9 | 60.0 | 40.000 | ○ | ○ | ○ |
| | XGA 1024x768 | 48.4 | 60.0 | 65.000 | ○ | ○ | ○ |
| | QVGA 1280x960 | 64.0 | 60.0 | 108.000 | ○ | ○ | ○ |
| | SXGA 1280x1024 | 64.0 | 60.0 | 108.000 | ○ | ○ | ○ |
| | CVT 1400x900 | 55.9 | 60.0 | 106.500 | ○ | ○ | ○ |
| | UXGA 1680x1050 | 65.3 | 60.0 | 146.250 | ○ | ○ | ○ |
| | FHD 1920x1080 | 67.5 | 60.0 | 148.500 | ○ | ○ | ○ |
| | 2048x1152 | 70.9 | 60.0 | 156.750 | ○ | ○ | ○ |
| | 2560x1440 | 88.8 | 60.0 | 241.700 | ○ | ○ | ○ |
| | 2560x1600 | 98.7 | 60.0 | 268.500 | ○ | ○ | ○ |
| 4K 3840x2160 | | 67.5 | 30.0 | 297.000 | ○ | ○ | ○ |
| | | 135.0 | 60.0 | 594.000 | ○ | ○ | ○ |
| IBM | 720x400 | 31.5 | 70.0 | 28.320 | ○ | ○ | ○ |
| SD | 480i | 60Hz | 15.7 | 60.0 | 27.000 | ○ | ○ |
| | 576i | 50Hz | 15.6 | 50.0 | 13.500 | ○ | ○ |
| | 480p | 60Hz | 31.5 | 60.0 | 27.000 | ○ | ○ |
| | 576p | 50Hz | 31.3 | 50.0 | 27.000 | ○ | ○ |
| HD | 720p | 50Hz | 37.5 | 50.0 | 27.000 | ○ | ○ |
| | | 60Hz | 45.0 | 60.0 | 74.250 | ○ | ○ |
| | 1080i | 50Hz | 28.1 | 50.0 | 74.250 | ○ | ○ |
| | | 60Hz | 33.7 | 60.0 | 74.250 | ○ | ○ |
| | 1080p | 50Hz | 56.3 | 50.0 | 148.500 | ○ | ○ |
| | | 60Hz | 67.5 | 60.0 | 148.500 | ○ | ○ |

* ○ means supported the timing.