

FT133BI5CAPOB

v1: GL: 3030514302 | EU: 1010502664



Pictures show sample configurations, real product may vary.

DISPLAY

Display Size [inch]	13.3
Aspect Ratio	16 : 9
Resolution	1920 × 1080
Active Area [mm]	293.76 × 165.24
Brightness [cd/m²]	300
Contrast Ratio	800 : 1
LED life time [h]	15000
Viewing Angle [°]	170 / 170
Display Interface	eDP

TOUCH PANEL

Touch Type	Projected Capacitive 10-point Multi-touch
Printing Type	Organic
Glass Thickness [mm]	1.1
Cover Glass Surface Treatment	AG (chemical etching)
IK Protection	IK08
Printing Color	RAL9004 (Black)
Strengthening	Thermally Strengthened
Touch Controller	EXC81W84
Touch Interface	USB
Touch Resolution RX	53
Touch Resolution TX	30
Optical Bonding	Clear Bond®

PC/MONITOR SYSTEM

Processor	Intel® Core™ i5-1145G7E (Tiger Lake U)
Standard Operating System	Debian 12 *
OS Available on Request (additional fee)	Linux Ubuntu 22.4, Windows 10 & 11
RAM Size	8 GB DDR4
SSD Size	240 GB
Loudspeaker	2× 2W
Wifi	Intel® AC 3168
HDMI	1
DP	1
Audio In / Out	1 (Realtek® ALC897 Audio CODEC)
USB 2.0	2
USB 3.0	2
Ethernet Network (10/100/1000 Mbit/s)	2 (Realtek® 8111H)
Serial Port RS232 (RX / TX only)	2
SD Card Slot	1
SIM Card Slot	1

ENVIRONMENTAL CONDITIONS

Operation Temperature	-10°C to 60°C
Storage Temperature	-20°C to 60°C
Humidity Range	10% to 90%

CERTIFICATIONS

CE Certificate	Yes
FCC Certificate	Yes

CHASSIS

Case Design	Rubber Frame Sealing
Case Size	Large
IP Protection	IP65 Front / IP40 Back
Case Color	RAL9004 (Black)
Case Coating	Powder Coating
Case Material	Aluminum
Case size L × W × H [mm]	338.2 × 220.7 × 42.3
Cut-out for clamp supports L × H [mm]	322.0 × 196.0
Max. wall thickness for clamp supports [mm]	5.0
Amount of clamps required	4
Mounting	VESA 100 × 100

SERIAL (RS232) PIN DEFINITION

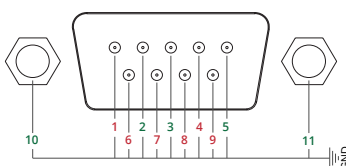

2	RXD1
3	TXD1
5	GND
10	GND
11	GND

* Pyramid Computer GmbH is not affiliated with Debian. Debian is a registered trademark owned by Software in the Public Interest, Inc.

ACCESSORIES

Power Adapter	100-240V ACDC active switching; 12V DC-Out
Wifi Antenna	RP-SMA female
Short Instruction Manual	Yes
Power over Ethernet (PoE)	No, available upon request

INTENDED USE/APPLICATION

The device is to be used as (touchscreen) display for indoor use as control panel, digital signage, way-finding, POS and similar applications.

Direct sunlight might increase the device temperature beyond the allowed storage and operation conditions. Therefore the devices must be protected against direct sunlight. Devices operated or stored outside the specified temperature ranges are not covered by warranty.

POWER

Power Indicator	Green LED
Working Power	9-36V
Power Consumption	18.8W
Stand-By Consumption	<1W

WEIGHT & PACKAGING

Net Weight	~3.40 kg est.
Gross Weight	~5.30 kg est. (incl. Cartonage)
Packaging Material	100% recyclable cardboard and polyethylene (PE)
Packaging Size L x W x H [mm]	495.0 x 310.0 x 80.0

Front kit & Back kit concept:

- Pre-assembled or separately packaged available
- Easily replace or switch back kits and front-kits
- Connected through various connectors
- Assembly to be done by a professional

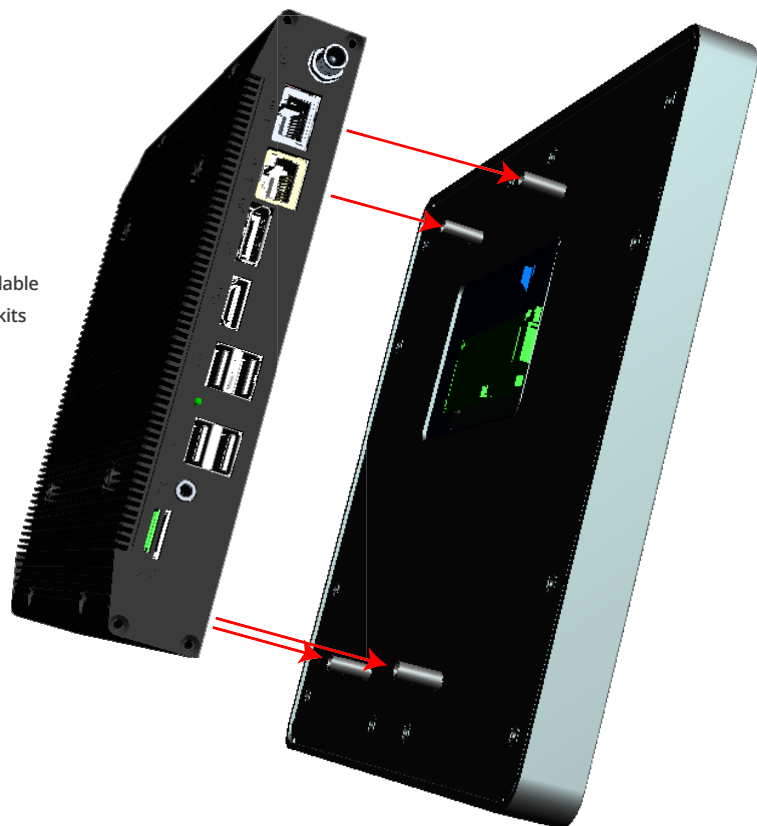

DIMENSIONS

Pictures show sample configurations, real product may vary.

13.3" RUBBER FRAME FRONT KIT

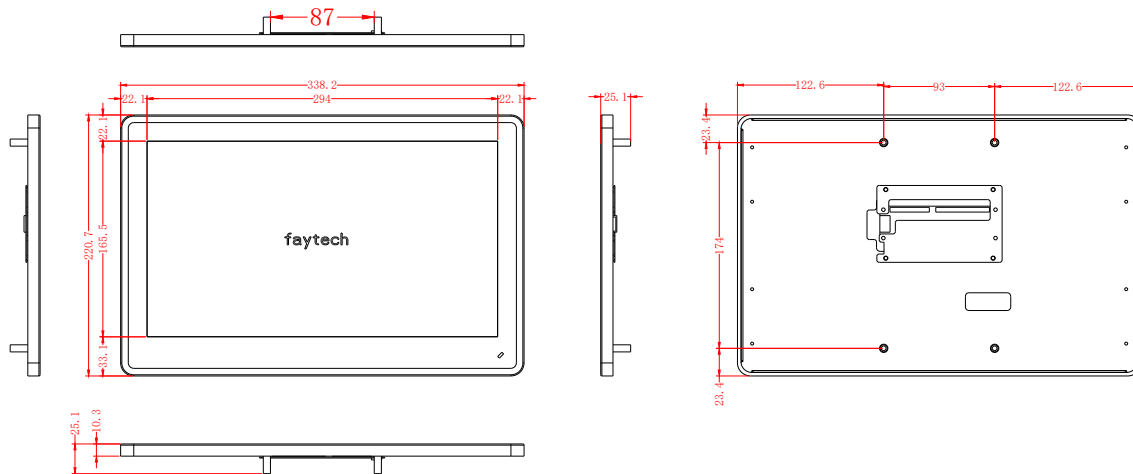

LARGE IPC BACK KIT (I5-1145G7E)

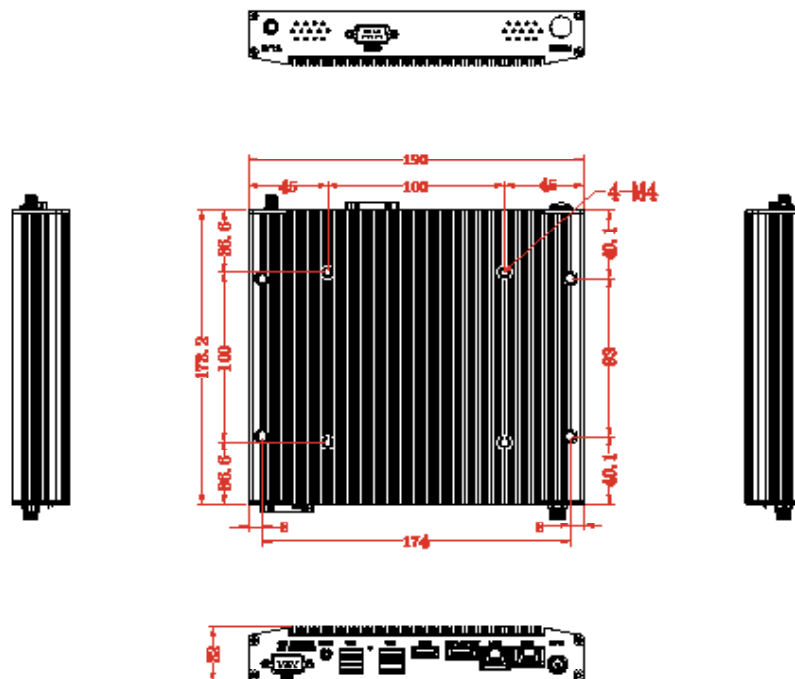

UPDATE NOTES:

Version:	Changes:
v1	First version