

CDE92UW

CDE105UW

Commercial Display User Guide

IMPORTANT: Please read this User Guide to obtain important information on installing and using your product in a safe manner, as well as registering your product for future service. Warranty information contained in this User Guide will describe your limited coverage from ViewSonic® Corporation, which is also found on our web site at <http://www.viewsonic.com> in English, or in specific languages using the Regional selection box of our website.

Model No. VS20065 | VS20378
P/N: CDE92UW | CDE105UW

Thank you for choosing ViewSonic®

As a world-leading provider of visual solutions, ViewSonic® is dedicated to exceeding the world's expectations for technological evolution, innovation, and simplicity. At ViewSonic®, we believe that our products have the potential to make a positive impact in the world, and we are confident that the ViewSonic® product you have chosen will serve you well.

Once again, thank you for choosing ViewSonic®!

Safety Precautions

Please read the following **Safety Precautions** before you start using the device.

- Keep this user guide in a safe place for later reference.
- Read all warnings and follow all instructions.
- Do not use the device near water. To reduce the risk of fire or electric shock, do not expose the device to moisture.
- Never remove the rear cover. This display contains high-voltage parts. You may be seriously injured if you touch them.
- Avoid exposing the device to direct sunlight or other sources of sustained heat.
- Do not install near any heat sources such as radiators, heat registers, stoves, or other devices (including amplifiers) that may increase the temperature of the device to dangerous levels.
- Use a soft, dry cloth to clean the external housing. For more information, refer to the "Maintenance" section.
- When moving the device, be careful not to drop or bump the device on anything.
- Do not place the device on an uneven or unstable surface. The device may fall over resulting in an injury or a malfunction.
- Do not place any heavy objects on the device or connection cables.
- If smoke, an abnormal noise, or a strange odor is present, immediately turn the device off and call your dealer or ViewSonic®. It is dangerous to continue using the device.
- The device is a monitor with an LED backlight intended for general office use.
- Do not attempt to circumvent the safety provisions of the polarized or grounding-type plug. A polarized plug has two blades with one wider than the other. A grounding-type plug has two blades and a third grounding prong. The wide blade and the third prong are provided for your safety. If the plug does not fit into your outlet, obtain an adapter and do not attempt to force the plug into the outlet.
- When connecting to a power outlet, DO NOT remove the grounding prong. Please ensure grounding prongs are NEVER REMOVED.
- Protect the power cord from being treaded upon or pinched, particularly at the plug, and at the point where it emerges from the equipment. Ensure that the power outlet is located near the equipment so that it is easily accessible.
- Only use attachments/accessories specified by the manufacturer.
- When a cart is used, use with caution when moving the cart/equipment combination to avoid injury from tipping over.

- Disconnect the power plug from the AC outlet if the device is not being used for a long period of time.
- Place the device in a well-ventilated area. Do not place anything on the device that prevents heat dissipation. Also, avoid any direct lighting.

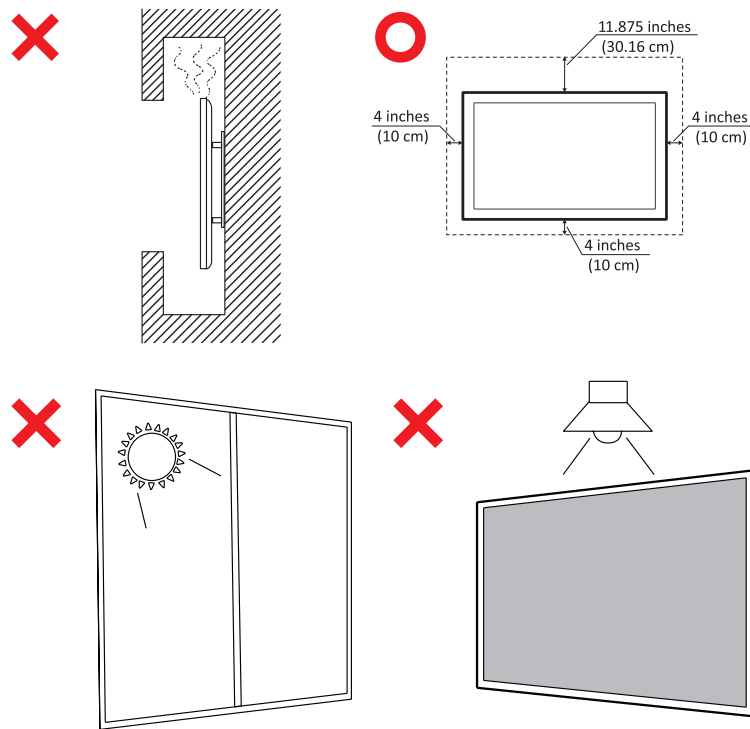

IMPORTANT

To ensure the optimal performance and longevity of your display, it is essential to follow the recommended handling, mounting, and storage procedures. Placing the display in a horizontal position can lead to a range of potential issues, including:

- Excessive stress on the display's structural components, resulting in the formation of cracks or distortions along the edges.
- Uneven weight distribution, which can cause the screen to warp, sustain internal damage, or crack over time.
- Thermal-related damage, as the internal components may not be able to dissipate heat as intended, leading to potential failure or permanent damage.

Furthermore, altering the display's form can also compromise the integrity of its internal components, including the sensitive LCD cells, which can result in a permanent degradation of the display's quality.

To prevent such issues and maintain the display's optimal condition, it is recommended to always mount, handle, transport, and store it in a vertical position. Failure to do so may void the warranty and compromise the display's performance and lifespan.

NOTE: Any damage resulting from the misuse or improper handling of the display is not covered under warranty.

CAUTION:

Immediately unplug your device from the wall outlet and refer servicing to a qualified service personnel under the following conditions:

- When the power supply cord or plug is damaged.
- If liquid has been spilled onto or objects have fallen into the unit.
- If the unit has been exposed to moisture.
- If the unit does not operate normally or has been dropped.

Never place the device in an unstable location. The device may fall, causing serious personal injury or death. Many injuries, particularly to children, can be avoided by taking simple precautions such as:

- Using cabinets or stands recommended by the manufacturer of the device.
- Only using furniture that can safely support the device.
- Ensuring the device is not overhanging the edge of the supporting furniture.
- Not placing the device on tall furniture (e.g., cupboards or bookcases) without anchoring both the furniture and the device to a suitable support.
- Not placing the device on cloth or other materials that may be located between the device and supporting furniture.
- Educating children about the dangers of climbing on furniture to reach the device or its controls.

If the existing device is going to be retained and relocated, the same considerations as above should be applied.

Contents

Safety Precautions.....	3
Contents.....	6
Introduction	10
Package Contents	10
Wall Mounting Specifications (VESA)	11
Product Overview	12
I/O Panels	13
Rear I/O	14
Side I/O.....	15
OPS and Wi-Fi Slot.....	17
Remote Control	18
Remote Control Receiver Range	21
Making Connections.....	22
Connecting to Power	22
Connecting to External Devices	23
USB Type C Connection	23
HDMI Connection	23
DisplayPort Connection.....	23
RS-232 Connection	24
USB Connection	25
USB Type A	25
USB Type C	25
Network Connection.....	26
Media Connection	27
Audio Connection	28
Audio In	28
Audio Out	28
SPDIF Connection	28
Video Output Connection (HDMI Out)	29
Optional Connections	30
UMB202 Camera Plate Installation	30

Using Your Display.....	31
Turning the Display On/Off.....	31
Initial Launch Setup	32
Home Screen	34
General Settings	35
Network.....	36
Device.....	39
System.....	46
General Settings Menu Tree	48
On-Screen Display (OSD) Menu	50
Navigating the OSD Menu using the Remote Control.....	50
On-Screen Display (OSD) Menu Tree	51
Picture	56
Low Blue Light Filter and Eye Health.....	57
PIP	59
Using PIP (Split-Screen Mode) with an Application.....	60
Audio	62
Time.....	63
Advanced.....	64
About.....	66

Pre-installed Applications and Settings.....	67
myViewBoard Display	67
myViewBoard Manager	68
vCast	69
Display Group Settings	71
Synchronized Group Screen All the Time	73
Share a Screen to the Display Group (One to Many Casting).....	73
Moderator Mode	74
Broadcast	75
Multiple Screen Sharing	75
Preview Screen.....	75
Touch.....	75
Casting from Windows, MacBook, and Chrome Devices	76
Casting from Android Devices	78
Casting from Apple iOS Devices	82
Connecting to a ViewBoard from a Mobile Device	85
Casting with Chromecast.....	86
Casting with Miracast.....	88
Other Default Applications	90
Chromium.....	90
Folders.....	91
OfficeMobile.....	93
vSweeper.....	94
RS-232 Protocol.....	95
Description	95
RS-232 Hardware Specification	95
LAN Hardware Specification.....	96
RS-232 Communication Setting.....	96
LAN Communication Setting	96
Command Message Reference.....	96
Protocol	97
Set-Function Listing.....	97
Get-Function Listing	105
Remote Control Pass-through Mode	113

Appendix.....	116
USB Media Support Format.....	116
Photo.....	116
Video.....	116
Audio.....	120
Subtitle.....	126
Timing Table.....	127
HDMI PC.....	127
HDMI.....	128
Type C.....	129
Troubleshooting.....	130
Maintenance.....	132
General Precautions.....	132
Cleaning the Screen.....	132
Cleaning the Case.....	132
Regulatory and Service Information	133
Compliance Information.....	133
FCC Compliance Statement.....	133
Industry Canada Statement.....	133
CE Conformity for European Countries.....	133
Declaration of RoHS2 Compliance.....	134
ENERGY STAR Statement.....	135
Indian Restriction of Hazardous Substances.....	136
Product Disposal at End of Product Life.....	136
Copyright Information.....	137
Customer Service.....	138
Limited Warranty.....	139
Mexico Limited Warranty.....	142

Introduction

Package Contents

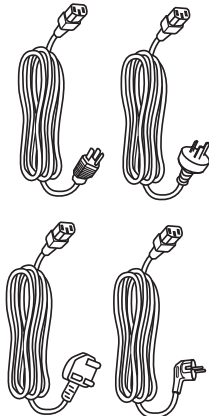

ship by region

Power Cable
(3 m/9.84 ft)



HDMI Cable
(3 m/9.84 ft)

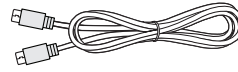

USB Type C Cable
(1.8 m/5.9 ft)



Remote Control



2 x AAA Battery

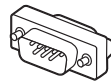

RS-232 Adapter

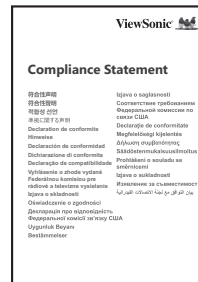

Compliance Statement

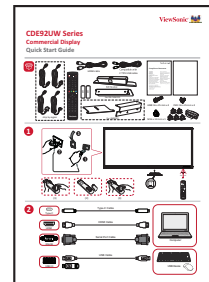

Quick Start Guide



4 x HM8 16 x 25 mm



4 x CM3 16 x 25 mm



M16 x 14 mm



5 x Clamp



2 x Camera Plate
(for UMB202)

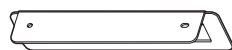

Camera Plate
(for VB-CAM-201)

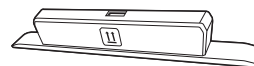

Wi-Fi Dongle
(VB-WIFI-004)
(optional)

NOTE: The cables included in your package may vary depending on your country. Please contact your local reseller for more information.

Wall Mounting Specifications (VESA)

NOTE: Please follow the instructions in the wall mount installation guide to install your wall mount or mobile mount bracket. If attaching to other building materials, please contact your nearest dealer.

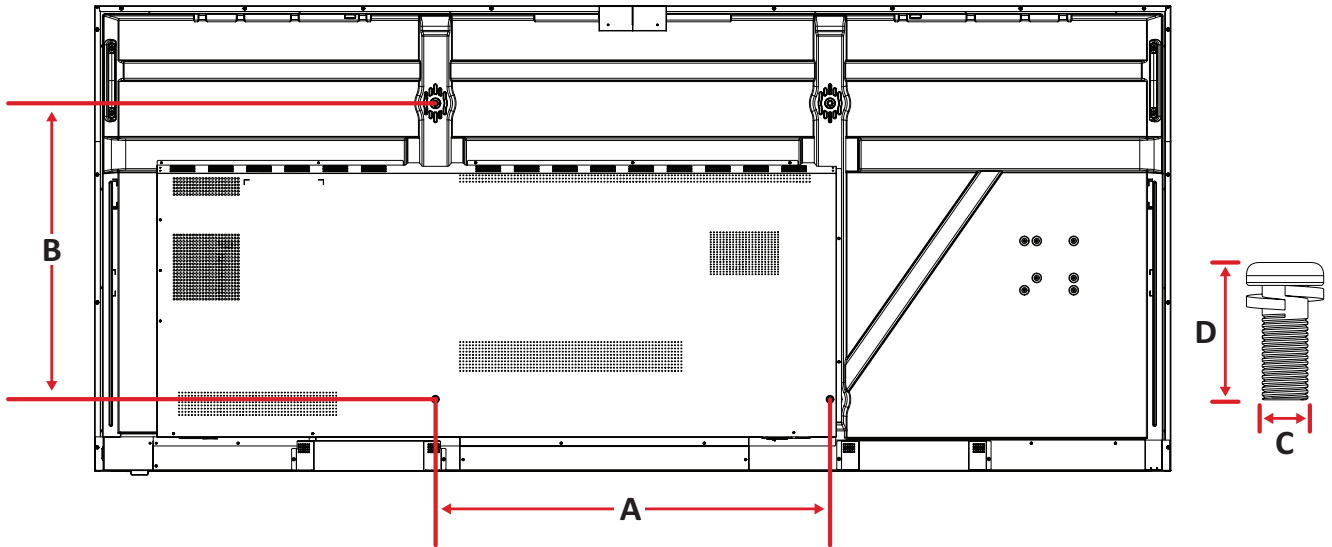

Model	VESA Spec. (A x B)	Standard Screw (C x D)	Screw Quantity
CDE92UW	800 x 600 mm	M8 x 25 mm	4

NOTE:

- Do not use screws that are longer than the standard dimension, as they may cause damage to the inside of the display.
- Only mount the display in landscape orientation. Never mount in a portrait orientation.

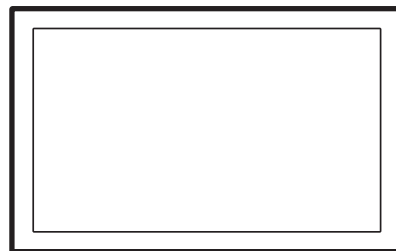
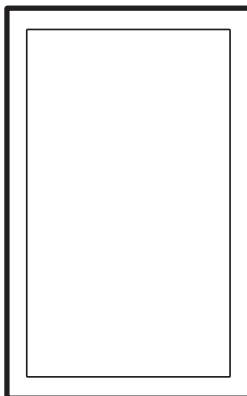

Product Overview

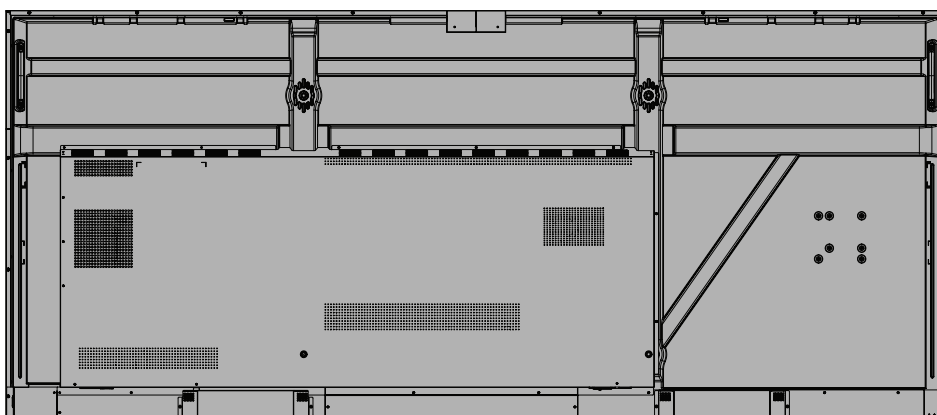
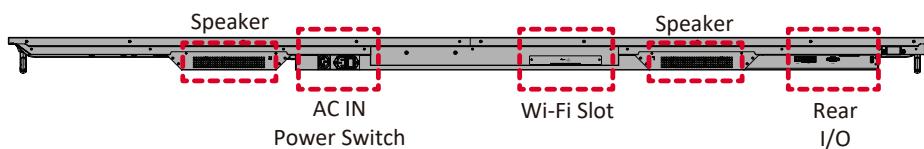
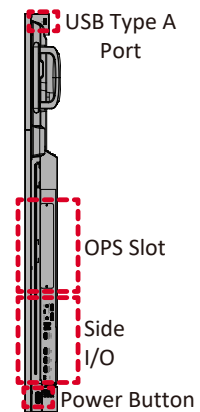
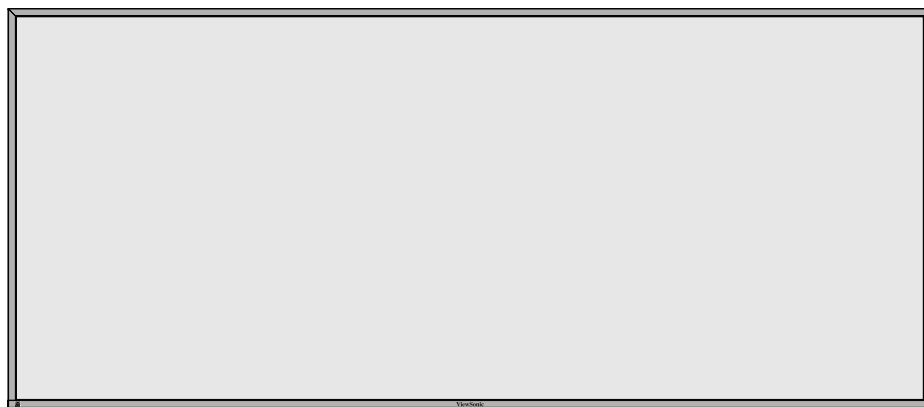
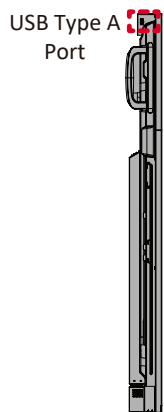

I/O Panels

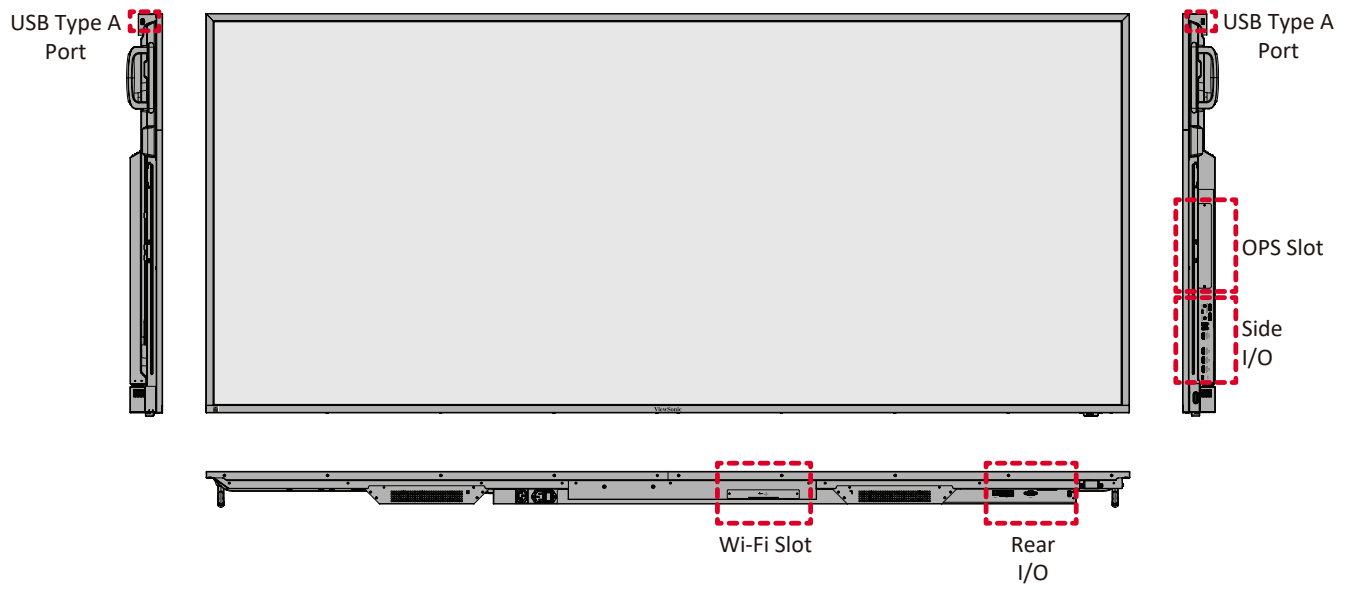

Rear I/O

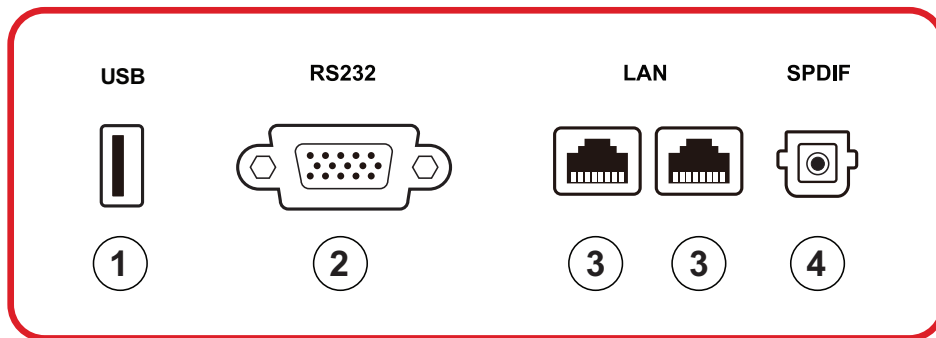

Number	Item	Description
1	USB	<ul style="list-style-type: none"> • USB Type A input. • USB 2.0 standard. • Connect USB devices such as hard disks, keyboard, mouse, etc. • Supports: 5V/0.5A.
2	RS-232	Serial interface used for mutual transfer of data between devices.
3	LAN	Standard RJ45 (10M/100M/1000M) Internet connection interface. Features hub support for network sharing.
4	SPDIF	Multichannel sound via optical signals.

Side I/O

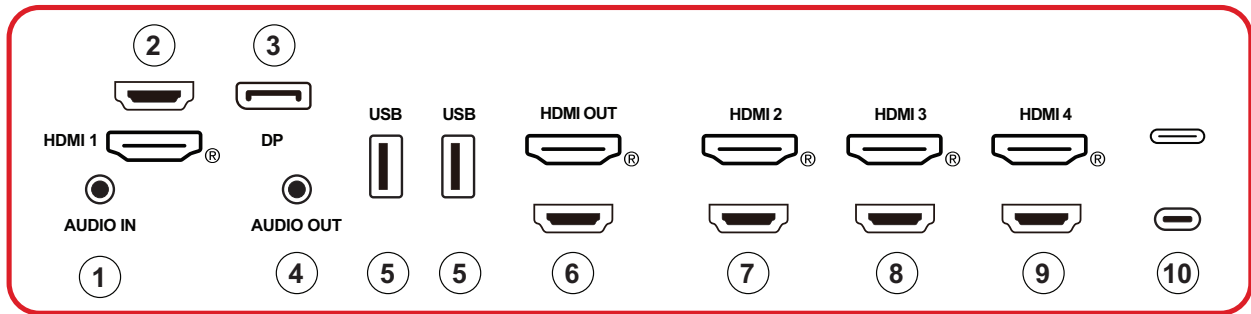

Number	Item	Description
1	AUDIO IN	External device audio input.
2	HDMI 1	<ul style="list-style-type: none"> HDMI input. Connect to a computer with HDMI output, set-top box, or other video device. Supports 4K display; HDMI v. 2.1; CEC; ARC.
3	DP	<ul style="list-style-type: none"> DisplayPort input. Supports 5K @ 60 Hz; DP 1.4; HDCP 2.3.
4	AUDIO OUT	Audio output to an external speaker or headset.
5	USB	<ul style="list-style-type: none"> USB Type A input. USB 3.0 standard. Connect USB devices such as hard disks, keyboard, mouse, etc. Supports: 5V/0.9A.
6	HDMI OUT	
7	HDMI 2	<ul style="list-style-type: none"> HDMI input Connect to a computer with HDMI output, set-top box, or other video device Supports 4K display; HDMI v. 2.0; CEC.
8	HDMI 3	<ul style="list-style-type: none"> HDMI input Connect to a computer with HDMI output, set-top box, or other video device Supports 4K display; HDMI v. 2.0; CEC.
9	HDMI 4	<ul style="list-style-type: none"> HDMI input Connect to a computer with HDMI output, set-top box, or other video device Supports 4K display; HDMI v. 2.0; CEC.

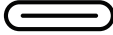



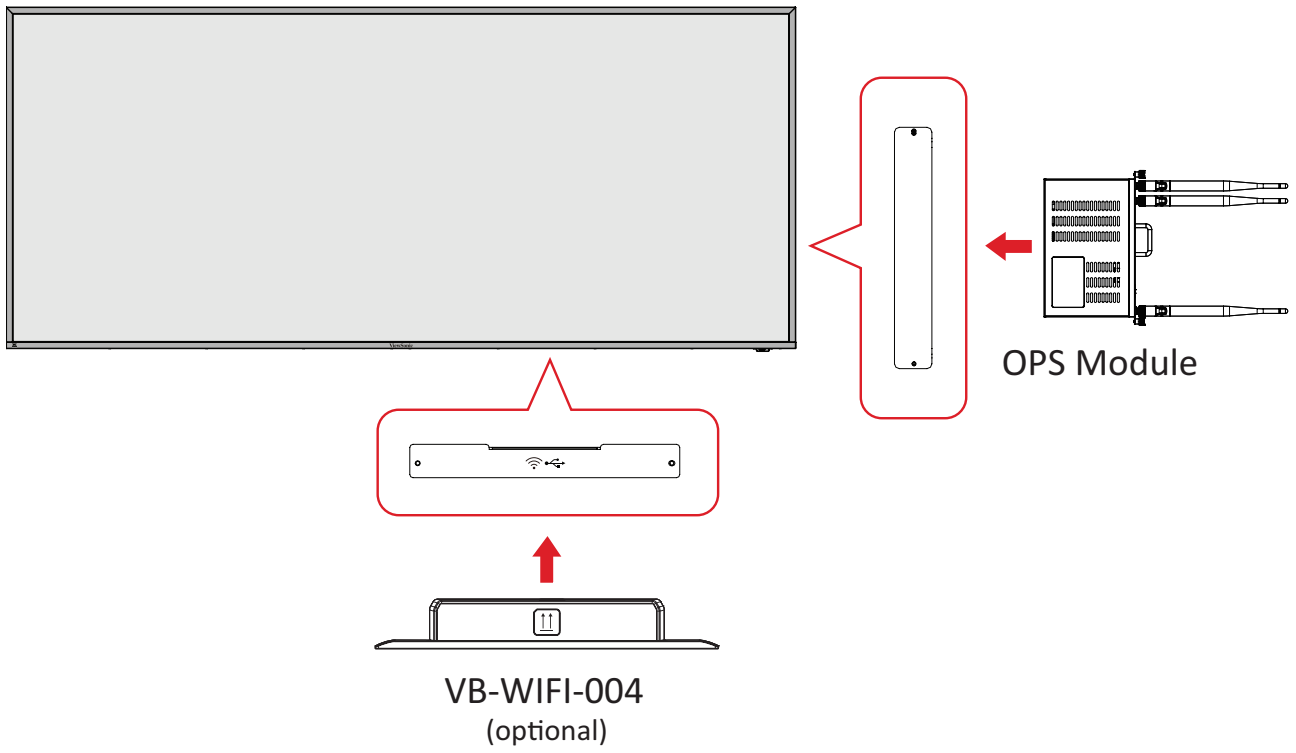



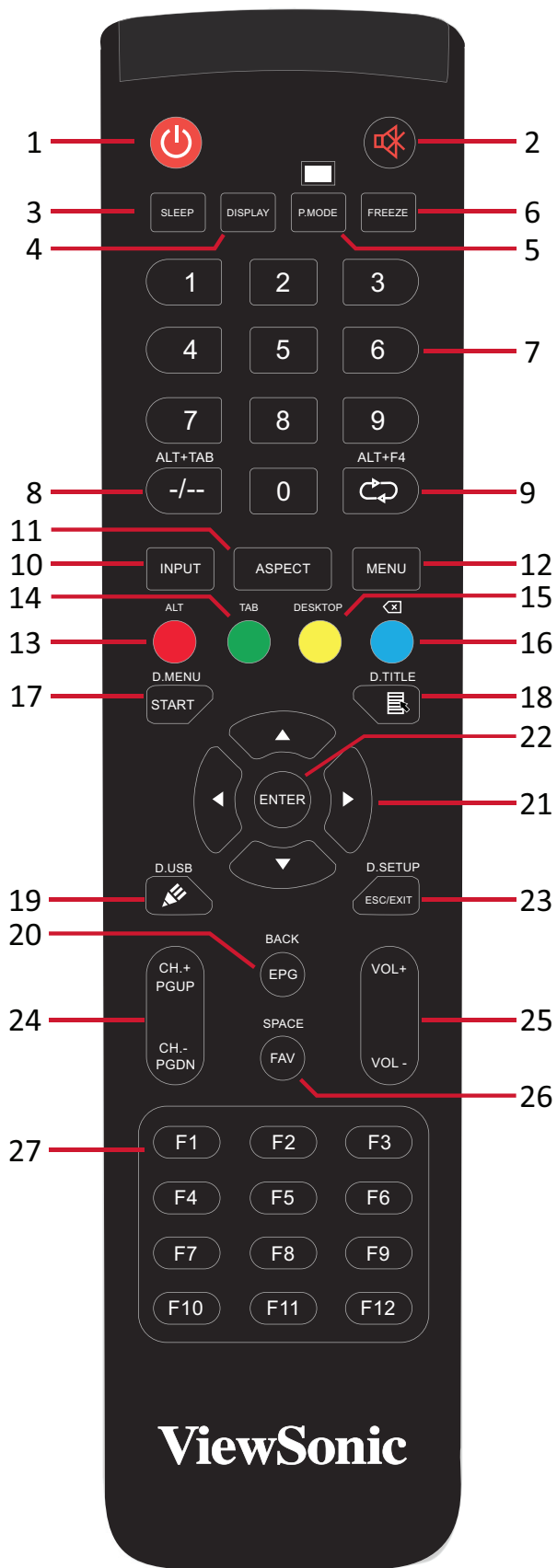

Number	Item	Description
10	 (Type C)	<ul style="list-style-type: none"> • USB Type C input. • USB 3.0 standard. • Supports DP v. 1.2 with audio and video. • Supports LAN by 100M. • Supports power charge up to 100W without OPS. Also supports: 5V/3A, 9V/3A, 12V/3A, 15V/3A, 20V/3.25A, 20V/5A.

OPS and Wi-Fi Slot



Remote Control



Number	Item	Description
1		Power on/off
2		Mute/Unmute
3	SLEEP	Sleep Mode
4	DISPLAY	For Non-Android sources; display current input source information
5	P.MODE	Blank Screen
6	FREEZE	Freeze Screen
7		Numeric input buttons
8	ALT+TAB -/--	Slot-in computer space bar Alt+Tab
9	ALT+F4 	Slot-in computer, close program window
10	INPUT	Input source selection
11	ASPECT	Back to slot-in system main interface
12	MENU	Access Settings
13	Red / ALT	Screen capture
14	Green / TAB	PC ¹ [Tab] button
15	Yellow / DESKTOP	Switch to slot-in PC desktop
16	BLUE/ 	PC ¹ [Backspace] button
17	START / D.MENU	PC ¹ [Windows] button
18	 / D.TITLE	PC ¹ [Menu] button
19	 / D.USB	Writing software setup
20	EPG/BACK	Return button
21	 /  /  / 	Scroll up, down, left, and right
22	ENTER	Confirm selection/state
23	ESC / EXIT / D.SETUP	Shortcut button to exit dialogue boxes
24	CH.+ / PGUP / CH.- / PGDN	CH+: PC previous page CH-: PC next page
25	VOL+ / VOL-	Increase/Decrease volume
26	FAV / SPACE	PC ¹ [Space] button
27	F1-F12	Built-in computer F1 - F12 function button

1 - All computer-related function keys are not available without a slot-in computer.

Inserting Remote Control Batteries

To insert batteries into the remote control:

1. Remove the cover on the rear of the remote control.
2. Insert two “AAA” batteries, ensuring the “+” symbol on the battery matches the “+” on the battery post.
3. Replace the cover by aligning it with the slot on the remote control and snapping the latch shut.

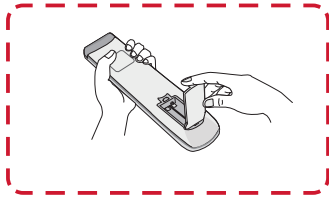

(1)

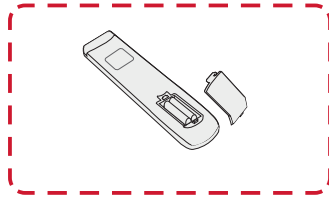

(2)

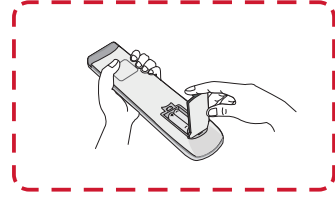

(3)

WARNING: There is a risk of explosion if batteries are replaced with the incorrect type.

NOTE:

- It is recommended that you do not mix battery types.
- Always dispose of old batteries in an environmentally friendly way. Contact your local government for more information on how to dispose of batteries safely.

Remote Control Receiver Range

The working range of the remote control is shown here. It has an effective range of 6 meters, 30° degrees left and right. Please make sure there is nothing obstructing the remote control's signal to the receiver.



Making Connections

Connecting to Power

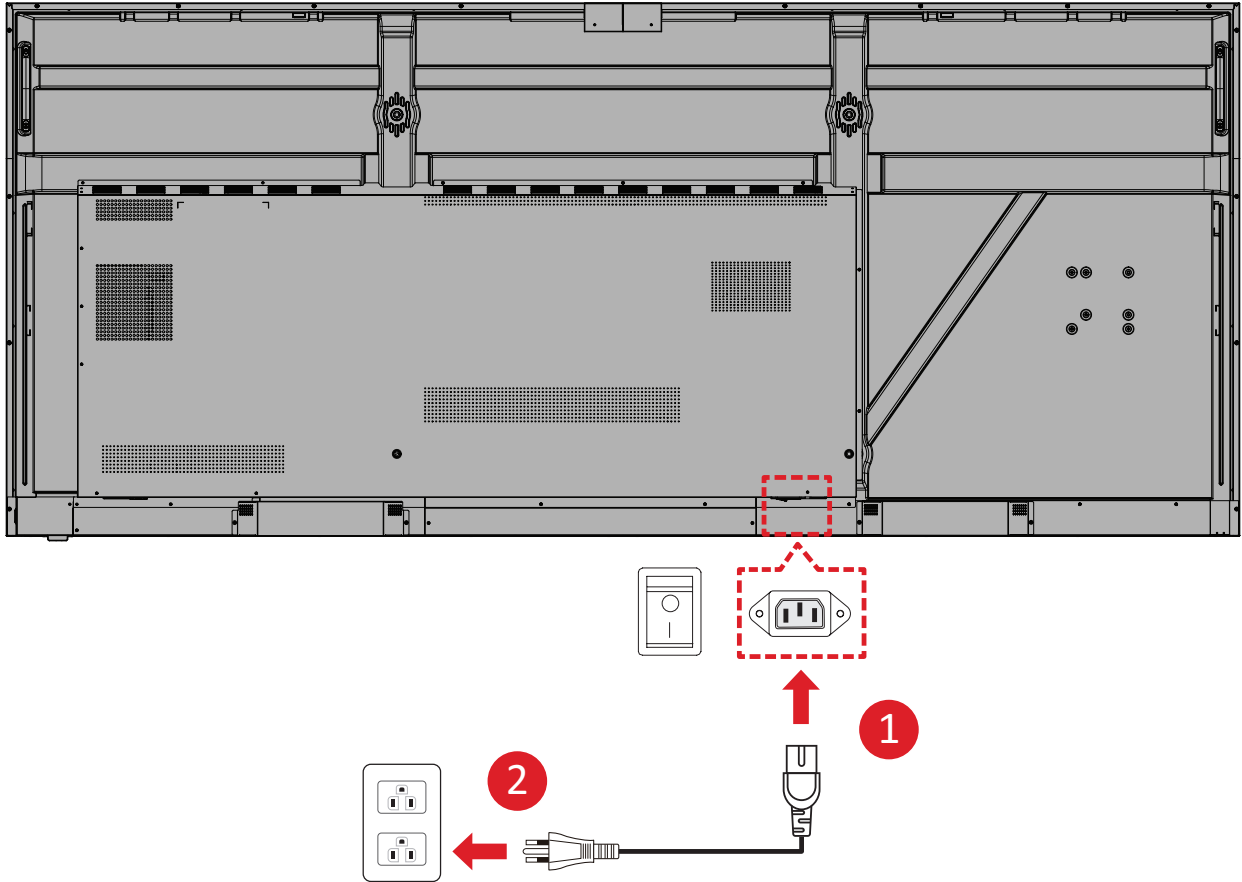

1. Connect the power cord to the AC IN jack at the rear of the display.
2. Plug the power cord plug into a power outlet.

Connecting to External Devices

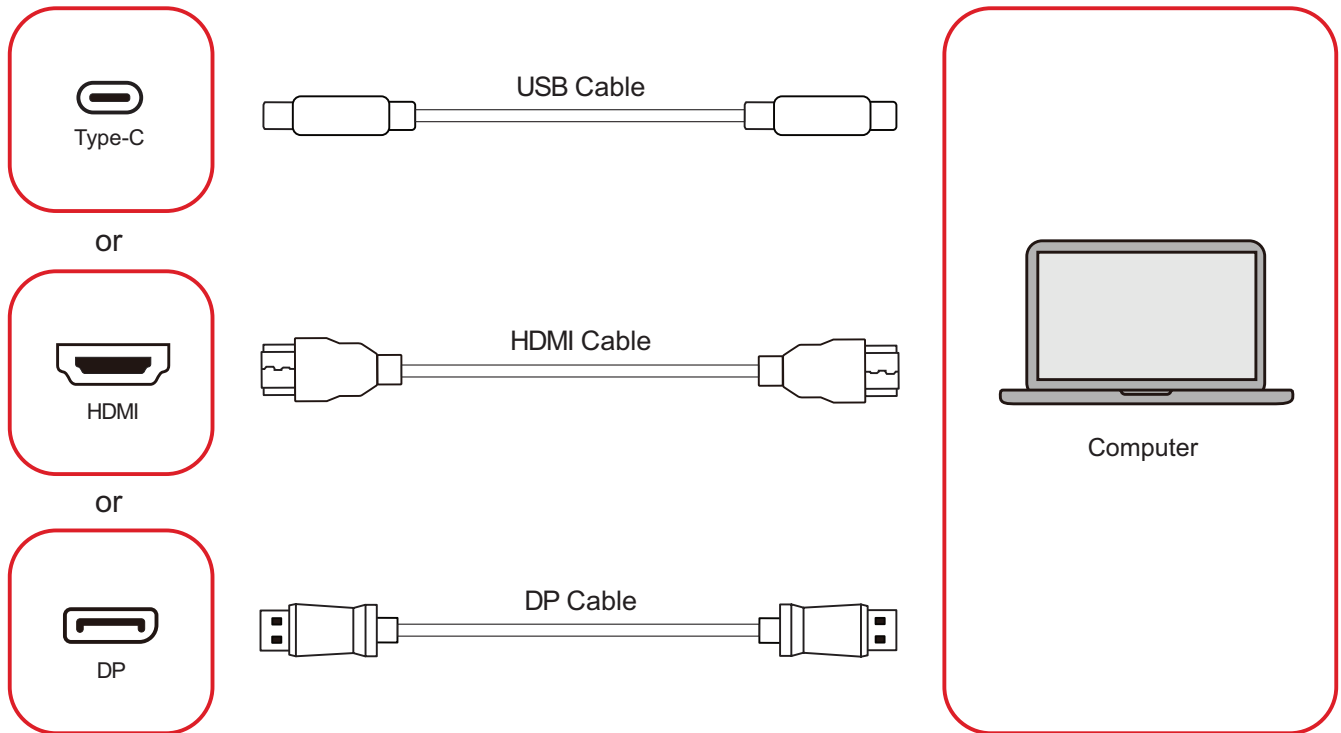

Your external device(s) can be connected in any of the following configurations:

USB Type C Connection

Connect a USB Type C cable from your external device to the Type C () port on the display.

HDMI Connection

Connect an HDMI cable from your external device to the **HDMI 1/2/3/4** port on the display.

DisplayPort Connection

Connect a DisplayPort cable from your external device to the **DP** port on the display.

RS-232 Connection

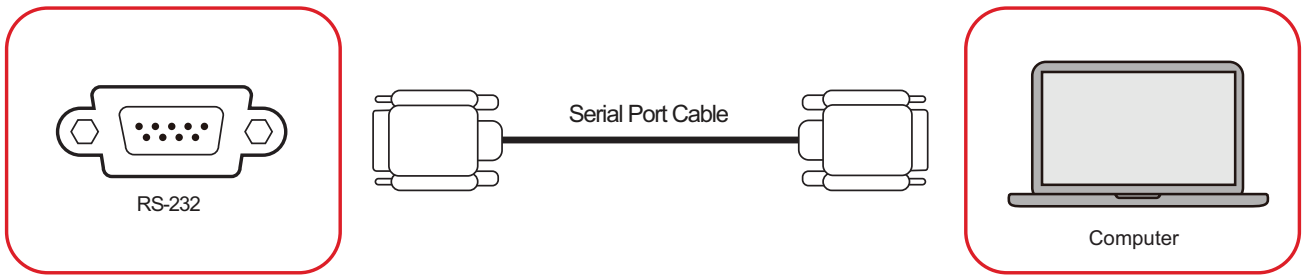

When you use a RS-232 serial cable to connect the display to an external computer or control system, certain functions can be controlled remotely such as: power on and off, volume adjustment, input select, brightness, and more.

USB Connection

Just like any PC, it is easy to connect various USB devices and other peripherals to your display.

USB Type A

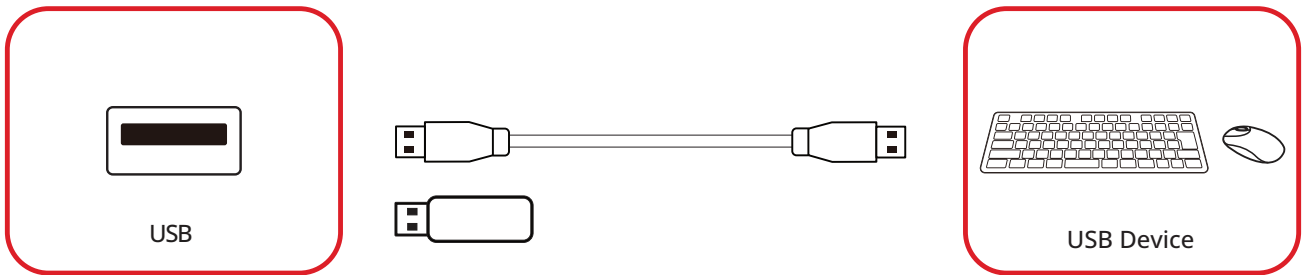

Plug the USB device into a **USB** Type A port of the display.

USB Type C

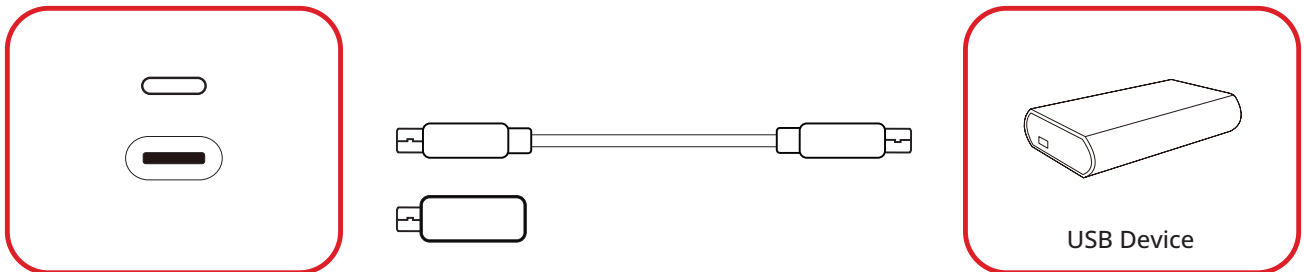

Plug the USB device into the USB Type C (≡) port of the display.

Network Connection



To connect to a local network, connect an Ethernet cable to your network, then connect the other end to a **LAN** port of the display.

Media Connection

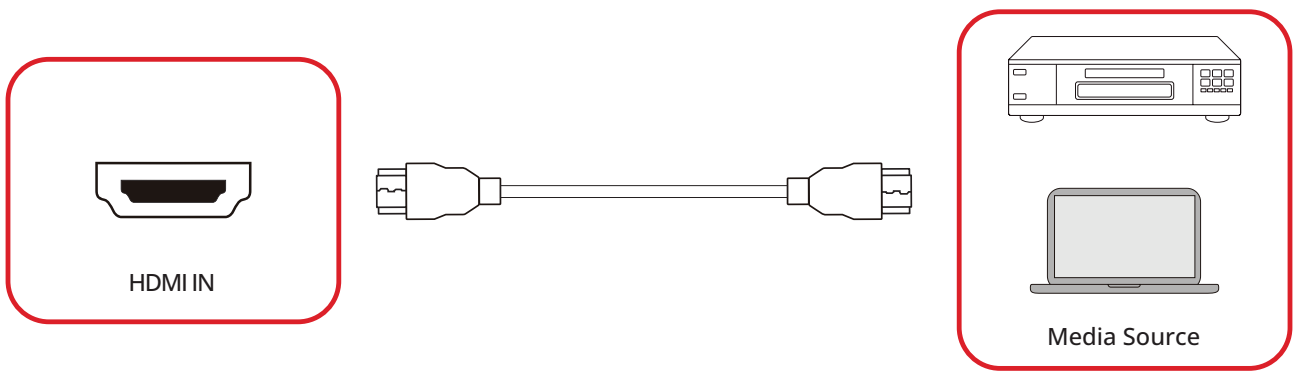

To connect to a media source:

1. Connect an HDMI cable to a **HDMI** port on the display and peripheral device.
2. Press the **INPUT** button on the remote control and switch to the HDMI input source.

Audio Connection

The display supports **Audio In**, **Audio Out**, and **SPDIF**.

Audio In

To play audio from your external device through the display's speakers, connect one end of an audio cable to your external device, and the other end to the display's **AUDIO IN** port.

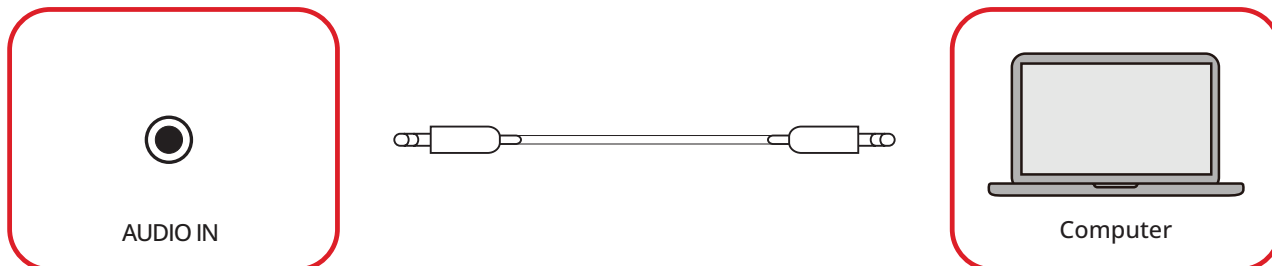

Audio Out

To play audio from the display through an external speaker, connect one end of an audio cable to the external speaker, and the other end to the display's **Audio Out** port.

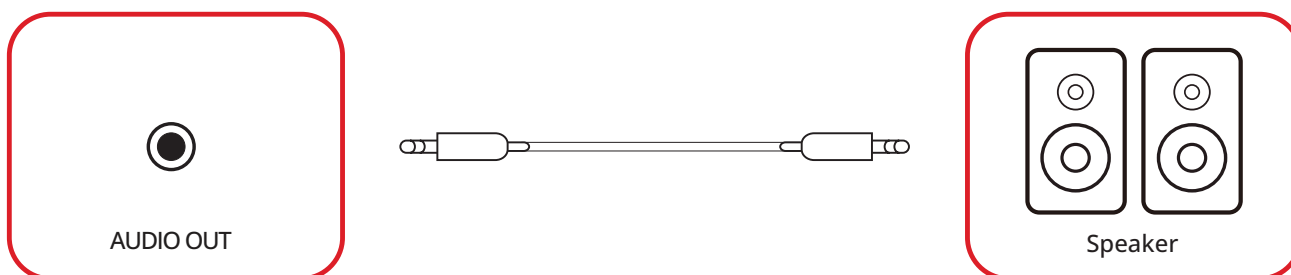

SPDIF Connection

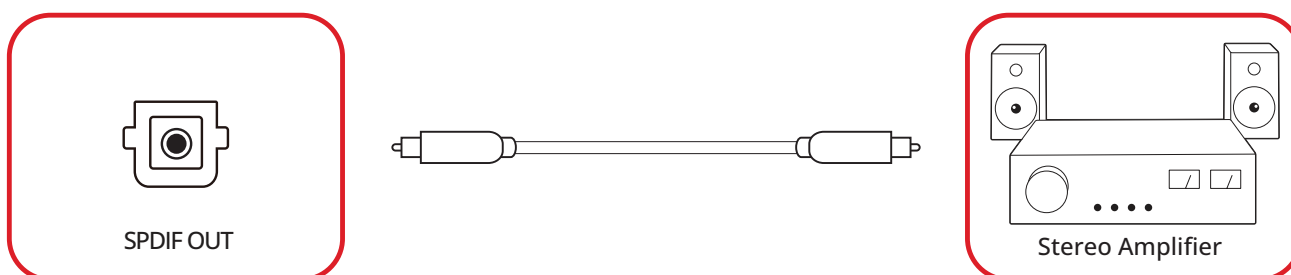

To connect to an external sound system, connect an optical cable from the display's **SPDIF** port to your sound system's optical connector.

Video Output Connection (HDMI Out)

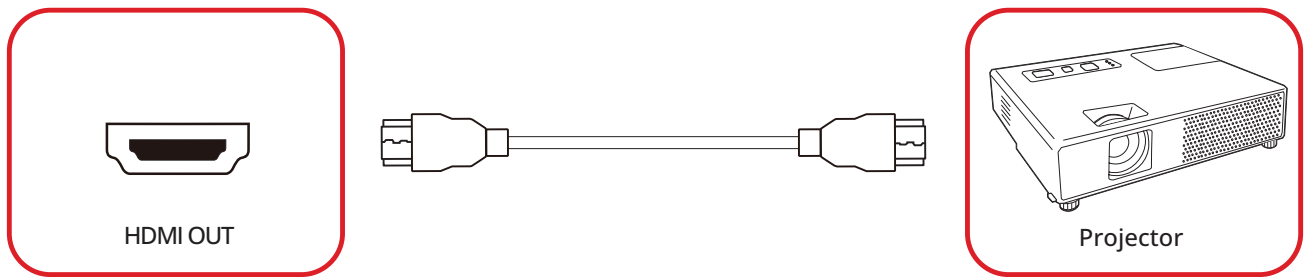

To output video to a display device:

1. Connect an HDMI cable to the **HDMI IN** port of your device, and the other end to the **HDMI OUT** port of the display.
2. Press the **INPUT** button on the remote control and switch to the HDMI IN input source.

Optional Connections

UMB202 Camera Plate Installation

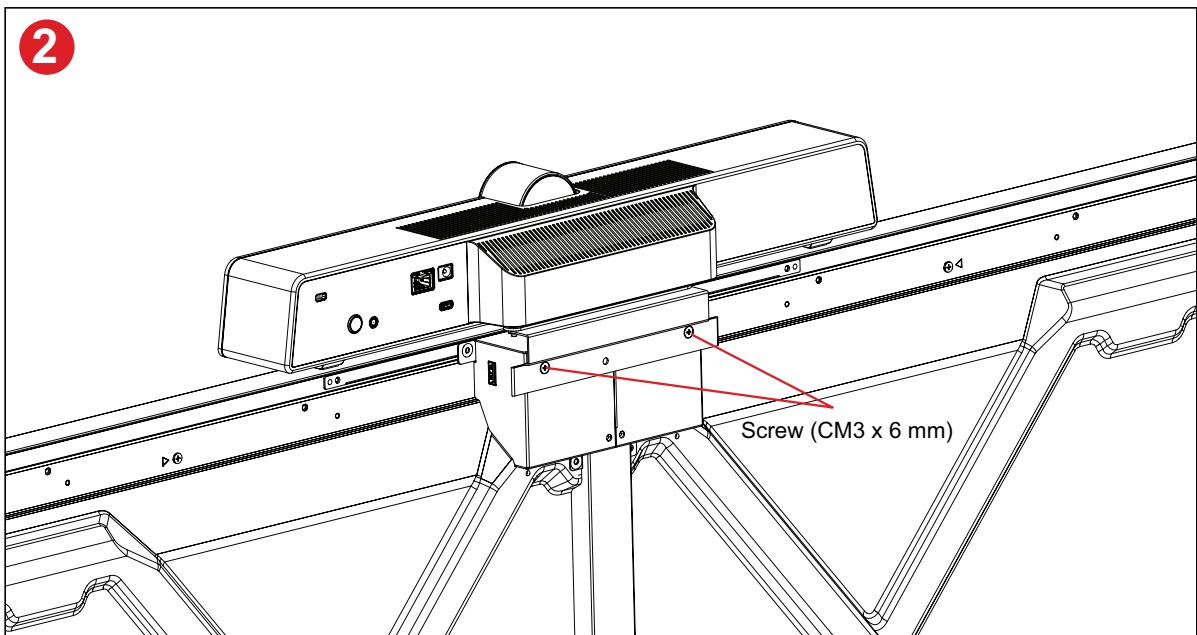
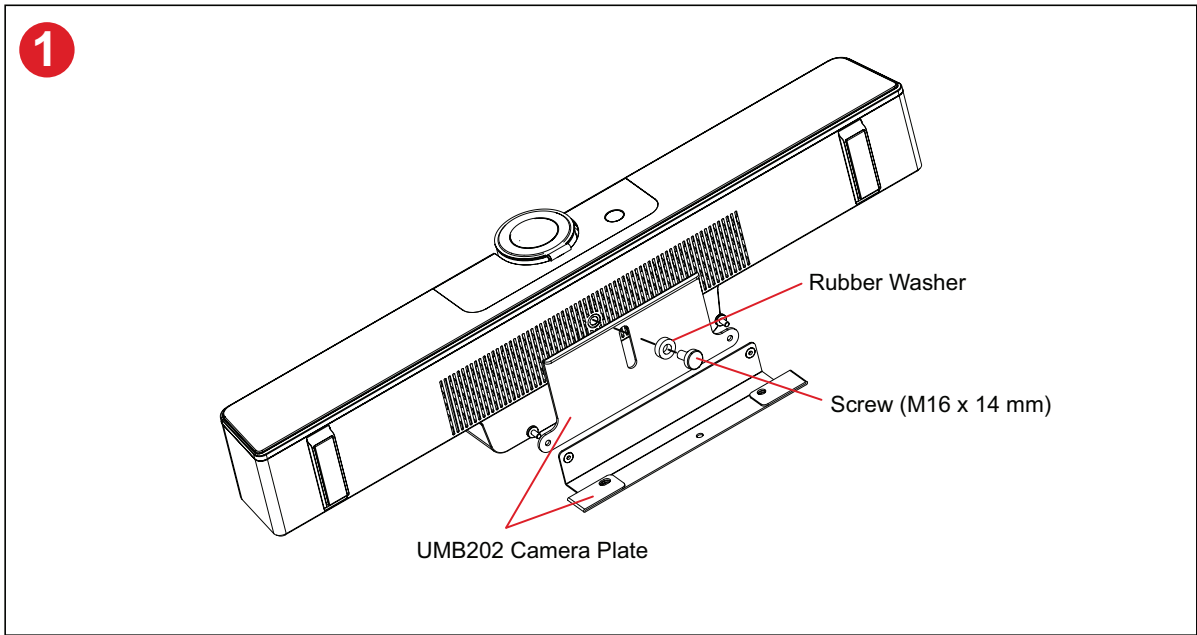

Using Your Display

Turning the Display On/Off

1. Make sure the power cord is connected, plugged into a power outlet, and the Power Switch is in the “on” position.

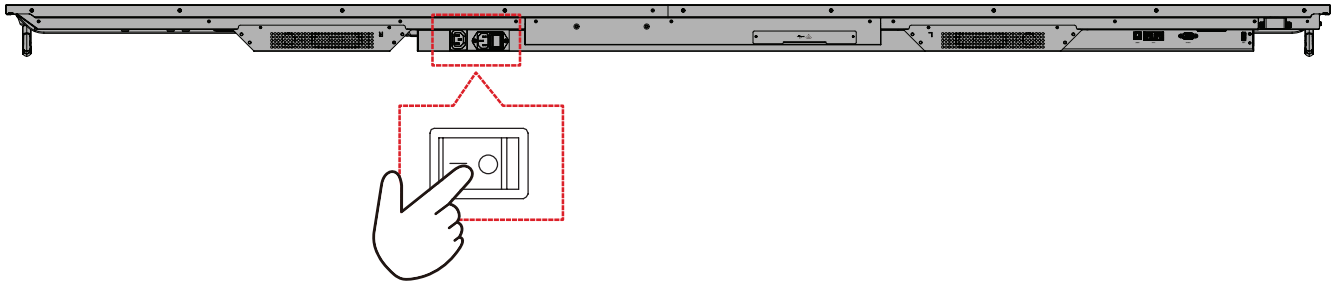

2. Press the  Power button to turn on the display.

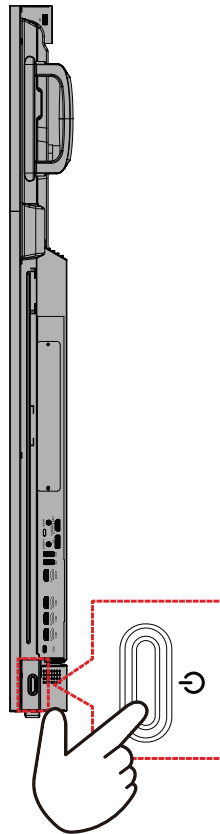

3. To turn the display off, press the  Power button.

Initial Launch Setup

When you first turn on your display, an initial setup wizard will launch.

1. Select your Language.

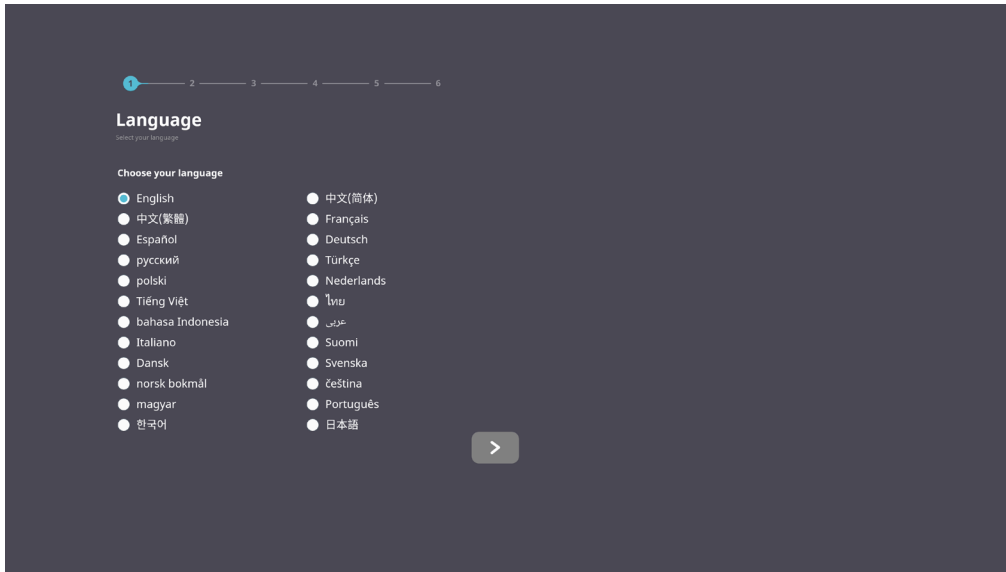

2. Select your Time Zone.

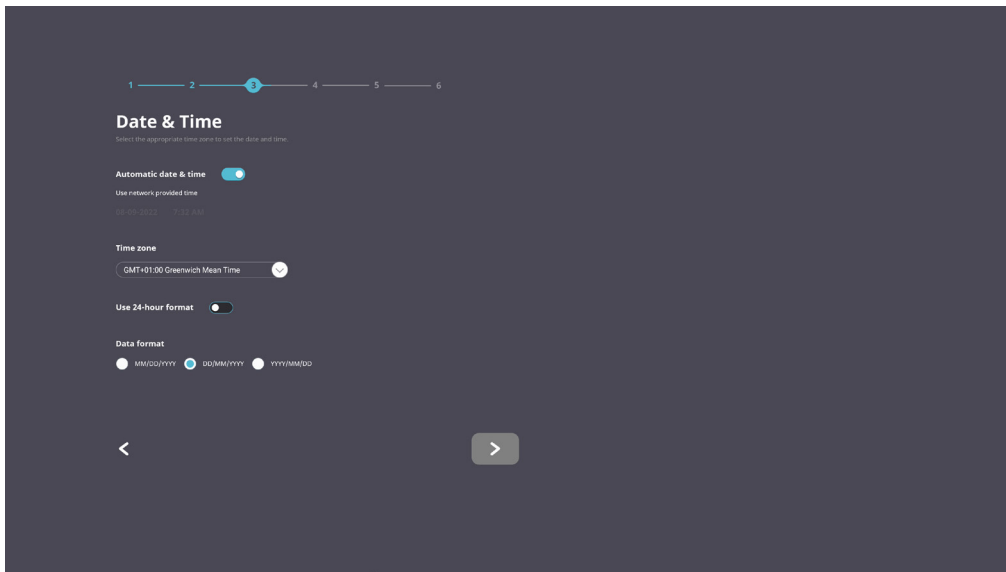

3. Select your Boot Mode.

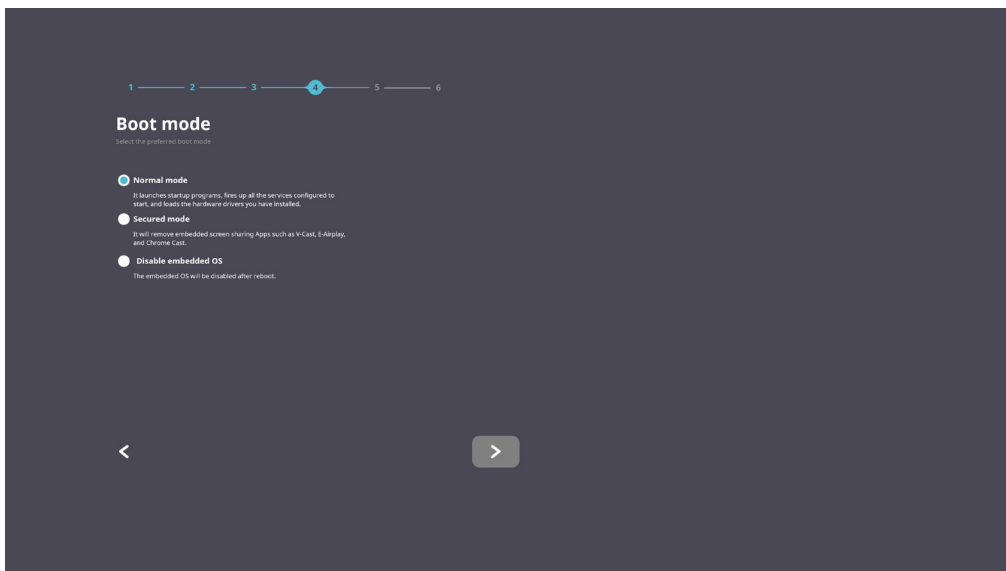

4. Select your Power Saving Mode.

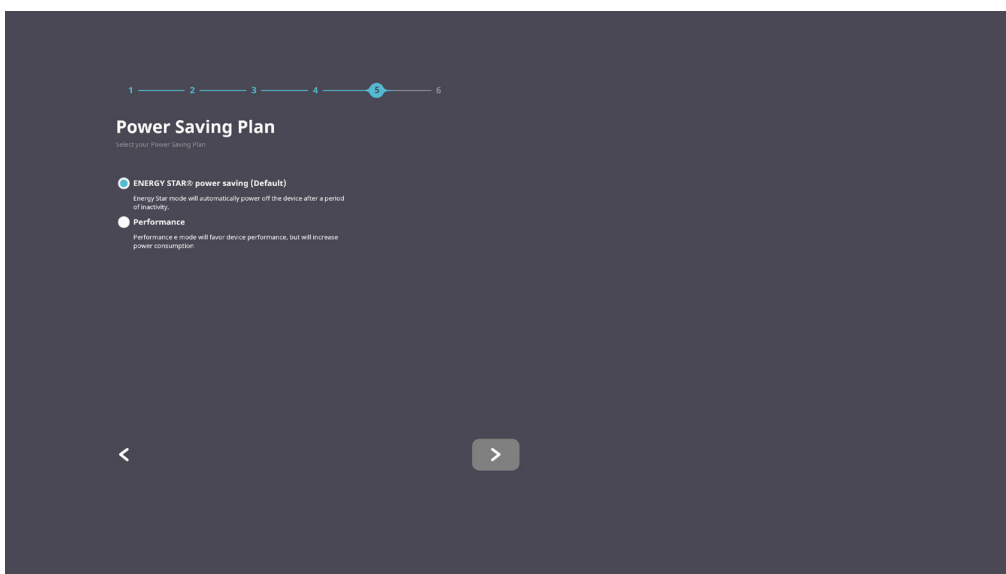

5. Accept or Decline Privacy and Copyright Protection.

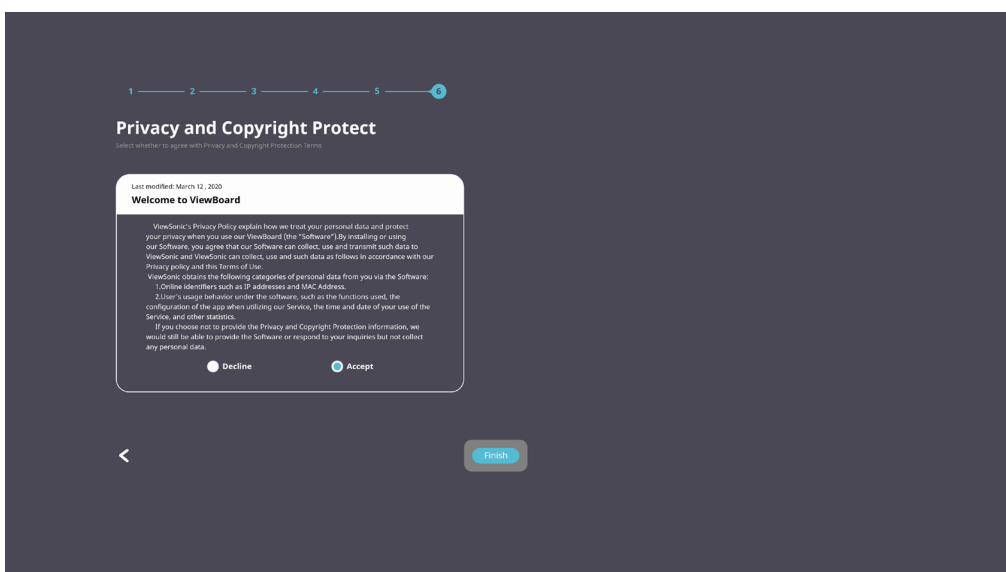

Home Screen

From the **Home Screen** all the installed applications can be accessed.

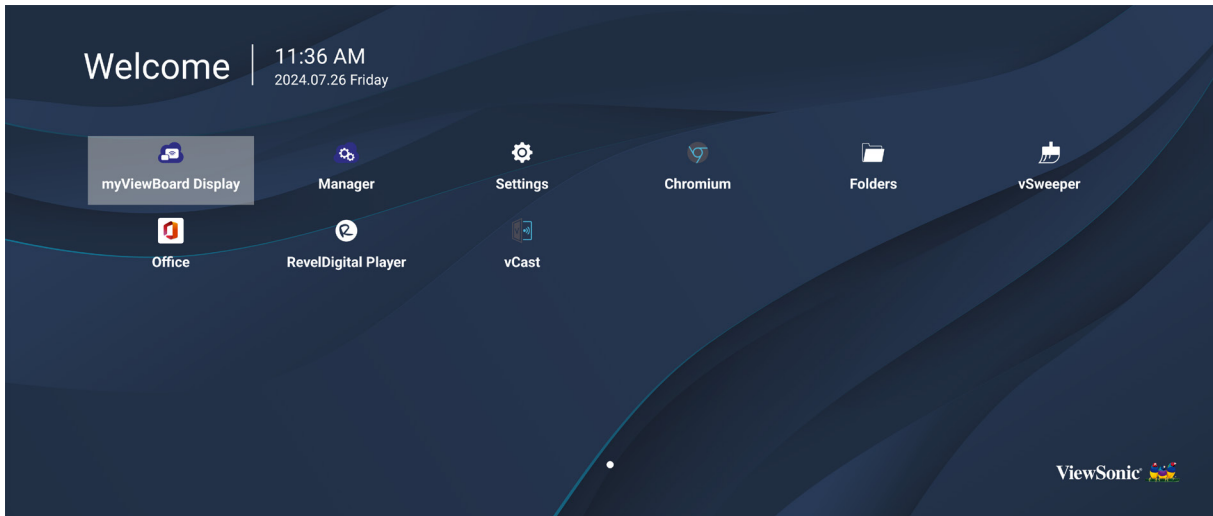

NOTE: Press the **Home** button on the remote control at any time to return to the **Home Screen**.

General Settings

Configure basic Network, Device, and System settings.

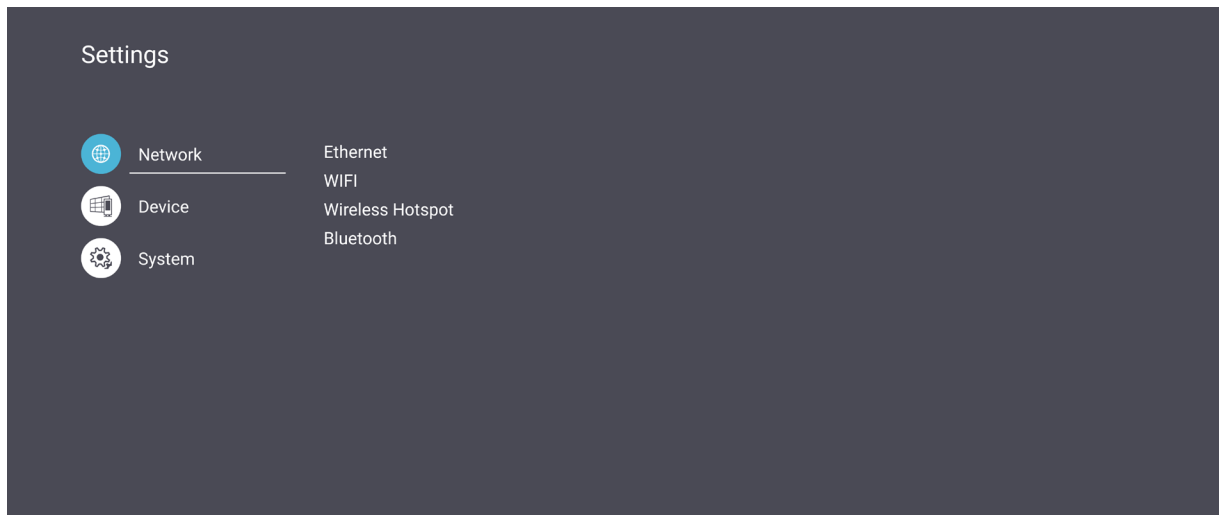

Network

Configure Ethernet, Wi-Fi, Wireless Hotspot, and Bluetooth settings.

Ethernet

- Enable/Disable Ethernet.

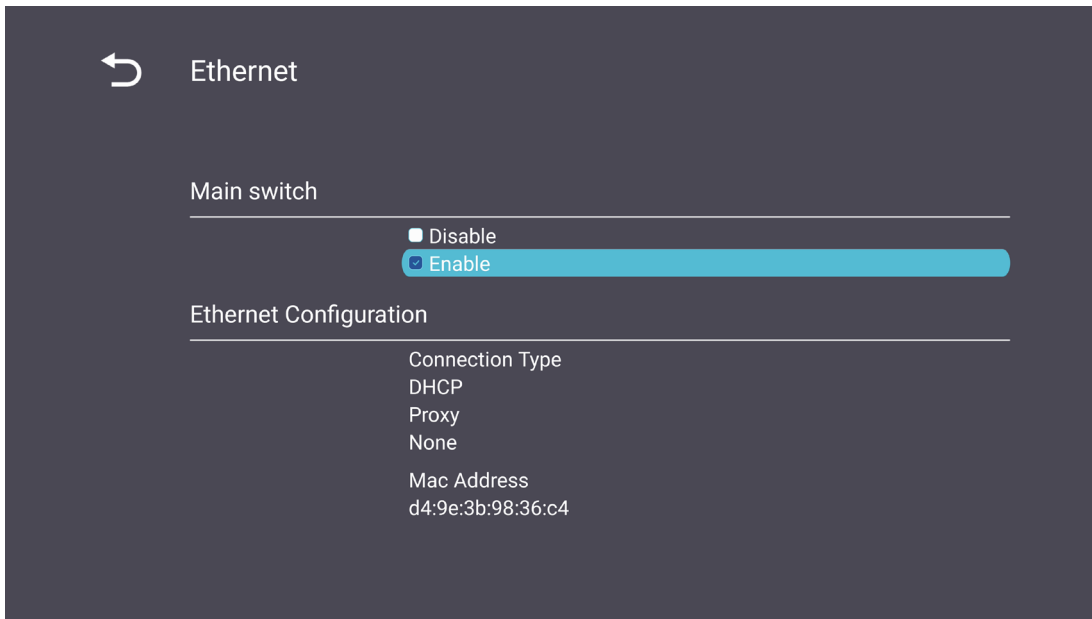

NOTE: After Ethernet is Enabled, the Connection Type and MAC Address will be available.

- Adjust the Connection Type.

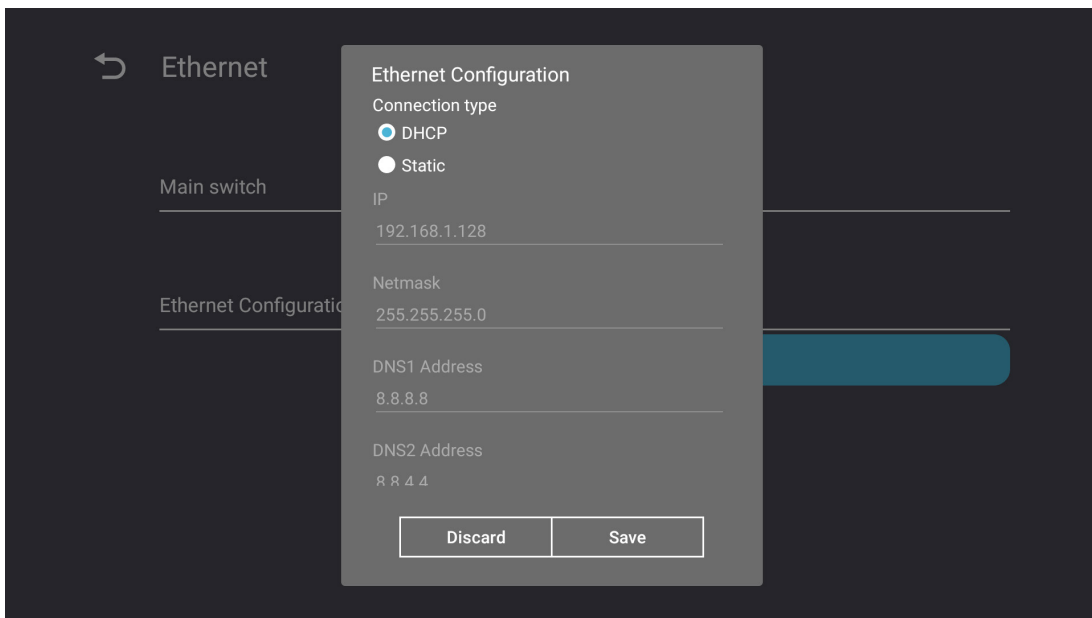

Connection Type	Description
DHCP	Cannot modify IP Address, Netmask, DNS Address and Gateway.
Static IP	Can input IP Address, Netmask, DNS Address and Gateway.

Wi-Fi

- Enable/Disable Wi-Fi.
- Add a Wi-Fi network or choose from the available listed.

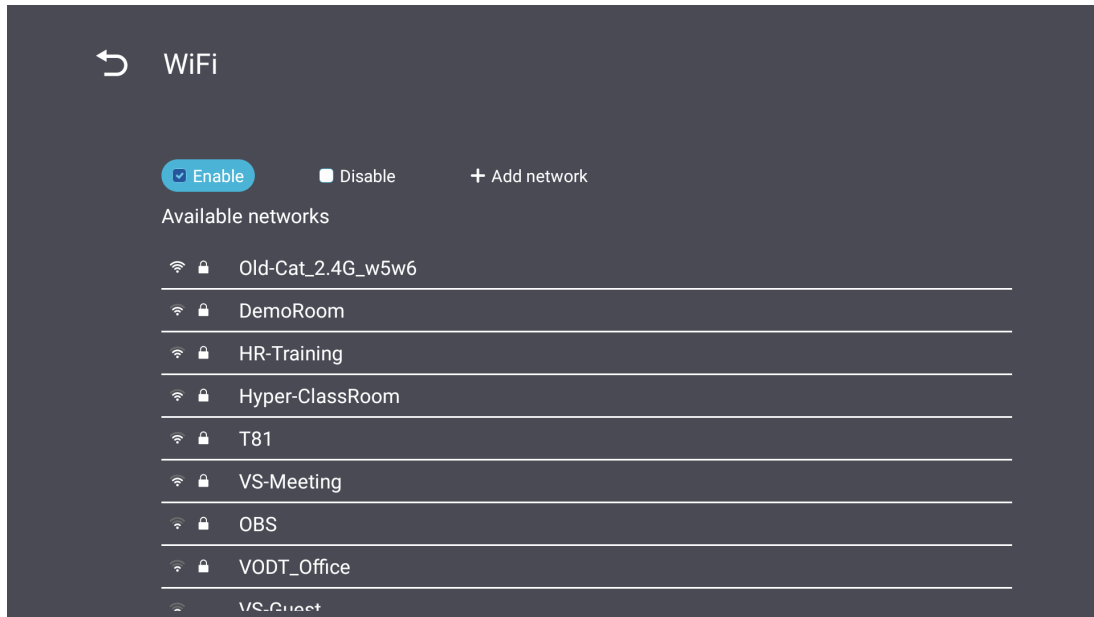

NOTE: After Wi-Fi is Enabled, available networks will be listed.

Wireless Hotspot

- Enable/Disable Wireless Hotspot.
- Share an internet connection with your devices once enabled.



Bluetooth

- Enable/Disable Bluetooth.

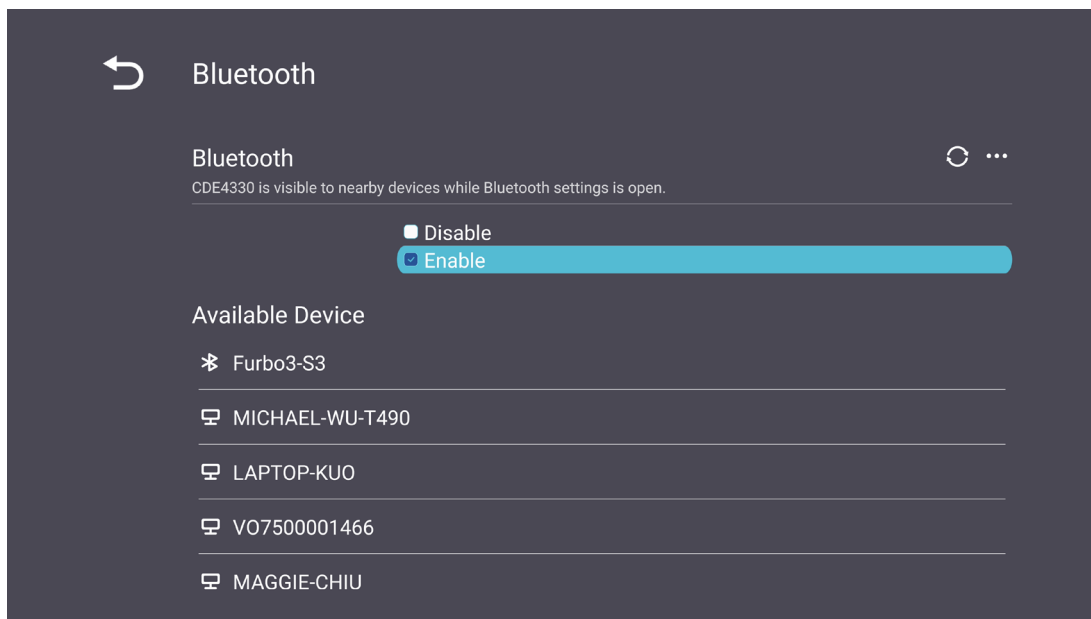

Device

Configure Signage Display, System Tools, Display, Apps, and Physical Keyboard settings.

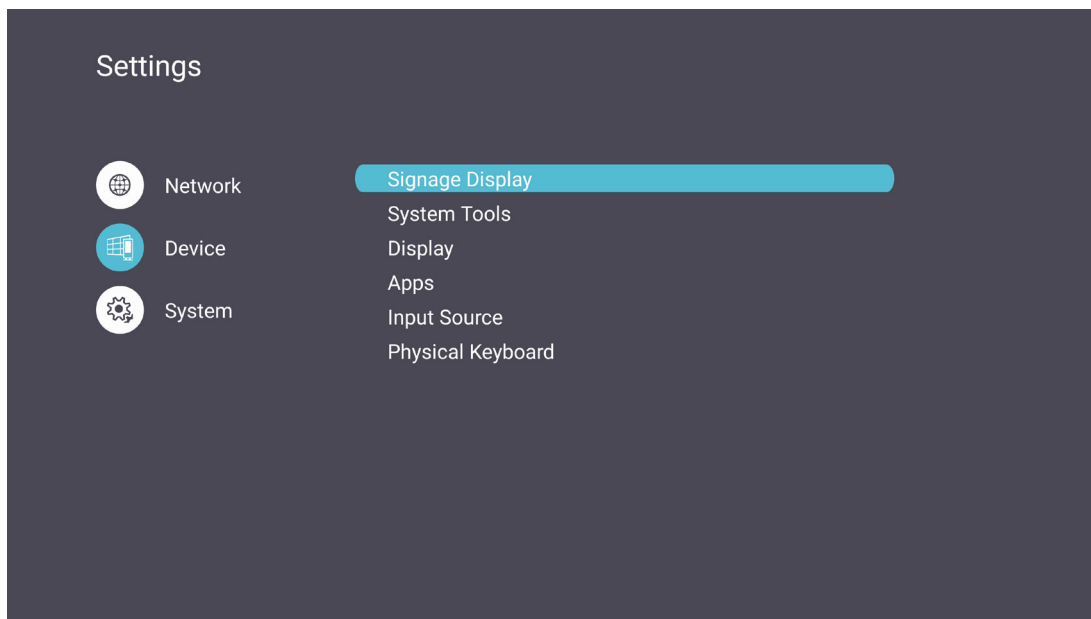

Signage Display

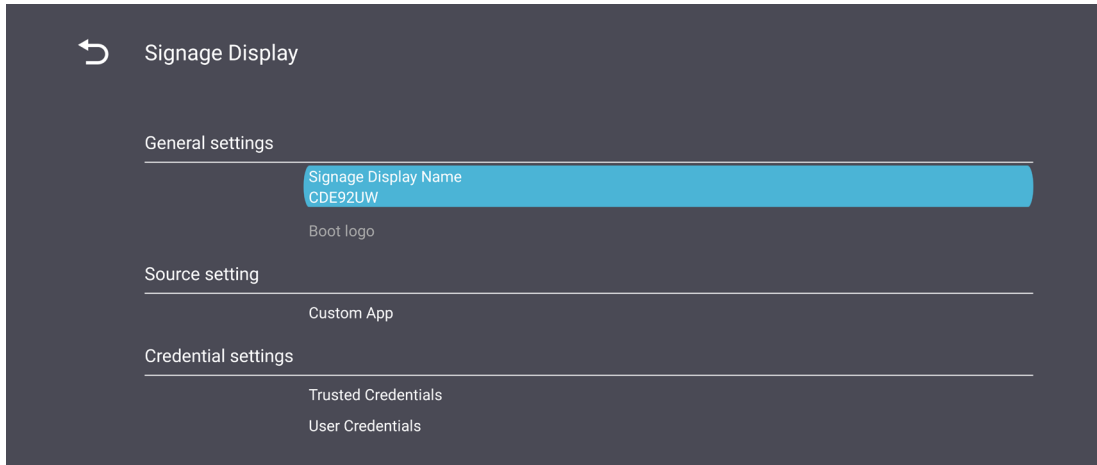

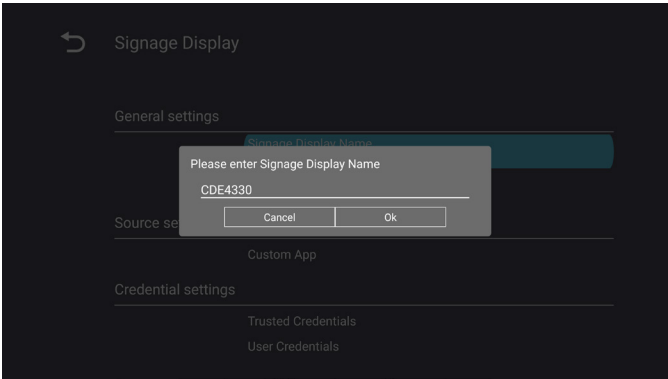
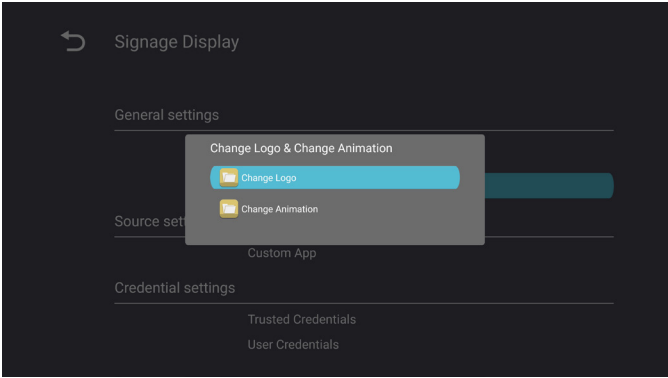
Item	Description
<p>General Settings</p>	<p><u>Signage Display Name</u></p> <p>Setup the display’s name. Maximum of 36 characters.</p>  <p><u>Boot Logo</u></p> <ul style="list-style-type: none"> • Enable/Disable the boot logo. • Select a custom boot logo or animation file.  <p>NOTE: Ensure “Boot on logo” in the Advanced settings of the OSD Menu is set to “User” to be able to select a custom boot logo or animation file.</p>

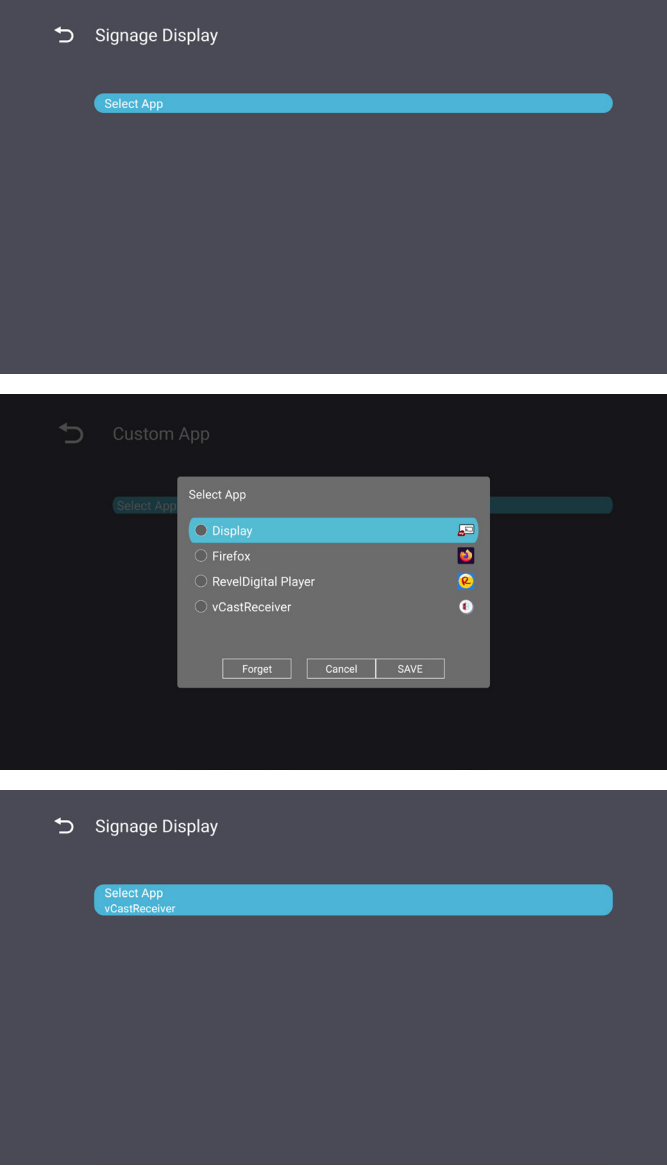
Item	Description
<p style="text-align: center;">Source Setting</p>	<p><u>Custom App</u></p> <p>Setup a custom .apk application for Custom input source. If a Custom App is setup, the display will open the App when the input source is changed to “Custom”.</p> 
<p style="text-align: center;">Security</p>	<p><u>External Storage</u></p> <p>Enable/Disable USB storage.</p> <p>NOTE: Re-insert any connected USB external storage device(s) after enabling.</p> <p><u>Unknown Sources</u></p> <p>Allow or don't allow the installation of unknown .apk files.</p>

System Tools

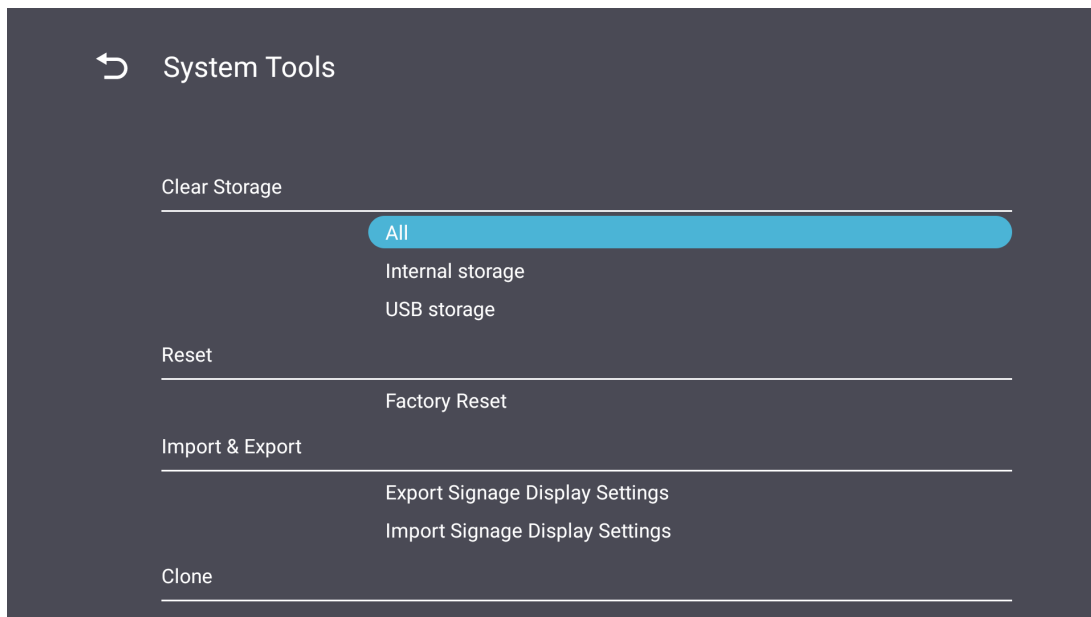

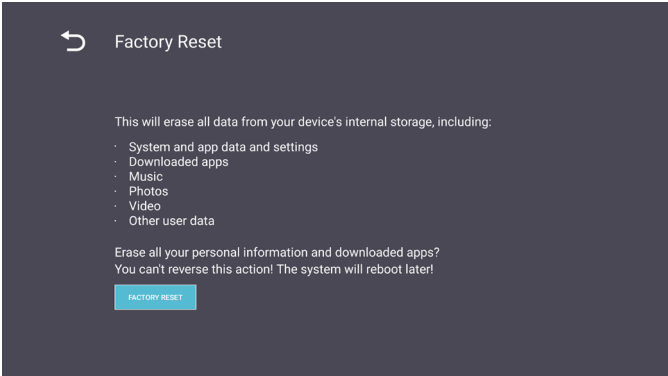
Item	Description
<p>Clear Storage</p>	<p><u>All</u> Clear all folder data.</p> <p><u>Internal Storage</u> Only clear internal storage folder data.</p> <p><u>USB Storage</u> Only clear USB storage folder data.</p>
<p>Reset</p>	<p><u>Factory Reset</u> Return to factory default settings.</p>  <p>The screenshot shows the 'Factory Reset' confirmation screen with the following text:</p> <p>This will erase all data from your device's internal storage, including:</p> <ul style="list-style-type: none"> · System and app data and settings · Downloaded apps · Music · Photos · Video · Other user data <p>Erase all your personal information and downloaded apps? You can't reverse this action! The system will reboot later!</p> <p>FACTORY RESET</p>

Item	Description
<p>Import & Export</p>	<p><u>Export Signage Display Settings</u> Export display settings to a USB.</p> <p>NOTE:</p> <ul style="list-style-type: none"> • The saved file name will be: vs8386SettingFile.txt • File will be saved in a folder titled “ViewSonic”. If one does not exist, it will be created. <p><u>Import Signage Display Settings</u> Import display settings from a USB.</p>
<p>Clone</p>	<div data-bbox="651 622 1321 994" data-label="Image"> </div> <p>Create a copy of media files from the internal storage folder “AutoPlayFiles”.</p> <p><u>Source</u> Choose the media files copy location (Internal Storage or USB).</p> <p><u>Target</u> Select Internal Storage or USB as the target for the copied media files.</p>

Display

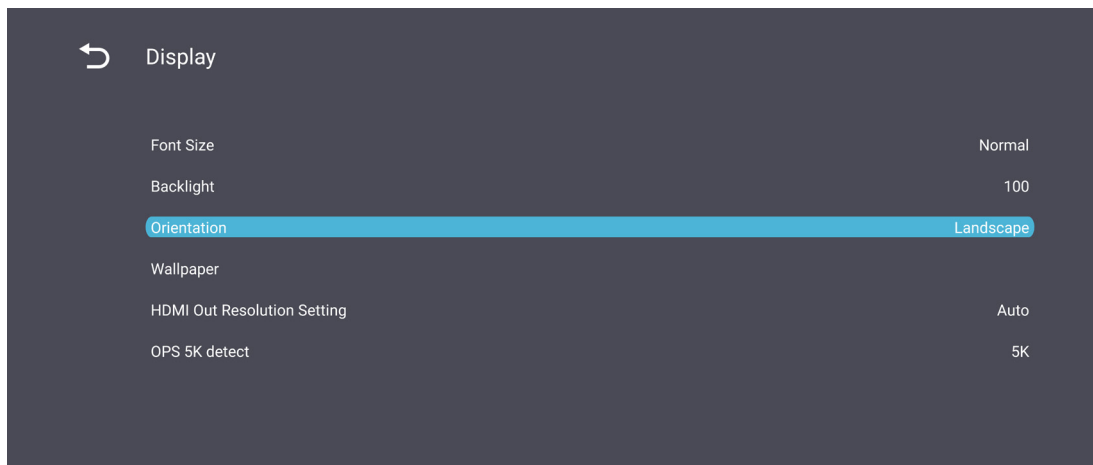

Item	Description
Font Size	Adjust the display's font size.
Backlight	Adjust the brightness of the display.
Orientation	Select landscape or portrait mode.
Wallpaper	Choose a background image for the display.

Apps

- View any running or installed applications. Select them for more detailed information and options.
- By selecting a running application, more information will be displayed, and the application can be stopped or reported.

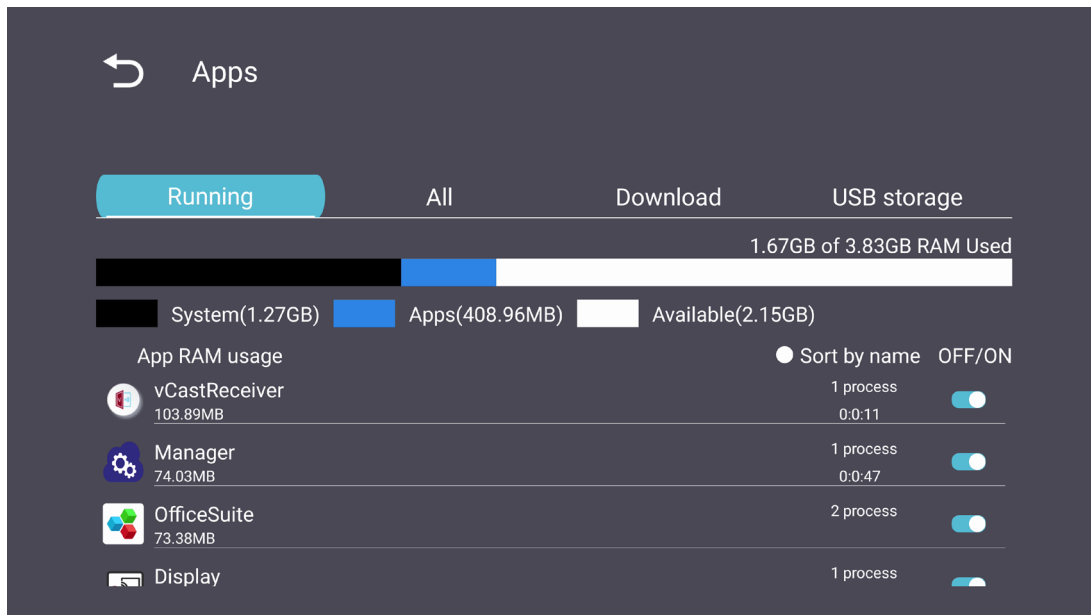

System

Date & Time

Set the time zone and Auto Time settings.

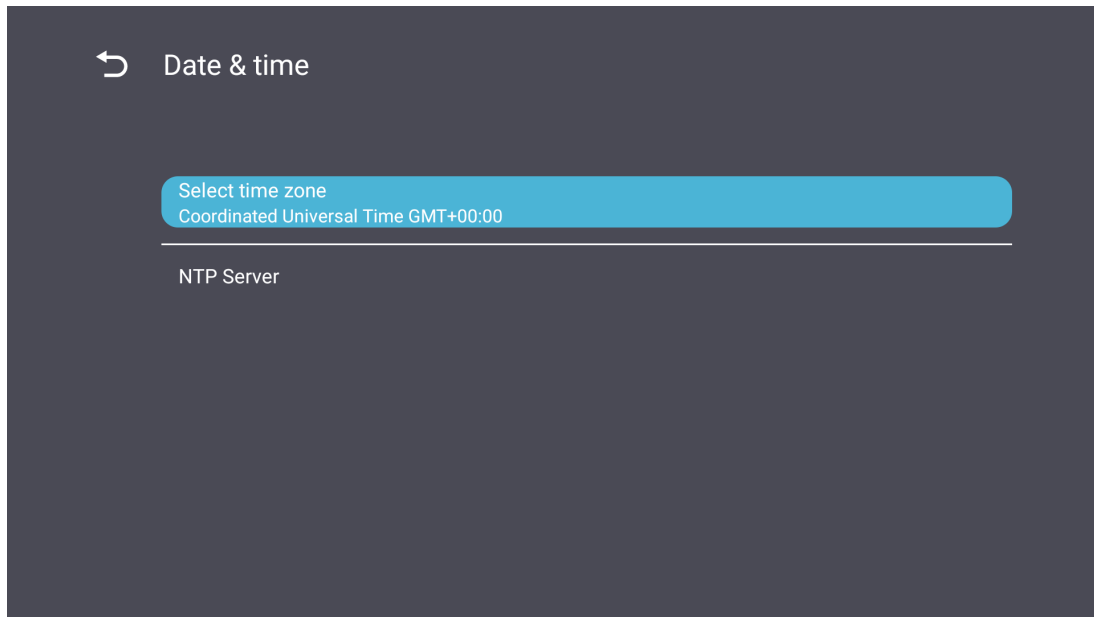

About

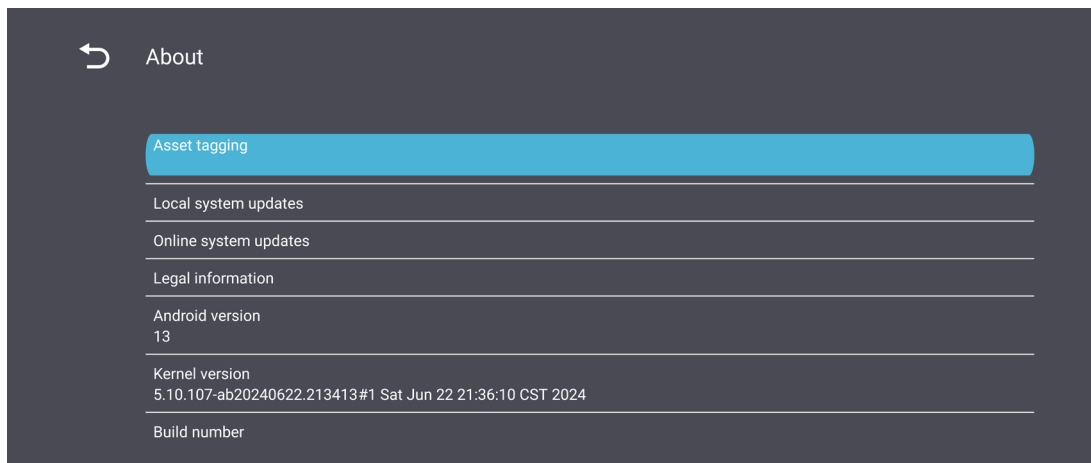

Item	Description
Online System Updates	When the display is off, the system will automatically check for a new version. If a new version is found, the system will automatically update. After the update is complete, the system will turn off.
Android Version	Current Android version information.
Kernel Version	Kernel version information.
Build Number	Build number information.

General Settings Menu Tree

Main Menu	Sub-menu	Menu Option	
Network	Ethernet	Enable/ Disable	
		Ethernet Configuration	Connection Type
			MAC Address
	Wi-Fi	Enable/ Disable	
		Add Wi-Fi	
	Wireless Hotspot	Enable/ Disable	
		Hotspot Configuration	
	Bluetooth	Enable/Disable	
		Available Devices	

Main Menu	Sub-menu	Menu Option		
Device	Signage Display	General Settings	Signage Display Name	
			Boot Logo	
		Source Setting	Custom App	
		Credentials Settings	Trusted Credentials	
			User Credentials	
			Install from Storage	
			Clear Credentials	
		Security	External Storage	
			Unknown Sources	
			Privacy and Copyright Protection	
			App Authority	
		System Tools	Clear Storage	All
				Internal Storage
	USB Storage			
	Reset		Factory Reset	
	Import & Export		Export Signage Display Settings	
			Import Signage Display Settings	
	Clone	Clone Media Files		
	Display	Font Size		
		Backlight		
		Orientation		
		Wallpaper		
	Apps			
Physical Keyboard				
System	Date & Time	Select Time Zone		
		NTP Server		
	About	Online System Updates		
		Legal Information		
		Android Version		
		Kernel Version		
		Build Number		

On-Screen Display (OSD) Menu

Access Picture, Screen, Audio, Time, Advanced, and About settings.

Navigating the OSD Menu using the Remote Control

1. On the remote control, press the **Settings** button (⋮) to display the OSD Menu.
2. Use the directional buttons, ▼/▲/◀/▶, to select menu items and adjust values.
3. Press the **Back** button (⏪) to go back to the previous menu.
4. Press the **Settings** button (⋮) again to exit the OSD Menu.

On-Screen Display (OSD) Menu Tree

Main Menu	Sub-menu		
Picture	Brightness	(0~100)	
	Contrast	(0~100)	
	Sharpness	(0~100)	
	Color	(0~100)	
	Color Temperature	Warm (7500K)	
		Normal (9300K)	
		Cool (10000K)	
		User	
	Picture Mode	Normal	
		Dynamic	
		Soft	
		User	
	Flicker Free	Off	
		On	
	Blue Light Filter	(0~100)	
Gamma Set	Native		
	2.2		
	2.4		
	DICOM		
Picture Reset	Cancel		
	Reset		
PIP	Sub Mode	Off	
		PIP	
		PBP	
	PIP Size		
	PIP Position		
	PIP Source		
	PIP Audio		
PIP Reset			

Main Menu	Sub-menu		
Audio	Balance	(0~100)	
	Treble	(0~100)	
	Bass	(0~100)	
	Volume	(0~100)	
	Maximum Volume	(0~100)	
	Minimum Volume	(0~100)	
	Mute	Off	
		On	
	Volume Control	Speaker	
		Audio Out	
		Sync	
	Audio Out Sync	Enable	
		Disable	
	Audio Out Volume (Line Out)	(0~100)	
	Audio Reset	Cancel	
Reset			

Main Menu		Sub-menu		
Time	Off Timer	Off		
		1 hour~24 hours		
	Date and Time	Set Date		
		Set Time		
		Choose Time Zone		
		Use 24-hour Format		
		Schedule List		
	Schedule	Enable		
		Start Time		
		End Time		
		Input		
		HDMI 1		
		HDMI 2		
		AV		
		USB Auto Play		
		Custom		
		Day of the Week		
		Every Week		
		OSD Turn Off	Off	
	5 seconds~120 seconds			
Display Information	Off			
	1 second~60 seconds			
Time Reset	Cancel			
	Reset			
Advanced	Saving	Panel Saving	Brightness	Off
			On	
	Power Save	Mode 1		
		Mode 2		
		Mode 3		
	Power LED Light	Off		
On				

Main Menu	Sub-menu		
Advanced	Boot	Boot On Source	Last Input
			HDMI 1
			HDMI 2
			AV
			USB Auto Play
			Custom
	Boot On Logo	Off	
		On	
		User	
	Signal	Auto Signal Detection	Off
			On
		No Signal Standby	Off
			0 min
			5 min
			15 min
	30 min		
	Port	HDMI with One Wire	Off
			On
		USB Cloning	Import
			Export
		USB Auto Play	Off
			On
	Others	Switch On State	Power Off
			Fored On
			Last Status
		WOL	Off
			On
		Monitor ID	Monitor ID: 1~98
		Language	
		Factory Reset	Cancel
			Reset
		Advanced Option Reset	Cancel
Reset			

Main Menu	Sub-menu	
About	Heat Status	xx° C / xx° F
	Display Information	Model Name
		Serial No.
		Operation Hours
		SW Version

Picture

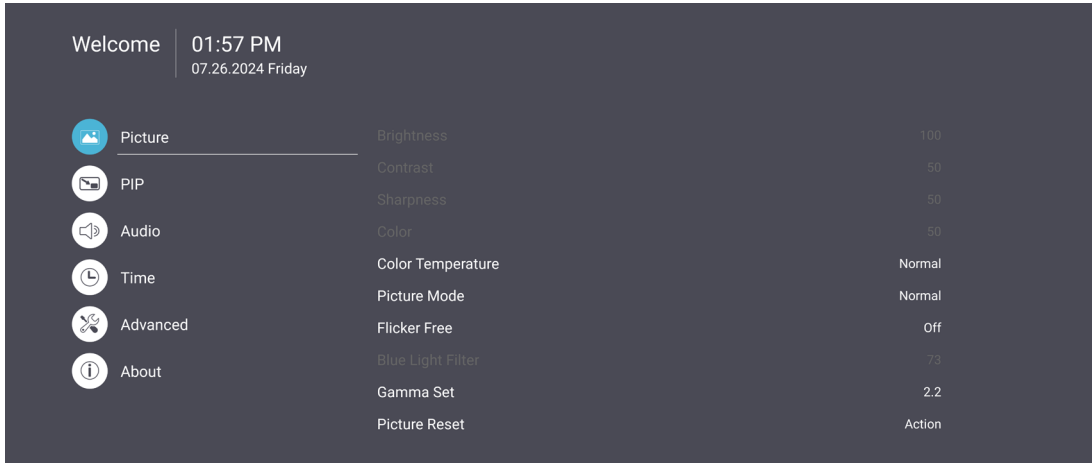

Item	Description
Brightness	Adjust the background black levels of the screen image.
Contrast	Adjust the degree of difference between the lightest and darkest parts of the picture and change the amount of black and white in the image.
Sharpness	Adjust the picture quality.
Color	Adjust the amount of color present.
Color Temperature	Adjust the color temperature.
Picture Mode	Select a predefined picture setting.
Flicker Free	When enabled, reduces or eliminates screen flicker, thus easing potential eye strain.
Blue Light Filter	Adjusts the filter that blocks high-energy blue light for a more comfortable viewing experience.
Gamma Set	Manually adjust the brightness level of the monitor's grayscale levels.
Picture Reset	Reset all Picture menu settings to default.

Low Blue Light Filter and Eye Health

The Blue Light Filter blocks high-energy blue light for a more comfortable viewing experience.

Calculating Breaks

When viewing screens for extended periods, it is recommended to take periodic breaks from viewing. Short breaks of at least 10 minutes are recommended after one hour of continuous viewing.

Taking shorter, more frequent breaks are generally more beneficial than longer, less frequent breaks.

Focus Fatigue (20-20-20 Rule)

To reduce the risk of eye fatigue by constantly looking at the screen, look away from the screen at least every 20 minutes and gaze at a distant object (at least 20 feet away) for at least 20 seconds.

Looking at Distant Objects

While taking breaks, users can further reduce eye strain and dryness by focusing on objects that are further away from them for 10-15 seconds, then gaze at something up close for 10-15 seconds. Repeat this up to 10 times. This exercise reduces the risk of your eyes' focusing ability to "lock up" after prolonged computer work.

Eye and Neck Exercises

Eye Exercises

Eye exercises can help minimize eye strain. Slowly roll your eyes to the left, right, up, and down. Repeat as many times as needed.

Exercises for the eyes

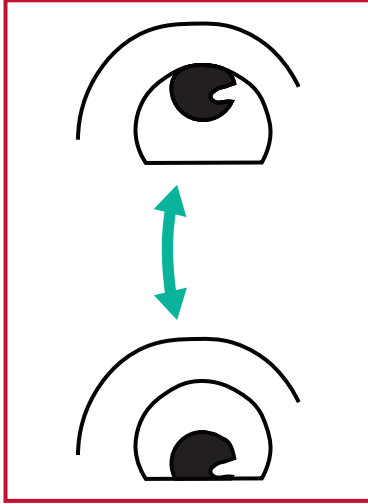

(1) Keep the body and the head upright. Move the eyes up to look at the ceiling, then turn down to look at the floor.

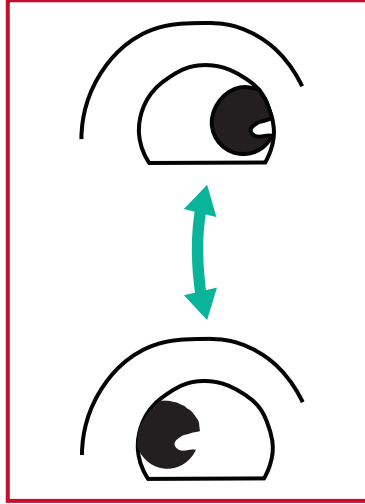

(2) Move the eyes left and right slowly to look at objects on the two sides.

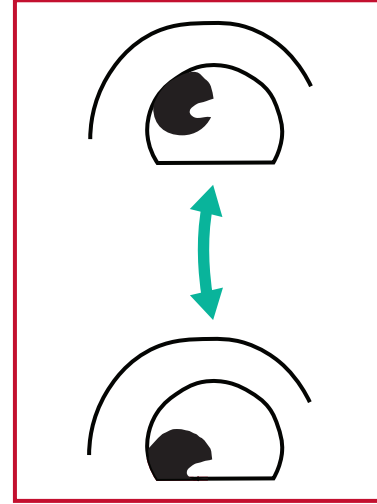

(3) Move the eyes to look at objects at the right upper direction and then right lower direction. Repeat for the left upper and left lower directions.

Neck Exercises

Neck exercises can also help minimize eye strain. Relax your arms and let them hang at your sides, bend forward slightly to stretch the neck, turn your head to the right and to the left. Repeat as many times as needed.

Flicker-Free

The display uses DC-adjustable backlighting, which does not produce a visible or invisible flicker within the 0~3000 Hz range and therefore can reduce eye fatigue.

PIP

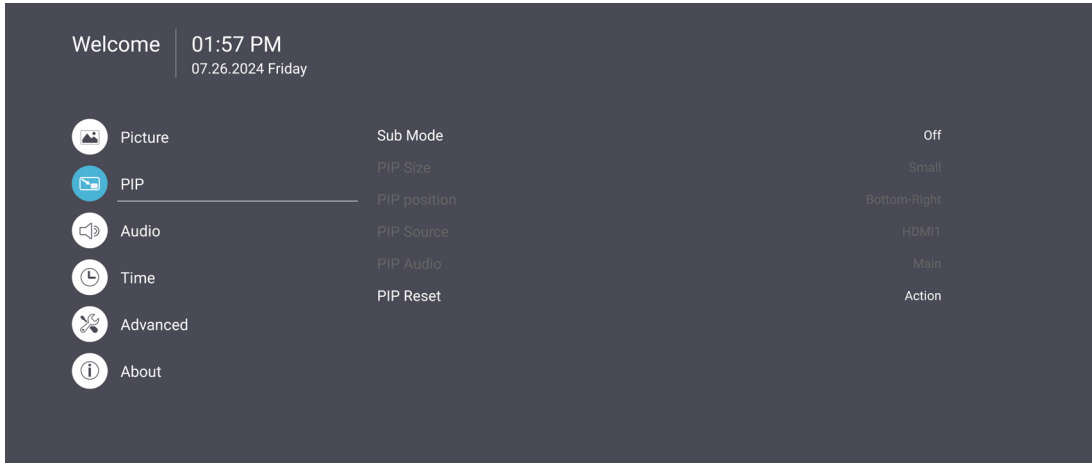

Item	Description
Sub Mode	Select the PIP (Picture-in-Picture) mode. Choose from: Off, PIP, PBP.
PIP Size	Select the size of the sub picture in the PIP (Picture-in-Picture) mode. Choose from: Small, Medium, Large.
PIP Position	Select the position of the sub picture in the PIP (Picture-in-Picture) mode. Choose from: Bottom-Right, Bottom-Left, Top-Right, Top-Left.
PIP Source	Select the input signal for the sub-picture.
PIP Audio	Select the audio source for the Sub Mode. <ul style="list-style-type: none"> • Main - Select audio from the main picture • Sub - Select audio from the sub-picture.
PIP Reset	Reset all settings in the PIP menu to factory preset values.

Using PBP (Split-Screen Mode) with an Application

Before using PBP (Split-Screen Mode), it is necessary to set the application source. To set the application source:

1. From General Settings, go to: **Device > Signage Display > Source Setting > Custom App**.

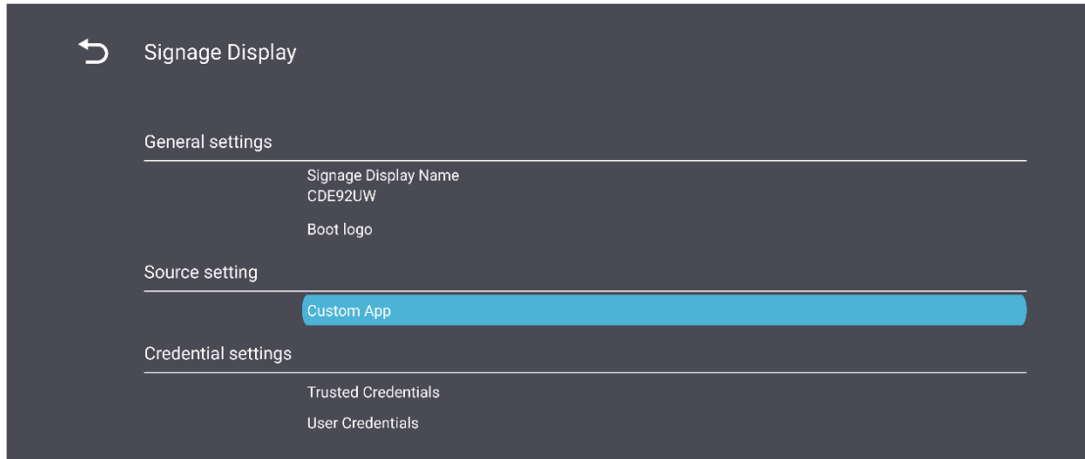

2. Select the application for PBP use.

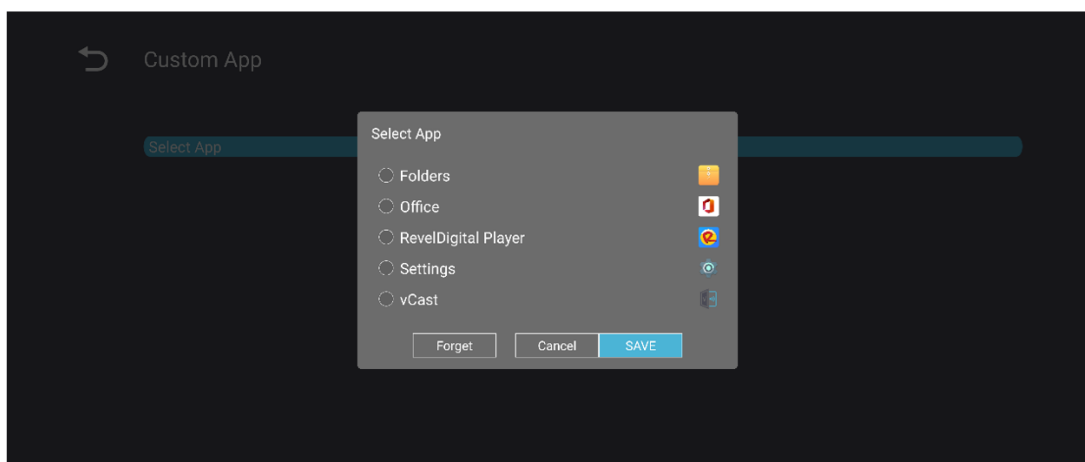

To use PBP (Split-Screen Mode):

1. From the On-Screen Display (OSD) Menu, go to: **PIP > Sub Mode > select PBP.**

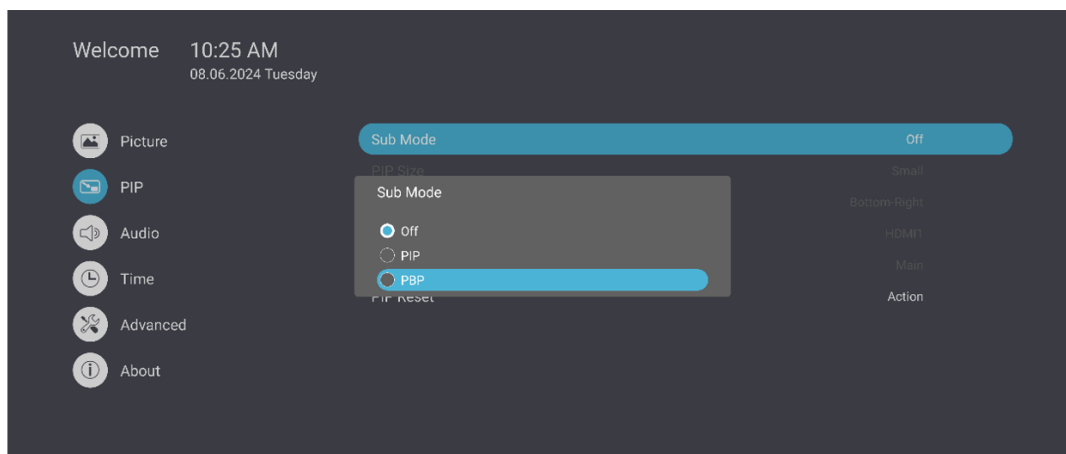

2. For the PIP Source, select **Custom**.

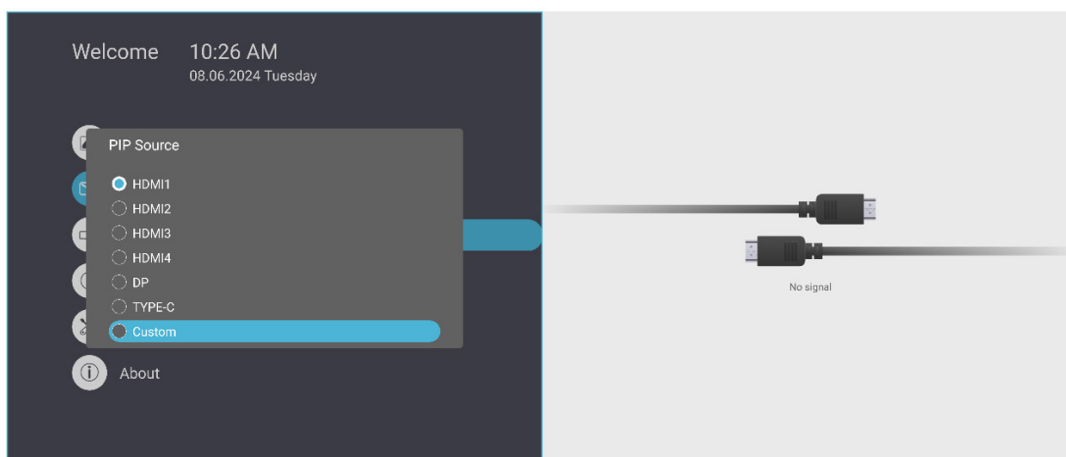

NOTE: To switch the application window, press the Green/Tab button on the remote control.

Audio

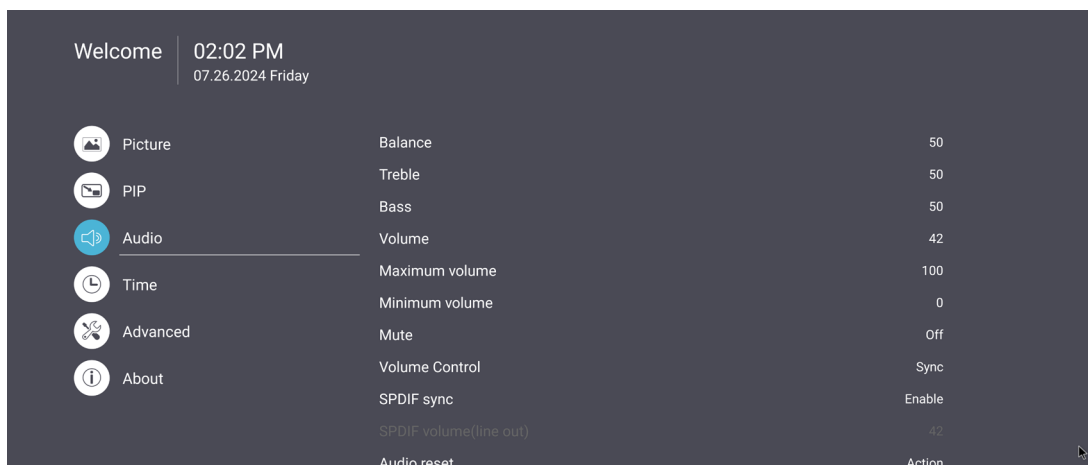

Item	Description
Balance	Adjust the left/right speaker balance.
Treble	Increase/decrease the treble level (higher-pitched sounds).
Bass	Increase/decrease the bass level (lower-pitched sounds).
Volume	Increase/decrease the display's volume level.
Maximum Volume	Set the maximum volume level.
Minimum Volume	Set the minimum volume level.
Mute	Mute the volume.
Volume Control	Select audio source from internal speaker or Audio Out port.
Audio Out Sync	Sync Audio Out volume with the display's speakers.
Audio Out Volume (Line Out)	Increase/decrease the Audio Out volume.
Audio Reset	Reset all Audio menu settings to default.

Time

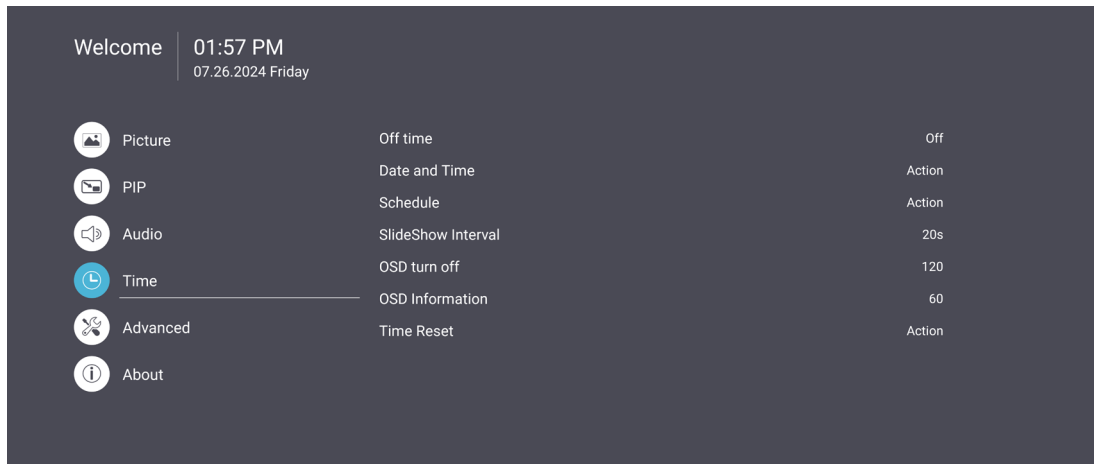

Item	Description
Off Time	Set the auto power off time.
Date and Time	Adjust the date and time of the display.
Schedule	Set up to seven (7) different time intervals for the display to be active.
Slide Show Interval	Set the photo slide show interval for USB auto play.
OSD Turn Off	Set the time period the OSD Menu stays on the screen.
OSD Information	Set the time period the OSD information will be displayed in the upper left corner of the display.
Time Reset	Reset all Time menu settings to default.

Advanced

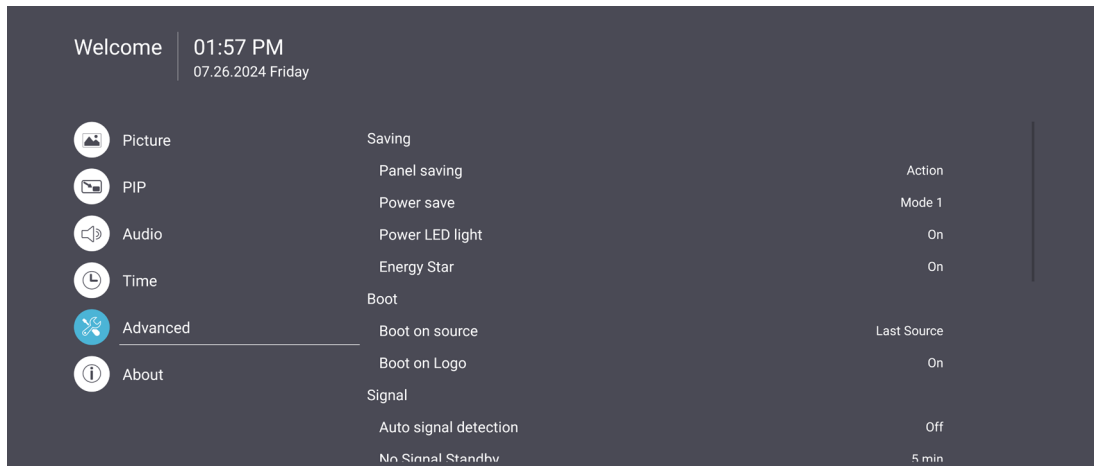

Item	Description
Panel Saving	Reduces the risk of Image Burn-in when enabled.
Power Save	Reduce power consumption. <u>Mode 1</u> TCP off, WOL on. <u>Mode 2</u> TCP off, WOL on, wake up by video signal resume. <u>Mode 3</u> TCP on, WOL off, wake up by video signal resume. <u>Mode 4</u> TCP on, WOL off, no wake up by video signal resume support.
Power LED Light	Turn On/Off the Power LED indicator.
Boot on Source	Select the input source after boot up.
Boot on Logo	Enable/Disable a logo when the display is turned on. <u>Off</u> Neither the ViewSonic nor animation logo will show. <u>On</u> The ViewSonic logo and animation will show. <u>User</u> If a custom logo option is set in General Settings , then the custom logo will show. If there is no custom logo set then no logo will show. For more information, see page 39.
Auto Signal Detection	Let the display detect and display available input sources automatically.
No Signal Standby	Set the time period to enter Standby Mode when there is no signal.

Item	Description
HDMI with One Wire	<p>Enable/Disable CEC (Consumer Electronics Control).</p> <p>CEC synchronizes power on/off operation via HDMI connection. That is, if a device that also supports CEC is connected to the HDMI input of the display, when the display's power is turned off, the power of the connected device will also be turned off automatically. When the power of the connected device is turned on, the display's power will be turned on automatically.</p>
USB Cloning	Save the OSD Menu configuration to the USB storage.
USB Auto Play	If set to ON, the display will copy media files from the external USB storage to the display's internal storage then play the media files automatically.
Switch on State	<p>Select the display status for the next time the power cord is connected to a power outlet.</p> <p><u>Power Off</u></p> <p>The display will remain off when the power cord is connected.</p> <p><u>Forced On</u></p> <p>The display will turn on when the power cord is connected.</p> <p><u>Last Status</u></p> <p>The display will return to the previous power status.</p>
WOL	Enable/Disable the Wake on LAN (WOL) feature.
Monitor ID	<p>Assign a number to remote control the display by RS-232.</p> <p>NOTE: The number range is: 1~98; 99 is reserved for "All Displays".</p>
Language	Select OSD Menu language.
Factory Reset	Reset all OSD Menu settings to default.
Advanced Reset	Reset all Advanced menu settings to default.

About

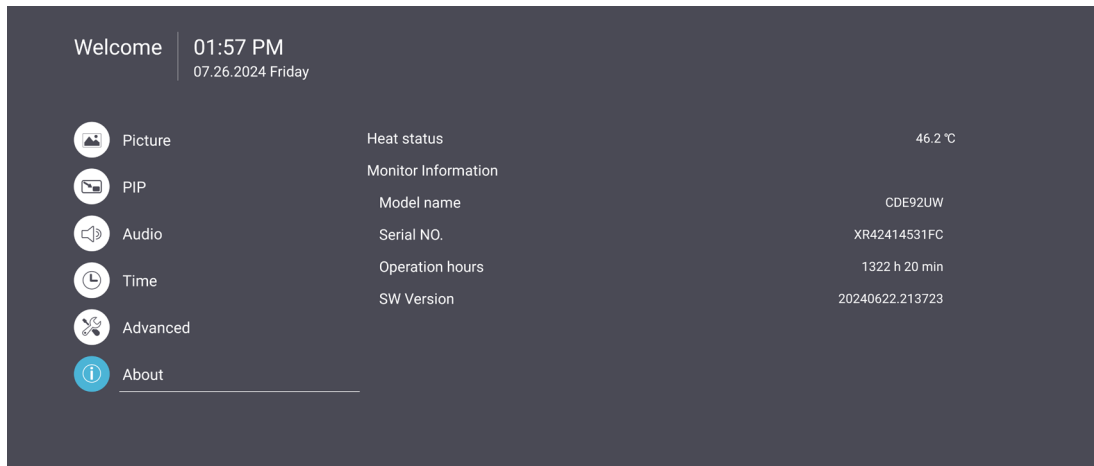

Item	Description
Heat Status	Check the temperature of the display.
Monitor Information	See information about the display: Model Name, Serial No., Operation Hours, and Software Version.

Pre-installed Applications and Settings

myViewBoard Display

Wirelessly mirror screens to a larger display.

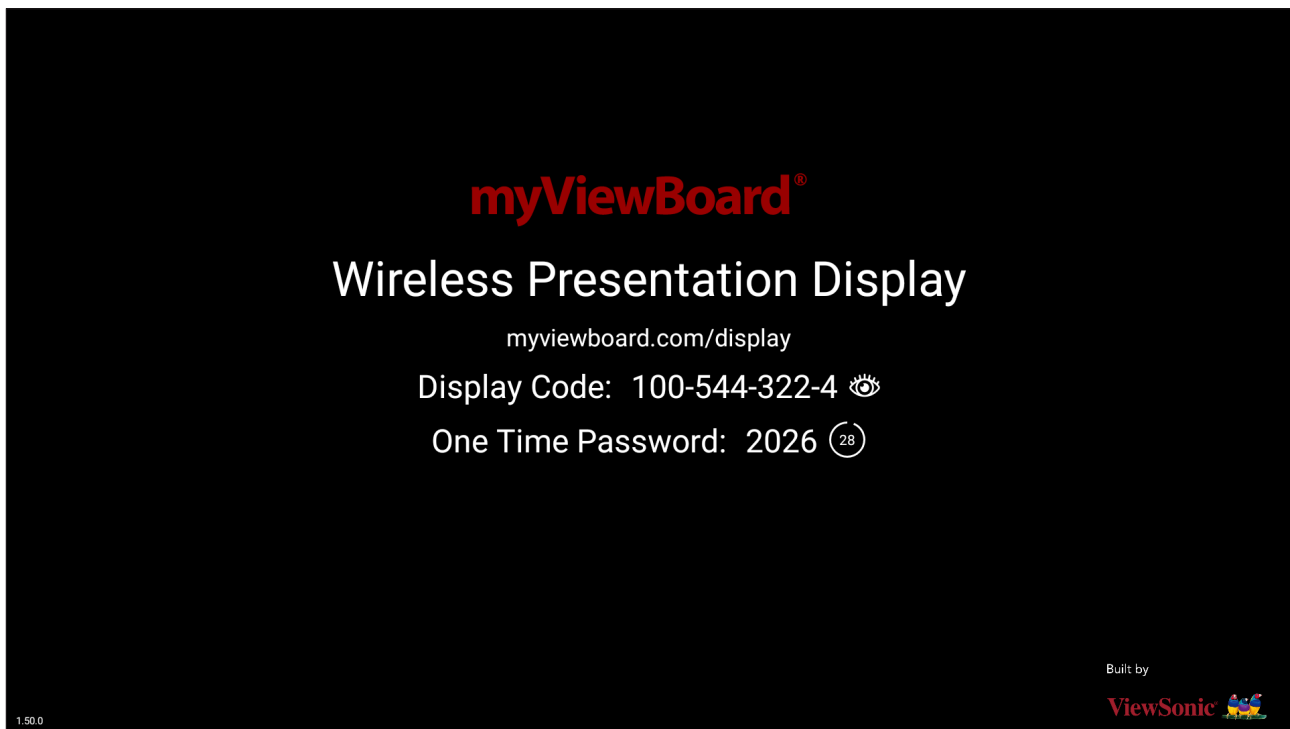

To share a screen to a ViewBoard with myViewBoard Display:

1. Open myViewBoard Display on the ViewBoard you want to share your screen to.
2. On the device you want to share the screen from, go to: <https://myviewboard.com/display>.
3. Enter the **Display Code** and **One Time Password** for the ViewBoard you wish to share to.

NOTE: Note that the password refreshes every 30 seconds.

myViewBoard Manager

Remotely manage multiple installations of ViewSonic devices.

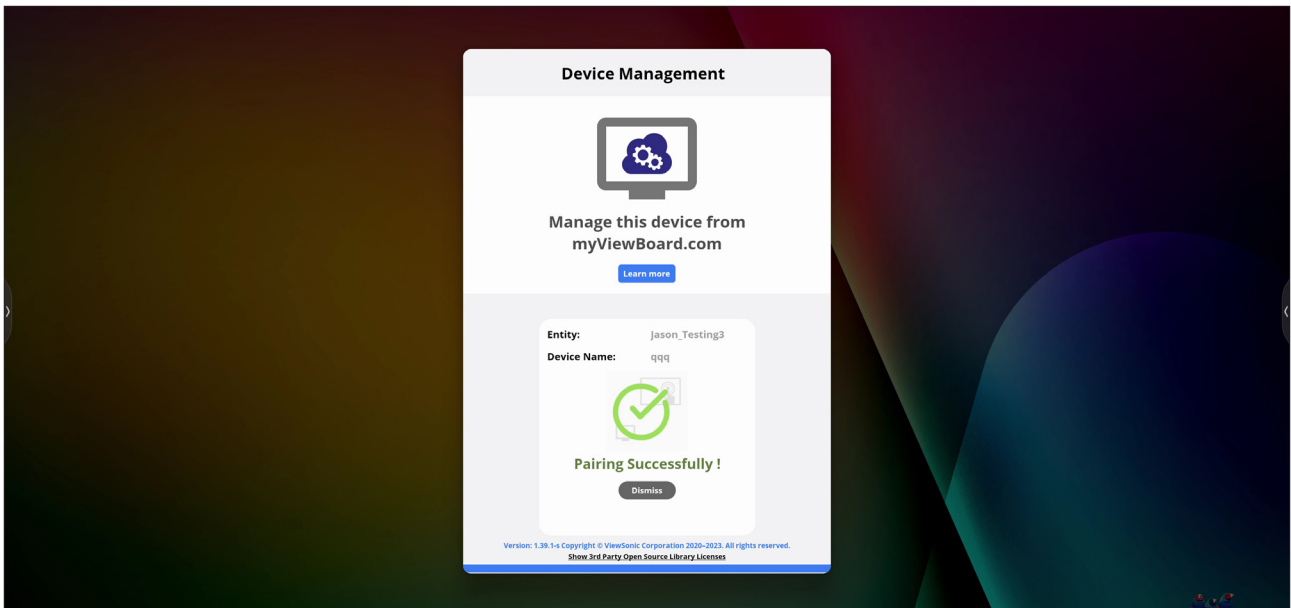

Once devices are set up and have myViewBoard Manager installed, they can be added to the entity and managed remotely from the Manager web application.

NOTE: Only available to Entity Admins from myviewboard.com after signing in.

Add a Device

On the device to manage:

1. Download and install myViewBoard Manager.
2. Open myViewBoard Manager and note the 6-digit PIN displayed.

In the myViewBoard Manager web application on myviewboard.com:

1. Click **Add Device**.
2. Input the 6-digit PIN obtained earlier.
3. Name the device (if applicable).
4. Click **Add**.

vCast

Working with ViewBoard® Cast software (vCast, vCast Pro, and vCastSender), the vCast application will allow the ViewBoard to receive laptop screens (Windows/Mac/Chrome) and mobile (iOS/Android) users' screens, photos, videos, annotations, and camera(s) that are using the vCastSender application.

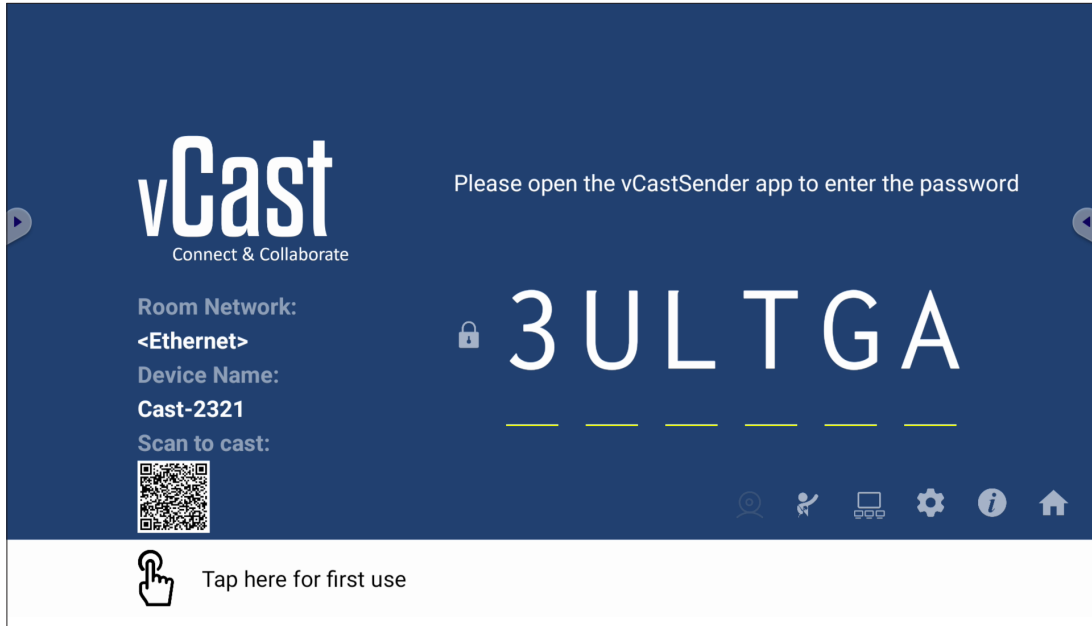

Network Information

- ViewBoard® Cast software, laptops, and mobile devices can connect to both the same subnet and cross subnet by entering the on-screen PIN code.
- Connected devices will show up under **Device List** on the same subnet connection.
- If the device does not show up under **Device List**, users will need to key-in the on-screen PIN code.
- **Ports:**
 - » TCP 56789, 25123, 8121 & 8000 (Controlling message port & client device audio transfer)
 - » TCP 8600 (BYOM)
 - » TCP 53000 (Request share screen)
 - » TCP 52020 (Reverse control)
 - » TCP 52025 (Reverse control for ViewBoard Cast Button)
 - » TCP 52030 (Status sync)
 - » TCP 52040 (Moderator mode)
 - » UDP 48689, 25123 (Device searching and broadcast & client device audio transfer)
 - » UDP 5353 (Multicast search device protocol)
- **Port and DNS for Activation:**
 - » Port: 443
 - » DNS: <https://vcastactivate.viewsonic.com>
- **OTA Service**
 - » Server Port: TCP 443
 - » Server FQDN Name: <https://vcastupdate.viewsonic.com>

Display Group Settings

To adjust the Display Group Settings, select the Display Group icon (🖥️) located in the lower-right corner of the screen.

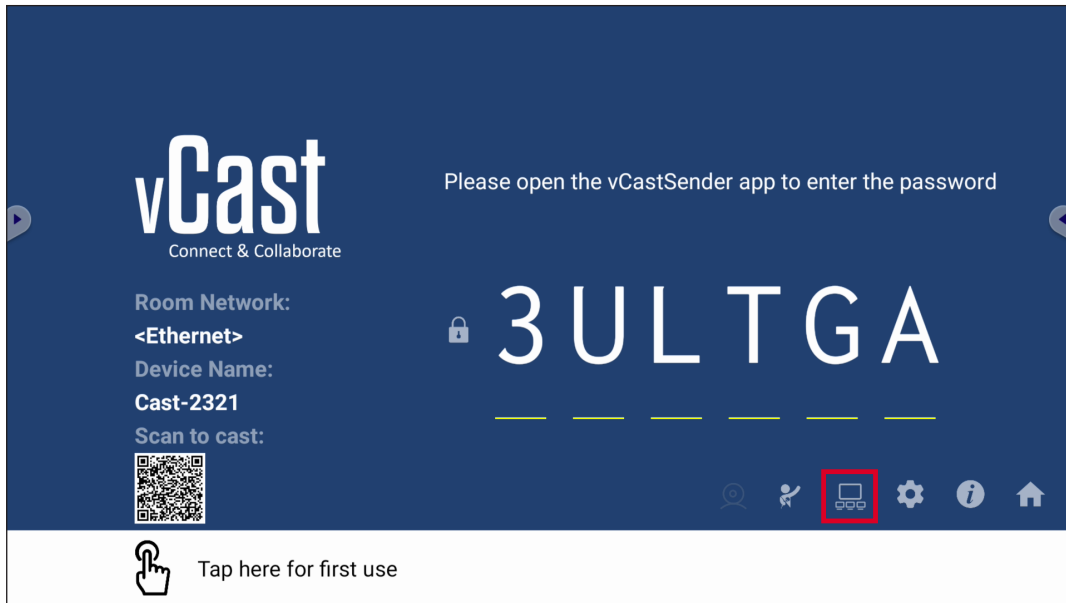

1. Toggle the “Turn On/Off Display Group” ON to enable the Display Group feature.

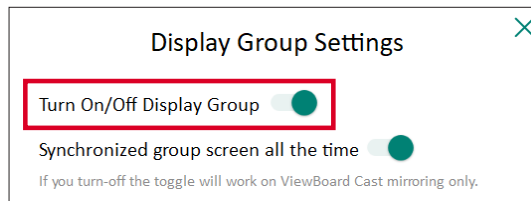

NOTE: Other preinstalled ViewBoard Cast devices in the same network will be listed.

2. Select the devices you want to join the display group and select **OK** to save the settings.

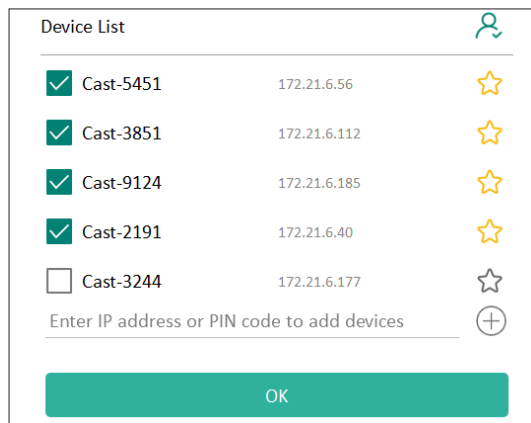

NOTE:

- If the devices you want to group are not listed, you can enter their respective IP address or connecting PIN code.
- The Display Group maximum device limit is six devices.

3. If you frequently connect to the same device, you can select the Star icon (☆) next to the device to add it to your frequently connected devices list, “My List of Devices in Group”, for easier Display Group setup and management.

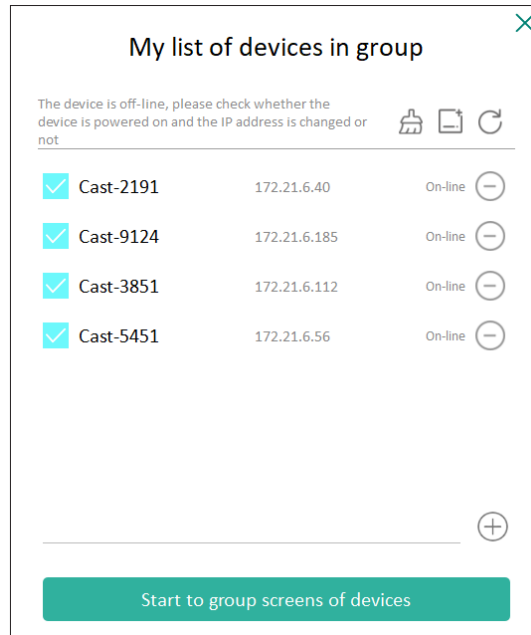

Synchronized Group Screen All the Time

When the “Synchronized group screen all the time” function is toggled ON, it will display a synchronized group screen continuously. If it is toggled OFF, it will work on vCast mirroring only.

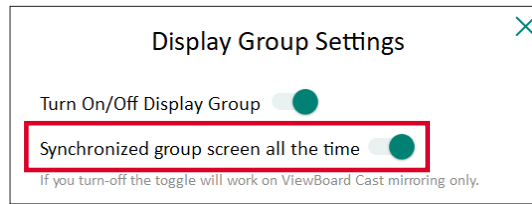

NOTE: Select the devices to group first, then toggle the “Synchronized group screen all the time” function ON to avoid interruption.

Share a Screen to the Display Group (One to Many Casting)

After confirming the above settings, you can share your screen to the main display, then the grouped client devices will be synced up to your screen.



Moderator Mode

Moderator Mode allows the moderator to take control of the devices connected to the ViewBoard or display. To enter Moderator Mode, select the Moderator Mode icon (👤) located in the lower-right corner of the screen.

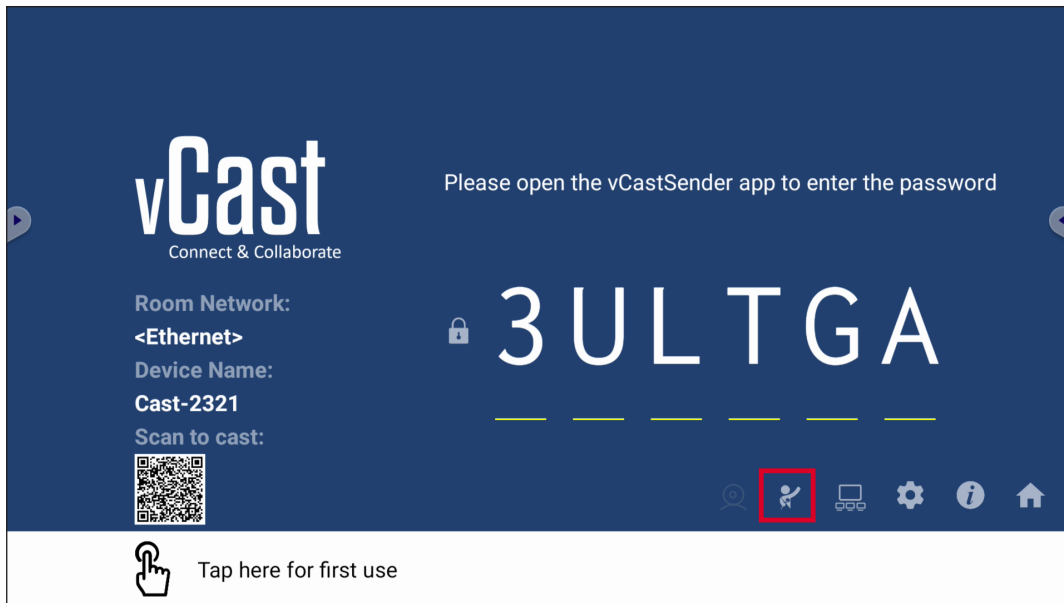

When enabled, the moderator can view a list of all connected screens in the left floating window and can preview each participant's screen and then select any of participant's screen and cast to the ViewBoard's or display's main screen for presentation. The moderator can also control each participant's screen, annotate on the ViewBoard or display, and remove unwanted participants by selecting the close icon (X).

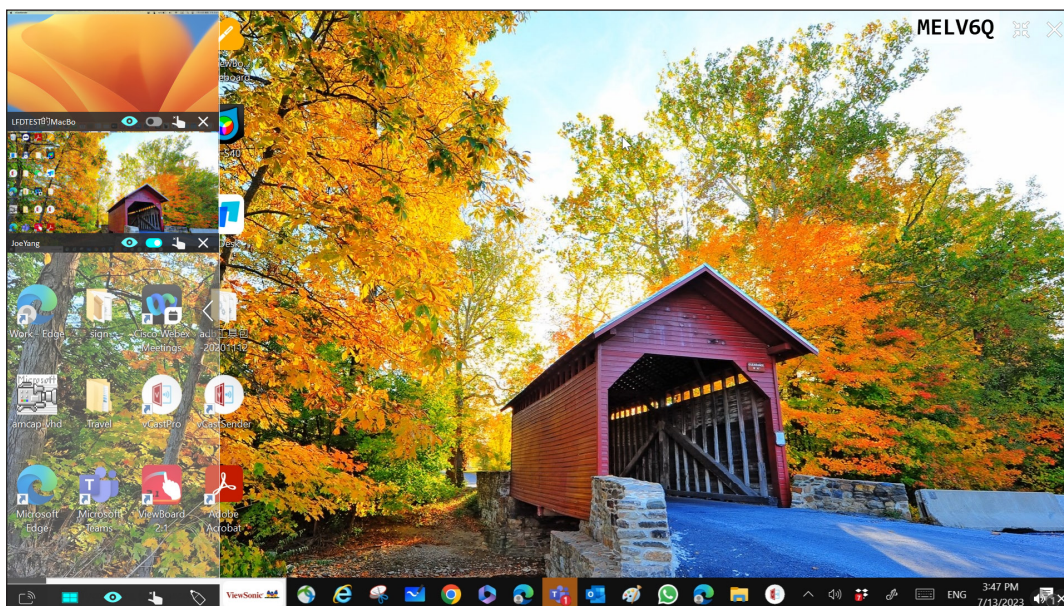

Broadcast

When enabled, the ViewBoard's screen will be broadcasted to all of the participant's connected screens simultaneously. The participants can only view the presentation contents until the moderator disables the Broadcast function.

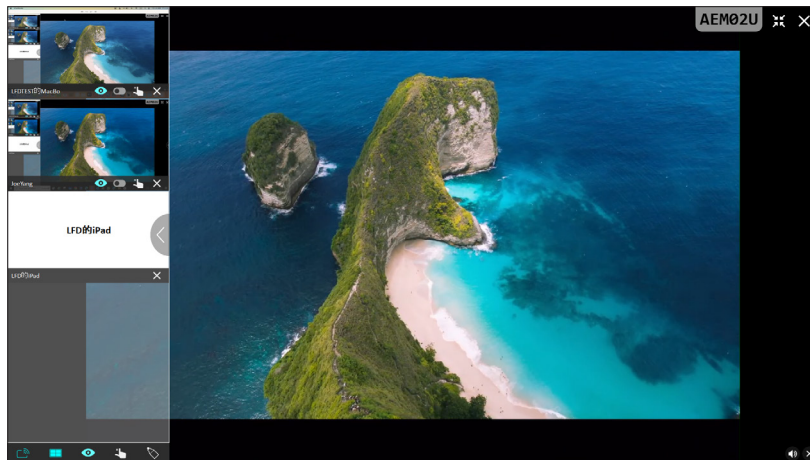

Multiple Screen Sharing

By default, vCast is set to allow multiple screen sharing, but can also be set to single screen sharing. To do this, the moderator can select the Multiple Screen Sharing icon to switch to single screen sharing.

Preview Screen

By default, vCast is set to let the moderator preview the participant's screen contents prior to sharing to the ViewBoard. Selecting the Preview Screen icon, the Moderator can switch to see the participant's name only.

Touch

By default, participants can use touch for collaboration after connecting. The moderator can enable/disable the touch function of a participant by selecting the Touch icon in their window.

NOTE:

- Moderator Mode is supported on all vCastSender and AirPlay devices, but mobile devices are limited to a "preview" function. Additionally, mobile Android devices cannot cast sound out.
- When you cast your Windows/Mac/Chrome screen to a ViewBoard or display, the selected full screen unit will not be broadcasted back to your device to avoid repetitive screen casting.
- The active presenter can touch each of the participant's screens to remotely control casting devices.
- The number of multi-screen presenters on-screen depends on your Windows CPU processor performance and router specifications.

Casting from Windows, MacBook, and Chrome Devices

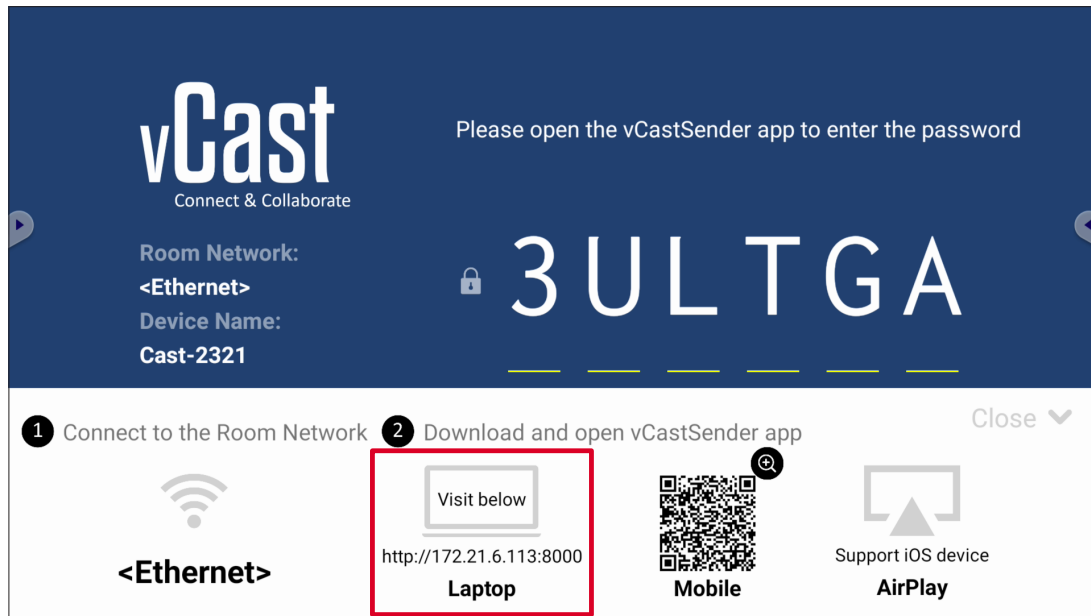

1. Ensure the client device (e.g., laptop) is connected to the same network as the ViewBoard.

NOTE: The network name can be found under **Room Network**.

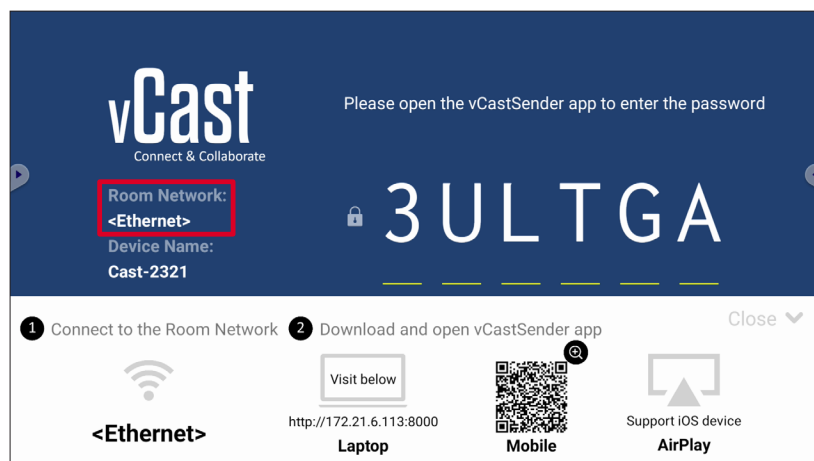

2. On the client device, visit the address that is shown on the ViewBoard to download and install the vCastSender application.
3. After installing, launch the vCastSender application.

4. To connect to the ViewBoard, input the PIN code and click OK.

NOTE: The PIN code can be found as highlighted below:

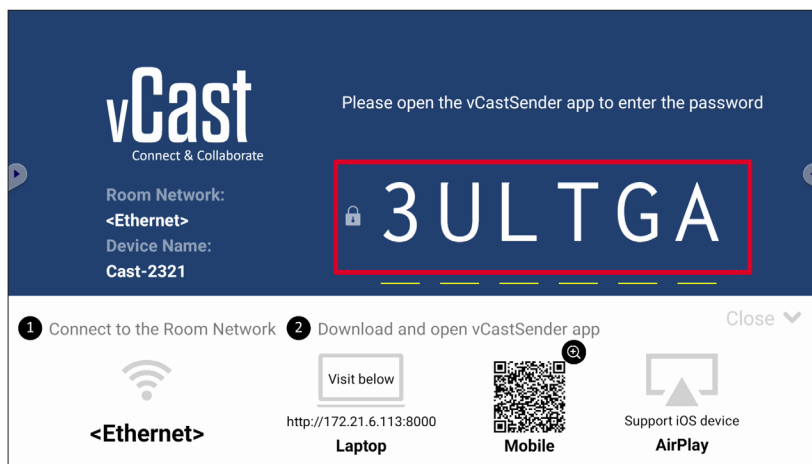

5. Additionally, you can connect to the ViewBoard by clicking **Device List** then the **Device Name** listed.

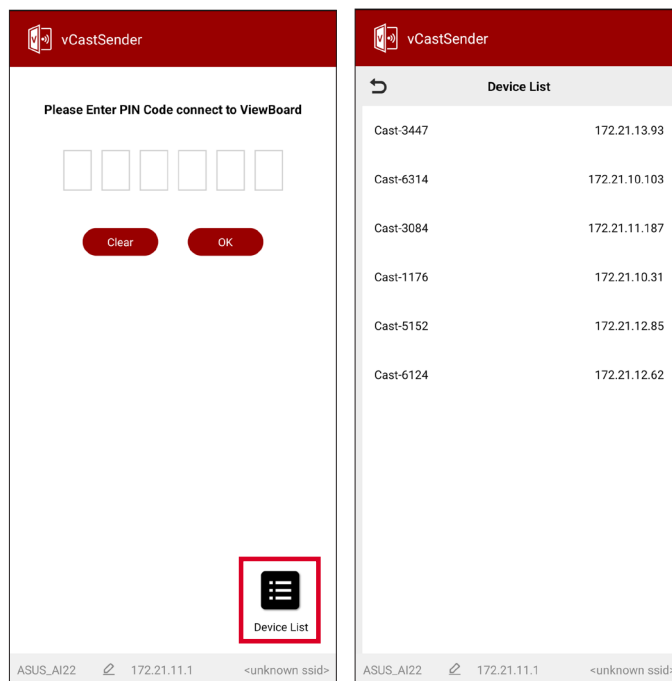

NOTE: The Device Name can be found as highlighted below:

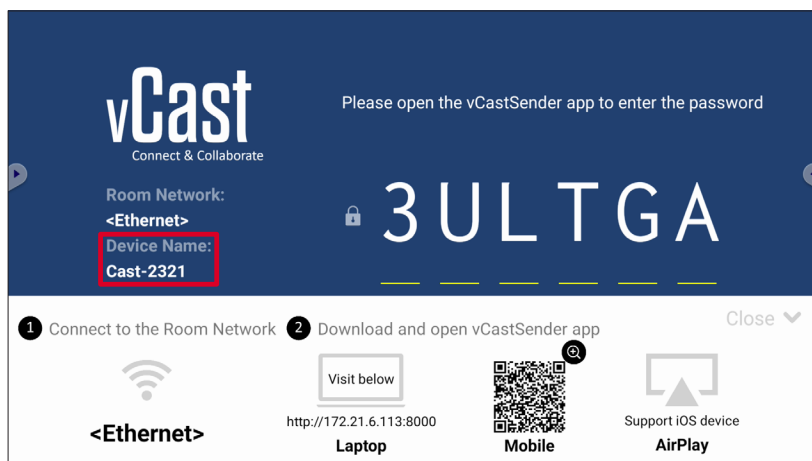

Casting from Android Devices

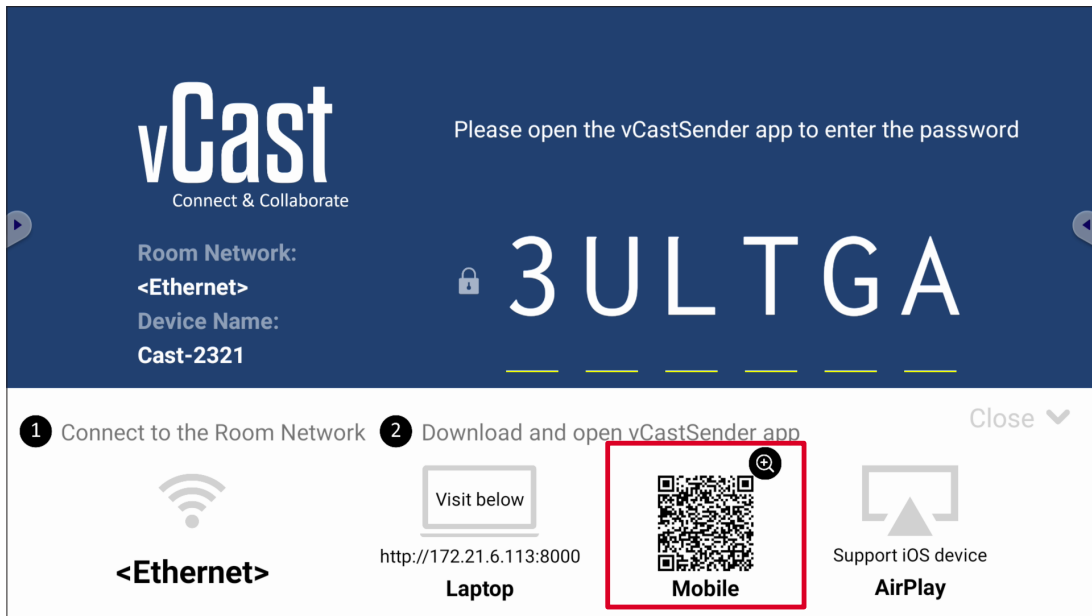

1. Ensure the client device (e.g., Android phone or tablet) is connected to the same network as the ViewBoard.

NOTE: The network name can be found under **Room Network**.

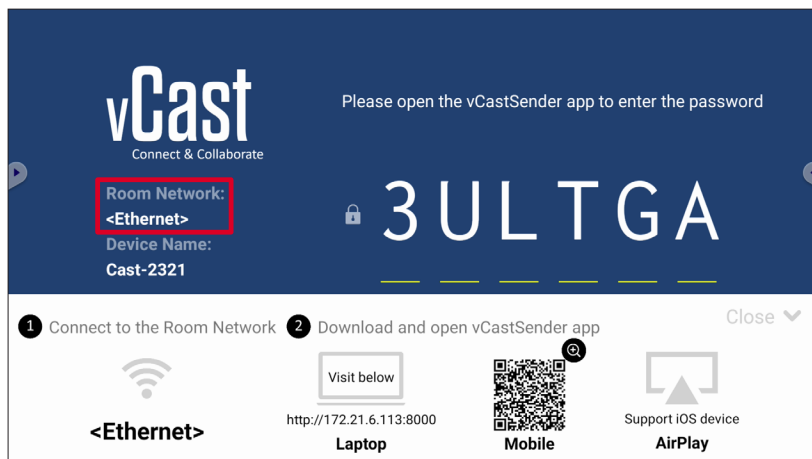

2. On the Android client device, scan the QR code shown on the ViewBoard to directly download the vCastSender application, or download the application from the Google Play Store.

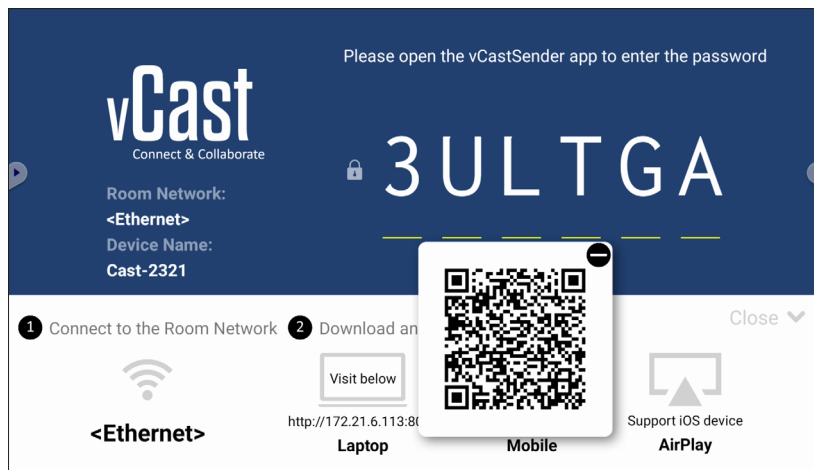

3. After installing, launch the vCastSender application.
4. To connect to the ViewBoard, input the PIN code and select **OK**.

NOTE: The **PIN code** can be found as highlighted below:

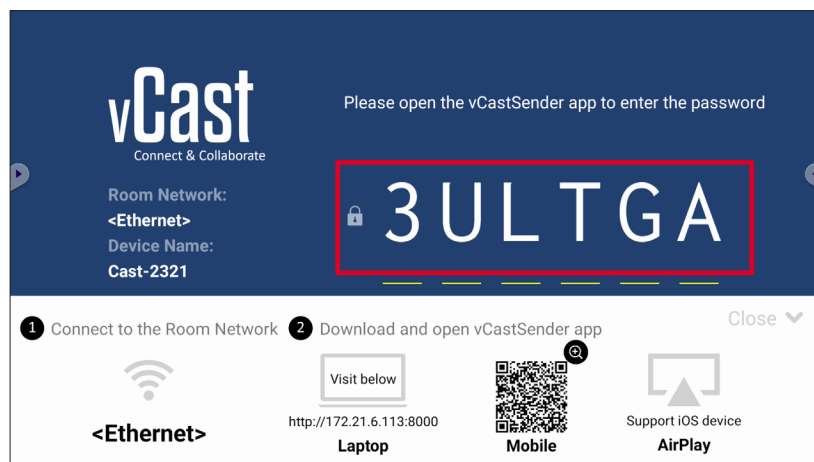

5. You can also connect to the ViewBoard by selecting **Device List** then the **Device Name** listed.

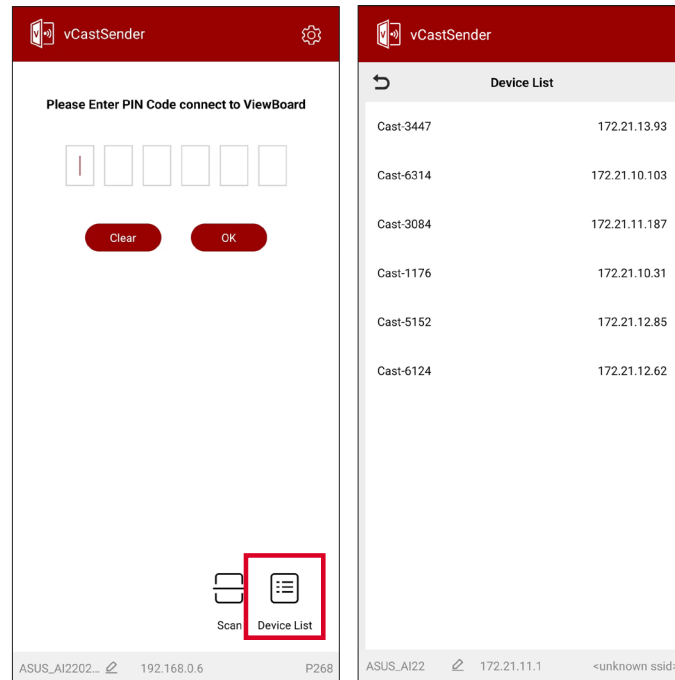

NOTE: The **Device Name** can be found as highlighted below:

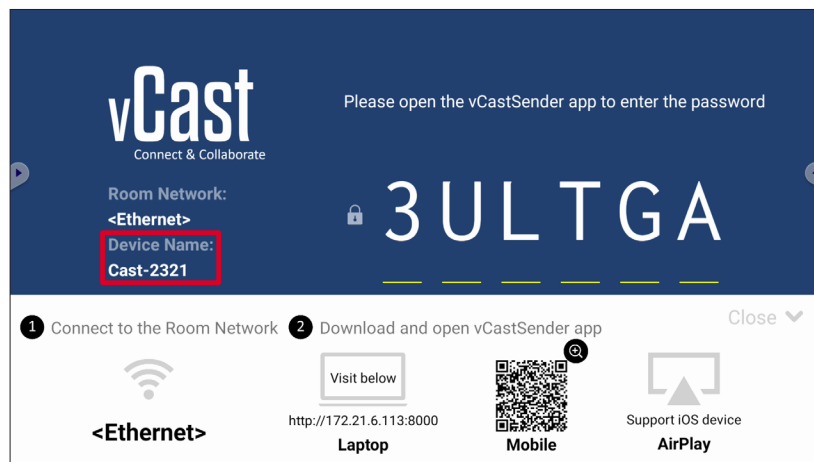

6. Additionally, you can connect to the ViewBoard or by selecting **Scan** then placing the on-screen QR code into the box to automatically connect.

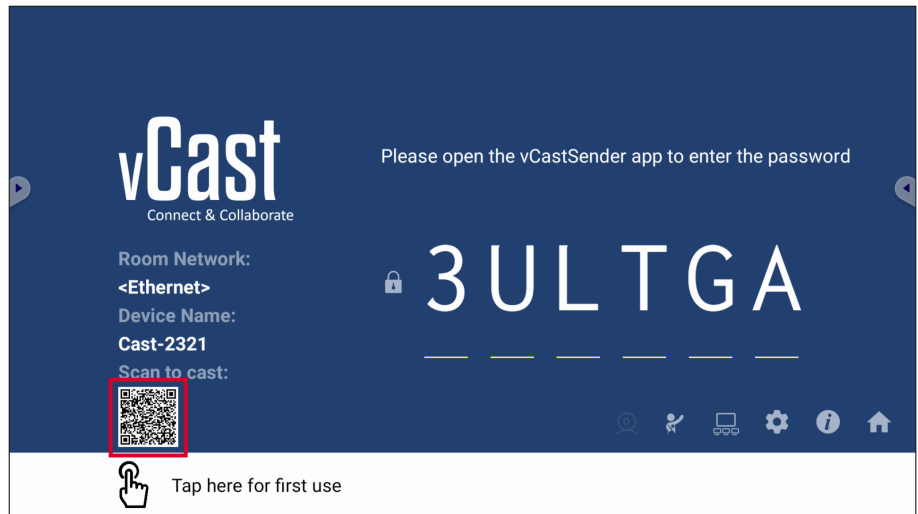
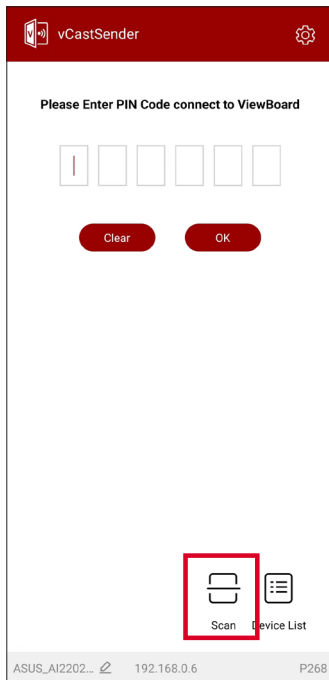

Casting from Apple iOS Devices

Apple AirPlay® is compatible with vCast for screen mirroring and content streaming under the same subnet environment only. An “AirPlay Password” will be generated on-screen for connection when using AirPlay to cast to a ViewBoard.

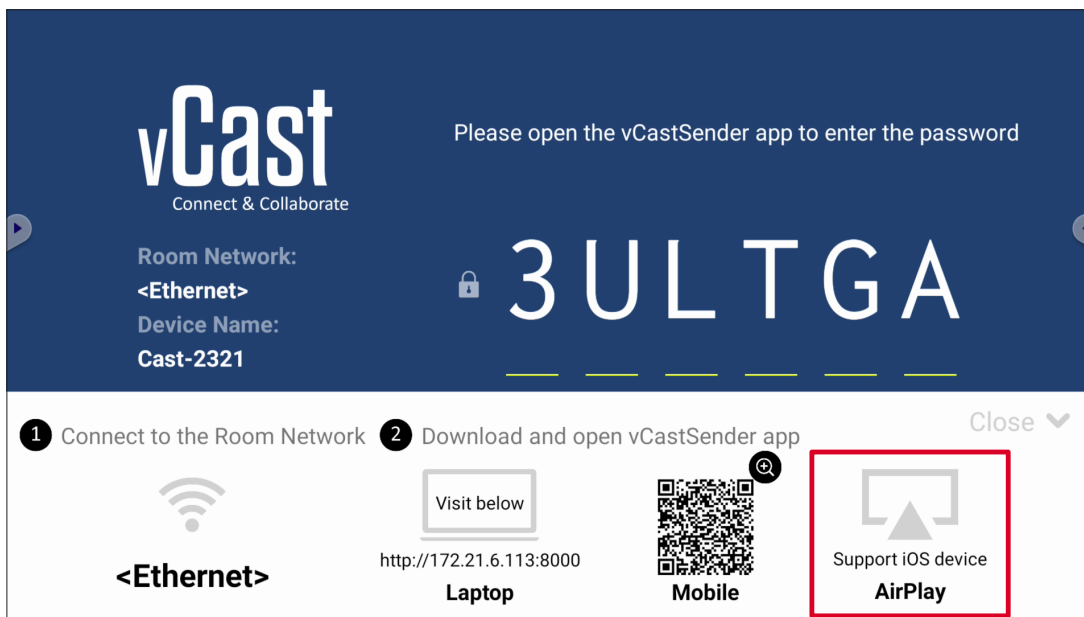

1. Ensure the client device (e.g., iPhone or iPad) is connected to the same network as the ViewBoard.

NOTE: The network name can be found under **Room Network**.

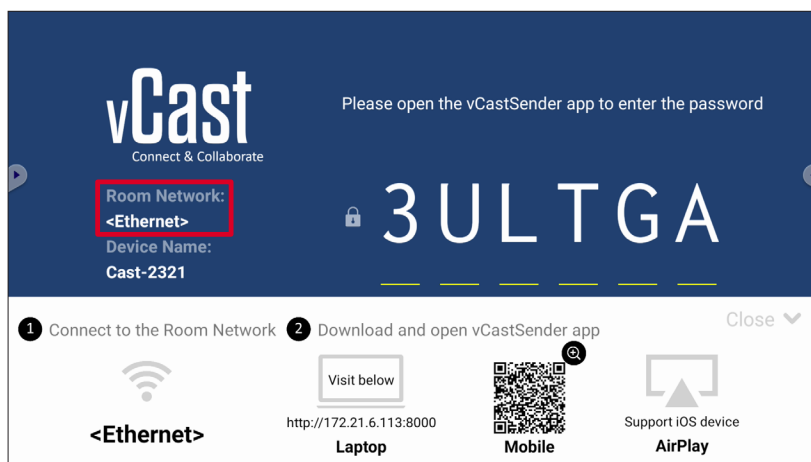

2. On the iOS client device, directly open AirPlay and select the **Device Name** of the ViewBoard to connect.

NOTE: The **Device Name** can be found as highlighted below:

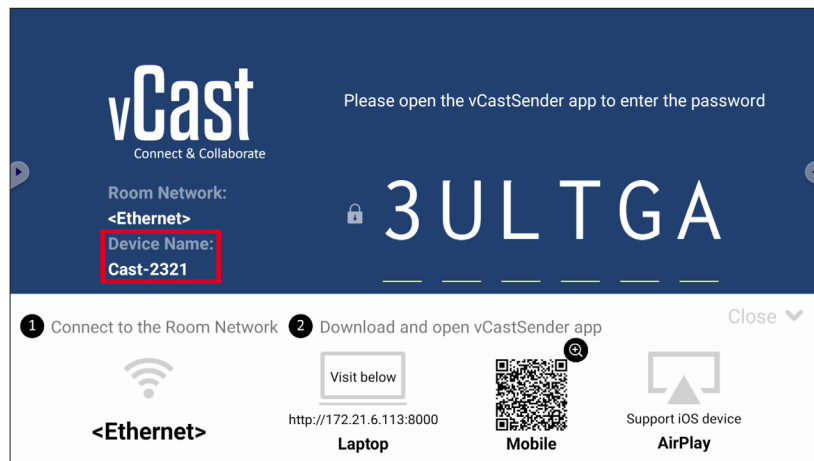

3. Input the generated on-screen **AirPlay Password** on the client device to connect.

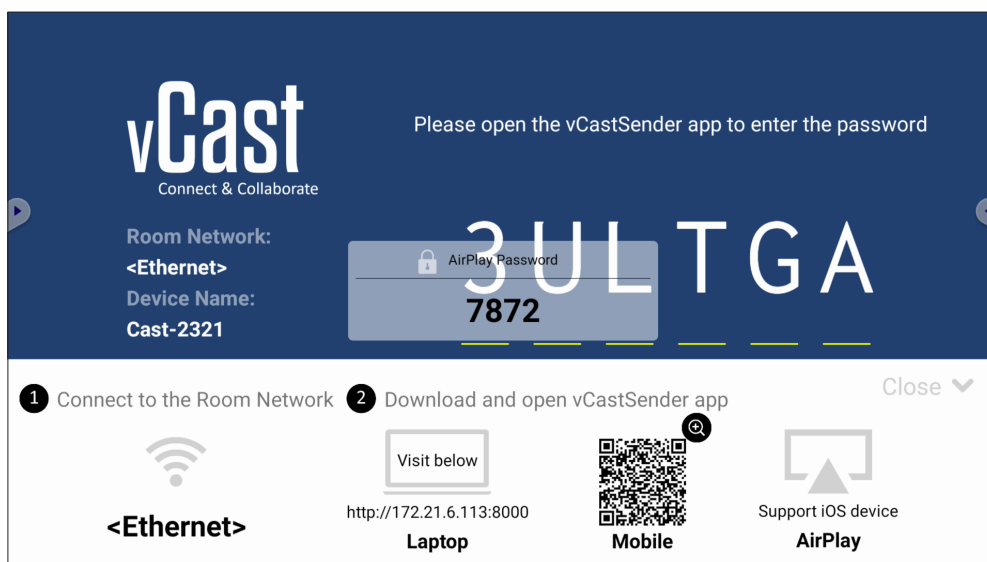

NOTE: In a cross subnet environment, please download and connect with the vCastSender iOS application from the Apple App Store.



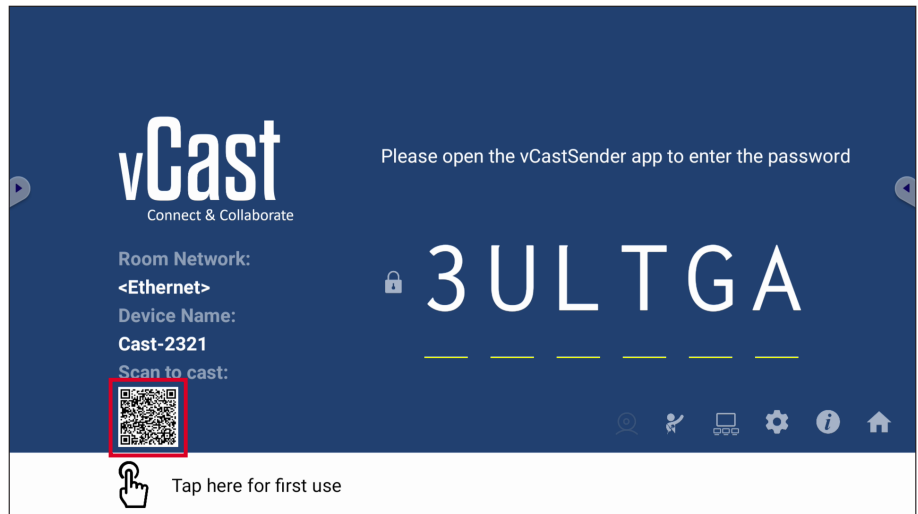
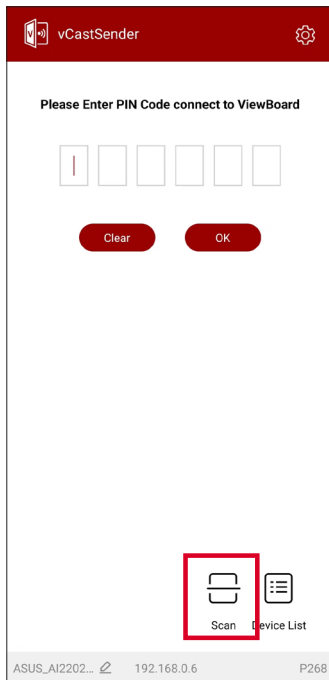



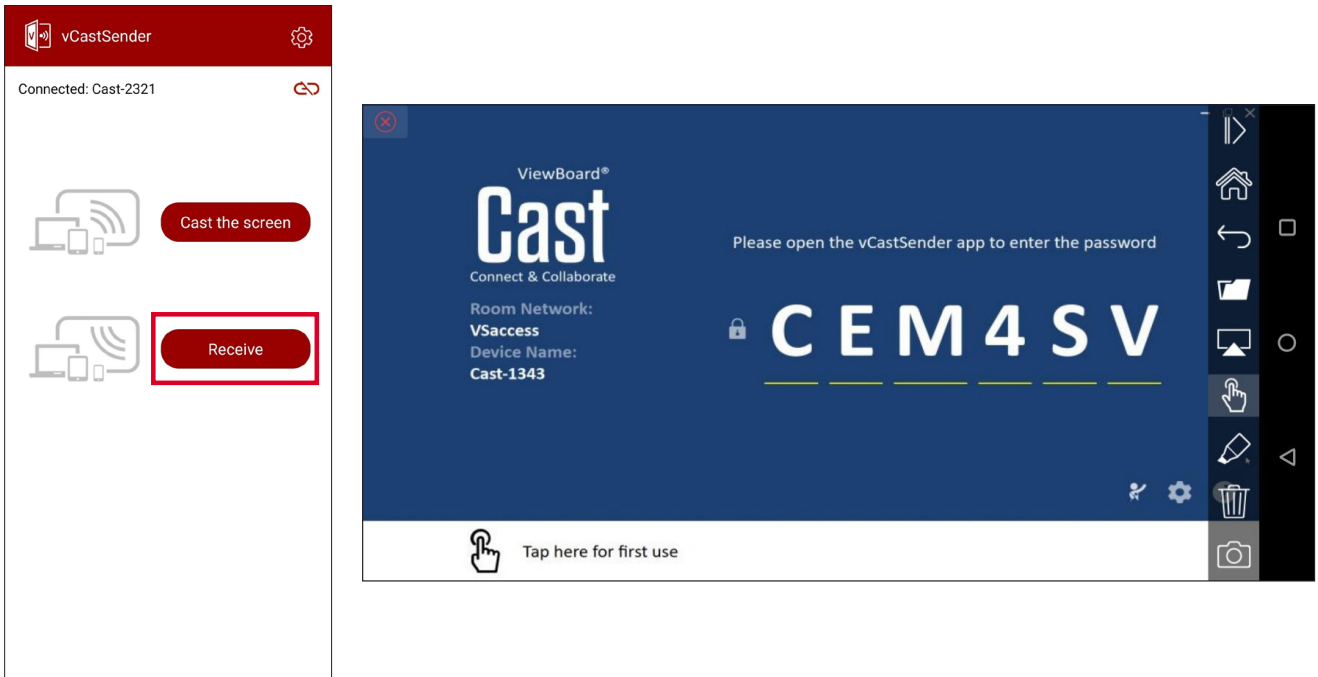

4. You can also connect to the ViewBoard by selecting **Scan** then placing the on-screen QR code into the box to automatically connect.



Connecting to a ViewBoard from a Mobile Device

Once connected, select **Receive**. The ViewBoard will appear on the mobile device with an on-screen toolbar. Users can interact with the ViewBoard with annotations, file sharing, etc.



Item		Description
	Toggle	Hide or display the toolbar.
	Home	Return to the Home interface.
	Return	Return to the previous operation.
	Folder	View or open the mobile device's files.
	Share	Cast the mobile device's screen to the connected ViewBoard or display.
	Touch	Remotely control the connected ViewBoard or display.
	Annotate	Make annotations, and adjust the pen color.
	Clear	Clear everything on screen.
	Camera	Send camera images to the connected ViewBoard or display.

Casting with Chromecast

vCast supports native Chromecast screen sharing via the Chrome browser casting when the Chromecast feature is enabled.

NOTE: Chromecast does not support password protection or multiple-screen casting.

1. Ensure the client device (e.g., laptop) is connected to the same network as the ViewBoard.

NOTE: The network name can be found under **Room Network**.

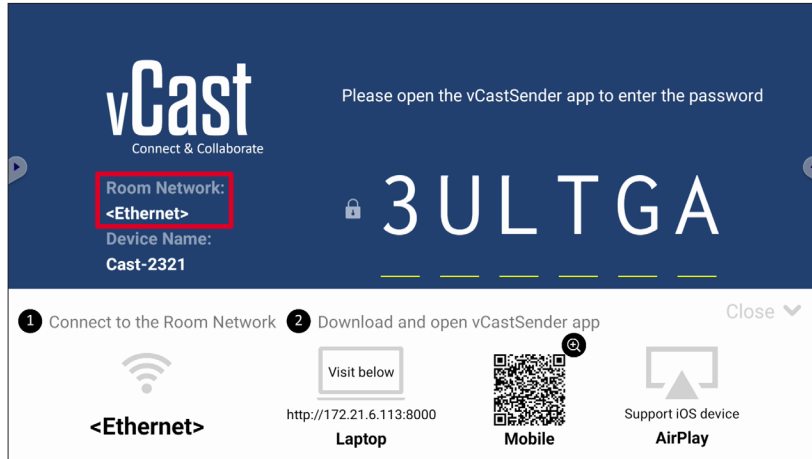

2. Ensure the **Chromecast Enable** checkbox is selected in the vCast settings.

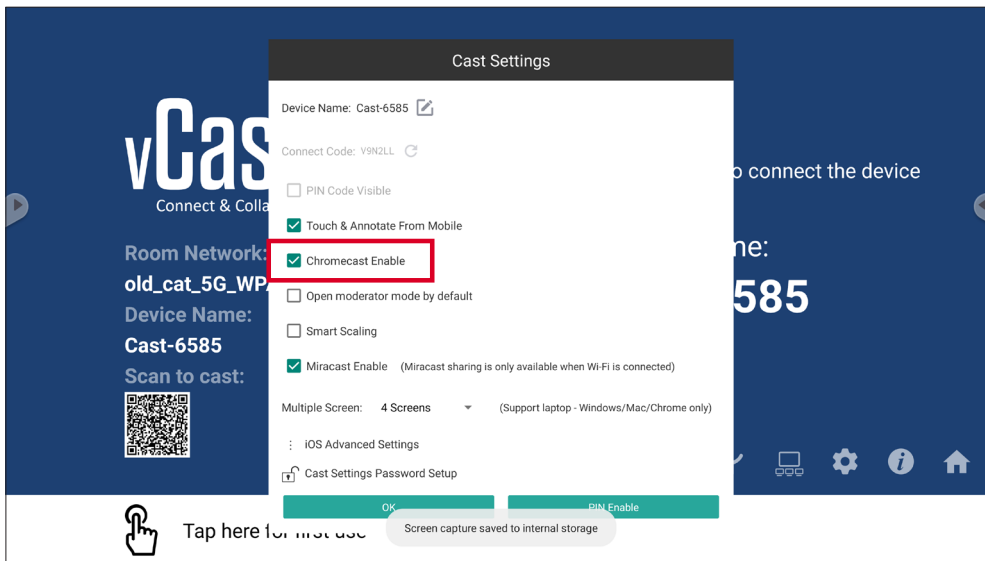

3. In the Chrome browser, go to: **Settings > Save and share > Cast...** > Select the screen to cast to.

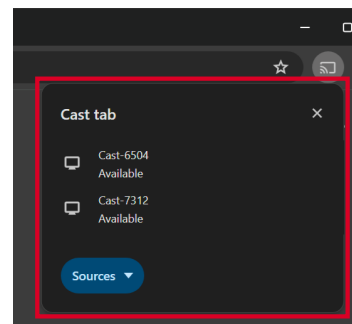
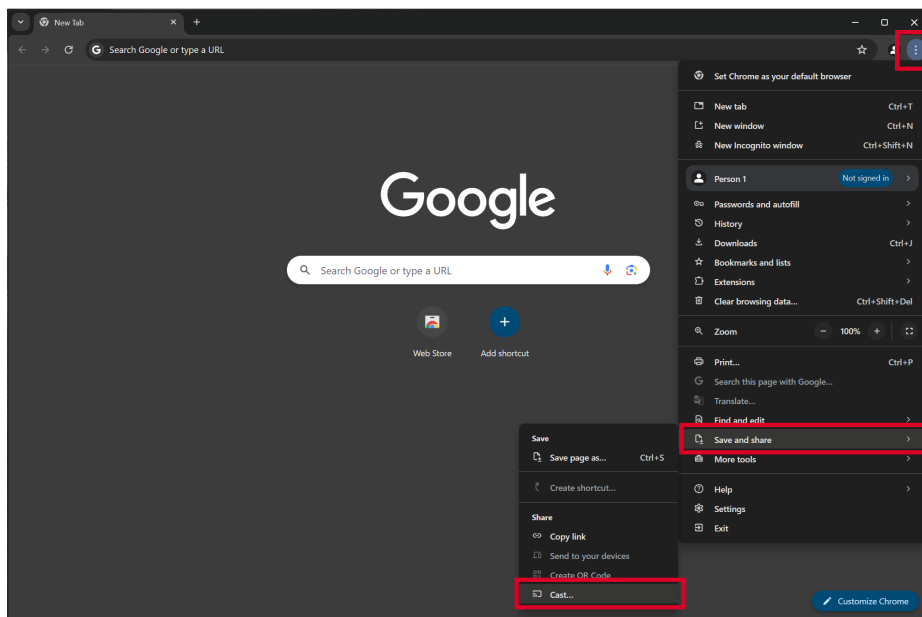

Casting with Miracast

vCast supports native Miracast to cast content from Windows and Android devices to a ViewBoard when the Miracast feature is enabled.

NOTE:

- Miracast does not support password protection or multiple-screen casting.
- Miracast sharing is only available over Wi-Fi.
- Miracast will automatically turn off after being idle for one hour.

1. Ensure the client device (e.g., laptop) is connected to the same network as the ViewBoard.

NOTE: The network name can be found under **Room Network**.

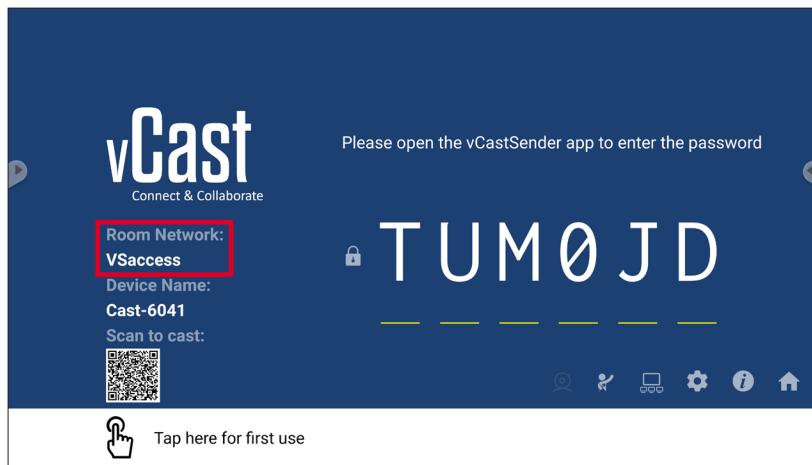

2. Ensure the **Miracast Enable** checkbox is selected in the vCast settings.

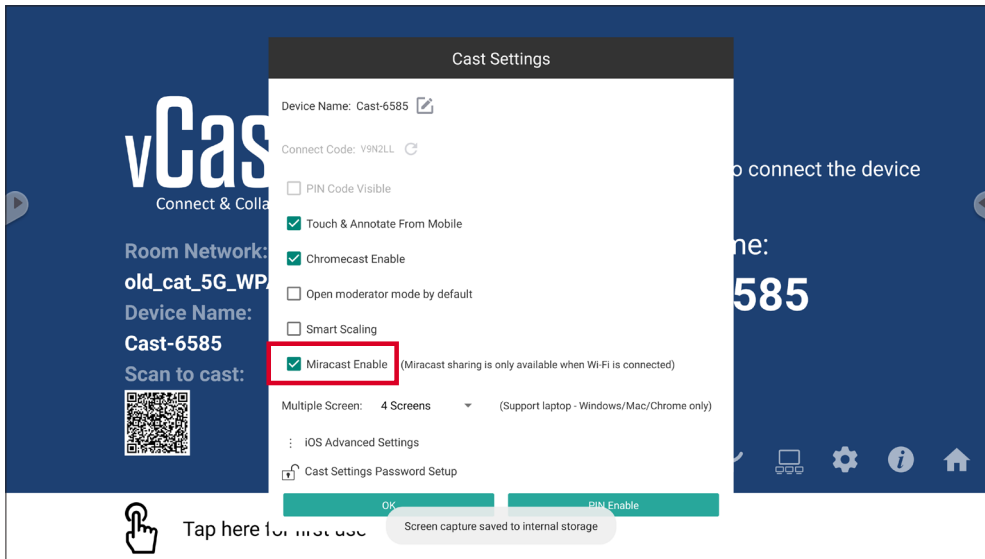

3. Please follow the below steps to cast:

For Windows devices:

1. On the Windows device, press Win + K and select the display to cast to.

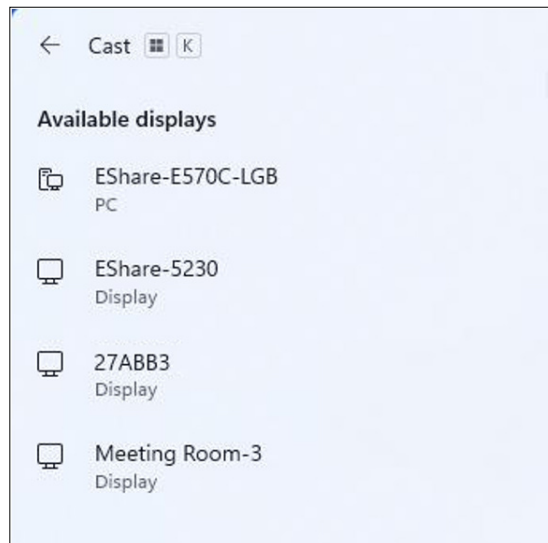

2. Select the checkbox "Allow mouse, keyboard, touch, and pen input from the device" to enable the touch feedback feature.

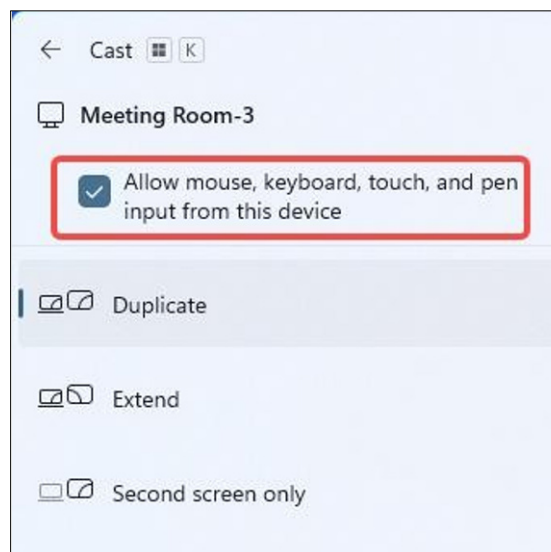

For Android devices:

On the Android device, directly select Cast/Smart View/Wireless Projection then select the display to cast to.

Other Default Applications

Chromium

Web browser for surfing the Internet.

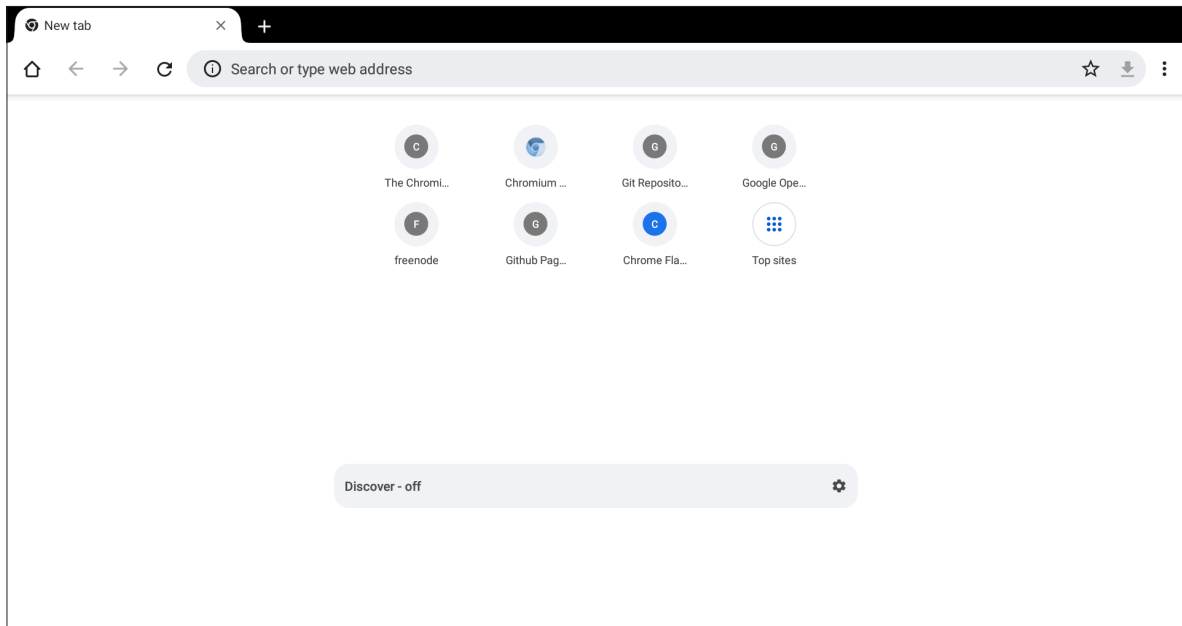



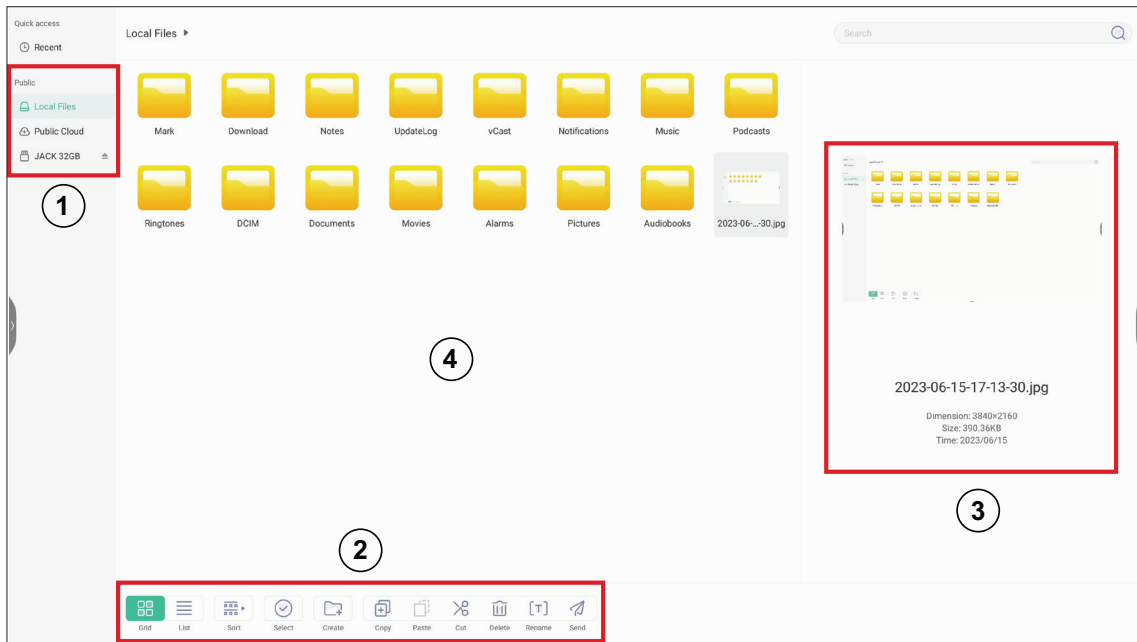







Folders



1. Storage Device Display

Select the appropriate storage device.

2. Icons

Item	Description
	Grid Display files by thumbnail view
	List Display files by list view
	Sort Sort the files
	Select Select a file
	Create Create a new folder
	Copy Copy a file
	Paste Paste a file
	Cut Cut a file
	Delete Delete a file
	Rename Rename a file
	Send Share a file

3. File Information

Preview the file, show the file's name, size, resolution, and creation date.

4. Main Display Area

Display files of corresponding type.

OfficeMobile

Create, edit, and view Documents, Spreadsheets, Presentations, and PDFs.

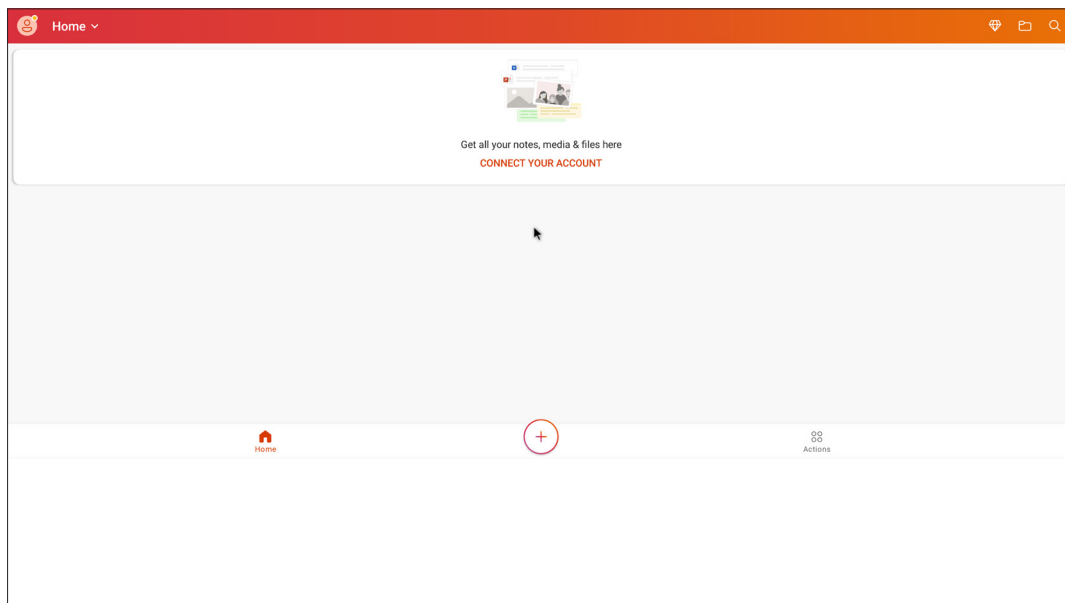

vSweeper

Clear unnecessary data and unwanted files.

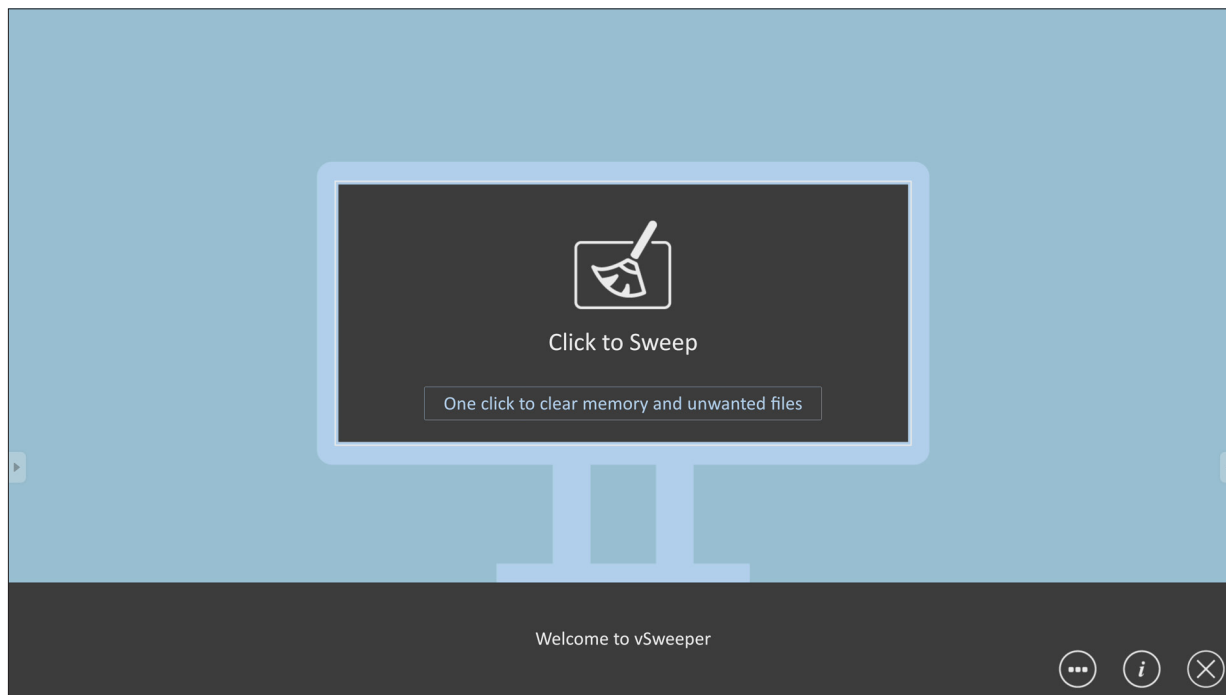

Advanced Settings can also be customized to the user's needs.

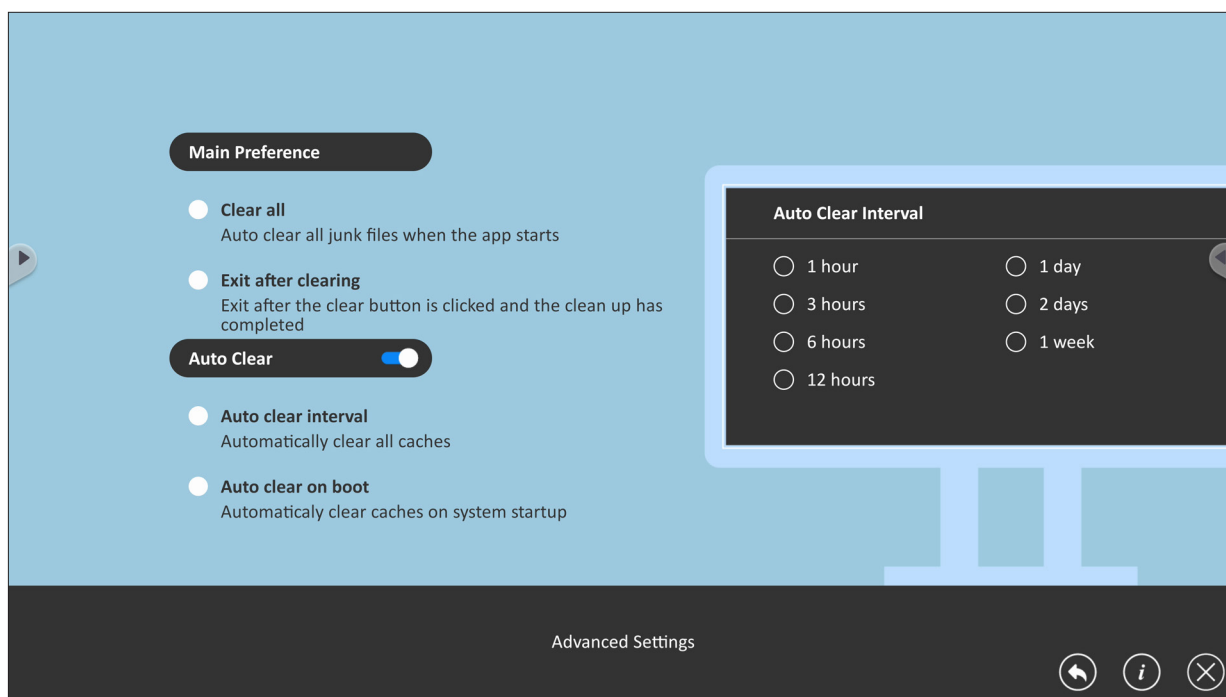

RS-232 Protocol

This document describes the hardware interface and software protocols of RS-232 interface communication between the ViewSonic LED Display and computers or other control units with RS-232 protocol.

The protocol contains three command sections:

- Set-Function
- Get-Function
- Remote control pass-through mode

NOTE: Below, “PC” represents all the control units that can send or receive the RS-232 protocol command.

Description

RS-232 Hardware Specification

ViewSonic LFD communication port on the rear side:

1. Connector type: DSUB 9-Pin Male (female or 3.5 mm barrel connector)
2. Use of crossover (null modem) cable for connection
3. Pin Assignment:

Male DSUB 9-Pin
(preferred)

1 2 3 4 5



6 7 8 9

Female DSUB 9-Pin

5 4 3 2 1



9 8 7 6

3.5 mm barrel connector
(alternative for limited
space)



Pin #	Signal	Remark
1	NC	
2	RXD	Input to Display
3	TXD	Output from Display
4	NC	
5	GND	
6	NC	
7	NC	
8	NC	
9	NC	
frame	GND	

Item	Signal	Remark
Tip	TXD	Output from Display
Ring	RXD	Input to Display
Sleeve	GND	

LAN Hardware Specification

ViewSonic LFD communication port on the rear side:

1. Connector type: 8P8C RJ45
2. Pin Assignment:

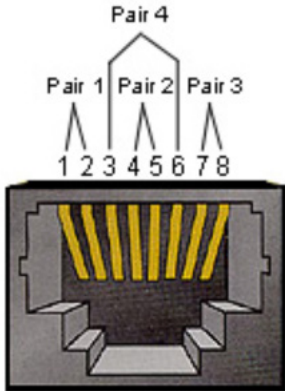

Pin #	Signal	Remark
1	TX+	Output from Display
2	TX-	Output from Display
3	RX+	Input to Display
4	BI_D3+	For 1G case
5	BI_D3-	For 1G case
6	RX-	Input to Display
7	BI_D4+	For 1G case
8	BI_D4-	For 1G case
frame	GND	

RS-232 Communication Setting

- Baud Rate Select: 9600bps (fixed)
- Data bits: 8 bits (fixed)
- Parity: None (fixed)
- Stop Bits: 1 (fixed)

LAN Communication Setting

- Type: Ethernet
- Protocol: TCP/IP
- Port: 5000 (fixed)
- WOL Port: 9 (fixed) for UDP*3.2.0
- Cross subnet: No
- Logon Credentials: No

Command Message Reference

PC sends to LFD command packet followed by “CR”. Every time PC sends control command to Display, the Display shall respond as follows:

1. If the message is received correctly it will send “+” (02Bh) followed by “CR” (00Dh)
2. If the message is received incorrectly it will send “-” (02Dh) followed by “CR” (00Dh)

Protocol

Set-Function Listing

The PC can control the Display for specific actions. The Set-Function command allows you to control the Display behavior at a remote site through the RS-232 port. The Set-Function packet format consists of 9 bytes.

Set-Function Description:

- Length:** Total Byte of Message excluding "CR"
- LFD ID** Identification for each Display (01~98; default is 01)
ID "99" means to apply the set command for all connected displays. Under such circumstances, only ID#1 display has to reply.
The LFD ID can be set via the OSD menu for each Display.
- Command Type** Identify command type,
"s" (0x73h): Set Command
"+" (0x2Bh): Valid command Reply
"- " (0x2Dh): Invalid command Reply
- Command:** Function command code: One byte ASCII code.
- Value[1~3]:** Three bytes ASCII that defines the value.
- CR** 0x0D

Set-Function Format

Send: (Command Type="s")

Name	Length	ID	Command Type	Command	Value1	Value2	Value3	CR
Byte Count	1 Byte	2 Byte	1 Byte	1 Byte	1 Byte	1 Byte	1 Byte	1 Byte
Bytes order	1	2~3	4	5	6	7	8	9

Reply: (Command Type="+" or "-")

Name	Length	ID	Command Type	CR
Byte Count	1 Byte	2 Byte	1 Byte	1 Byte
Bytes order	1	2~3	4	5

NOTE: When PC applies command to all displays (ID=99), only the #1 set needs to reply by the name of ID=1.

Example 1: Set Brightness at 76 for Display (#02) and this command is valid

Send (Hex Format)

Name	Length	ID	Command Type	Command	Value1	Value2	Value3	CR
Hex	0x38	0x30 0x32	0x73	0x24	0x30	0x37	0x36	0x0D

Reply (Hex Format)

Name	Length	ID	Command Type	CR
Hex	0x34	0x30 0x32	0x2B	0x0D

Example 2: Set Brightness at 75 for Display (#02) and this command is NOT valid

Send (Hex Format)

Name	Length	ID	Command Type	Command	Value1	Value2	Value3	CR
Hex	0x38	0x30 0x32	0x73	0x24	0x30	0x37	0x35	0x0D

Reply (Hex Format)

Name	Length	ID	Command Type	CR
Hex	0x34	0x30 0x32	0x2D	0x0D

Set-Function Table

A. Basic Function

Set Function	Length	ID	Command		Value Range	Comments
			Type (ASCII)	Code (ASCII) Code (Hex)		
Power ON *3.2.1/ OFF (standby)	8		s	!	21 000: STBY 001: ON	1. The Power-on via LAN control may work only under specific modes. See display UG for details. *3.1.1 2. "WOL by MAC address" maybe available as an alternative.*3.2.1
Input Select	8		s	"	22 000: TV 001: AV 002: S-Video 003: YPbPr 004: HDMI1 014: HDMI2 024: HDMI3 034: HDMI4 005: DVI 006: VGA1 016: VGA2 026: VGA3 007: Slot-in PC (OPS/SDM)/HDBT 008: Internal memory 009: DP1 *3.2.4 023: DP2 019: Type-C 1 *3.3.2 039: Type-C 2 00A: Embedded/Main (Android)	1. No need for USB 2. For the case of two or more same sources, the 2nd digital is used to indicate the extension. 3. The HEX of 00A is 30 30 41. 4. 00Z is reserved for cycle mode *3.3.1 5. Using 2nd digi to identify DP or Type C. 0 and even numbers stand for DP; odd numbers stand for Type C *3.3.2
Brightness	8		s	\$	24 000 ~ 100 900: Bright down (-1) 901: Bright up (+1) *3.1.1	
Backlight *3.2.0	8		A	B	42 000 ~ 100	1. For Android platform whose main mode is controlled by backlight and the other sources are controlled by brightness. 2. Derived from Color calibration. *3.2.0
Power lock	8		s	4	34 000: Unlock 001: Lock	*See note in details
Volume	8		s	5	35 000 ~ 100 900: Volume down(-1) 901:Volume up(+1)	
Mute	8		s	6	36 000: OFF 001: ON (mute)	
Button lock	8		s	8	38 000: Unlock 001: Lock	*See note in details
Menu lock	8		s	>	3E 000: Unlock 001: Lock	*See note in details

Set Function	Length	ID	Command	Command	Value Range	Comments	
Number *3.1.1	8		s	@	40	000~009	
Key Pad *3.1.1	8		s	A	41	000: UP 001: DOWN 002: LEFT 003: RIGHT 004: ENTER 005: INPUT 006: MENU/(EXIT) 007: EXIT	
Remote Control	8		s	B	42	000: Disable 001: Enable 002: Pass through	Disable: RCU will have no function Enabled: RCU controls normally Pass through: Display will bypass the RC code to connected device via the RS-232 port, but not react itself.
Restore default	8		s	~	7E	000	Recover to factory settings

NOTE:

1. Behavior at Lock Modes

Lock Mode	Behavior
Button Lock	<ol style="list-style-type: none">1. Lock all buttons on the front panel and RCU, except for “Power”2. All the SET functions should be workable via RS-232, even the ones with according hot key in RCU like Mute,...etc.
MENU Lock	<ol style="list-style-type: none">1. Lock the “MENU’ key of front panel and RCU2. The Factory and Hospitality modes should not be blocked for the model using MENU-combined key to enter these two modes. Alternative approach will be indicated separately if any limitation by model.
POWER Lock	<ol style="list-style-type: none">1. Lock the “POWER” key on the front and RCU.2. The SET_POWER ON/OFF should be workable via RS-232, but does not mean the POWER lock will be released under this case.3. Can not be unlocked by reset in OSD setting4. Will auto AC power-on in power-lock5. Under power-lock, the set will not enter power saving when no PC signal and neither turn off when no other video signals after 15 minutes.
Remote Control Disable	Lock the RCU keys, but keep the front panel buttons workable.

2. Wake-on-LAN by MAC address as alternative for SET Power on

(Length=126 Bytes)

6 Bytes	6 Bytes (#1)	6 Bytes (#2)	...	6 Bytes (#16)	24 Bytes
0xFF FF ... FF	MAC address	MAC address	...	MAC address	0x00 00 ... 00

B. Optional Function

Set Function	Length	ID	Command		Value Range (Three ASCII bytes)	Comments
			Type (ASCII)	Code (ASCII) Code (Hex)		
Input Select: Cycle *3.3.1	8		s	" 22	00Z	Inputs in cycle loop depend on display itself
Contrast	8		s	# 23	000 ~ 100	
Sharpness	8		s	% 25	000 ~ 100	
Color	8		s	& 26	000 ~ 100	
Tint	8		s	' 27	000 ~ 100	
Backlight On_Off *3.2.3	8		s	(28	000: OFF 001: ON	Keep both "Backlight On_Off" and "Function On_Off" for backward compatibility *3.3.2
Color mode	8		s) 29	000: Normal 001: Warm 002: Cold 003: Personal	
Freeze On_Off	8		s	* 2A	000: OFF 001: ON	Keep both "Freeze On_Off" and "Function On_Off" for backward compatibility *3.3.2
Surround sound	8		s	- 2D	000: OFF 001: ON	
Bass	8		s	. 2E	000 ~ 100	
Treble	8		s	/ 2F	000 ~ 100	
Balance	8		s	0 30	000 ~ 100	050 is central
Picture Size	8		s	1 31	000: FULL (16:9) 001: NORMAL (4:3) 002: REAL (1:1) *3.1.0	
OSD language	8		s	2 32	000: English 001: French 002: Spanish	Could be extended for more supported languages by model
PIP-Mode	8		s	9 39	000: OFF 001: PIP(POP) 002: PBP	
PIP-Sound select	8		s	: 3A	000: Main 001: Sub	
PIP-Position	8		s	; 3B	000: Up 001: Down 002: Left 003: Right	

Set Function	Length	ID	Command	Command	Value Range	Comments	
PIP-Input	8		s	7	37 *2.9	000: TV 001: AV 002: S-Video 003: YPbPr 004: HDMI1 014: HDMI2 024: HDMI3 034: HDMI4 005: DVI 006: VGA1 016: VGA2 026: VGA3 007: Slot-in PC (OPS/SDM)/HDBT 008: Internal memory 009: DP/Type-C *3.2.4 00A: Embedded/ Main (Android)	Value range is same as SET- Input select
Tiling-Mode	8		s	P	50	000: OFF 001: ON	(for video wall)
Tiling- Compensation	8		s	Q	51	000: OFF 001: ON	(for video wall) Bezel width compensation
Tiling-H by V Monitors	8		s	R	52	01x~09x: H 0x1~0x9: V	(for video wall) 1. 2nd digital for H monitors 2. 3rd digital for V monitors
Tiling-Position	8		s	S	53	001~025	(for Video wall) Copy the screen of Position# to identified display
Date: Year	8		s	V	56	Y17~Y99	Last 2 digits (20)17~(20)99
Date: Month	8		s	V	56	M01~M12	2 digits
Date: Day	8		s	V	56	D01~D31	2 digits
Time: Hour	8		s	W	57	H00~H23	24-hr format. 2 digits.
Time: Min	8		s	W	57	M00~M59	2 digits
Time: Sec	8		s	W	57	S00~S59	2 digits
Customized Hot Keys *3.2.6	8		s	X	58	001~999 001: Open MVB Whiteboard *3.3.3 002: Open MVB Display *3.3.3 003: Open MVB Manager *3.3.3 004: Open vCast *3.3.3 005: Open Signage Launcher *3.3.3 006: Open RevelDigital Player *3.3.3 007: Open XiO Connected *3.3.3	

Set Function	Length	ID	Command	Command	Value Range	Comments
Function On_Off *3.3.2	8		s	=	3D	001: Backlight OFF 101: Backlight ON 002: Freeze OFF 102: Freeze ON 003: Touch OFF 103: Touch ON

NOTE:

1. Tiling definition of H Monitors, V Monitors, and Position

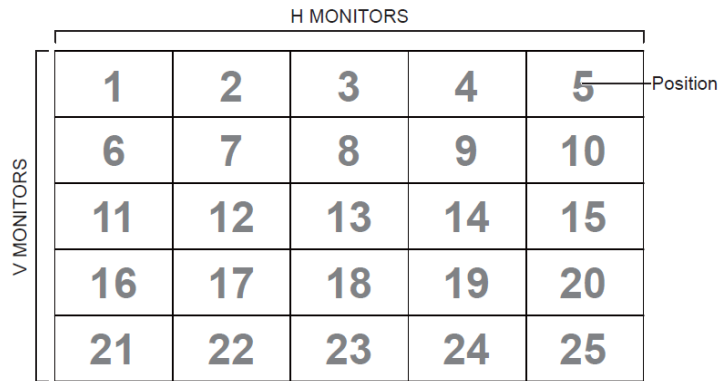

2. Set Date example

Date: 2017-3/15

Send: 0x 38 30 31 73 56 59 31 37 0D (“Y17”)

Send: 0x 38 30 31 73 56 4D 30 33 0D (“M03”)

Send: 0x 38 30 31 73 56 44 31 35 0D (“D15”)

3. Set Time example

Time: 16:27:59

Send: 0x 38 30 31 73 57 48 31 36 0D (“H16”)

Send: 0x 38 30 31 73 57 4D 32 37 0D (“M27”)

Send: 0x 38 30 31 73 57 53 35 39 0D (“S59”)

Get-Function Listing

The PC can interrogate the LFD for specific information. The Get-Function packet format consists of 9 bytes which is similar to the Set-Function packet structure. Note that the “Value” byte is always = 000.

Get-Function Description:

- Length:** Total Byte of Message excluding “CR”.
- TV/DS ID** Identification for each of TV/DS (01~98; default is 01).
- Command Type** Identify command type,
 “g” (0x67h) : Get Command
 “r” (0x72h) : Valid command Reply
 “-” (0x2Dh) : Invalid command Reply
- Command:** Function command code: One byte ASCII code.
- Value[1~3]:** Three bytes ASCII that defines the value.
- CR** 0x0D

Get-Function Format

Send: (Command Type=“g”)

Name	Length	ID	Command Type	Command	Value1	Value2	Value3	CR
Byte Count	1 Byte	2 Byte	1 Byte	1 Byte	1 Byte	1 Byte	1 Byte	1 Byte
Bytes order	1	2~3	4	5	6	7	8	9

Reply: (Command Type=“r” or “-”)

If the Command is valid, Command Type = “r”

Name	Length	ID	Command Type	Command	Value1	Value2	Value3	CR
Byte Count	1 Byte	2 Byte	1 Byte	1 Byte	1 Byte	1 Byte	1 Byte	1 Byte
Bytes order	1	2~3	4	5	6	7	8	9

If the Command is NOT valid, Command Type = “-”

Name	Length	ID	Command Type	CR
Byte Count	1 Byte	2 Byte	1 Byte	1 Byte
Bytes order	1	2~3	4	5

Example 1: Get Brightness from TV-05 and this command is valid. The Brightness value is 67.

Send (Hex Format)

Name	Length	ID	Command Type	Command	Value1	Value2	Value3	CR
Hex	0x38	0x30 0x35	0x67	0x62	0x30	0x30	0x30	0x0D

Reply (Hex Format)

Name	Length	ID	Command Type	Command	Value1	Value2	Value3	CR
Hex	0x38	0x30 0x35	0x72	0x62	0x30	0x36	0x37	0x0D

Example 2: Get Color from Display (#05), but the Color command is not supported by this model.

Send (Hex Format)

Name	Length	ID	Command Type	Command	Value1	Value2	Value3	CR
Hex	0x38	0x30 0x35	0x67	0x26	0x30	0x30	0x30	0x0D

Reply (Hex Format)

Name	Length	ID	Command Type	CR
Hex	0x34	0x30 0x35	0x2D	0x0D

Get-Function Table

A. Basic Function

Get Function	Length	ID	Command		Response Range (Three ASCII bytes)	Comments
			Type (ASCII)	Code (ASCII) Code (Hex)		
Get-Brightness	8		g	b 62	000 ~ 100	
Get-Backlight *3.2.0	8		a	B 42	000 ~ 100	1. For Android platform whose main mode is controlled by backlight and the other sources are controlled by brightness. 2. Derived from Color calibration. *3.2.0
Get-Volume	8		g	f 66	000 ~ 100	
Get-Mute	8		g	g 67	000: OFF 001: ON (muted)	
Get-Input select	8		g	j 6A	000~ 100~	1. 1st digit for signal detection: 0 means "no signal"; 1 means "signal detected" 2. 2nd & 3rd digit: See Set-function table
Get-Power status: ON/ STBY	8		g	l 6C	001: ON 000: STBY	
Get-Remote control	S		g	n 6E	000: Disable 001: Enable 002: Pass through	Get RCU mode status
Get-Power lock	8		g	o 6F	000: Unlock 001: Lock	
Get-Button lock	8		g	p 70	000: Unlock 001: Lock	
Get-Menu lock	8		g	l 6C	000: Unlock 001: Lock	
Get-ACK	8		g	z 7A	000	This command is used to test the communication link
Get-Thermal	8		g	0 30	000~100: 0~+100 deg C -01~-99: -1~-99 deg C	
Get-Operation hour *3.2.0	8		g	1 31	000	1. Accumulated hours in 6-digit integer (000,001~ 999,999) *3.2.0 2. Can not be reset when FW update and Factory initiation *3.2.2 3. Reply in new 32-byte format *3.2.0
Get-Device name	8		g	4 34	000	Reply in new 32-byte format *3.2.0

Get Function	Length	ID	Command	Command	Command	Response Range	Comments
Get-MAC address	8		g	5	35	000	(for the models with LAN) Reply in new 32-byte format *3.2.0
Get-IP address *3.2.0	8		g	6	36	000	(for the models with LAN) Reply in new 32-byte format *3.2.0
Get-Serial number *3.2.0	8		g	7	37	000	Reply in new 32-byte format *3.2.0
Get-FW version *3.2.0	8		g	8	38	000	Reply in new 32-byte format *3.2.0

NOTE:

1. Get Operation Hour example

Assumed the accumulated operation hour is 123,456 hrs

Send: 0x 38 30 31 67 31 30 30 30 0D (Get Operation hour)

Reply: 0x 32 30 31 72 31 31 32 33 34 35 36 00 00 ... 00 00 0D

2. Get Device Name example

Assumed the device name is CDE-5500

Send: 0x 38 30 31 67 34 30 30 30 0D (Get Device Name)

Reply: 0x 32 30 31 72 34 43 44 45 2D 35 35 30 30 00 00 ... 00 00 0D

Assumed the device name is "NMP-302#1"

Send: 0x 38 30 31 67 34 30 30 30 0D (Get Device Name)

Reply: 0x 32 30 31 72 34 4E 4D 50 2D 33 30 32 23 31 00 00 ...00 00 0D

3. Get MAC address example

Assumed the MAC address is 00:11:22:aa:bb:cc

Send: 0x 38 30 31 67 35 30 30 30 0D (Get MAC add)

Reply: 0x 32 30 31 72 35 30 30 31 31 32 32 61 61 62 62 63 63 00 00...00 00 0D

4. Get IP address example

Assumed the IP address is 192.168.100.2

Send: 0x 38 30 31 67 36 30 30 30 0D (Get IP address)

Reply: 0x 32 30 31 72 36 31 39 32 2E 31 36 38 2E 31 30 30 2E 32 00 00...00 00 0D

5. Get Serial number example

Assumed the Serial number is ABC180212345

Send: 0x 38 30 31 67 37 30 30 30 0D (Get Serial number)

Reply: 0x 32 30 31 72 37 41 42 43 31 38 30 32 31 32 33 34 35 00 00...00 00 0D

6. Get FW version example

Assumed the FW version is 3.02.001

Send: 0x 38 30 31 67 38 30 30 30 0D (Get FW version)

Reply: 0x 32 30 31 72 38 33 2E 30 32 2E 30 30 31 00 00...00 00 0D

B. Optional Function

Get Function	Length	ID	Command			Response Range	Comments
			Type (ASCII)	Code (ASCII)	Code (Hex)		
Get-Contrast	8		g	a	61	000 ~ 100	
Get-Sharpness	8		g	c	63	000 ~ 100	
Get-Color	8		g	d	64	000 ~ 100	
Get-Tint	8		g	e	65	000 ~ 100	
Get-Backlight On_Off *3.2.3	8		g	h	68	000: OFF 001: ON	Keep both "Backlight On_Off" and "Function On_Off" for backward compatibility *3.3.2
Get Freeze On_Off *3.2.5	8		g	i	69	000: OFF 001: ON	Keep both "Freeze On_Off" and "Function On_Off" for backward compatibility *3.3.2
Get-PIP mode	8		g	t	74	000: OFF 001: PIP (POP) 002: PBP	
Get-PIP input	8		g	u	75	000 ~	See Set-input select
Get-Tiling Mode	8		g	v	76	000: OFF 001: ON	(for Video wall)
Get-Tiling Compensation	8		g	w	77	000: OFF 001: ON	(for Video wall) Bezel width compensation
Get-Tiling H by V monitors	8		g	x	78	01x~09x: H monitors 0x1~0x9: V monitors	(for Video wall) 1. 2nd digital for H monitors 2. 3rd digital for V monitors
Get-Tiling position	8		g	y	79	000: OFF 001~025	(for Video wall) Copy the screen of Position# to identified display
Get-Date: Year	8		g	2	32	Y00~Y00	Last 2 digits (20)17~(20)99
Get-Date: Month	8		g	2	32	M00~M00	2 digits
Get-Date: Day	8		g	2	32	D00~M00	2 digits
Get-Time: Hour	8		g	3	33	H00~H00	24-hr format. 2 digits
Get-Time: Min	8		g	3	33	M00~M00	2 digits
Get-Time: Sec	8		g	3	33	S00~S00	2 digits
Get-Smart hub *3.3.0	8		g	:	3A	000: all 00A: Amb_Temp 00B: Amb_Humidity 00C: Amb_Light 00D: Amb_PIR detection	1. Reply in new 32-byte format. Each sub-item length is fixed 6 bytes. *3.3.0 2. Allow get data separately or once for all. *3.3.0

Get Function	Length	ID	Command	Command	Response Range	Comments
Get-Function On_ Off *3.3.2	8		G	=	3D	001: Backlight OFF 101: Backlight ON 002: Freeze OFF 102: Freeze ON 003: Touch OFF 103: Touch ON

NOTE:

1. Get Date example

Assumed the current date of display#01 as below:

Date: 2017-3/15

Send: 0x 38 30 31 67 32 59 30 30 0D (Get Date:Year)

Reply: 0x 38 30 31 72 32 59 31 37 0D ("Y17")

Send: 0x 38 30 31 67 32 4D 30 30 0D (Get Date:Month)

Reply: 0x 38 30 31 72 32 4D 30 33 0D ("M03")

Send: 0x 38 30 31 67 32 44 30 30 0D (Get Date:Day)

Reply: 0x 38 30 31 72 32 44 31 35 0D ("D15")

2. Get Time example

Assumed the current time of display#01 as below:

Time: 16:27:59

Send: 0x 38 30 31 67 33 48 30 30 0D (Get Time:Hour)

Reply: 0x 38 30 31 72 33 48 31 36 0D ("H16")

Send: 0x 38 30 31 67 33 4D 30 30 0D (Get Time:Min)

Reply: 0x 38 30 31 72 33 4D 32 37 0D ("M27")

Send: 0x 38 30 31 67 33 53 30 30 0D (Get Time:Sec)

Reply: 0x 38 30 31 72 33 53 35 39 0D ("S59")

3. Get Smart hub example

Assumed Amb_Temp is -5 deg C, Amb_Humidity is 30%, Amb_Light is 80, Amb_PIR detection is 1

Send: 0x 38 30 31 67 3A 30 30 30 0D (Get all Smart hub info)

Reply: 0x 32 30 31 72 3A 41 2D 30 35 2E 30 42 30 33 30 2E 30 43 30 30 30 38 30 44 30 30 30 30 31 00 00 00 0D (A-05.0B030.0C00080D00001)

Send: 0x 38 30 31 67 3A 30 30 41 0D (Get Amb_Temp only)

Reply: 0x 32 30 31 72 3A 41 2D 30 35 2E 30 00 00 ...00 00 0D (A-05.0)

C. Auto Reply *3.2.1

The display will send out the updated data/status automatically without GET query from the host whenever the following data/status is changed by the user through any of the available ways like: remote control unit, front control panel keys, or touch screen.

- Power On/Off
- Input Select
- Brightness
- Backlight
- Volume
- Mute On/Off

Remote Control Pass-through Mode

When the PC sets the Display to Remote Control Pass through mode, the Display will send a 7-byte packet (followed by “CR”) in response to remote control unit (RCU) button activation.

In this mode the RCU will have no effect on the Display function. For example: “Volume+” will not change the volume of the Display, but instead only send the “Volume+” code to the PC over the RS-232 port.

IR Pass Through-Function format

Reply: (Command Type=“p”)

Name	Length	ID	Command Type	RCU Code1 (MSB)	RCU Code2 (LSB)	CR
Byte Count	1 Byte	2 Byte	1 Byte	1 Byte	1 Byte	1 Byte
Bytes order	1	2~3	4	5	6	7

Example 1: Remote Control Pass-through when “VOL+” key is pressed for Display (#5)

Send (Hex Format)

Name	Length	ID	Command Type	RCU Code1 (MSB)	RCU Code2 (LSB)	CR
Hex	0x36	0x30 0x35	0x70	0x31	0x30	0x0D

Key	Code (HEX)	Basic ^{*3.1.1}	Optional ^{*3.1.1}
1	01	V	
2	02	V	
3	03	V	
4	04	V	
5	05	V	
6	06	V	
7	07	V	
8	08	V	
9	09	V	
0	0A	V	
-	0B		V
RECALL (LAST)	0C		V
INFO (DISPLAY)	0D		V
	0E		
ASPECT (ZOOM, SIZE)	0F		V
VOLUME UP (+)	10	V	
VOLUME DOWN (-)	11	V	
MUTE	12	V	
CHANNEL/PAGE UP (+)/ BRIGHTNESS+	13		V
CHANNEL/PAGE DOWN (-)/ BRIGHTNESS-	14		V
POWER	15	V	
SOURCES (INPUTS)	16	V	
	17		
	18		
SLEEP	19		V
MENU	1A	V	
UP	1B	V	
DOWN	1C	V	
LEFT (-)	1D	V	
RIGHT (+)	1E	V	
OK (ENTER, SET)	1F	V	
EXIT	20	V	
	21		
	22		
	23		
	24		
	25		
	26		
	27		
	28		
	29		

Key	Code (HEX)	Basic ^{*3.1.1}	Optional ^{*3.1.1}
	2A		
	2B		
RED ■ (F1)	2C		V
GREEN ■ (F2)	2D		V
YELLOW ■ (F3)	2E		V
BLUE ■ (F4)	2F		V

NOTE:

1. This IR-pass-through code is different from the RCU key code.
2. Special control sequence for POWER key under IR-pass through mode.
 - 2-1. When Display is OFF and receives the IR POWER code: Display will turn itself ON, then forward the POWER code to the host via RS-232.
 - 2-2. When Display is ON and receives the IR POWER code: Display will forward the POWER code to the host via RS-232, then turn OFF itself.
 - 2-3. When SET-POWER LOCK is enabled, the Display will not respond to POWER key pressing.
3. The VOLUME UP and VOLUME DOWN code will repeatedly output when you press and hold the keys.

Appendix

USB Media Support Format

Photo

Image	Photo	Resolution
JPEG	Base-line	1920 x 1080
	Progressive	1024 x 768
PNG	non-interlace	1920 x 1080
	Interlace	1920 x 1080
BMP		15360 x 8640

Video

Container	Codec	Resolution	Bit Rate
MKV(.mkv) WebM(.webm)	VP9	4096 x 2176 @60 FPS	100 Mbps
MP4(.mp4, .mov) 3GPP(.3gpp, .3gp) MEPG transport stream (.ts, .trp, .tp) MKV(.mkv) WebM(.webm) FLV(.flv) AVI(lavi) H265(.265)	HEVC/H.265	4096 x 2176 @60 FPS	100 Mbps
MP4(.mp4, .mov) 3GPP(.3gpp, .3gp) MEPG transport stream (.ts, .trp, .tp) MPEG program stream (.DAT, .VOB, .MPG, .MPEG) MKV(.mkv) WebM(.webm) AVI(lavi) ASF(.asf) WMV(.wmv) OGM(.ogm)	MPEG1/2	1920 x 1080 @120 FPS	40 Mbps

Container	Codec	Resolution	Bit Rate
MP4(.mp4, .mov) 3GPP(.3gpp, .3gp) MEPG transport stream (.ts, .trp, .tp) MPEG program stream (.DAT, .VOB, .MPG, .MPEG) MKV(.mkv) WebM(.webm) FLV(.flv) AVI(lavi) ASF(.asf) WMV(.wmv) OGM(.ogm)	MPEG4	1920 x 1080 @120 FPS	40 Mbps
ASF(.asf) AVI(.avi) DivX(.divx) MKV(.mkv) MP4(.mp4, .mov) OGM(.ogm) WebM(.webm) WMV(.wmv)	DivX 3.11 Divx 4.12 DivX 5.x DivX 6, XviD	1920 x 1080 @120 FPS	40 Mbps
AVI(.avi) FLV(.flv)	Sorenson H.263	1920 x 1080 @120 FPS	40 Mbps
3GPP(.3gpp, .3gp) ASF(.asf) AVI(lavi) FLV(.flv) MP4(.mp4, mov) WMV(.wmv)	H.263	1920 x 1080 @120 FPS	40 Mbps

Container	Codec	Resolution	Bit Rate
3GPP(.3gpp, .3gp) ASF(.asf) AVI(lavi) FLV(.flv) H.264(.264) MKV(.mkv) MP4(.mp4, .mov) MEPG transport stream (.ts, .trp, .tp) MPEG program stream (.DAT, .VOB, .MPG, .MPEG) OGM(.ogm) WebM(.webm) WMV(.wmv)	H.264	4096 x 2160 @60 FPS	135 Mbps
AVS(.avs) MEPG transport stream (.ts, .trp, .tp)	AVS	1920 x 1080 @60 FPS	50 Mbps
AVS(.avs) MEPG transport stream (.ts, .trp, .tp)	AVS+	1920 x 1080 @60 FPS	50 Mbps
AVS(.avs2) MEPG transport stream (.ts, .trp, .tp)	AVS2	4096 x 2160 @60 FPS	100 Mbps
3GPP(.3gpp, .3gp) ASF(.asf) AVI(.avi) MKV(.mkv) MP4(.mp4, .mov) OGM(.ogm) WebM(.webm) WMV(.wmv)	WMV3	1920 x 1080 @120 FPS	40 Mbps

Container	Codec	Resolution	Bit Rate
3GPP(.3gpp, .3gp) ASF(.asf) AVI(.avi) MKV(.mkv) MP4(.mp4, .mov) MEPG transport stream (.ts, .trp, .tp) WebM(.webm) WMV(.wmv) VC1(.vc1)	VC1	2048 x 1024 @120 FPS	40 Mbps
3GPP(.3gpp, 3gp) AVI(.avi) FLV(.flv) MKV(.mkv) MP4(.mp4, .mov) OGM(.gom) WebM(.webm)	Motion JPEG	1920 x 1080 @30 FPS	40 Mbps
3GPP(.3gpp, .3gp) AVI(.avi) FLV(.flv) MKV(.mkv) MP4(.mp4, .mov) OGM(.gom) WebM(.webm)	VP8	1920 x 1080 @60 FPS	50 Mbps
MKV(.mkv) RM(.rm, .rmvb) WebM(.webm)	RV30/RV40	1920 x 1080 @60 FPS	40 Mbps
3GPP(.3gpp, .3gp) MKV(.mkv) MP4(.mp4, .mov) WebM(.webm)	AV1	4096 x 2176 @60 FPS	100 Mbps

Audio

Container	Codec	Sample Rate	Channel	Bit Rate
3GPP(.3gpp, .3gp) ASF(.asf) AVI(.avi) DivX(.divx) FLV(.flv)	MPEG1/2 Layer1	16 kHz~48 kHz	Up to 2	32 kbps~448 kbps
MKV(.mkv, .mka) MP3(.mp3) MP4(.mp4) MEPG transport stream (.ts, .trp, .tp)	MPEG1/2 Layer2	16 kHz~48 kHz	Up to 2	8 kbps~384 kbps
MPEG program stream(.DAT, .VOB, .MPG, .MPEG) OGM(.ogm) WAV(.wav) WebM(.webm) WMV(.wmv)	MPEG1/2/2.5 Layer3	8 kHz~ 48 kHz	Up to 2	8 kbps~320 kbps
3GPP(.3gpp, .3gp) ASF(.asf) AVI(.avi) AC3(.ac3) DivX(.divx) MKV(.mkv, .mka) MP4(.mp4) MEPG transport stream (.ts, .trp, .tp) MPEG program stream (.DAT, .VOB, .MPG, .MPEG) OGM(.ogm) WebM(.webm) WMV(.wmv)	AC3(DD)	32 kHz, 44.1 kHz, 48 kHz	Up to 5.1	32 kbps~640 kbps

Container	Codec	Sample Rate	Channel	Bit Rate
3GPP(.3gpp, .3gp) ASF(.asf) AVI(.avi) DivX(.divx) EAC3(.ec3) MKV(.mkv, .mka) MP4(.mp4) MEPG transport stream (.ts, .trp, .tp) MPEG program stream (.DAT, .VOB, .MPG, .MPEG)	EAC3(DDP)	32 kHz, 44.1 kHz, 48 kHz	Up to 5.1	32 kbps~6 Mbps
OGM(.ogm) WebM(.webm) WMV(.wmv)	EAC3(DDP)	32 kHz, 44.1 kHz, 48 kHz	Up to 5.1	32 kbps~6 Mbps
3GPP(.3gpp, .3gp) AAC(.aac) ASF(.asf) AVI(.avi) DivX(.divx) FLV(.flv) MKV(.mkv, .mka) MP4(.mp4) MEPG transport stream (.ts, .trp, .tp) MPEG program stream (.DAT, .VOB, .MPG, .MPEG) OGM(.ogm) RM(.rm, .rmvb, .ra) WAV(.wav) WebM(.webm) WMV(.wmv)	AAC-LC, HEAAC	8 kHz~ 48 kHz	Up to 5.1	AAC-LC: 12 kbps~576 kbps V1: 6 kbps~288 kbps V2: 3 kbps~144 kbps

Container	Codec	Sample Rate	Channel	Bit Rate
3GPP(.3gpp, .3gp) ASF(.asf) AVI(.avi) MKV(.mkv, .mka) MP4(.mp4, .mov) WebM(.webm) WMV(.wma, .wmv)	WMA	8 kHz~48 kHz	Up to 2	128 kbps~320 kbps
3GPP(.3gpp, .3gp) ASF(.asf) AVI(.avi) MP4(.mp4, .mov) WMV(.wma, .wmv)	WMA 10 Pro M0	8 kHz~48 kHz	Up to 2	< 192 kbps
	WMA 10 Pro M1	8 kHz~48 kHz	Up to 5.1	< 384 kbps
	WMA 10 Pro M2	8 kHz~96 kHz	Up to 5.1	< 768 kbps
3GPP(.3gpp, .3gp) ASF(.asf) AVI(.avi) MKV(.mkv, .mka) MP4(.mp4, .mov) Ogg(.ogg) WebM(.webm) WMV(.wma, .wmv)	VORBIS *Support stereo decoding only	Up to 48 kHz	Up to 2	

Container	Codec	Sample Rate	Channel	Bit Rate
3GPP(.3gpp, .3gp) AVI(.avi) DTS(.dts) MKV(.mkv, .mka) MP4(.mp4, .mov) MEPG transport stream (.ts, .trp, .tp) MPEG program stream (.DAT, .VOB, .MPG, .MPEG) OGM(.ogm) WAV(.wav) WebM(.webm)	DTS	Up to 48 kHz	Up to 5.1	< 1.5 Mbps (Pure DTS core)
3GPP(.3gpp, .3gp) MP4(.mp4, .mov) MEPG transport stream (.ts, .trp, .tp)	DTS LBR	12 kHz, 22 kHz, 24 kHz, 44.1 kHz, 48 kHz	Up to 5.1	Up to 2 Mbps
3GPP(.3gpp, .3gp) MP4(.mp4, .mov) MEPG transport stream (.ts, .trp, .tp, .mts, .m2ts)	DTS XLL	Up to 96 kHz	Up to 6	Up to 6.123 Mbps
3GPP(.3gpp, .3gp) MP4(.mp4, .mov) MEPG transport stream (.ts, .trp, .tp, .mts, .m2ts)	DTS Master Audio	Up to 48 kHz	Up to 6	Up to 24.537 Mbps

Container	Codec	Sample Rate	Channel	Bit Rate
3GPP(.3gpp, .3gp) ASF(.asf) AVI(.avi) FLV(.flv) MKV(.mkv, .mka) MP4(.mp4, .mov, .m4a) MEPG transport stream (.ts, .trp, .tp) MPEG program stream (.DAT, .VOB, .MPG, .MPEG) OGM(.ogm) WAV(.wav) WebM(.webm) WMV(.wmv)	LPCM	8 kHz~48 kHz	Mono, Stereo 5.1	64 kbps~1.5 Mbps
AVI(.avi) MKV(.mkv, .mka) OGM(.ogm) WAV(.wav) WebM(.webm)	IMA-ADPCM MS)ADPCM	8 kHz~48 kHz	Up to 2	32 kbps~384 kbps
AVI(.avi) FLV(.flv) MKV(.mkv, .mka) WAV(.wav) WebM(.webm)	G711 A /mu-law	8 kHz	1	64 kbps
RM(.rm, .rmvb, .ra)	LBR(cook)	8 kHz, 11.025 kHz, 22.05 kHz, 44.1 kHz	Up to 5.1	6 kbps~128 kbps
FLAC(.flac) MKV(.mkv, .mka) WebM(.webm)	FLAC	8 kHz~96 kHz	Up to 7.1	< 1.6 Mbps
MKV(.mkv, .mka) WebM(.webm)	OPUS	8 kHz~48 kHz	Up to 6	6 kbps~510 kbps

Container	Codec	Sample Rate	Channel	Bit Rate
3GPP(.3gpp, 3gp) AC4(.ac4) MP4(.mp4, .mov, .m4a) MEPG transport stream (.ts, .trp, .tp)	AC4	44.1 kHz, 48 kHz	Up to 5.1 (MS12 v1.x) Up to 7.1 (MS12 v2.x)	Up to 1521 kbps per presentation
3GPP(.3gpp, .3gp) MP4(.mp4, .mov, .m4a)	Fraunhofer MPEG-H TV Audio System	32 kHz, 44.1 kHz, 48 kHz	Up to 16 core channels Up to 5.1 channels output	1.2 Mbps
3GPP(.3gpp, .3gp) MP4(.mp4, .mov, .m4a)	AMR-NB	8 kHz	1	4.75~12.2 kbps
3GPP(.3gpp, .3gp) MP4(.mp4, .mov, .m4a)	AMR-WB	16 kHz	1	6.6~23.85 kbps

Subtitle

Internal

File Extension	Container	Codec
dat, mpg, mpeg, vob	MPG, MPEG	DVD Subtitle
ts, trp, tp	TS	DVB Subtitle
mp4	MP4	DVD Subtitle UTF-8 Plain Text
mkv	MKV	ASS SSA UTF-8 Plain Text VobSub DVD Subtitle
divx, avi	AVI(1.0, 2.0) DMF0, 1, 2	XSUB XSUB+

External

File Extension	Container	Codec
.srt	SubRip	
.ssa/.ass	SubStation Alpha	
.smi	SAMI	
.sub	SubViewer MicroDVD DVDSubtitleSystem SubIdx(VobSub)	SubViewer 1.0 & 2.0 Only
.txt	TMPlayer	

Timing Table

HDMI PC

Resolution	Refresh Rate
640 x 480	60 Hz
	72 Hz
800 x 600	75 Hz
	72 Hz
	75 Hz
1024 x 768	60 Hz
	70 Hz
	75 Hz
1280 x 1024	60 Hz
1360 x 768	60 Hz
1920 x 1080	60 Hz

HDMI

Video	Resolution	Refresh Rate
480i	720 x 480	60 Hz
480p	720 x 480	60 Hz
576i	720 x 576	50 Hz
576p	720 x 576	50 Hz
720p	1280 x 720	50 Hz
		60 Hz
1080i	1920 x 1080	50 Hz
		60 Hz
1080p	1920 x 1080	50 Hz
		60 Hz
4K	3840 x 2160	29.97 Hz/R444
	3840 x 2160	30 Hz/R444
	3840 x 2160	25 Hz/R444
	3840 x 2160	23.98 Hz/R444
	3840 x 2160	24 Hz/R444
	4096 x 2160	24 Hz/R444
	3840 x 2160	50 Hz/R444
	3840 x 2160	59 Hz/R444
	3840 x 2160	60 Hz/R444
	4096 x 2160	50 Hz/R444
	4096 x 2160	59 Hz/R444
	4096 x 2160	60 Hz/R444

Type C

Video	Resolution	Refresh Rate
480p (4:3)	640 x 480	60 Hz
	640 x 480	60 Hz
	720 x 480	60 Hz
	1440 x 480	60 Hz
480p (16:9)	720 x 480	60 Hz
	1440 x 480	60 Hz
	1440 x 480	60 Hz
576p (4:3)	720 x 576	50 Hz
576p (16:9)	720 x 576	50 Hz
	1440 x 576	50 Hz
720p (16:9)	1280 x 720	50 Hz
	1280 x 720	60 Hz
	1280 x 720	60 Hz
1080p (16:9)	1920 x 1080	24 Hz
	1920 x 1080	24 Hz
	1920 x 1080	25 Hz
	1920 x 1080	30 Hz
	1920 x 1080	30 Hz
	1920 x 1080	50 Hz
	1920 x 1080	60 Hz
	1920 x 1080	60 Hz
4K	3840 x 2160	24 Hz
	3840 x 2160	25 Hz
	3840 x 2160	30 Hz
	3840 x 2160	50 Hz
	3840 x 2160	60 Hz

Troubleshooting

This section describes some common problems that you may experience when using the display.

Problem or Issue	Possible Solutions
Remote Control is not working	<ol style="list-style-type: none">1. Check whether something is obstructing the display's remote control receiver.2. Check whether the batteries in the remote control are installed correctly.3. Check whether the batteries need to be replaced.
The unit turns off unexpectedly	<ol style="list-style-type: none">1. Check whether Sleep mode is enabled.2. Check if there is a power outage in your area.3. Turn on the display and see if the problem is with the signal and control system.

PC Mode

Problem or Issue	Possible Solutions
No PC signal	<ol style="list-style-type: none">1. Check the display settings.2. Check the display resolution.3. Adjust the Hs & Vs (synchronization) settings using the OSD menu.4. Check the OPS resolution. Please make sure the OPS is set to the correct resolution.
Background streaking	<ol style="list-style-type: none">1. Choose auto adjust.2. Adjust clock and phase.
False color	<ol style="list-style-type: none">1. Check the connection.2. Adjust the chroma, brightness, and contrast settings.
Unsupported format	<ol style="list-style-type: none">1. Choose auto adjust.2. Adjust clock and phase settings.

Video Not Working Properly

Problem or Issue	Possible Solutions
No picture/ No sound	<ol style="list-style-type: none">1. Check the Power status.2. Check the signal cable.3. Check that the internal PC is installed correctly.
Picture is unclear or cuts in and out	<ol style="list-style-type: none">1. Check the signal cable.2. Check if other electronics are interrupting the signal.
Poor picture	<ol style="list-style-type: none">1. Adjust chroma, brightness, and contrast settings in the menu.2. Check the signal cable.

Audio Not Working Properly

Problem or Issue	Possible Solutions
No sound	<ol style="list-style-type: none">1. Press the Mute/Unmute button.2. Adjust the volume.3. Check the audio cable.
One speaker only	<ol style="list-style-type: none">1. Adjust the sound balance in the menu.2. Check the sound control panel settings of the computer.3. Check the audio cable.

Maintenance

General Precautions

- Make sure the device is turned off and the power cable is unplugged from the power outlet.
- Never spray or pour any liquid directly onto the screen or case.
- Handle the device with care, as a darker-colored device, if scuffed, may show marks more clearly than a lighter-colored device.
- Do not use the system continuously for long periods of time.

Cleaning the Screen

- Wipe the screen with a clean, soft, lint-free cloth. This removes dust and other particles.
- If the screen is still not clean, apply a small amount of non-ammonia, non-alcohol based glass cleaner onto a clean, soft, lint-free cloth; then wipe the screen.

Cleaning the Case

- Use a soft, dry cloth.
- If the case is still not clean, apply a small amount of non-ammonia, non-alcohol based, mild non-abrasive detergent onto a clean, soft, lint-free cloth, then wipe the surface.

Disclaimer

- ViewSonic® does not recommend the use of any ammonia or alcohol-based cleaners on the display screen or case. Some chemical cleaners have been reported to damage the screen and/or case of the device.
- ViewSonic® will not be liable for damage resulting from use of any ammonia or alcohol-based cleaners.

NOTE: If condensation appears between the glass and the panel, keep the display turned on until the moisture disappears.

Regulatory and Service Information

Compliance Information

This section addresses all connected requirements and statements regarding regulations. Confirmed corresponding applications shall refer to nameplate labels and relevant markings on the unit.

FCC Compliance Statement

This device complies with part 15 of FCC Rules. Operation is subject to the following two conditions: (1) this device may not cause harmful interference, and (2) this device must accept any interference received, including interference that may cause undesired operation.

This equipment has been tested and found to comply with the limits for a Class B digital device, pursuant to part 15 of the FCC Rules. These limits are designed to provide reasonable protection against harmful interference in a residential installation. This equipment generates, uses, and can radiate radio frequency energy, and if not installed and used in accordance with the instructions, may cause harmful interference to radio communications. However, there is no guarantee that interference will not occur in a particular installation. If this equipment does cause harmful interference to radio or television reception, which can be determined by turning the equipment off and on, the user is encouraged to try to correct the interference by one or more of the following measures:

- Reorient or relocate the receiving antenna.
- Increase the separation between the equipment and receiver.
- Connect the equipment into an outlet on a circuit different from that to which the receiver is connected.
- Consult the dealer or an experienced radio/TV technician for help.

Warning: You are cautioned that changes or modifications not expressly approved by the party responsible for compliance could void your authority to operate the equipment.

Industry Canada Statement

CAN ICES (B) / NMB (B)

CE Conformity for European Countries



The device complies with the EMC Directive 2014/30/EU and Low Voltage Directive 2014/35/EU.

The following information is only for EU-member states:

The mark shown to the right is in compliance with the Waste Electrical and Electronic Equipment Directive 2012/19/EU (WEEE). The mark indicates the requirement NOT to dispose of the equipment as unsorted municipal waste, but use the return and collection systems according to local law.



Declaration of RoHS2 Compliance

This product has been designed and manufactured in compliance with Directive 2011/65/EU of the European Parliament and the Council on restriction of the use of certain hazardous substances in electrical and electronic equipment (RoHS2 Directive) and is deemed to comply with the maximum concentration values issued by the European Technical Adaptation Committee (TAC) as shown below:

Substance	Proposed Maximum Concentration	Actual Concentration
Lead (Pb)	0.1%	< 0.1%
Mercury (Hg)	0.1%	< 0.1%
Cadmium (Cd)	0.01%	< 0.01%
Hexavalent Chromium (Cr6 ⁺)	0.1%	< 0.1%
Polybrominated biphenyls (PBB)	0.1%	< 0.1%
Polybrominated diphenyl ethers (PBDE)	0.1%	< 0.1%
Bis (2-ethylhexyl) phthalate (DEHP)	0.1%	< 0.1%
Butyl benzyl phthalate (BBP)	0.1%	< 0.1%
Dibutyl phthalate (DBP)	0.1%	< 0.1%
Diisobutyl phthalate (DIBP)	0.1%	< 0.1%

Certain components of products as stated above are exempted under the Annex III of the RoHS2 Directives as noted below. Examples of exempted components are:

- Copper alloy containing up to 4% lead by weight.
- Lead in high melting temperature type solders (i.e. lead-based alloys containing 85% by weight or more lead).
- Electrical and electronic components containing lead in a glass or ceramic other than dielectric ceramic in capacitors, e.g. piezoelectronic devices, or in a glass or ceramic matrix compound.
- Lead in dielectric ceramic in capacitors for a rated voltage of 125V AC or 250V DC or higher.

ENERGY STAR Statement

ENERGY STAR is a U.S. Environmental Protection Agency voluntary program that helps businesses and individuals save money and protect our climate through superior energy efficiency. Products that earn the ENERGY STAR prevent greenhouse gas emissions by meeting strict energy efficiency criteria or requirements set by the U.S. Environmental Protection Agency.

As an ENERGY STAR Partner, ViewSonic is determined to meet the Energy star Guidelines and mark all certified models with the ENERGY STAR logo.

The following logo appears on all ENERGY STAR-certified models:



NOTE: The power management features significantly reduce energy consumption when the product is not in use. Power management allows the device to automatically enter a low power “sleep” mode after a defined period of inactivity. And the power management features also enter Sleep Mode or Off Mode within 5 minutes of being disconnected from a host computer. Please note any change in energy settings will increase energy consumption.

Indian Restriction of Hazardous Substances

Restriction on Hazardous Substances statement (India). This product complies with the “India E-waste Rule 2011” and prohibits use of lead, mercury, hexavalent chromium, polybrominated biphenyls or polybrominated diphenyl ethers in concentrations exceeding 0.1 weight % and 0.01 weight % for cadmium, except for the exemptions set in Schedule 2 of the Rule.

Product Disposal at End of Product Life

ViewSonic® respects the environment and is committed to working and living green. Thank you for being part of Smarter, Greener Computing. Please visit the ViewSonic® website to learn more.

USA & Canada:

<https://www.viewsonic.com/us/go-green-with-viewsonic>

Europe:

<https://www.viewsonic.com/eu/environmental-social-governance/recycle>

Taiwan:

<https://recycle.moenv.gov.tw/>

For EU users, please contact us for any safety/accident issue experienced with this product:

ViewSonic Europe Limited



Haaksbergweg 75
1101 BR Amsterdam
Netherlands



+31 (0) 650608655



EPREL@viewsoniceurope.com



<https://www.viewsonic.com/eu/>

Copyright Information

Copyright© ViewSonic® Corporation, 2024. All rights reserved.

Macintosh and Power Macintosh are registered trademarks of Apple Inc.

Microsoft, Windows, and the Windows logo are registered trademarks of Microsoft Corporation in the United States and other countries.

ViewSonic® and the three birds logo are registered trademarks of ViewSonic® Corporation.

VESA is a registered trademark of the Video Electronics Standards Association. DPMS, DisplayPort, and DDC are trademarks of VESA.

ENERGY STAR® is a registered trademark of the U.S. Environmental Protection Agency (EPA).

As an ENERGY STAR® partner, ViewSonic® Corporation has determined that this product meets the ENERGY STAR® guidelines for energy efficiency.

Disclaimer: ViewSonic® Corporation shall not be liable for technical or editorial errors or omissions contained herein; nor for incidental or consequential damages resulting from furnishing this material, or the performance or use of this product.

In the interest of continuing product improvement, ViewSonic® Corporation reserves the right to change product specifications without notice. Information in this document may change without notice.

No part of this document may be copied, reproduced, or transmitted by any means, for any purpose without prior written permission from ViewSonic® Corporation.

Customer Service

For technical support or product service, see the table below or contact your reseller.

NOTE: You will need the product's serial number.

Country/Region	Website	Country/Region	Website
Asia Pacific & Africa			
Australia	www.viewsonic.com/au/	Bangladesh	www.viewsonic.com/bd/
中国 (China)	www.viewsonic.com.cn	香港 (繁體中文)	www.viewsonic.com/hk/
Hong Kong (English)	www.viewsonic.com/hk-en/	India	www.viewsonic.com/in/
Indonesia	www.viewsonic.com/id/	Israel	www.viewsonic.com/il/
日本 (Japan)	www.viewsonic.com/jp/	Korea	www.viewsonic.com/kr/
Malaysia	www.viewsonic.com/my/	Middle East	www.viewsonic.com/me/
Myanmar	www.viewsonic.com/mm/	Nepal	www.viewsonic.com/np/
New Zealand	www.viewsonic.com/nz/	Pakistan	www.viewsonic.com/pk/
Philippines	www.viewsonic.com/ph/	Singapore	www.viewsonic.com/sg/
臺灣 (Taiwan)	www.viewsonic.com/tw/	ประเทศไทย	www.viewsonic.com/th/
Việt Nam	www.viewsonic.com/vn/	South Africa & Mauritius	www.viewsonic.com/za/
Americas			
United States	www.viewsonic.com/us	Canada	www.viewsonic.com/us
Latin America	www.viewsonic.com/la		
Europe			
Europe	www.viewsonic.com/eu/	France	www.viewsonic.com/fr/
Deutschland	www.viewsonic.com/de/	Қазақстан	www.viewsonic.com/kz/
Россия	www.viewsonic.com/ru/	España	www.viewsonic.com/es/
Türkiye	www.viewsonic.com/tr/	Україна	www.viewsonic.com/ua/
United Kingdom	www.viewsonic.com/uk/		

Limited Warranty

ViewSonic® Display

What the warranty covers:

ViewSonic® warrants its products to be free from defects in material and workmanship during the warranty period. If a product proves to be defective in material or workmanship during the warranty period, ViewSonic® will, at its sole option, and as your sole remedy, repair or replace the product with a similar product. Replacement Product or parts may include remanufactured or refurbished parts or components. The repair or replacement unit or parts or components will be covered by the balance of the time remaining on the customer's original limited warranty and the warranty period will not be extended. ViewSonic® provides no warranty for any third-party software whether included with the product or installed by the customer, installation of any unauthorized hardware parts or components (e.g. Projector Lamps). (Please refer to: "What the warranty excludes and does not cover" section).

How long the warranty is effective:

ViewSonic® displays are warranted for between 1 and 3 years, depending on your country of purchase, for all parts including the light source and for all labor from the date of the first consumer purchase.

Who the warranty protects:

This warranty is valid only for the first consumer purchaser.

What the warranty excludes and does not cover:

- Any product on which the serial number has been defaced, modified, or removed.
- Damage, deterioration, or malfunction resulting from:
 - » Accident, misuse, neglect, fire, water, lightning, or other acts of nature, unauthorized product modification, or failure to follow instructions supplied with the product.
 - » Repair or attempted repair by anyone not authorized by ViewSonic®.
 - » Damage to or loss of any programs, data, or removable storage media.
 - » Normal wear and tear.
 - » Removal or installation of the product.
- Software or data loss occurring during repair or replacement.

- Any damage of the product due to shipment.
- Causes external to the product, such as electric power fluctuations or failure.
- Use of supplies or parts not meeting ViewSonic's specifications.
- Failure of owner to perform periodic product maintenance as stated in the User Guide.
- Any other cause which does not relate to a product defect.
- Damage caused by static (non-moving) images displayed for lengthy periods of time (also referred to as image burn-in).
- Software - Any third-party software included with the product or installed by the customer.
- Hardware/Accessories/Parts/Components – Installation of any unauthorized hardware, accessories, consumable parts or components (e.g. Projector Lamps).
- Damage to, or abuse of, the coating on the surface of the display through inappropriate cleaning as described in the product User Guide.
- Removal, installation, and set-up service charges, including wall-mounting of the product.

How to get service:

- For information about receiving service under warranty, contact ViewSonic® Customer Support (Please refer to the "Customer Service" page). You will need to provide your product's serial number.
- To obtain warranty service, you will be required to provide: (a) the original dated sales slip, (b) your name, (c) your address, (d) a description of the problem, and (e) the serial number of the product.
- Take or ship the product, freight prepaid, in the original container to an authorized ViewSonic® service center or ViewSonic®.
- For additional information or the name of the nearest ViewSonic® service center, contact ViewSonic®.

Limitation of implied warranties:

There are no warranties, express or implied, which extend beyond the description contained herein including the implied warranty of merchantability and fitness for a particular purpose.

Exclusion of damages:

ViewSonic's liability is limited to the cost of repair or replacement of the product. ViewSonic® shall not be liable for:

- Damage to other property caused by any defects in the product, damages based upon inconvenience, loss of use of the product, loss of time, loss of profits, loss of business opportunity, loss of goodwill, interference with business relationships, or other commercial loss, even if advised of the possibility of such damages.
- Any other damages, whether incidental, consequential or otherwise.
- Any claim against the customer by any other party.
- Repair or attempted repair by anyone not authorized by ViewSonic®.

Effect of state law:

This warranty gives you specific legal rights, and you may also have other rights which vary from state to state. Some states do not allow limitations on implied warranties and/or do not allow the exclusion of incidental or consequential damages, so the above limitations and exclusions may not apply to you.

Sales outside the U.S.A. and Canada:

For warranty information and service on ViewSonic® products sold outside of the U.S.A. and Canada, contact ViewSonic® or your local ViewSonic® dealer.

The warranty period for this product in mainland China (Hong Kong, Macao, and Taiwan Excluded) is subject to the terms and conditions of the Maintenance Guarantee Card.

For users in Europe and Russia, full details of warranty provided can be found at: <http://www.viewsonic.com/eu/> under "Support/Warranty Information".

Mexico Limited Warranty

ViewSonic® Display

What the warranty covers:

ViewSonic® warrants its products to be free from defects in material and workmanship, under normal use, during the warranty period. If a product proves to be defective in material or workmanship during the warranty period, ViewSonic® will, at its sole option, repair or replace the product with a like product. Replacement product or parts may include remanufactured or refurbished parts or components & accessories.

How long the warranty is effective:

ViewSonic® LCD displays are warranted for between 1 and 3 years, depending on your country of purchase, for all parts including the light source and for all labour from the date of the first consumer purchase.

Who the warranty protects:

This warranty is valid only for the first consumer purchaser.

What the warranty excludes and does not cover:

- Any product on which the serial number has been defaced, modified or removed.
- Damage, deterioration, or malfunction resulting from:
 - » Accident, misuse, neglect, fire, water, lightning, or other acts of nature, unauthorized product modification, unauthorized attempted repair, or failure to follow instructions supplied with the product.
 - » Causes external to the product, such as electrical power fluctuations or failure.
 - » Use of supplies or parts not meeting ViewSonic®'s specifications.
 - » Normal wear and tear.
 - » Any other cause which does not relate to a product defect.
- Any product exhibiting a condition commonly known as “image burn-in” which results when a static image is displayed on the product for an extended period of time.
- Removal, installation, insurance, and set-up service charges.

How to get service:

For information about receiving service under warranty, contact ViewSonic® Customer Support (Please refer to the attached “Customer Service” page). You will need to provide your product’s serial number, so please record the product information in the space provided below on your purchase for your future use. Please retain your receipt of proof of purchase to support your warranty claim.

For Your Records

Product Name: _____ Model Number: _____

Document Number: _____ Serial Number: _____

Purchase Date: _____ Extended Warranty Purchase? _____ (Y/N)

If so, what date does warranty expire? _____

- To obtain warranty service, you will be required to provide (a) the original dated sales slip, (b) your name, (c) your address, (d) a description of the problem, and (e) the serial number of the product.
- Take or ship the product, in the original container packaging, to an authorized ViewSonic® service center.
- Round trip transportation costs for in-warranty products will be paid by ViewSonic®.

Limitation of implied warranties:

There are no warranties, express or implied, which extend beyond the description contained herein including the implied warranty of merchantability and fitness for a particular purpose.

Exclusion of damages:

ViewSonic®’s liability is limited to the cost of repair or replacement of the product.

ViewSonic® shall not be liable for:

- Damage to other property caused by any defects in the product, damages based upon inconvenience, loss of use of the product, loss of time, loss of profits, loss of business opportunity, loss of goodwill, interference with business relationships, or other commercial loss, even if advised of the possibility of such damages.
- Any other damages, whether incidental, consequential or otherwise.
- Any claim against the customer by any other party.
- Repair or attempted repair by anyone not authorized by ViewSonic®.

Contact Information for Sales & Authorized Service (Centro Autorizado de Servicio) within Mexico:	
Name, address, of manufacturer and importers: México, Av. de la Palma #8 Piso 2 Despacho 203, Corporativo Interpalmas, Col. San Fernando Huixquilucan, Estado de México Tel: (55) 3605-1099 http://www.viewsonic.com/la/soporte/index.htm	
NÚMERO GRATIS DE ASISTENCIA TÉCNICA PARA TODO MÉXICO: 001.866.823.2004	
Hermosillo: Distribuciones y Servicios Computacionales SA de CV. Calle Juárez 284 local 2 Col. Bugambilias C.P: 83140 Tel: 01-66-22-14-9005 E-Mail: disc2@hmo.megared.net.mx	Villahermosa: Compumantenimientos Garantizados, S.A. de C.V. AV. GREGORIO MENDEZ #1504 COL, FLORIDA C.P. 86040 Tel: 01 (993) 3 52 00 47 / 3522074 / 3 52 20 09 E-Mail: compumantenimientos@prodigy.net.mx
Puebla, Pue. (Matriz): RENTA Y DATOS, S.A. DE C.V. Domicilio: 29 SUR 721 COL. LA PAZ 72160 PUEBLA, PUE. Tel: 01(52).222.891.55.77 CON 10 LINEAS E-Mail: datos@puebla.megared.net.mx	Veracruz, Ver.: CONEXION Y DESARROLLO, S.A DE C.V. Av. Americas # 419 ENTRE PINZÓN Y ALVARADO Fracc. Reforma C.P. 91919 Tel: 01-22-91-00-31-67 E-Mail: gacosta@qplus.com.mx
Chihuahua: Soluciones Globales en Computación C. Magisterio # 3321 Col. Magisterial Chihuahua, Chih. Tel: 4136954 E-Mail: Cefeo@soluglobales.com	Cuernavaca: Compusupport de Cuernavaca SA de CV Francisco Leyva # 178 Col. Miguel Hidalgo C.P. 62040, Cuernavaca Morelos Tel: 01 777 3180579 / 01 777 3124014 E-Mail: aquevedo@compusupportcva.com
Distrito Federal: QPLUS, S.A. de C.V. Av. Coyoacán 931 Col. Del Valle 03100, México, D.F. Tel: 01(52)55-50-00-27-35 E-Mail : gacosta@qplus.com.mx	Guadalajara, Jal.: SERVICRECE, S.A. de C.V. Av. Niños Héroes # 2281 Col. Arcos Sur, Sector Juárez 44170, Guadalajara, Jalisco Tel: 01(52)33-36-15-15-43 E-Mail: mmiranda@servicrece.com
Guerrero Acapulco: GS Computación (Grupo Sesicomp) Progreso #6-A, Colo Centro 39300 Acapulco, Guerrero Tel: 744-48-32627	Monterrey: Global Product Services Mar Caribe # 1987, Esquina con Golfo Pérsico Fracc. Bernardo Reyes, CP 64280 Monterrey N.L. México Tel: 8129-5103 E-Mail: aydeem@gps1.com.mx
MERIDA: ELECTROSER Av Reforma No. 403Gx39 y 41 Mérida, Yucatán, México CP97000 Tel: (52) 999-925-1916 E-Mail: rrrb@sureste.com	Oaxaca, Oax.: CENTRO DE DISTRIBUCION Y SERVICIO, S.A. de C.V. Murguía # 708 P.A., Col. Centro, 68000, Oaxaca Tel: 01(52)95-15-15-22-22 Fax: 01(52)95-15-13-67-00 E-Mail: gpotai2001@hotmail.com
Tijuana: STD Av Ferrocarril Sonora #3780 L-C Col 20 de Noviembre Tijuana, Mexico	FOR USA SUPPORT: ViewSonic® Corporation 381 Brea Canyon Road, Walnut, CA. 91789 USA Tel: 800-688-6688 E-Mail: http://www.viewsonic.com



ViewSonic®