

User Guide



Lenovo ThinkBook 13s Gen 4

Read this first

Before using this documentation and the product it supports, ensure that you read and understand the following:

- [Generic Safety and Compliance Notices](#)
- *Safety and Warranty Guide*
- *Setup Guide*

First Edition (March 2022)

© Copyright Lenovo 2022.

LIMITED AND RESTRICTED RIGHTS NOTICE: If data or software is delivered pursuant to a General Services Administration "GSA" contract, use, reproduction, or disclosure is subject to restrictions set forth in Contract No. GS-35F-05925.

Contents

About this guide iii

Chapter 1. Meet your computer. 1

Front 1
Base 3
Left 4
Right 6
Bottom 7
Features and specifications 8
 Statement on USB transfer rate 9
 Operating environment 10

Chapter 2. Get started with your computer. 11

Work with Windows 11
 Windows help information 12
Lenovo Vantage and Lenovo PC Manager 12
The Novo Button menu 12
 Open the Novo Button menu 12
Interact with your computer 13
 Keyboard hotkeys 13
 The FnLock switch 14
 Multi-touch gestures for touch-enabled screens 14

Chapter 3. Explore your computer . . . 17

Manage power 17
 Check the battery status 17
 Charge the battery 17
 Set power button behavior. 17

A power plan 17
 Set performance mode 18
Change settings in UEFI/BIOS setup utility 18
 What is UEFI/BIOS setup utility 18
 Open the UEFI/BIOS setup utility 18
 Select boot devices 18
 Change hotkey mode 18
 Enable or disable always-on 19
Set passwords in UEFI/BIOS setup utility 19
 Password types 19
 Set administrator password 19
 Change or remove administrator password 20
 Set user password 20
 Enable power-on password 20
 Set hard disk password 21
 Change or remove hard disk password 21

Chapter 4. Help and support 23

Frequently asked questions 23
Self-help resources 23
What is a CRU? 24
CRUs for your product model 25
Call Lenovo 25
 Before you contact Lenovo 25
 Lenovo Customer Support Center 25
Purchase additional services. 26

Appendix A. Notices and trademarks. 27

About this guide

- This guide applies to Lenovo product model(s) listed below. Illustrations in this guide may look slightly different from your product model.

| Model name | Machine type (MT) |
|----------------------|-------------------|
| ThinkBook 13s G4 IAP | 21AR |
| ThinkBook 13s G4 ARB | 21AS |

- For further compliance information, refer to the *Generic Safety and Compliance Notices* at https://pcsupport.lenovo.com/docs/generic_notices.
- This guide may contain information about accessories, features, and software that are not available on all models.
- This guide contains instructions that are based on the Windows operating system. These instructions are not applicable if you install and use other operating systems.
- Microsoft® makes periodic feature changes to the Windows® operating system through Windows Update. As a result, the operating system related instructions may become outdated. Refer to Microsoft resources for the latest information.
- The content of the guide is subject to change without notice. To obtain the latest version, go to <https://support.lenovo.com>.

Chapter 1. Meet your computer

Front

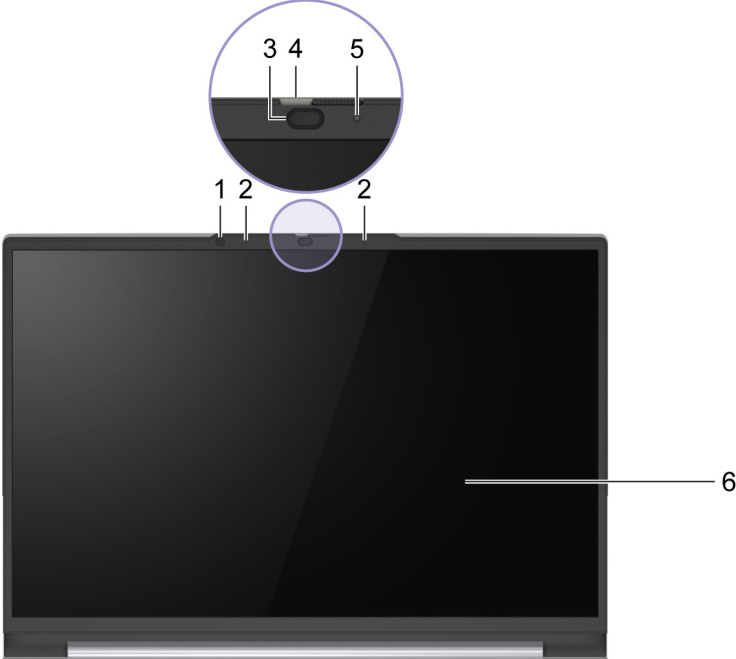

Figure 1. Front view – non-touch screen

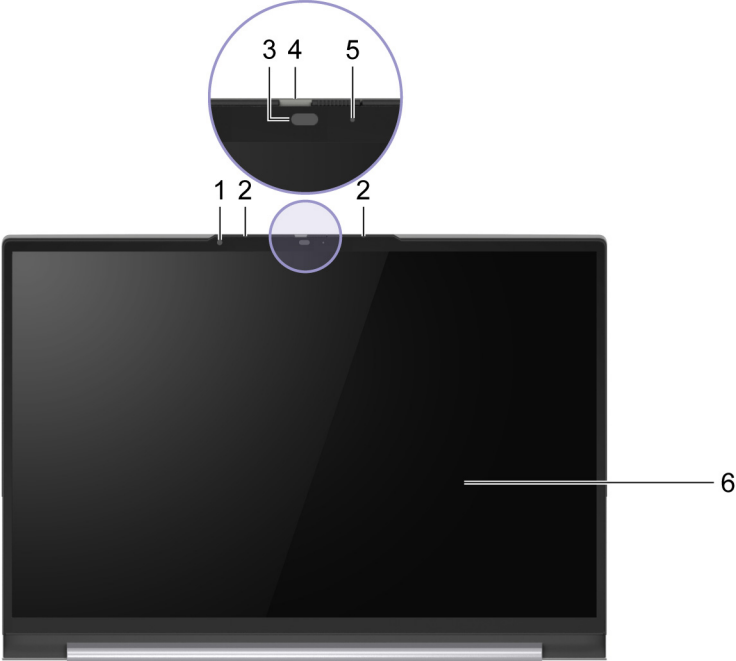

Figure 2. Front view – touch screen

| | |
|-------------------------|---|
| 1. Ambient light sensor | Detect the surrounding light intensity and adjust the brightness of the built-in screen accordingly. Note: To turn off the automatic brightness adjustment, type display settings in the Windows search box and then press Enter. |
| 2. Microphones | Capture or record sound and voice. |
| 3. Camera | Capture still and moving images for taking photos, recording videos, and video chatting. |
| 4. Camera switch | Turn the camera on or off. |
| 5. Camera light | If the light is on, the camera is in use. |
| 6. Screen | Display text, graphics, and videos. Selected models support multi-touch function. |

Base



Figure 3. Base view

| | |
|---|--|
| 1. Wireless antennas | <p>Send and receive radio waves for the built-in wireless LAN (local area network) and Bluetooth module.</p> <p>Notes:</p> <ul style="list-style-type: none">• The antennas are not visible from the outside of the computer.• If the location of the antennas is close to the user's body (< 20 cm), you can find the Specific Absorption Rate (SAR) values in the <i>Setup Guide</i> that comes with your computer. |
| 2. Power button/Fingerprint reader | <ul style="list-style-type: none">• Press the button to turn on the computer or put the computer into sleep mode.• Enroll and read your fingerprint for user authentication. |
| 3. Power light/Fingerprint reader light | <p>The light shows power status of the computer. The computer includes a fingerprint reader, and it can also show the status of the reader.</p> <ul style="list-style-type: none">• Power light<ul style="list-style-type: none">– Solid white: The computer is turned on.– Blinking white: The computer is in sleep mode.– Off: The computer is turned off or in hibernation mode.• Fingerprint reader light<ul style="list-style-type: none">– Blinking green: The fingerprint reader is starting.– Solid green: The fingerprint reader is waiting for you to scan your fingerprint. |
| 4. Keyboard | <p>Enter characters and interact with programs.</p> <p>Note: The keyboard also includes hotkeys and function keys for changing settings and performing tasks quickly.</p> |
| 5. Touchpad | <p>Perform finger touch and all the functions of a traditional mouse.</p> <p>Note: The touchpad also supports multi-touch function.</p> |

Left



Figure 4. Left-side view-ThinkBook 13s G4 IAP



Figure 5. Left-side view-ThinkBook 13s G4 ARB

| | |
|-----------------------------|--|
| 1. Thunderbolt™ 4 connector | <ul style="list-style-type: none"> • Plug the ac power adapter into the Thunderbolt 4 connector to provide power to the computer and charge the internal battery. • Connect to an external display, storage, or data devices. <p>Note: An appropriate adapter may be needed for connecting to external devices.</p> |
| 2. USB-C® connector | <ul style="list-style-type: none"> • Connect to power with the included power cord and ac power adapter. • Connect to an external display, storage, or data devices. <p>Note: An appropriate adapter may be needed for connecting to external devices.</p> |
| 3. Charging light | <p>Indicate whether the computer is connected to ac power.</p> <ul style="list-style-type: none"> • Solid white: Connected to ac power; battery capacity 91%–100% • Solid amber: Connected to ac power; battery capacity 1%–90% • Off: Not connected to ac power |
| 4. HDMI™ connector | <p>Connect to a compatible digital audio device or video monitor, such as an HDTV.</p> |
| 5. Status light | <ul style="list-style-type: none"> • Solid white: The computer is turned on; battery capacity 21%–100% • Blinking fast in white/Solid amber: The computer is turned on; battery capacity 1%–20% • Blinking slowly in white: The computer is in hibernate mode • Off: The computer is turned off |

Right

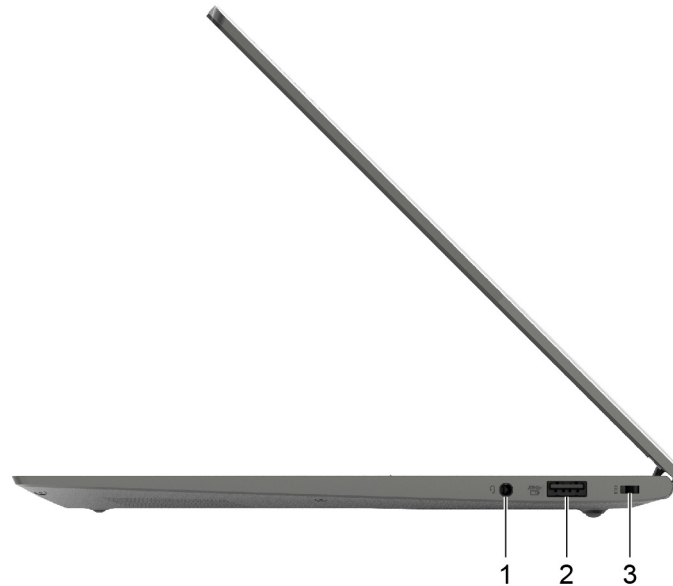

Figure 6. Right-side view

| | |
|---|--|
| 1. Combo audio jack | Connect to headphones or headsets with a 3.5 mm (0.14 inch), 4-pole plug. Note: This jack does not support standalone external microphones. If you use headsets, choose one with a single plug. |
| 2. USB (3.2 Gen 1) Type-A connector (always-on) | The always-on connector can charge external devices when the computer is turned off, in sleep or hibernation mode. The always-on function can be turned on or off in the UEFI/BIOS setup utility. Note: If Lenovo Vantage is pre-installed on your computer, you can also set always-on function within that software. |
| 3. Nano security-lock slot | Lock your computer to a desk, table, or other fixtures through a compatible security cable lock. |

Bottom

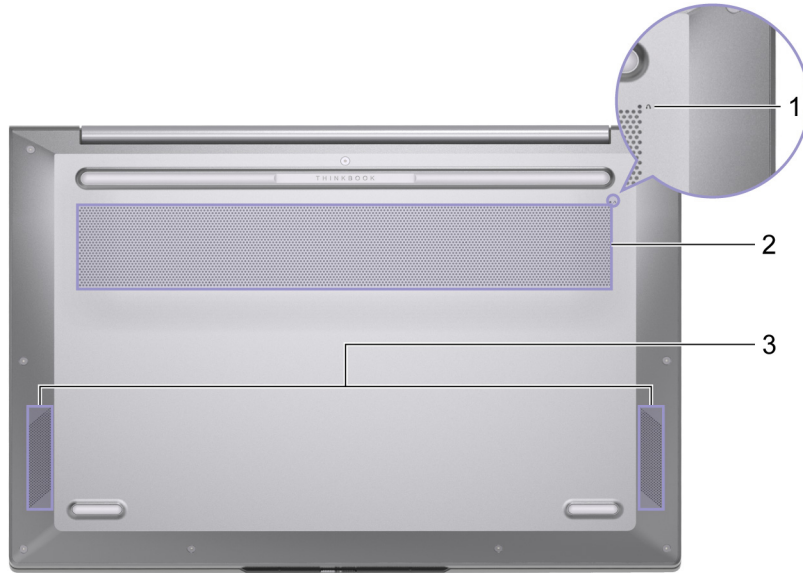



Figure 7. Bottom view

| | |
|------------------------------|---|
| 1. Novo button hole | Press the Novo button to open the Novo Button menu. From the menu, you can choose to open the UEFI/BIOS setup utility, the Boot menu, or the Windows startup options screen. |
| 2. Ventilation slots (inlet) | Maintain the incoming airflow to dissipate internal heat. Note: Do not block the ventilation slots. Otherwise, the computer might overheat. |
| 3. Speakers | Produce sound. |

Features and specifications

| | |
|------------------|---|
| Dimensions | <ul style="list-style-type: none">• Width: 297 mm (11.69 inches)• Depth: 211 mm (8.31 inches)• Thickness: 15.45 mm (0.61 inches) |
| ac power adapter | <ul style="list-style-type: none">• Input: 100 V ac–240 V ac, 50 Hz–60 Hz• Maximum output: 20 V dc, 3.25 A/20 V dc, 5 A• Maximum power: 65 W/100 W |
| Battery pack | <ul style="list-style-type: none">• Capacity: 56 Wh• Number of cells: 4 <p>Note: The battery capacity is the typical or average capacity as measured in a specific test environment. Capacities measured in other environments may differ but are no lower than the rated capacity (see product label).</p> |
| Microprocessor | To view the microprocessor information of your computer, type system information in the Windows search box and then press Enter. |
| Memory | <ul style="list-style-type: none">• Type: LPDDR5• Number of physical slots: 0 |
| Storage device | <ul style="list-style-type: none">• Type: solid-state drive• Form factor: M.2 (2242/2280)• Bus: PCI Express |
| Screen | <ul style="list-style-type: none">• Size: 337.82 mm (13.3 inches)• Display resolution<ul style="list-style-type: none">– 2560 × 1600 pixels (WQXGA model)– 1920 × 1200 pixels (WUXGA model) |
| Keyboard | <ul style="list-style-type: none">• Function keys• Hotkeys• Keyboard backlight |

Connectors and slots

- Combo audio jack
- USB Type-A connector (with Always-On function)
- Thunderbolt 4 connector * × 2
 - Power input up to 100 W using the included power adapter
 - Power output up to 5 V and 3 A
 - USB data transfer rate up to 10 Gbps for USB 3.2 Gen 2
 - DisplayPort 1.4. Supports maximum output resolution of 5120 × 3200, at 60 Hz frame rate and color depth of 24 bpp (bits per pixel).
 - Up to 40 Gbps bi-directional data transfer rate in Thunderbolt mode.
- USB-C connector × 2
 - Power input up to 100 W using the included power adapter
 - Power output up to 5 V and 3 A
 - USB data transfer rate up to 10 Gbps for USB 3.2 Gen 2 (for the USB-C connector with the  icon)
 - USB data transfer rate up to 40 Gbps for USB4 (for the USB-C connector between the HDMI connector and the status light) *
 - DisplayPort 1.4. Supports maximum output resolution of 5120 × 3200, at 60 Hz frame rate and color depth of 24 bpp (bits per pixel).
- HDMI 2.0 connector

Note: Data rates and performance ratings are dependent on connected devices and cables if they are used. For DisplayPort connection through a USB-C port, the listed maximum output capacity is only available on external displays with a DisplayPort, a Mini DisplayPort, or a USB-C port that supports DisplayPort Alternate Mode. For connections using a converter or an adapter, the actual output resolution may be lower.

Security

- Fingerprint reader
- Nano Security-lock slot
- UEFI/BIOS passwords
 - Administrator password
 - User password
 - Master hard disk password
 - User hard disk password

Network

Bluetooth and Wi-Fi combo adapter

* for selected models

Statement on USB transfer rate

Depending on many factors such as the processing capability of the host and peripheral devices, file attributes, and other factors related to system configuration and operating environments, the actual transfer rate using the various USB connectors on this device will vary and will be slower than the data rate listed below for each corresponding device.

| USB device | Data rate (Gbit/s) |
|------------|--------------------|
| 3.2 Gen 1 | 5 |
| 3.2 Gen 2 | 10 |

Operating environment

Maximum altitude (without pressurization)

3048 m (10 000 ft)

Temperature

- At altitudes up to 2438 m (8000 ft)
 - Operating: 5°C to 35°C (41°F to 95°F)
 - Storage: 5°C to 43°C (41°F to 109°F)
- At altitudes above 2438 m (8000 ft)
 - Maximum temperature when operating under the unpressurized condition: 31.3°C (88°F)

Note: When you charge the battery, its temperature must be no lower than 10°C (50°F).

Relative humidity

- Operating: 8% to 95% at wet-bulb temperature 23°C (73°F)
- Storage: 5% to 95% at wet-bulb temperature 27°C (81°F)

Chapter 2. Get started with your computer

Work with Windows

The following table contains Windows frequently used settings. You can learn the basics and start working with Windows right away.

To configure settings, type the corresponding keywords in the Windows search box and select the best match. Follow the on-screen instructions to customize settings.

Table 1. Basic settings

| Functions | Descriptions | Search by keywords |
|---------------------------|--|--------------------|
| Control Panel | View or change Windows settings, including hardware and software setup and configuration. | Control Panel |
| Connect to Wi-Fi networks | For models with a wireless LAN module, you can connect your computer to a Wi-Fi® network. Click the network icon in the Windows notification area, and then select a network for connection. Note: The wireless LAN module on your computer may support different standards. For some countries or regions, use of 802.11ax may be disabled according to local regulations. | Wi-Fi |
| Airplane mode | Airplane mode is a convenient setting to turn all wireless communications of your computer on and off. You may need to turn it on when boarding an airplane. | Airplane mode |
| Night light mode | Night light is a switch in Windows that you can turn on and off. When it is turned on, your screen shows warmer colors and the amount of emitted blue light is reduced. Enabling night light reduces the chances of developing eye fatigue or eye strain. | Night light |
| Adjust color temperature | If night light mode is turned on, you can adjust the color temperature of the screen. Note: Selected Lenovo computers are low blue light certified. These computers are tested with night light turned on and color temperature set to the default value of 48. | Night light |
| Windows Updates | Microsoft periodically releases feature and security updates to the Windows operating system. Updates that are applicable to your Windows version are downloaded automatically when your computer is connected to the Internet. When updates are downloaded, you are prompted to restart the computer to install these updates. You can also manually check if there are available updates for the installed version of Windows. Attention: Only use Windows Update to download and install updates. Updates downloaded from other sources may include security risks. | Windows Updates |

Table 2. Optional settings

| Functions | Descriptions | Search by keywords |
|-------------------------|--|--------------------|
| Enroll your fingerprint | For models with a fingerprint reader, you can enroll your fingerprint for Windows sign-in. | Sign-in options |

Windows help information

If the on-screen instructions cannot solve your problem, refer to the following to get the online Windows help information.

- Type Get Help or Tips in the Windows search box and then press Enter. When the app opens, type the problem description and select the matched result.
- Visit Microsoft support Web site: <https://support.microsoft.com>. Enter what you are looking for in the search box and get search results.

Lenovo Vantage and Lenovo PC Manager

They are both apps developed by Lenovo. Using either of them, you can:

- View product information and system status
- Manage and change device settings
- Check for and perform system update

Note: This feature is only available on Lenovo Vantage. In Lenovo PC Manager, you can check for and perform driver update.

Depending on the country or region in which your computer is purchased, one of the apps may be pre-installed on your computer. To open it, type its name in the Windows Search box and select the matched result. If neither of the apps is pre-installed, you may install one on your own. Lenovo Vantage is available for download free of charge from the Microsoft Store.

Note: App features are subject to change with updates and specific features may not be available on all Lenovo products.

The Novo Button menu

The Novo Button menu can be displayed before the operating system starts. From the menu, you can choose to

- Open the BIOS/UEFI setup utility
- Open the boot device selection menu
- Open the Windows startup options screen

Note: From the Windows startup options screen, you can then choose to

- Start your computer using a recovery drive
- Reset your computer
- Open advanced options screen

Open the Novo Button menu

For Lenovo computers with a Novo button, you can press the button to open the Novo Button menu.

Step 1. Turn off the computer.













Step 2. Open the LCD screen and press the Novo button.

Note: Alternatively, turn off the computer. Press Fn and the power button to open the Novo Button menu.

Interact with your computer

Keyboard hotkeys

Some keys on the keyboard are printed with icons. These keys are called hotkeys and can be pressed alone or in combination with the Fn key to open certain apps or change certain settings quickly. The functions of the hotkeys are symbolized by the icons printed on them.

| Hotkey | Function |
|---|---|
|  | Mute/Unmute sound. |
|  | Decrease/Increase system volume. |
|  | Mute/Unmute the microphone. |
|  | Increase/Decrease screen brightness. |
|  | Switch display devices. |
|  | Turn airplane mode on and off. |
|  | Service key. |
|  | Answer the Microsoft Teams calls. Notes: <ul style="list-style-type: none">• Supported on select versions of Microsoft Teams.• Install Microsoft Teams manually. |
|  | Reject the Microsoft Teams calls. Notes: <ul style="list-style-type: none">• Supported on select versions of Microsoft Teams.• Install Microsoft Teams manually. |
|  | Open the Windows Calculator app. |
|  | Open Lenovo Vantage, Lenovo PC Manager, or an app launch bar. |
|  | Open the Windows snipping tool. |
|  | Turn on/off or adjust the brightness of the keyboard backlight. Note: This hotkey must be used with the Fn key. |

Hotkey mode

Some hotkeys share keys with function keys (F1 to F12). The hotkey mode is a UEFI/BIOS setting that changes how hotkeys (or function keys) are used.

| Hotkey mode setting | How to use hotkeys | How to use function keys |
|---------------------|--|--|
| Disabled | Hold down the Fn key and press one of the hotkeys. | Press the function keys directly. |
| Enabled | Press the hotkeys directly. | Hold down the Fn key and press one of the function keys. |

Note: Hotkeys that do not share keys with function keys are not affected by the hotkey mode setting. They should always be used with the Fn key.

The FnLock switch

The FnLock is a switch that reverses the default and hidden function of a hotkey. The following table provides an example of how the FnLock switch changes the default function of the F1 key.

| FnLock | FnLock light | Default function of the F1 key |
|--------|--------------|--------------------------------|
| Off | Off | Mute/Unmute sound |
| On | On | F1 function * |



Note: The F1 function is application-dependent. It may have no function if the active application does not have a definition for the key.

The FnLock switch shares the ESC key (in the upper left corner of the keyboard). To turn it on or off, press Fn + ESC.

Multi-touch gestures for touch-enabled screens

Selected Lenovo computers include a touch-enabled screen. For such a computer, you can use your fingers to interact with the operating system and apps that are gesture aware.

Note: Not all gestures are supported by all apps.

| Gesture | Function |
|--|-------------------------|
|  Tap | Selecting an item |
|  Tap twice quickly | Double-clicking an item |
|  Tap and hold | Right-clicking an item |

Gesture

Function

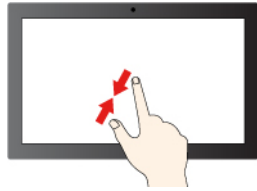

Pinch

Zooming out

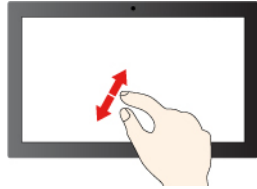

Spread



Zooming in

Chapter 3. Explore your computer

Manage power

Use the information in this section to achieve the best balance between performance and power efficiency.

Check the battery status

The battery status icon  or  is in the Windows notification area. You can check the battery status, view the current power plan, and access battery settings quickly.

Click the battery status icon to display the percentage of battery power remaining and change the power mode. A warning message is displayed when the battery is low.

Charge the battery

When the remaining battery power is low, charge your battery by connecting your computer to ac power.

The battery is fully charged in about two to four hours. The actual charging time depends on the battery capacity, the physical environment, and whether you are using the computer.

Battery charging is also affected by its temperature. The recommended temperature range for charging the battery is between 10°C (50°F) and 35°C (95°F).

Note:

You can check the battery temperature in Lenovo Vantage or Lenovo PC Manager.

To maximize the life of the battery, once the battery is fully charged, it must discharge to 94% or lower before it will be allowed to recharge again.

To extend your battery's lifespan, the battery may optimize its full charge capacity based on your usage. After prolonged periods of limited use, full battery capacity may not be available until you discharge to as low as 20% and recharge completely. For more information, refer to the power section of Lenovo Vantage.

Set power button behavior

By default, pressing the power button puts the computer to sleep mode. However, you can change the power button behavior in Windows Control Panel.

- Step 1. Type Control Panel in the Windows search box and then press Enter. Open the control panel and view by large or small icons.
- Step 2. Select the power options and then click choose what the power button does.

A power plan

A power plan is a collection of power-saving settings made available by an operating system. With a power plan, you can set idle time-outs for different hardware components to enter a low-power state. The default power plan and some of its idle time-out settings are listed below for computer models pre-installed with Windows.

The listed settings are active when the computer is connected to an electrical outlet. If your computer include a built-in battery pack, a different collection of time-out settings is set to take effect when the computer is operating on battery power.

- Default power plan: Balanced
- Turn off the display: after 4 minutes
- Put the computer to sleep: after 4 minutes

Note: To wake the computer from the sleep state, press the power button or any key on the keyboard.

Change or customize a power plan

This operation is applicable to computers with pre-installed Windows.

Step 1. Type power plan in the Windows search box and then press Enter.

Step 2. Customize a power plan of your preference.

Set performance mode

Your computer can work in different performance modes. The performance and power consumption of the computer vary in different performance modes. Press **Fn + Q** to cycle through different performance modes.

Change settings in UEFI/BIOS setup utility

This section introduces what is UEFI/BIOS and the operations you can perform in its setup utility.

What is UEFI/BIOS setup utility

UEFI/BIOS is the first program that runs when a computer starts. UEFI/BIOS initializes hardware components and loads the operating system and other programs. Your computer may include a setup program (setup utility) with which you can change certain UEFI/BIOS settings.

Open the UEFI/BIOS setup utility

Step 1. Turn on or restart the computer.

Step 2. When the Lenovo logo appears on the screen, press F1 repeatedly.

Note: For computers with hotkey mode enabled, press Fn + F1.

Select boot devices

Normally, the computer starts to a boot manager loaded from the secondary storage device of the computer. Occasionally, you may need to start the computer to a program or boot manager loaded from another device or a network location. After the system firmware initializes all devices, you can press an interruption key to display the boot menu and select a desired boot device.

Step 1. Turn on or restart the computer.

Step 2. Press F12.

Step 3. From the boot device menu, select a boot device to start the computer.

You can make a permanent change on boot devices in the UEFI/BIOS setup utility. Select the **Boot** menu; in the **EFI** section, select the desired boot device and move it to the top of the device list. Save changes and exit the setup utility for the change to take effect.

Change hotkey mode

Step 1. Open the UEFI/BIOS setup utility.

Step 2. Select **Configuration** → **Hotkey Mode** and press Enter.

Step 3. Change the setting to **Disabled** or **Enabled**.

Step 4. Select **Exit** → **Exit Saving Changes**.

Enable or disable always-on

For some Lenovo computers with always-on connectors, the always-on function can be enabled or disabled in the UEFI/BIOS setup utility.

Step 1. Open the UEFI/BIOS setup utility.

Step 2. Select **Configuration** → **Always On USB** and press Enter.

Step 3. Change the setting to **Disabled** or **Enabled**.

Step 4. Select **Exit** → **Exit Saving Changes**.

Set passwords in UEFI/BIOS setup utility

This section introduces the types of passwords that you can set in the UEFI (Unified Extensible Firmware Interface) or BIOS (Basic Input/Output System) setup utility.

Password types

You can set various types of passwords in the UEFI/BIOS setup utility.

| Password type | Pre-requisite | Usage |
|---------------------------|--|--|
| Administrator password | No | You must enter it to start the setup utility. |
| User password | The administrator password must be set. | You can use the user password to start the setup utility. |
| Master hard disk password | No | You must enter it to start the operating system. |
| User hard disk password | The master hard disk password must be set. | You can use the user hard disk password to start the operating system. |

Notes:

- All passwords set in the setup utility consist of alphanumeric characters only.
- If you start the setup utility using the user password, you can only change a few settings.

Set administrator password

You set the administrator password to prevent unauthorized access to the UEFI/BIOS setup utility.

Attention: If you forget the administrator password, a Lenovo authorized service personnel cannot reset your password. You must take your computer to a Lenovo authorized service personnel to have the system board replaced. Proof of purchase is required and a fee will be charged for parts and service.

Step 1. Open the UEFI/BIOS setup utility.

Step 2. Select **Security** → **Set Administrator Password** and press Enter.

Step 3. Enter a password string that contains only letters and numbers and then press Enter

Step 4. Enter the password again and press Enter.

Step 5. Select **Exit → Exit Saving Changes**.

Next time you start the computer, you must enter the administrator password to open the setup utility. If **Power on Password** is enabled, you must enter the administrator password or the user password to start the computer.

Change or remove administrator password

Only the administrator can change or remove the administrator password.

Step 1. Open the UEFI/BIOS setup utility using the administrator password.

Step 2. Select **Security → Set Administrator Password** and press Enter.

Step 3. Enter the current password.

Step 4. In the **Enter New Password** text box, enter the new password.

Step 5. In the **Confirm New Password** text box, enter the new password again.

Note: If you want to remove the password, press Enter in both text boxes without entering any character.

Step 6. Select **Exit → Exit Saving Changes**.

If you remove the administrator password, the user password is also removed.

Set user password

You must set the administrator password before you can set the user password.

The administrator of the setup utility might need to set a user password for use by others.

Step 1. Open the UEFI/BIOS setup utility using the administrator password.

Step 2. Select **Security → Set User Password** and press Enter.

Step 3. Enter a password string that contains only letters and numbers and then press Enter. The user password must be different from the administrator password.

Step 4. Enter the password again and press Enter.

Step 5. Select **Exit → Exit Saving Changes**.

Enable power-on password

If the administrator password has been set, you can enable power-on password to enforce greater security.

Step 1. Open the UEFI/BIOS setup utility.

Step 2. Select **Security → Power on Password** and press Enter.

Note: The administrator password must be set in advance.

Step 3. Change the setting to **Enabled**.

Step 4. Select **Exit → Exit Saving Changes**.

If power-on password is enabled, a prompt appears on the screen every time you turn on the computer. You must enter the administrator or user password to start the computer.

Set hard disk password

You can set a hard disk password in the setup utility to prevent unauthorized access to your data.

Attention: Be extremely careful when setting a hard disk password. If you forget the hard disk password, a Lenovo authorized service personnel cannot reset your password or recover data from the hard disk. You must take your computer to a Lenovo authorized service personnel to have the hard disk drive replaced. Proof of purchase is required and a fee will be charged for parts and service.

Step 1. Open the UEFI/BIOS setup utility.

Step 2. Select **Security → Set Hard Disk Password** and press Enter.

Note: If you start the setup utility using the user password, you cannot set hard disk password.

Step 3. Follow on-screen instructions to set both master and user passwords.

Note: The master and user hard disk passwords must be set at the same time.

Step 4. Select **Exit → Exit Saving Changes**.

If the hard disk password is set, you must provide the correct password to start the operating system.

Change or remove hard disk password

Step 1. Open the UEFI/BIOS setup utility.

Step 2. Select **Security**.

Step 3. Change or remove the hard disk password.

To change or remove master password, select **Change Master Password** and press Enter.

Note: If you remove the master hard disk password, the user hard disk password is also removed.

To change user password, select **Change User Password** and press Enter.

Note: The user hard disk password cannot be removed separately.

Step 4. Select **Exit → Exit Saving Changes**.

Chapter 4. Help and support

Frequently asked questions

| | |
|--|---|
| How do I partition my storage drive? | Refer to https://support.lenovo.com/solutions/ht503851 |
| What should I do if my computer stops responding. | Press and hold the power button until the computer turns off. Then restart the computer. 1. Carefully unplug the ac power adapter and turn off the computer immediately. The more quickly you stop the current from passing through the computer the more likely you will reduce damage from short circuits. Attention: Although you might lose some data or work by turning off the computer immediately, leaving the computer on might make your computer unusable. 2. Wait until you are certain that all the liquid is dry before turning on your computer. CAUTION: Do not try to drain out the liquid by turning over the computer. If your computer has keyboard drainage holes on the bottom, the liquid will be drained out through the holes. |
| What should I do if I spill liquid on the computer? | |
| Where can I get the latest device drivers and UEFI/BIOS? | <ul style="list-style-type: none">• Lenovo Vantage or Lenovo PC Manager• Lenovo Support Web site at https://support.lenovo.com |

Self-help resources

Use the following self-help resources to learn more about the computer and troubleshoot problems.

| Resources | How to access? |
|--|--|
| Troubleshooting and frequently asked questions | <ul style="list-style-type: none">• https://www.lenovo.com/tips• https://forums.lenovo.com |
| Accessibility information | https://www.lenovo.com/accessibility |
| Reset or restore Windows | <ul style="list-style-type: none">• Use Lenovo recovery options.<ol style="list-style-type: none">1. Go to https://support.lenovo.com/HowToCreateLenovoRecovery.2. Follow the on-screen instructions.• Use Windows recovery options.<ol style="list-style-type: none">1. Go to https://pcsupport.lenovo.com.2. Detect your computer or manually select your computer model.3. Click Diagnostics → Operating System Diagnostics and then follow the on-screen instructions. |

| Resources | How to access? |
|---|--|
| <p>Use Lenovo Vantage or Lenovo PC Manager to:</p> <ul style="list-style-type: none"> • Download and install the latest drivers and firmware. • Configure hardware settings • Diagnose computer hardware problems. • Check the computer warranty status. | Use Windows Search. |
| <p>Product documentation:</p> <ul style="list-style-type: none"> • Generic Safety and Compliance Notices • <i>Safety and Warranty Guide</i> • <i>Setup Guide</i> • <i>This User Guide</i> • <i>Regulatory Notice</i> | <ol style="list-style-type: none"> 1. Go to https://support.lenovo.com. 2. Detect your computer or select computer model manually. 3. Select Documentation and filter out the documentation you want. |
| <p>Lenovo Support Web site with the latest support information of the following:</p> <ul style="list-style-type: none"> • Drivers and software • Diagnostic solutions • Product and service warranty • Product and parts details • Knowledge base and frequently asked questions | Visit https://support.lenovo.com |
| Windows help information | <ul style="list-style-type: none"> • Use Get Help or Tips. • Use Windows Search or the Cortana® personal assistant. • Microsoft support Web site: https://support.microsoft.com |

What is a CRU?

Customer replaceable units (CRUs) are parts that can be upgraded or replaced by the customer. A Lenovo computer may contain the following types of CRUs:

Self-service CRU

Parts that can be installed or replaced easily by customer themselves or by trained service technicians at an additional cost.

Optional-service CRU

Parts that can be installed or replaced by customers with a greater skill level. Trained service technicians can also provide service to install or replace the parts under the type of warranty designated for the customer's machine.

If you intend to install a CRU, Lenovo will ship the CRU to you. You might be required to return the defective part that is replaced by the CRU. When return is required: (1) return instructions, a prepaid shipping label, and a container will be included with the replacement CRU; and (2) you might be charged for the replacement CRU if Lenovo does not receive the defective CRU within thirty (30) days of your receipt of the replacement CRU. For full details, see the *Lenovo Limited Warranty* at https://www.lenovo.com/warranty/llw_02.

CRUs for your product model

The table below lists the CRUs and CRU types that are defined for your product model.

| Part | Self-service CRU | Optional-service CRU |
|------------------|------------------|----------------------|
| Power cord * | X | |
| ac power adapter | X | |

* for selected models

Notes:

- CRU replacement instruction is provided in one or more of the following publications and are available from Lenovo at any time upon your request.
 - the product *User Guide*
 - the printed publications that came with the product
- Replacement of any parts not listed above, including the built-in rechargeable battery, must be done by a Lenovo-authorized repair facility or technician. Go to <https://support.lenovo.com/partnerlocation> for more information.

Call Lenovo

If you have tried to correct the problem yourself and still need help, you can call Lenovo Customer Support Center.

Before you contact Lenovo

Record product information and problem details before you contact Lenovo.

| Product information | Problem symptoms and details |
|---|---|
| <ul style="list-style-type: none">• Product name• Machine type and serial number | <ul style="list-style-type: none">• What is the problem? Is it continuous or intermittent?• Any error message or error code?• What operating system are you using? Which version?• Which software applications were running at the time of the problem?• Can the problem be reproduced? If so, how? |

Note: The product name and serial number can usually be found on the bottom of the computer, either printed on a label or etched on the cover.

Lenovo Customer Support Center

During the warranty period, you can call Lenovo Customer Support Center for help.

Telephone numbers

For a list of the Lenovo Support phone numbers for your country or region, go to <https://pcsupport.lenovo.com/supportphonenumberlist>.

Note: Phone numbers are subject to change without notice. If the number for your country or region is not provided, contact your Lenovo reseller or Lenovo marketing representative.

Services available during the warranty period

- Problem determination - Trained personnel are available to assist you with determining if you have a hardware problem and deciding what action is necessary to fix the problem.
- Lenovo hardware repair - If the problem is determined to be caused by Lenovo hardware under warranty, trained service personnel are available to provide the applicable level of service.
- Engineering change management - Occasionally, there might be changes that are required after a product has been sold. Lenovo or your reseller, if authorized by Lenovo, will make selected Engineering Changes (ECs) that apply to your hardware available.

Services not covered

- Replacement or use of parts not manufactured for or by Lenovo or nonwarranted parts
- Identification of software problem sources
- Configuration of UEFI/BIOS as part of an installation or upgrade
- Changes, modifications, or upgrades to device drivers
- Installation and maintenance of network operating systems (NOS)
- Installation and maintenance of programs

For the terms and conditions of the Lenovo Limited Warranty that apply to your Lenovo hardware product, see “Warranty information” in the *Safety and Warranty Guide* that comes with your computer.

Purchase additional services

During and after the warranty period, you can purchase additional services from Lenovo at <https://pcsupport.lenovo.com/warrantyupgrade>.

Service availability and service name might vary by country or region.

Appendix A. Notices and trademarks

Notices

Lenovo may not offer the products, services, or features discussed in this document in all countries. Consult your local Lenovo representative for information on the products and services currently available in your area. Any reference to a Lenovo product, program, or service is not intended to state or imply that only that Lenovo product, program, or service may be used. Any functionally equivalent product, program, or service that does not infringe any Lenovo intellectual property right may be used instead. However, it is the user's responsibility to evaluate and verify the operation of any other product, program, or service.

Lenovo may have patents or pending patent programs covering subject matter described in this document. The furnishing of this document does not give you any license to these patents. You can send license inquiries, in writing, to:

Lenovo (United States), Inc.
8001 Development Drive
Morrisville, NC 27560
U.S.A.

Attention: Lenovo Director of Licensing

LENOVO PROVIDES THIS PUBLICATION "AS IS" WITHOUT WARRANTY OF ANY KIND, EITHER EXPRESS OR IMPLIED, INCLUDING, BUT NOT LIMITED TO, THE IMPLIED WARRANTIES OF NON-INFRINGEMENT, MERCHANTABILITY OR FITNESS FOR A PARTICULAR PURPOSE. Some jurisdictions do not allow disclaimer of express or implied warranties in certain transactions, therefore, this statement may not apply to you.

Changes are made periodically to the information herein; these changes will be incorporated in new editions of the publication. To provide better service, Lenovo reserves the right to improve and/or modify the products and software programs described in the manuals included with your computer, and the content of the manual, at any time without additional notice.

The software interface and function and hardware configuration described in the manuals included with your computer might not match exactly the actual configuration of the computer that you purchase. For the configuration of the product, refer to the related contract (if any) or product packing list, or consult the distributor for the product sales. Lenovo may use or distribute any of the information you supply in any way it believes appropriate without incurring any obligation to you.

The products described in this document are not intended for use in implantation or other life support applications where malfunction may result in injury or death to persons. The information contained in this document does not affect or change Lenovo product specifications or warranties. Nothing in this document shall operate as an express or implied license or indemnity under the intellectual property rights of Lenovo or third parties. All information contained in this document was obtained in specific environments and is presented as an illustration. The result obtained in other operating environments may vary.

Lenovo may use or distribute any of the information you supply in any way it believes appropriate without incurring any obligation to you.

Any references in this publication to non-Lenovo Web sites are provided for convenience only and do not in any manner serve as an endorsement of those Web sites. The materials at those Web sites are not part of the materials for this Lenovo product, and use of those Web sites is at your own risk.

Any performance data contained herein was determined in a controlled environment. Therefore, the result obtained in other operating environments may vary significantly. Some measurements may have been made on development-level systems and there is no guarantee that these measurements will be the same on generally available systems. Furthermore, some measurements may have been estimated through extrapolation. Actual results may vary. Users of this document should verify the applicable data for their specific environment.

This document is copyrighted by Lenovo and is not covered by any open source license, including any Linux agreement(s) which may accompany software included with this product. Lenovo may update this document at any time without notice.

For the latest information or any questions or comments, contact or visit the Lenovo Web site:

<https://support.lenovo.com>

Trademarks

Lenovo, and the Lenovo logo are trademarks of Lenovo. Thunderbolt is a trademark of Intel Corporation or its subsidiaries. Microsoft, Windows, and Cortana are trademarks of the Microsoft group of companies. DisplayPort is a trademark of the Video Electronics Standards Association. The terms HDMI and HDMI High-Definition Multimedia Interface, and the HDMI logo are trademarks or registered trademarks of HDMI Licensing Administrator, Inc. in the United States and other countries. Wi-Fi is a registered trademark of Wi-Fi Alliance. USB-C is a trademark of USB Implementers Forum. All other trademarks are the property of their respective owners.