

SAMSUNG Flip

User Manual

WM75A WM85A

The colour and the appearance may differ depending on the product, and the content in the manual is subject to change without prior notice to improve the performance.

Recommended hours of use per day of this product is under 16 hours. If the product is used for longer than 16 hours a day, the warranty may be void.

[For India Only]

This product is RoHS compliant.

For more information on safe disposal and recycling visit our website www.samsung.com/in or contact our Helpline numbers -

1800 40 SAMSUNG (1800 40 7267864) (Toll-Free)

1800 5 SAMSUNG (1800 5 7267864) (Toll-Free)

Table of contents

Before Using the Product

Safety Precautions	4
Safety symbols	4
Storage	5
Electricity and safety	5
Installation	6
Operation	7
Precautions for Use	8

Preparations

Checking the Components	9
Parts	10
Ports	11
Tray	12
Before Installing the Product (Installation Guide)	13
Installing the Wall Mount	14
Installing the Wall Mount	14
Wall Mount Kit Specifications (VESA)	15
Connecting to a network	16
Network Settings (Wired)	16
Network Settings (Wireless)	18
Use WPS	20

Writing

What's a 'Roll'?	21
PEN MODE	22
Screen Elements	22
Drawing	23
Erasing	23
Changing the pen thickness and colour	23
BRUSH MODE	24
Screen Elements	24
Managing Rolls	25
ROLL EXPLORER	26
Page Viewer	27
Note On/Off	28
Using the Selection Tools	29

IMPORT

Connecting to a Mobile Device	31
Connecting using Smart View or Screen Mirroring	31
Connecting to a PC	31
Connecting using a cable	32
Connecting using a OPS (Sold separately)	32
Connecting via the Wireless Display function	33
Connecting via SMARTVIEW+	33
Importing from a USB Device	34
Connecting to Internet	34
Read before using the INTERNET function	34
Connecting to SAMSUNG WORKSPACE	35
Source Window	36
Document view	37
Image view	38
Video view	39

Table of contents

EXPORT

Sending Email	41
Printing	42
Installing Flip Printing Software	42
Setting up the printer	42
Exporting to a USB Device	44
Exporting from a Network Drive	45
Sending to a mobile device	45
Sharing your screen	46

Menu

Connect	47
System	55
Picture	59
Support	61

Troubleshooting Guide

Problems and Solutions	62
------------------------	----

Specifications

General	67
Preset Timing Modes	69

Appendix

Responsibility for the Pay Service (Cost to Customers)	70
Not a product defect	70
A Product damage caused by customer's fault	70
Others	70
Prevention of Afterimage Burn-in	71
What is afterimage burn-in?	71
Recommended prevention practices	71
Licence	71





Chapter 01

Before Using the Product

Safety Precautions

The following safety instructions are to ensure your personal safety and prevent property damage. Please read the following to ensure the proper use of the product.







Safety symbols

Symbol	Name	Meaning
	Warning	A serious or fatal injury may result if instructions are not followed.
	Caution	Personal injury or damage to properties may result if instructions are not followed.
	Prohibition	Do NOT attempt.
	Instruction	Follow directions.

CAUTION

RISK OF ELECTRIC SHOCK. DO NOT OPEN.

CAUTION: TO REDUCE THE RISK OF ELECTRIC SHOCK, DO NOT REMOVE COVER (OR BACK). THERE ARE NO USER SERVICEABLE PARTS INSIDE. REFER ALL SERVICING TO QUALIFIED PERSONNEL.

	This symbol indicates that high voltage is present inside. It is dangerous to make any kind of contact with any internal part of this product.		AC voltage: Rated voltage marked with this symbol is AC voltage.
	This symbol indicates that this product has included important literature concerning operation and maintenance.		DC voltage: Rated voltage marked with this symbol is DC voltage.
	Class II product: This symbol indicates that a safety connection to electrical earth (ground) is not required. If this symbol is not present on a product with a mains lead, the product MUST have a reliable connection to protective earth (ground).		Caution. Consult instructions for use: This symbol instructs the user to consult the user manual for further safety related information.





Storage



Due to the characteristics of high-glossy products, using a UV humidifier nearby may create white-coloured stains on the product.

 Contact Customer Service Centre if the inside of the product needs cleaning (service fee will be charged).





Electricity and safety

Warning

-  Do not use a damaged power cord or plug, or a loose power socket.
An electric shock or fire may result.
-  Do not use multiple products with a single power socket.
Overheated power sockets may cause a fire.
-  Do not touch the power plug with wet hands. Otherwise, an electric shock may result.
-  Do not bend or pull the power cord with force. Be careful not to leave the power cord under a heavy object.
Damage to the cord may result in a fire or electric shock.
-  Do not place the power cord or product near heat sources.
A fire or electric shock may result.



-  Insert the power plug all the way in so it is not loose.
An unsecure connection may cause a fire.
-  Connect the power plug to a grounded power socket (type 1 insulated devices only).
An electric shock or injury may result.
-  Clean any dust around the pins of the power plug or the power socket with a dry cloth.
A fire may result.

Caution

-  Do not disconnect the power cord while the product is being used.
The product may become damaged by an electric shock.
-  Only use the power cord provided with your product by Samsung. Do not use the power cord with other products.
A fire or electric shock may result.
-  Keep the power socket where the power cord is connected unobstructed.
The power cord must be disconnected to cut off power to the product when an issue occurs.
-  Hold the plug when disconnecting the power cord from the power socket.
An electric shock or fire may result.

Installation





Warning

-  DO NOT PLACE CANDLES, INSECT REPELLANTS OR CIGARETTES ON TOP OF THE PRODUCT. DO NOT INSTALL THE PRODUCT NEAR HEAT SOURCES.
A fire may result.
-  Do not install the product in poorly ventilated spaces such as a bookcase or closet.
An increased internal temperature may cause a fire.
-  Do not install the product on an unstable or vibrating surface (insecure shelf, sloped surface, etc.)
 - The product may fall and become damaged and/or cause an injury.
 - Using the product in an area with excess vibration may damage the product or cause a fire.
-  Do not expose the product to direct sunlight, heat, or a hot object such as a stove.
The product lifespan may be reduced or a fire may result.
-  Do not install the product within the reach of young children.
 - The product may fall and injure children.
 - As the front is heavy, install the product on a flat and stable surface.
-  Edible oil, such as soybean oil, can damage or deform the product. Do not install the product in a kitchen or near a kitchen counter.
-  Have a technician install the wall-mount hanger.
 - Installation by an unqualified person can result in an injury.
 - Only use approved cabinets.
-  Install the product at least 10 cm away from the wall to allow ventilation.
An increased internal temperature may cause a fire.

 Keep the plastic packaging out of the reach of children.
Children may suffocate.



 Do not install the product in a vehicle or a place exposed to dust, moisture (water drips, etc.), oil, or smoke.
A fire or electric shock may result.

Caution

-  Do not set down the product on its front.
The screen may become damaged.
-  Do not drop the product while moving.
Product failure or personal injury may result.
-  Set down the product gently.
Product failure or personal injury may result.
-  Installing the product in an unusual place (a place exposed to a lot of fine dust, chemical substances, extreme temperatures or a significant presence of moisture, or a place where the product will operate continuously for an extended period of time) may seriously affect its performance.
Be sure to consult Samsung Customer Service Centre if you want to install the product at such a place.

Operation

Warning

-  There is a high voltage inside the product. Never disassemble, repair or modify the product yourself.
 - A fire or electric shock may result.
 - Contact Samsung Customer Service Centre for repairs.
-  Do not let children hang from the product or climb on top of it.

Children may become injured or seriously harmed.
-  If the product is dropped or the outer case is damaged, turn off the power switch and disconnect the power cord. Then contact Samsung Customer Service Centre.



Continued use can result in a fire or electric shock.
-  Do not leave heavy objects or items that children like (toys, sweets, etc.) on top of the product.

The product or heavy objects may fall as children try to reach for the toys or sweets resulting in a serious injury.
-  Do not move the product by pulling the power cord or any cable.

Product failure, an electric shock or fire may result from a damaged cable.
-  Do not lift or move the product by pulling the power cord or any cable.

Product failure, an electric shock or fire may result from a damaged cable.
-  Ensure the vents are not blocked by tablecloths or curtains.

An increased internal temperature may cause a fire.
-  Do not insert metallic objects (chopsticks, coins, hairpins, etc) or objects that burn easily (paper, matches, etc) into the product (via the vent or input/output ports, etc).
 - Be sure to power off the product and disconnect the power cord when water or other foreign substances have entered the product. Then contact Samsung Customer Service Centre.
 - Product failure, an electric shock or fire may result.

-  Do not place objects containing liquid (vases, pots, bottles, etc) or metallic objects on top of the product.
 - Be sure to power off the product and disconnect the power cord when water or other foreign substances have entered the product. Then contact Samsung Customer Service Centre.
 - Product failure, an electric shock or fire may result.
-  Before moving the product, turn off the power switch and disconnect the power cable and all other connected cables.

Damage to the cord may result in a fire or electric shock.
-  If the product generates abnormal sounds, a burning smell or smoke, disconnect the power cord immediately and contact Samsung Customer Service Centre.

An electric shock or fire may result.
-  During a lightning or thunderstorm, power off the product and remove the power cable.









A fire or electric shock may result.
-  Do not drop objects on the product or apply impact.

A fire or electric shock may result.
-  If a gas leakage is found, do not touch the product or power plug. Also, ventilate the area immediately.

Sparks can cause an explosion or fire.
-  Do not use or keep combustible spray or an inflammable substance near the product.

An explosion or fire may result.

Caution

-  Do not use humidifiers or stoves around the product.
A fire or electric shock may result.
-  Do not touch the screen when the product has been turned on for an extended period of time as it will become hot.
-  Do not place heavy objects on the product.
Product failure or personal injury may result.
-  Leaving the screen fixed on a stationary image for an extended period of time may cause afterimage burn-in or defective pixels.
Activate power-saving mode or a moving-picture screen saver if you will not be using the product for an extended period of time.
-  Disconnect the power cord from the power socket if you do not plan on using the product for an extended period of time (vacation, etc).
Dust accumulation combined with heat can cause a fire, electric shock or electric leakage.
-  Use the product at the recommended resolution and frequency.
Your eyesight may deteriorate.
-  Looking at the screen too close for an extended period of time can deteriorate your eyesight.
-  Rest your eyes for more than 5 minutes for every 1 hour of product use.
Eye fatigue will be relieved.
-  Store small accessories out of the reach of children.

Precautions for Use

Be careful that if you use the supplied pen with a load exceeding 2.5 kg, scratches may occur on the protective glass.

If you use a ballpoint pen other than the supplied pen, be careful that the screen may be stained with ink or damaged.

Do not use a dirty brush to avoid screen damage.

 We recommend that you use the supplied pen. Do not use sharp, pointed objects other than the pen.

 If dust or dirt from the supplied pen remains on the protective glass, clean it referring to the instructions below.

Cleaning the exterior and display

Wipe the surface with a slightly wet, soft cloth, and then wipe with a dry cloth.

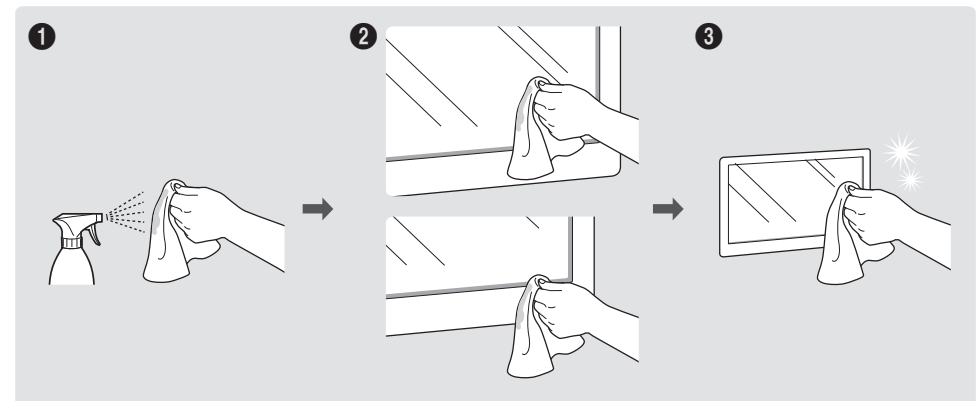

Chapter 02

Preparations

Checking the Components

-
- Contact the vendor where you purchased the product if any components are missing.
 - The appearance of the components may differ from the images shown.
 - Refer to the installation guide for the WMA stand or wall mount (available for optional purchase).

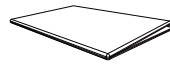

Quick Setup Guide



Warranty card
(Not available in some locations)

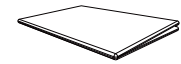

Regulatory guide



Power cord

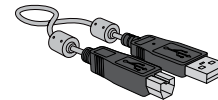

USB cable

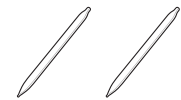



Touch Pen x 2





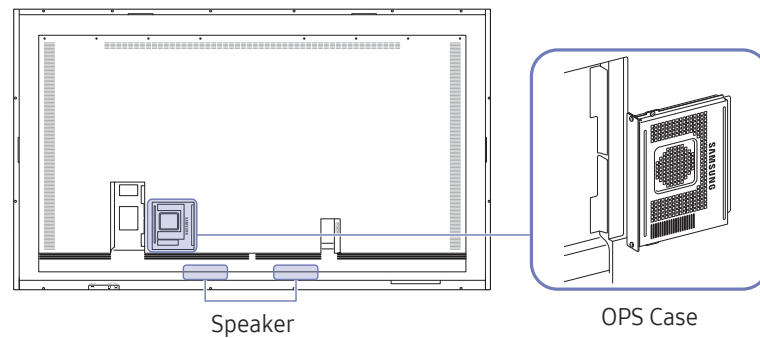
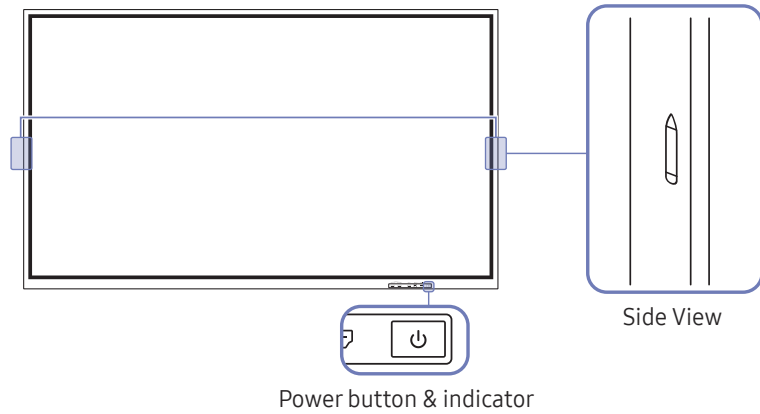



Wall Mount Adapter x 4 (WM75A only)

Parts



 The colour and shape of parts may differ from what is shown. Specifications are subject to change without notice to improve quality.

Parts	Description
Power button & indicator	<ul style="list-style-type: none"> Press and hold the button to turn off the product. <ul style="list-style-type: none">  The power indicator is on when the product is turned on.  The power indicator is off when the product is turned off. In writing mode, shortly press the Power button to switch to the screen saver mode.
	The pen is magnetic. Keep it by attaching to the marked location.
OPS case (Sold separately)	<p>Connect the OPS case to the product and insert the standard OPS module into the case. You can purchase the OPS case and module separately.</p> <p> Before inserting the OPS module, make sure to remove the power cable from the product to completely cut off the power supply.</p> <ul style="list-style-type: none">  OPS refers to the Intel Open Pluggable Specification.  When the OPS case needs to be installed, be sure to install the OPS case first before the product.  OPS power supply: 19V/3.7A

Ports

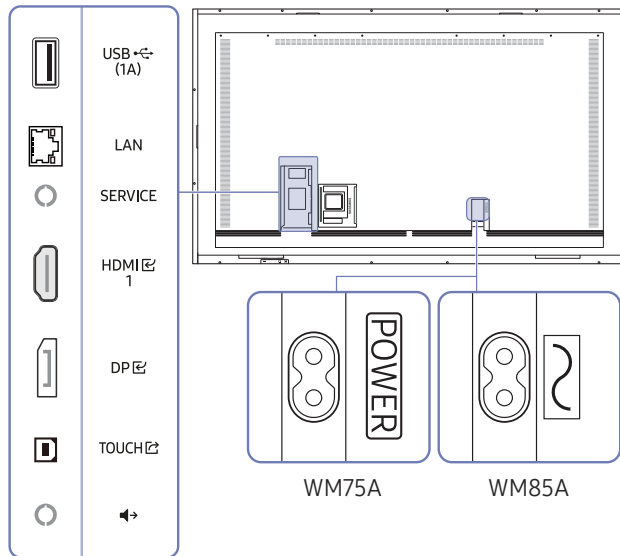

The colour and shape of parts may differ from what is shown. Specifications are subject to change without notice to improve quality.

Ports	Description
USB (1A)	<p>Connect to a USB memory device.</p> <p> The USB ports on the product accept a maximum constant current of 1.0A. If the maximum value is exceeded, USB ports may not work.</p>
LAN	<p>Connects to a network using a LAN cable. (10/100 Mbps)</p> <p> Use Cat7(*STP Type) cable for the connection. *Shielded Twist Pair.</p>
SERVICE	<p>Dedicated to service technicians.</p> <p> This port is for servicing only and has no user function. Do not connect a cable to this port.</p>
HDMI 1	Connects to a source device using a HDMI cable.
DP	Connects to a source device using a DP cable.
TOUCH	Allows touch-based control of the PC screen connected through the HDMI 1 or DP port. Use the supplied USB cable to connect between the TOUCH port on the rear of the product and the PC.
	Outputs sound to an audio device via an audio cable.

Tray

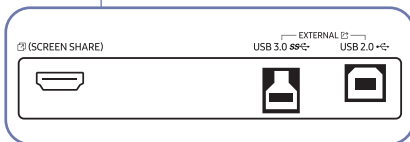
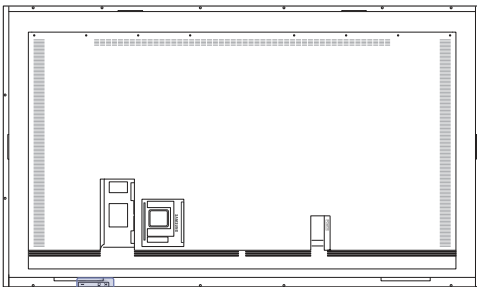
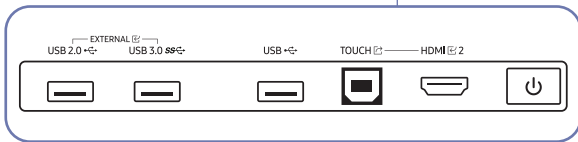
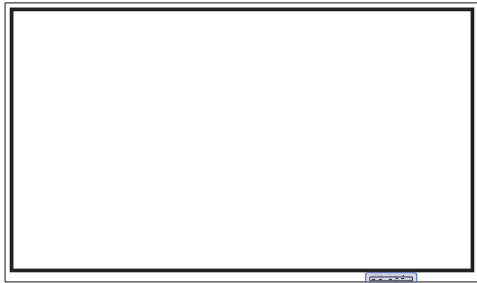

The colour and shape of parts may differ from what is shown. Specifications are subject to change without notice to improve quality.

Ports	Description
EXTERNAL (USB 2.0, USB 3.0)	Provides USB connectivity to PC. 1 Use a USB cable to connect EXTERNAL (USB 2.0, USB 3.0) to the connected PC. 2 Connect the USB device to EXTERNAL (USB 2.0, USB 3.0). 3 A connection is established between the USB device and PC.
EXTERNAL (USB 2.0, USB 3.0)	
USB	Connect to a USB memory device.
TOUCH	Allows touch-based control of the PC screen connected through the HDMI 2 port. Use the supplied USB cable to connect between the TOUCH port on the tray and the PC.
HDMI 2	An HDMI port for displaying input from an external source.
(SCREEN SHARE)	An HDMI port for connecting to an external display.

Before Installing the Product (Installation Guide)

This product can be wall-mounted.

- ✎ Do not install or use the product with its front facing up. Touch-based functions may not work properly.

Ventilation

- ✎ Contact Samsung Customer Service Centre for further details.

Installation on a Perpendicular Wall

- A Minimum 15 mm
- B Ambient temperature: 35 °C or less

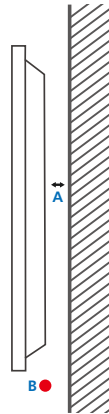

Installation on an Indented Wall

- A Minimum 15 mm
- B Minimum 25 mm
- C Ambient temperature: 35 °C or less
- ✎ When installing the product on an indented wall, allow at least the space specified above between the product and wall for ventilation and ensure that the ambient temperature is kept below 35 °C.

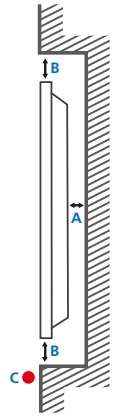

Installing the Wall Mount

Installing the Wall Mount

- The wall mount kit allows you to mount the product on the wall.
- For detailed information on installing the wall mount, see the instructions provided with the wall mount.
- We recommend you contact a technician for assistance when installing the wall mount bracket.
- Samsung is not responsible for any damage to the product or injury to yourself or others if you select to install the wall mount on your own.

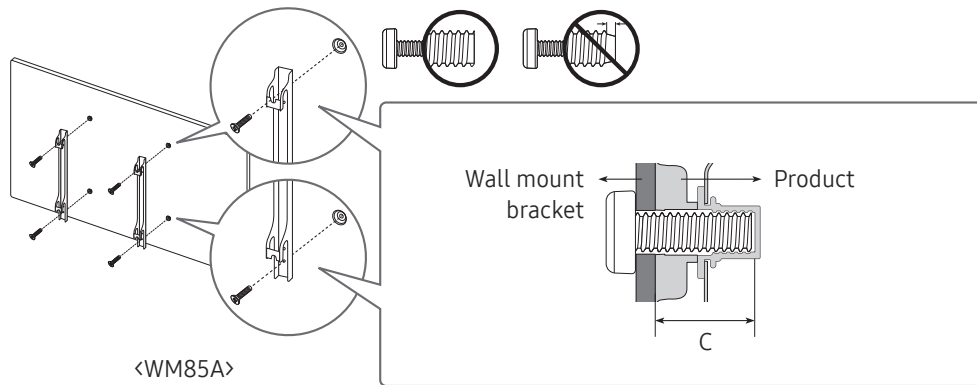

Using the wall mount adapter (WM75A only)

Install the provided wall mount adapters as shown in the figure below before installing the wall mount kit.

- ✎ If you are installing a third-party wall mount, note that the length of the screws you can use to attach the product to the wall mount is shown in column C in the table on the next page.

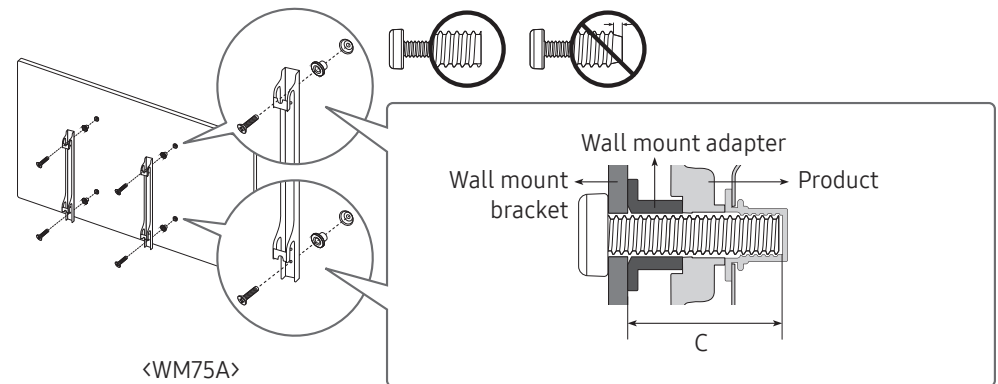

Wall Mount Kit Specifications (VESA)

 Install your wall mount on a solid wall perpendicular to the floor. To install the product on the other wall area, contact the nearest agency.

If you install the product on a slanted wall, it may fall and result in severe personal injury.

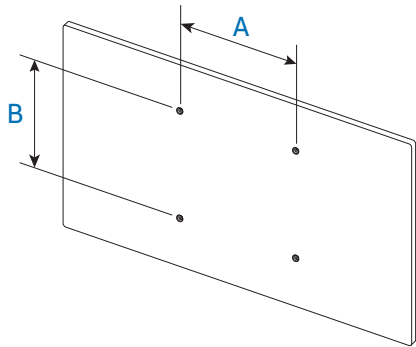

- Samsung wall mount kits contain a detailed installation manual and all parts necessary for assembly are provided.
- Do not use screws that are longer than the standard length or do not comply with the VESA standard screw specifications. Screws that are too long may cause damage to the inside of the product.
- For wall mounts that do not comply with the VESA standard screw specifications, the length of the screws may differ depending on the wall mount specifications.
- Do not fasten the screws too firmly. This may damage the product or cause the product to fall, leading to personal injury. Samsung is not liable for these kinds of accidents.
- Samsung is not liable for product damage or personal injury when a non-VESA or non-specified wall mount is used or the consumer fails to follow the product installation instructions.
- Always have at least two people mount the product on a wall. (Four or more people for the 82-inch size and larger models.)
- Standard dimensions for wall mount kits are shown in the table below.

Model Name	VESA screw hole specs (A * B) in millimetres	C (mm)	Standard Screw	Quantity
WM75A	400 x 400	43 - 45	M8	4
WM85A	600 x 400	36 - 38		

 Do not install your Wall Mount Kit while your product is turned on. It may result in personal injury due to electric shock.

Connecting to a network

 Connecting parts may differ in different products.

Network Settings (Wired)

Connecting to a Wired Network

There are three ways to attach your product to your LAN using cable.

- You can attach your product to your LAN by connecting the LAN port on the back of your product to an external modem using a LAN cable. See the diagram below.

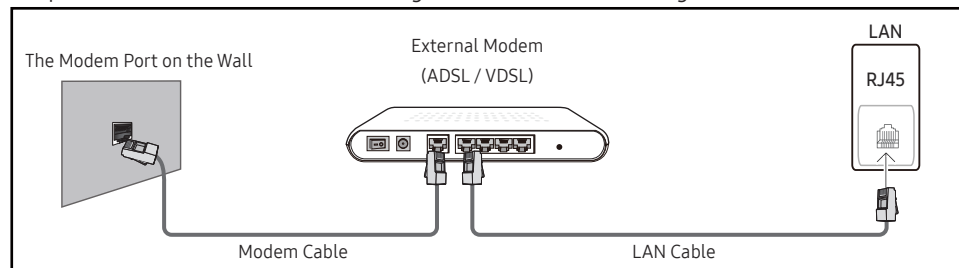

- You can attach your product to your LAN by connecting the LAN port on the back of your product to an IP Sharer which is connected to an external modem. Use LAN cable for the connection. See the diagram below.

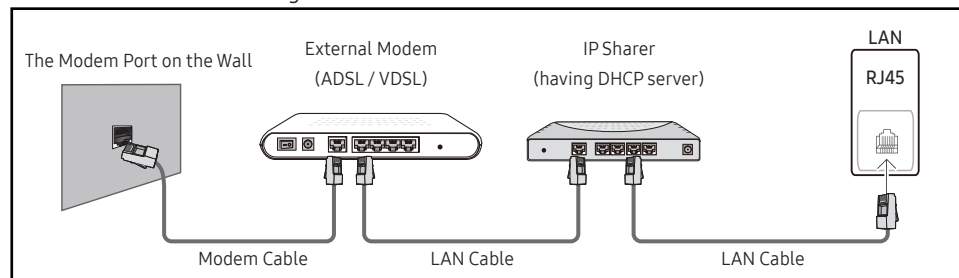

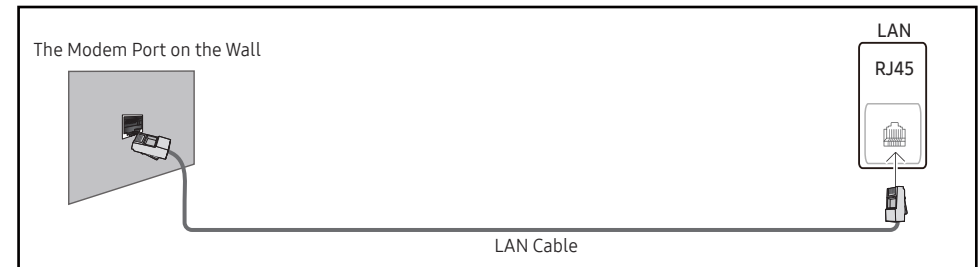

- Depending on how your network is configured, you may be able to attach your product to your LAN by connecting the LAN port on the back of your product directly to a network wall outlet using a LAN cable. See the diagram below. Note that the wall outlet is attached to a modem or router elsewhere in your house.



If you have a Dynamic Network, you should use an ADSL modem or router that supports the Dynamic Host Configuration Protocol (DHCP). Modems and routers that support DHCP automatically provide the IP address, subnet mask, gateway, and DNS values your product needs to access the Internet so you do not have to enter them manually. Most home networks are Dynamic Networks.

Some networks require a Static IP address. If your network requires a Static IP address, you must enter the IP address, subnet mask, gateway, and DNS values manually on your product Cable Setup Screen when you set up the network connection. To get the IP address, subnet mask, gateway, and DNS values, contact your Internet Service Provider (ISP).

If you have a Windows computer, you can also get these values through your computer.

-  You can use ADSL modems that support DHCP if your network requires a Static IP address.
-  ADSL modems that support DHCP also let you use Static IP addresses.



Set the network connection to use Internet services such as perform software upgrades.

Automatic Open Network Settings (Wired)

Connect to the network using a LAN cable.

Make sure a LAN cable is connected first.

How to set up automatically

- 1 Set **Network Type** to **Wired** from the **Open Network Settings** page.
- 2 The network test screen appears and verifies the network connection.
When the connection has been verified, the **“Success! Your device is connected to the Internet. If you have any problems using online services, please contact your Internet service provider.”** message appears.
 If the connection process fails, check the LAN port connection.
 If the automatic process cannot find the network connection values or if you want to set the connection manually, go to the next section(Manual Open Network Settings (Wired)).

Manual Open Network Settings (Wired)

Offices may use static IP addresses.

If this is the case, ask the network administrator for the IP address, subnet mask, gateway and DNS server address. Enter these values manually.

Getting the Network Connection Values

To view the Network connection values on most Windows computers, follow these steps.

- 1 Right click the Network icon on the bottom right of the screen.
- 2 In the pop-up menu that appears, click Status.
- 3 On the dialog that appears, click the **Support** tab.
- 4 On the **Support** Tab, click the **Details** button. The Network connection values are displayed.

How to set up manually



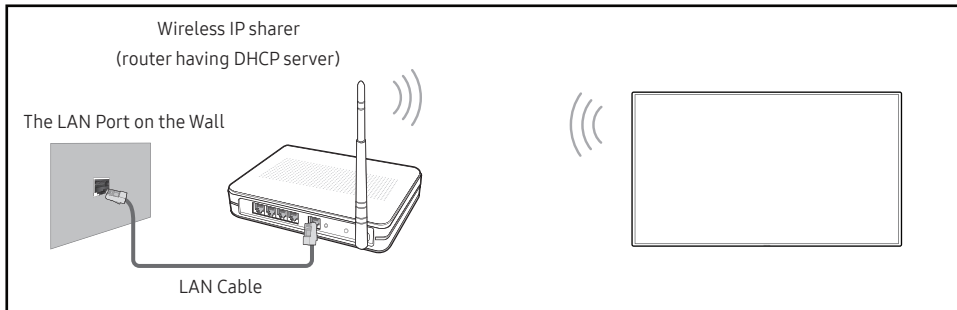

- 1 Set **Network Type** to **Wired** from the **Open Network Settings** page.
- 2 The network test screen appears and the verification process starts. Press **Cancel**. The verification process stops.
- 3 Select **IP Settings** on network connection screen. The **IP Settings** screen appears.
- 4 Select the field at the top and then set **IP setting** to **Enter manually** Repeat the entry process for each field in the **IP Address**.
 Setting **IP setting** to **Enter manually** automatically changes **DNS setting** to **Enter manually**.
- 5 When done, select **OK** at the bottom of the page. The network test screen appears and the verification process starts.
- 6 When the connection has been verified, the **“Success! Your device is connected to the Internet. If you have any problems using online services, please contact your Internet service provider.”** message appears.

Network Settings (Wireless)

Connecting to a Wireless Network





Samsung recommends using IEEE 802.11n. When you play video over a network connection, the video may not play smoothly.

-  Select a channel for the wireless IP sharer that is not currently being used. If the channel set for the wireless IP sharer is currently being used by another device nearby, this will result in interference and communication failure.
-  Your product supports only the following wireless network security protocols. If you select the Pure High-throughput (Greenfield) 802.11n mode and the Encryption type is set to WEP, TKIP or TKIP AES (WPS2Mixed) on your AP or wireless router, Samsung products will not support a connection in compliance with new Wi-Fi certification specifications.
-  If your wireless router supports WPS (Wi-Fi Protected Setup), you can connect to the network via PBC (Push Button Configuration) or PIN (Personal Identification Number). WPS will automatically configure the SSID and WPA key in either mode.
-  Connection Methods: You can setup the wireless network connection in three ways. Auto Setup (Using the Auto Network Search function), Manual Setup, **Use WPS**
-  This product supports Enterprise WPA2 (TLS/TTLS/PEAP).

Automatic Network Setup (Wireless)

Most wireless networks have an optional security system that requires devices that access the network to transmit an encrypted security code called an Access or Security Key. The Security Key is based on a Pass Phrase, typically a word or a series of letters and numbers of a specified length you were asked to enter when you set up security for your wireless network. If you use this method of setting up the network connection, and have a Security Key for your wireless network, you will have to enter the Pass Phrase during the the automatic or manual setup process.

How to set up automatically

- 1 Set **Network Type** to **Wireless** from the **Open Network Settings** page.
- 2 The **Network** function searches for available wireless networks. When done, it displays a list of the available networks.
- 3 In the list of networks, select a network.
 -  If the desired wireless router does not appear, select **Refresh** to search again.
 -  If the router cannot be found after retrying, select the **Add Network**.
- 4 If the **Enter the password for (AP Name)** screen appears, go to step 5. If you select a wireless router that does not have security, go to step 7.
- 5 If the router has security, enter the **Enter the password for (AP Name)**. (Security key or PIN).
- 6 When done, select **Done**. The network connection screen appears and the verification process starts.
 -  A connection with the router is established, but the Internet cannot be accessed. In this case, contact your Internet service provider.
- 7 When the connection has been verified, the **"Success! Your device is connected to the Internet. If you have any problems using online services, please contact your Internet service provider."** message appears.

Manual Network Setup (Wireless)

Offices may use static IP addresses.



If this is the case, ask the network administrator for the IP address, subnet mask, gateway and DNS server address. Enter these values manually.

Getting the Network Connection Values

To view the Network connection values on most Windows computers, follow these steps.

- 1 Right click the Network icon on the bottom right of the screen.
- 2 In the pop-up menu that appears, click Status.
- 3 On the dialog that appears, click the **Support** tab.
- 4 On the **Support** Tab, click the **Details** button. The Network connection values are displayed.

How to set up manually

- 1 Set **Network Type** to **Wireless** from the **Open Network Settings** page.
- 2 The **Network** function searches for available wireless networks. When done, it displays a list of the available networks.
- 3 In the list of networks, select a network.
 -  If the desired wireless router does not appear, select **Refresh** to search again.
 -  If the router cannot be found after retrying, select the **Stop** button. The **Add Network** button appears.
- 4 If the **Enter the password for (AP Name)** screen appears, go to step 5. If you select a wireless router that does not have security, go to step 7.
- 5 If the router has security, enter the **Enter the password for (AP Name)**. (Security key or PIN).
- 6 When done, select **Done**. The network connection screen appears and the verification process starts.
- 7 Select **Cancel** while network connections are being attempted. This will stop the connection.
- 8 Select **IP Settings** on network connection screen. The **IP Settings** screen appears.
- 9 Select the field at the top and then set **IP setting** to **Enter manually**. Repeat the entry process for each field in the **IP Address**.
 -  Setting **IP setting** to **Enter manually** automatically changes **DNS setting** to **Enter manually**.
- 10 When done, select **OK** at the bottom of the page. The network test screen appears and the verification process starts.
- 11 When the connection has been verified, the **“Success! Your device is connected to the Internet. If you have any problems using online services, please contact your Internet service provider.”** message appears.

Use WPS

How to set up using Use WPS

If your router has a **Use WPS** button, follow these steps.

- 1 Set **Network Type** to **Wireless** from the **Open Network Settings** page.
- 2 Select **Use WPS**.
- 3 Press the WPS or PBC button on your wireless router within the next two minutes. Your product automatically acquires all the network setting values it needs and connects to your network.
- 4 The network connection screen appears, and network setup is done.

Chapter 03

Writing

What's a 'Roll'?

- Files are called 'rolls' in this product. A 'roll' is a file with multiple pages linked together.
- A roll can have up to 20 pages linked together.
 - ✎ **BRUSH MODE** supports one page only.
- ✎ You can open only one roll on one screen. For more information, refer to '[Managing Rolls](#)'.

Landscape orientation

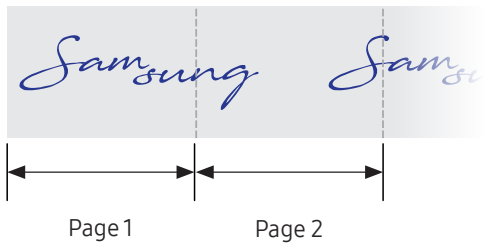

PEN MODE

Screen Elements

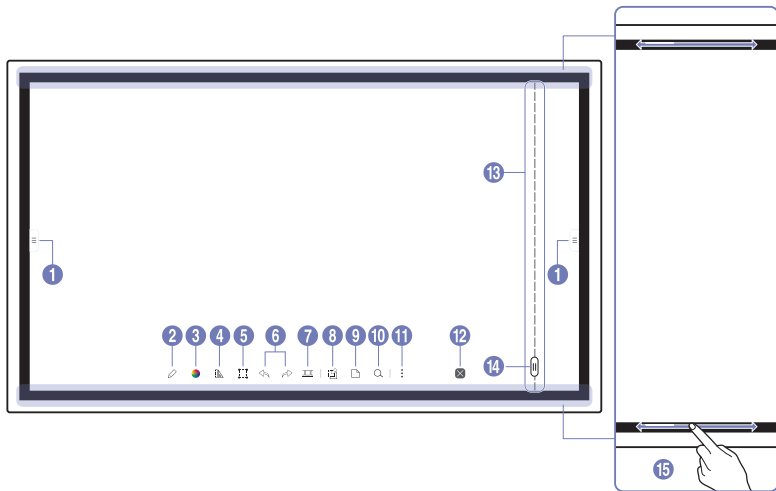

Buttons	Description
1	Tap to open the IMPORT/EXPORT window. <ul style="list-style-type: none"> IMPORT: View the screen of a mobile device or PC connected to the product, or import data such as images from a connected USB or network drive. EXPORT: Share your creations in various ways.
2	Tap to select a mode. You can select from PEN MODE or BRUSH MODE .
3	Tap to open the Palette. You can select the colour and thickness of the pen and the highlighter.
4	Use math tools to make geometric constructions and take measurements.
5	Select and edit / capture / email / print the pen or brush content.
6	Undo or redo the last action. <ul style="list-style-type: none"> If any page editing actions such as page adding, deleting, and moving are found, / is reset. <p> / can be performed up to 20 times for each individual.</p>
7	Move or edit the created rolls for each page.
8	Create a layer to write or draw on over the screen which can also be saved the captured image.
9	Bring out Miniboard to take notes or draw as a separate layer above the viewer or source screen.
10	Tap to search the Internet.
11	Manage and change the rolls and settings.
12	Close the current roll and create a new roll.
13 Page breaking line	See page lines.
14	Scroll through pages.
15 Bezel Scroll	Scroll the black area to move the pages.

Drawing

You can freely use the supplied pen to write anything you want.

- Thin Tip (A): Pen Type
- Thick Tip (B): Highlighter Type

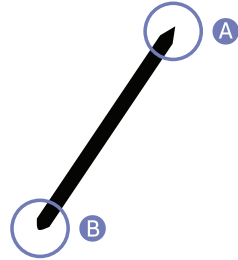

Changing the pen thickness and colour

You can change the pen thickness and colour by touching and holding the screen with the pen.

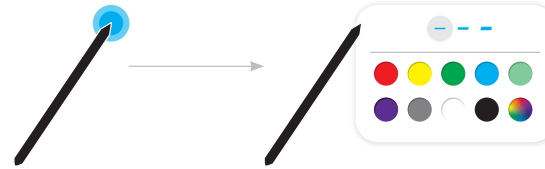

Erasing



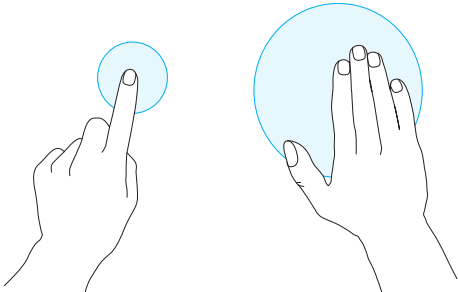





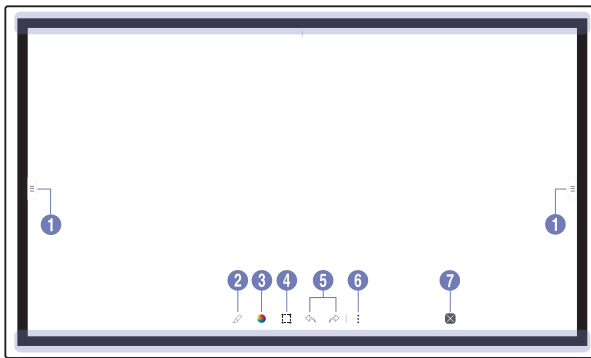



You can use your finger or palm to erase your writing.



BRUSH MODE

Screen Elements



Buttons	Description
1 	Tap to open the IMPORT/EXPORT window. <ul style="list-style-type: none"> IMPORT: View the screen of a mobile device or PC connected to the product, or import data such as images from a connected USB or network drive. EXPORT: Share your creations in various ways.
2 	Tap to select a mode. You can select from PEN MODE or BRUSH MODE .
3 	Tap to open the Palette. You can select the colour and use other options. <ul style="list-style-type: none"> : Dry colours to stop blending. : Extract the colour from the selected point. : Delete the selected area.
4 	Select and edit / capture / email / print the pen or brush content.
5 	Undo or redo the last action. <ul style="list-style-type: none"> If any page editing actions such as page adding, deleting, and moving are found,  is reset. <p>  can be performed up to 20 times for each individual.</p>
6 	Manage and change the rolls and settings.
7 	Close the current roll and create a new roll.



 Changes in the thickness depending on the area touching the screen apply immediately. (max. 5.0 cm)

 Brush use is recommended.

 **BRUSH MODE** supports single touch only.

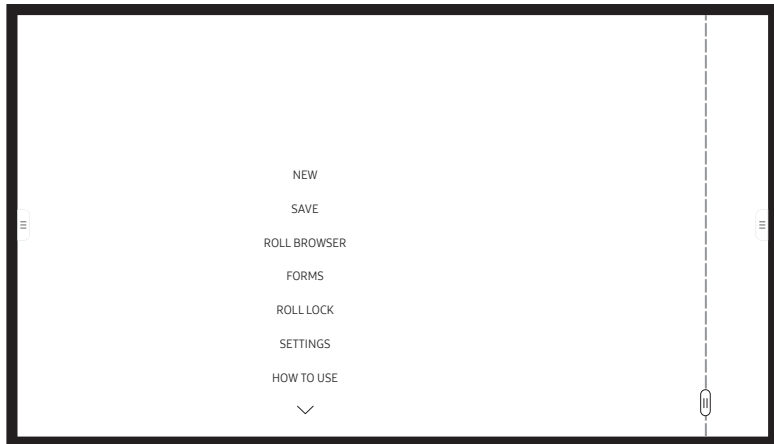
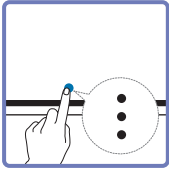
Managing Rolls



Buttons	Description
NEW	Create a new roll.
SAVE	Save the current roll.
ROLL BROWSER	Open, delete or export saved rolls.
FORMS	Change the background format.  This menu is only visible in PEN MODE mode.
ROLL LOCK / UNLOCK	<ul style="list-style-type: none">ROLL LOCK: Press a six-digit password to lock the current roll.UNLOCK: To unlock a locked roll, press the six-digit password you set when locking the roll.  Once unlocked, the current roll remains unlocked until it is locked again.
SETTINGS	You can see the configuration menu.
HOW TO USE	You can view How To Use.

ROLL EXPLORER

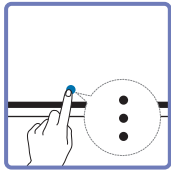

→ **ROLL BROWSER**

Open, browse and manage rolls via the Rolls explorer.

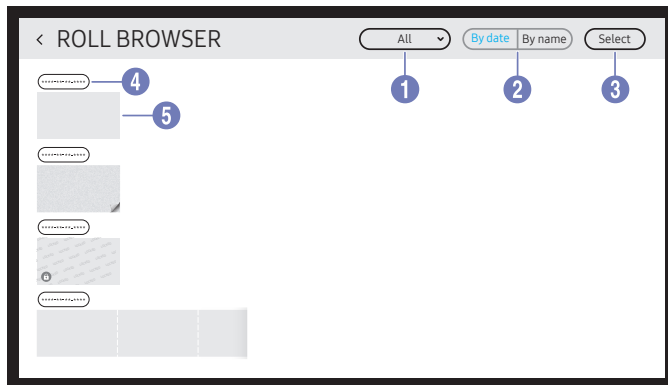

Parts	Description
1 All	You can view the list by the mode you want. <ul style="list-style-type: none"> All / Pen Mode / Brush Mode
2 By date ↔ By name	Set the sort order of files. <ul style="list-style-type: none"> By date: The rolls are sorted by recent date. This is the default sort option. By name: The rolls are sorted by name of the rolls.
3 Select	Select multiple rolls to export or delete.
4 File name	Rename the file.
5 Rolls	Browse and open a desired roll.

To open a locked roll (🔒), press the six-digit password.

Deleting / Exporting rolls

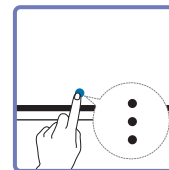

→ **ROLL BROWSER** → **Select**

You can select multiple rolls to export or delete.

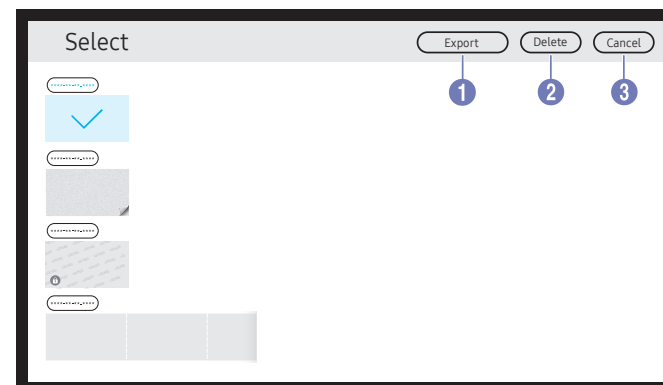

Parts	Description
1 Export	Share the selected rolls any way you like. <ul style="list-style-type: none"> Email (@) / USB (📁) / Network Drive (☁)
2 Delete	Delete the selected rolls.
3 Cancel	Deselect the roll.

Page Viewer

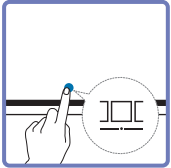

You can move or edit the created rolls for each page.

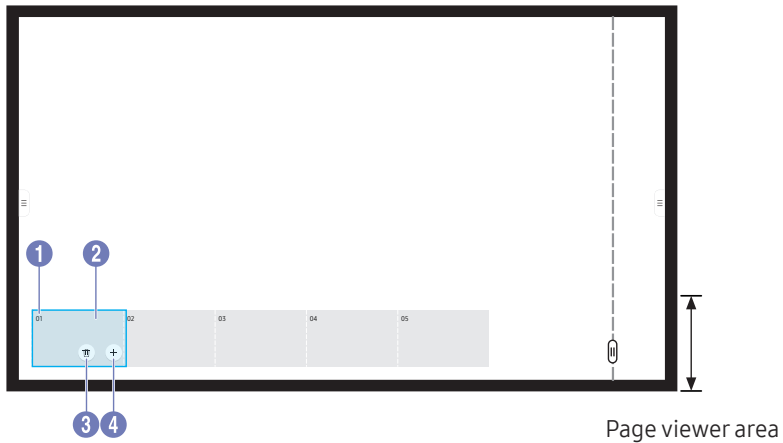

Page viewer area

This menu is only visible in **PEN MODE** mode.

Parts	Description
1 Page number	Displays the page number.
2 Focus	Displays the page you are currently viewing. <ul style="list-style-type: none">When you tap a page, the focus is moved to it.
3	Delete the focused page.
4	Add a new page to the focused position. You can create up to 20 pages per roll.

The displayed image may differ depending on the model.

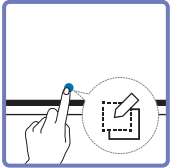

Note On/Off

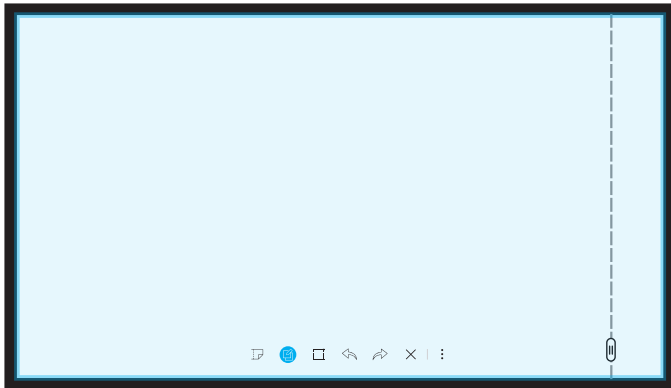

Add a layer over the screen to write or draw on. This can be useful for adding note to content from an external source.



 This menu is only visible in **PEN MODE** mode.

- 1 Tap  to add a new note layer over the screen.
- 2 Take note on the layer.
- 3 Tap  to select one of the following options.
 - **Save / Don't Save / Cancel**

Using the Selection Tools

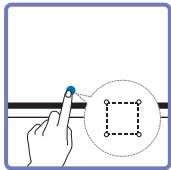

Select and edit / capture / email / print the pen or brush content. Use to move, rotate, or resize the selection.

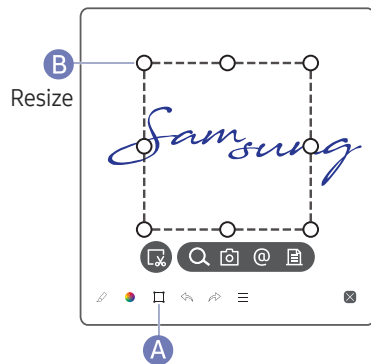

Search / capture / email / print

- 1 Tap **A** in the screen bottom. A select box appears on the screen.
 - Drag the **B** of the select box to adjust the size.
- 2 Select the area and choose from / / / options.
 - The product must be connected to a network to use the email or print option.
 - The **Search** function is only available for handwriting.

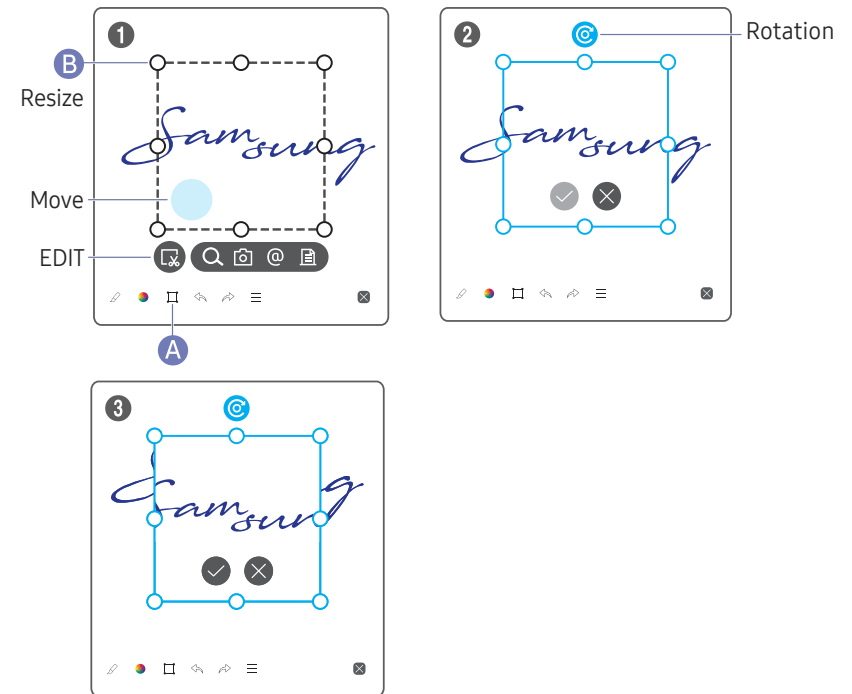

Editing pen and brush content

- The changes apply to pen and brush content only.
- 1 Tap **A** in the screen bottom. A select box appears on the screen.
 - Drag the **B** of the select box to adjust the size.
 - 2 Tap to enable editing for the selected area.
 - 3 Move, rotate or resize the selected area and tap .
 - Tap to abort the changes.







Chapter 04

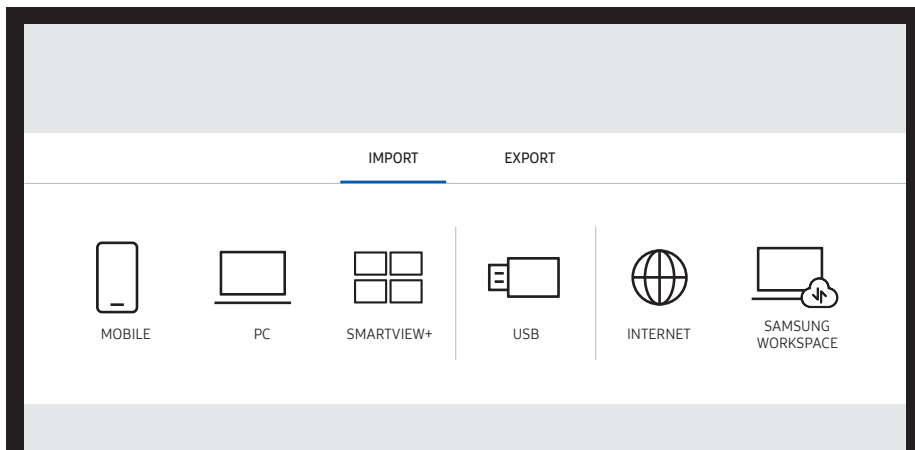



IMPORT

You can view the screen of a mobile device or PC connected to the product, or import data such as images from a connected USB or network drive.

- Tap  on the left or right side of the screen to open the **IMPORT/EXPORT** window. Then, tap **IMPORT** to select the desired device.



Icons	Description
	Displays the screen from a mobile device by using Smart View or Screen Mirroring function.
	Displays your PC screen using HDMI, DisplayPort, OPS connection or Wireless Display .
	You can display the screen shared from your PC, mobile, or tablet.
	Import videos, images, native FLIP files, or document files from a USB device.
	Connect the network to access the Internet from the product like accessing the Internet from a computer.
	Access to remote PC and your work resources with this function.



-  The native FLIP format (.iwb) refers to files that are directly saved from the device and only supported by FLIP devices.
-  Supported video file formats: avi, mkv, asf, wmv, .mp4, mov, 3gp, vro, mpg, mpeg, ts, tp, trp, flv, vob, svi, m2ts, mts, .webm, .rmvb
-  Supportable image file formats: JPG, BMP, PNG, MPO
-  Supported document file formats: DOC, PPT, PDF, XLS, XLSX

Connecting to a Mobile Device

☰ → IMPORT → MOBILE

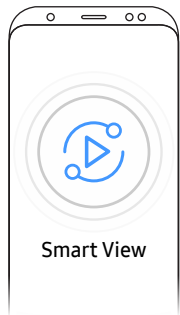
Connecting using Smart View or Screen Mirroring



- 1 Drag down the top bar on the mobile device screen to start Smart View or Screen Mirroring.
 - 2 Select this product from the list of devices displayed on the screen.
 - The initial device name is **[FLIP] Samsung WMA Series**.
-  You can control the mobile device from the product screen.
-  HDCP (High-bandwidth Digital Content Protection) contents will not show on the screen if **PIP Capture** is set to **On**.

Connecting to a PC

☰ → IMPORT → PC

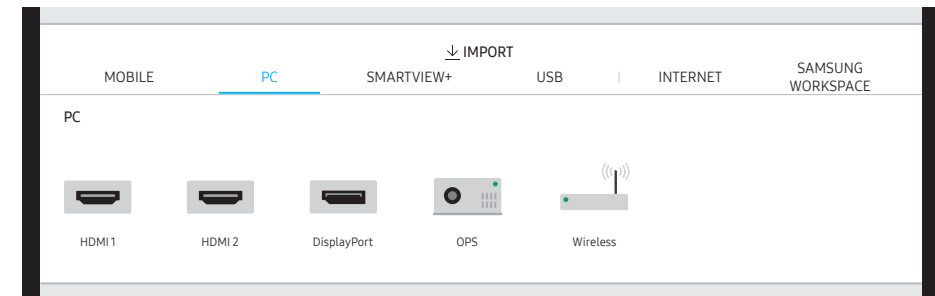

Connecting using a cable

 Connecting parts may differ depending on the model.

1 Connect the product to the PC using an HDMI, DP cable.

 HDCP contents will not show on the screen if **PIP Capture** is set to **On**.

 When the screen is black, turn off **PIP Capture** because some graphic cards can support HDCP automatically.



2 Select  → **IMPORT** → **PC** → **HDMI, DisplayPort** on the screen.

3 To control the PC from the product screen, connect the supplied USB cable to the **TOUCH**  port on the product.

 If used in a multi-screen setup, make sure you have configured FLIP as the main display.



Connecting using a OPS (Sold separately)

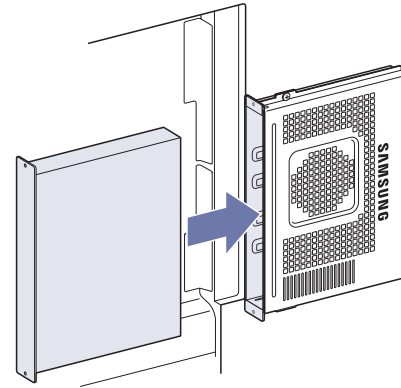



Touchscreen may not work properly during initial OPS Windows settings. Connect a mouse and keyboard to OPS for use during initial settings.

Connecting via the Wireless Display function

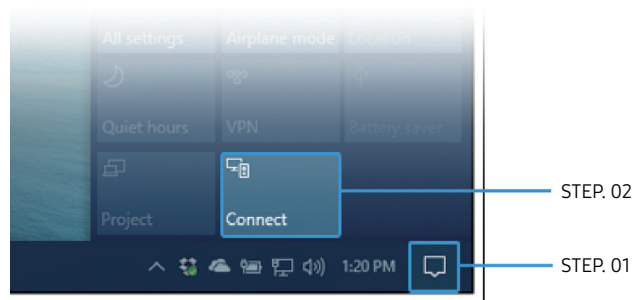
 This function is only available for the laptop that supports the Wireless Display function.





- 1 Select **Action Center** or **Devices** in the taskbar notification area of the laptop.
- 2 Click **Connect** or **Project** and select a [Flip] Samsung WMA Series device to complete the connection.

-  The connection procedure may vary depending on the laptop.
-  After the **Wireless Display** connection is made, you can control the laptop screen from the product screen.
-  This function is only supported by **Windows 8.1 and 10**.

Connecting via SMARTVIEW+

 → **IMPORT** → **SMARTVIEW+**

You can display the screen shared from your PC, mobile, or tablet.

- 1 Select **SMARTVIEW+**.
 - 2 Once **SMARTVIEW+** starts, follow the onscreen instruction to connect with the desired device.
-  The CA certificate installation is required for the PC Client, and you can download the CA certificate from the URL provided in the initial screen of **SMARTVIEW+**.
 -  If the Client device's screen aspect ratio differs from the Flip, the Client device may transmit a partially cropped screen. You may experience a partially cropped image of the Client device's screen on Flip since it displays according to the signal received from the Client device.
 -  **SMARTVIEW+** supports the following browsers; however, browsers on some devices may not work normally.
 - Chrome / Safari / Edge / Firefox

Importing from a USB Device

☰ → IMPORT → USB

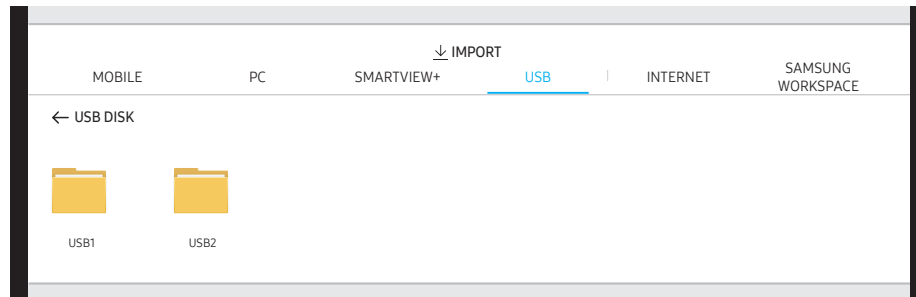

 The contents displayed on your product screen may differ from the above image.

Connect an external HDD or a USB storage device.

 Import videos, images, native FLIP files (.iwb), or document files.

Connecting to Internet

☰ → IMPORT → INTERNET

Connect the network to access the Internet from the product like accessing the Internet from a computer.

Capture, reposition, or see the browser window in full screen view.

 A specific page may not appear or work due to compatibility issues.

Read before using the INTERNET function

Read this information before using the **INTERNET** function.

- File download is not supported.
- The **INTERNET** function may not be able to access certain websites, including websites operated by certain companies.
- The TV does not support playback of flash videos.
- E-commerce for online purchases is not supported.
- ActiveX is not supported.
- Only a limited number of fonts are supported. Certain symbols and characters may not be displayed properly.
- The response to remote commands and the resulting on-screen display may be delayed while a web page is loading.
- Loading a web page may be delayed or suspended completely depending on the status of the participating systems.
- Copy and paste operations are not supported.
- When composing an email or a simple message, certain functions such as the font size and color selection may not be available.
- There is a limit to the number of bookmarks and the size of the log file that can be saved.
- The number of windows that can be opened concurrently is limited.
- Web browsing speed will differ with the network environment.
- Browsing history is saved from latest to oldest, with the oldest entries being overwritten first.
- Depending on the types of video/audio codecs supported, you may not be able to play certain HTML5 video and audio files.
- Video sources from PC-optimized streaming service providers may not play properly on our proprietary **INTERNET** browser.

Connecting to SAMSUNG WORKSPACE

☰ → IMPORT → SAMSUNG WORKSPACE

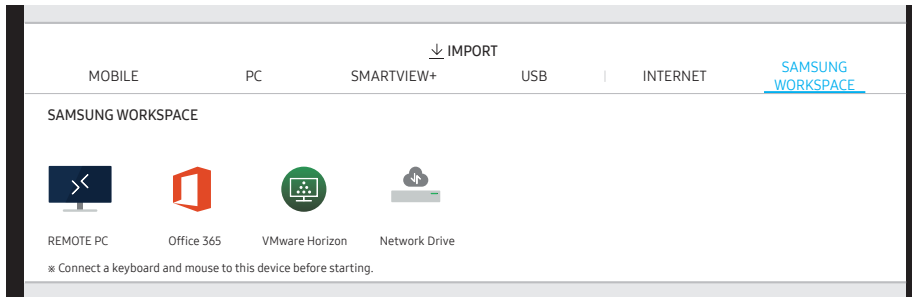

Access to remote PC and your work resources with this function.

- **REMOTE PC:** This function allows you to connect your product to a remote PC or a cloud server.
 - ✎ Only PCs or Cloud Servers running on macOS/Windows 7 Pro or newer are supported.
- **Office 365:** Provides access to **Office 365** features from Microsoft.
- **VMware Horizon:** Enterprise customers who won VMware Infrastructure can access **VMware Horizon**.
- **NETWORK DRIVE:** Connect the network drive to bring files.
 - ✎ You can register a network drive while the network is connected.
For information about how to connect to a network, see '[Connecting to a network](#)'.
 - ✎ You can register a network drive account at ☰ → **SETTINGS** → **Connect** → **Advanced Settings** → **Network Drive** → **Add Account**.
To register a network drive account, you must enter the **Address**, **Username**, and **Password**.
To register your network drive account, refer to '[Add Account](#)' for **Network Drive**.
 - ✎ Import videos, images, native FLIP files (.iwb), or document files.

Source Window

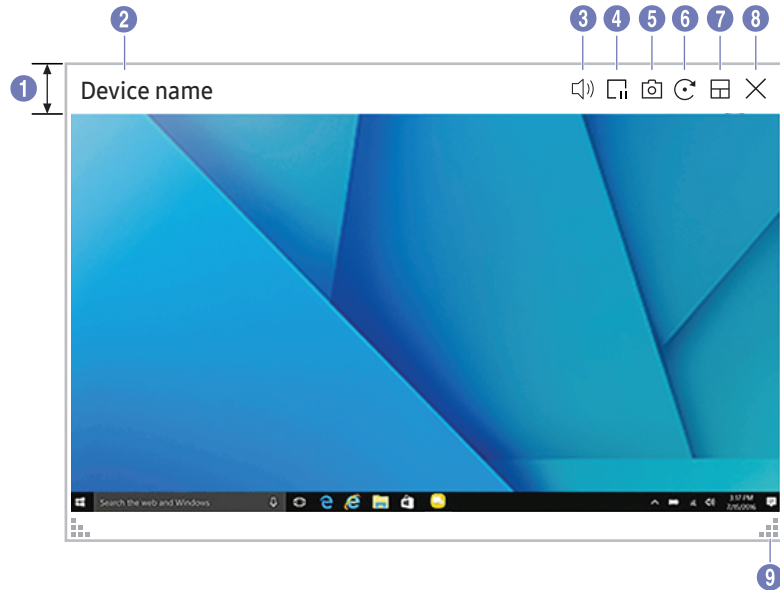

Available functions may differ depending on the PIP setting.

When you connect a PC or a mobile device to the product, the source window appears.









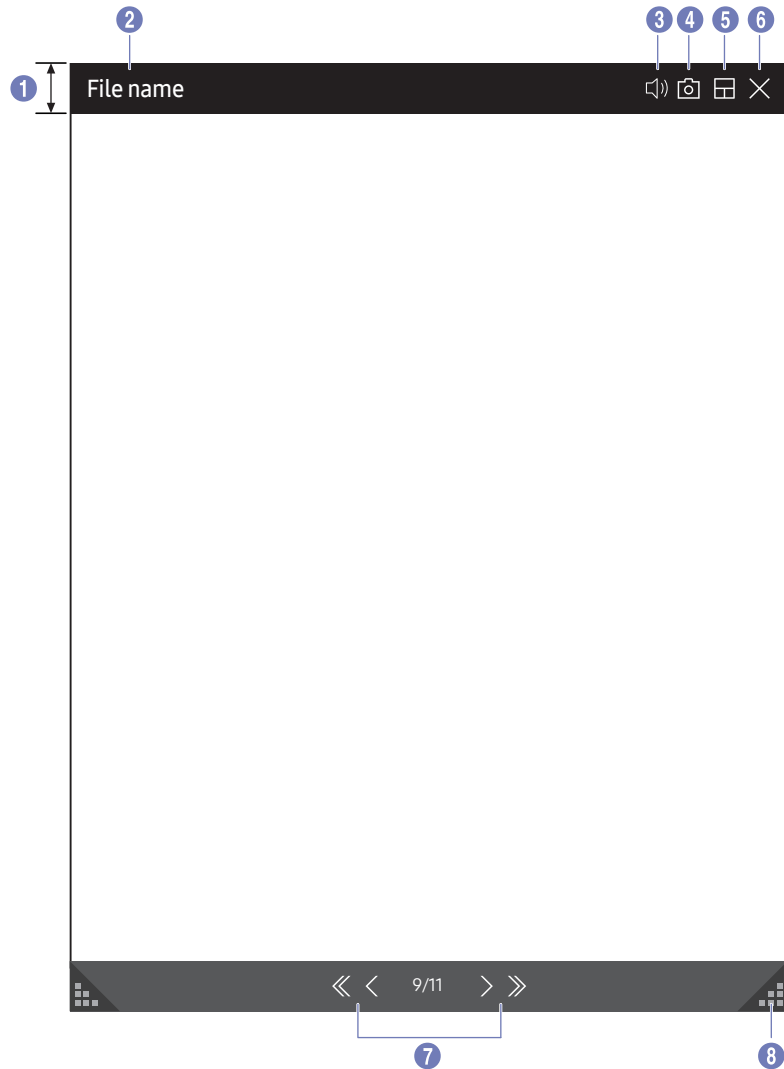







Parts	Description
1 Menu bar	Drag the source window to move to the desired position.
2 Device name / Source port	Displays the name of the connected device or source port.
3	Adjust the volume.
4	Pause the input screen display.
5	Capture the source window. This feature is not available when PIP Capture is set to Off .
6	Rotate the source window. This function is supported only on Android 8.0 Oreo version or later of Samsung mobile devices.
7	Change the input screen position or view it on full screen. <ul style="list-style-type: none"> The icon images are for position reference only. The size of the screen may differ from what is shown.
8	Close the viewer.
9	Adjust the size of the source window.

Document view

Displays the document file you select to import from a USB device or network drive.

 Supported document file formats: DOC, PPT, PDF, XLS, XLSX









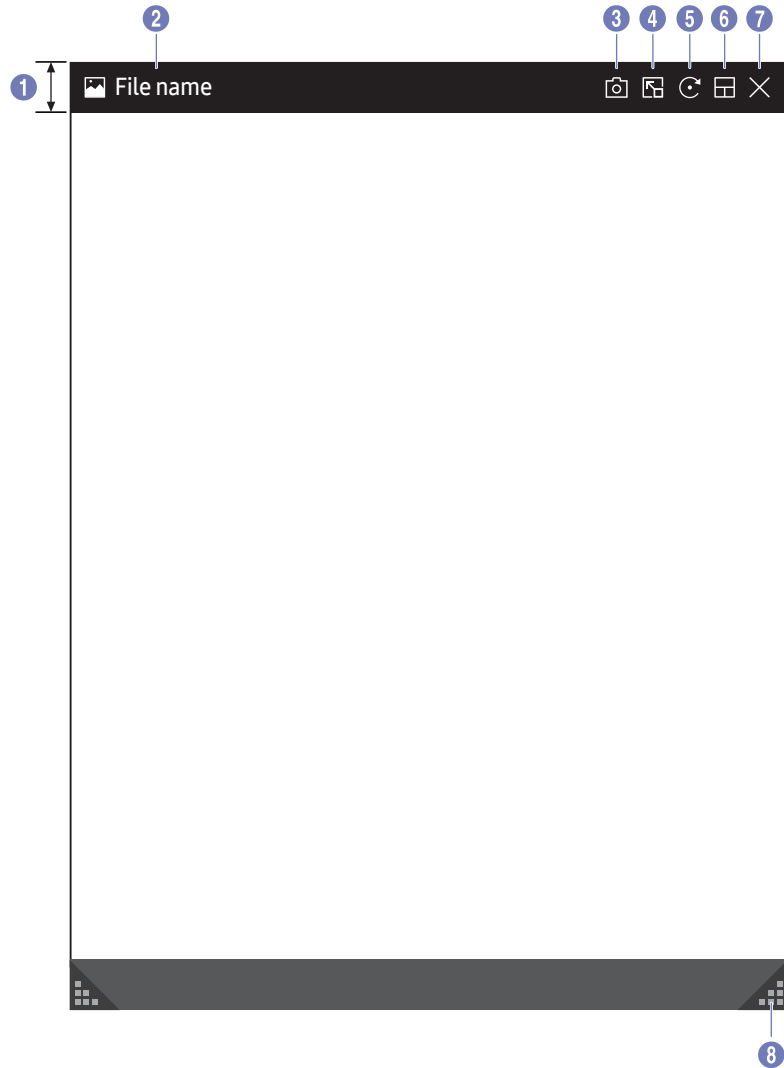

Parts	Description
 Menu bar	Drag the menu bar to move the viewer around.
 File name	Name of the currently viewing file.
 	Adjust the volume.
 	Capture the document viewer screen.  This feature is not available when PIP Capture is set to Off .
 	Change the input screen position or view it on full screen. • 
 	Close the viewer.
 	Tap  to move between pages.
 	Adjust size of the viewer.

 Available functions may differ depending on the PIP setting.

Image view

Select the file to import from the USB device or network drive.



Parts	Description
1	Menu bar Drag the menu bar to move the viewer around.
2	File name Name of the currently viewing file.
3	 Capture the image viewer screen.
4	 Tap  to paste the image to the roll.
5	 Rotate the image.
6	Change the input screen position or view it on full screen. • 
7	 Close the viewer.
8	 Adjust size of the viewer.









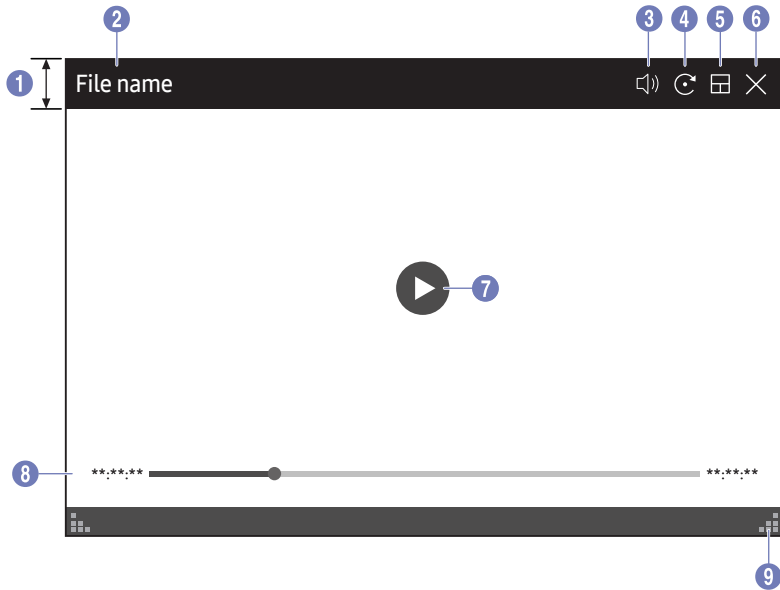







 Available functions may differ depending on the PIP setting.

Video view

Select the video file to import from a USB or network device and display.

 Supported video file formats: avi, mkv, asf, wmv, .mp4, mov, 3gp, vro, mpg, mpeg, ts, tp, trp, flv, vob, svi, m2ts, mts, .webm, .rmvb



Parts	Description
 Menu bar	Drag the menu bar to move the viewer around.
 File name	Name of the currently viewing file.
 	Adjust the volume.
 	Rotate the video screen.
 	Change the input screen position or view it on full screen. <ul style="list-style-type: none"> 
 	Close the viewer.
 	Play or pause the video.
 Playback slider and time details	Navigate through the video and view time details for the file.
 	Adjust size of the viewer.

 Available functions may differ depending on the PIP setting.





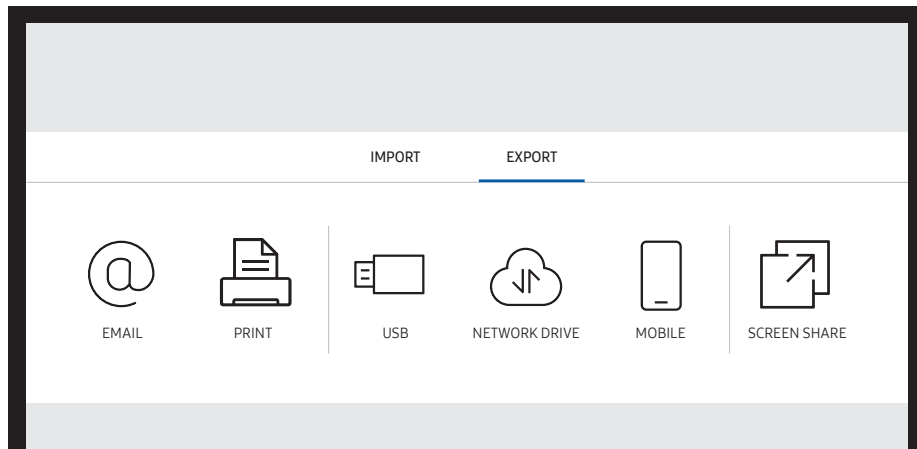

Chapter 05

EXPORT

You can export your created rolls in various ways.

- Tap  on the left or right side of the screen to open the **IMPORT/EXPORT** window. Then, tap **EXPORT** to select the desired menu.



Icons	Description
	Send your created rolls via email.
	Print your created rolls.
	Export your created rolls to a connected USB device.
	Export your created rolls to a registered and connected network drive.
	Send the roll to a mobile device.
	Share your screen with selected devices.

Sending Email

☰ → EXPORT → EMAIL

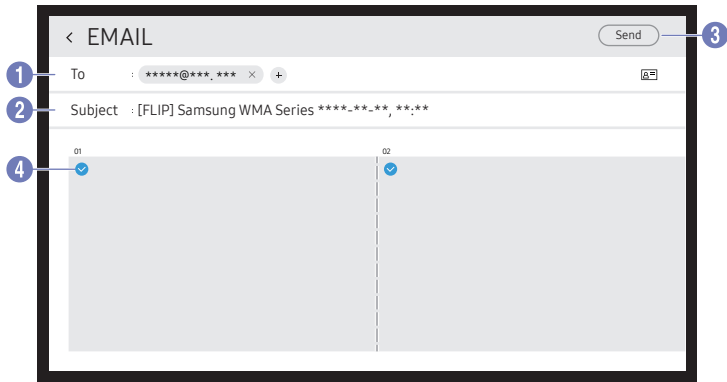

To send your created rolls via email, first register your email account.

You can register your email account at : → **SETTINGS** → **Connect** → **Advanced Settings** → **Email**.

If you set **Sender Authentication** to **Personal Account** at : → **SETTINGS** → **Connect** → **Advanced Settings** → **Email**, you must authenticate your account each time you send an email. See below.

- You can send emails when **Sender Authentication** is set to **Personal Account** as long as you have an account on that mail server (**SMTP Server Name** and **SMTP Port Number**).

Note that it requires the sender to provide the SMTP account ID and password, as well as the sender address for every email.

- If you set **Sender Authentication** to **Default Account**, you can use the SMTP ID and password you saved to **Default Account** to send emails. (The sender address is usually identical to the SMTP ID, with some exceptions depending on the SMTP server.)
- For the SMTP information required to register a mail server, contact your mail server administrator.

Files saved as dedicated files are converted to PDF files and sent.

Parts	Description
1 To	Enter the recipient's email address. <ul style="list-style-type: none">• Press + and type text by using the virtual keyboard. Press ✍ on the virtual keyboard to enter text by handwriting. Search recipient in Local Address Book or LDAP server.
2 Subject	The email subject is automatically set to the device name and the current date.
3 Send	Send the email.
4	Select the pages to send.

Printing

To print, you must set up the **Print Server** and the **Clock Set**.

To set up the **Print Server**, the product and the printer you want and your PC must be connected to the same network.

Flip Printing Software must be also installed on the PC connected.

- ✎ For information about how to connect to a network, see '[Connecting to a network](#)'.
- ✎ You can set up the **Print Server** at : → **SETTINGS** → **Connect** → **Advanced Settings** → **Print Server**.
- ✎ You can set **Clock Set** at : → **SETTINGS** → **System** → **Time** → **Clock Set**.
- ✎ The **Flip Printing Software** is available on the website
 - <http://displaysolutions.samsung.com>
 - <http://www.samsung.com>
- ✎ Devices that transfer files, such as virtual printers (PDF, XPS, One note, etc.) or fax machines, are not supported, but only printers that can print actual paper are supported.
- ✎ For print paper size, only A4 is supported.

Installing Flip Printing Software

Follow the onscreen instructions to install **Flip Printing Software**.

- ✎ The installation takes about 10 minutes, and the time taken may vary depending on your PC environment.

PC installation requirements

- Supported operating systems:
Windows 7(32/64 bit), Windows 10(32/64 bit), MAC
 - ✎ When installing the software, make sure that critical Windows updates are already installed. Update Windows to the latest version before beginning the setup.
 - ✎ For Windows 7, make sure that Service Pack 1 is already installed.

Setting up the printer

After the **Flip Printing Software** is installed, make the following settings on the product onscreen menu.

Setting up automatically



- 1 Select : → **SETTINGS** → **Connect** → **Advanced Settings** menu.
- 2 Select **Print Server** → **Connect to Server** → **Auto**.

Setting up manually

- 1 Select : → **SETTINGS** → **Connect** → **Advanced Settings** menu.
- 2 Select **Print Server** → **Connect to Server** → **Manual**, and then enter the **Server IP** address of the PC where **Flip Printing Software** is installed.

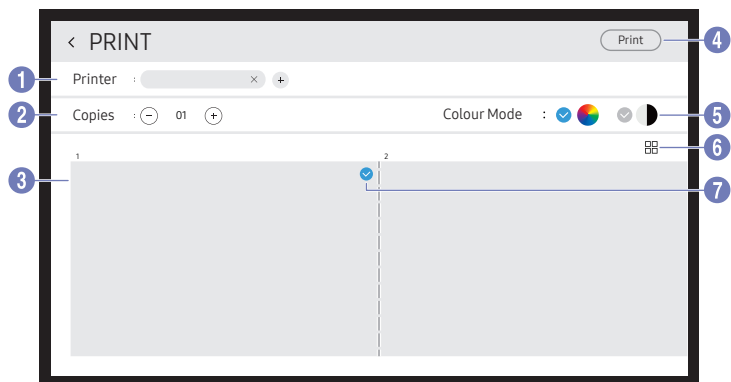
☰ → EXPORT → PRINT



Parts	Description
1 Printer	Displays a list of connected printers. Select a printer to print the roll with.
2 Copies	Set the number of prints.
3 Print preview area	Preview the roll to print.
4 Print	Start the printing.
5 Colour Mode	Select the colour to print the roll with.
6  / 	Change the page view mode of the roll to print.
7 	Select the pages to print.

Exporting to a USB Device

☰ → EXPORT → USB

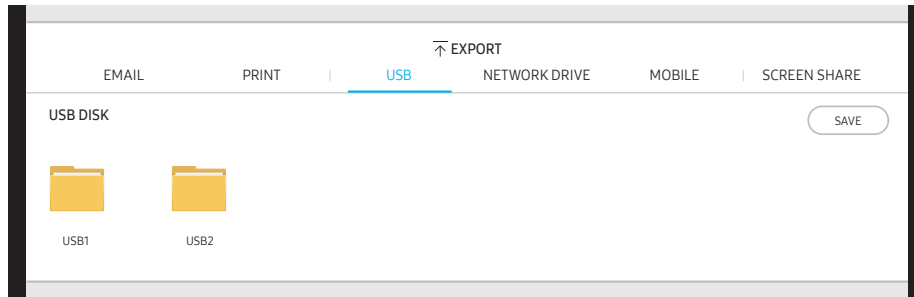

 The contents displayed on your product screen may differ from the above image.

Connect an external HDD or a USB storage device.

 Your device saves files in two versions (IWB and PDF formats).

Exporting from a Network Drive

☰ → EXPORT → NETWORK DRIVE

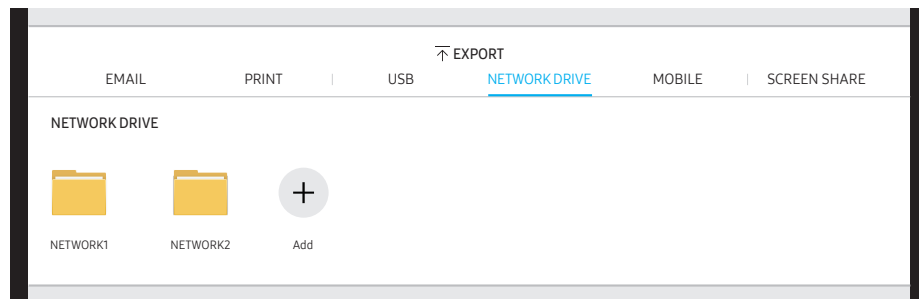

Connect the network drive to save files.

- ✎ You can register a network drive while the network is connected.
For information about how to connect to a network, see '[Connecting to a network](#)'.
- ✎ You can register a network drive account at ☰ → SETTINGS → Connect → Advanced Settings → Network Drive → Add Account.
To register a network drive account, you must enter the **Address**, **Username**, and **Password**.
To register your network drive account, refer to '[Add Account](#)' for **Network Drive**.
- ✎ Your device saves files in two versions (IWB and PDF formats).

Sending to a mobile device

☰ → EXPORT → MOBILE

View the screen of the product from a mobile device.

✎ Sharing is only available for rolls at the moment.

Download **Samsung Flip Mobile** app after searching from Play Store or Galaxy store to your mobile device and enter the following information which can be found on the product screen.

- Versions supported: Android 7.0 or above
- **QR code**, **Wi-Fi Name**, **Wi-Fi Password**, **Server IP address**

Sharing your screen

☰ → EXPORT → SCREEN SHARE

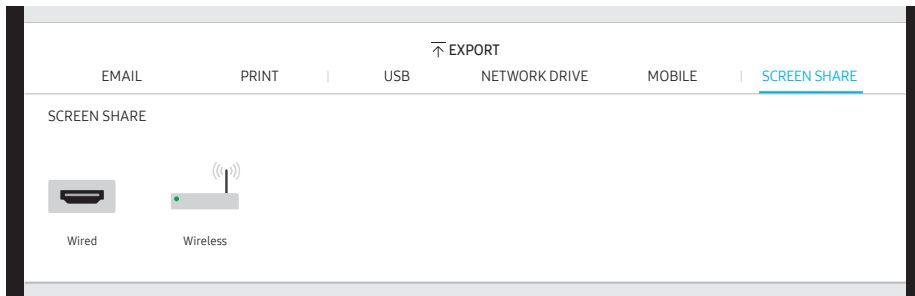

Share your screen with selected devices.

Connecting with HDMI cables

- 3 Use an HDMI cable to connect the SCREEN SHARE port to the external display.
- 4 Select ☰ → EXPORT → SCREEN SHARE → Wired on the screen.
 - ✎ If the PC is connected to the HDMI 2 port on a tray without setting it, the PC screen is shared on the display instead.
- 5 The screen is shared on the display.
 - ✎ This option supports UHD (50 Hz / 60 Hz) and FHD (50 Hz / 60 Hz) only.
 - ✎ Some devices may not support 50 Hz depending on the connected external display.
 - ✎ The screen may blink once or twice upon when connecting for the first time or when there is a change in the WMA product or source state.
 - ✎ When any device does not work, change the screen resolution for SCREEN SHARE. (☰ → SETTINGS → Picture → Screen Share (Wired) Resolution)
 - ✎ If the UHD or FHD1 output is not available for the external device due to compatibility, set Screen Share (wired) Resolution to FHD2.
 - ✎ SCREEN SHARE connecting with HDMI cables is optimized for direct connection with Samsung display product.

Connecting wirelessly

Select ☰ → EXPORT → SCREEN SHARE → Wireless on the screen and then the device to share the screen with.

- ✎ SCREEN SHARE feature works best when using FLIP in landscape orientation.
- ✎ Devices must support receiving Screen Mirroring to project the shared screen using SCREEN SHARE.

Buttons	Description
Change Device	Change devices to share the screen with.
Disconnect	Stop sharing.

Chapter 06

Menu

⋮ → SETTINGS

Connect

2nd	3rd	Description
Network		Configure your device's network.
	Network Status	View your current network and internet status.
	Open Network Settings	Configure network settings to connect to an available network.
	Reset Network	Restore the network settings to the factory default.
External Device Manager	Input Device Manager	Set up keyboards to use with your product. You can add keyboards and configure their settings. <ul style="list-style-type: none">• Bluetooth Device List• Keyboard Settings• Mouse Settings
	Device Connect Manager	Allow devices on your network, like smartphones and tablets, to share content with your product. <ul style="list-style-type: none">• Access Notification• Device List

2nd	3rd	Description
Advanced Settings	Email	<p>Set up an email account for sending emails.</p> <ul style="list-style-type: none"> • SMTP Server Name: SMTP server address • SMTP Port Number: SMTP server port • SSL/TLS: Enable or disable SSL/TLS • Sender Authentication: Choose the authentication mode to be used when sending emails <ul style="list-style-type: none"> – Personal Account / Default Account • Default Account: Default SMTP account • Password: Password for the default SMTP account • Sender Email: Sender's email address • Recipient Address: Select from options to manage email contacts after successfully send emails <ul style="list-style-type: none"> – Auto Save / Do Not Save / Delete All • Local Address Book: Import contacts from a USB device or delete them. <ul style="list-style-type: none"> – Import / Delete <p> For more information, refer to 'Importing Local Address Book contacts'.</p>

Importing Local Address Book contacts

To use FLIP **Local Address Book**, first **Import** contacts from a CSV file using a USB device.

1 Use LDAP: Set **Don't Use**.

☰ → **SETTINGS** → **Connect** → **Advanced Settings** → Enter password → **LDAP** → **Set LDAP Connection** → **Use LDAP** → **Don't Use**

2 Set up details under **Email** menu.

☰ → **SETTINGS** → **Connect** → **Advanced Settings** → Enter password → **Email**

3 Edit and save your **Local Address Book** to a USB device.

Make a list of contacts in the following structure and save it to the root directory as RecentSearchList.csv.

– RecentSearchList.csv structure (example)

emailid1@samsung.com	Name1	Level1	Team1	Company1
emailid2@samsung.com	Name2	Level2	Team2	Company2
emailid3@samsung.com	Name3	Level3	Team3	Company3

4 Connect the USB device to FLIP to import contacts.

☰ → **SETTINGS** → **Connect** → **Advanced Settings** → Enter password → **Email** → **Local Address Book** → **Import**

✎ The USB device and its contents may not be detected properly if a USB extension cable is used. (USB hubs are not supported.)

✎ Do not remove the USB device while loading.

✎ If more than two USB devices are connected, some of them may not be detected.

✎ USB devices that require higher operating power need to be connected to the USB  (1A) port on the back.

✎ The file system supports FAT, exFAT, and NTFS formats.





Using Local Address Book contacts

Automatically search and suggest from the list of contacts when selecting recipient(s) in **EXPORT** → **EMAIL**.







✎ To use this function, complete setting details under **Email** menu.

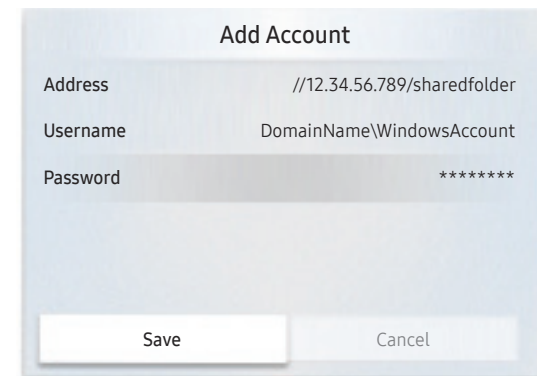

Deleting Local Address Book contacts

☰ → **SETTINGS** → **Connect** → **Advanced Settings** → Enter password → **Email** → **Local Address Book** → **Delete**

2nd	3rd	Description
Advanced Settings	Print Server	<p>Set up the Print Server to use the printing function.</p> <p> For more information, refer to 'Printing'.</p> <ul style="list-style-type: none"> • Connect to Server <ul style="list-style-type: none"> – Auto: View and select one from a list of server IP addresses of the PCs where Flip Printing Software is installed, available on the network. – Manual: Enter the Server IP address of the PC where Flip Printing Software is installed. • Server IP: Enter the Server IP address of the PC where Flip Printing Software is installed. • Server Port: Enter the Server Port address of the PC where Flip Printing Software is installed.
	Network Drive	<p>Add or edit network drive accounts. If you cannot connect to the network drive, update SAMBA of PC to the latest version.</p> <ul style="list-style-type: none"> • Add Account: Add new network drive accounts. Only Samba can be added to the network drive. <p> SAMBA 2.0 or later is supported. If you cannot connect to the network drive, update SAMBA to the latest version.</p> <p> To register a network drive account, you must enter the Address, Username, and Password.</p> <ul style="list-style-type: none"> – Address: //computer IP address/shared folder name <ul style="list-style-type: none">  When entering an address, be sure to use / instead of W and \. For example, if you share a folder named "sharedfolder" on a PC with IP address of 12.34.56.789, enter "//12.34.56.789/sharedfolder" as the address. – Username: A Windows account with permissions to the shared folder <ul style="list-style-type: none">  When entering a domain, be sure to use W or \. For example, DomainNameWWindowsAccount – Password: The password you set for your Windows account <ul style="list-style-type: none"> • Edit Account: Edit network drive accounts.



2nd	3rd	Description
Advanced Settings	LDAP	<p>Set LDAP connection or configure connected LDAP queries.</p> <ul style="list-style-type: none"> • Set LDAP Connection Configure a new LDAP connection. <ul style="list-style-type: none"> – Use LDAP: Whether or not to use LDAP – Import Setup Value: Can fetch the following settings from LDAPConnectionConfig.txt stored on the USB(Password excluded) <ul style="list-style-type: none">  For more information, refer to 'How to create a text file for use of LDAP'. – Authentication Type: Kerberos, Anonymous or Basic whichever is supported by the LDAP server – User ID: DN(Distinguished Name) of the User ID that is used in the LDAP server <ul style="list-style-type: none">  The format of User ID complies with the DN format of LDAP. e.g. cn=admin, dc=myldap, dc=com – Password: Password that is used for authentication of the LDAP server – Server Address: IP or URL of the LDAP server – Server Port Number: Port number of the LDAP server – Base DN: Base DN that is to be used for search in the DIT(Directory Information Tree) when connecting the LDAP – SSL/TLS: Whether or not to use SSL/TLS <ul style="list-style-type: none">  When SSL/TLS is set to be Use, the encrypted data communication is enabled. – Use Untrusted Certificates: Whether or not to allow untrusted certificates  The following menu is activated when setting the Authentication Type to Kerberos. <ul style="list-style-type: none">  Kerberos Realm: Kerberos realm data  KDC Host: KDC Host URL  KDC Port: KDC Host port number

2nd	3rd	Description
Advanced Settings	LDAP	<ul style="list-style-type: none"> • LDAP Query Configuration Set the query for the connected LDAP. <ul style="list-style-type: none"> – UID: Change the user UID that is used in LDAP. – Email: Change the Email that is used in LDAP. – Name: Change the user name (common name) that is used in LDAP. – Last Name: Change the surname of the user that is used in LDAP. – Position: Change the title that is used in LDAP. – Company name: Change the company name that is used in LDAP. – Department: Change the department name that is used in LDAP. – Use Custom Query: Fetches the user defined query from LDAPQuery.txt (case sensitive) stored on the USB. <ul style="list-style-type: none">  For more information, refer to 'How to create a text file for use of LDAP'.  When the mapping does not match, the search result does not include the attributes.
	Server Network Settings	Set up your server network connection and related functions. <ul style="list-style-type: none"> • Connect to server : Connect to MagicInfo server. • Server Access : Allow or deny access to MagicInfo server. • Proxy Server : Set up your proxy server connection and related functions.
	Certificate Manager	Manage the certificate files for this device. <ul style="list-style-type: none"> • App Certificate: View and manage the app certificates installed on this device. Connect a USB flash drive that contains certificates to install them on this device. • Wi-Fi Certificate: Manage the certificates installed on this device. Connect a USB flash drive to install certificates or delete any installed certificates.

How to create a text file for use of LDAP

The LDAP configuration basically consists of many long sentences.

During LDAP configuration, FLIP can be fetched using the text file to prevent typos and make a batch setting.

 Input of file name and content should be case sensitive for correct operation.

- Format of LDAPConnectionConfig.txt

(1) Example of the text file

```
User ID=cn=Manager, dc=example, dc=com
Server Address=123.456.789.012
Server Port Number=12345
Base DN=dc=samsung, dc=example, dc=com
SSL/TLS=Don't Use
Use Untrusted Certificates=Don't Use
Authentication Type=Basic
Kerberos Realm=MYLDAP.COM
KDC Host=krb1.myldap.com
KDC Port=88
```

(2) Allocation of values (VAL) for each key

User ID: Enter the User ID.

Server Address: Enter the IP or URL of the LDAP server.

Server Port Number: Enter the Port of the LDAP server.

SSL/TLS: Enter Use or Don't Use.

Use Untrusted Certificates: Enter Use or Don't Use.

Authentication Type: Enter Basic or Anonymous.

– The following three items will be added if you select Kerberos type verification.

Kerberos Realm: Fill in the Kerberos field (Example: MYLDAP.LDAP)

KDC Host: Enter the KDC Host URL (Example: krb1.myldap.com)

KDC Port: Enter the KDC Host Port (Example: 88)

 If you select to use Kerberos type verification, use the original Kerberos User ID for a User ID instead of User ID in DN(Distinguished Name) format. (Example: Mirko)

- Format of LDAPQuery.txt

- (1) Example of the text file

- UID=uid

- Email=mail

- Name=cn

- Last Name=sn

- Position=title

- Company Name=o

- Department=departmentNumber

- Query=((mail=*<A>*)(cn=*<A>*))

- (2) Allocation of values (VAL) for each key

- 1) Mapping part (all rows except the last)

- Includes all rows except the last, in the order of **UID, Email, Name, Last Name, Position, Company name, and Department.**

- Values are mapped in the following manner.

- On the left of "=" syntax is the name that is seen in the **LDAP Query Configuration** menu (also on the left) and mapped to the values on the right side of "=" (the actual LDAP Server attributes).

- You can choose attributes to change values. For instance, you can change the right-side values without changing the left-side values.

- 2) Query part



- <A> is the Keyword that is used for a Search.

- The syntax for the Use Custom Query complies with the LDAP Query rule excluding <A>.



- For example, when <A> is included in the mail or cn attribute, you can create it as follows.



- Query=((mail=*<A>*)(cn=*<A>*))

System

2nd	3rd	Description
Language		Change your Language settings.
Rolls	Auto Save	Automatically save all data.
	Delete All	Delete all data from the device, including locked data.
	Period for Delete All	Set a regular reset interval at which all data on the internal storage will be deleted.
Time		Configure various time-related settings.
	Clock Set	Set current date and time.
	DST	Adjust clock for Daylight Saving Time.  Start Date , End Date and Time Offset are enabled only when DST is set to On .
Change PIN		Change your 6-digit Personal Identification Number (PIN).  The default PIN number is 000000.  Change the PIN to keep your device secure.
Device Name		Enter Device Name. You can find this name on the device being used over the network.
Tap to turn on		Turn Tap to Turn On on or off. Enables you to turn on the screen with just a tap.

2nd	3rd	Description
Sound Output		Select speakers for sound output. <ul style="list-style-type: none">• Flip Speaker / Audio Out / Screen Share (Wired)
Sound Feedback		Select the volume of the sound feedback for certain options (capture, merge to roll, etc.) <ul style="list-style-type: none">• Off / Low / Medium / High

2nd	3rd	Description
Advanced Settings		<p>Configure advanced settings which includes USB Lock and Network Lock.</p> <p>Enter your 6 digit PIN number. The default PIN number is "000000".</p> <ul style="list-style-type: none">  If you want to change the PIN number, use the Change PIN function.  Change the PIN to keep your device secure.
	Screen Saver	Set up the screensaver. The selected image can be used as a custom screensaver.
	Touch Control Lock	<p>Run Touch Control Lock.</p> <ul style="list-style-type: none">  Tap and hold the screen to release Touch Control Lock.
	USB Lock	<p>Set up a USB Lock. After setting up, the device will be restarted to apply the settings.</p> <ul style="list-style-type: none"> • Off / Read-only / All On
	Network Lock	Set up a Network Lock .
	Screen Monitoring Lock	Block screen images from being monitored by MagicINFO Server.
	Auto Power Off	Choose how long the display will stay on before turning off after no user interaction is detected.
	PC module power	<p>Turns on or off to sync with OPS Power when the power is on or off.</p> <ul style="list-style-type: none"> • Synced power-on: When the Flip is turned on, the PC module is automatically turned on as well. • Synced power-off: When the Flip is turned off, the PC module is automatically turned off as well.
	No Signal/No Interaction Power Off	Save power by turning the device off when no signals/touch interactions are received from any source.
	Remote Power Control	Turn Remote Power Control on or off. By activating this feature, the network connection is maintained when the product is turned off.
	Remote Management Settings	<p>Set to connect and control the Flip remotely from other devices.</p> <ul style="list-style-type: none"> • Remote Management: Restrict access to the product from other devices via the network. • Device ID: Set a unique ID number. • PC Connection Cable: Select the type of cable used to connect the product to a PC. • Secure Protocol: Secure the protocol between the product and other devices.





2nd	3rd	Description
Advanced Settings	PIP Capture	Turn PIP Capture on or off.  HDCP contents will not show on the screen if PIP Capture is set to On .
	Power on Source Setting	Set the default source when turning on the power. By setting this, either Roll or Source is turned on at power on.
	Auto Source Switching	Set Auto Source Switching . By activating this feature, newly connected sources are displayed automatically.
	PIP Screen Default Size	Set the default size for the PIP screen. <ul style="list-style-type: none"> • Full Screen / Partial Screen
	Edit Samsung Workspace	You can add your favourite URLs in Samsung Workspace.
	Clone Product	Export this device's settings or import from other devices.
	URL Launcher Settings	Set the URL Launcher. <ul style="list-style-type: none"> • Install Web Apps: Install the web application by entering an address. • Install from USB Device: Install the web application from the USB storage device. • Uninstall: Remove the installed web application. • Timeout Setting: Set the timeout period for connecting to the URL. • Developer Mode: Select to set developer mode.
	Self Diagnosis	Run self diagnosis on the email, LDAP, or print server.  You can export a detailed self-diagnosis report including information about emails, LDAP, print servers, and other information to a USB storage device connected to the product.
Start Setup	Go through the initial setup steps like you did the first time you used this product.	

Picture

2nd	3rd	Description																																		
Backlight		Adjust backlight brightness to your preference. 100 is the brightest setting.																																		
Colour Temperature		It sets colour temperature. The value and temperature increase simultaneously, so the ratio of blue colour rises. (Range: 2800K - 16000K)																																		
White Balance	R-Gain / G-Gain / B-Gain / R-Offset / G-Offset / B-Offset / Reset	Adjust the colour temperature of the picture so that white objects appear brighter.																																		
Input Signal Plus		<p>Expands the input signal range for HDMI connections.</p> <p> Supports resolutions up to 3840 x 2160 @ 60 Hz with Input Signal Plus expansion set to On. Supports resolutions up to 3840 x 2160 @ 30 Hz with Input Signal Plus expansion set to Off.</p> <h3><u>Supported Resolutions for UHD Input Signals</u></h3> <p>Check the supported resolution for UHD input signals.</p> <ul style="list-style-type: none"> Resolution: 3840 x 2160p, 4096 x 2160p <p>If Input Signal Plus is set to Off</p> <table border="1"> <thead> <tr> <th>Frame rate (fps)</th> <th>Colour Depth / Chroma Sampling</th> <th>RGB 4:4:4</th> <th>YCbCr 4:4:4</th> <th>YCbCr 4:2:2</th> <th>YCbCr 4:2:0</th> </tr> </thead> <tbody> <tr> <td>50 / 60</td> <td>8 bit</td> <td>-</td> <td>-</td> <td>-</td> <td>0</td> </tr> </tbody> </table> <p>If Input Signal Plus is set to On</p> <table border="1"> <thead> <tr> <th>Frame rate (fps)</th> <th>Colour Depth / Chroma Sampling</th> <th>RGB 4:4:4</th> <th>YCbCr 4:4:4</th> <th>YCbCr 4:2:2</th> <th>YCbCr 4:2:0</th> </tr> </thead> <tbody> <tr> <td rowspan="3">50 / 60</td> <td>8 bit</td> <td>0</td> <td>0</td> <td>0</td> <td>0</td> </tr> <tr> <td>10 bit</td> <td>-</td> <td>-</td> <td>0</td> <td>0</td> </tr> <tr> <td>12 bit</td> <td>-</td> <td>-</td> <td>0</td> <td>0</td> </tr> </tbody> </table>	Frame rate (fps)	Colour Depth / Chroma Sampling	RGB 4:4:4	YCbCr 4:4:4	YCbCr 4:2:2	YCbCr 4:2:0	50 / 60	8 bit	-	-	-	0	Frame rate (fps)	Colour Depth / Chroma Sampling	RGB 4:4:4	YCbCr 4:4:4	YCbCr 4:2:2	YCbCr 4:2:0	50 / 60	8 bit	0	0	0	0	10 bit	-	-	0	0	12 bit	-	-	0	0
Frame rate (fps)	Colour Depth / Chroma Sampling	RGB 4:4:4	YCbCr 4:4:4	YCbCr 4:2:2	YCbCr 4:2:0																															
50 / 60	8 bit	-	-	-	0																															
Frame rate (fps)	Colour Depth / Chroma Sampling	RGB 4:4:4	YCbCr 4:4:4	YCbCr 4:2:2	YCbCr 4:2:0																															
50 / 60	8 bit	0	0	0	0																															
	10 bit	-	-	0	0																															
	12 bit	-	-	0	0																															

2nd	3rd	Description
HDMI Black Level		Adjust the black level to optimise the HDMI picture brightness and contrast.  This function is available only when the product is connected to a PC using an HDMI cable and the Source window is turned on.
Screen Share (Wired) Resolution		Set the resolution when sharing the screen (wired). <ul style="list-style-type: none"> • Auto / UHD / FHD1 / FHD2
Reset Picture		Restore all picture settings to the factory default.

Support

2nd	3rd	Description
Software Update		Update the software installed on your product.
	Update now	<p>Update software by downloading update files.</p> <ul style="list-style-type: none">– Online update  Requires an internet connection.– Update with a USB device After downloading the update file from the Samsung website and storing it on a USB device, connect the USB device to the product to update.  Make sure you saved the update file in a top-level folder. <ul style="list-style-type: none">• Current Version: This is the software version already installed in the product.
	Auto update	<p>Automatically start software updates once your device is powered off.</p>  Requires an internet connection.
Contact Samsung		<p>Contact information for assistance with your device.</p>  Go to Contact Samsung and find the product Model Code and Software Version .
Reset All		It initialises all items in the total menu.

Chapter 07

Troubleshooting Guide









Problems and Solutions

 Test your product as follows before calling Samsung Customer Service Centre. If the problem persists, contact Samsung Customer Service Centre.

Source window (HDMI) issue	
Blank spaces are found on all four sides of the screen when an HDMI cable is connected to the product and PC.	The blank spaces found on the screen have nothing to do with the product.
	Blank spaces on the screen are caused by the PC or graphics card. To resolve the problem, adjust the screen size in the HDMI settings for the graphics card.
	If the graphics card settings menu does not have an option to adjust the screen size, update the graphics card driver to the latest version. (Please contact the graphics card or computer manufacturer for further details about how to adjust the screen settings.)
The images on the screen look distorted.	Check the connected cable. Compatibility is not guaranteed if you use a cable that has not been supplied by Samsung.
The screen is not clear. The screen is blurry.	Set the resolution and frequency to the recommended level.
The screen appears unstable and shaky.	Check that the resolution and frequency of the PC and graphics card are set within a range compatible with the product. Then, change the screen settings if required by referring to 'Preset Timing Modes'.
There are shadows or ghost images left on the screen.	

Source window (HDMI) issue	
White does not really look white.	Go to Picture and adjust the White Balance settings.
The product will turn off automatically.	Make sure the power cable is connected properly to the product and power outlet.
The screen display does not look normal.	Encoded video content may cause the display to appear corrupted in scenes featuring fast moving objects such as in a sports event or action video.
	Low signal level or low picture quality may cause the display to appear corrupted. This does not mean the product is defective.
	A mobile device within a distance of one-meter radius may cause static on analogue and digital products.
The brightness and colour do not look normal.	From the menu, select ⋮ → SETTINGS → Support → Reset All to try resetting the screen.
The display looks unstable and then freezes.	The screen may freeze when a resolution other than the recommended resolution is used or if the signal is not stable. To resolve the issue, change the PC resolution to the recommended resolution.
The screen cannot be displayed in full screen.	If the source window is set to full screen mode while in portrait orientation, a black bar appears at both the top and bottom. Change to landscape orientation, and then switch the Source window to full screen mode.

Sound issue	
There is no sound.	Check the volume.
The volume is too low.	Adjust the volume.
	If the volume is still low after turning it up to the maximum level, adjust the volume on your PC sound card or software programme.
Video is available but there is no sound.	If an HDMI cable or a DP cable is connected, check the audio output settings on the PC.
	If a source device is used <ul style="list-style-type: none"> • Check the audio output settings for the source device. (For example, if your monitor is connected to HDMI, you may need to change the audio option of your video output device to HDMI.)
	Reconnect the power cable to the device and then reboot the device.
There is static coming from the speakers.	Low signal level can cause corrupted sound.
There is audible sound when the volume is muted.	Audio settings for main speakers are separate from the internal speakers on the product. Changing or muting the volume on the product does not affect an external amplifier(decoder).

Touch function issues	
The icons can be touched but the drawings cannot.	Use the provided product-specific pen.
Touching does not work when HDMI connection is used.	<p>Check whether the TOUCH  port on the product is connected to a USB port on the PC using the supplied USB cable.</p> <ul style="list-style-type: none">  HDMI  1 or DP  → TOUCH  on the rear of the product  HDMI  2 → TOUCH  on the tray
I use two pens, but they do not work well.	Make sure that there is enough space between the two pens at multi-touching.
There is a screen touch malfunction such as slow or inaccurate responding.	Make sure that there are no foreign substances on the screen surface.
	Check whether the screen is broken.
	Make sure that the product is not exposed to direct sunlight.
	When the product is turned on after turning off, do not tap the screen because touch calibration is performed for 5 seconds.

Other issue	
The product smells like plastic.	The plastic smell is normal and disappears over time.
Small particles are found on the edges of the product.	The particles are part of the product design. The product is not defective.
When I try to change the PC resolution, a message " The defined resolution is not currently supported. " appears.	The message " The defined resolution is not currently supported. " appears if the input source resolution exceeds the maximum resolution of the product. To resolve the issue, change the PC resolution to a resolution supported on the product.
There is no sound from the speakers in HDMI mode when a DVI-HDMI cable is connected.	DVI cables do not transmit sound data.
HDMI Black Level is not functioning properly on an HDMI device with YCbCr output.	This function works only when the HDMI signal of the external device is RGB output.
There is no sound in HDMI mode.	Displayed picture colours may not look normal. Video or sound may not be available. This can occur if a source device that only supports an older version of the HDMI standard is connected to the product.

Chapter 08

Specifications

General

Horizontal Frequency

The time required to scan a single line from the left to the right side of the screen is called a horizontal cycle. The reciprocal number of a horizontal cycle is called horizontal frequency. Horizontal frequency is measured in kHz.

Vertical Frequency

The product displays a single image multiple times per second (like a fluorescent light) to display what the viewer sees. The rate of a single image being displayed repeatedly per second is called vertical frequency or refresh rate. Vertical frequency is measured in Hz.

Model Name		WM75A	WM85A
Panel	Size	189.3 cm	214.7 cm
	Display area	1650.24 mm (H) x 928.26 mm (V)	1872.0 mm (H) x 1053.0 mm (V)
Synchronization (Panel Spec)	Horizontal Frequency	30 - 81 kHz	
	Vertical Frequency	48 - 75 Hz	
Resolution	Optimum resolution	3840 x 2160	
	Maximum resolution		
Power Supply		AC100-240V~ 50/60Hz Refer to the label at the back of the product as the standard voltage can vary in different countries.	
Environmental considerations	Operating	Temperature : 0 °C – 40 °C (32 °F – 104 °F) * For installing the enclosure, keep the internal temperature at 40 °C or below. Humidity : 10% – 80%, non-condensing	
	Storage	Temperature : -20 °C – 45 °C (-4 °F – 113 °F) Humidity : 5% – 95%, non-condensing * Applicable before the product package is unpacked.	

-
- ✎ Due to the nature of the manufacturing of this product, approximately 1 pixel per million (1ppm) may appear brighter or darker on the panel. This does not affect product performance.
 - ✎ This product can be set to only one resolution for each screen size to obtain the optimum picture quality due to the nature of the panel. Using a resolution other than the specified resolution may degrade the picture quality. To avoid this, it is recommended that you select the optimum resolution specified for your product.
 - ✎ For detailed device specifications, visit the Samsung website.

Preset Timing Modes

The screen will automatically be adjusted if a signal that belongs to the following standard signal modes is transmitted from your PC. If the signals transmitted from the PC differ from the standard mode, the screen may not be displayed. In such a case, change the settings as shown in the following table by referring to the graphics card user manual.

Resolution	Horizontal Frequency (kHz)	Vertical Frequency (Hz)	Pixel Clock (MHz)	Sync Polarity (H/V)	Port	
					HDMI IN	DisplayPort
IBM, 720 x 400	31.469	70.087	28.322	-/+	0	0
MAC, 640 x 480	35.000	66.667	30.240	-/-	0	0
MAC, 832 x 624	49.726	74.551	57.284	-/-	0	0
MAC, 1152 x 870	68.681	75.062	100.000	-/-	0	0
VESA CVT, 3840 x 2160RB	110.500	49.977	442.000	+/-	-	0
VESA CVT, 3840 x 2160RB	133.313	59.997	533.250	+/-	-	0
VESA DMT, 640 x 480	31.469	59.940	25.175	-/-	0	0
VESA DMT, 640 x 480	37.861	72.809	31.500	-/-	0	0
VESA DMT, 640 x 480	37.500	75.000	31.500	-/-	0	0
VESA DMT, 800 x 600	37.879	60.317	40.000	+/+	0	0
VESA DMT, 800 x 600	48.077	72.188	50.000	+/+	0	0
VESA DMT, 800 x 600	46.875	75.000	49.500	+/+	0	0
VESA DMT, 1024 x 768	48.363	60.004	65.000	-/-	0	0
VESA DMT, 1024 x 768	56.476	70.069	75.000	-/-	0	0
VESA DMT, 1024 x 768	60.023	75.029	78.750	+/+	0	0
VESA DMT, 1152 x 864	67.500	75.000	108.000	+/+	0	0
VESA DMT, 1280 x 720	45.000	60.000	74.250	+/+	0	0
VESA DMT, 1280 x 800	49.702	59.810	83.500	-/+	0	0
VESA DMT, 1280 x 1024	63.981	60.020	108.000	+/+	0	0
VESA DMT, 1280 x 1024	79.976	75.025	135.000	+/+	0	0
VESA DMT, 1366 x 768	47.712	59.790	85.500	+/+	0	0

Resolution	Horizontal Frequency (kHz)	Vertical Frequency (Hz)	Pixel Clock (MHz)	Sync Polarity (H/V)	Port	
					HDMI IN	DisplayPort
VESA DMT, 1440 x 900	55.935	59.887	106.500	-/+	0	0
VESA DMT, 1600 x 900RB	60.000	60.000	108.000	+/+	0	0
VESA DMT, 1680 x 1050	65.290	59.954	146.250	-/+	0	0
VESA DMT, 1920 x 1080	67.500	60.000	148.500	+/+	0	0
VESA DMT, 2560 x 1440RB	88.787	59.951	241.500	+/-	0	0
CEA-861, 720(1440) x 576i	15.625	50.000	27.000	-/-	0	-
CEA-861, 720(1440) x 480i	15.734	59.940	27.000	-/-	0	-
CEA-861, 720 x 576	31.250	50.000	27.000	-/-	0	0
CEA-861, 720 x 480	31.469	59.940	27.000	-/-	0	0
CEA-861, 1280 x 720	37.500	50.000	74.250	+/+	0	0
CEA-861, 1280 x 720	45.000	60.000	74.250	+/+	0	0
CEA-861, 1920 x 1080i	28.125	50.000	74.250	+/+	0	-
CEA-861, 1920 x 1080i	33.750	60.000	74.250	+/+	0	-
CEA-861, 1920 x 1080	27.000	24.000	74.250	+/+	0	-
CEA-861, 1920 x 1080	28.125	25.000	74.250	+/+	0	-
CEA-861, 1920 x 1080	33.750	30.000	74.250	+/+	0	-
CEA-861, 1920 x 1080	56.250	50.000	148.500	+/+	0	0
CEA-861, 1920 x 1080	67.500	60.000	148.500	+/+	0	0
CEA-861, 3840 x 2160	54.000	24.000	297.000	+/+	0	-
CEA-861, 3840 x 2160	56.250	25.000	297.000	+/+	0	-
CEA-861, 3840 x 2160	67.500	30.000	297.000	+/+	0	0
CEA-861, 3840 x 2160	112.500	50.000	594.000	+/+	0	0
CEA-861, 3840 x 2160	135.000	60.000	594.000	+/+	0	0
CEA-861, 4096 x 2160	54.000	24.000	297.000	+/+	0	-
CEA-861, 4096 x 2160	67.500	30.000	297.000	+/+	0	-
CEA-861, 4096 x 2160	112.500	50.000	594.000	+/+	0	-
CEA-861, 4096 x 2160	135.000	60.000	594.000	+/+	0	-

Chapter 09

Appendix

Responsibility for the Pay Service (Cost to Customers)

 When the service is requested, in spite of in warranty, we may charge you for a visit from a service technician in the following cases.

Not a product defect

Cleaning of the product, Adjustment, Explanation, Re-installation and etc.

- If a service technician is requested to give instructions on how to use product or simply adjusts options without disassembling product.
- If a defect is caused by external environmental factors (Internet, Antenna, Wired Signal, etc.)
- If a product is reinstalled or devices are connected additionally after installing the purchased product for the first time.
- If a product is reinstalled to move to a different spot or to move to a different house.
- If the customer requests instructions on how to use another company's product.
- If customer requests instructions on how to use the network or another company's programme.
- If customer requests software installation and setup for the product.
- If a service technician removes/cleans dusts or foreign materials inside of the product.
- If customer requests an installation additionally after purchasing a product through home-shopping or online.

A Product damage caused by customer's fault

Product damage caused by customer's mishandling or wrong repair

If a product damage is caused by;

- External impact or drop.
- Use of supplies or separately sold product unspecified by Samsung.
- Repair from a person besides an engineer of outsourcing service company or partner of Samsung Electronics Co., Ltd.
- Remodeling or repairing the product by customer.
- Using it with incorrect voltage or non-authorized electrical connections.
- Not following the "cautions" in User Manual.

Others

- If product fails by natural disaster. (lightning, fire, earthquake, flood damage, etc)
 - If consumable components are all used up. (Battery, Toner, Fluorescent lights, Head, Vibrator, Lamp, Filter, Ribbon, etc.)
-  If customer requests a service in case the product has no defect, service fee may be charged. So please read User Manual first.

Prevention of Afterimage Burn-in

What is afterimage burn-in?

Afterimage burn-in should not occur when the panel is operating normally. Normal operation refers to a continuously changing video pattern. If the panel displays a fixed pattern for an extended period of time a slight voltage difference may occur between the electrodes in pixels that control the liquid crystals.

Such a voltage difference between electrodes increases with time and makes the liquid crystals thinner. When this occurs, a previous image can remain on the screen when the pattern changes.

-  This information is a guide to prevent afterimage burn-in. Viewing a fixed screen for an extended period of time may cause afterimage burn-in. This problem is not included in warranty.

Recommended prevention practices

Viewing a fixed screen for an extended period of time may cause afterimage burn-ins or smudges. Turn off the product when it is not used for a long time, activate the Power Saving mode, or run a moving screen saver.

Licence



The terms HDMI and HDMI High-Definition Multimedia Interface, and the HDMI Logo are trademarks or registered trademarks of HDMI Licensing Administrator, Inc. in the United States and other countries.

Open Source Licence Notice

In the case of using open source software, Open Source Licences are available on the product menu. For information on the Open Source Licence Notice, contact Samsung Open Source (<http://opensource.samsung.com>)
