

DLP® Projector

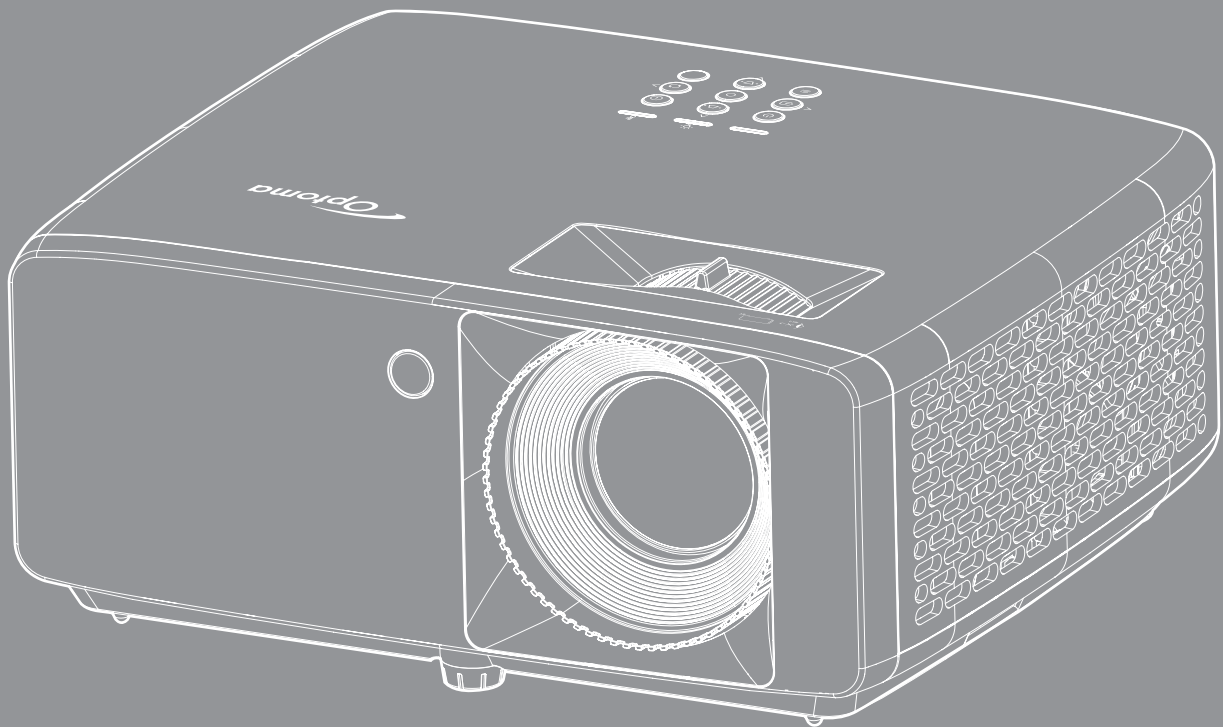
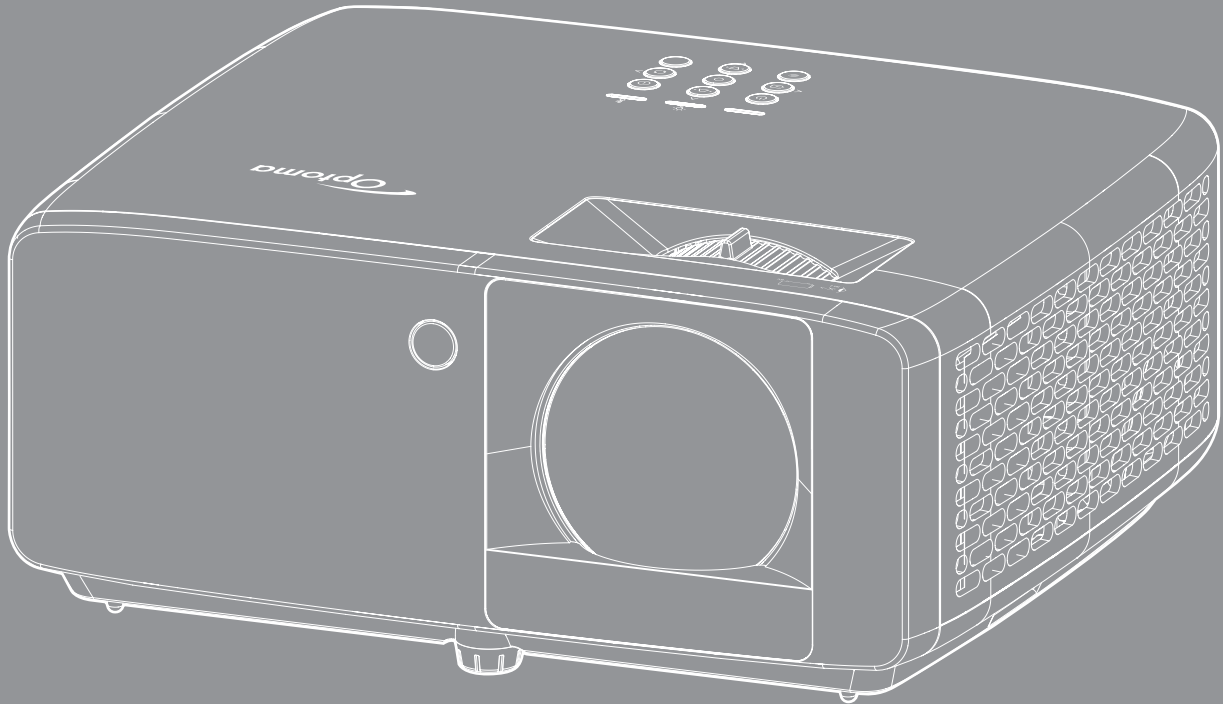

TABLE OF CONTENTS

SAFETY	4
<i>Important Safety Instruction</i>	4
<i>Laser Radiation Safety Information</i>	5
<i>Copyright</i>	7
<i>Disclaimer</i>	7
<i>Trademark Recognition</i>	7
<i>FCC</i>	7
<i>Declaration of Conformity for EU countries</i>	8
<i>WEEE</i>	8
<i>Cleaning the Lens</i>	8
INTRODUCTION	9
<i>Package Overview</i>	9
<i>Standard accessories</i>	9
<i>Product Overview</i>	10
<i>Connections</i>	11
<i>Keypad</i>	12
<i>Remote control</i>	13
SETUP AND INSTALLATION	14
<i>Installing the projector</i>	14
<i>Connecting sources to the projector</i>	16
<i>Adjusting the projector image</i>	17
<i>Remote setup</i>	19
USING THE PROJECTOR	21
<i>Powering on / off the projector</i>	21
<i>Selecting an input source</i>	22
<i>Menu navigation and features</i>	23
<i>OSD Menu tree</i>	24
<i>Image picture mode menu</i>	30
<i>Image dynamic range menu</i>	30
<i>Image brightness menu</i>	30
<i>Image contrast menu</i>	31
<i>Image sharpness menu</i>	31
<i>Image gamma menu</i>	31
<i>Image color settings menu</i>	31
<i>Image wall color menu</i>	31
<i>Image 3D menu</i>	32
<i>Image reset menu</i>	32
<i>Display projection orientation menu</i>	33
<i>Display light source mode menu</i>	33
<i>Display dynamic black menu</i>	33

<i>Display gaming mode menu</i>	33
<i>Display screen type menu</i>	33
<i>Display aspect ratio menu</i>	34
<i>Display geometric correction menu</i>	37
<i>Display digital zoom menu</i>	37
<i>Display image shift menu</i>	37
<i>Display reset menu</i>	37
<i>Setup test pattern menu</i>	38
<i>Setup language menu</i>	38
<i>Setup menu settings menu</i>	38
<i>Setup high altitude menu</i>	38
<i>Setup filter settings menu</i>	38
<i>Setup power settings menu</i>	39
<i>Setup security menu</i>	39
<i>Setup keypad settings menu</i>	39
<i>Setup startup logo menu</i>	40
<i>Setup background color menu</i>	40
<i>Setup reset menu</i>	40
<i>Input auto source menu</i>	41
<i>Input auto input switch menu</i>	41
<i>Input HDMI CEC settings menu</i>	41
<i>Input reset menu</i>	41
<i>Audio volume menu</i>	42
<i>Audio mute menu</i>	42
<i>Audio reset menu</i>	42
<i>Control device ID menu</i>	43
<i>Control remote settings menu</i>	43
<i>Control keypad settings menu</i>	43
<i>Control LAN menu</i>	43
<i>Control control menu</i>	45
<i>Setup network control settings menu</i>	46
<i>Control reset menu</i>	53
<i>Information menu</i>	54

ADDITIONAL INFORMATION..... 55

<i>Compatible resolutions</i>	55
<i>Image size and projection distance</i>	59
<i>Projector dimensions and ceiling mount installation</i>	61
<i>IR remote control codes</i>	63
<i>Troubleshooting</i>	65
<i>Warning indicators</i>	67
<i>Specifications</i>	68
<i>Optoma global offices</i>	69

SAFETY

	The lightning flash with arrow head within an equilateral triangle is intended to alert the user to the presence of uninsulated "dangerous voltage" within the product's enclosure that may be of sufficient magnitude to constitute a risk of electric shock to persons.
	The exclamation point within an equilateral triangle is intended to alert the user to the presence of important operating and maintenance (servicing) instructions in the literature accompanying the appliance.

Please follow all warnings, precautions and maintenance as recommended in this user's guide.

Important Safety Instruction

- Do not block any ventilation openings. To ensure reliable operation of the projector and to protect from over heating, it is recommended to install the projector in a location that does not block ventilation. As an example, do not place the projector on a crowded coffee table, sofa, bed, etc. Do not put the projector in an enclosure such as a book case or a cabinet that restricts air flow.
- To reduce the risk of fire and/or electric shock, do not expose the projector to rain or moisture. Do not install near heat sources such as radiators, heaters, stoves or any other apparatus such as amplifiers that emits heat.
- Do not let objects or liquids enter the projector. They may touch dangerous voltage points and short out parts that could result in fire or electric shock.
- Do not use under the following conditions:
 - In extremely hot, cold or humid environments.
 - (i) Ensure that the ambient room temperature is within 0°C ~ 40°C
 - (ii) Relative humidity is up to 80%
 - In areas susceptible to excessive dust and dirt.
 - Near any appliance generating a strong magnetic field.
 - In direct sunlight.
- Do not use the unit if it has been physically damaged or abused. Physical damage/abuse would be (but not limited to):
 - Unit has been dropped.
 - Power supply cord or plug has been damaged.
 - Liquid has been spilled on to the projector.
 - Projector has been exposed to rain or moisture.
 - Something has fallen in the projector or something is loose inside.
- Do not place the projector on an unstable surface. The projector may fall over resulting in injury or the projector may become damaged.
- Do not block the light coming out of the projector lens when in operation. The light will heat the object and may melt, cause burns or start a fire.
- Please do not open or disassemble the projector as this may cause electric shock.
- Do not attempt to service the unit yourself. Opening or removing covers may expose you to dangerous voltages or other hazards. Please call Optoma before you send the unit for repair.
- See projector enclosure for safety related markings.
- The unit should only be repaired by authorized service personnel.
- Only use attachments/accessories specified by the manufacturer.
- Do not look into straight into the projector lens during operation. The bright light may harm your eyes.
- This projector will detect the life of the light source itself.

- When switching the projector off, please ensure the cooling cycle has been completed before disconnecting power. Allow 90 seconds for the projector to cool down.
- Turn off and unplug the power plug from the AC outlet before cleaning the product.
- Use a soft dry cloth with mild detergent to clean the display housing. Do not use abrasive cleaners, waxes or solvents to clean the unit.
- Disconnect the power plug from AC outlet if the product is not being used for a long period of time.
- Do not setup the projector in places where it might be subjected to vibration or shock.
- Do not touch the lens with bare hands.
- Remove battery/batteries from remote control before storage. If the battery/batteries are left in the remote for long periods, they may leak.
- Replacement of a battery with an incorrect type that can defeat a safeguard.
- Disposal of a battery into fire or a hot oven, or mechanically crushing or cutting a battery, that can result in an explosion.
- Leaving a battery in an extremely high temperature surrounding environment that can result in an explosion or the leakage of flammable liquid or gas; and a battery subjected to extremely lower air pressure that may result in an explosion or the leakage of flammable liquid or gas.
- CAUTION: Risk of fire or explosion of the battery is replaced by an incorrect type.
- Do not use or store the projector in places where smoke from oil or cigarettes may be present, as it can adversely affect the quality of the projector performance.
- Please follow the correct projector orientation installation as non standard installation may affect the projector performance.
- Use a power strip and or surge protector. As power outages and brown-outs can KILL devices.

Laser Radiation Safety Information

- This product is classified as consumer laser product and complies with IEC 60825-1: 2014, EN 60825-1: 2014/A11: 2021 and EN 50689:2021, and also complies with 21 CFR 1040.10 and 1040.11 as a Risk Group 2, LIP (Laser Illuminated Projector) as defined in IEC 62471-5:Ed. 1.0. For more information see Laser Notice No. 57, dated May 8, 2019.

IEC 60825-1:2014, EN 60825-1:2014+A11:2021, EN 50689:2021 CLASS 1 CONSUMER LASER PRODUCT RISK GROUP 2, Complies with 21 CFR 1040.10 and 1040.11 except for conformance as a Risk Group 2 LIP as defined in IEC 62471-5:Ed.1.0. For more information see Laser Notice No. 57, dated May 8, 2019.
 IEC 60825-1:2014 等級1雷射產品RG2危險等級
 IEC 60825-1:2014 1类激光产品RG2危险等级

“WARNING: MOUNT ABOVE THE HEADS OF CHILDREN.”
 Additional warning against eye exposure for close exposures less than 1 m.
 “AVERTISSEMENT : INSTALLER AU-DESSUS DE LA TÊTE DES ENFANTS.”
 Avertissement supplémentaire contre l'exposition oculaire pour des expositions à une distance de moins de 1 m.
 「警告: 安裝在高於兒童頭部處」 針對1m以下近距離眼睛接觸的額外警告
 “警告: 安裝在高於孩童頭頂處” 關於小於1m近距離眼睛暴露的附加警告



- As with any bright source, do not stare into the direct beam, RG2 IEC 62471-5:2015.
- This projector is class 1 consumer laser product of IEC/EN 60825-1:2014/A11: 2021 and risk group 2 with the requirements of IEC 62471-5:2015.
- Supervise children: no staring, and avoid use of optical aids!
- Notice is given to supervise children and to never allow them to stare into the projector beam at any distance from the projector.
- Notice is given to use caution when using the remote control for starting the projector while in front of the projection lens.

- Notice is given to the user to avoid the use of optical aids such as binoculars or telescopes inside the beam.
- When turning on the projector, make sure no one within projection range is looking at the lens.
- Keep any items (magnifying glass etc.) out of the light path of the projector. The light path being projected from the lens is extensive, therefore any kind of abnormal objects that can redirect light coming out of the lens, can cause an unpredictable outcome such as a fire or injury to the eyes.
- Any operation or adjustment not specifically instructed by the user's guide creates the risk of hazardous laser radiation exposure.
- Do not open or disassemble the projector as this may cause damage by the exposure of laser radiation.
- Do not stare into beam when the projector is on. The bright light may result in permanent eye damage.

Not following the control, adjustment or operation procedure may cause damage by the the exposure of laser radiation.

Copyright

This publication, including all photographs, illustrations and software, is protected under international copyright laws, with all rights reserved. Neither this manual, nor any of the material contained herein, may be reproduced without written consent of the author.

© Copyright 2023

Disclaimer

The information in this document is subject to change without notice. The manufacturer makes no representations or warranties with respect to the contents hereof and specifically disclaims any implied warranties of merchantability or fitness for any particular purpose. The manufacturer reserves the right to revise this publication and to make changes from time to time in the content hereof without obligation of the manufacturer to notify any person of such revision or changes.

Trademark Recognition

Kensington is a U.S. registered trademark of ACCO Brand Corporation with issued registrations and pending applications in other countries throughout the world.

HDMI, the HDMI Logo, and High-Definition Multimedia Interface are trademarks or registered trademarks of HDMI Licensing LLC in the United States and other countries.

DLP®, DLP Link and the DLP logo are registered trademarks of Texas Instruments and BrilliantColor™ is a trademark of Texas Instruments.

All other product names used in this manual are the properties of their respective owners and are Acknowledged.

FCC

This device has been tested and found to comply with the limits for a Class B digital device pursuant to Part 15 of the FCC rules. These limits are designed to provide reasonable protection against harmful interference in a residential installation. This device generates, uses and can radiate radio frequency energy and, if not installed and used in accordance with the instructions, may cause harmful interference to radio communications.

However, there is no guarantee that interference will not occur in a particular installation. If this device does cause harmful interference to radio or television reception, which can be determined by turning the device off and on is encouraged to try to correct the interference by one or more of the following measures:

- Reorient or relocate the receiving antenna.
- Increase the separation between the device and receiver.
- Connect the device into an outlet on a circuit different from that to which the receiver is connected.
- Consult the dealer or an experienced radio/television technician for help.

Notice: Shielded cables

All connections to other computing devices must be made using shielded cables to maintain compliance with FCC regulations.

Caution

Changes or modifications not expressly approved by the manufacturer could void the user's authority, which is granted by the Federal Communications Commission, to operate this projector.

Operation Conditions

This device complies with Part 15 of the FCC Rules. Operation is subject to the following two conditions:

1. This device may not cause harmful interference and
2. This device must accept any interference received, including interference that may cause undesired operation.

Notice: Canadian users

This Class B digital apparatus complies with Canadian ICES-003.

Remarque à l'intention des utilisateurs canadiens

Cet appareil numérique de la classe B est conforme à la norme NMB-003 du Canada.

Declaration of Conformity for EU countries

- EMC Directive 2014/30/EU (including amendments)
- Low Voltage Directive 2014/35/EU
- RED 2014/53/EU (if product has RF function)

WEEE



Disposal instructions

Do not throw this electronic device into the trash when discarding. To minimize pollution and ensure utmost protection of the global environment, please recycle it.

Cleaning the Lens

- Before cleaning the lens, be sure to turn off the projector and unplug the power cord to allow it to completely cool down.
- Use a compressed air tank to remove the dust.
- Use a special cloth for cleaning lens and gently wipe the lens. Do not touch the lens with your fingers.
- Do not use alkaline/acid detergents or volatile solvents such as alcohol for cleaning lens. If the lens is damaged due to the cleaning process, it is not covered by the warranty.



Warning: Do not use a spray containing flammable gases to remove dust or dirt from the lens. This may cause a fire due to excessive heat inside the projector.



Warning: Do not clean the lens if the projector is warming up as this may cause the lens' surface film to peel off.



Warning: Do not wipe or tap the lens with a hard object.

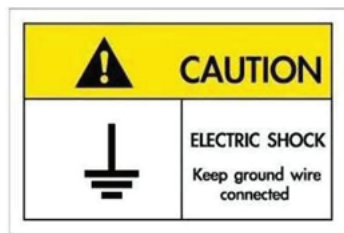

To avoid electric shock, the unit and its peripherals must be properly grounded (earthed).

INTRODUCTION

Thank you for purchasing an Optoma laser projector. For full list of features please visit the product page on our website, where you will also find additional information and documentation such as FAQs.

Package Overview

Carefully unpack and verify that you have the items listed below under standard accessories. Some of the items under optional accessories may not be available depending on the model, specification and your region of purchase. Please check with your place of purchase. Some accessories may vary from region to region.

The warranty card is only supplied in some specific regions. Please consult your dealer for detailed information.

Standard accessories

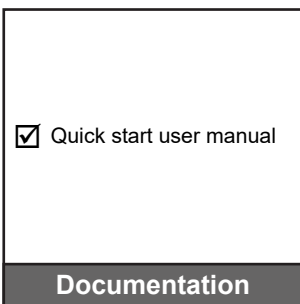
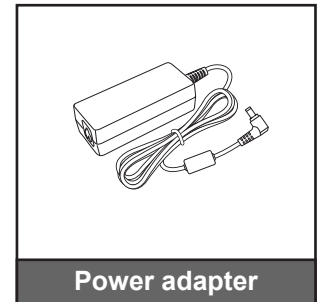
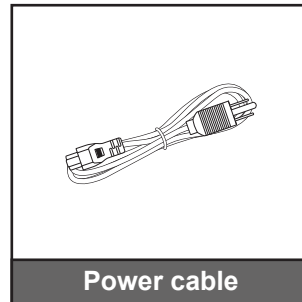
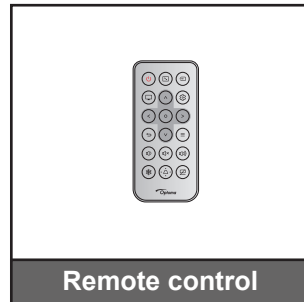
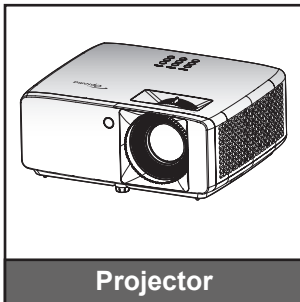

Note:

- For access to the setup information, user manual, warranty information, and product updates – please scan the QR Code or visit the following URL:
<https://www.optoma.com/support/download>



INTRODUCTION

Product Overview

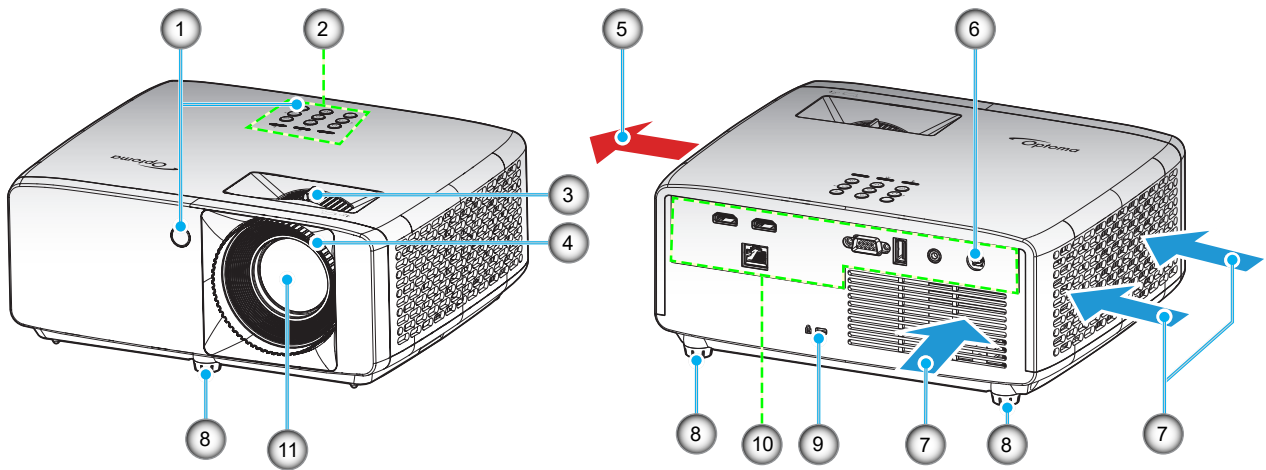

Short Throw model

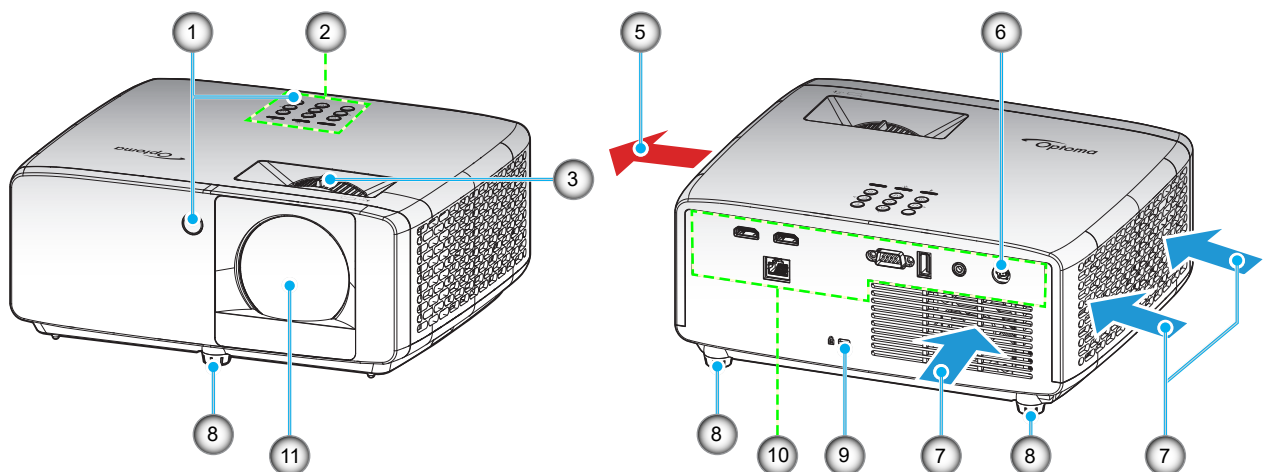

Note:

- Do not block projector intake and exhaust vents.
- When operating the projector in an enclosed space, allow at least 30 cm clearance around the intake and exhaust vents.

No	Item	No	Item
1.	IR Receivers	7.	Ventilation (inlet)
2.	Keypad	8.	Tilt-Adjustment Feet
3.	Zoom Lever	9.	Kensington™ Lock Port
4.	Focus Ring	10.	Input / Output
5.	Ventilation (outlet)	11.	Lens
6.	DC Jack		

INTRODUCTION

Connections

1080p model

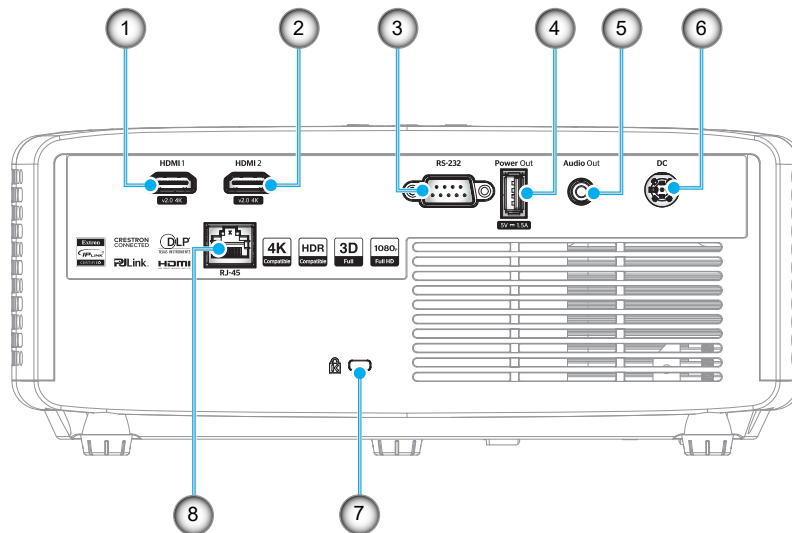

WXGA model

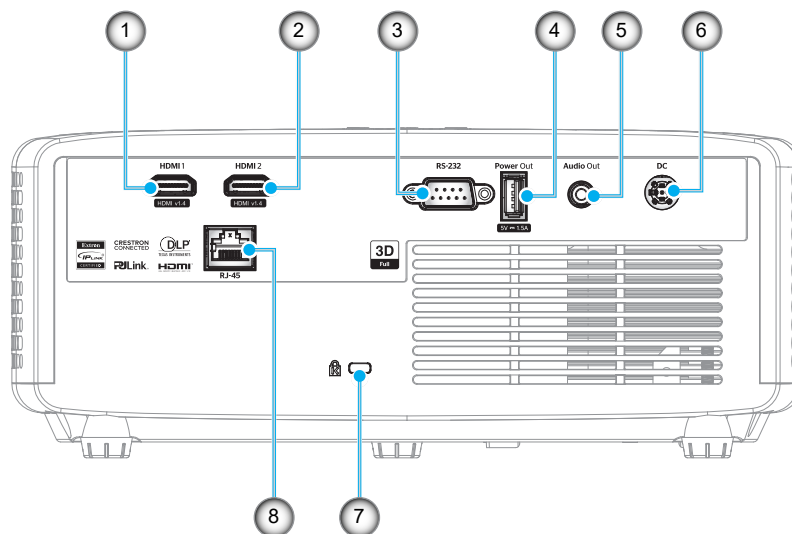

No	Item	No	Item
1.	HDMI 1 Connector	5.	Audio Out Connector
2.	HDMI 2 Connector	6.	DC Jack
3.	RS-232 Connector	7.	Kensington™ Lock Port
4.	USB Power Out (5V---1.5A) Connector	8.	RJ-45 Connector

Note: Signal mode support varies from different model in each sales region.

INTRODUCTION

Keypad

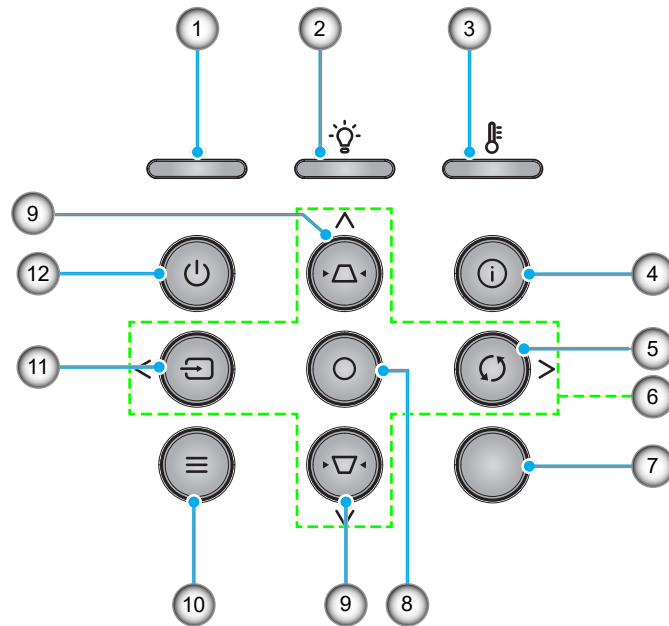

No	Item	No	Item
1.	Power LED	7.	IR Receiver
2.	Lamp LED	8.	Enter
3.	Temp LED	9.	Keystone Correction
4.	Information	10.	Menu
5.	Re-Sync	11.	Source
6.	Four Directional Select Keys	12.	Power

INTRODUCTION

Remote control

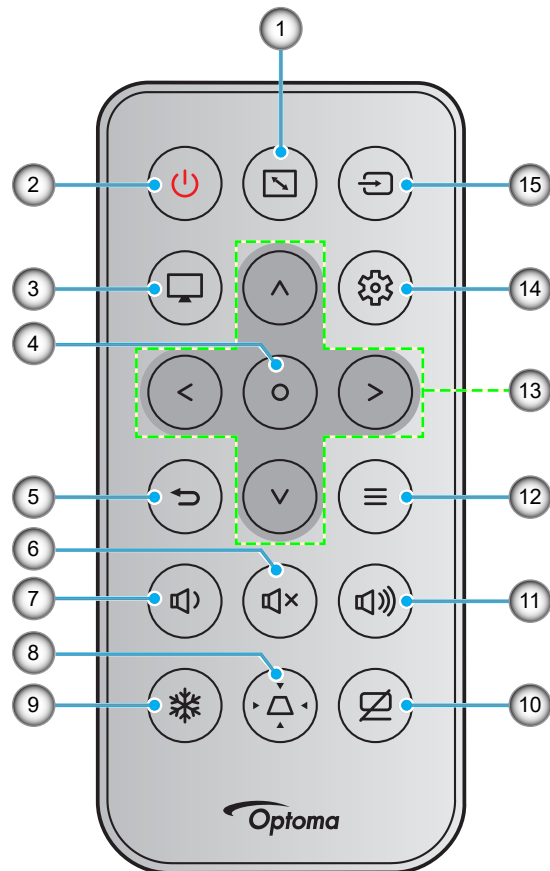

No	Item	No	Item
1.	Aspect Ratio	9.	Freeze
2.	Power On / Off	10.	AV Mute
3.	Mode	11.	Volume +
4.	Enter	12.	Menu
5.	Return	13.	Four Directional Select Keys
6.	Mute	14.	Settings/Setup Menu
7.	Volume -	15.	Source
8.	Keystone Correction		

Note:

- Some keys may have no function for models that do not support these features.
- Before using the remote control for the first time, remove the transparent insulation tape. See page 19 for battery installation.
- The inclusion of the battery for the remote control may vary depending on the region.

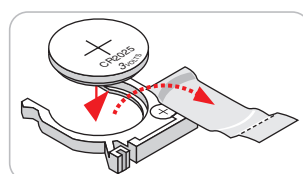

SETUP AND INSTALLATION

Installing the projector

Your projector is designed to be installed in one of four possible positions.

Your room layout or personal preference will dictate which installation location you select. Take into consideration the size and position of your screen, the location of a suitable power outlet, as well as the location and distance between the projector and the rest of your equipment.

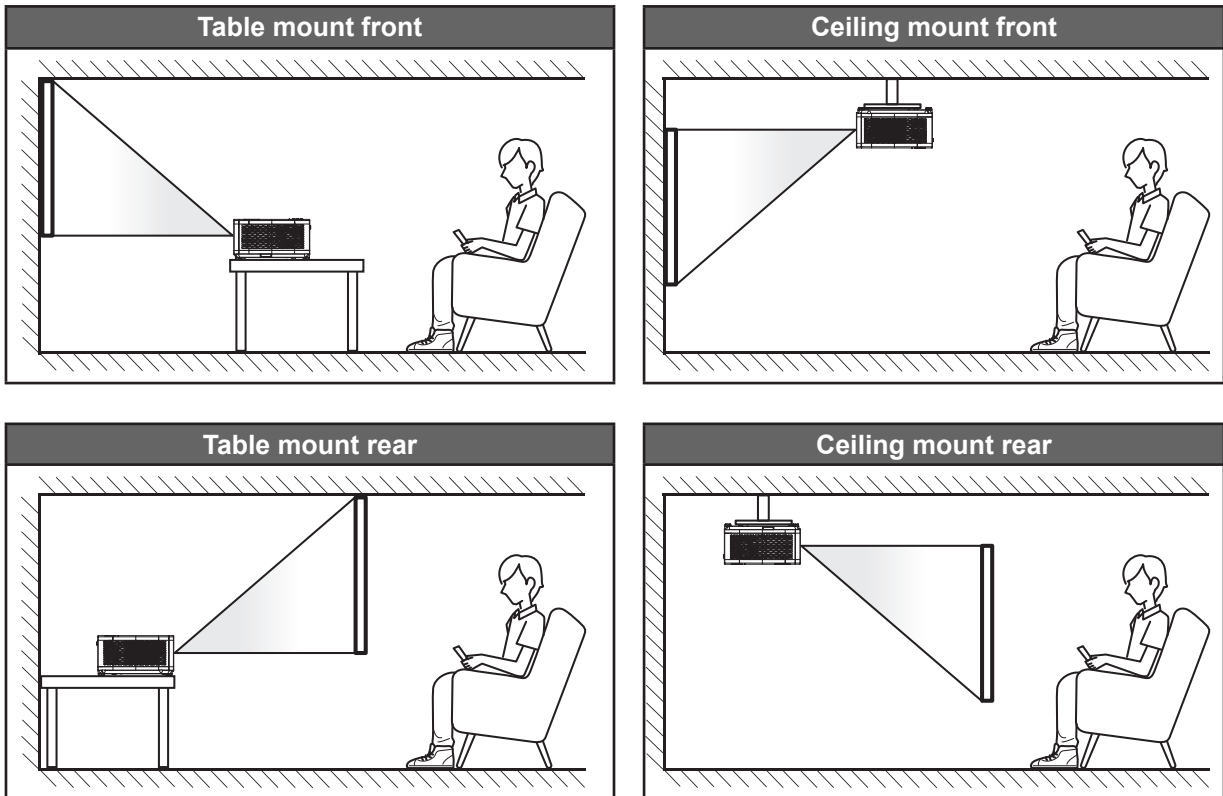

Projector should be placed flat on a surface and 90 degrees / perpendicular to the screen.

- How to determine projector location for a given screen size, please refer to distance table on pages 59~60.
- How to determine screen size for a given distance, please refer to distance table on pages 59~60.

Note: *The further away the projector is placed from the screen the projected image size increases and vertical offset also increases proportionally.*

SETUP AND INSTALLATION

Projector installation notice

- 360° free orientation operation

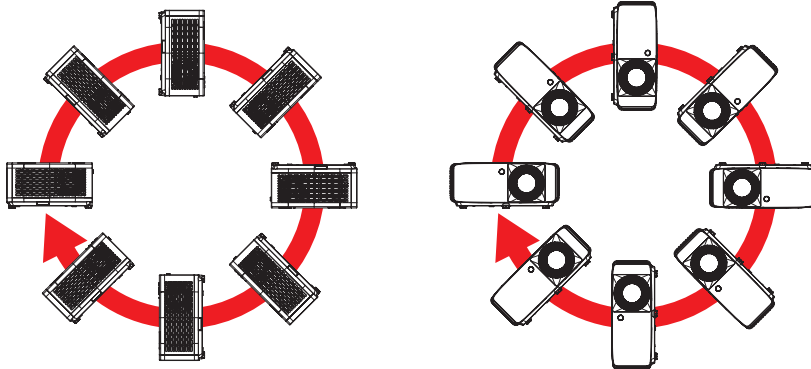

- Allow at least 30 cm clearance around the exhaust vent.

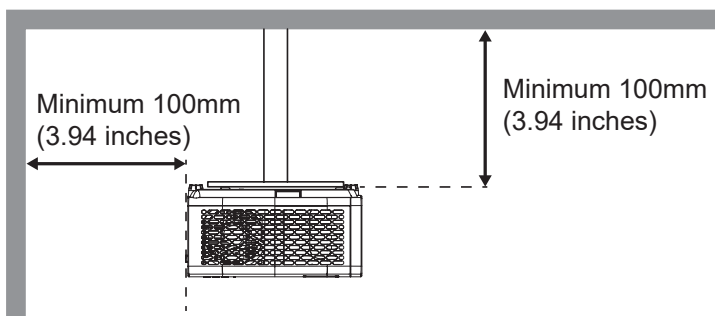
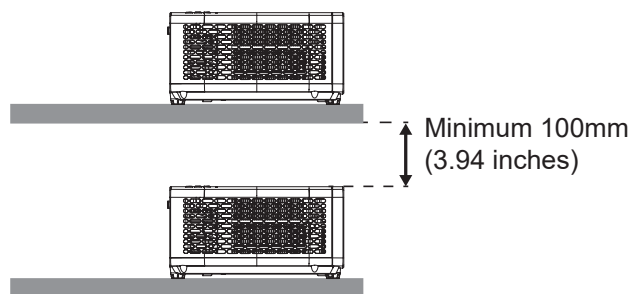
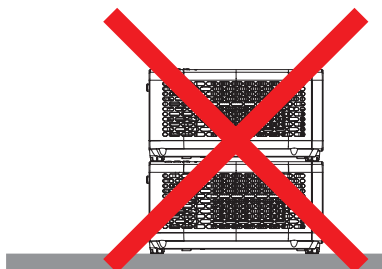
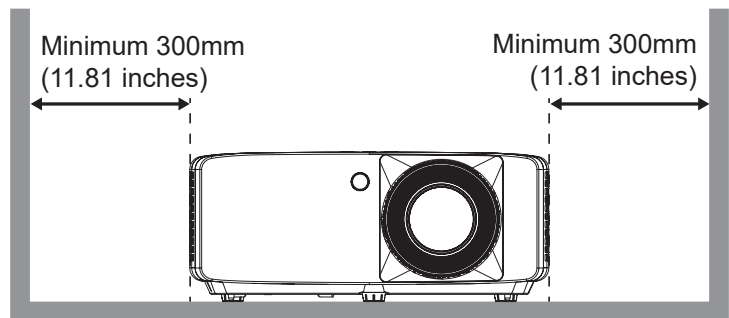
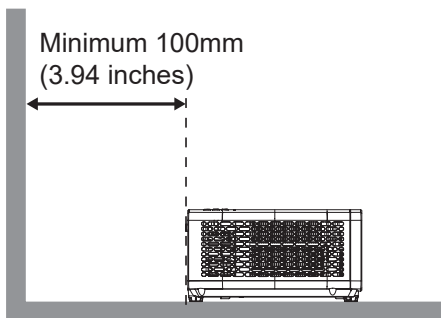

- Ensure that the intake vents do not recycle hot air from the exhaust vent.
- When operating the projector in an enclosed space, ensure that the surrounding air temperature within the enclosure does not exceed operation temperature while the projector is running, and the air intake and exhaust vents are unobstructed.
- All enclosures should pass a certified thermal evaluation to ensure that the projector does not recycle exhaust air, as this may cause the device to shutdown even if the enclosure temperature is within the acceptable operation temperature range.

SETUP AND INSTALLATION

Connecting sources to the projector

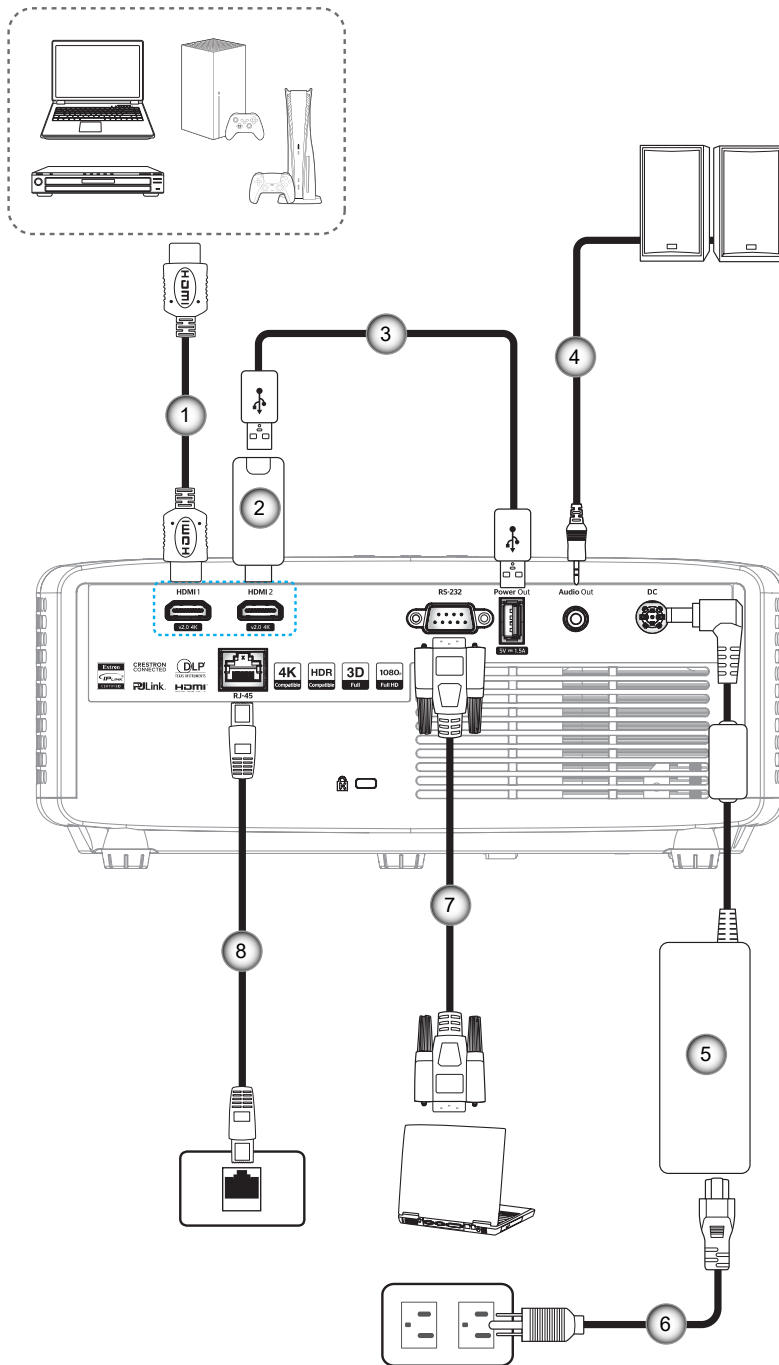

No	Item	No	Item
1.	HDMI Cable	5.	Power Adapter
2.	HDMI Dongle	6.	Power Cable
3.	USB Power Cable	7.	RS232 Cable
4.	Audio Out Cable	8.	RJ-45 Cable*

Note: To ensure the best image quality and avoid connection errors, we recommend the use of High Speed or Premium Certified HDMI cables up to 5 meters.

SETUP AND INSTALLATION

Adjusting the projector image

Image height

The projector is equipped with elevator feet for adjusting the image height.

1. Locate the adjustable foot you wish to adjust on the underside of the projector.
2. Rotate the adjustable foot clockwise or counterclockwise to raise or lower the projector.

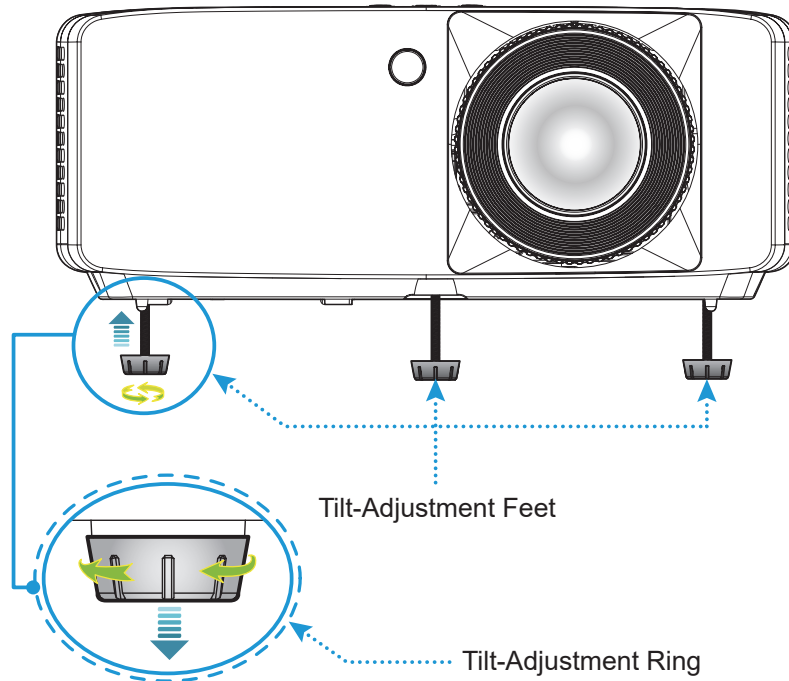

Short Throw model:

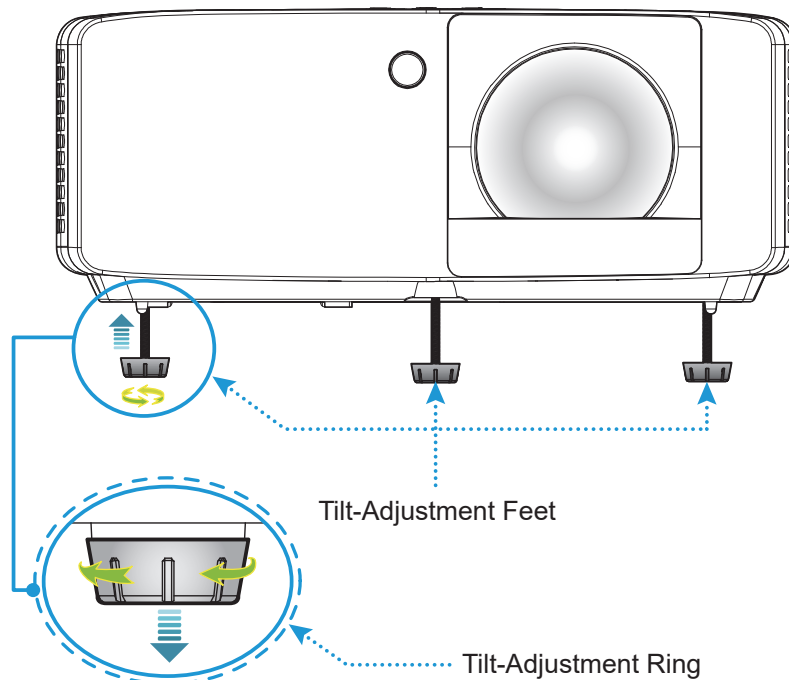

SETUP AND INSTALLATION

Zoom and focus

- To adjust the image size, turn the zoom lever clockwise or counterclockwise to increase or decrease the projected image size.
- To adjust the focus, turn the focus ring clockwise or counterclockwise until the image is sharp and legible.

1080p 1.3x model:

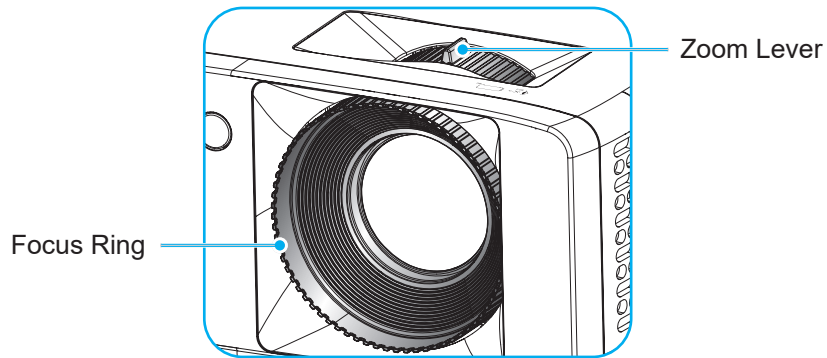

Short Throw model:

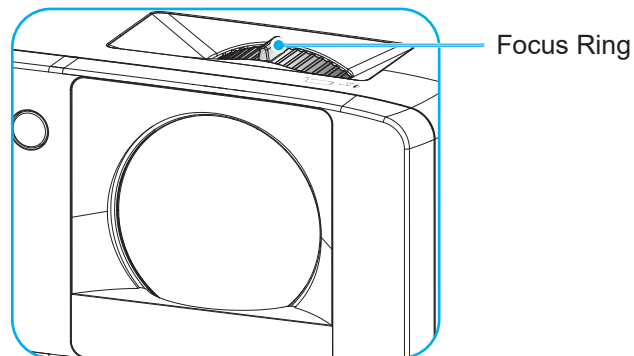

SETUP AND INSTALLATION

Remote setup

Installing / replacing the batteries

1. Press firmly and slide the battery cover off.

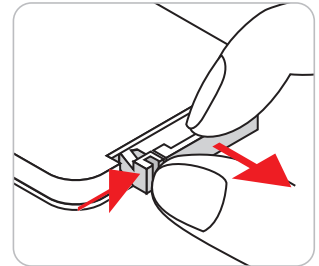

2. Install new battery into the compartment. Remove the old battery and install new one (CR2025). Ensure that the side with a “+” is facing up.

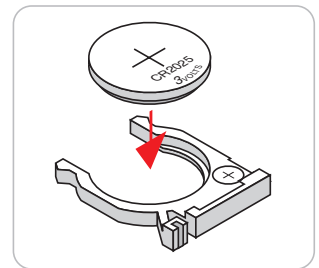

3. Put the cover back.

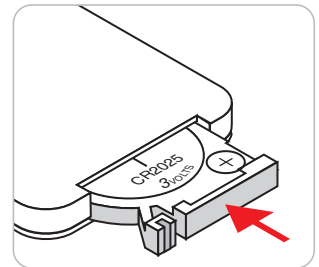

CAUTION: To ensure safe operation, please observe the following precautions:

- Use CR2025 type battery.
- Avoid contact with water or liquid.
- Do not expose the remote control to moisture or heat.
- Do not drop the remote control.
- If the battery has leaked in the remote control, carefully wipe the case clean and install new battery.
- Risk of an explosion if battery is replaced by an incorrect type.
- Dispose of used battery according to the instructions.

Note: The inclusion of the battery for the remote control may vary depending on the region.

SETUP AND INSTALLATION

Effective range

Infra-Red (IR) remote control sensor is located on the top and front sides of the projector. Ensure that the remote control is held at an angle 30 degrees perpendicular to the projector's IR remote control sensor to ensure correct functionality. The distance between the remote control and the sensor should not be longer than 6 meters (19.7 feet).

- Make sure that there are no obstacles between the remote control and the IR sensor on the projector that might obstruct the infra-red beam.
- Make sure the IR transmitter of the remote control is not being shined on directly by sunlight or fluorescent lamps.
- Please keep the remote controller at least 2m away from fluorescent lamps or it may malfunction.
- If the remote control is close to Inverter-Type fluorescent lamps, it might become ineffective from time to time.
- If the remote control and the projector are within a very short distance of one another, the remote control might become ineffective.

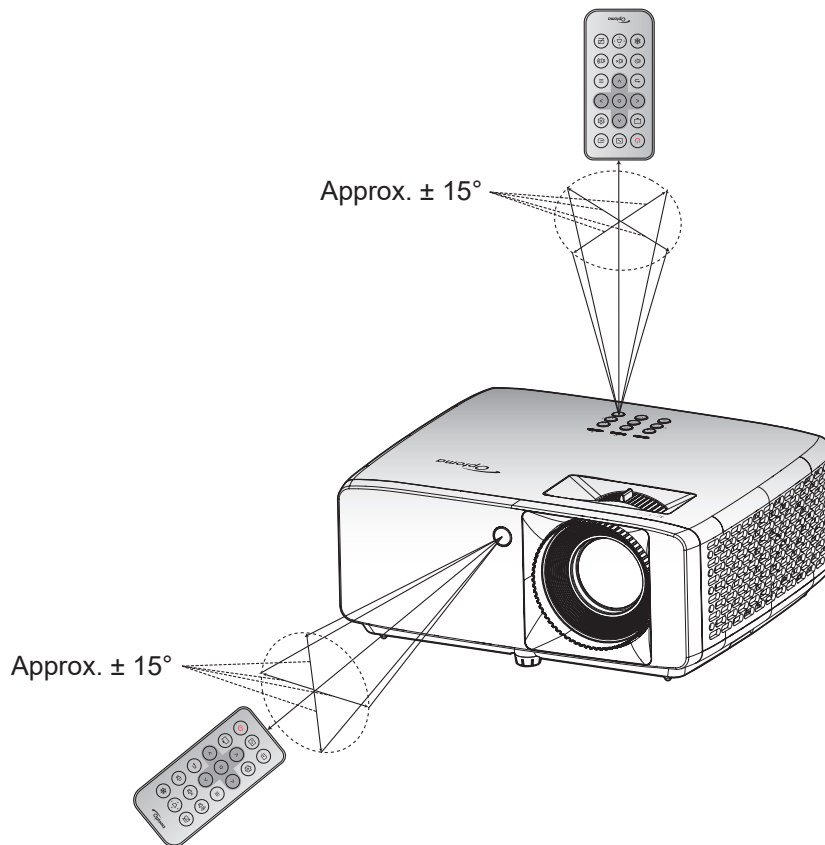

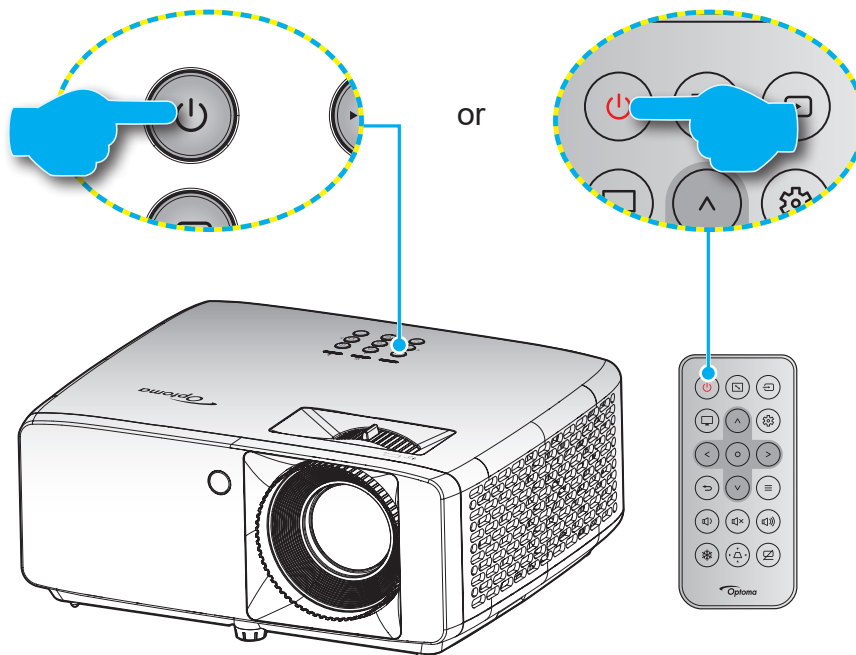

USING THE PROJECTOR

Powering on / off the projector





Powering on



1. Securely connect the power lead and signal/source cable. When connected, the Power LED will turn red.
2. Turn on the projector by pressing the  button on the projector keypad or the  button on the remote control.
3. A start up screen will display in approximately 10 seconds and the Power LED will be flashing green or blue.

Note: The first time the projector is turned on, you will be prompted to select the preferred language, projection orientation, and other settings.

Powering off

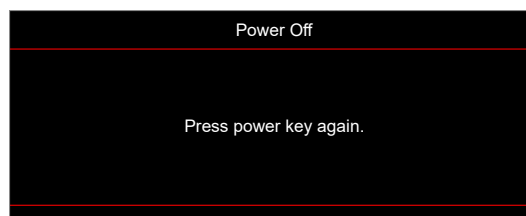
1. Turn off the projector by pressing the  button on the projector keypad or the  button on the remote control.
2. The following message will be displayed:



3. Press the  button again to confirm, otherwise the message will disappear after 15 seconds. When you press the  button for the second time, the projector will shut down.
4. The cooling fans will continue to operate for about 10 seconds for the cooling cycle and the Power LED will flash green or blue. When the Power LED turns solid red, this indicates the projector has entered standby mode. If you wish to turn the projector back on, you must wait until the cooling cycle has finished and the projector has entered standby mode. When the projector is in standby mode, simply press the  button again to turn on the projector.
5. Disconnect the power lead from the electrical outlet and the projector.

Note: It is not recommended that the projector is turned on immediately, right after a power off procedure.

USING THE PROJECTOR

Selecting an input source

Turn on the connected source that you want to display on the screen, such as computer, notebook, video player, etc. The projector will automatically detect the source. If multiple sources are connected, press the  button on the projector keypad or remote control to select the desired input.

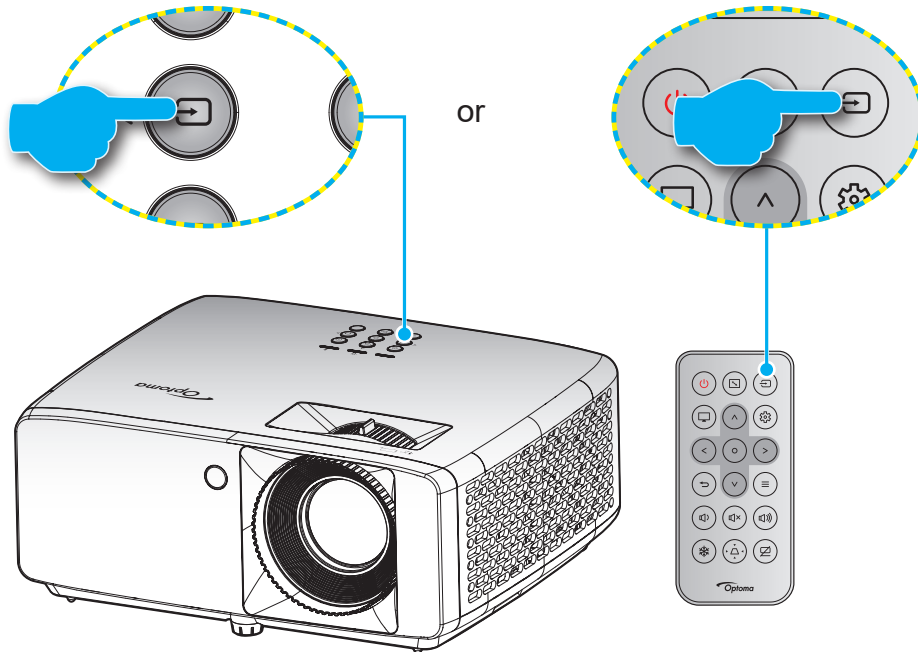

USING THE PROJECTOR

Menu navigation and features

The projector has multilingual on-screen display menus that allow you to make image adjustments and change a variety of settings. The projector will automatically detect the source.

1. To open the OSD menu, press the \equiv button on the projector keypad or remote control.
2. When OSD is displayed, use \wedge / \vee keys to select any item in the main menu. While making a selection on a particular page, press the \circ button on the projector keypad or remote control to enter sub menu.
3. Use \lt / \gt keys to select the desired item in the sub menu and then press the \circ button to view further settings. Adjust the settings by using $\wedge / \vee / \lt / \gt$ keys.
4. Select the next item to be adjusted in the sub menu and adjust as described above.
5. Press the \circ button to confirm, and the screen will return to the main menu.
6. To exit, press the \equiv button again. The OSD menu will close and the projector will automatically save the new settings.

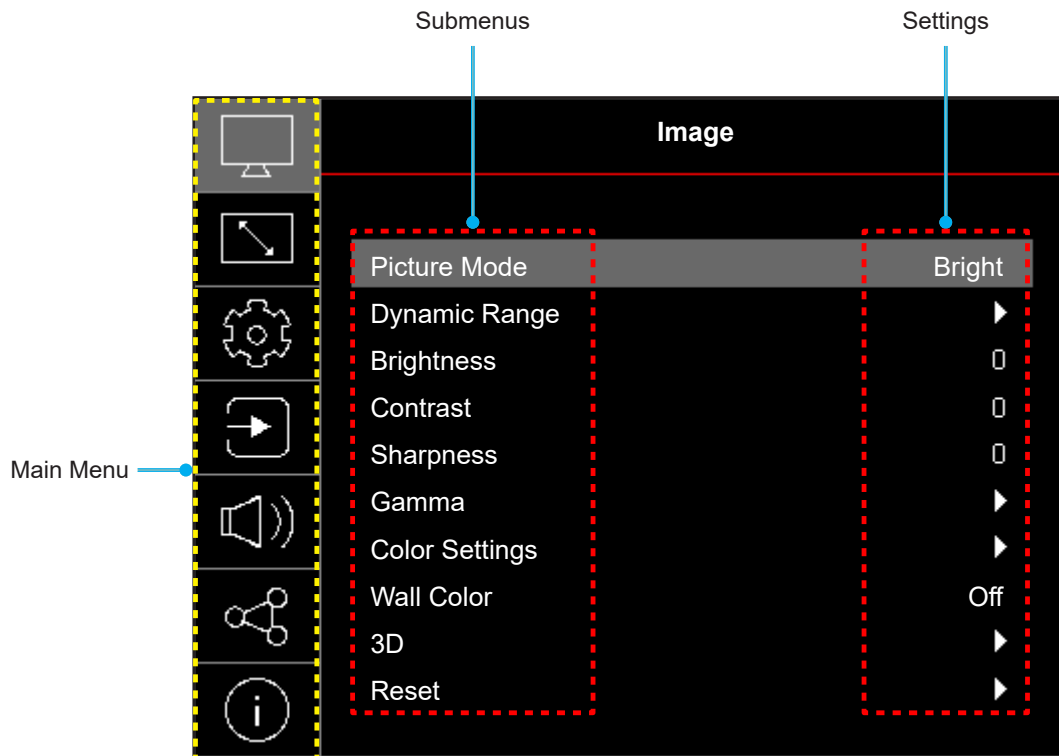

USING THE PROJECTOR

OSD Menu tree



Note: The OSD menu tree items and features are subject to models and region. Optoma reserve the right to add or remove items to improve product performance without notice.

Main Menu	Sub Menu	Sub Menu 2	Sub Menu 3	Sub Menu 4	Values		
Image	Picture Mode				Vivid		
					HDR [for HDMI 2.0 models]		
					HLG [for HDMI 2.0 models]		
					Cinema		
					Game		
					Sport		
					Reference		
					Bright		
					DICOM SIM.		
				3D			
	Dynamic Range [for HDMI 2.0 models]	HDR / HLG			Auto		
					Off		
	Brightness				-50 ~ 50		
	Contrast				-50 ~ 50		
	Sharpness				1 ~ 15		
	Gamma					Film	
						Graphics	
						1.8	
						2.0	
						2.2	
						2.4	
	Color Settings	Color				-50 ~ 50	
						-50 ~ 50	
						1 ~ 10	
		Color Temperature					Warm
							Standard
							Cool
							Cold
		CMS	Color				White / Red / Green / Blue / Cyan / Magenta / Yellow
							-50 ~ 50
							-50 ~ 50
							-50 ~ 50
							No
						Yes	
Color Space				Auto / RGB(0~255) / RGB(16~235) / YUV			

USING THE PROJECTOR

Main Menu	Sub Menu	Sub Menu 2	Sub Menu 3	Sub Menu 4	Values	
Image	Wall Color				Off	
					Blackboard	
					Light Yellow	
					Light Green	
					Light Blue	
					Pink	
					Grey	
	3D	3D Mode				Off
						On
		3D Tech				DLP-Link
						3D Sync
		3D-2D Conversion				3D
						L
						R
		3D Format				Auto
						Side by Side (SBS)
						Top and Bottom
						Frame Sequential
		3D Sync Invert				Off
						On
Reset				No		
				Yes		
Reset						
Display	Projection Orientation				Front	
					Rear	
					Ceiling-Top	
					Rear-Top	
	Light Source Mode				Eco.	
					Power =100% / 95% / 90% / 85% / 80% / 75% / 70% / 65% / 60% / 55% / 50% (100%~20%)- Password lock	
	Dynamic Black				Off	
					On	
	Gaming Mode				Off	
					On	
	Screen Type				4:3	
					16:9	
					16:10	
	Aspect Ratio				4:3 [Screen Type: 4:3]	
					16:9 [Screen Type: 16:9]	
					16:10 [Screen Type: 16:10]	
					21:9	
				Native		
				Auto		

USING THE PROJECTOR

Main Menu	Sub Menu	Sub Menu 2	Sub Menu 3	Sub Menu 4	Values	
Display	Geometric Correction	V Keystone			-30 ~ 30 [-15 ~ 15, for ST model]	
		H Keystone			-30 ~ 30 [-15 ~ 15, for ST model]	
		Four Corner Adjustment				
		Reset				
	Digital Zoom	Zoom			-5 ~ 25	
	Image Shift	H 				-100 ~ 100
		V 				-100 ~ 100
		Reset				
	Reset					
	Setup	Test Pattern				Green Grid
					Magenta Grid	
					White Grid	
					White	
					Off	
Language						English
						Deutsch
						Français
						Italiano
						Español
						Português
						Polski
						Nederlands
						Svenska
						Norsk
						Dansk
						Suomi
						ελληνικά
						繁體中文
						簡體中文
						日本語
						한국어
						Русский
						Magyar
						Čeština
						عربي
						ไทย
				Türkçe		

USING THE PROJECTOR

Main Menu	Sub Menu	Sub Menu 2	Sub Menu 3	Sub Menu 4	Values		
Setup	Language				فارسی		
					Tiếng Việt		
					Bahasa Indonesia		
					Română		
	Menu Settings	Menu Location				Top-Left	
						Top-Right	
						Bottom-Left	
						Bottom-Right	
						Center	
		Menu Timer					Off
							5s
							10s
							20s
							30s
	Information Hide					Off	
						On	
	High Altitude					Off	
						On	
	Filter Settings	Filter Usage Hours				(read only)	
		Optional Filter Installed				No	
						Yes	
		Filter Reminder					Off
							300hr
							500hr
							800hr
		Filter Reset					1000hr
						No	
	Power Settings	Direct Power On				Yes	
						Off	
		Signal Power On					On
							Off
		Auto Power Off (min.)				0 ~ 180 (1 min increments)	
	Sleep Timer (min.)				0 ~ 990 (30 min increments)		
	Power Mode (Standby)					Active	
						Eco.	
	Security	Security				Off	
						On	
		Security Timer	Month				
			Day				
			Hour				
Change Password							

USING THE PROJECTOR

Main Menu	Sub Menu	Sub Menu 2	Sub Menu 3	Sub Menu 4	Values		
Setup	Startup Logo				Default		
					Neutral		
					User		
	Background Color					None	
						Blue	
						Red	
						Green	
						Grey	
						Logo	
	Reset	Reset OSD				No	
					Yes		
	Reset to Default				No		
					Yes		
Input	Auto Source				Off		
					On		
	Auto Input Switch					Off	
						On	
	HDMI CEC Settings	HDMI Link				Off	
						On	
		Inclusive of TV					No
							Yes
		Power On Link					Mutual
							PJ → Device
	Power Off Link					Device → PJ	
						Off	
	Reset					On	
					No		
Audio	Volume				0 ~ 100		
	Mute				Off		
						On	
Reset							
Control	Device ID				0~99		
	Remote Settings	IR Function				On	
						Off	
	Keypad Settings	Keypad Lock				Off	
						On	
	LAN	Network Status				(read only)	
		MAC Address				(read only)	
		DHCP				Off / On	
		IP Address				192.168.0.100	
		Subnet Mask				255.255.255.0	
		Gateway				192.168.0.254	
DNS					192.168.0.51		
Reset							

USING THE PROJECTOR

Main Menu	Sub Menu	Sub Menu 2	Sub Menu 3	Sub Menu 4	Values	
Control	Control	Crestron (Port 41794)			Off	
					On	
		Extron (Port 2023)			Off	
					On	
		PJ Link (Port 4352)			Off	
					On	
	AMX Device Discovery (Port 9131)			Off		
			On			
Telnet (Port 23)			Off			
			On			
HTTP (Port 80)			Off			
			On			
	Reset					
Information	Regulatory					
	Serial Number					
	Source					
	Color Info					
	Light Source Hours					
	Picture Mode					
	Device ID					
	Filter Usage Hours					
	Note: <i>Optional dust filter may vary by regions. Please consult with your local agent.</i>					
	Light Source Mode					
FW Version	DDP					
	MCU					
	LAN					

USING THE PROJECTOR

Image menu

Image picture mode menu

There are several predefined display modes that you can choose from to suit your viewing preference. Each mode has been fine-tuned by our expert colour team to ensure superior colour performance for wide range of content.

- **Vivid:** In this mode, the color saturation and brightness are well-balanced. Choose this mode for playing games.
- **HDR / HLG:** Decodes and displays High Dynamic Range (HDR) / Hybrid Log Gamma (HLG) content for the deepest blacks, brightest whites, and vivid cinematic color using REC.2020 color gamut. This mode will be automatically enabled if HDR/HLG is set to Auto (and HDR/HLG Content is sent to projector – 4K UHD Blu-ray, 1080p/4K UHD HDR/HLG Games, 4K UHD Streaming Video). While HDR/HLG mode is active, other display modes (Cinema, Reference, etc.) cannot be selected as HDR/HLG delivers color that is highly accurate, exceeding the color performance of the other display modes.
Note: *This option is only available for 1080p model.*
- **Cinema:** Provides the best balance of detail and colors for watching movies.
- **Game:** Optimises your projector for maximum contrast and vivid colours allowing you to see shadow detail when playing video games.
- **Sport:** Optimises your projector for watching sports playback or playing sports games.
- **Reference:** This mode reproduces colours as close as possible the image the way the movie director intended. Color, color temperature, brightness, contrast and gamma settings are all configured to Rec.709 color gamut. Select this mode for the most accurate colour reproduction when watching movies.
- **Bright:** This mode is suitable for environments where extra-high brightness is required, such as using the projector in well-lit rooms.
- **DICOM SIM.:** This mode has been created for viewing greyscale images, perfect for viewing X-rays and scans during medical training*.
Note: **This projector is not suitable for use in medical diagnosis.*
- **3D:** Optimized settings for watching 3D content.
Note: *To experience the 3D effect, you will need to have compatible DLP Link 3D glasses. See 3D section for more information.*

Image dynamic range menu

HDR / HLG

Configure the High Dynamic Range (HDR) / Hybrid Log Gamma(HLG) setting and its effect when displaying video from 4K Blu-ray players and streaming devices.

- **Auto:** Auto detect HDR/HLG signal.
- **Off:** Turn off HDR/HLG Processing. When set to Off, the projector will NOT decode HDR/HLG content.

Note: *This option is only available for 1080p model.*

Image brightness menu

Adjust the brightness of the image.

USING THE PROJECTOR

Image contrast menu

The contrast controls the degree of difference between the lightest and darkest parts of the picture.

Image sharpness menu

Adjust the sharpness of the image.

Image gamma menu

Set up gamma curve type. After the initial setup and fine tuning is completed, utilize the Gamma Adjustment steps to optimize your image output.

- **Film:** For home theater.
- **Graphics:** For PC / Photo source.
- **1.8 / 2.0 / 2.2 / 2.4:** For specific PC / Photo source.

Image color settings menu

Color

Adjust a video image from black and white to fully saturated color.

Tint

Adjust the color balance of red and green.

BrilliantColor™

This adjustable item utilizes a new color-processing algorithm and enhancements to enable higher brightness while providing true, more vibrant colors in picture.

Color Temperature

Select a color temperature from Warm, Standard, Cool, or Cold.

CMS

Select the following options:

- **Color:** Adjust the red, green, blue, cyan, yellow, magenta, and white level of the image.
- **Hue:** Adjust the color balance of red and green.
- **Saturation:** Adjust a video image from black and white to fully saturated color.
- **Gain:** Adjust the luminance of the selected color.
- **Reset:** Return the factory default settings for color adjustment.
- **Exit:** Return to the previous menu.

Color Space

Select an appropriate color matrix type from the following: Auto, RGB(0-255), RGB(16-235), and YUV.

Image wall color menu

Designed to adjust the colors of the projected image when projecting on to a wall without a screen. Each mode has been fine-tuned by our expert colour team to ensure superior color performance.

There are several predefined modes that you can choose from to suit the colour of your wall. Select between off, blackboard, light yellow, light green, light blue, pink, and grey.

Note: For accurate color reproduction, we recommend using a screen.

USING THE PROJECTOR

Image 3D menu

Note:

- *This projector is a 3D ready projector with DLP-Link 3D solution.*
- *Please ensure that 3D glasses are in use for DLP-Link 3D content before enjoying your video.*
- *This projector supports frame sequential (page-flip) 3D via HDMI1/HDMI2 ports.*
- *To enable 3D mode, the input frame rate should be set to 60Hz only, lower or higher frame rate is not supported.*
- *To reach the best performance, resolution 1920x1080 is recommended, please note that 4K (3840x2160) resolution is not supported in 3D mode.*

3D Mode

Use this option to disable or enable the 3D function.

- **Off:** Select “Off” to turn off 3D mode.
- **On:** Select “On” to turn on 3D mode.

3D Tech

Use this option to select 3D technology.

- **DLP-Link:** Select to use optimized settings for DLP 3D Glasses.
- **3D Sync:** Select to use optimized settings for IR, RF or polarized 3D Glasses.

3D-2D Conversion

Use this option to specify how the 3D content should appear on the screen.

- **3D:** Display 3D signal.
- **L:** Display the left frame of 3D content.
- **R:** Display the right frame of 3D content.

3D Format

Use this option to select the appropriate 3D format content.

- **Auto:** When a 3D identification signal is detected, the 3D format is selected automatically.
- **Side by Side:** Display 3D signal in “Side-by-Side” format.
- **Top and Bottom:** Display 3D signal in “Top and Bottom” format.
- **Frame Sequential:** Display 3D signal in “Frame Sequential” format.

3D Sync Invert

Use this option to enable/disable the 3D sync invert function.

Reset

Return the factory default setting for 3D settings.

- **No:** Select to cancel Reset.
- **Yes:** Select to return the factory default settings for 3D.

Image reset menu

Return the factory default settings for image settings.

USING THE PROJECTOR

Display menu

Display projection orientation menu

Select the preferred projection between front, rear, ceiling-top, and rear-top.

Display light source mode menu

Select a light source mode depending on the installation requirements.

Display dynamic black menu

Use to automatically adjust the picture brightness in order to give optimum contrast performance.

Display gaming mode menu

Enable this feature to reduce response times (input latency) during gaming to 8.6ms (1080p@120Hz). All geometry settings (example: Keystone, Four Corners) will be disabled when Gaming Mode is enabled. For more information is below.

Note:

- *The input lag by signals is described in the following table:*
- *The values in the table can vary slightly.*

Source Timing	Gaming Mode	Output Timing	Output Resolution	Input Lag
1080p60	On	1080p60Hz	1080p	17ms
1080p120	On	1080p120Hz	1080p	8.6ms*
4K60	On	1080p60Hz	1080p	17ms*
1080p60	Off	1080p60Hz	1080p	49.5ms
1080p120	Off	1080p120Hz	1080p	25ms
4K60	Off	1080p60Hz	1080p	49.6ms

- *1080p120 and 4K60 only support 1080p model.*
- **Only supported in 1080p model.*

Display screen type menu

Choose the screen type from 4:3, 16:9, and 16:10.

USING THE PROJECTOR

Display aspect ratio menu

Select the aspect ratio of the displayed image between the following options:

- **4:3:** This format is for 4:3 input sources.
- **16:9:** This format is for 16:9 input sources, like HDTV and DVD enhanced for Wide screen TV.
- **16:10:** This format is for 16:10 input sources.
- **21:9:** This format is for 21:9 input sources.
- **Native:** This format displays the original image without any scaling.
- **Auto:** Automatically selects the appropriate display format.

WXGA scaling table (screen type 16x10):

16 : 10 screen	480i/p	576i/p	1080i/p	720p	PC
4x3	Scale to 1066x800.				
16x10	Scale to 1280x800.				
LBX	Scale to 1280x960, then get the central 1280x800 image to display.				
Native mode	1:1 mapping centered.		1:1 mapping display 1280x800.	1280x720 centered.	1:1 mapping centered.
Auto	- Input source will be fit into 1280x800 display area and be kept its original aspect ratio. - If source is 4:3, the screen type will be scaled to 1066x800. - If source is 16:9, the screen type will be scaled to 1280x720. - If source is 15:9, the screen type will be scaled to 1280x768. - If source is 16:10, the screen type will be scaled to 1280x800.				

WXGA auto mapping rule (screen type 16x10):

Auto	Input resolution		Auto/Scale	
	H-resolution	V-resolution	1280	800
4:3	640	480	1066	800
	800	600	1066	800
	1024	768	1066	800
	1280	1024	1066	800
	1400	1050	1066	800
	1600	1200	1066	800
Wide Laptop	1280	720	1280	720
	1280	768	1280	768
	1280	800	1280	800
SDTV	720	576	1280	720
	720	480	1280	720
HDTV	1280	720	1280	720
	1920	1080	1280	720

USING THE PROJECTOR

WXGA scaling table (screen type 16x9):

16 : 9 screen	480i/p	576i/p	1080i/p	720p	PC
4x3	Scale to 960x720.				
16x9	Scale to 1280x720.				
LBX	Scale to 1280x960, then get the central 1280x720 image to display.				
Native mode	1:1 mapping centered.		1:1 mapping display 1280x720.	1280x720 centered.	1:1 mapping centred.
Auto	<ul style="list-style-type: none"> - If auto format is selected, the screen type will automatically become 16:9 (1280x720). - If source is 4:3, the screen type will be scaled to 960x720. - If source is 16:9, the screen type will be scaled to 1280x720. - If source is 15:9, the screen type will be scaled to 1200x720. - If source is 16:10, the screen type will be scaled to 1152x720. 				

WXGA auto mapping rule (screen type 16x9):

Auto	Input resolution		Auto/Scale	
	H-resolution	V-resolution	1280	720
4:3	640	480	960	720
	800	600	960	720
	1024	768	960	720
	1280	1024	960	720
	1400	1050	960	720
	1600	1200	960	720
Wide Laptop	1280	720	1280	720
	1280	768	1200	720
	1280	800	1152	720
SDTV	720	576	1280	720
	720	480	1280	720
HDTV	1280	720	1280	720
	1920	1080	1280	720

USING THE PROJECTOR

1080p scaling table:

16:9 screen	480i/p	576i/p	1080i/p	720p	PC
4x3	Scale to 1440x1080.				
16x9	Scale to 1920x1080.				
LBX	Scale to 1920x1440, then get the central 1920x1080 image to display.				
Native mode	<ul style="list-style-type: none"> - 1:1 mapping centered. - No scaling will be made; the image is displayed with the resolution based on input source. 				
Auto	<ul style="list-style-type: none"> - If auto format is selected, the screen type will automatically become 16:9 (1920x1080). - If source is 4:3, the screen type will be scaled to 1440 x1080. - If source is 16:9, the screen type will be scaled to 1920x1080. - If source is 16:10, the screen type will be scaled to 1920x1200 and cut 1920x1080 area to display. 				

1080p auto mapping rule:

Auto	Input resolution		Auto/Scale	
	H-resolution	V-resolution	1920	1080
4:3	640	480	1440	1080
	800	600	1440	1080
	1024	768	1440	1080
	1280	1024	1440	1080
	1400	1050	1440	1080
	1600	1200	1440	1080
Wide Laptop	1280	720	1920	1080
	1280	768	1800	1080
	1280	800	1728	1080
SDTV	720	576	1350	1080
	720	480	1620	1080
HDTV	1280	720	1920	1080
	1920	1080	1920	1080

USING THE PROJECTOR

Display geometric correction menu

V Keystone

Adjust image distortion vertically and make a squarer image. Vertical keystone is used to correct a keystone image shape in which the top and bottom are slanted to one of the sides. This is intended for use with vertically on-axis applications.

H Keystone

Adjust image distortion horizontally and make a squarer image. Horizontal keystone is used to correct a keystone image shape in which the left and right borders of the image are unequal in length. This is intended for use with horizontally on-axis applications.

Note: *H Keystone function is not supported in WXGA model.*

Four Corner Adjustment

This setting allows the projected image to be adjusted from each corner to make a square image when the projection surface is not level.

Note: *Four Corner Adjustment function is not supported in WXGA model.*

Reset

Return the factory default setting for geometric correction settings.

Display digital zoom menu

Use to reduce or magnify an image on the projection screen. Digital Zoom is not the same as optical zoom and can result in degradation of image quality.

Note: *Zoom settings are retained on power cycle of the projector.*

Display image shift menu

Adjust the projected image position horizontally (H) or vertically (V).

Display reset menu

Return the factory default settings for display settings.

USING THE PROJECTOR

Setup menu

Setup test pattern menu

Select the test pattern from green grid, magenta grid, white grid, white, or disable this function (off).

Setup language menu

Select the multilingual OSD menu between English, German, French, Italian, Spanish, Portuguese, Polish, Dutch, Swedish, Norwegian, Danish, Finnish, Greek, Traditional Chinese, Simplified Chinese, Japanese, Korean, Russian, Hungarian, Czechoslovak, Arabic, Thai, Turkish, Farsi, Vietnamese, Indonesian, and Romanian.

Setup menu settings menu

Menu Location

Set the position of the OSD menu on the screen.

Menu Timer

Set the duration where the OSD menu stays visible on the screen.

Information Hide

Enable this function to hide the information message.

Setup high altitude menu

When "On" is selected, the fans will spin faster. This feature is useful in high altitude areas where the air is thin.

Setup filter settings menu

Filter Usage Hours

Display the filter time.

Optional Filter Installed

Note: *Please consult with your local agent regarding the availability of this optional filter.*

Set the warning message setting.

- **Yes:** Display warning message after 500 hours of use.

Note: *"Filter Usage Hours / Filter Reminder / Filter Reset" will only appear when "Optional Filter Installed" is "Yes".*

- **No:** Turn off warning message.

Filter Reminder

Choose this function to show or hide the warning message when the changing filter message is displayed. The available options include Off, 300hr, 500hr, 800hr, and 1000hr.

Filter Reset

Reset the dust filter counter after replacing or cleaning the dust filter.

USING THE PROJECTOR

Setup power settings menu

Direct Power On

Choose “On” to activate Direct Power mode. The projector will automatically power on when AC power is supplied, without pressing the “Power” key on the projector keypad or on the remote control.

Signal Power On

Choose “On” to activate Signal Power mode. The projector will automatically power on when a signal is detected, without pressing the “Power” key on the projector Keypad or on the remote control.

Note:

- *If the “Signal Power On” option is turned “On”, the power consumption of the projector in standby mode will be over 3W.*
- *This function is applicable with HDMI source.*

Auto Power Off (min.)

Sets the countdown timer interval. The countdown timer will start, when there is no signal being sent to the projector. The projector will automatically power off when the countdown has finished (in minutes).

Sleep Timer (min.)

Sets the countdown timer interval. The countdown timer will start, with or without a signal being sent to the projector. The projector will automatically power off when the countdown has finished (in minutes).

Note: *The Sleep Timer is reset every time when the projector is powered off.*

Power Mode (Standby)

Set the power mode setting.

- **Active:** Choose “Active” to return to normal standby.
- **Eco:** Choose “Eco.” to save power dissipation further < 0.5W.

Setup security menu

Security

Enable this function to prompt for a password before using the projector.

- **On:** Choose “On” to use security verification when the turning on the projector.
- **Off:** Choose “Off” to be able to switch on the projector without password verification.

Note: *The default password is 1234.*

Security Timer

Select the time (Month/Day/Hour) function to set the number of hours the projector can be used. Once this time has elapsed you will be requested to enter your password again.

Change Password

Use to set or modify the password that is prompted when turning the projector on.

USING THE PROJECTOR

Setup startup logo menu

Use this function to set the desired startup screen. If changes are made, they will take effect the next time the projector is powered on.

- **Default:** The default startup screen.
- **Neutral:** Logo is not displayed on startup screen.
- **User:** Logo capture tool required.
Note: *Please visit the website to download the logo capture tool.
The supported file format: png/bmp/jpg*

Setup background color menu

Use this function to display a blue, red, green, grey color, none, or logo screen when no signal is available.

Note: *If the background color is set to "None", then the background color is black.*

Setup reset menu

Reset OSD

Return the factory default settings for OSD menu settings.

Reset to Default

Return the factory default settings for all settings.

USING THE PROJECTOR

Input menu

Input auto source menu

Choose this option to let the projector automatically find an available input source.

Input auto input switch menu

When HDMI input signal is detected, the projector will automatically switch the input source.

Input HDMI CEC settings menu

Note: When you connect HDMI CEC-compatible devices to the projector with HDMI cables, you can control them on the same power on or power off status using the HDMI Link control feature in the projector's OSD. This lets one device or multiple devices in a group power on or power off via HDMI Link Feature in a typical configuration, your DVD player may be connected to the projector through an amplifier or home theater system.

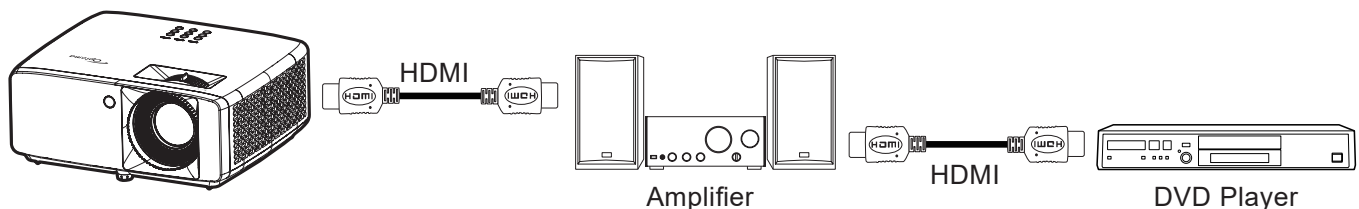

HDMI Link

Enable/disable the HDMI Link function.

Inclusive of TV

If the settings is set to "Yes" then the power on and power off link options are available.

Power On Link

CEC power on command.

- **Mutual:** Both projector and CEC device will be turned on simultaneously.
- **PJ → Device:** The CEC device will be turned on only after the projector is switched on.
- **Device → PJ:** The projector will be switched on only after the CEC device is turned on.

Power Off Link

Enable this function to let both HDMI Link and projector to be automatically turned off at the same time.

Input reset menu

Return the factory default settings for input settings.

USING THE PROJECTOR

Audio menu

Audio volume menu

Adjust the volume level.

Audio mute menu

Use this option to temporarily turn off the sound.

- **On:** Choose “On” to turn mute on.
- **Off:** Choose “Off” to turn mute off.

Note: *“Mute” function affects both internal and external speaker volume.*

Audio reset menu

Return the factory default settings for audio settings.

USING THE PROJECTOR

Control menu

Control device ID menu

ID definition can be set up by menu (range 0-99), and allow user control an individual projector by using RS232 command.

Note: For a full list of RS232 commands, please refer to the RS232 user manual on our website.

Control remote settings menu

IR Function

Set the IR function setting.

- **On:** Choose “On”, the projector can be operated by the remote control from the top and front IR receivers.
- **Off:** Choose “Off”, the projector can't be operated by the remote control. By selecting “Off”, you will be able to use the Keypad keys.

Control keypad settings menu

Keypad Lock

When the keypad lock function is “On”, the Keypad will be locked. However, the projector can be operated by the remote control. By selecting “Off”, you will be able to reuse the Keypad.

Control LAN menu

Configure the projector's network settings.

Network Status

Display the network connection status. (Read only)

MAC Address

Display the MAC address. (Read only)

DHCP

Turn on DHCP to automatically acquire IP address, subnet mask, gateway, and DNS.

IP Address

Assign the projector's IP address.

Subnet Mask

Assign the projector's subnet mask.

Gateway

Assign the projector's gateway.

DNS

Assign the projector's DNS.

USING THE PROJECTOR

How to use web browser to control your projector

1. Turn “On” the DHCP option on projector to allow a DHCP server to automatically assign an IP address.
2. Open the web browser in your PC and type in the projector’s IP address (“Control > LAN > IP Address”).
3. Enter the user name and password, and click “Login”.
The projector’s configuration web interface opens.

Note:

- The default user name and password is “admin”.
- The steps in this section is based on Windows 10 operating system.

Making a direct connection from your computer to the projector*

1. Turn “Off” the DHCP option on the projector.
2. Configure the IP address, Subnet Mask, Gateway, and DNS on projector (“Control > LAN”).
3. Open **Network & Internet** page on your PC, and assign the identical network parameters to your PC as set on projector. Click “OK” to save the parameters.

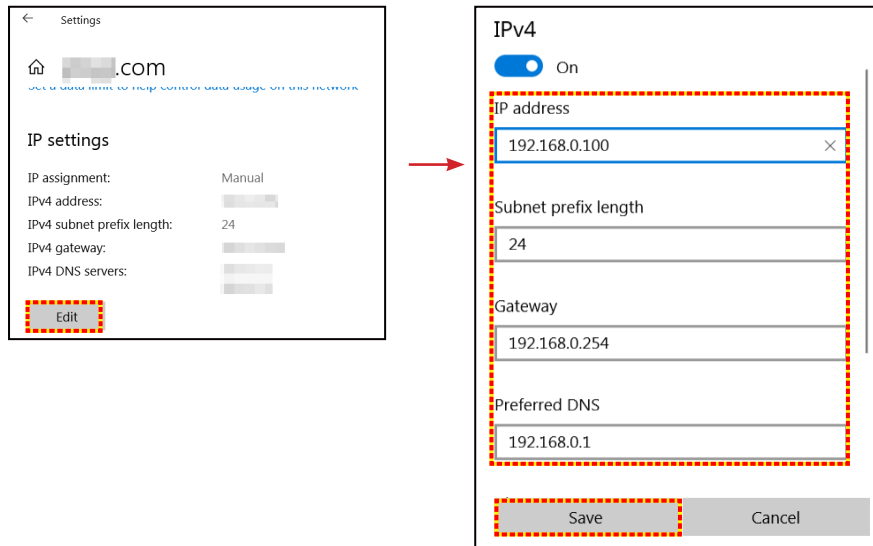

4. Open the web browser on your PC and type in to the URL field the IP address, assigned in step 3. Then press “Enter” key.

Reset

Reset the network settings to default factory values.

USING THE PROJECTOR

Control control menu

This projector can be controlled remotely by a computer or other external devices through the wired network connection. It allows the user to control one or more projectors from a remote control center, such as powering the projector on or off, and adjusting the image brightness or contrast.

Use the Control submenu to select a control device for the projector.

Crestron

Control the projector with Crestron controller and related software. (Port: 41794)

For more information, please visit <http://www.crestron.com>.

Extron

Control the projector with Extron devices. (Port: 2023)

For more information, please visit <http://www.extron.com>.

PJ Link

Control the projector with PJLink v2.0 commands. (Port: 4352)

For more information, please visit <http://pjlink.jbmia.or.jp/english>.

AMX Device Discovery

Control the projector with AMX devices. (Port: 9131)

For more information, please visit <http://www.amx.com>.

Telnet

Control the projector using RS232 commands through Telnet connection. (Port: 23)

For more information, refer to “RS232 by Telnet Function” on page 53.

HTTP

Control the projector with web browser. (Port: 80)

For more information, refer to “How to use web browser to control your projector” on page 44.

Note:

- *Crestron is a registered trademark of Crestron Electronics, Inc. of the United States.*
- *Extron is a registered trademark of Extron Electronics, Inc. of the United States.*
- *AMX is a registered trademark of AMX LLC of the United States.*
- *PJLink applied for trademark and logo registration in Japan, the United States of America, and other countries by JBMIA.*
- *For more information about the various types of external devices which can be connected to the LAN / RJ45 port and remotely control the projector, as well as the supported commands for these external devices, please contact the Support-Service directly.*

USING THE PROJECTOR

Setup network control settings menu

LAN_RJ45 function

For simplicity and ease of operation, the projector provides diverse networking and remote management features. The LAN / RJ45 function of the projector through a network, such as remotely manage: Power On / Off, brightness, and contrast settings. Also, you can view the projector status information, such as: Video- Source, Sound-Mute, etc.

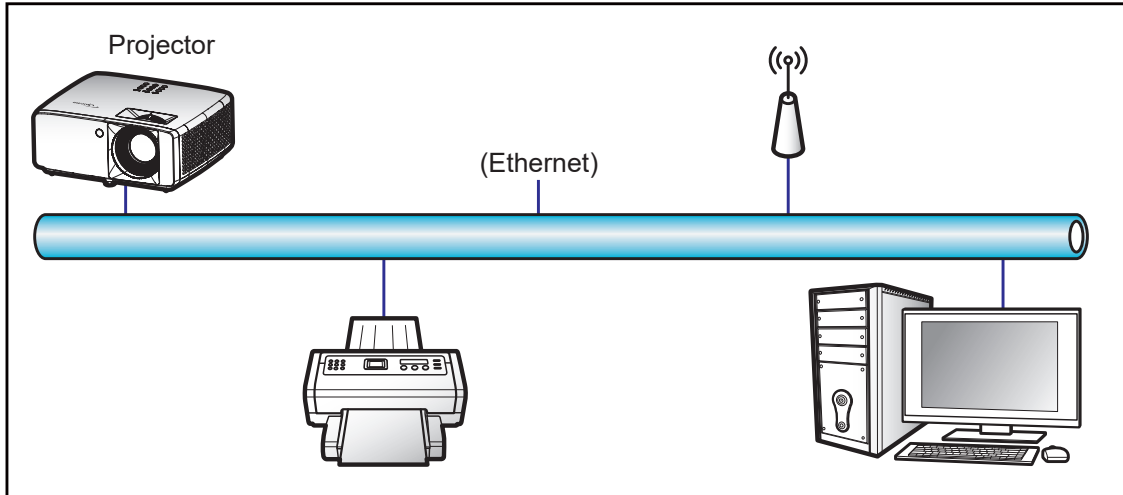

Wired LAN terminal functionalities

This projector can be controlled by using a PC (laptop) or other external device via LAN / RJ45 port and compatible with Crestron / Extron / AMX (Device -Discovery) / PJLink.

- Crestron is a registered trademark of Crestron Electronics, Inc. of the United States.
- Extron is a registered trademark of Extron Electronics, Inc. of the United States.
- AMX is a registered trademark of AMX LLC of the United States.
- PJLink applied for trademark and logo registration in Japan, the United States of America, and other countries by JBMIA.

The projector is supported by the specified commands of the Crestron Electronics controller and related software, for example RoomView®.

<http://www.crestron.com/>

This projector is compliant to support Extron device(s) for reference.

<http://www.extron.com/>

This projector is supported by AMX (Device Discovery).

<http://www.amx.com/>

This projector supports all commands of PJLink Class1 (Version 1.00).

<http://pjlink.jbmia.or.jp/english/>

For more detailed information about the various types of external devices which can be connected to the LAN / RJ45 port and remote control the projector, as well as the supported commands for these external devices, please contact the Support-Service directly.

USING THE PROJECTOR

LAN RJ45

1. Connect an RJ45 cable to RJ45 ports on the projector and the PC (laptop).

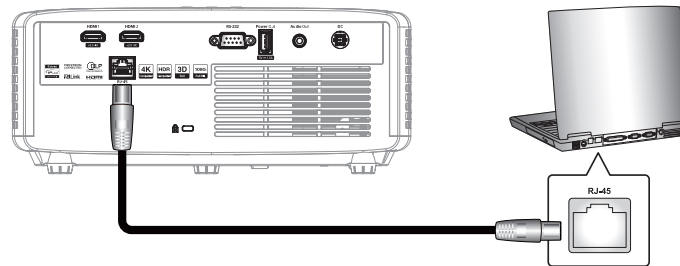

2. On the PC (Laptop), select **Start**  > **Settings**  > **Network & Internet**.

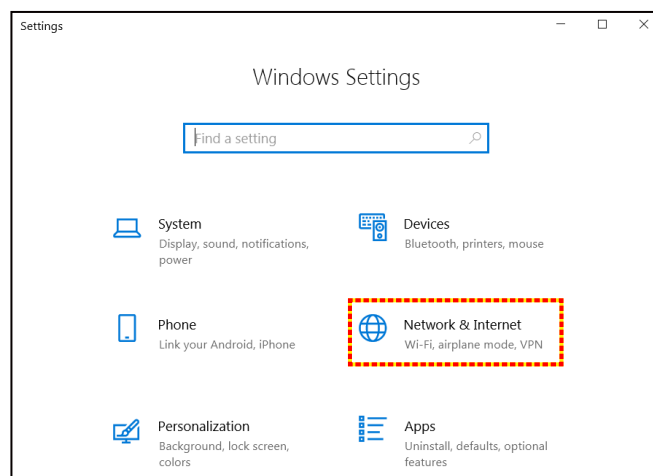

3. In the **Ethernet** section, select **Properties**.

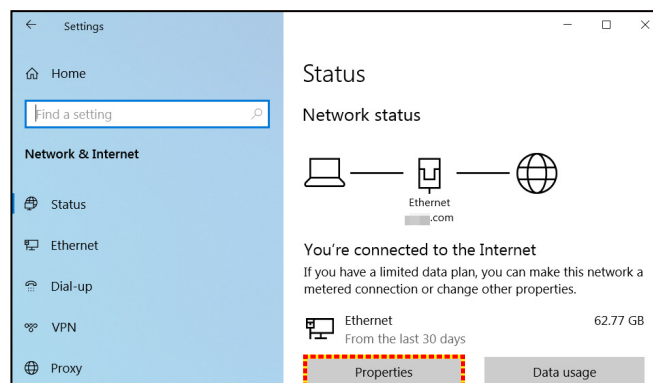

4. In the **IP settings** section, select **Edit**.

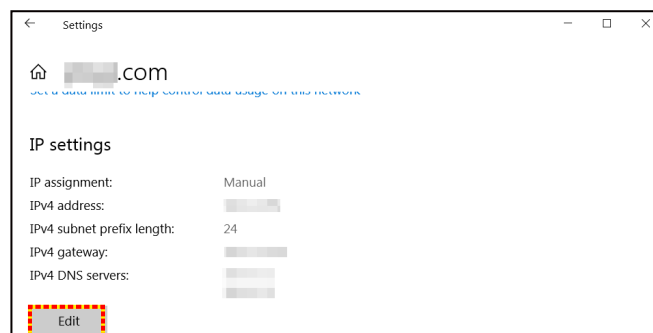

USING THE PROJECTOR

5. Type in the IP address and Gateway, then select “Save”.

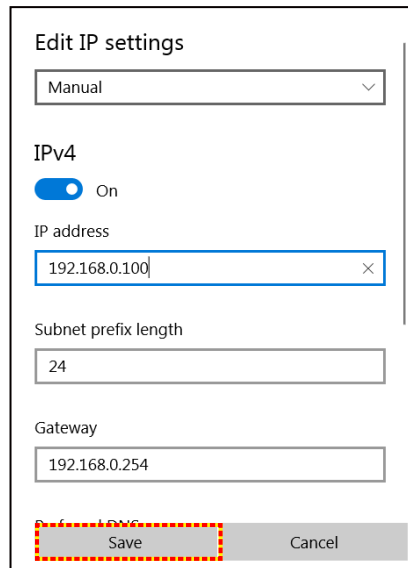

Edit IP settings

Manual

IPv4

On

IP address

192.168.0.100

Subnet prefix length

24

Gateway

192.168.0.254

Save Cancel

6. Press the “Menu” button on the projector.
7. Open on projector **Control > LAN**.
8. Enter the following connection parameters:
 - DHCP: Off
 - IP Address: 192.168.0.100
 - Subnet Mask: 255.255.255.0
 - Gateway: 192.168.0.254
 - DNS: 192.168.0.51
9. Press “Enter” to confirm settings.
10. Open a web browser, for example Microsoft Edge or Chrome with Adobe Flash Player 9.0 or higher installed.
11. In the Address bar, input the projector’s IP address: 192.168.0.100.

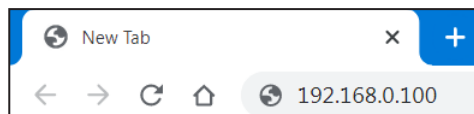

12. Press “Enter”.

USING THE PROJECTOR

The projector is setup for remote management. The LAN / RJ45 function displays as follows:

Log in

When you open the web page for the first time, you will see a screen like the one below. Please enter valid user password.

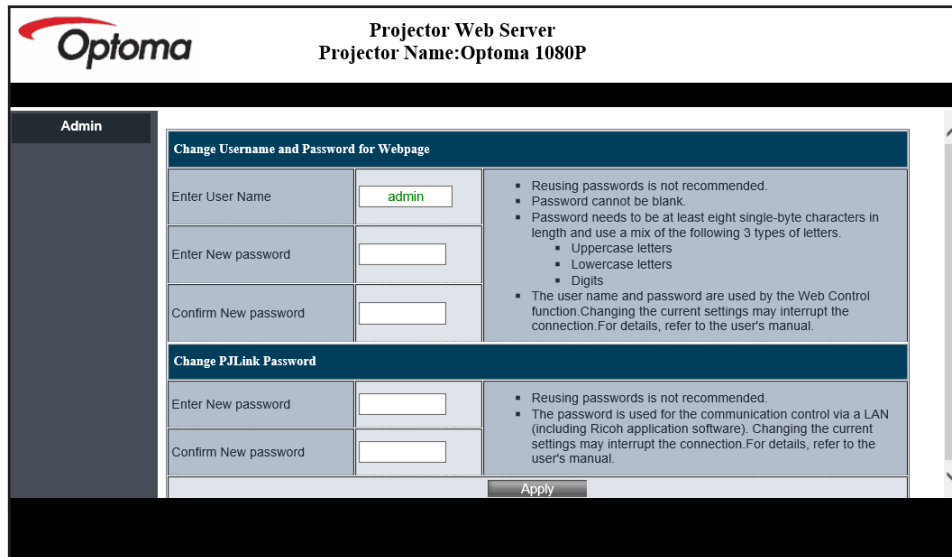

The screenshot shows the 'Projector Web Server' interface for an 'Optoma 1080P' projector. The 'Admin' section is active, displaying two password change forms. The first form, 'Change Username and Password for Webpage', has the 'Enter User Name' field filled with 'admin'. The second form, 'Change PLink Password', is empty. Both forms include an 'Apply' button and a list of password requirements: 'Reusing passwords is not recommended', 'Password cannot be blank', and 'Password needs to be at least eight single-byte characters in length and use a mix of the following 3 types of letters: Uppercase letters, Lowercase letters, Digits'. A note states that the user name and password are used by the Web Control function and that changing settings may interrupt the connection.

When you open the web page after entering a valid password, you will see a screen like the one below. Enter the password in the "Password" field.

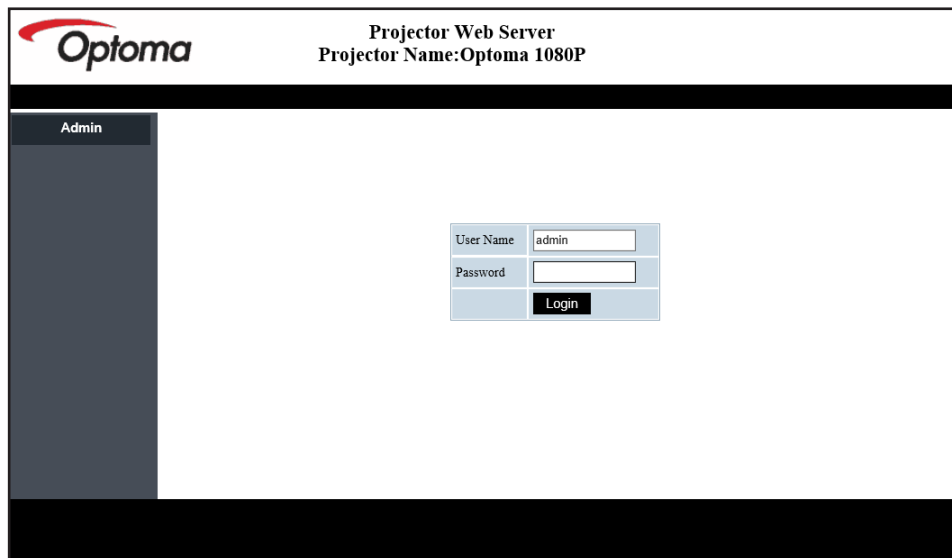

The screenshot shows the 'Projector Web Server' interface for an 'Optoma 1080P' projector. The 'Admin' section is active, displaying a login form with 'User Name' (filled with 'admin') and 'Password' fields, and a 'Login' button.

USING THE PROJECTOR

System Status

The current status of the projector is displayed. You can check projector model name, firmware version, current LAN configuration, and change the interface language if needed.

The version name displayed on the web page in the diagram may differ from the actual display.

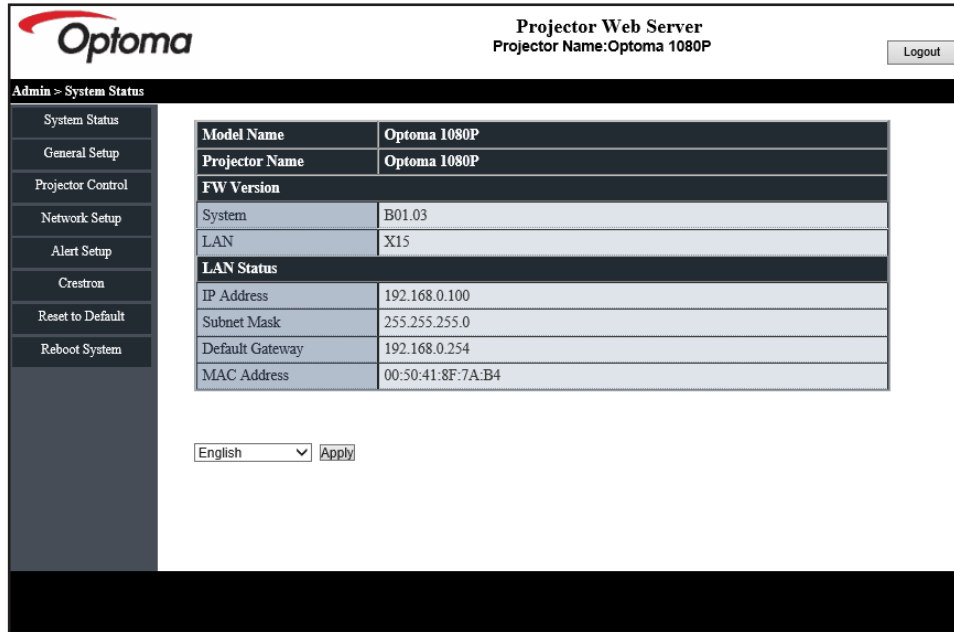

General Setup

The projector name set here is also used in PJLink control. Only alphanumeric characters can be used as projector name. The maximum number of characters is 32.

You can use only alphanumeric characters in the password. The minimum number of characters is 8. If you enter an invalid character, "Invalid Character" warning is displayed.

If the characters of new password and the characters of confirm (new) password do not match, error message will be displayed. In this case, re-enter the password.

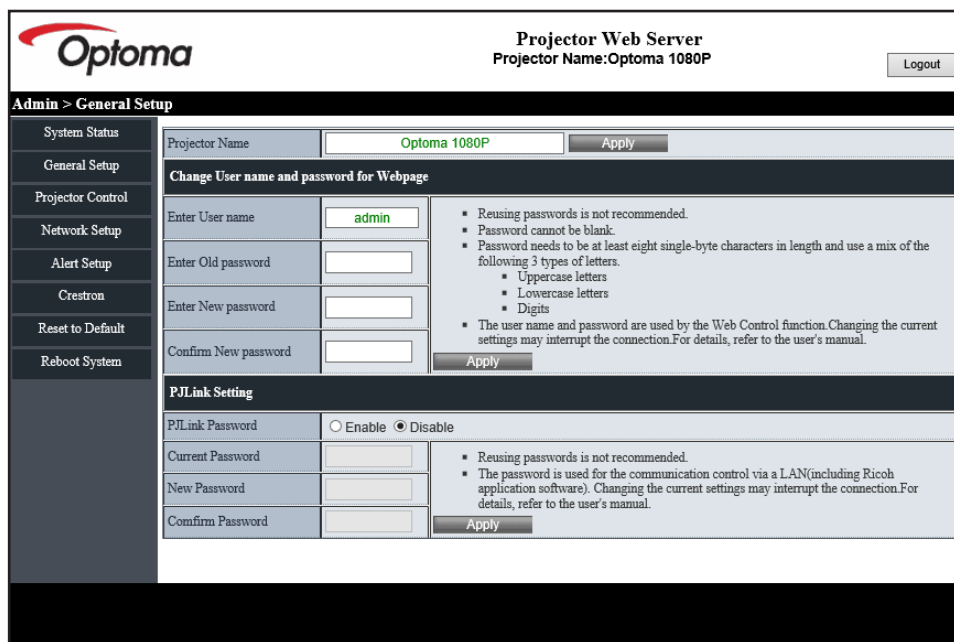

USING THE PROJECTOR

Projector Control

You can control the projector with this item. The items for control are described in this section.

Control button: When you click a button, the corresponding function will be performed.

The screenshot shows the 'Projector Web Server' interface for an Optoma 1080P projector. The page title is 'Projector Web Server' and the projector name is 'Optoma 1080P'. A 'Logout' button is in the top right. The breadcrumb is 'Admin > Projector Control'. A sidebar on the left lists menu items: System Status, General Setup, Projector Control, Network Setup, Alert Setup, Crestron, Reset to Default, and Reboot System. The main content area is titled 'Projector Control' and contains several control panels:

- Power:** Power On, Power Off, Auto Set, Input.
- Source:** Auto Source, AV Mute, Freeze.
- 3D:** 3D Format (Auto), L/R Reverse.
- Image:** Input (HDMI1), Brightness (0), Contrast (0), Sharpness (10), Display Mode (Cinema).
- Audio:** Volume (5).
- Management:** Auto Power Off (Min.) (20), Lamp Power Mode (Bright), Aspect Ratio (4:3).

Network Setup

Set the network of the projector.

The screenshot shows the 'Projector Web Server' interface for an Optoma 1080P projector. The page title is 'Projector Web Server' and the projector name is 'Optoma 1080P'. A 'Logout' button is in the top right. The breadcrumb is 'Admin > Network Setup'. A sidebar on the left lists menu items: System Status, General Setup, Projector Control, Network Setup, Alert Setup, Crestron, Reset to Default, and Reboot System. The main content area is titled 'Network Setup' and contains an 'IP Setup' panel:

- DHCP:** On (selected), Off.
- IP Address:** 192, 168, 0, 100
- Subnet Mask:** 255, 255, 255, 0
- Default Gateway:** 192, 168, 0, 254
- DNS Server:** 192, 168, 0, 51
- Apply:** Button

USING THE PROJECTOR

Alert Setup

You can send email alerts when an error occurs. You can carry out settings for alert mail in this section.

1. Alert types: Check the type of error for which you want to send alert mail.
2. Alert mail notification: Check and perform the following settings:
 - SMTP Setting: Set the following:
 - a) SMTP Server: Server address (server name) (SMTP server)
 - b) From: e-mail address of the sender
 - c) User Name: User name of the mail server
 - d) Password: Mail server password.
 - Email Setting: Set the following:
 - a) Mail Subject
 - b) Mail Content
 - c) To: Enter the e-mail address of the sender.
3. Click "Apply" to fix the value.
4. Enter the IP address of projector in *xxx.xxx.xxx.xxx.
5. Send Test Mail.

When you click [Send Test Mail], test email will be sent. The text will be "Email Test xxx.xxx.xxx.xxx *".

The screenshot shows the 'Alert Setup' page in the Optoma Projector Web Server interface. The page title is 'Projector Web Server' and the projector name is 'Optoma 1080P'. A 'Logout' button is in the top right. The left sidebar contains navigation links: System Status, General Setup, Projector Control, Network Setup, Alert Setup (selected), Crestron, Reset to Default, and Reboot System. The main content area is titled 'Admin > Alert Setup' and contains the following settings:

- Alert Type:** Fan Error, High Temp Warning, Light Source Error
- Alert Mail Notification:** Alert Mail Notification
- SMTP Setting:**
 - SMTP Server: [Text Input]
 - From: [Text Input]
 - User Name: [Text Input]
 - Password: [Text Input]
- Email Setting:**
 - Mail Subject: [Text Input]
 - Mail Content: [Text Area]
 - To: [Text Input]

At the bottom right of the form are two buttons: 'Apply' and 'Send Test Mail'.

USING THE PROJECTOR

RS232 by Telnet Function

As an alternative method of control, this projector has RS232 command control by TELNET for LAN / RJ45 interface.

Quick Start-Guide for “RS232 by Telnet”

- Check and get the IP address on OSD of the projector.
 - Make sure that the PC / laptop can access the web-page of the projector.
 - Make sure that “Windows Firewall” setting is set to disabled in case of “TELNET” function filtering out by PC / laptop.
1. Click on **Search**  and then enter “cmd” as a search word. Press the “Enter” key.

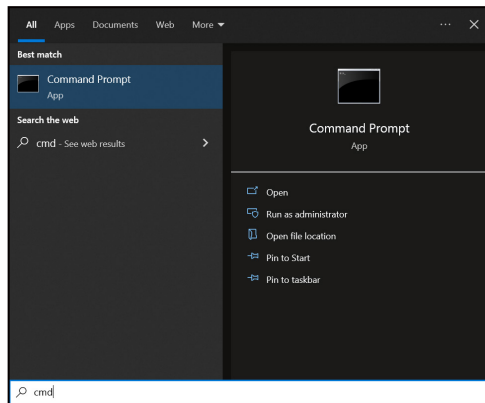

2. Open the Command Prompt app.
3. Input the command format as follows:
 - telnet ttt.xxx.yyy.zzz 23 (“Enter” key pressed)
 - (ttt.xxx.yyy.zzz: IP-Address of the projector)
4. If Telnet-Connection ready, and user can have RS232 command input, then press the “Enter” key and Telnet connection should be ready for RS232 command control.

Specification for “RS232 by TELNET”:

1. Telnet: TCP.
2. Telnet port: 23 (for further details, please contact the Optoma service team).
3. Telnet utility: Windows “TELNET.exe” (console mode).
4. To end the Telnet session, just close the Command Prompt app window.
5. Windows Telnet utility directly after TELNET connection ready.
 - Limitation 1 for Telnet-Control: There cannot be more than 50 bytes for successive network payload for Telnet-Control application.
 - Limitation 2 for Telnet-Control: There cannot be more than 26 bytes for successive RS232 command for Telnet-Control.
 - Limitation 3 for Telnet-Control: Minimum delay for next command must be more than 200 (ms).

Control reset menu

Return the factory default settings for control settings.

USING THE PROJECTOR

Information menu

Information menu

View the projector information as listed below:

- Regulatory
- Serial Number
- Source
- Color Info
- Light Source Hours
- Picture Mode
- Device ID
- Filter Usage Hours
- Light Source Mode
- FW Version

ADDITIONAL INFORMATION

Compatible resolutions

Input Signal for HDMI

Signal	Resolution	Refresh Rate(Hz)	Notes for Mac
VGA	640 x 480	60	Mac 60/72/85/
SVGA	800 x 600	60(*2)/72/85/120(*2)	Mac 60/72/85
XGA	1024 x 768	48/50(*4)/60(*2)/70/75/85/120(*2)	Mac 60/70/75/85
SDTV(480I)	720 x 480	60	
SDTV(480P)	720 x 480	60	
SDTV(576I)	720 x 576	50	
SDTV(576P)	720 x 576	50	
WSVGA(1024x600)	1024 x 600	60 (*3)	
HDTV(720p)	1280 x 720	50(*2)/60/120(*2)	Mac 60
WXGA	1280 x 768	60/75/85	Mac 75
WXGA	1280 x 800	60/50/48hz(*4)	Mac 60
WXGA(*5)	1366 x 768	60	
SXGA	1280 x 1024	60/75/85	Mac 60/75
SXGA	1440 x 900	60	Mac 60/75
SXGA+	1400 x 1050	60	
UXGA	1600 x 1200	60	
HDTV(1080I)	1920 x 1080	50/60	
HDTV(1080p)	1920 x 1080	24/30/50/60	Mac 60
WUXGA	1920 x 1200(*1)	60/50(*4)	Mac 60

Note:

- (*1) 1920 x 1200 @60hz only support RB(reduced blanking).
- (*2) 3D timing for 3D Ready projector(STD) and True 3D projector(Option).
- (*3) New ERA & Data projector must have this timing WSVGA, Proscene and Home is nice to have.
- (*4) Proscene and Data projector >4,000L, Native resolution must support @50Hz/48Hz.
- (*5) Windows 8 standard timing.

ADDITIONAL INFORMATION

True 3D Video Compatibility

Input resolutions	HDMI 1.4a 3D Input	Input timing		
		1280 x 720P @ 50Hz	Top-and-Bottom	
		1280 x 720P @ 60Hz	Top-and-Bottom	
		1280 x 720P @ 50Hz	Frame packing	
		1280 x 720P @ 60Hz	Frame packing	
		1920 x 1080i @ 50Hz	Side-by-Side(Half)	
		1920 x 1080i @ 60Hz	Side-by-Side(Half)	
		1920 x 1080P @ 24Hz	Top-and-Bottom	
		1920 x 1080P @ 24Hz	Frame packing	
		HDMI 1.3	1920 x 1080i @ 50Hz	Side-by-Side(Half)
	1920 x 1080i @ 60Hz			
	1280 x 720P @ 50Hz			
	1280 x 720P @ 60Hz			
	800 x 600 @ 60Hz			
	1024 x 768 @ 60Hz			
	1280 x 800 @ 60Hz		Top-and-Bottom	TAB mode is on
	1920 x 1080i @ 50Hz			
	1920 x 1080i @ 60Hz			
	1280 x 720P @ 50Hz			
	1280 x 720P @ 60Hz			
800 x 600 @ 60Hz				
1024 x 768 @ 60Hz	Frame Sequential	3D format is Frame sequential		
1280 x 800 @ 60Hz				
1024 x 768 @ 120Hz				
1280x 720 @ 120Hz				

Note:

- If 3D input is 1080p@24hz, the DMD should replay with integral multiple with 3D mode
- 1080i@25Hz and 720p@50Hz will run in 100Hz; other 3D timing will run in 120Hz.
- 1080p@24Hz will run 144Hz.

ADDITIONAL INFORMATION

EDID (Digital)

WXGA				
B0 / Established Timing	B0 / Standard Timing	B0 / Detail Timing	B1 / Video Mode	B1 / Detail Timing
640 x 480 @ 60Hz	1600 x 1200 @ 60Hz	Native timing:	640 x 480p @ 60Hz	1280 x 800p @ 120Hz
640 x 480 @ 67Hz	1440 x 900 @ 60Hz	1280 x 800 @ 60Hz	720(1440) x 480i @ 60Hz	1366 x 768 @ 60Hz
640 x 480 @ 72Hz	1280 x 720 @ 60Hz		720(1440) x 576i @ 50Hz	1920 x 1080p @ 50Hz
640 x 480 @ 75Hz	1280 x 800 @ 60Hz		720 x 480p @ 60Hz	1920 x 1080p @ 60Hz
800 x 600 @ 56Hz	640 x 480 @ 120Hz		720 x 576p @ 50Hz	
800 x 600 @ 60Hz	800 x 600 @ 120Hz		1280 x 720p @ 60Hz	
800 x 600 @ 72Hz	1024 x 768 @ 120Hz		1280 x 720p @ 50Hz	
800 x 600 @ 75Hz	1280 x 720 @ 120Hz		1920 x 1080i @ 60Hz	
1024 x 768 @ 60Hz			1920 x 1080i @ 50Hz	
1024 x 768 @ 70Hz			1920 x 1080p @ 60Hz	
1024 x 768 @ 75Hz			1920 x 1080p @ 50Hz	
1280 x 1024 @ 75Hz			1920 x 1080p @ 24Hz	
1152 x 870 @ 75Hz			1920 x 1080p @ 25Hz	
			1920 x 1080p @ 30Hz	

1080p				
B0 / Established Timing	B0 / Standard Timing	B0 / Detail Timing	B1 / Video Mode	B1 / Detail Timing
640 x 480 @ 60Hz	1280 x 1024 @ 60Hz	Native timing:	720(1440) x 480i @ 60Hz 4:3	3840 x 2160p @ 60Hz
640 x 480 @ 67Hz	1400 x 1050 @ 60Hz	1920 x 1080p @ 60Hz	720(1440) x 576i @ 50 Hz 4:3	
640 x 480 @ 72Hz	1024 x 768 @ 120Hz		720 x 480p @ 60 Hz 4:3	
640 x 480 @ 75Hz	1280 x 720 @ 60Hz		720 x 576p @ 50 Hz 4:3	
800 x 600 @ 56Hz	1280 x 720 @ 120Hz		1280 x 720p @ 60 Hz 16:9	
800 x 600 @ 60Hz	1280 x 800 @ 60Hz		1280 x 720p @ 50 Hz 16:9	
800 x 600 @ 72Hz	1440 x 900 @ 60Hz		1920 x 1080i @ 60 Hz 16:9	
800 x 600 @ 75Hz	1600 x 1200 @ 60Hz		640 x 480p @ 60 Hz 4:3	
1024 x 768 @ 60Hz			1920 x 1080p @ 60 Hz 16:9	
1024 x 768 @ 70Hz			1920 x 1080p @ 50 Hz 16:9	
1024 x 768 @ 75Hz			1920 x 1080p @ 24 Hz 16:9	
1280 x 1024 @ 75Hz			1920 x 1080p @ 30 Hz 16:9	
1152 x 870 @ 75Hz			1920 x 1080p @ 120 Hz 16:9	
			3840 x 2160p @ 24 Hz 16:9	
			3840 x 2160p @ 25 Hz 16:9	
			3840 x 2160p @ 30 Hz 16:9	
			3840 x 2160p @ 50 Hz 16:9	
			3840 x 2160p @ 60 Hz 16:9	
			4096 x 2160p @ 24 Hz 256:135	
			4096 x 2160p @ 25 Hz 256:135	
			4096 x 2160p @ 30 Hz 256:135	
			4096 x 2160p @ 50 Hz 256:135	
			4096 x 2160p @ 60 Hz 256:135	

ADDITIONAL INFORMATION

1080p				
B0 / Established Timing	B0 / Standard Timing	B0 / Detail Timing	B1 / Video Mode	B1 / Detail Timing
			720 x 480p @ 60 Hz 16:9	
			720(1440) x 480i @ 60 Hz 16:9	
			720 x 576p @ 50 Hz 16:9	
			2880 x 480i @ 60 Hz 16:9	
			1440 x 480p @ 60 Hz 16:9	
			2880 x 576i @ 50 Hz 16:9	
			1440 x 576p @ 50 Hz 16:9	
			720(1440) x 576i @ 50 Hz 16:9	

ADDITIONAL INFORMATION

Image size and projection distance

WXGA model

Diagonal Length Size of (16:10) Screen	Screen Size (W x H)				Projection Distance (D)				Offset (Hd)	
	(m)		(inch)		(m)		(feet)		(m)	(inch)
	Width	Height	Width	Height	Wide	Tele	Wide	Tele		
30	0.65	0.40	25.44	15.90	0.77	1.00	2.52	3.27	0.05	1.91
40	0.86	0.54	33.92	21.20	1.02	1.33	3.36	4.36	0.06	2.54
50	1.08	0.67	42.40	26.50	1.28	1.66	4.19	5.46	0.08	3.18
60	1.29	0.81	50.88	31.80	1.53	2.00	5.03	6.55	0.10	3.82
70	1.51	0.94	59.36	37.10	1.79	2.33	5.87	7.64	0.11	4.45
80	1.72	1.08	67.84	42.40	2.05	2.66	6.71	8.73	0.13	5.09
90	1.94	1.21	76.32	47.70	2.30	2.99	7.55	9.82	0.15	5.72
100	2.15	1.35	84.80	53.00	2.56	3.33	8.39	10.91	0.16	6.36
120	2.58	1.62	101.76	63.60	3.07	3.99	10.07	13.09	0.19	7.63
150	3.23	2.02	127.20	79.50	3.84	4.99	12.58	16.37	0.24	9.54
180	3.88	2.42	152.64	95.40	4.60	5.99	15.10	19.64	0.29	11.45
200	4.31	2.69	169.60	106.00	5.11	6.65	16.78	21.82	0.32	12.72
250	5.38	3.37	212.00	132.50	6.39	8.31	20.97	27.28	0.40	15.90
300	6.46	4.04	254.40	159.00	7.67	9.98	25.16	32.73	0.48	19.08

Note:

- Zoom Ratio: 1.3x
- Vertical lens shift values are based on the center of the projection lens, if calculated base to the center of the projection lens. All vertical lens shift values must add 5.2cm (2.05 inch).

1080p model

Diagonal Length Size of (16:10) Screen	Screen Size (W x H)				Projection Distance (D)				Offset (Hd)	
	(m)		(inch)		(m)		(feet)		(m)	(inch)
	Width	Height	Width	Height	Wide	Tele	Wide	Tele		
30	0.66	0.37	26.15	14.71	0.75	0.98	2.46	3.20	0.06	2.35
40	0.89	0.50	34.86	19.61	1.00	1.30	3.28	4.27	0.08	3.14
50	1.11	0.62	43.58	24.51	1.25	1.63	4.10	5.34	0.10	3.92
60	1.33	0.75	52.29	29.42	1.50	1.95	4.92	6.41	0.12	4.71
70	1.55	0.87	61.01	34.32	1.75	2.28	5.75	7.47	0.14	5.49
80	1.77	1.00	69.73	39.22	2.00	2.60	6.57	8.54	0.16	6.28
90	1.99	1.12	78.44	44.12	2.25	2.93	7.39	9.61	0.18	7.06
100	2.21	1.25	87.16	49.03	2.50	3.25	8.21	10.68	0.20	7.84
120	2.66	1.49	104.59	58.83	3.00	3.91	9.85	12.81	0.24	9.41
150	3.32	1.87	130.74	73.54	3.75	4.88	12.31	16.02	0.30	11.77
180	3.98	2.24	156.88	88.25	4.50	5.86	14.77	19.22	0.36	14.12
200	4.43	2.49	174.32	98.05	5.00	6.51	16.41	21.35	0.40	15.69
250	5.53	3.11	217.89	122.57	6.25	8.14	20.52	26.69	0.50	19.61
300	6.64	3.74	261.47	147.08	7.50	9.76	24.62	32.03	0.60	23.53

Note:

- Zoom Ratio: 1.3x
- Vertical lens shift values are based on the center of the projection lens, if calculated base to the center of the projection lens. All vertical lens shift values must add 5.2cm (2.05 inch).

ADDITIONAL INFORMATION

1080p Short Throw model

Diagonal Length Size of (16:9) Screen	Screen Size (W x H)				Projection Distance (D)				Offset (Hd)	
	(m)		(inch)		(m)		(feet)		(m)	(inch)
	Width	Height	Width	Height	Wide	Tele	Wide	Tele		
36	0.80	0.45	31.38	17.65	0.40	0.40	N/A	1.31	0.07	2.76
40	0.89	0.50	34.86	19.60	0.40	0.40	1.31	1.31	0.08	3.15
50	1.11	0.62	43.58	24.50	0.50	0.50	1.64	1.64	0.10	3.94
60	1.33	0.75	52.29	29.40	0.70	0.70	2.30	2.30	0.12	4.72
70	1.55	0.87	61.01	34.30	0.80	0.80	2.62	2.62	0.14	5.51
80	1.77	1.00	69.73	39.20	0.90	0.90	2.95	2.95	0.16	6.30
90	1.99	1.12	78.44	44.10	1.00	1.00	3.28	3.28	0.18	7.09
100	2.21	1.25	87.16	49.00	1.10	1.10	3.61	3.61	0.19	7.48
120	2.66	1.49	104.59	58.80	1.30	1.30	4.27	4.27	0.24	9.45
150	3.32	1.87	130.74	73.50	1.60	1.60	5.25	5.25	0.30	11.81
180	3.98	2.24	156.88	88.20	2.00	2.00	6.56	6.56	0.36	14.17
200	4.43	2.49	174.32	98.10	2.20	2.20	7.22	7.22	0.40	15.75
250	5.53	3.11	217.89	122.60	2.70	2.70	8.86	8.86	0.50	19.69
292	6.46	3.64	254.50	143.20	3.20	3.20	10.50	10.50	0.58	22.83

Note:

- Zoom Ratio: 1.0x
- Vertical lens shift values are based on the center of the projection lens, if calculated base to the center of the projection lens. All vertical lens shift values must add 5.2cm (2.05 inch).

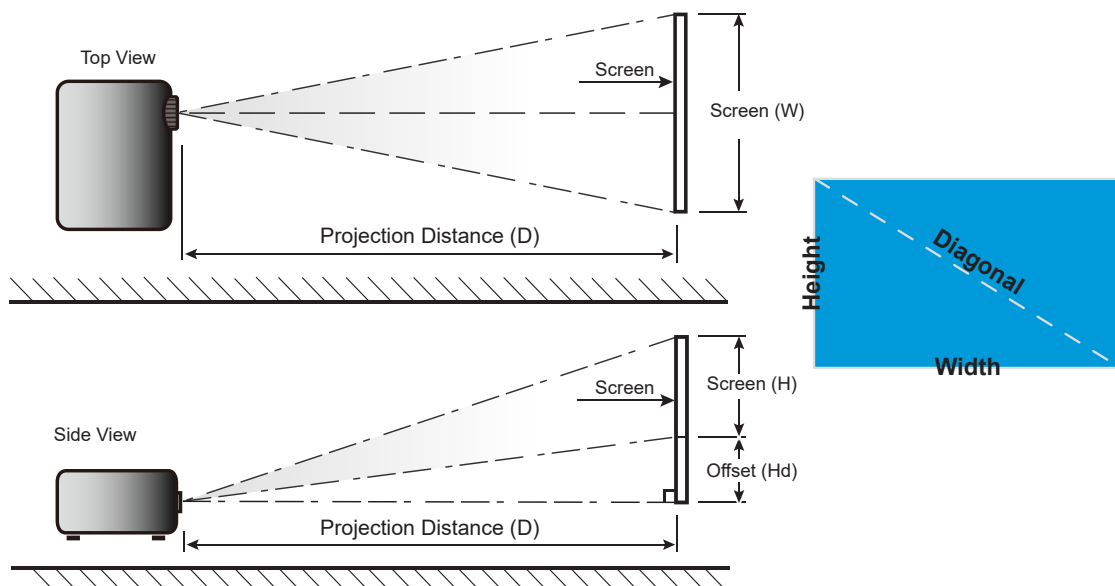

ADDITIONAL INFORMATION

Projector dimensions and ceiling mount installation

1. To prevent damage to your projector, please use the Optoma ceiling mount.
2. If you wish to use a third party ceiling mount kit, please ensure the screws used to attach a mount to the projector meet the following specifications:
 - Screw type: M4*10mm
 - Minimum screw length: 10mm

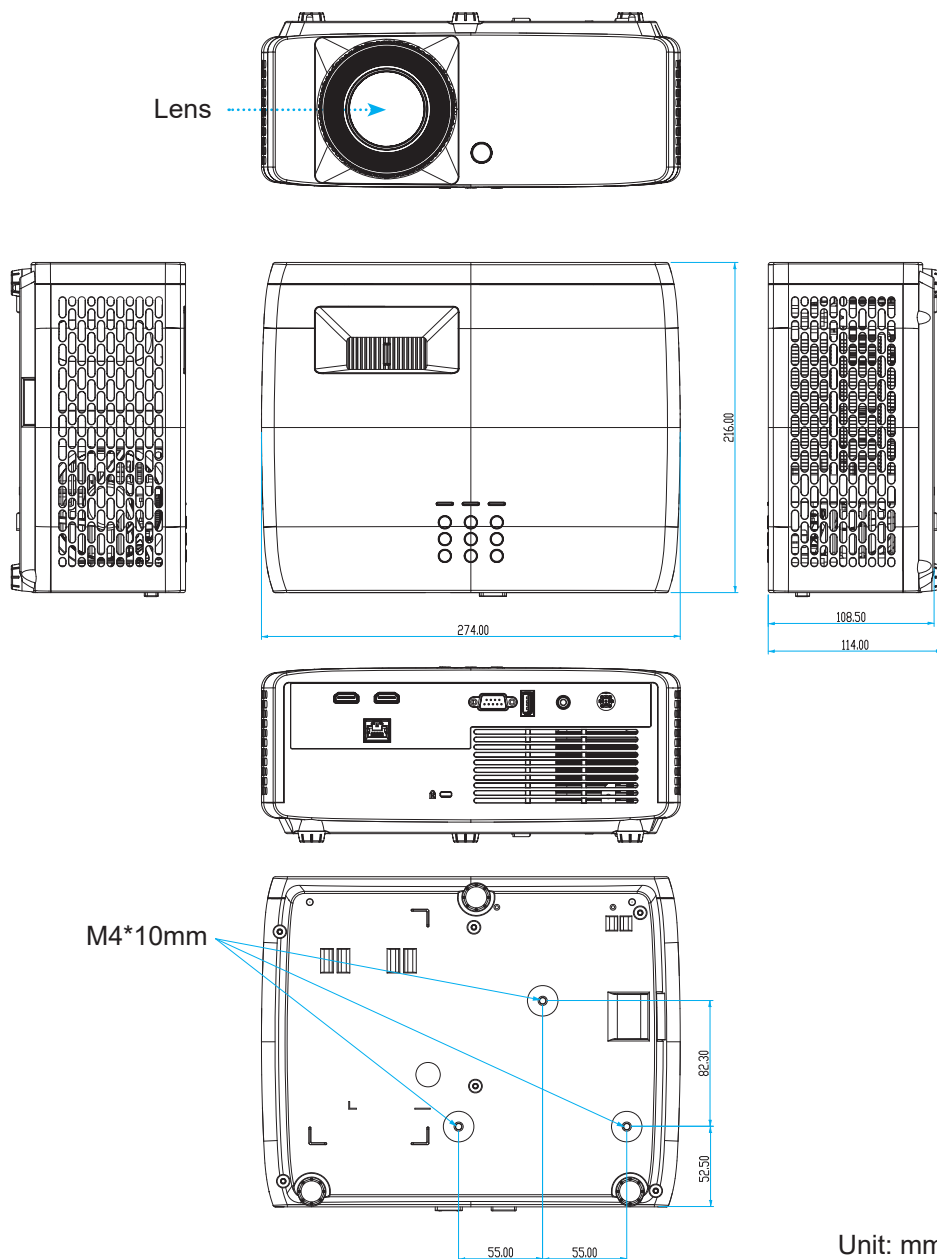

Note: Please note that damage resulting from incorrect installation will void the warranty.



Warning:

- If you buy a ceiling mount from another company, please be sure to use the correct screw size. Screw size will vary depending on the thickness of the mounting plate.
- Be sure to keep at least 10 cm gap between the ceiling and the bottom of the projector.
- Avoid installing the projector near a heat source.

ADDITIONAL INFORMATION

For ceiling mounting, you could purchase a cable tie whose length is over 250mm to fix the AC adapter if needed.

1. Install the cable tie to the designated holes on the bottom of the projector. Then place the AC adapter onto its slot.

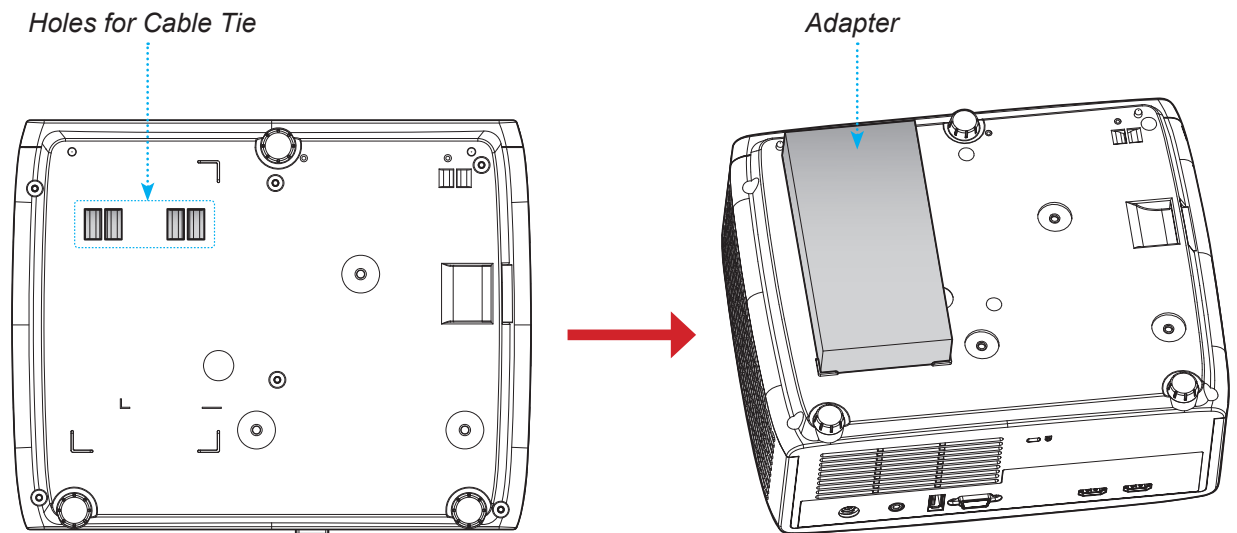

2. Secure the AC adapter with the cable tie.

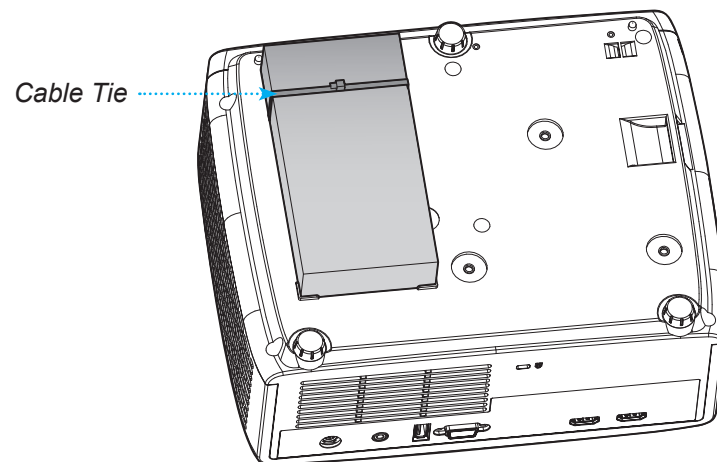





ADDITIONAL INFORMATION

IR remote control codes



Key	NEC format	Customer Code		Key Code		Description	
		Byte 1	Byte 2	Byte 3	Byte 4		
Power		Format 1	32	CD	02	FD	Press to turn on / off the projector.
Aspect ratio		Format 1	32	CD	64	9B	Press to change the aspect ratio of a displayed image.
Source		Format 1	32	CD	C3	3C	Press to select an input signal.
Mode		Format 1	32	CD	5	FA	Press to change the Picture mode of a displayed image.
Four directional select keys (Up)	^	Format 2	32	CD	11	EE	Press to select items or make adjustments to your selection.
Four directional select keys (Left)	<	Format 2	32	CD	10	EF	
Four directional select keys (Right)	>	Format 2	32	CD	12	ED	
Four directional select keys (Down)	v	Format 2	32	CD	14	EB	
Enter	o	Format 1	32	CD	0F	F0	Confirm your item selection.
Settings/Setup Menu		Format 1	32	CD	A8	57	Press to enter the Setup menu.
Return		Format 1	32	CD	0D	F2	Press to return to the previous menu.
Menu		Format 1	32	CD	0E	F1	Press to display or exit the on-screen display menus.
Volume -		Format 2	32	CD	8F	70	Press to decrease the volume.
Mute		Format 1	32	CD	52	AD	Press to momentarily turn off / on the audio.

ADDITIONAL INFORMATION







Key		NEC format	Customer Code		Key Code		Description
			Byte 1	Byte 2	Byte 3	Byte 4	
Volume +		Format 2	32	CD	8C	73	Press to increase the volume.
Freeze		Format 1	32	CD	06	F9	Press to freeze the projector image.
Keystone		Format 1	32	CD	7	F8	Press to adjust image distortion caused by tilting the projector.
AV Mute		Format 1	32	CD	03	FC	Press to hide / unhide the screen picture and turn off / on audio.

ADDITIONAL INFORMATION

Troubleshooting

If you experience a problem with your projector, please refer to the following information. If a problem persists, please contact your local reseller or service center.

Image problems

-  *No image appears on-screen*
- Ensure all the cables and power connections are correctly and securely connected as described in the "Installation" section.
 - Ensure the pins of connectors are not crooked or broken.
 - Ensure that the "Mute" feature is not turned on.
-  *Image is out of focus*
- Turn the focus ring clockwise or counterclockwise until the image is sharp and legible. (Please see page 18).
 - Make sure the projection screen is between the required distance from the projector. (Please refer to pages 59~60).
-  *The image is stretched when displaying 16:9 DVD title*
- When you play anamorphic DVD or 16:9 DVD, the projector will show the best image in 16: 9 format on projector side.
 - If you play the V-Stretch format DVD title, please change the format as V-Stretch in projector OSD.
 - If you play 4:3 format DVD title, please change the format as 4:3 in projector OSD.
 - Please setup the display format as 16:9 (wide) aspect ratio type on your DVD player.
-  *Image is too small or too large*
- Turn the zoom lever clockwise or counterclockwise to increase or decrease the projected image size. (Please see page 18).
 - Move the projector closer to or further from the screen.
 - Press "Menu" on the projector panel, go to "Display → Aspect Ratio". Try the different settings.
-  *Image has slanted sides:*
- If possible, reposition the projector so that it is centered on the screen and below the bottom of the screen.
-  *Image is reversed*
- Select "Display → Projection Orientation" from the OSD and adjust the projection direction.

ADDITIONAL INFORMATION

Other problems



The projector stops responding to all controls

- If possible, turn off the projector, then unplug the power cord and wait at least 20 seconds before reconnecting power.

Remote control problems



If the remote control does not work

- Check the operating angle of the remote control is pointed within $\pm 15^\circ$ to the IR receiver on the projector.
- Make sure there are not any obstructions between the remote control and the projector. Move to within 6 m (19.7 ft) of the projector.
- Make sure batteries are inserted correctly.
- Replace batteries if they are exhausted.

ADDITIONAL INFORMATION

Warning indicators

When the warning indicators (see below) light up or flash, the projector will automatically shutdown:

- “Lamp” LED indicator is lit red and if “Power” indicator flashes red.
- “Temp” LED indicator is lit red and if “Power” indicator flashes red. This indicates the projector has overheated. Under normal conditions, the project can be switched back on.
- “Temp” LED indicator flashes red and if “Power” indicator flashes red.

Unplug the power cord from the projector, wait for 30 seconds and try again. If the warning indicator lights up or flashes, please contact your nearest service center for assistance.

LED lightning messages

Message	Power LED		Temp LED	Lamp LED
	(Red)	(Green or Blue)	(Red)	(Red)
Standby state (Input power cord)	Steady light			
Power on (Warming)		Flashing (0.5 sec off / 0.5 sec on)		
Power on and Lamp lighting		Steady light		
Power off (Cooling)		Flashing (0.5 sec off / 0.5 sec on). Back to red steady light when cooling fan turns off.		
Error (Lamp failure)	Flashing			Steady light
Error (Fan failure)	Flashing		Flashing	
Error (Over temp.)	Flashing		Steady light	

- Power off:

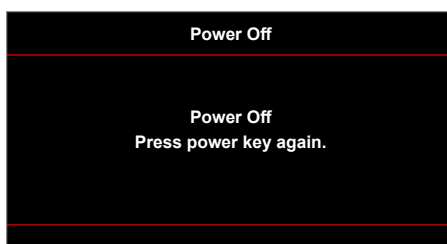

- Temperature warning:

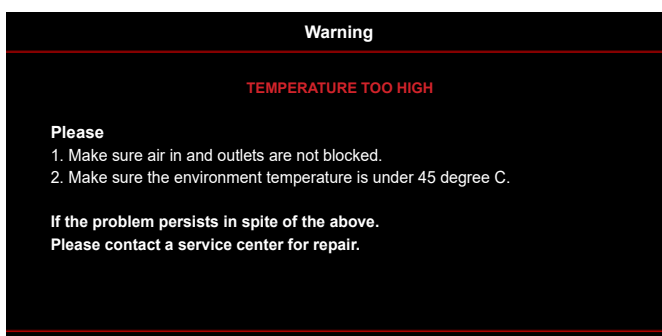

ADDITIONAL INFORMATION

Specifications

Item	Description	
Technology	<ul style="list-style-type: none"> • WXGA: Texas Instrument DMD, 0.65" S450 DMD • 1080p: Texas Instrument DMD, 0.65" S600 DMD 	
Native Resolution	<ul style="list-style-type: none"> • WXGA: 1280 x 800 • 1080p: 1920 x 1080 	
Lens	Throw ratio	<ul style="list-style-type: none"> • WXGA: 1.187~1.544 • 1080p: 1.13~1.47
	F-stop	2.43~2.78
	Focal length	16.9~21.61mm
	Zoom range	1.3x
Offset	<ul style="list-style-type: none"> • WXGA: 112% @60", tolerance $\pm 5\%$ • 1080p: 116% @60", tolerance $\pm 5\%$ 	
Image size	<ul style="list-style-type: none"> • WXGA: Optimized at 60" wide @1.53m • 1080p: Optimized at 60" wide @1.5m 	
Projection distance	<ul style="list-style-type: none"> • WXGA: 1.2m to 7.7m mechanism travel, 1.3m to 3m optical optimized range • 1080p: 1m to 8m mechanism travel, 1.3m to 3m optical optimized range 	
I/Os	<ul style="list-style-type: none"> • HDMI 1 <ul style="list-style-type: none"> • WXGA model: HDMI 1.4b, HDCP 2.0 • 1080p model: HDMI 2.0, HDCP 2.2 • HDMI 2 <ul style="list-style-type: none"> • WXGA model: HDMI 1.4b, HDCP 2.0 • 1080p model: HDMI 2.0, HDCP 2.2 • USB Type-A for firmware upgrade and power USB 5V/1.5A • Audio Out 3.5mm • RS232 • LAN 	
Colour	1073.4 Million color	
Scan rate	<ul style="list-style-type: none"> • Horizontal scan rate: 15KHz ~ 140KHz • Vertical scan rate: 24Hz ~ 120Hz 	
Speaker	15W	
Power consumption	<ul style="list-style-type: none"> • ECO mode: 160W (typical) @110VAC; 158W @220VAC • Bright mode: 225W (typical) @110VAC; 220W @220VAC 	
Input current	DC 19.5V, 10.5A	
Installation orientations	Front, Rear, Ceiling, Rear-top	
Dimensions (W x D x H)	<ul style="list-style-type: none"> • Without feet: 274 x 216 x 108.5 mm • With feet: 274 x 216 x 114 mm 	
Weight	2.9 \pm 0.2 kg	
Environmental	Operating in 0~40°C, 80% humidity (max., non-condensing)	

Note: All specifications are subject to change without notice.



ADDITIONAL INFORMATION

Optoma global offices

For service or support, please contact your local office.



USA

Optoma Technology, Inc.
47697 Westinghouse Drive.
Fremont, Ca 94539

 888-289-6786
 510-897-8601
 services@optoma.com



Canada

Optoma Technology, Inc.
47697 Westinghouse Drive.
Fremont, Ca 94539

 888-289-6786
 510-897-8601
 services@optoma.com



Latin America

Optoma Technology, Inc.
47697 Westinghouse Drive.
Fremont, Ca 94539

 888-289-6786
 510-897-8601
 services@optoma.com



Europe

Unit 1, Network 41, Bourne End Mills
Hemel Hempstead, Herts,
HP1 2UJ, United Kingdom
www.optoma.eu
Service Tel : +44 (0)1923 691865

 +44 (0) 1923 691 800
 +44 (0) 1923 691 888
 service@tsc-europe.com



Benelux BV

Randstad 22-123
1316 BW Almere
The Netherlands
www.optoma.nl

 +31 (0) 36 820 0252
 +31 (0) 36 548 9052

France

Bâtiment E
81-83 avenue Edouard Vaillant
92100 Boulogne Billancourt, France

 +33 1 41 46 12 20
 +33 1 41 46 94 35
 savoptoma@optoma.fr



Spain

C/ José Hierro,36 Of. 1C
28522 Rivas VaciaMadrid,
Spain

 +34 91 499 06 06
 +34 91 670 08 32



Deutschland

Am Nordpark 3
41069 Mönchengladbach
Germany

 +49 (0) 2161 68643 0
 +49 (0) 2161 68643 99
 info@optoma.de

Scandinavia

Lerpeveien 25
3040 Drammen
Norway

 +47 32 98 89 90
 +47 32 98 89 99
 info@optoma.no

PO.BOX 9515
3038 Drammen
Norway

Korea

<https://www.optoma.com/kr/>

Japan



<https://www.optoma.com/jp/>

Taiwan

<https://www.optoma.com/tw/>

China

Room 2001, 20F, Building 4,
No.1398 Kaixuan Road,
Changning District
Shanghai, 200052, China

 +86-21-62947376
 +86-21-62947375
www.optoma.com.cn

Australia

<https://www.optoma.com/au/>

