

# FUJITSU Display

## B24-9 WE / B24-9 WS

---

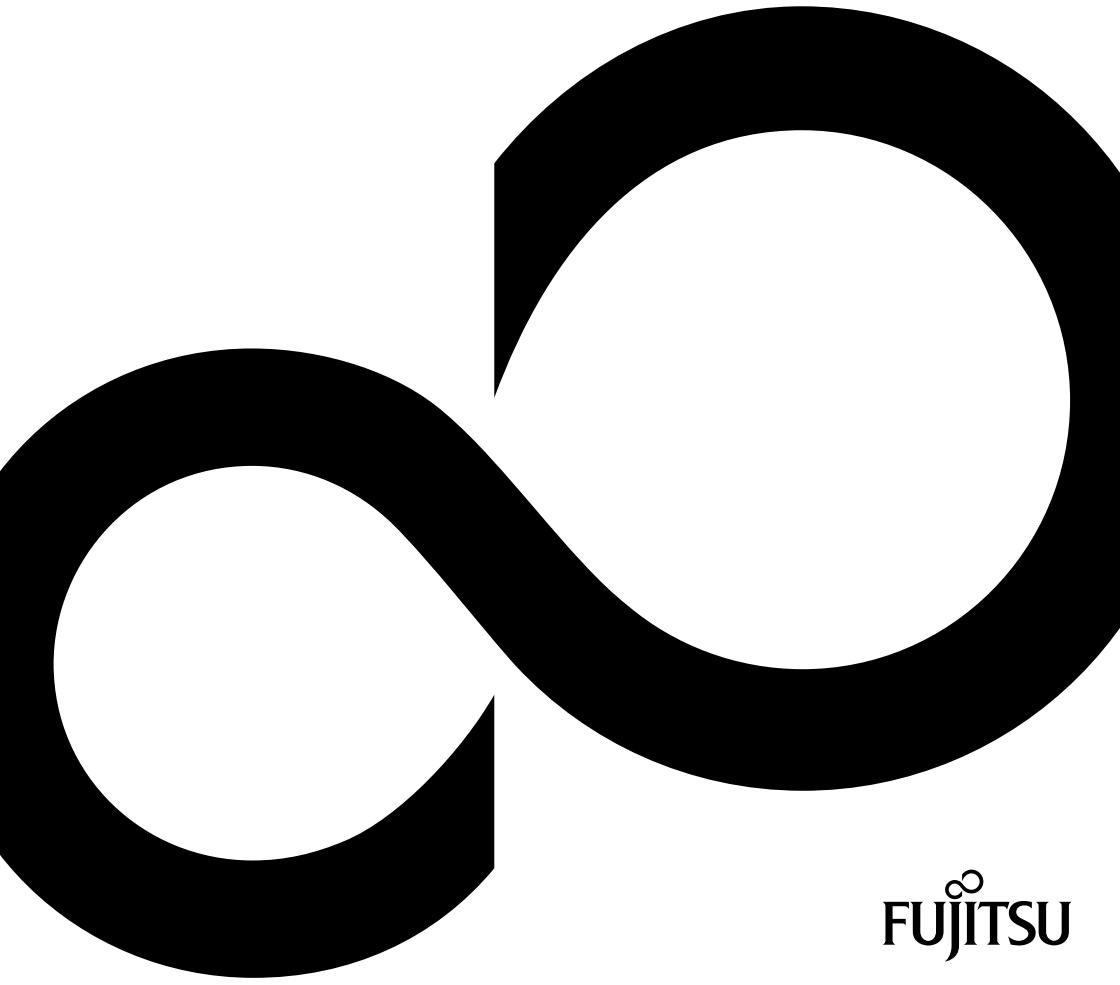

# Congratulations on your purchase of an innovative product from Fujitsu.

Latest information about our products, tips, updates etc. can be found on the Internet at: ["http://www.fujitsu.com/fts/"](http://www.fujitsu.com/fts/)

You can find driver updates at: ["http://support.ts.fujitsu.com/download"](http://support.ts.fujitsu.com/download)

Should you have any technical questions, please contact:

- our Hotline/Service Desk (["http://support.ts.fujitsu.com/contact/service desk"](http://support.ts.fujitsu.com/contact/service desk))
- Your sales partner
- Your sales office

We hope you enjoy working with your new Fujitsu system!





**Published by / Contact address in the EU**

Fujitsu Technology Solutions GmbH

Mies-van-der-Rohe-Straße 8

80807 Munich, Germany

["http://www.fujitsu.com/fts/"](http://www.fujitsu.com/fts/)

**Copyright**

© Fujitsu Technology Solutions GmbH 2018. All rights reserved.

**Publication Date**

09/2018

Order No.: A26361-K1684-Z320-1-7619, edition 1

# **FUJITSU Display**

## **B24-9 WE / B24-9 WS**

### **Operating Manual**

<b>Your LCD screen...</b>	<b>5</b>
<b>Important notes</b>	<b>7</b>
<b>Getting started</b>	<b>11</b>
<b>Operation</b>	<b>19</b>
<b>Driver installation</b>	<b>37</b>
<b>Notes on power management</b>	<b>38</b>
<b>Notes on low blue light mode</b>	<b>39</b>
<b>Notes on ergonomic colour adjustment</b>	<b>40</b>
<b>Explanatory information about standard ISO 9241-307</b>	<b>41</b>
<b>Troubleshooting</b>	<b>42</b>
<b>Technical specification</b>	<b>44</b>

**Remarks**

Notes on the product description meet the design requirements of Fujitsu and are provided for the purposes of comparison. The actual results may differ due to several factors. Subject to technical changes without prior notification. Fujitsu accepts no responsibility for technical or editorial mistakes or omissions.

**Trademarks**

Fujitsu and the Fujitsu logo are registered trademarks of Fujitsu Limited in Japan and other countries.

Microsoft and Windows are trademarks or registered trademarks of the Microsoft Corporation in the United States and/or other countries.

VESA is a registered trademark of Video Electronics Standards Association.

HDMI is a trademark or registered trademark of HDMI Licensing, LLC in the United States of America and/or other countries.

All other trademarks specified here are the property of their respective owners.

**Copyright**

No part of this publication may be copied, reproduced or translated without the prior written consent of Fujitsu.

No part of this publication may be saved or transmitted by any electronic means without the written consent of Fujitsu.

---

# Contents

<b>Your LCD screen...</b> .....	<b>5</b>
Target group .....	5
Further information .....	6
Notational conventions .....	6
<b>Important notes</b> .....	<b>7</b>
Safety instructions .....	7
Power cable .....	8
Transporting the device .....	8
Cleaning the device .....	9
CE marking .....	9
Disposal and recycling .....	10
<b>Getting started</b> .....	<b>11</b>
Unpacking and checking the delivery .....	11
Setting up the device .....	12
Setting up an ergonomic video workstation .....	12
Mounting the monitor base .....	14
Adjusting height .....	14
Adjusting the inclination .....	15
Adjusting the rotation .....	15
Adjusting portrait format .....	15
Removing monitor base .....	16
Connecting the device .....	17
Connecting cables to the monitor .....	17
Connecting cables to the computer .....	18
<b>Operation</b> .....	<b>19</b>
Switching the device on and off .....	19
Changing the monitor settings .....	20
Functions of the control panel and the OSD menu .....	21
Select OSD language .....	21
Setting screen display .....	22
Configuring the OSD menu .....	24
Advanced setting functions .....	26
Displaying information .....	28
Activate/deactivate ECO operating mode .....	28
Selecting the input signal .....	29
Selecting the application mode .....	30
Setting colour temperature and colours .....	32
Adjusting the volume .....	33
Adjusting the brightness and contrast .....	34
Locking the OSD menu .....	35
Lock the ON/OFF button .....	35
Notes on the program "DisplayView" .....	36
Rotation function .....	36
<b>Driver installation</b> .....	<b>37</b>
<b>Notes on power management</b> .....	<b>38</b>
<b>Notes on low blue light mode</b> .....	<b>39</b>

**Notes on ergonomic colour adjustment** ..... 40

**Explanatory information about standard ISO 9241-307** ..... 41

**Troubleshooting** ..... 42

**Technical specification** ..... 44

VESA-DDC-compatible VGA interface ..... 45

Preset operating modes ..... 45

    Most frequent operating modes ..... 45

    Video/TV operating modes via digital video inputs ..... 46

SUB D port ..... 46

HDMI port ..... 47

Displayport socket ..... 48



---

# Your LCD screen...

has a whole range of useful features and functions, e.g.:

- TFT display (Thin Film Transistor; active matrix)
- minimal space requirements thanks to slim casing
- optimum ergonomic characteristics (totally distortion-free, excellent picture definition and colour purity right into the corners)
- high degree of brightness and good contrast
- high resolution (1920 x 1200)
- presentation of up to 16.7 million colours (in conjunction with an appropriate display adapter)
- automatic scanning of horizontal frequencies from 30 to 82 kHz and refresh rates (vertical frequencies) from 48 to 76 Hz (absolutely flicker-free)
- digital screen controller with microprocessor for storing 39 different display modes
- freely adjustable colour alignment for matching the screen colours to the colours of various input and output devices
- convenient operation via integrated OSD (On-Screen-display) menu
- VESA-DDC compatibility
- VESA-FPMPMI compatibility (Flat Panel Monitor Physical Mounting Interface) – Mounting device for swivel arm or a similar accessory
- Plug&Play capability
- Digital video inputs (HDMI and DisplayPort) with HDCP
- power management for reducing power consumption when the computer is not in use
- Compliance with the recommendations according to the latest TCO requirements
- the monitor fulfills all GS ("Geprüfte Sicherheit", Certified Security) requirements.

This operating manual contains important information you require to start up and run your LCD monitor.

A display adapter (graphics card) with VGA interface or a digital display adapter with HDMI interface or DisplayPort interface is required to control the LCD monitor. The monitor processes the data supplied to it by the display adapter. The display adapter or the corresponding driver software is responsible for setting the modes (resolution and refresh rate).

When putting the monitor into operation for the first time, the screen display should be optimally adapted to the display adapter used and adjusted in accordance with your needs (see chapter ["Changing the monitor settings", Page 20](#)).

## Target group

You don't need to be an "expert" to perform the operations described here. Nonetheless, it is important to always observe the safety notes given in the operating instructions for the computer and in this manual.

In the event of any problems, please contact your sales office or our Service Desk.







## Further information

Details of how you set the resolution and refresh rate are provided in the documentation for your display adapter and the associated driver software.

For ergonomic reasons, a screen resolution of 1920 x 1200 pixels is recommended.

Because of the technology used (active matrix) an LCD monitor provides a totally flicker-free picture even with a refresh rate of 60 Hz.

## Notational conventions

	Pay particular attention to text marked with this symbol. Failure to observe these warnings could pose a risk to health, damage the device or lead to loss of data. The warranty will be invalidated if the device becomes defective through failure to observe these warnings.
	Indicates important information for the proper use of the device.
	Indicates an activity that must be performed
	Indicates a result
<b>This font</b>	indicates data entered using the keyboard in a program dialogue or at the command line, e.g. your password ( <b>Name123</b> ) or a command used to start a program ( <b>start.exe</b> )
This font	indicates information that is displayed on the screen by a program, e.g.: <i>Installation is complete.</i>
<i>This font</i>	indicates <ul style="list-style-type: none"> <li>terms and texts used in a software interface, e.g.: Click on <i>Save</i></li> <li>names of programs or files, e.g. <i>Windows</i> or <i>setup.exe</i>.</li> </ul>
"This font"	indicates <ul style="list-style-type: none"> <li>cross-references to another section, e.g. "Safety information"</li> <li>cross-references to an external source, e.g. a web address: For more information, go to <a href="http://www.fujitsu.com/fts/">"http://www.fujitsu.com/fts/"</a></li> <li>Names of CDs, DVDs and titles or designations of other materials, e.g.: "CD/DVD Drivers &amp; Utilities" or "Safety" Manual</li> </ul>
	indicates a button on the monitor, e.g.: 
<b>This font</b>	indicates terms and texts that are emphasised or highlighted, e.g.: <b>Do not switch off the device</b>

# Important notes

In this chapter you will find information regarding safety which it is essential to take note of when working with your device.

## Safety instructions

This device complies with the relevant safety regulations for data processing equipment, including electronic office machines for use in an office environment. If you have any questions about whether the device can be used in the intended environment, please contact your sales office or our Service Desk.

- The display surface of the device is sensitive to pressure and scratches. You should therefore be careful with the display surface in order to avoid lasting damage (scratches).
- If the device is brought into the installation site from a cold environment, condensation can form. Before operating the device, wait until it is absolutely dry and has reached approximately the same temperature as the installation site.
- When installing and operating the device, please observe the notes on environmental conditions in Chapter ["Technical specification", Page 44](#) as well as the instructions in Chapter ["Setting up an ergonomic video workstation", Page 12](#).
- To ensure sufficient ventilation, the air inlet and outlet openings of the device must be kept clear.
- The device automatically sets itself to the correct voltage within the range from 100 V to 240 V. Make sure that the local mains voltage is neither higher nor lower than this range.
- Ensure that the power socket on the device and the mains outlet are freely accessible.
- The ON/OFF switch does not disconnect the monitor from the mains voltage. To completely disconnect from the mains voltage, you must remove the mains plug from the mains socket.
- The device is equipped with a power cable that complies with safety standards.
- Use the supplied power cable only.
- Lay the cables in such a way that they do not create a hazard (danger of tripping) and cannot be damaged. When connecting the device, observe the relevant notes in chapter ["Connecting the device", Page 17](#).
- No data transfer cables should be connected or disconnected during a thunderstorm.
- Make sure that no objects (e.g. jewellery chains, paper clips, etc.) or liquids get inside the device (danger of electric shock, short circuit).
- The device is not waterproof! Never immerse the device in water and protect it from spray water (rain, sea water).
- In an emergency (e.g. damaged casing, operation controls or cables, penetration of liquids or foreign matter), switch off the device, disconnect the power plug and contact your sales outlet or our Service Desk.
- Repairs to the device must only be performed by qualified technicians. Unauthorised opening and incorrect repair may greatly endanger the user (electric shock, fire risk).
- Only use the screen resolution settings and refresh rates specified in Chapter ["Technical specification", Page 44](#). Otherwise you may damage the device. If you are in any doubt, contact your sales outlet or our Service Desk.
- Use a screen saver with moving images and activate the power management for your monitor to prevent still images from "burning in".
- If you operate the device with the swivel arm or a similar accessory, it must not be turned by 180°.

- The device may only be operated in wide format (0° landscape mode) and high format (90° portrait mode). The buttons of the control panel are located at the bottom in the middle of the monitor in wide format (0° landscape mode) and at the left-hand side of the monitor in high format (90° portrait mode).
- Store this manual close to the device. If you pass the device on to third parties, you should pass this manual on with it.
- We recommend that you place your device on a durable, non-slip surface. In view of the many different finishes and varnishes used on furniture, it is possible that the feet of the device may mark the surface they stand on.
- The device must be connected to protective earth.
- To prevent possible hearing damage, do not listen at high volume levels for long periods.
- Warning for excessive sound pressure from earphones and headphones:  
Excessive sound pressure from earphones and headphones can cause hearing loss. Adjustment of the equalizer to maximum increases the earphones and headphones output voltage and therefore the sound pressure level.

## Power cable

Use the supplied power cable only.

Use the following guidelines if it is necessary to replace the original cable set.

- The female/male receptacles of the cord set must meet IEC60320/CEE-22 requirements.
- The cable has to be HAR-certified or VDE-certified. The mark HAR or VDE will appear on the outer sheath.
- For devices which are mounted on a desk or table, type SVT or SJT cable sets may be used. For devices which sit on the floor, only SJT type cable sets may be used.
- The cable set must be selected according to the rated current for your device.
- If necessary, replace the original power cable with a regular grounded 3-core mains lead.

## Transporting the device



Transport all parts separately in their original packaging or in a packaging which protects them from knocks and jolts, to the new site.

Do not unpack them until all transportation manoeuvres are completed.

If the device is brought from a cold environment into the room where it will be used, condensation may occur. Before operating the device, wait until it is absolutely dry and has reached approximately the same temperature as the installation site.

## Cleaning the device



Switch off the device and unplug the power plug.

Do not clean any interior parts yourself, leave this job to a service technician.

Do not use any cleaning agents that contain abrasives or may corrode plastic.

Ensure that no liquid enters the device.

The display surface of the device is sensitive to pressure and scratches. Clean it only using a soft, slightly moistened cloth.

The surface of the casing can be cleaned with a dry cloth. If particularly dirty, use a cloth that has been moistened in mild domestic detergent and then carefully wrung out.

## CE marking

The shipped version of this device complies with the requirements of EU directives 2014/30/EC "Electromagnetic compatibility", 2014/35/EC "Low voltage directive", 2009/125/EC "Ecodesign directive" and 2011/65/EC "RoHS directive".

## Disposal and recycling

This device has been manufactured as far as possible from materials which can be recycled or disposed of in such a way that the environment is not damaged. The device may be taken back after use to be reused or recycled, provided that it is returned in a condition that befits its intended use. Any components not reclaimed will be disposed of in an environmentally acceptable manner.

The device must be disposed of in accordance with the local regulations for disposal of special waste.

If you have any questions on disposal, please contact your local sales office or our Service Desk, or contact one of the following directly:

Germany	Belgium	Switzerland
AfB gemeinnützige GmbH Heinz-Nixdorf-Ring 1 D-33106 Paderborn Tel.: +49 (0) 5251 / 414 90 10 Fax: +49 (0) 5251 / 414 90 29 <a href="http://www.fujitsu.com/fts/recycling">"http://www.fujitsu.com/fts/recycling"</a>	RECUPEL Boulevard Reyers, 80 B-1030 Brussels Tel.: +32 2 / 706 86 16 Fax: +32 2 / 706 86 13 E-mail: <a href="mailto:info@recupel.be">"info@recupel.be"</a> <a href="http://www.recupel.be">"http://www.recupel.be"</a>	SWICO Schweizerischer Wirtschaftsverband der Informations-, Kommunikations- und Organisationstechnik A list of the SWICO acceptance locations can be found at: <a href="http://www.swico.ch">"http://www.swico.ch"</a>
Asia	USA	
Taiwan: Environmental Protection Administration Executive Yuan R.O.C. <a href="http://recycle.epa.gov.tw">"http://recycle.epa.gov.tw"</a>	Fujitsu America, Inc. 1250E. Arques Avenue Sunnyvale, CA 94085 U.S.A. Phone No.: (408) 746-6000	

You can also find more information on this at ["http://www.fujitsu.com/fts/about/fts/environment-care/"](http://www.fujitsu.com/fts/about/fts/environment-care/).

# Getting started

## Unpacking and checking the delivery



The display surface of the device is sensitive to pressure and scratches. Always hold the device by the casing!

The complete device package includes:

- one monitor
- a data cable (DisplayPort)
- one USB cable
- one audio cable
- one power cable
- a flyer "Quick Start Guide"
- a flyer "safety instructions"

- ▶ Unpack all the individual parts.
- ▶ Check the contents of the package for any visible damage caused during transport.
- ▶ Check whether the delivery conforms to the details in the delivery note.
- ▶ Should you discover that the delivery does not correspond to the delivery note, notify your local sales outlet immediately.



Do not discard the original packing material of the devices. You may need the packaging in the future if you need to transport your device.

## Setting up the device



To ensure sufficient ventilation, the air inlet and outlet openings of the device must be kept clear.

## Setting up an ergonomic video workstation

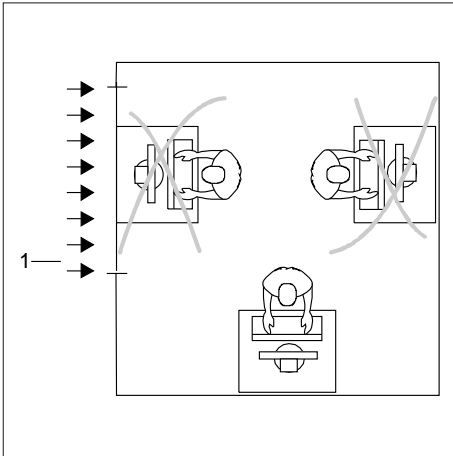

- ▶ Do not position the video workstation opposite a window (1).

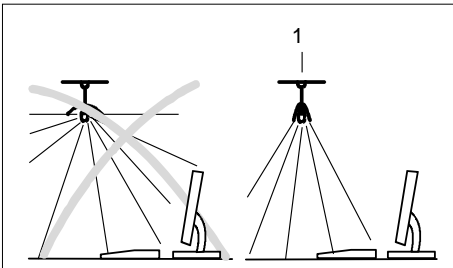

- ▶ Position the monitor outside the reach of a light source (1).





- Position the keyboard where it is easiest to reach (1).

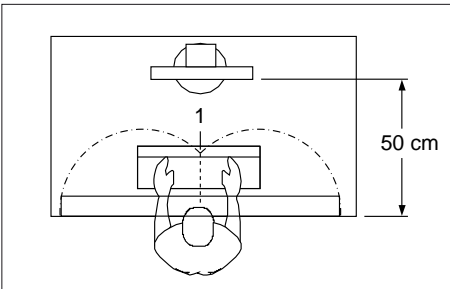

- Position the monitor so that the eye distance to the screen (1) is around 50 cm.

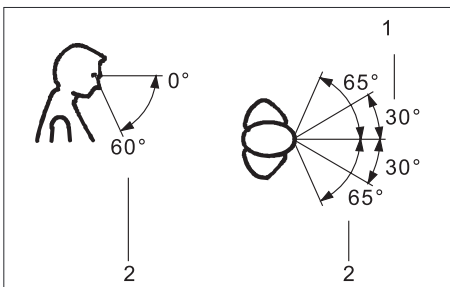

- Position the monitor for optimum viewing (1). The monitor should under no circumstances fall outside the permissible viewing space (2).



Depending on the situation, it may be advisable to use a swivel arm or similar accessory (VESA FPMPMI), which are available from specialist dealers. For this purpose the monitor base must be removed beforehand as described in Chapter ["Removing monitor base", Page 16](#).

## Mounting the monitor base

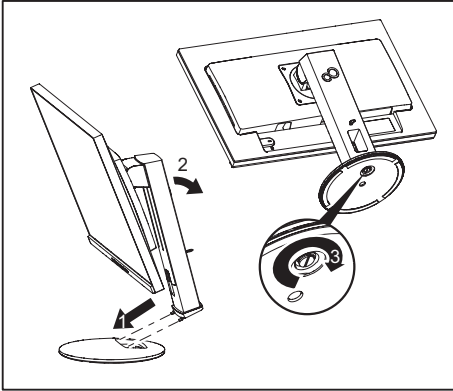

- ▶ Insert the base plate at the foot (1 and 2).
- ▶ Secure the base plate with the screw (3).
- ▶ Place the monitor in the operating position.

## Adjusting height

The height of the screen can be adjusted by approximately 130 mm.



The height adjustment is fixed in the transport position.

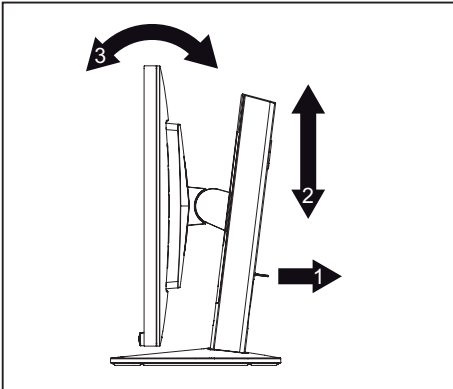

- ▶ To free the fixing, remove the locking pin on the flange (1).
- ▶ Grasp the monitor with both hands on the right and left edge of the casing and move it up or down (2).

## Adjusting the inclination

The inclination of the monitor can be adjusted by  $-3^{\circ}$  (forwards) and  $+35^{\circ}$  (backwards) from its vertical position.

- ▶ Hold the monitor with both hands on the left and right sides of the case and move it to the desired angle (3, see ["Adjusting height", Page 14](#)).

## Adjusting the rotation

The monitor can be rotated by  $\pm 172^{\circ}$ .

- ▶ Grasp the monitor with both hands on the right and left edge of the casing and turn it to the desired position.

## Adjusting portrait format

The monitor can be rotated from horizontal format (landscape mode) into vertical format (portrait mode).

- ▶ Grasp the monitor with both hands on the right and left edge of the casing, move it into the highest position and turn it clockwise until it is in the portrait position.
- ▶ To set the screen back into landscape mode, rotate it back anti-clockwise.



The screen supports the "Autorotation" function with the associated software (DisplayView), which is used to adapt the display to the orientation of the screen (see ["Notes on the program "DisplayView"", Page 36](#)).



For you to be able to display the screen contents in portrait mode, your graphics card will also need to support this function or you will need to use special software.

In the OSD menu you have the option of switching the OSD manually from landscape mode to portrait mode (see ["Functions of the control panel and the OSD menu", Page 21](#)).

To reset the monitor to landscape mode, the monitor should be turned anti-clockwise. The OSD display can be reset again in the OSD menu.

## Removing monitor base

Before you can use a swivel arm or a similar accessory, you must remove the monitor base.



The display surface is susceptible to scratching!

Place the device on a stable, flat and clean surface. If necessary, place a slip-resistant cloth on this surface to prevent the device from being scratched.

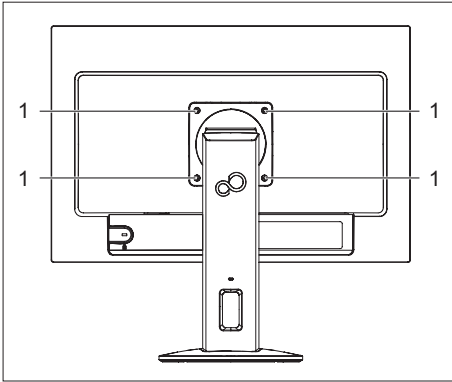

- ▶ Switch off the monitor and pull the power plug out of the power socket.
- ▶ Lay the monitor on its face on a soft surface.
- ▶ Disconnect all cables.
- ▶ To release the stand, remove the four screws (1) that hold the stand in the VESA mount. Then lift the stand away upwards.
- ↳ You can now mount a swivel arm or a similar accessory in accordance with VESA FPMPMI using a hole spacing of 100 mm.



For instructions on how to mount the swivel arm or a similar accessory, please see the documentation for the swivel arm or similar accessory.



The assured ergonomics and safety of the monitor may be limited if the foot provided for the monitor is not used.

## Connecting the device



Please observe the safety information in ["Important notes", Page 7.](#)

CE conformance and optimum picture quality are guaranteed only if you use the data cables supplied.

- ▶ Switch off the monitor and the computer.
- ▶ Disconnect the power plug from the computer.

## Connecting cables to the monitor

The data cables supplied have two 20-pin DP connectors for connection to the monitor and to the computer.

Information on the computer connections and interfaces is contained in the operating manual for the computer.

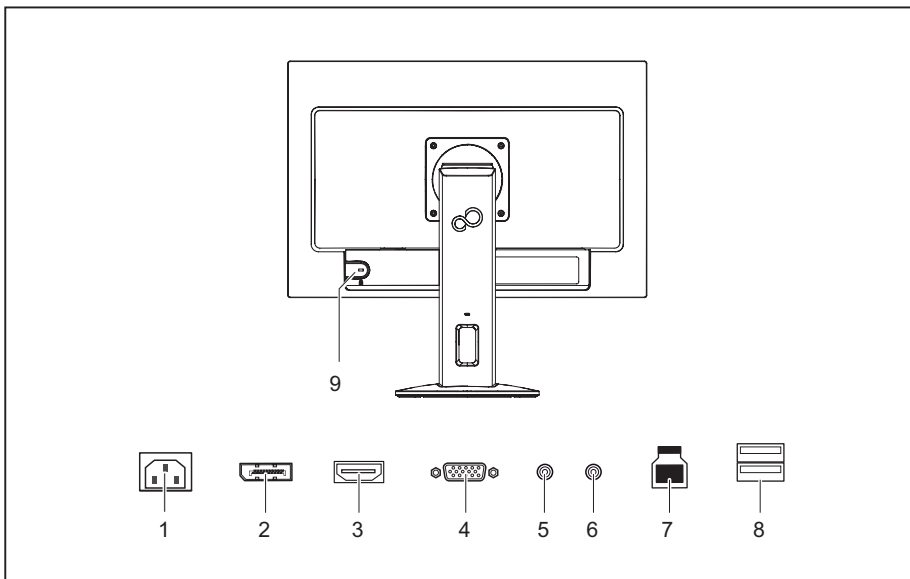

- |                         |                                     |
|-------------------------|-------------------------------------|
| 1 = Power socket        | 6 = AUDIO-OUT socket                |
| 2 = Display port socket | 7 = USB 3.0 (Upstream)              |
| 3 = HDMI socket         | 8 = USB 3.0 (Downstream)            |
| 4 = D-SUB socket (VGA)  | 9 = Security slot for Security Lock |
| 5 = AUDIO-IN socket     |                                     |

- ▶ Select the appropriate data cable for your computer.

- ▶ Connect a connector of the data cable to the D-SUB socket or HDMI socket or to the DP socket of the monitor. Secure the plug-in connection by tightening the safety screws when available.



The monitor automatically detects the input when only one signal source is connected.

- ▶ If analogue audio will be output on the monitor, plug a connector of the audio cable (not in the delivery scope) into the AUDIO IN socket on the monitor and make sure that it engages securely.
- ▶ Plug the power cable supplied into the power connector of the monitor.
- ▶ Plug the supplied USB cable into the USB IN socket and the other end of the cable into a USB socket of the computer.



A lock (Security Lock) can be mounted in the security slot to protect the monitor against theft. A Security Lock is not included with the monitor at delivery.

## Connecting cables to the computer

Information on the computer connections and interfaces is contained in the operating manual for your computer.

- ▶ Connect the data cable to the (active) monitor port on the computer and secure the plug-in connection by tightening the safety screws when available.
- ▶ If used, insert the other plug of the audio cable into the audio output of the computer.
- ▶ Plug the power connector of the monitor into a properly grounded mains outlet.
- ▶ Plug the power connector of the computer into a properly grounded mains outlet.



If your computer has two monitor ports ("onboard" screen controller and separate graphics card), the monitor port for the separate graphics card is active as standard.

# Operation

## Switching the device on and off

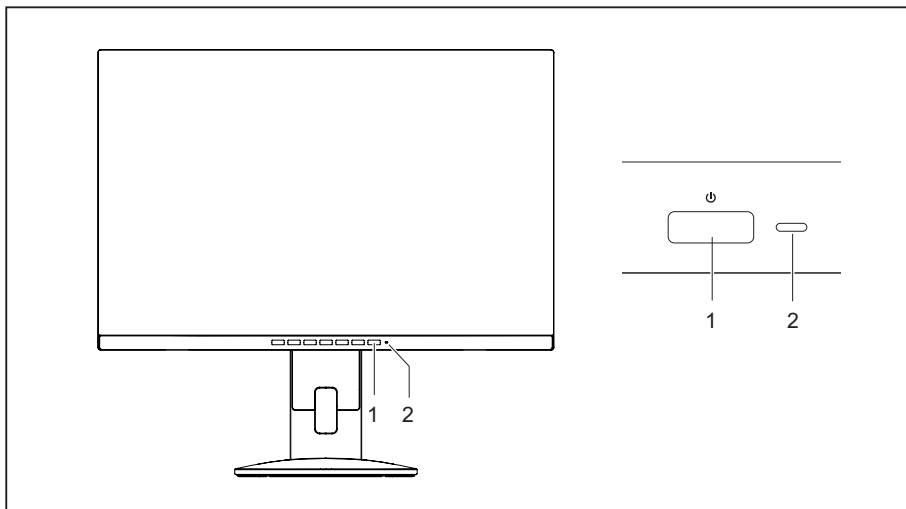

1 = On/off switch

2 = Power indicator

The colour of the power indicator changes as follows:

Power indicator	Status
blue	Monitor and computer are switched on (normal mode).
green	Monitor and computer are switched on (ECO mode).
orange	Monitor is not receiving a video signal or is in power saving mode.
does not light up	Monitor is switched off.



- ▶ Switch the device on again with the ON/OFF switch (1).

## Changing the monitor settings



The buttons on the control panel have multiple functions. When the OSD menu is active, the current meaning of the buttons is shown directly over the buttons on the edge of the screen.

The display (softkey icon) over the buttons varies depending on the sub-menu chosen.

Key	Function
<b>MENU</b>	Make image and OSD settings / Advanced configuration / Call up monitor information
<b>ECO</b>	Activate/deactivate ECO operating mode
<b>INPUT</b>	Selecting the input signal
<b>MODE</b>	Select display mode/colour temperature / Adjust RGB channels
	Adjust volume
	Adjust brightness/contrast
	Monitor: switching on/off

Softkey icon	Function
↑	Selecting the next menu item (sub-menu)
↓	Selecting the previous menu item (sub-menu)
→	Opening the selected sub-menu Going to the next setting Running a function
←	Going to the previous setting
—	Decreasing the set value
+	Increasing the set value
✓	Accepting the applied settings and returning to the previous menu
↶	Return to the parent menu
✕	Exiting OSD menu



---

## Functions of the control panel and the OSD menu

With the buttons on the control panel, you can call up and use the integrated OSD (On-Screen Display) menu.

A square box containing a lowercase letter 'i' in a bold, serif font, representing an information icon.

The English menu names are used in the following description (default setting).

The OSD menu of your device may differ in several ways from the functional scope described.

The softkey icons may deviate from those shown here.

### Select OSD language

When an OSD menu button is activated for the first time, the language selection window will appear:

- ▶ Press the ↑ button or the ↓ button to choose the desired language.
- ▶ Press the ✓ button to confirm.

A square box containing a lowercase letter 'i' in a bold, serif font, representing an information icon.

After selecting the OSD language for the first time, you can change it at any time in the OSD.

## Setting screen display

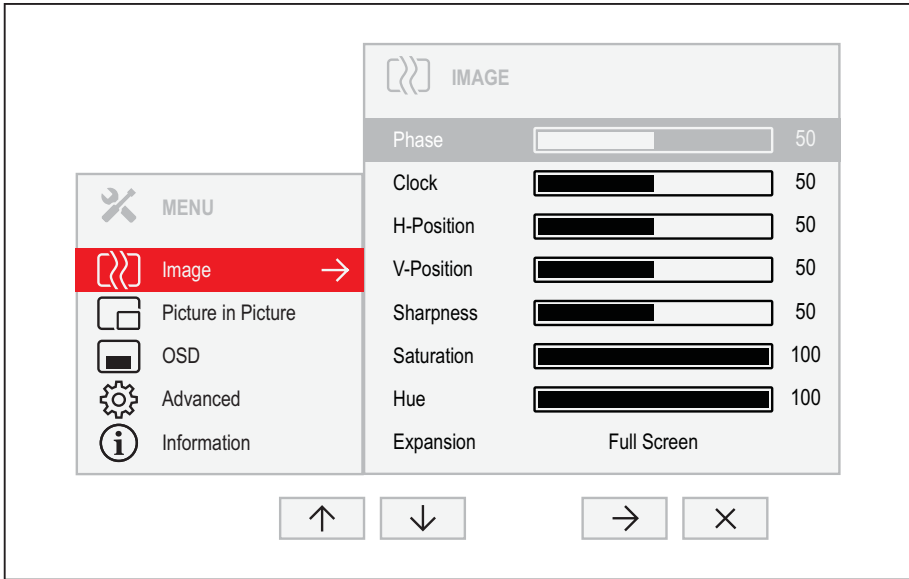

- ▶ Press the **MENU** button to call up the main menu.
- ▶ Press the → button to switch to the *Image* submenu.
- ▶ Press the ↑ / ↓ button to mark a function in the submenu.
- ▶ Press the - / + or ← / → button to make the desired setting.
- ▶ Press the ↶ button to save the settings and return to the main menu.

Function	Description
<i>Phase</i>	Eliminate picture disturbance With this function you fine-tune your monitor to eliminate picture disturbance. This setting only appears with an analogue video signal (e.g. VGA).
<i>Clock</i>	Set synchronisation With this function you adjust the picture width to eliminate vertical picture disturbances. This setting only appears with an analogue video signal (e.g. VGA).
<i>H-position</i>	Adjust the horizontal position With this function you move the picture to the left or to the right. This setting only appears with an analogue video signal (e.g. VGA).

Function	Description
<i>V-position</i>	<p>Adjusting the picture vertical position</p> <p>With this function you move the picture up or down.</p> <p>This setting only appears with an analogue video signal (e.g. VGA).</p>
<i>Auto adjust</i>	<p>Perform auto-adjustment of the monitor</p> <p>With this function, the monitor automatically sets the analogue parameters.</p> <p>► Press the → button to run the function.</p> <p>The <code>Auto Processing</code> message appears.</p> <p>This setting only appears with an analogue video signal (e.g. VGA).</p>
<i>Sharpness</i>	<p>Setting the picture sharpness</p> <p>This function is used to configure the integrated soft focus or sharpness filter of the monitor.</p> <ul style="list-style-type: none"> <li>• Values below 50 produce a softer picture.</li> <li>• Values above 50 produce a sharper picture.</li> </ul>
<i>Saturation</i>	<p>Setting colour saturation</p> <p>You can use this function to reduce or increase the intensity of the colours.</p> <p>This setting only applies for devices with YUV output (e.g. BluRay players).</p>
<i>Hue</i>	<p>Setting the colour tone</p> <p>This function can be used to shift the colour spectrum in order to compensate for a colour fault that may be present.</p> <p>This setting only applies for devices with YUV output (e.g. BluRay players).</p>
<i>Expansion</i>	<p>Adjusting size</p> <p>This function is used to change the type of scaling of low resolutions.</p> <p><i>Full screen</i> = maximum picture size with distortion (no black bands)</p> <p><i>Keep aspect</i> = Maximum picture size without distortion (black bands could appear in one direction)</p> <p><i>1:1</i> = Centred image without scaling (black bands could appear in both directions). This function is not available on all models.</p>

## Configuring the OSD menu

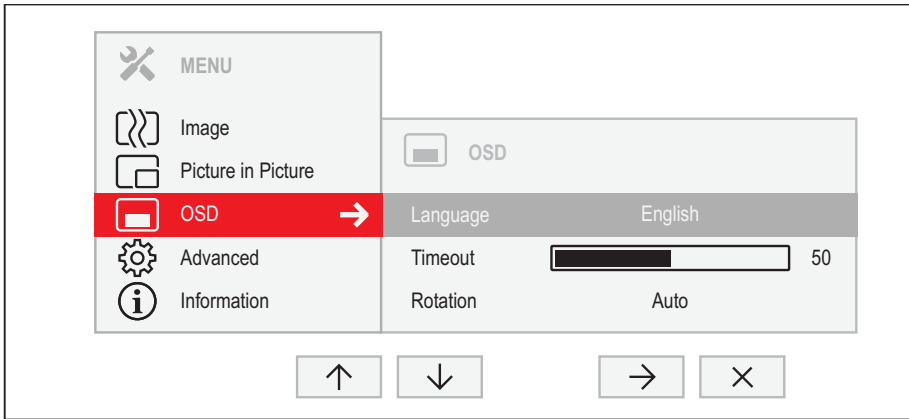

- ▶ Press the **MENU** button to call up the main menu.
- ▶ Press the ↓ button twice and then → to switch to the *OSD* submenu.
- ▶ Press the ↑ / ↓ button to mark a function in the submenu.
- ▶ Press the − / + or ← / → button to make the desired setting.
- ▶ Press the ↶ button to save the settings and return to the main menu.

Function	Description
<i>Language</i>	<p>Selecting the language for the OSD menu</p> <p>With this function you select the language for the OSD menu.</p> <ul style="list-style-type: none"> <li>▶ Press the → button to arrive at the choice of language.</li> <li>▶ Press the ↑ / ↓ button to select the desired language.</li> <li>▶ Press the ✓ button to confirm the language selected or ↶ to leave the language selection option without making any changes.</li> </ul>
<i>Timeout</i>	<p>Setting the display duration of the OSD menu</p> <p>With this function you can select a value from 10 to 120 seconds.</p> <p>If the set time expires without a setting being made, the OSD menu is automatically hidden.</p> <p>Where applicable, settings that must be confirmed with the ✓ button are thereby lost.</p>
<i>Rotation</i>	<p>Set the orientation of the OSD menu</p> <p>This function allows the orientation of the OSD menu to be rotated. This makes it easier to read the OSD menu while the pivot function is being used.</p> <p><i>Off</i> = OSD menu will not be rotated</p> <p><i>On</i> = OSD menu will be turned through 90°.</p> <p><i>Auto</i> = orientation of the OSD menu will automatically be matched to the orientation of the monitor.</p> <p>The <i>Auto</i> setting only appears on models with a rotation sensor.</p> <p>The <i>Rotation</i> function cannot be selected when the monitor is in <i>Picture in Picture</i> mode (Picture in Picture).</p>

## Advanced setting functions

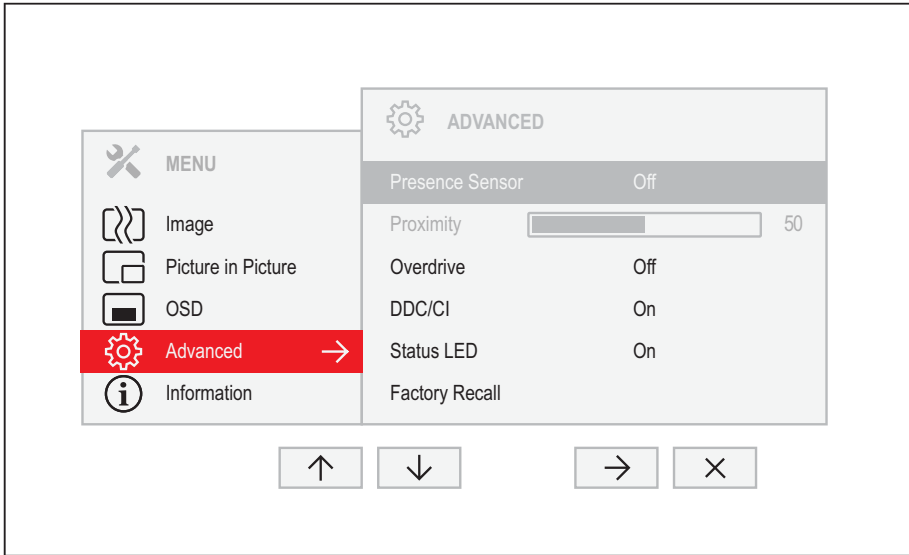

- ▶ Press the **MENU** button to call up the main menu.
- ▶ Press the ↓ button three times and then → to switch to the *Advanced* submenu.
- ▶ Press the ↑ / ↓ button to mark a function in the submenu.
- ▶ Press the — / + or ← / → button to make the desired setting.
- ▶ Press the ↶ button to save the settings and return to the main menu.

Function	Description
<i>Presence Sensor</i>	<p>Activating/deactivating the presence sensor</p> <p>This function shuts down the monitor gradually while you are absent. After 10 seconds of absence, the brightness is reduced to a minimum. After a further 30 seconds absence, the display lighting is switched off. This option only appears if your model has a presence sensor.</p>
<i>Proximity</i>	<p>Setting the distance to the monitor</p> <p>With this function, you can indicate your actual distance to the monitor and optimise detection by the presence sensor.</p> <p>The vertical indicator dynamically displays the detected distance to the monitor. This setting can be used to set the distance within which you want the sensor to react. If the vertical line is outside the setting bar, this will be judged as "absent" by the presence sensor.</p> <p>This setting can only be applied if the <i>Presence Sensor</i> function is active.</p>

Function	Description
<i>Call Indicator</i>	<p>Enable/disable call display</p> <p>This function shows the status of the user of the communication software (e. g. <i>Microsoft Lync / Skype for Business</i>) via the LED on top of the monitor. Incoming calls are indicated audibly by the communication software using the monitor speakers.</p> <p>This function is only available if your model has a call indicator display and the communication software being used supports status transmission.</p>
<i>Daisy Chain</i>	<p>Enable/disable daisy chaining via Displayport.</p> <p>This function allows the desktop to be extended onto a monitor connected via "DP OUT".</p> <p>This option only appears if your model supports daisy chain and display port or USB-C is selected as input signal.</p>
<i>Overdrive</i>	<p>Enable/disable enhanced reaction time</p> <p>This function can be used to improve the focus in fast moving images.</p> <p>This setting can only be configured in <i>Video</i> or <i>Custom</i> application mode.</p>
<i>DDC-CI</i>	<p>Enable/disable Display Data Channel - Command Interface</p> <p>This function allows data to be exchanged via the connection between the PC and the display.</p>
<i>Status LED</i>	<p>Enable/disable Status LED</p> <p>This function allows the power indicator on the monitor to be switched on or off.</p>
<i>Factory recall</i>	<p>Activate the factory settings</p> <p>With this function all settings are reset to the factory settings.</p> <ul style="list-style-type: none"> <li>▶ Press the → button to run the function.</li> <li>▶ Press the ✓ button to confirm or the ✕ button to cancel. The language selection menu appears.</li> </ul> <p>With a VGA data cable, the message <i>Auto Processing</i> is displayed.</p>

## Displaying information



- ▶ Press the **MENU** button to call up the main menu.
- ▶ Press the **↑** button to call up the *Information* window.

Details such as the model designation, serial number, resolution, H/V frequency and ECO mode are displayed.

## Activate/deactivate ECO operating mode



The power consumption of the device can be decreased by reducing the brightness of the picture.



The ECO mode can only be activated when the *ACR* and *Auto Brightness* are switched off.

- ▶ Press the **ECO** button to switch ECO operating mode on or off.

↳ The message *ECO Mode on* or *ECO Mode off* is displayed.

If ECO mode is active, a brightness is used that is the optimum from both the ergonomic and ecological aspects.

If the brightness is further reduced by the user, this new setting is used during the next call of the ECO operating mode.

After the ECO operating mode is switched off, the brightness previously set by the user is restored.



## Selecting the input signal

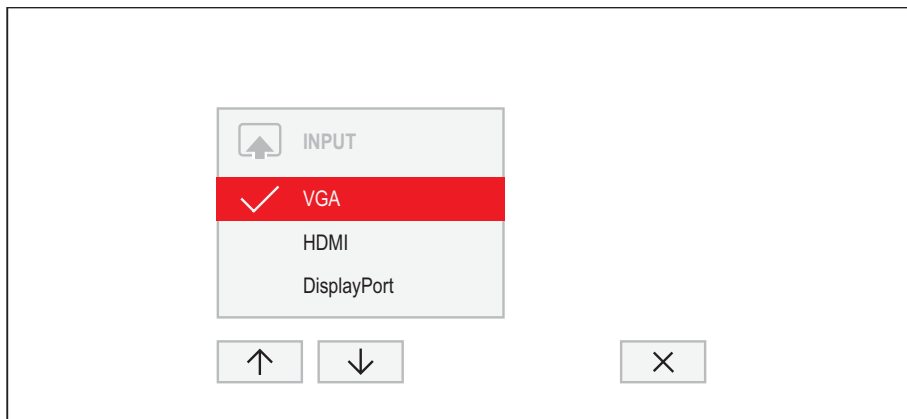

- ▶ Press the **INPUT** button to open the *INPUT* setting window.
- ▶ Press the  $\uparrow$  /  $\downarrow$  button to select the desired monitor port.
- ▶ Press the  $\checkmark$  button to confirm the selected monitor port or  $\times$  to close the window without making any changes.

## Selecting the application mode

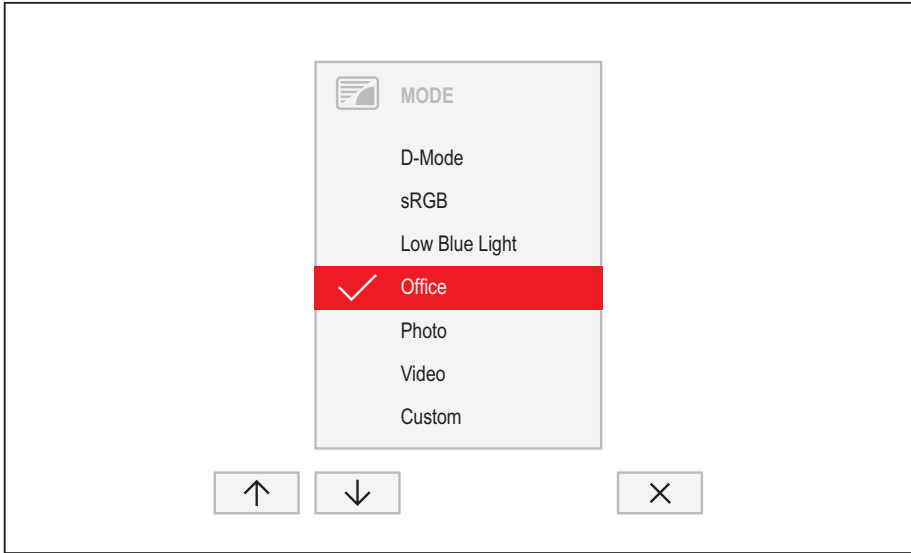

- ▶ Press the **MODE** button to open the *MODE* setting window.
- ▶ Press the ↑ / ↓ button to select the desired application mode.
- ▶ Press the ✓ button to confirm the selected application mode or × to close the window without making any changes.

Function	Description
<i>D-Mode</i>	Mode for Digital Imaging and Communication in Medicine (DICOM) Colour temperature equal to 7500 K, specially calibrated gamma curve. This setting only appears on models that support the DICOM picture format.
<i>sRGB</i>	Mode for applications in sRGB colour space Colour temperature and brightness according to the sRGB standard.
<i>Low Blue Light</i>	Mode with reduced blue light emission Warm tints, reduced brightness.
<i>Office</i>	Mode for everyday office applications Colour temperature equals 6500 K, ECO operating mode active.
<i>Photo</i>	Mode for the display of photos Increased picture definition and colour saturation.
<i>Video</i>	Mode for the display of videos Enhanced reaction time (overdrive), dynamic contrast (ACR).
<i>Custom</i>	Mode for special application purposes Free choice of colour temperature, advanced configuration capabilities.



The brightness set in Mode is stored under *Office*, *Photo*, *Video* and *Custom*.

## Setting colour temperature and colours

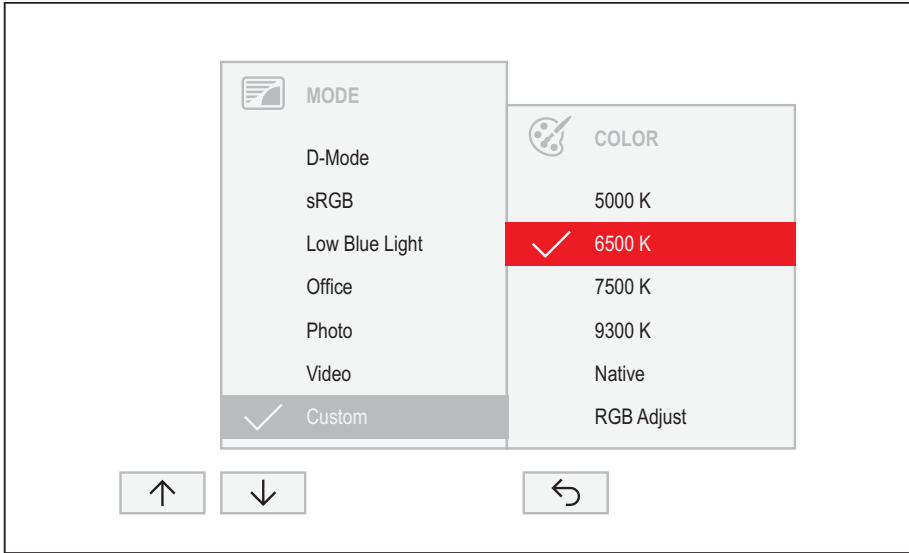





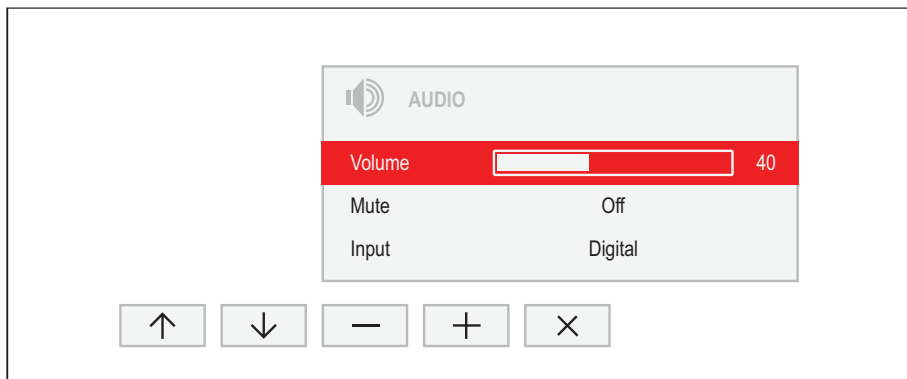

- ▶ Press the **MODE** button to open the *MODE* setting window.
- ▶ Press the  $\uparrow$  /  $\downarrow$  button to select *Custom* mode.
- ▶ Press the  $\rightarrow$  button to arrive at the choice of colour temperature.
- ▶ Press the  $\uparrow$  /  $\downarrow$  button to select the desired colour temperature.
- ▶ Press the  $\checkmark$  button to confirm the selected colour temperature or  $\hookleftarrow$  to close the window without making any changes.

Function	Description
5000 K	Select the colour temperature
6500 K	The "warmth" of the screen colours is set using the colour temperature. The colour temperature is measured in K (= Kelvin).
7500 K	
Native	
RGB Adjust	You can change the colour ratios of the primary colours (red, green, blue) as required using this function. <ul style="list-style-type: none"> <li>▶ Press the <math>\rightarrow</math> button to arrive at the selection of colour channels.</li> <li>▶ Press the <math>\uparrow</math> / <math>\downarrow</math> button to select the desired colour channel.</li> <li>▶ Press the <math>-</math> / <math>+</math> button to make the desired setting.</li> <li>▶ Press the <math>\hookleftarrow</math> button to save the settings and return to the previous menu.</li> </ul>

## Adjusting the volume



- ▶ Press the  button to open the *AUDIO* setting window.
- ▶ Press the  /  or  /  button to make the desired setting.
- ▶ Press the  button to save the settings and close the menu.

Function	Description
<i>Volume</i>	Set the volume for playback with the integrated loudspeakers
<i>Mute</i>	Switch the loudspeakers off or on
<i>Input</i>	Change the audio input signal to another source The setting only appears when more than one audio input signal is possible (e.g. display port and AUDIO-IN socket).

## Adjusting the brightness and contrast

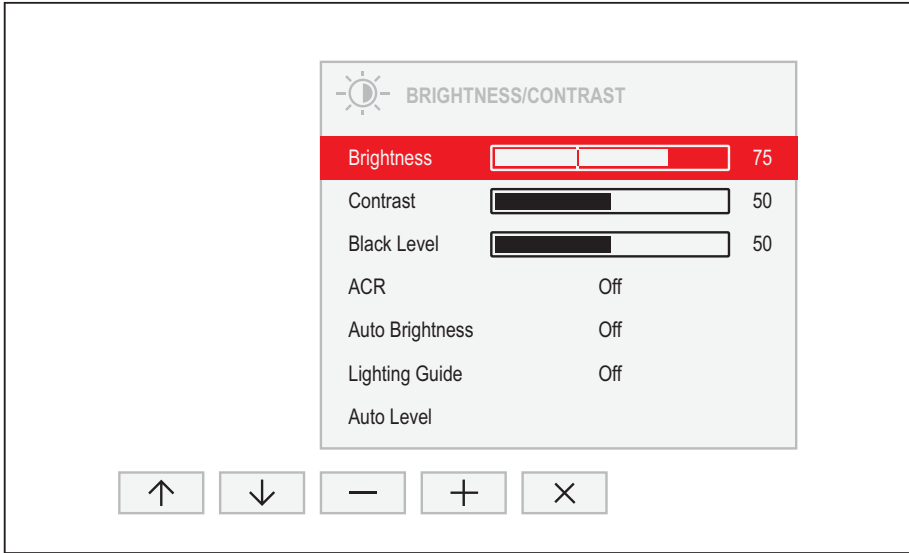

- ▶ Press the ☀ button to open the *BRIGHTNESS/CONTRAST* setting window.
- ▶ Press the  $- / +$  or  $\leftarrow / \rightarrow$  button to make the desired setting.
- ▶ Press the  $\times$  button to save the settings and close the menu.

Function	Description
<i>Brightness</i>	Set the brightness of the display With this function you change the brightness of the background lighting.
<i>Contrast</i>	Set the contrast of the display With this function you modify the contrast of bright colour tones. If the contrast is set too high, bright surfaces can no longer be distinguished from very bright surfaces. If the contrast is set too low, the maximum brightness will not be achieved.
<i>Black level</i>	Set the brightness of the display With this function you modify the contrast of dark colour tones.
<i>ACR</i>	Enable/disable dynamic contrast This function improves the contrast by automatically controlling the background lighting in relation to the image being displayed. This setting can only be configured in <i>Office</i> and <i>Custom</i> application mode. As soon as ACR is enabled, <i>Auto brightness</i> is automatically disabled.

Function	Description
<i>Auto Brightness</i>	<p>Enable/disable automatic control of the brightness</p> <p>This function is used to automatically control the brightness of the background lighting using the ambient light sensor.</p> <p>This setting only appears on models with an ambient light sensor and can only be enabled in <i>Office</i>, <i>Photo</i> or <i>Custom</i> mode.</p> <p>As soon as <i>Auto brightness</i> is enabled, <i>ACR</i> is automatically disabled</p>
<i>Lighting Guide</i>	<p>Enable/disable advice on workplace lighting</p> <p>With this function, advice is displayed if the ambient light at the workplace does not meet the ergonomic recommendations for working at the computer screen.</p> <p>This setting only appears on models with a light sensor.</p>
<i>Auto level</i>	<p>Adjust the signal level</p> <p>With this function you can automatically set the contrast.</p> <p>Press the → button to run the function.</p> <p>This setting only appears with an analogue video signal (e.g. VGA).</p>

## Locking the OSD menu

The OSD menu can be locked to prevent accidental or unauthorised changes to the monitor settings.

- ▶ Press the **MENU** button and the ON/OFF button at the same time and keep them pressed for approximately 10 seconds.

↳ The message *OSD locked / unlocked* is displayed.



Please proceed in the same manner to release the locked OSD menu again.

## Lock the ON/OFF button

The ON/OFF button can be locked to prevent accidental or unauthorised changes to the monitor settings.

- ▶ Press the buttons **ECO** and **INPUT** at the same time and keep them pressed for a few seconds.

↳ The message *Power button locked / unlocked* is displayed.



To remove the locking of the ON/OFF button again, proceed in the same way.

## Notes on the program "DisplayView"

*DisplayView* is a help programme for Microsoft Windows operating systems, which provides the user with a simple user interface for adapting functions that are normally assigned to the OSD.

Changes to brightness, contrast, image position and other default monitor settings can be made easily and intuitively. The help programme includes guided instructions on how to fine-tune the monitor to achieve optimal display results.

The help programme also supports advanced functions such as Auto-Rotation.



Your device may differ from the described scope of function in some areas.

*DisplayView* Can be downloaded here: ["http://www.fujitsu.com/fts/download"](http://www.fujitsu.com/fts/download)

Function overview:

- OSD replacement for monitors equipped with DDC/CI
- OSD direct access for quick changes
- Settings for power saving mode and security settings for the presence sensor (only for models with presence sensor)
- Automatic rotation of the screen contents
- Supports analogue and digital monitor ports
- Supports up to 4 monitors
- Supports the Microsoft Windows 7 and Windows 10 operating systems

## Rotation function

The rotation menu allows you to rotate the screen content pursuant to the screen orientation.



# Driver installation

**i**

The display drivers are automatically installed when the Microsoft Windows operating system is updated.

- ▶ For manual installation, download the monitor drivers from "<http://www.fujitsu.com/fts/download>".
- ▶ Unpack the zip file.
- ▶ Open the *Device Manager* and select directory *Monitors*.
- ▶ Double click on a listed *Generic PnP Monitor* to open the *Properties* window.

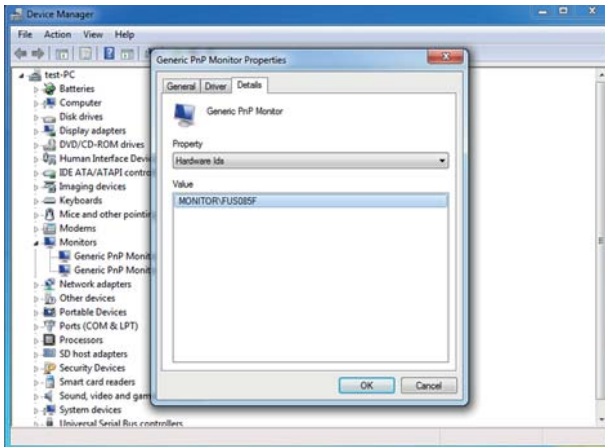

- ▶ If more than one *Generic PnP Monitor* device is displayed, check whether the correct device is selected.  
To do this, go to tab *Details*, *Property* and set "Hardware Ids".  
"Monitor\FUSxxxx" is displayed under *Value*. Otherwise, select the other *Generic PnP Monitor* device.
- ▶ Click on *Update Driver* in tab *Driver*.
- ▶ Click on *Browse my computer for driver software*.
- ▶ Click on *Browse*, navigate to the unpacked zip file and confirm with *OK*.
- ▶ Click on *Next* and wait until the driver is installed.

# Notes on power management

If your computer is equipped with power management (power-saving mode), the monitor can fully support this function. Here the monitor does not distinguish between the individual energy-saving modes of the computer (standby mode, suspend mode and OFF mode), as it is capable of immediately switching into the mode with the highest energy-saving effect.

Stage	Operation		Power saving mode
	Normal	ECO	
Power supply indicator	Lights up blue	Lights up green	Lights up orange
Display	Max. brightness	typ. 175 cd/m <sup>2</sup>	unlit
Typical power consumption (without USB and audio)	< 22 W	< 1.7 W	< 0.2 W

If the computer detects inactivity (no input) it sends an appropriate signal to the monitor to reduce the power consumption (power saving mode). The power indicator of the monitor changes colour to show the change in status. ECO mode is the preset factory default.

Once an input is made at the computer the screen contents are restored.



For detailed information on how energy-saving mode operates, please refer to the operating manual or technical manual of the computer.

# Notes on low blue light mode

This monitor has a "low blue light" function, which can be selected in the OSD menu. This "low blue light" function reduces the blue light emission of the monitor to a minimum. In this way, the device complies with the "low blue light" certification of the Technical Inspection Association.

LED backlights no longer emit blue light as a conventional source of white light.

Further information can be found in Chapter ["Selecting the application mode", Page 30](#).

The viewing distance to the monitor should be approximately 50 cm. Further information can be found in Chapter ["Setting up an ergonomic video workstation", Page 12](#).

When working continuously at a display screen, it is recommended that you take a five minute break every hour. During these breaks, do eye exercises to relax your eyes.

To prevent eye strain and dryness, focus regularly on objects in the distance.

# Notes on ergonomic colour adjustment



If you select colours for the monitor in your application programmes, take note of the information below.

The primary colours blue and red on a dark background do not produce the minimum required contrast of 3:1 and are therefore not suitable for continuous text and data entry.

When using several colours for characters and background and giving the primary colours full modulation, you can obtain very suitable colour combinations (see the following table):

Background	Characters							
	black	white	purple	blue	cyan	green	yellow	red
black		+	+	-	+	+	+	-
white	+		+	+	-	-	-	+
purple	+	+		-	-	-	-	-
blue	-	+	-		+	-	+	-
cyan	+	-	-	+		-	-	-
green	+	-	-	+	-		-	-
yellow	+	-	+	+	-	-		+
red	-	+	-	-	-	-	+	

+ Colour combination very suitable

- Colour combination not suitable because colour hues are too close together, thin characters are not identifiable or rigorous focusing is demanded of the human eye.

# Explanatory information about standard ISO 9241-307

## Permanently unlit or lit pixels

Today's production techniques cannot guarantee an absolutely fault-free screen display. Depending on the total number of pixels (resolution), there may be a few constantly lit or unlit pixels or subpixels.

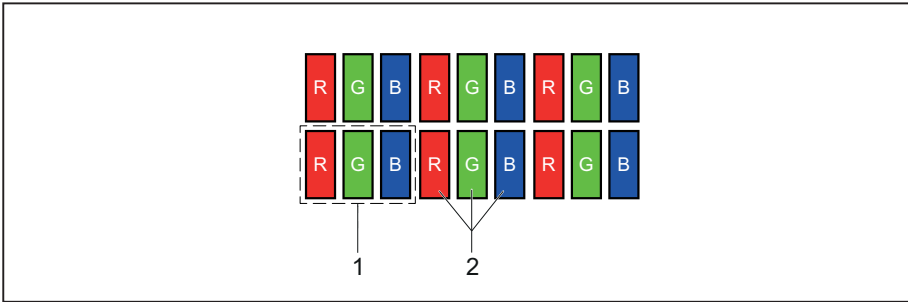

1 = Pixel

2 = Subpixel

Pixel	A pixel consists of 3 subpixels, normally red, green and blue. A pixel is the smallest element that can be generated by complete functionality of the display.
Subpixel	A subpixel is a separately addressable internal structure within a pixel that enhances the pixel function.
Pixel fault	All 3 subpixels are lit/unlit. The result is a brighter or darker pixel.
Subpixel fault	Only one subpixel is lit/unlit. The result is a pixel with missing colours.

The maximum permitted number of faulty pixels is stipulated in the international standard ISO 9241-307. The LCD displays from Fujitsu comply to at least Class I. Fujitsu guarantees displays that are free of pixel faults, so that only subpixel faults may occur.

### Examples:

A flat-screen display with a resolution of 1280 x 1024 has  $1280 \times 1024 = 1310720$  pixels. Each pixel consists of three subpixels (red, green and blue), making a total of about 3.9 million subpixels. According to ISO 9241-3 (Class II), a maximum of 3 lit and 3 unlit pixels plus 7 lit or 13 unlit subpixels, or a corresponding combination, may be faulty (1 lit subpixel counts as two unlit subpixels).

A flat-screen display with a resolution of 1920 x 1200 has  $1920 \times 1200 = 2304000$  pixels. Each pixel consists of three subpixels (red, green and blue), making a total of about 6.9 million subpixels. According to ISO 9241-3 (Class I), a maximum of 2 lit and 2 unlit pixels plus 5 lit or 11 unlit subpixels, or a corresponding combination, may be faulty (1 lit subpixel counts as two unlit subpixels). Because Fujitsu supplies displays that are free of pixel faults, only subpixel faults enter into the evaluation.

# Troubleshooting

Should an error occur, first check the following points. If the distortion is still not eliminated, the monitor should, if possible, be checked on another computer.

If you cannot solve the problem, please contact our Service Desk.

Having this problem?	Check the following points:
No screen display Power indicator is lit	<ul style="list-style-type: none"> <li>▶ Check whether the computer is switched on.</li> <li>▶ Check whether the data cable for the monitor is correctly screwed into the monitor port on the computer.</li> <li>▶ Press any key on the computer keyboard. The computer may be in power saving mode.</li> <li>▶ Alter the brightness and/or contrast until you get a picture.</li> </ul>
Message: No Signal	<ul style="list-style-type: none"> <li>▶ Check whether the data cable for the monitor is correctly screwed into the monitor port on the computer.</li> <li>▶ Check whether the computer is switched on.</li> </ul>
Message: Frequency out of range : ## kHz / ## Hz Please change the display mode to 1920 x 1200 with 60 Hz	The input signal (horizontal frequency and refresh rate) at the displayed input does not correspond to the technical data for the monitor. <ul style="list-style-type: none"> <li>▶ Reboot the system after connecting to the monitor. The VGA interface does not support "Hot Plugging".</li> <li>▶ Adjust the video frequency range using the computer software (see documentation for the computer or display adapter).</li> <li>▶ Set a different screen resolution using the computer software (see documentation for the computer or display adapter).</li> </ul>

Having this problem?	Check the following points:
Picture position not correct	<p>The monitor recognises an undefined mode (see chapter <a href="#">"Technical specification", Page 44</a>).</p> <ul style="list-style-type: none"> <li>▶ Run the function <i>Auto adjust</i> (see Chapter <a href="#">"Setting screen display", Page 22</a>).</li> </ul>
Picture is shaking	<ul style="list-style-type: none"> <li>▶ Check whether the data cable for the monitor is correctly screwed into the monitor port on the computer.</li> <li>▶ Run the function <i>Auto adjust</i> (see Chapter <a href="#">"Setting screen display", Page 22</a>).</li> </ul>
Picture is wrongly adjusted	<ul style="list-style-type: none"> <li>▶ Run the function <i>Factory Recall</i> (see Chapter <a href="#">"Advanced setting functions", Page 26</a>).</li> </ul> <p>The <i>Auto Processing</i> message appears.</p>
Picture disturbances (vertical lines)	<ul style="list-style-type: none"> <li>▶ Run the function <i>Auto adjust</i> (see Chapter <a href="#">"Setting screen display", Page 22</a>).</li> </ul>
Picture disturbances (horizontal lines, picture noise)	<ul style="list-style-type: none"> <li>▶ Run the function <i>Auto adjust</i> (see Chapter <a href="#">"Setting screen display", Page 22</a>).</li> </ul>
The screen becomes darker	<p>The background lighting has a limited lifetime. If your monitor display should become too dark, the background lighting will have to be replaced.</p> <ul style="list-style-type: none"> <li>▶ Contact our Service Desk.</li> </ul>

# Technical specification



Condensation is not permitted, neither in the rated range of operation nor in the limit range of operation.

<b>Product name</b>		<b>B24-9 WE/B24-9 WS</b>
Name of model		B24-9W
<b>Dimensions and weight</b>		
Visible diagonals		61.13 cm
Dot pitch		0.27 mm
Image size	Width	518.4 mm
	Height	324.0 mm
Maximum resolution		1920 x 1200
Dimensions incl. monitor base	Width	531.8 mm
	Height (min.)	367.7 mm
	Depth	212.7 mm
Weight (without packaging)		5.6 kg
Storable display modes		39
Pixel error classes according to ISO 9241-307	Class	I
<b>Electrical data</b>		
Video	Analog	Positive, 0.7 V <sub>pp</sub> , 75 Ω
	Digital	DisplayPort / HDMI
Synchronisation		Separate Sync. TTL, positive or negative
Horizontal frequency		30 kHz .... 82 kHz (multi-scanning)
Refresh rate		48 Hz .... 76 Hz
Maximum pixel rate		VGA: 165 MHz HDMI: 165 MHz DP: 165 MHz
Power supply		Switches automatically 100 V – 240 V, 50/60 Hz
Total power consumption (without audio, USB)	Normal operation	22 W
	ECO operating mode	17 W
	Power saving mode	0.2 W
Sound output		2 W left; 2 W right



### Environmental conditions

Environment class 3K2, DIN IEC 721

Rated range of operation	15 °C .... 35 °C
Humidity	20 % .... 85 %
Limit range of operation	5 °C .... 35 °C
Humidity	15 % .... 85 %

## VESA-DDC-compatible VGA interface

Your monitor is equipped with a VESA-DDC-compatible VGA interface. VESA-DDC (Video Electronics Standard Association, Display Data Channel) is used as the communications interface between the monitor and the computer. If the computer is equipped with a VESA-DDC-compatible VGA interface, it can automatically read the data for ensuring optimum operation from the monitor and select the appropriate settings.

## Preset operating modes



The picture position and size have been set to optimum values at the factory for the operating modes listed above. Depending on the display adapter used, it may be necessary to adjust the picture position and size. In this case, you can change and save the settings (see chapter ["Changing the monitor settings", Page 20](#)).

For ergonomic reasons, a screen resolution of 1920 x 1200 pixels is recommended. Because of the technology used (active matrix), an LCD monitor provides a totally flicker-free picture, even with a refresh rate of 60 Hz.

## Most frequent operating modes

Screen resolution	Refresh rate
640 x 480	60/75 Hz
720 x 400	70 Hz
800 x 600	60/75 Hz
1024 x 768	60/75 Hz
1280 x 720	60 Hz
1280 x 1024	60/75 Hz (SXGA)
1440 x 900	60 Hz (WXGA+)
1600 x 900	60 Hz (HD+)
1680 x 1050	60 Hz (WSXGA+)
1920 x 1080	60 Hz (FHD)
1920 x 1200	60 Hz (WUXGA)

## Video/TV operating modes via digital video inputs

Screen resolution	Refresh rate	Aspect ratio
640 x 480 p	60 Hz	4:3
720 x 576 p	50 Hz	4:3 / 16:9
1280 x 720 p	50 / 60 Hz	4:3 / 16:9
1920 x 1080 p	50 / 60 Hz	4:3 / 16:9

## SUB D port

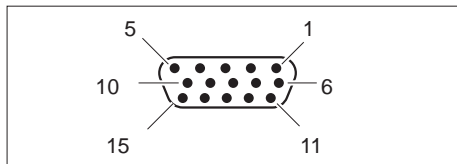

Pin	Meaning
1	Video input red
2	Video input green
3	Video input blue
4	Ground
5	Ground
6	Video ground red
7	Video ground green
8	Video ground blue
9	+5 V (DDC)
10	Sync. ground
11	Ground
12	DDC Data
13	H. sync
14	V. sync
15	DDC Clock

## HDMI port

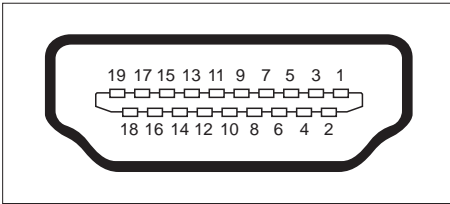

Pin	Meaning
1	TMDS Data2+
2	TMDS Data2 Shield
3	TMDS Data2-
4	TMDS Data1+
5	TMDS Data1 Shield
6	TMDS Data1-
7	TMDS Data0+
8	TMDS Data0 Shield
9	TMDS Data0-
10	TMDS Clock+
11	TMDS Clock Shield
12	TMDS Clock-
13	CEC
14	N.C.
15	SCL
16	SDA
17	DDC/CEC Ground
18	+5 V Power
19	Hot plug detect

# Displayport socket

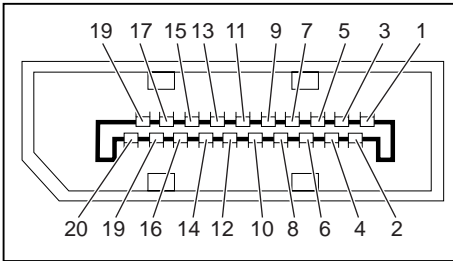

Pin	Meaning
1	Lane 3 (negative)
2	Earth
3	Lane 3 (positive)
4	Lane 2 (negative)
5	Earth
6	Lane 2 (positive)
7	Lane 1 (negative)
8	Earth
9	Lane 1 (positive)
10	Lane 0 (negative)
11	Earth
12	Lane 0 (positive)
13	Connected to earth
14	Connected to earth
15	Auxiliary channel (positive)
16	Earth
17	Auxiliary channel (negative)
18	Hot Plug Detect
19	Return for Power
20	Power for connector (3.3 V 500 mA)