

Quick Setup

IMPORTANT: Before using the projector, make sure you read these instructions and the safety instructions in the online *User's Guide*.

Note: Your product may differ from the illustrations on this sheet, but the instructions are the same.

Connect the projector

Computer

Choose from the following connections. See the sections below or the online *User's Guide* for details.

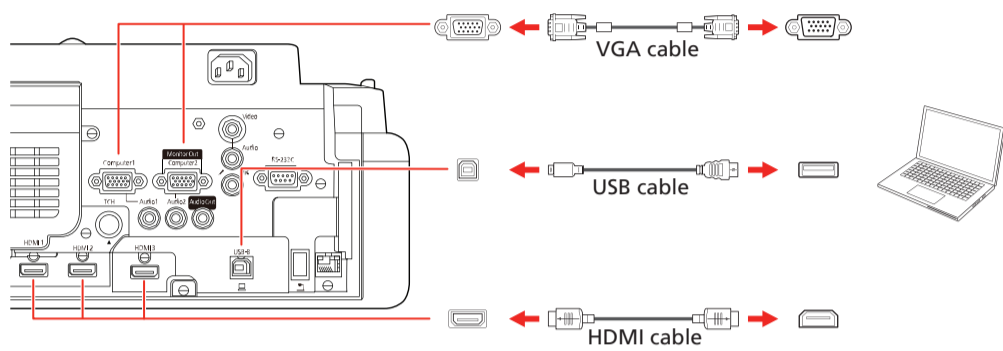

HDMI port

Connect one end of an HDMI cable to one of the projector's **HDMI** ports and the other end to an HDMI port on your computer.

Computer port

Connect one end of a VGA cable to one of the projector's **Computer** ports, and the other end to your computer's  monitor port. If you are using a laptop, switch it to external display (see "Troubleshooting"). You can also connect an audio cable.

USB port

Connect the square end of a USB cable to the projector's **USB-B** (square) port. Connect the flat end of the cable to any USB port on your computer.

Windows® 7 or later: After turning on the projector, follow the on-screen instructions to install the Epson® USB Display software (**EMP_UDSE.EXE**; only on first connection). If the software screen does not display automatically, open **My Computer, Computer, or This PC**, then double-click **EPSON_PJ_UD**.

OS X 10.8.x or higher: After turning on the projector, the setup folder for USB Display appears in the Finder. Double-click **USB Display Installer** and follow the on-screen instructions to install the Epson USB Display software (only on first connection). If the software screen does not display automatically, double-click **EPSON_PJ_UD**, then double-click **USB Display Installer**.

External monitor and speakers

You can connect an external monitor and external speakers to your projector to enhance your presentations. See the online *User's Guide* for details.

Wired network

Connect the projector to your network using an Ethernet cable. See "Wired network configuration" for more information.

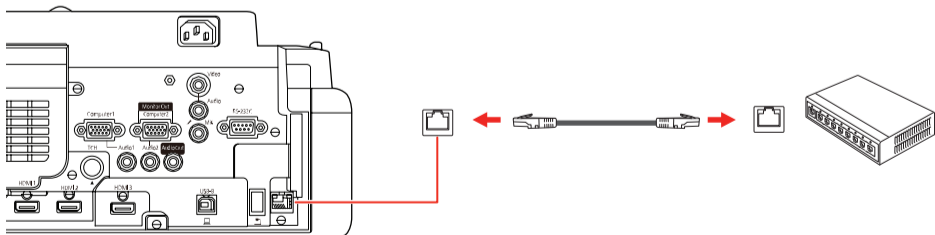

Microphone

Connect a dynamic microphone to the **Mic** port, using a 3.5 mm mini-jack cable.

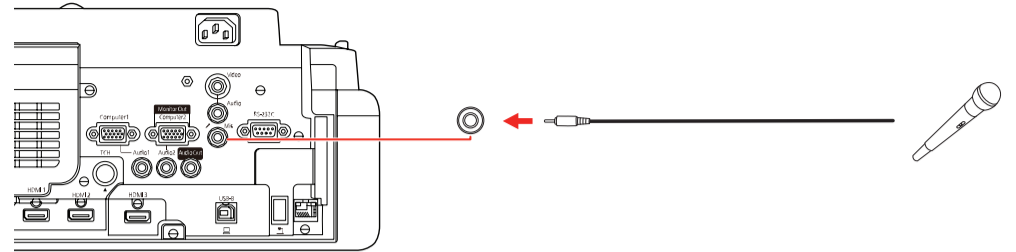

Video device

Connect multiple video devices and use the **Source Search** button on the projector or remote control to switch between them. For more information on playing sound through the projector, see the online *User's Guide*.

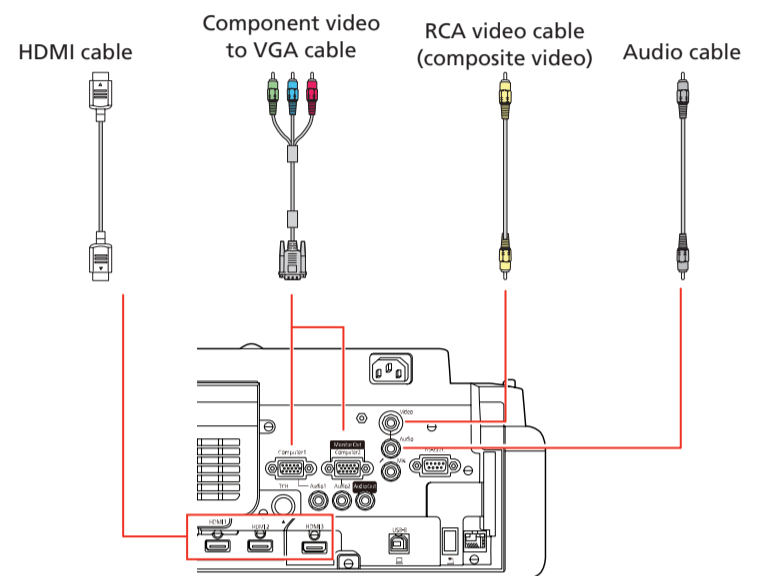

Camera, USB device, or document camera

Connect a digital camera, USB flash drive, USB storage device, or Epson DC-07 document camera to the projector's USB-A (flat) port.

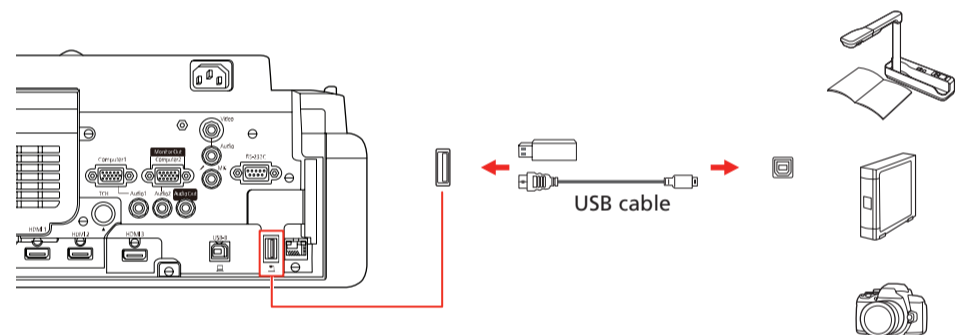

If you connect a digital camera, USB flash drive, or USB storage device, you can use the projector's PC Free feature. You can also connect other Epson document cameras to the projector. See the online *User's Guide* for details.



Using the remote control

Install the two AA batteries as shown.

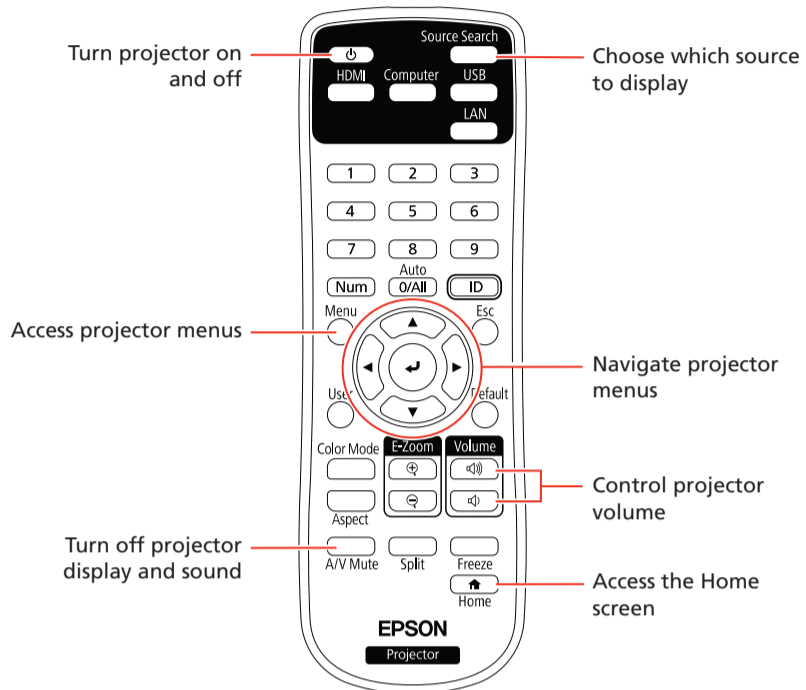
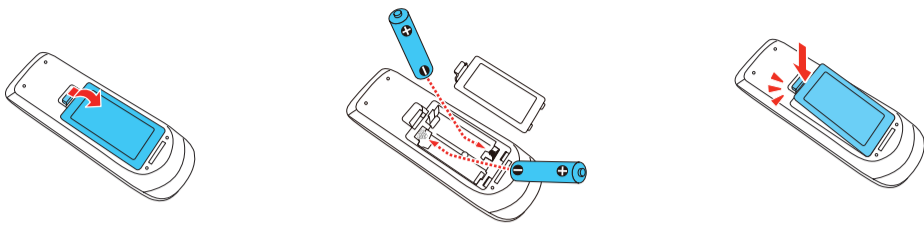

For more information on using the remote control, see the online *User's Guide*.

Turn on your equipment

- 1 Turn on your computer or video source.
- 2 Make sure the power cord is connected and plugged into an electrical outlet.

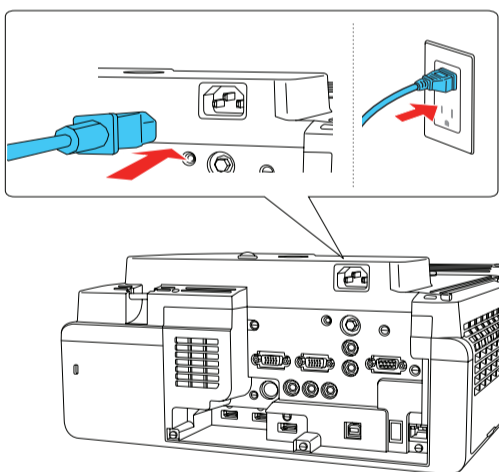

- 3 Press the power button on the projector or remote control. The projector beeps, and the Status light flashes blue and then stays on.

Note: To shut down the projector, press the power button twice.

- 4 If you don't see an image, press the **Source Search** button on the remote control to select the image source.

Note: If you still see a blank screen or have other display problems, see the troubleshooting tips on the back of this sheet.

- 5 If you need to focus the image, first slide the switch on the side of the projector to open the air filter cover. Then raise or lower the focus lever to sharpen the image.

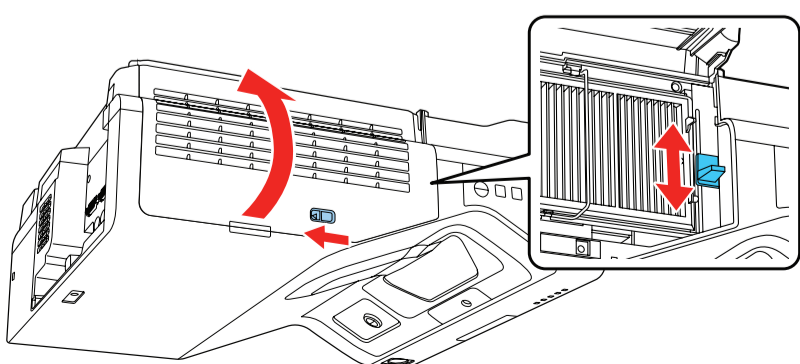

- 6 Use the arrow buttons on the remote control to highlight any of the options on the Home screen, then press to select it.
- 7 The default language of the menu system is English. To select another language, press the **Menu** button on the remote control. Select **Management** and press . Select **Language** and press . Select your language and press . Press the **Menu** button to exit the menu system.

Wireless network configuration

Follow these steps to set up the projector for a wireless network connection.

- 1 Press the **Menu** button on the remote control.
- 2 Select the **Management** menu and press .

Frequently Used Items	Management
Image	User Button
Signal I/O	User's Logo
Installation	User Pattern
Display	Control Panel Lock
Operation	Color Uniformity
	Refresh Mode
	Light Source Calibration
	Date & Time
	Schedule Settings
	Wireless LAN Power
	Wireless LAN Diagnosis
	Log Save Destination
	Batch Setup Range
	Language
	Information
	Display Logs
	Reset Management Settings

- 3 Select **On** as the **Wireless LAN Power** setting.
- 4 Select the **Network** menu and press .
- 5 Select **Network Settings** and press .
- 6 Select **Wireless LAN** as the **Priority Control Interface** setting.
- 7 Select one of the following as the **Simple AP** setting:

- **On** for a direct connection to a computer, tablet, or smartphone.
- **Off** to connect your projector to a router or access point.

Note: If you directly connect to the projector, you can only project locally-stored content.

- 8 Select any other wireless settings as necessary. See the online *User's Guide* for details.
- 9 When you are finished, return to the Network Settings menu and select **Set** to apply your settings.

Wired network configuration

Follow these steps to set up your projector for a wired network connection.

- 1 Press the **Menu** button on the remote control, select the **Network** menu, then press **↵**.
- 2 Choose **Network Settings** and press **↵**.
- 3 Select **Wired LAN** as the **Priority Control Interface** setting.
- 4 Select the **Wired LAN** menu and press **↵**.

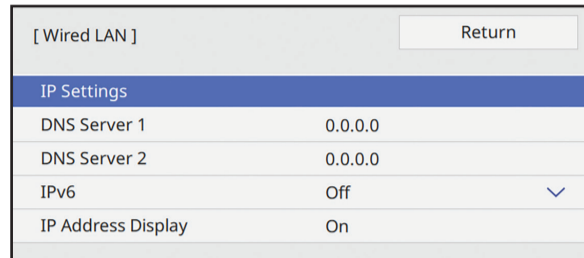

- 5 Choose **IP Settings** and press **↵**.
- 6 If your network assigns addresses automatically, make sure the **DHCP** setting is on. If not, make sure DHCP is off and enter the projector's **IP Address**, **Subnet Mask**, and **Gateway Address**, as needed. Then press **Esc**.
- 7 To prevent the IP address from appearing on the network standby screen, set the **IP Address Display** setting to **Off**.
- 8 When you are finished, return to the Network Settings menu and select **Set** to apply your settings.
- 9 Press the **Menu** button to exit the menu system.

Install the optional software

Download the Epson iProjection™ software and manual from your product's support page (see "Where to get help") and install the program on each computer that will project over the network.

To monitor and control your projector over the network, download and install the Epson Projector Management software (Windows only) and manual from your product's support page (see "Where to get help").

Project over a network

If you need to configure the projector for a wired network, see "Wired network configuration" on the back of this sheet.

- 1 Press the **LAN** button on the remote control. You see this screen:

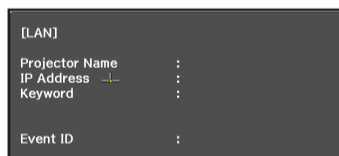

- 2 Start Epson iProjection on your computer.

Windows 10: Select  > **EPSON Projector** > **Epson iProjection Ver X.XX**.

Windows 8.x: Navigate to the **Apps** screen and select **Epson iProjection Ver. X.XX**.

Windows 7: Select  or **Start** > **Programs** or **All Programs** > **EPSON Projector** > **Epson iProjection** > **Epson iProjection Ver X.XX**.

macOS: Double-click the **Epson iProjection** icon in the Applications folder.

- 3 Select **Advanced Connection Mode** and click **OK**.

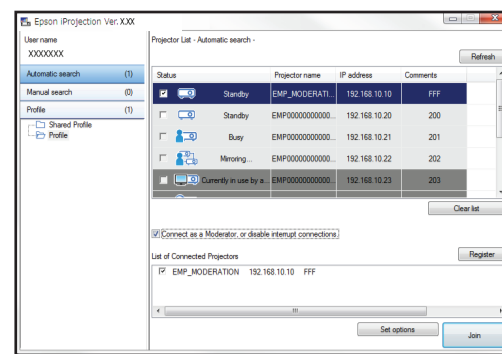

- 4 Select the projector you want to connect to, then click **Join**.

If you don't see the projector you want, click the **Automatic search** button to find the projector automatically, click the **Manual search** button to enter the projector's IP address, or click the **Profile** button to find the projector based on a previously saved profile.

- 5 If you see a message asking for a keyword, enter the four digits that appear on the LAN standby screen and click **OK**.

Your computer image is projected, with a floating toolbar:



When you're done presenting, click **Disconnect All** on the toolbar.

Using the Epson iProjection app

You can project wirelessly from a mobile device (iOS, Android™, or Chromebook™) using the Epson iProjection app and a QR code.

- 1 Use the following QR code to download and install the Epson iProjection app.



- 2 If you connected the projector to a network wirelessly, make sure to connect your mobile device to the same network.
- 3 Press the **LAN** button on the remote control to display a QR code on the projector screen.
- 4 Start Epson iProjection on your mobile device.
- 5 Use the QR code reader feature to read the QR code displayed.



- 6 Follow the app instructions to connect your device to the projector.

For more information on setting up and using this app, visit www.epson.com/projectorapp (U.S.), www.epson.ca/projectorapp (Canada) or www.latin.epson.com/iprojection (Caribbean).

Using web remote

You can use a standard web browser to control the projector through the network. A virtual remote control on your computer screen lets you perform many of the same functions as you can with the physical remote control.

- 1 Open your web browser and enter the IP address of the projector you want to monitor in the browser's address bar.

If you're not sure what the IP address of the projector is, turn the projector on and select **Wired LAN Info** or **Wireless LAN Info** from the Network menu to display the IP address of the projector. (Do not enter the leading zeroes.)
- 2 Enter **EPSONWEB** as the default user name and **admin** as the default password, then click **OK**. The Epson Web Control menu opens.
- 3 Select **Basic Control**. If you see a login screen, enter **EPSONREMOTE** as the user name and **guest** as the password.
- 4 Use the on-screen buttons to operate the projector, as you would using the remote control. See the online *User's Guide* for details.

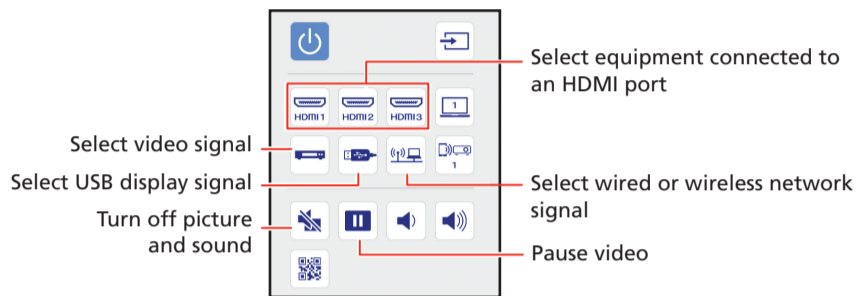

Troubleshooting

If you see a blank screen or the **No signal** message after turning on your computer or video device, check the following:

- Make sure the Status light on the projector is blue and not flashing.
- Press the **Source Search** button on the projector or the remote control to switch to the correct image source, if necessary.
- Press the **Home** button on the projector or remote control to verify the source input and settings.
- On Windows 7 or later, hold down the Windows key and press **P** at the same time, then click **Duplicate**.
- If you're using a Windows laptop, press the function key on your keyboard that lets you display on an external monitor. It may be labeled **CRT/LCD** or have an icon such as . You may have to hold down the **Fn** key while pressing it (such as **Fn + F7**). Wait a moment for the display to appear.
- If you're using a Mac laptop, open **System Preferences** and select **Displays**. Click the **Arrangement** tab and select the **Mirror Displays** checkbox.

Registration

Register today to get product updates and exclusive offers. You can register online at www.epson.com/webreg.

Where to get help

Manuals

For more information about using the projector, see the online manuals. You can view or download the manuals from the Epson website, as described below.

Internet support services

Visit www.epson.com/support (U.S.) or www.epson.ca/support (Canada) and search for your product to download software and utilities, view manuals, get FAQs and troubleshooting advice, or contact Epson.

Telephone support

To use the Epson PrivateLine® Support service, call (800) 637-7661. This service is available for the duration of your warranty period. You may also speak with a support specialist by calling (562) 276-4394 (U.S.) or (905) 709-3839 (Canada).

Support hours are 6 AM to 8 PM, Pacific Time, Monday through Friday, and 7 AM to 4 PM, Pacific Time, Saturday. Days and hours of support are subject to change without notice. Toll or long distance charges may apply.

Optional accessories

For a list of optional accessories, see the online *User's Guide*.

You can purchase screens or other accessories from an Epson authorized reseller. To find the nearest reseller, call 800-GO-EPSON (800-463-7766). Or you can purchase online at www.epsonstore.com (U.S. sales) or www.epsonstore.ca (Canadian sales).



EPSON and PowerLite are registered trademarks, Epson iProjection is a trademark, and EPSON Exceed Your Vision is a registered logomark of Seiko Epson Corporation.

PrivateLine is a registered trademark of Epson America, Inc.

Mac, macOS, and OS X are trademarks of Apple Inc., registered in the U.S. and other countries.

Windows is a registered trademark of Microsoft Corporation in the United States and/or other countries.

Android and Chromebook are trademarks of Google LLC.

General Notice: Other product names used herein are for identification purposes only and may be trademarks of their respective owners. Epson disclaims any and all rights in those marks.

This information is subject to change without notice.

© 2020 Epson America, Inc., 6/20