

# PHILIPS

## Momentum

329M1



[www.philips.com/welcome](http://www.philips.com/welcome)

EN	User manual	1
	Customer care and warranty	28
	Troubleshooting & FAQs	32

# Table of Contents

1. Important .....	1	10. Troubleshooting & FAQs .....	32
1.1 Safety precautions and maintenance .....	1	10.1 Troubleshooting .....	32
1.2 Notational Descriptions .....	3	10.2 General FAQs .....	33
1.3 Disposal of product and packing material .....	4		
2. Setting up the display .....	5		
2.1 Installation .....	5		
2.2 Operating the display .....	8		
2.3 Remove the Base Assembly for VESA Mounting .....	12		
2.4 MultiView .....	13		
3. Image Optimization .....	15		
3.1 SmartImage .....	15		
3.2 SmartContrast .....	17		
3.3 Adaptive Sync .....	18		
4. Ambiglow .....	19		
5. HDR .....	20		
5.1 HDR Settings in Windows 10 system .....	20		
6. Power Delivery and Smart Power .....	21		
7. Technical Specifications .....	22		
7.1 Resolution & Preset Modes ...	25		
8. Power Management .....	27		
9. Customer care and warranty .	28		
9.1 Philips' Flat Panel Displays Pixel Defect Policy .....	28		
9.2 Customer Care & Warranty .....	31		

# 1. Important

This electronic user's guide is intended for anyone who uses the Philips display. Take time to read this user manual before you use your display. It contains important information and notes regarding operating your display.

The Philips guarantee applies provided the product is handled properly for its intended use, in accordance with its operating instructions and upon presentation of the original invoice or cash receipt, indicating the date of purchase, dealer's name and model and production number of the product.

---

## 1.1 Safety precautions and maintenance

### Warnings

Use of controls, adjustments or procedures other than those specified in this documentation may result in exposure to shock, electrical hazards and/or mechanical hazards.

Read and follow these instructions when connecting and using your computer monitor.

Excessive sound pressure from earphones and headphones can cause hearing loss. Adjustment of the equalizer to maximum increases the earphones and headphones output voltage and therefore the sound pressure level.

### Operation

- Please Keep the monitor out of direct sunlight, very strong bright lights and away from any other heat source. Lengthy exposure to this type of environment may result in discoloration and damage to the monitor.
- Oil-based cleaning solutions may damage the plastic parts and void the warranty.
- Remove any object that could fall into ventilation holes or prevent proper cooling of the monitor's electronics.
- Do not block the ventilation holes on the cabinet.
- When positioning the monitor, make sure the power plug and outlet are easily accessible.
- If turning off the monitor by detaching the power cable or DC power cord, wait for 6 seconds before attaching the power cable or DC power cord for normal operation.
- Please use approved power cord provided by Philips all the time. If your power cord is missing, please contact with your local service center. (Please refer to Service contact information listed in Regulation & Service Information Manual.)
- Operate under the specified power supply. Be sure to operate the monitor only with the specified power supply. Use of an incorrect voltage will cause malfunction and may cause fire or electric shock.
- Protect the cable. Do not pull or bend the power cable and signal cable. Do not place the monitor or any other heavy objects on the cables, if damaged, the cables may cause fire or electric shock.
- Do not subject the monitor to severe vibration or high impact conditions during operation.
- To avoid potential damage, for example the panel peeling from the bezel, ensure that the monitor does not tilt downward by more than -5

## i. Important

- degrees. If the -5 degree downward tilt angle maximum is exceeded, the monitor damage will not be covered under warranty.
- Do not knock or drop the monitor during operation or transportation.
  - Excessive usage of monitor can cause eye discomfort, it's better to take shorter breaks more often at your workstation than longer breaks and less often; for example a 5-10 minute break after 50-60-minute continuous screen use is likely to be better than a 15-minute break every two hours. Try to keep your eyes from eye strain while using the screen for a constant period of time by :
    - Looking at something varying distances after a long period focusing on the screen.
    - Conscious Blinking often while you work.
    - Gently closing and rolling your eyes to relax.
    - Reposition your screen to appropriate height and angle according to your height.
    - Adjusting the brightness and contrast to appropriate level.
    - Adjusting the environment lighting similar to that of your screen brightness, avoid the fluorescent lighting, and surfaces that don't reflect too much light.
    - Seeing a doctor if your symptoms.
  - Oil-based cleaning solutions may damage the plastic parts and void the warranty.
  - Unplug the monitor if you are not going to use it for an extensive period of time.
  - Unplug the monitor if you need to clean it with a slightly damp cloth. The screen may be wiped with a dry cloth when the power is off. However, never use organic solvent, such as, alcohol, or ammonia-based liquids to clean your monitor.
  - To avoid the risk of shock or permanent damage to the set, do not expose the monitor to dust, rain, water, or excessive moisture environment.
  - If your monitor gets wet, wipe it with dry cloth as soon as possible.
  - If foreign substance or water gets in your monitor, please turn the power off immediately and disconnect the power cord. Then, remove the foreign substance or water, and send it to the maintenance center.
  - Do not store or use the monitor in locations exposed to heat, direct sunlight or extreme cold.
  - In order to maintain the best performance of your monitor and use it for a longer lifetime, please use the monitor in a location that falls within the following temperature and humidity ranges.
    - Temperature: 0-40°C 32-104°F
    - Humidity: 20-80% RH

## Maintenance

- To protect your monitor from possible damage, do not put excessive pressure on the LCD panel. When moving your monitor, grasp the frame to lift; do not lift the monitor by placing your hand or fingers on the LCD panel.

## Important information for Burn-in/ Ghost image

- Always activate a moving screen saver program when you leave your monitor unattended. Always activate a periodic screen refresh application if your monitor will display unchanging static content.

Uninterrupted display of still or static images over an extended period may cause “Burn-in”, also known as “after-imaging” or “ghost imaging”, on your screen.

- “Burn-in”, “after-imaging”, or “ghost imaging” is a well-known phenomenon in LCD panel technology. In most cases, the “Burn-in” or “after-imaging” or “ghost imaging” will disappear gradually over a period of time after the power has been switched off.

 **Warning**

Failure to activate a screen saver, or a periodic screen refresh application may result in severe “Burn-in” or “after-imaging” or “ghost image” symptoms that will not disappear and cannot be repaired. The damage mentioned above is not covered under your warranty.

**Service**

- The casing cover should be opened only by qualified service personnel.
- If there is any need for any document for repair or integration, please contact with your local service center. (Please refer to Service contact information listed in Regulation & Service Information Manual.)
- For transportation information, please refer to “Technical Specifications”.
- Do not leave your monitor in a car/trunk under direct sun light.

 **Note**

Consult a service technician if the monitor does not operate normally, or you are not sure what procedure to take when the operating instructions given in this manual have been followed.

---

## 1.2 Notational Descriptions

The following subsections describe notational conventions used in this document.

### Notes, Cautions and Warnings

Throughout this guide, blocks of text may be accompanied by an icon and printed in bold or italic type. These blocks contain notes, cautions or warnings. They are used as follows:

 **Note**

This icon indicates important information and tips that help you make better use of your computer system.

 **Caution**

This icon indicates information that tells you how to avoid either potential damage to hardware or loss of data.

 **Warning**

This icon indicates the potential for bodily harm and tells you how to avoid the problem.

Some warnings may appear in alternate formats and may not be accompanied by an icon. In such cases, the specific presentation of the warning is mandated by the relevant regulatory authority.

 **Warning**

The equipment will be not used in the home or similar installation environments where the equipment may be accessible to children.

## 1.3 Disposal of product and packing material

### Waste Electrical and Electronic Equipment-WEEE



This marking on the product or on its packaging illustrates that, under European Directive 2012/19/EU governing used electrical and electronic appliances, this product may not be disposed of with normal household waste. You are responsible for disposal of this equipment through a designated waste electrical and electronic equipment collection. To determine the locations for dropping off such waste electrical and electronic, contact your local government office, the waste disposal organization that serves your household or the store at which you purchased the product.

Your new display contains materials that can be recycled and reused. Specialized companies can recycle your product to increase the amount of reusable materials and to minimize the amount to be disposed of.

All redundant packing material has been omitted. We have done our utmost to make the packaging easily separable into mono materials.

Please find out about the local regulations on how to dispose of your old display and packing from your sales representative.

Taking back/Recycling Information for

### Customers

Philips establishes technically and economically viable objectives to optimize the environmental performance of the organization's product, service and activities.

From the planning, design and production stages, Philips emphasizes the important of making products that can easily be recycled. At Philips, end-of-life management primarily entails participation in national take-back initiatives and recycling programs whenever possible, preferably in cooperation with competitors, which recycle all materials (products and related packaging material) in accordance with all Environmental Laws and taking back program with the contractor company.

Your display is manufactured with high quality materials and components which can be recycled and reused.

To learn more about our recycling program please visit :

<http://www.philips.com/a-w/about/sustainability.html>

## 2. Setting up the display

### 2.1 Installation

#### 1 Package contents

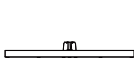
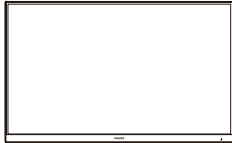

Power



\*HDMI



\*CD



\*DP



\*USB A-B



\*USB C-C

\*Different according to region

#### 2 Install base stand

1. Place the monitor face down on soft and smooth surface taking care to avoid scratching or damaging the screen.

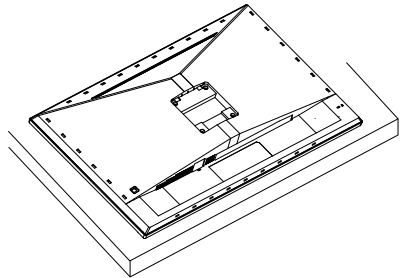

2. Hold the stand with both hands. Gently attach the stand to the VESA mount area until the latch locks the stand.

329M1RV

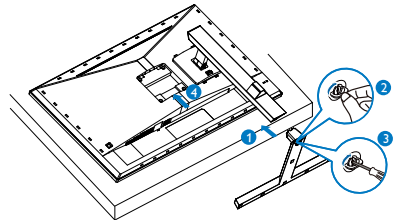

329M1RVE

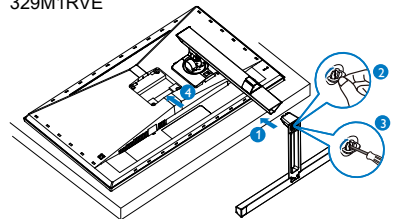

## 2. Setting up the Display

### 3 Connecting to your PC

329MIRV

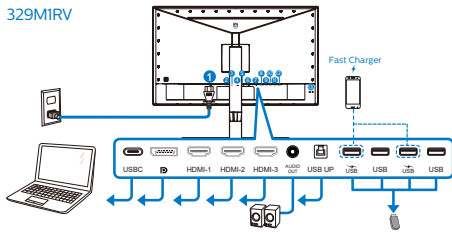

USB Hub

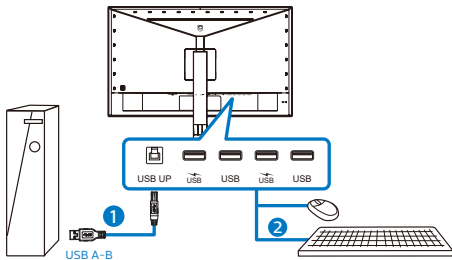

329MIRVE

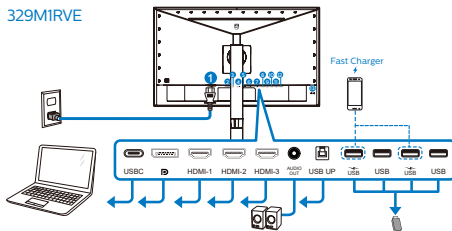

USB Hub

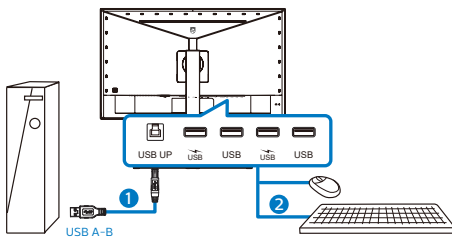

1. AC power input
2. USB C
3. DisplayPort input
4. HDMI-1 input
5. HDMI-2 input
6. HDMI-3 input
7. AUDIO OUT
8. USB UP
9. USB downstream/USB fast charger
10. USB downstream
11. USB downstream/USB fast charger
12. USB downstream
13. Kensington anti-theft lock

#### Connect to PC

1. Connect the power cord to the back of the display firmly.
2. Turn off your computer and unplug its power cable.
3. Connect the display signal cable to the video connector on the back of your computer.
4. Plug the power cord of your computer and your display into a nearby outlet.
5. Turn on your computer and display. If the display displays an image, installation is complete.



#### 4 USB hub

To comply with International energy standards, the USB hub/ports of this display are disabled during Standby and Off modes.

Connected USB devices will not work in this state.

To permanently put the USB function in “ON” state, please go to OSD Menu, then select “USB standby mode”, and switch it to “ON” state. Somehow if your monitor reset to factory setting, ensure to select “USB standby mode” to “ON” state in OSD menu.

#### 5 USB charging

This display has USB ports capable of standard power output including some with USB charging function (identifiable with power icon ). You can use these ports to charge your Smart phone or power your external HDD, for example. The display must be powered ON at all times to be able to use this function.

Some select Philips displays may not Power or Charge your device when it enters to “Sleep/Standby” mode (White power LED blinking). In that case, please enter to OSD Menu and select “USB Standby Mode”, then, turn the function to “ON” mode (default=OFF). This will then keep the USB power and charging functions active even when the monitor is in sleep/standby mode.

Setup	Resolution Notification	On
	USB Standby Mode	Off ✓
	Smart Power	
	CEC	
	Reset	
	Information	

#### Note

If you Turn OFF your monitor via the power switch at any given time, all the USB ports will power OFF.

#### Warning

USB 2.4Ghz wireless devices, such as, wireless mouse, keyboard, and headphones, maybe have interference by the high-speed signal of USB 3.2 devices, which may result in a decreased efficiency of the radio transmission. Should this happen, please try the following methods to help reduce the effects of interference.

- Try to keep USB2.0 receivers away from USB3.2 connection port.
- Use a standard USB extension cable or USB hub to increase the space between your wireless receiver and the USB3.2 connection port.

## 2.2 Operating the display

### 1 Description of the control buttons

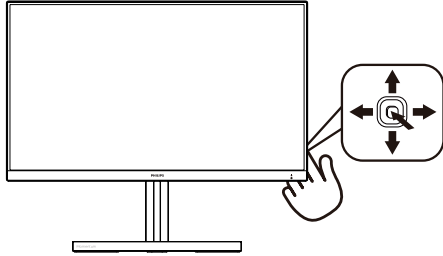

1		Press to switch power on. Press more than 3 seconds to switch power off.
2		Access the OSD menu. Confirm the OSD adjustment.
3		Adjust the Gaming Setting. Adjust the OSD menu.
4		Change the signal input source. Adjust the OSD menu.
5		SmartImage Game menu. There are multiple selections: Xbox, FPS, Racing, RTS, Gamer 1, Gamer 2, Movie, Economy, LowBlue Mode, SmartUniformity, Off. When the monitor receives HDR signal, SmartImage will show HDR menu. There are multiple selections: Xbox, HDR Game, HDR Movie, HDR Photo, DisplayHDR 400, Personal, Off. Return to previous OSD level.

### 2 EasyLink (CEC)

What is it?

HDMI is a single cable to carry both picture and audio signals from your devices to your monitor, saving you from cable clutter. It carries uncompressed signals, ensuring that you have the highest quality from source to screen. HDMI-connected monitors with Philips EasyLink (CEC) allow you to control functions of multiple connected devices with one remote control. Enjoy high quality picture and sound without clutter or fuss.

How to enable EasyLink (CEC)

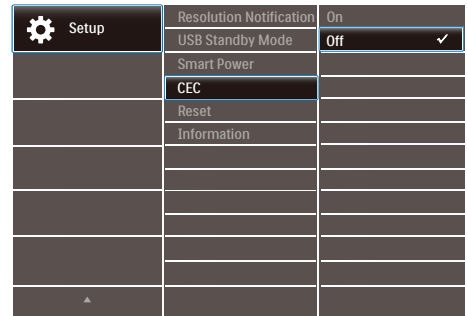

1. Connect an HDMI-CEC compliant device through HDMI.
2. Configure the HDMI-CEC compliant device properly.
3. Switch on EasyLink(CEC) of this display by toggling to the right to enter OSD.
4. Select [Setup] > [CEC].
5. Select [On], and then confirm the selection.
6. Now, you can turn on or off both your device and this display using the same remote control.

## 2. Setting up the Display

### Note

1. The EasyLink-compliant device must be switched on and selected as the source.
2. Philips does not guarantee 100% interoperability with all HDMI CEC devices.

### 3 Description of the On Screen Display

What is On-Screen Display (OSD)?

On-Screen Display (OSD) is a feature in all Philips LCD displays. It allows an end user to adjust screen performance or select functions of the displays directly through an on-screen instruction window. A user friendly on screen display interface is shown as below:

Ambiglow	Follow Video	
	Follow Audio	
Game Setting	Color Shift	Clockwise
	Color Wave	Clockwise
LowBlue Mode	Color Breathing	
	Starry Night	
Input	Static Mode	
	Your Color	Blue
HDMI Refresh Rate	Light Position	All-around
	Speed	Low
Picture	Brightness	Bright
	Off	✓

Basic and simple instruction on the control keys

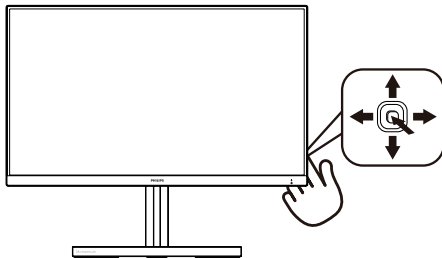

To access the OSD menu on this Philips display simply use the single toggle button on the backside of the display bezel. The single button operates like a joystick. To move the cursor, simply toggle the button in four directions. Press the button to select desired option.

### The OSD Menu

Below is an overall view of the structure of the On-Screen Display. You can use this as a reference when you want to work your way around the different adjustments later on.

## 2. Setting up the Display

Main menu	Sub menu	
Ambiglow	Follow Video	
	Follow Audio	
	Color Shift	Clockwise, Anticlockwise
	Color Wave	Clockwise, Anticlockwise
	Color Breathing	
	Starry Night	
	Static Mode	
	Your Color	Rainbow, White, Red, Rose, Magenta, Violet, Blue, Azure, Cyan, Aquamarine, Green, Chartrreuse, Yellow, Orange
	Light Position	All-around, Top/Left/Right, Left/Right, Bottom
	Speed	Low, Normal, High
	Brightness	Bright, Brighter, Brightest
	Off	
	Game Setting	MPRT
MPRT Level		0-20
Crosshair		On, Off
Low Input Lag		On, Off
SmartResponse		Off, Fast, Faster, Fastest
SmartFrame		On, Off
Size (1,2,3,4,5,6,7)		Size (1,2,3,4,5,6,7)
Brightness (0-100)		Brightness (0-100)
Contrast (0-100)		Contrast (0-100)
H. position		H. position
V. position	V. position	
1,2,3,4	1,2,3,4	
LowBlue Mode	On	
	Off	
Input	1 HDMI 2.1	
	2 HDMI 2.1	
	3 HDMI 2.1	
	DisplayPort	
	USB C	
	Auto	
HDMI Refresh Rate	HDMI 1	120Hz, 144Hz
	HDMI 2	120Hz, 144Hz
	HDMI 3	120Hz, 144Hz
Picture	SmartImage	Xbox/FPS/Racing/RTS/Gamer 1/Game2/ Movie/ Economy/ LowBlue Mode/SmartUniformity/Off
	SmartImage HDR	Xbox/HDR Game/ HDR Movie/ HDR Photo/ DisplayHDR 400/ Personal / Off
	Brightness	(0-100)
	Contrast	(0-100)
	Sharpness	(0-100)
	Saturation	(0-100)
	SmartContrast	On, Off
	Gamma	(1.8, 2.0, 2.2, 2.4, 2.6)
	Over Scan	On, Off
	Off, PBP	Off, PBP
PBP	PBP Mode	Off, PBP
	PBP Input Swap	1 HDMI 2.1, 2 HDMI 2.1, 3 HDMI 2.1, DisplayPort, USB C
SmartSize	Panel Size	17" (5:4), 19" (5:4), 19"W (16:10), 22"W (16:10), 18.5"W (16:9), 19.5"W (16:9), 20"W (16:9), 21.5"W (16:9), 23"W (16:9), 24"W (16:9), 27"W (16:9), 32"W
	1:1	
	Aspect	
Audio	Volume	0-100
	Mute	On, Off
	Audio Source	HDMI1, HDMI2, HDMI3, DisplayPort, USB C
	DTS Sound	Standard/Game/Classical/Rock/Live/Theater/Off
	TruVolume HD	On, Off
EQ	100Hz, 300Hz, 1KHz, 3KHz, 10KHz	
Color	Color Temperature	Native, 5000K, 6500K, 7500K, 8200K, 9300K, 11500K
	sRGB	
	User Define	Red: 0-100 Green: 0-100 Blue: 0-100
Language	English, Deutsch, Español, Ελληνικά, Français, Italiano, Māryang, Nederlands, Português, Português do Brasil, Polski, Русский, Svenska, Suomi, Türkçe, Čeština, Українська, 简体中文, 繁體中文, 日本語, 한국어	
OSD Settings	Horizontal	0-100
	Vertical	0-100
	Transparency	Off, 1, 2, 3, 4
	OSD Time Out	5s, 10s, 20s, 30s, 60s
Setup	Resolution Notification	On, Off
	USB Standby Mode	On, Off
	Smart Power	On, Off
	CEC	On, Off
	Reset	Yes, No
	Information	

### Note

- MPRT: To reduce motion blur, LED backlight will strobe synchronously with screen refresh, which may cause noticeable brightness change.
- 75Hz refresh rate or higher is required for MPRT.
- Adaptive Sync and MPRT cannot be enabled simultaneously.
- MPRT is to adjust brightness for blur reduction, so cannot adjust brightness while MPRT is turned on.
- MPRT is gaming-optimized mode. Turn on MPRT may cause noticeable screen flickering. It is recommended to turn off when you are not using the gaming function.

### Note

Xbox: Level up your gaming experience while playing Xbox games, you can even control the connected Xbox console using the remote control.

## 4 Resolution notification

This display is designed for optimal performance at its native resolution, 3840 X 2160 . When the display is powered on at a different resolution, an alert is displayed on screen: Use 3840 X 2160 for best results.

Display of the native resolution alert can be switched off from Setup in the OSD (On Screen Display) menu.

5 Physical Function

Tilt

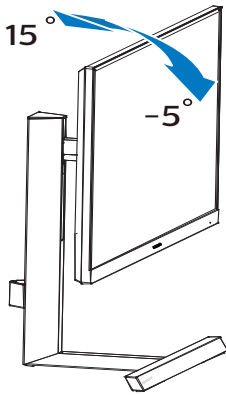

Height adjustment

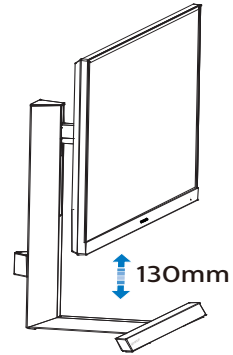

329M1RVE

Pivot

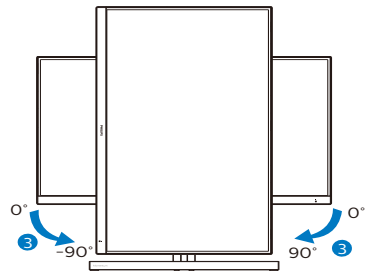

Swivel

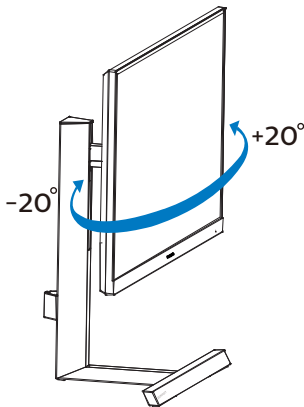

 Warning

- To avoid potential screen damage, such as panel peeling, ensure that the monitor does not tilt downward by more than -5 degrees.
- Do not press the screen while adjusting the angle of the monitor. Grasp only the bezel.

## 2.3 Remove the Base Assembly for VESA Mounting

Before you start disassembling the Display base, please follow the instructions below to avoid any possible damage or injury.

1. Place the monitor face down on soft and smooth surface taking care to avoid scratching or damaging the screen.

329M1RV

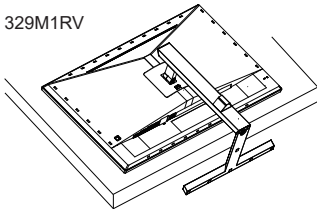

329M1RVE

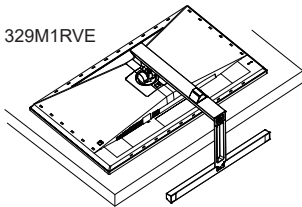

2. While keeping the release button pressed, tilt the stand and slide it out.

329M1RV

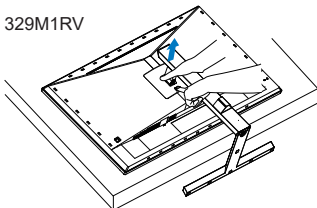

329M1RVE

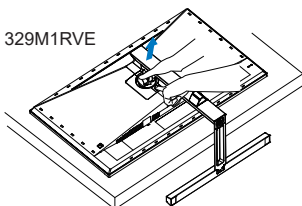

### Note

This monitor accepts a 100mm x 100mm VESA-Compliant mounting interface. VESA Mounting Screw M4. Always contact manufacturer for wall-mount installation.

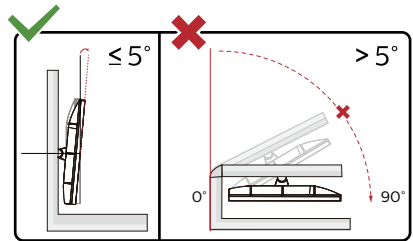
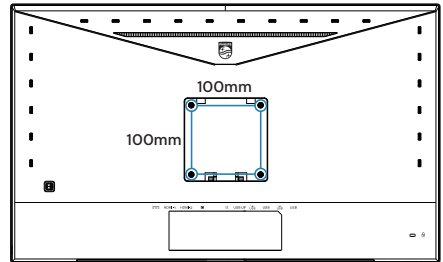

\* Display design may differ from those illustrated.

### Warning

- To avoid potential screen damage, such as panel peeling, ensure that the monitor does not tilt downward by more than  $-5$  degrees.
- Do not press the screen while adjusting the angle of the monitor. Grasp only the bezel.

## 2.4 MultiView

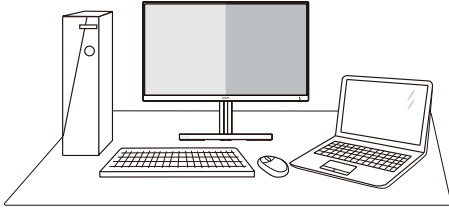

### 1 What is it?

Multiview enables active variety connect and view so that you can work with multiple devices like PC and Notebook side-by-side simultaneously, making complex multi-tasking work a breeze.

### 2 Why do I need it?

With the ultra high resolution Philips MultiView display, you can experience a world of connectivity in a comfortable way in the office or at home. With this display, you can conveniently enjoy multiple content sources at one screen. For example: You may want to keep an eye on the live news video feed with audio in the small window, while working on your latest blog, or you may want to edit an Excel file from your Ultrabook, while logged into secured company intranet to access files from a desktop.

### 3 How to enable MultiView by OSD menu?

PBP	PBP Mode	Off
SmartSize	PBP Input	2.HDMI 2.1
Audio	Swap	
Color		
Language		
OSD Setting		

1. Toggle to the right to enter OSD Menu Screen.
2. Toggle to the up or down to select main menu [PBP], then toggle to the right to confirm.
3. Toggle to the up or down to select [PBP Mode], then toggle to the right.
4. Toggle to the up or down to select [PBP], then toggle to the right to confirm your selection.
5. Now you can move backward to set the [PBP Mode], [PBP Input], or [Swap].
6. Toggle to the right to confirm your selection.

### 4 MultiView in OSD menu

[PBP]: Picture by Picture

Open up a sub-window side-by-side of another signal source.



When the sub source is not detected:



#### Note

The black strip shows on the top and the bottom of the screen for the correct aspect ratio when in the PBP mode. If you expect to see full screen side by side, adjust your devices resolution as pop up attention resolution, and make sure graphic card's resolution is set to '1920 x 2160 at 60Hz'.

## 2. Setting up the Display

**[PBP Input]:** There are 5 different video inputs to choose as the sub display source: **[1 HDMI 2.1]**, **[2 HDMI 2.1]**, **[3 HDMI 2.1]**, **[DisplayPort]**, **[USB C]**.

 MultiView		SUB SOURCE POSSIBILITY (x1)				
		Inputs	HDMI 1	HDMI 2	HDMI 3	DisplayPort
MAIN SOURCE (x1)	HDMI 1	•	•	•	•	•
	HDMI 2	•	•	•	•	•
	HDMI 3	•	•	•	•	•
	DisplayPort	•	•	•	•	•
	USB C	•	•	•	•	•

**[Swap]:** The main picture source and the sub picture source swapped on the display.

Swap A and B source in **[PBP]** mode:

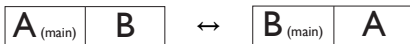

- **Off:** Stop MultiView function.

### Note

When you do the SWAP function, the video and its audio source will swap at the same time.



## 3. Image Optimization

### 3.1 SmartImage

#### 1 What is it?

SmartImage provides presets that optimize display for different types of content, dynamically adjusting brightness, contrast, color and sharpness in real time. Whether you're working with text applications, displaying images or watching a video, Philips SmartImage delivers great optimized display performance.

#### 2 Why do I need it?

You want a display that delivers optimized display all your favorite types of content, SmartImage software dynamically adjust brightness, contrast, color and sharpness in real time to enhance your display viewing experience.

#### 3 How does it work?

SmartImage is an exclusive, leading edge Philips technology that analyzes the content displayed on your screen. Based on a scenario you select, SmartImage dynamically enhances the contrast, color saturation and sharpness of images to enhance the contents being displayed - all in real time with the press of a single button.

#### 4 How to enable SmartImage?

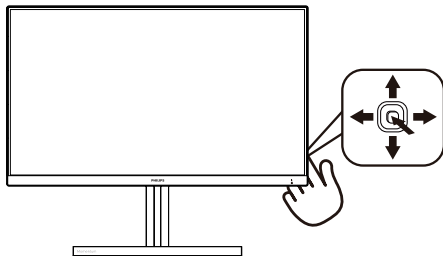

1. Toggle to the left to launch the SmartImage on screen display.
2. Toggle to the up or down to select among Xbox, FPS, Racing, RTS, Gamer 1, Gamer 2, Movie, Economy, LowBlue Mode, SmartUniformity, Off.
3. The SmartImage on screen display will remain on screen for 5 seconds or you can also toggle to the right to make confirmation.

There are multiple selections: Xbox, FPS, Racing, RTS, Gamer 1, Gamer 2, Movie, Economy, LowBlue Mode, SmartUniformity, Off.

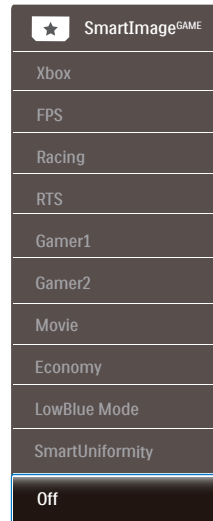

- **Xbox:** Level up your gaming experience while playing Xbox games, you can even control the connected Xbox console using the remote control.
- **FPS:** For playing FPS (First Person Shooters) games. Improves dark theme black level details.
- **Racing:** For playing Racing games. Provides fastest response time and high color saturation.

### 3. Image Optimization

- **RTS:** For playing RTS (Real Time Strategy) games, a user-selected portion can be highlighted for RTS games (through SmartFrame). The picture quality can be adjusted for the highlighted portion.
- **Gamer 1:** User's preference settings saved as Gamer 1.
- **Gamer 2:** User's preference settings saved as Gamer 2.
- **Movie:** Ramped up luminance, deepened color saturation, dynamic contrast and razor sharpness displays every details in darker areas of your videos without color washout in brighter areas maintaining a dynamic natural values for the ultimate video display.
- **Economy:** Under this profile, brightness, contrast are adjusted and backlighting finetuned for just right display of everyday office applications and lower power consumption.
- **LowBlue Mode:** LowBlue Mode for easy on-the-eyes productivity Studies have shown that just as ultra-violet rays can cause eye damage, shortwave length blue light rays from LED displays can cause eye damage and affect vision over time. Developed for wellbeing, Philips LowBlue Mode setting uses a smart software technology to reduce harmful shortwave blue light.
- **SmartUniformity:** Fluctuations in brightness on different parts of a screen are a common phenomenon among LCD displays. Typical uniformity is measured around 75-80%. By enabling Philips SmartUniformity feature, display uniformity is increased to

above 95%. This produces more consistent and true images.

- **Off:** No optimization by SmartImage.

When this display receives HDR signal from the connected device, select a picture mode that best fits your needs.

There are multiple selections: Xbox, HDR Game, HDR Movie, HDR Photo, DisplayHDR 400, Personal, and Off.

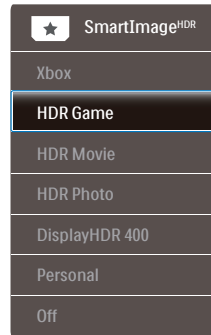

- **Xbox:** Level up your gaming experience while playing Xbox games, you can even control the connected Xbox console using the remote control.
- **HDR Game:** Ideal setting to optimize for playing video games. With brighter white and darker black, the gaming scene is vivid and revealing more details, easily spot enemies hiding in the dark corner and shadows.
- **HDR Movie:** Ideal setting for watching HDR movie. Deliver better contrast and brightness for more realistic and immerse viewing experience.
- **HDR Photo:** Enhancing red, green, and blue for true-to-life visuals.
- **DisplayHDR 400:** Meet VESA DisplayHDR 400 standard
- **Personal:** Customize available settings in picture menu.

- **Off:** No optimization by SmartImage HDR.

#### Note

To switch off HDR function, please disable from input device and its content.

Inconsistent HDR settings between input device and monitor may cause unsatisfying images.

---

## 3.2 SmartContrast

### 1 What is it?

Unique technology that dynamically analyzes displayed content and automatically optimizes a display's contrast ratio for maximum visual clarity and viewing enjoyment, stepping up backlighting for clearer, crisper and brighter images or dimming backlighting for clear display of images on dark backgrounds.

### 2 Why do I need it?

You want the very best visual clarity and viewing comfort for every type of content. SmartContrast dynamically controls contrast and adjusts backlighting for clear, crisp, bright gaming and video images or displays clear, readable text for office work. By reducing your display's power consumption, you save on energy costs and extend the lifetime of your display.

### 3 How does it work?

When you activate SmartContrast, it will analyse the content you are displaying in real time to adjust colors and control backlight intensity. This function will dynamically enhance contrast for a great entertainment experience when viewing videos or playing games.

### 3.3 Adaptive Sync



## Adaptive Sync

PC gaming has long been an imperfect experience because GPUs and monitors update at different rates. Sometimes a GPU can render many new pictures during a single update of the monitor, and the monitor will show pieces of each picture as a single image. This is called “tearing.” Gamers can fix tearing with a feature called “v-sync,” but the image can become jerky as the GPU waits on the monitor to call for an update before delivering new pictures.

The responsiveness of mouse input and overall frames per second are reduced with v-sync, too. AMD Adaptive Sync™ technology eliminates all of these problems by letting the GPU update the monitor the moment a new picture is ready, leaving gamers with unbelievably smooth, responsive, tearing-free games.

Followed by the graphic card that are compatible.

- AMD Radeon R9 290
- AMD Radeon R9 285
- AMD Radeon R7 260X
- AMD Radeon R7 260
- Processor A-Series Desktop and Mobility APUs
  - AMD A10-7890K
  - AMD A10-7870K
  - AMD A10-7850K
  - AMD A10-7800
  - AMD A10-7700K
  - AMD A8-7670K
  - AMD A8-7650K
  - AMD A8-7600
  - AMD A6-7400K
- Operating system
  - Windows 10/8.1/8/7
- Graphic Card: R9 290/300 Series & R7 260 Series
  - AMD Radeon R9 300 Series
  - AMD Radeon R9 Fury X
  - AMD Radeon R9 360
  - AMD Radeon R7 360
  - AMD Radeon R9 295X2
  - AMD Radeon R9 290X

## 4. Ambiglow

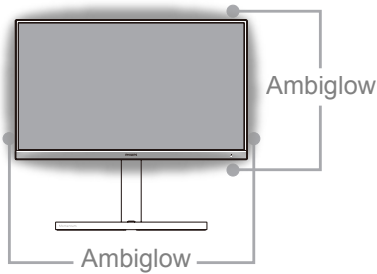

### 1 What is it?

Ambiglow adds a new dimension to your viewing experience. The innovative Ambiglow processor continuously adjusts the overall color and brightness of the light to match the on screen image. User options like Auto mode, 3 step brightness settings allow to adjust the ambiance to your liking and available wall surface. Whether you are playing games, or watching movies, Philips Ambiglow offers you a unique and immersive viewing experience.







### 2 How does it work?

It is recommended that you dim the lighting conditions in your room for maximum effect. Ensure that Ambiglow is set to “on” mode. Start a movie, or play a game from your computer. The monitor will react with appropriate colors creating a halo effect, overall matching the image on the screen. You can also manually select Bright, Brighter, Brightest mode or ambiglow function off mode depending on your preference which helps reduce eye fatigue under prolonged usage.

### 3 How to enable Ambiglow

Ambiglow function can be selected through OSD menu by pressing right button to choose and pressing right button again to confirm the selection:

1. Press right button.
2. To switch Ambiglow off, or select [Follow Video], [Follow Audio], [Color Shift], [Color Wave], [Color Breathing], [Starry Night], [Static Mode], [Your Color], [Light Position], [Speed], [Brightness], [Off].

 Ambiglow	Follow Video	
	Follow Audio	
 Game Setting	Color Shift	Clockwise
	Color Wave	Clockwise
 LowBlue Mode	Color Breathing	
	Starry Night	
 Input	Static Mode	
	Your Color	Blue
 HDMI Refresh Rate	Light Position	All-around
	Speed	Low
 Picture	Brightness	Bright
	Off	✓

## 5. HDR

### 5.1 HDR Settings in Windows 10 system

#### Steps

1. Right click on the desktop, enter to display settings.
2. Select the display/monitor.
3. Adjust resolution to 3840 X 2160.
4. Turn the “HDR and WCG” to on mode.
5. Adjust Brightness for SDR content.

#### Note

Windows 10 edition is required, always upgrade to the most updated version.

Below linkage is for the further more information from microsoft official website.

<https://support.microsoft.com/en-au/help/4040263/windows-10-hdr-advanced-color-settings>

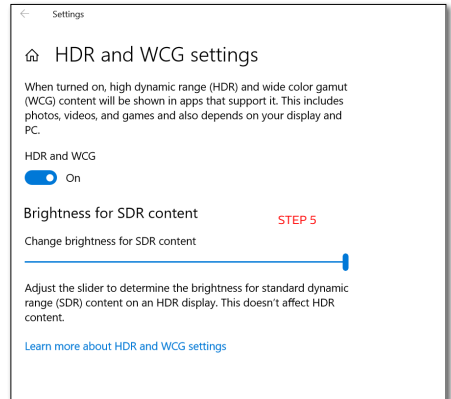

#### Note

To switch off HDR function, please disable from Input device and its content. Inconsistent HDR settings between input device and monitor may cause unsatisfying images.

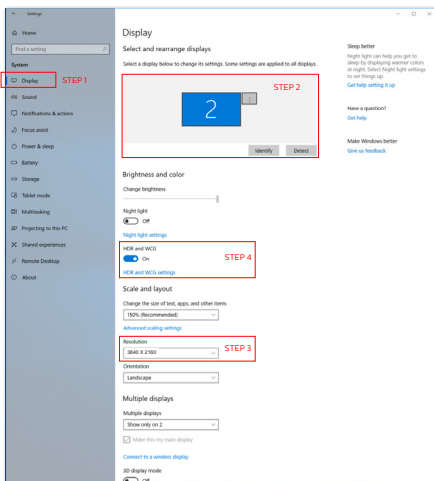

## 6. Power Delivery and Smart Power

Smart Power is an exclusive Philips technology that provides flexible power delivery options. With Smart Power, you can still charge your device without sacrificing the screen brightness, even set your screen as VESA DisplayHDR 400.

### 1 How to enable Smart Power?

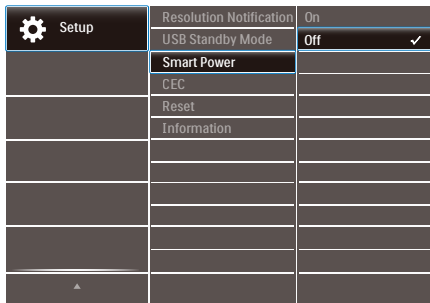

Setup	Resolution Notification	On
	USB Standby Mode	Off ✓
	Smart Power	
	CEC	
	Reset	
	Information	

1. Connect the device to the USB C port.
2. Press right button, and select [Setup].
3. Select [Smart Power], and turn on or off.

SmartImage mode	Power Delivery from USB C	Ambiglow
SmartImage	Smart Power On: 65W	On
	Smart Power Off: 45W	On
SmartImage HDR (HDR Game, HDR Movie, HDR Photo, Personal)	Smart Power On: 65W*	On
	Smart Power Off: 45W	On
SmartImage HDR (VESA DisplayHDR 400)	Smart Power On: 65W*	Off
	Smart Power Off: 45W	On

#### Note

- If DFP (Downstream Facing Port) is using more than 5W, then [Smart Power] will be turned off.

## 7. Technical Specifications

Picture/Display	
Display Panel Type	IPS
Backlight	W-LED
Panel Size	31.5" (80 cm)
Aspect Ratio	16:9
Pixel Pitch	0.181 (H) mm x 0.181 (V) mm
Contrast ratio (typ.)	1000:1
Recommended Resolution	3840 X 2160 @ 144Hz (HDMI/DP) 3840 X 2160 @ 120Hz (USB C)
Viewing Angle	178° (H) / 178° (V) @ C/R > 10
Picture Enhancement	SmartImage Game / SmartImage HDR
Vertical Refresh Rate	48-144Hz (HDMI/DP) 48-120Hz (USB C)
Horizontal Frequency	30-135KHz (HDMI) 30-254KHz (DP/USB C)
sRGB	YES
Color Gamut	YES
SmartUniformity	YES
Delta E	YES
LowBlue Mode	YES
Display Colors	1.07G
Flicker-free	YES
HDR	VESA Certified DisplayHDR™ 400
Ambiglow	YES (4-sides Ambiglow)
Adaptive Sync	YES
Connectivity	
Connectors	1 x USB-C (DP ALT mode, PD 65W) 1 x DisplayPort 1.4 3 x HDMI 2.1 (HDCP 2.2) 4 x USB-A, downstream with x2 fast charge BC 1.2 1 x USB-B (upstream) 1 x Audio out
Power Delivery	USB-C: up to 65W (5V/3A, 7V/3A, 9V/3A, 10V/3A, 12V/3A, 15V/3A, 20V/3.25A) USB-A: x2 fast charge BC 1.2, up to 7.5W (5V/1.5A)
Input Signal	Separate Sync
Convenience	
Built-in speaker	5 W x 2 with DTS sound
MultiView	PBP mode (2 x devices)



## 7. Technical Specifications

OSD Languages	English, German, Spanish, Greek, French, Italian, Hungarian, Dutch, Portuguese, Brazil Portuguese, Polish, Russian, Swedish, Finnish, Turkish, Czech, Ukrainian, Simplified Chinese, Traditional Chinese, Japanese, Korean
Other Convenience	VESA mount(100x100 mm), Kensington Lock
Plug & Play Compatibility	DDC/CI, sRGB, Windows 10/8.1/8/7, Mac OSX

Stand	
Tilt	-5° / +15°
Swivel	-20°/+20°
Height adjustment	130mm
Pivot (329M1RVE)	-90 / +90 degree

Power			
Consumption	AC Input Voltage at 100VAC , 50Hz	AC Input Voltage at 115VAC , 60Hz	AC Input Voltage at 230VAC, 50Hz
Normal Operation	59.2 W (typ.)	58.9 W (typ.)	58.8 W (typ.)
Sleep (Standby mode)	0.5 W (typ.)	0.5 W (typ.)	0.5 W (typ.)
Off mode	0.3 W (typ.)	0.3 W (typ.)	0.3 W (typ.)
Heat Dissipation*	AC Input Voltage at 100VAC , 50Hz	AC Input Voltage at 115VAC , 60Hz	AC Input Voltage at 230VAC , 50Hz
Normal Operation	202.05 BTU/hr (typ.)	201.03 BTU/hr (typ.)	200.68 BTU/hr (typ.)
Sleep (Standby mode)	1.71 BTU/hr (typ.)	1.71 BTU/hr (typ.)	1.71 BTU/hr (typ.)
Off mode	1.02 BTU/hr (typ.)	1.02 BTU/hr (typ.)	1.02 BTU/hr (typ.)
Power LED indicator	On mode: White, Standby/Sleep mode: White (blinking)		
Power Supply	Built-in, 100-240VAC, 50/60Hz		

Dimensions	
Product with stand (WxHxD)	715 x 596 x 297 mm (329M1RV) 715 x 618 x 297 mm (329M1RVE)
Product without stand (WxHxD)	715 x 428 x 78 mm
Product with packaging (WxHxD)	800 x 526 x 224 mm

Weight	
Product with stand	11.63 kg (329M1RV) 11.71 kg (329M1RVE)
Product without stand	7.80 kg
Product with packaging	16.67 kg (329M1RV) 16.79 kg (329M1RVE)

Operating Condition	
Temperature range (operation)	0°C to 40 °C
Relative humidity (operation)	20% to 80%
Atmospheric pressure (operation)	700 to 1060hPa
Temperature range (Non-operation)	-20°C to 60°C
Relative humidity (Non-operation)	10% to 90%
Atmospheric pressure (Non-operation)	500 to 1060hPa
Environmental	
ROHS	YES
Packaging	100% recyclable
Specific Substances	100% PVC BFR free housing
Cabinet	
Color	Black
Finish	Glossy and texture

 Note

1. This data is subject to change without notice. Go to [www.philips.com/support](http://www.philips.com/support) to download the latest version of leaflet.
2. SmartUniformity and Delta E information sheets are included in the box.

## 7.1 Resolution & Preset Modes

- 1** Maximum Resolution  
3840 X 2160 @ 144 Hz (HDMI/DP)  
3840 X 2160 @ 120 Hz (USB C)
- 2** Recommended Resolution  
3840 X 2160 @ 60 Hz

H. freq (kHz)	Resolution	V. freq (Hz)
31.47	720 x 400	70.09
31.47	640 x 480	59.94
35.00	640 x 480	66.67
37.86	640 x 480	72.81
37.50	640 x 480	75.00
37.88	800 x 600	60.32
46.88	800 x 600	75.00
48.36	1024 x 768	60.00
60.02	1024 x 768	75.03
44.77	1280x 720	59.86
63.89	1280 x 1024	60.02
79.98	1280 x 1024	75.03
67.50	1920 x 1080	60.00
135.00	1920 x 1080	120.00
133.29	1920x2160 (PBP)	59.98
183.00	2560x1440	120.00
67.50	3840 x 2160	30.00
112.50	3840 x 2160	50.00
135.00	3840 x 2160	60.00
266.65	3840 x 2160	120.00
319.94	3840 x 2160 (HDMI/DP)	144.00

## 3 Video Timing

Resolution	V. freq (Hz)
640 x 480p	60Hz 4:3
720x 480p	60Hz 4:3
720 x 480p	60Hz 16:9
1280x 720p	60Hz
1920x 1080i	60Hz
1920x 1080p	60Hz
720 x 576p	50Hz 4:3
720 x 576p	50Hz 16:9
1280x 720p	50Hz
1920 x 1080i	50Hz
1920 x 1080p	50Hz
3840 x 2160p	50Hz
3840 x 2160p	60Hz

### ⓘ Note

1. Please notice that your display works best at native resolution of 3840 x 2160. For best output performance, please always ensure that your graphic card is capable of achieving the maximum resolution and refresh rate of this Philips display.
2. The default resolution through HDMI is 3840 x 2160 @120Hz for optimal HDMI 2.1 console gameplay. If you want to run 4K UHD with 144Hz, please go to OSD menu, select [HDMI Refresh Rate], and change to [144Hz].

## 7. Technical Specifications

3. If you feel the texts in your display is a little fade away, you can adjust your fonts setting in your PC/ Notebook as following steps.

### Step 1: Control panel/All Control Panel Items/Fonts

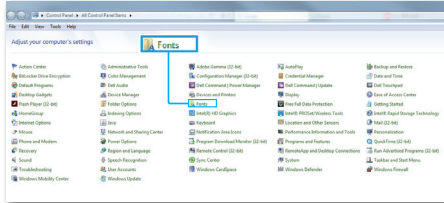

### Step 2: Adjust Clear Type Text

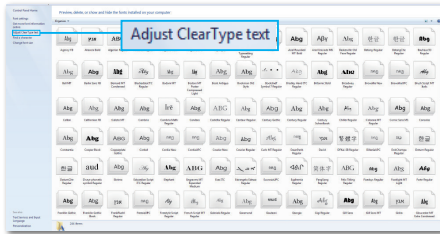

### Step 3: Uncheck "Clear Type"

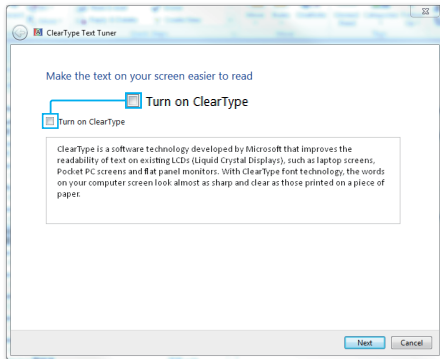

## 8. Power Management

If you have VESA DPM compliance display card or software installed in your PC, the display can automatically reduce its power consumption when not in use. If an input from a keyboard, mouse or other input device is detected, the display will 'wake up' automatically. The following table shows the power consumption and signaling of this automatic power saving feature:

Power Management Definition					
VESA Mode	Video	H-sync	V-sync	Power Used	LED Color
Active	ON	Yes	Yes	58.9 W (typ.) 205.8 W (max.)	White
Sleep (Standby mode)	OFF	No	No	0.5 W (typ.)	White (blink)
Off mode	OFF	-	-	0.3 W (typ.)	OFF

The following setup is used to measure power consumption on this display.

- Native resolution: 3840 X 2160
- Contrast: 50%
- Brightness: 70% (EU Brightness: 10%)
- Color temperature: 6500k with full white pattern

### Note

This data is subject to change without notice.

## 9. Customer care and warranty

### 9.1 Philips' Flat Panel Displays Pixel Defect Policy

Philips strives to deliver the highest quality products. We use some of the industry's most advanced manufacturing processes and practice stringent quality control. However, pixel or sub pixel defects on the TFT display panels used in flat panel displays are sometimes unavoidable. No manufacturer can guarantee that all panels will be free from pixel defects, but Philips guarantees that any display with an unacceptable number of defects will be repaired or replaced under warranty. This notice explains the different types of pixel defects and defines acceptable defect levels for each type. In order to qualify for repair or replacement under warranty, the number of pixel defects on a TFT display panel must exceed these acceptable levels. For example, no more than 0.0004% of the sub pixels on a display may be defective. Furthermore, Philips sets even higher quality standards for certain types or combinations of pixel defects that are more noticeable than others. This policy is valid worldwide.

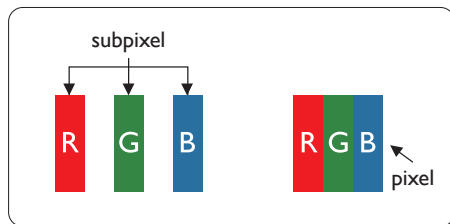

#### Pixels and Sub pixels

A pixel, or picture element, is composed of three sub pixels in the primary colors of red, green and blue. Many pixels together form an image. When all sub pixels of a pixel are lit, the three colored sub pixels together appear as a single white pixel. When all are dark, the three colored sub pixels together appear as a single black pixel. Other combinations of lit and dark sub pixels appear as single pixels of other colors.

#### Types of Pixel Defects

Pixel and sub pixel defects appear on the screen in different ways. There are two categories of pixel defects and several types of sub pixel defects within each category.

#### Bright Dot Defects

Bright dot defects appear as pixels or sub pixels that are always lit or 'on'. That is, a bright dot is a sub-pixel that stands out on the screen when the display displays a dark pattern. There are the types of bright dot defects.

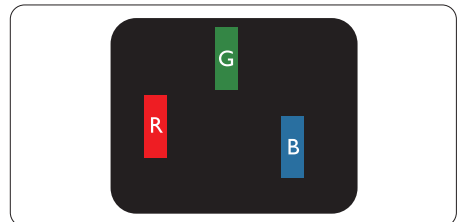

One lit red, green or blue sub pixel.

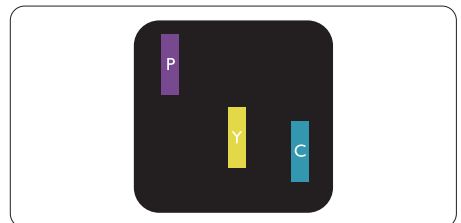

Two adjacent lit sub pixels:  
- Red + Blue = Purple

## 9. Customer care and warranty

- Red + Green = Yellow
- Green + Blue = Cyan (Light Blue)

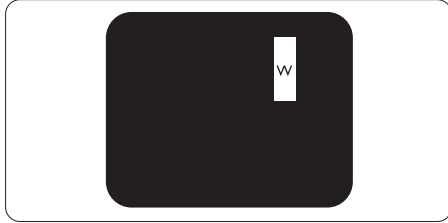

Three adjacent lit sub pixels (one white pixel).

### Note

A red or blue bright dot must be more than 50 percent brighter than neighboring dots while a green bright dot is 30 percent brighter than neighboring dots.

### Black Dot Defects

Black dot defects appear as pixels or sub pixels that are always dark or 'off'. That is, a dark dot is a sub-pixel that stands out on the screen when the display displays a light pattern. These are the types of black dot defects.

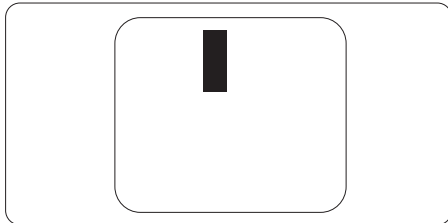

### Proximity of Pixel Defects

Because pixel and sub pixels defects of the same type that are near to one another may be more noticeable, Philips also specifies tolerances for the proximity of pixel defects.

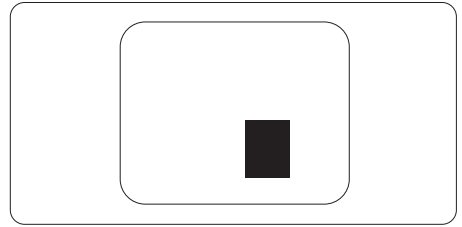

### Pixel Defect Tolerances

In order to qualify for repair or replacement due to pixel defects during the warranty period, a TFT display panel in a Philips flat panel display must have pixel or sub pixel defects exceeding the tolerances listed in the following tables.

<b>BRIGHT DOT DEFECTS</b>	<b>ACCEPTABLE LEVEL</b>
1 lit subpixel	2
2 adjacent lit subpixels	0
3 adjacent lit subpixels (one white pixel)	0
Total bright dot defects of all types	3
<b>BLACK DOT DEFECTS</b>	<b>ACCEPTABLE LEVEL</b>
1 dark subpixel	5 or fewer
2 adjacent dark subpixels	2 or fewer
3 adjacent dark subpixels	1 or fewer
Distance between two black dot defects*	$\geq 5\text{mm}$
Total black dot defects of all types	5 or fewer
<b>TOTAL DOT DEFECTS</b>	<b>ACCEPTABLE LEVEL</b>
Total bright or black dot defects of all types	5 or fewer

 **Note**

1 or 2 adjacent sub pixel defects = 1 dot defect



## 9.2 Customer Care & Warranty

For warranty coverage information and additional support requirements valid for your region, please visit [www.philips.com/support](http://www.philips.com/support) website for details or contact your local Philips Customer Care Center.

For Warranty Period please refer to Warranty Statement in Regulation & Service Information Manual

For extended warranty, if you would like to extend your general warranty period, an Out of Warranty service package is offered via our Certified Service Center.

If you wish to make use of this service, please be sure to purchase the service within 30 calendar days of your original purchase date. During the extended warranty period, the service includes pickup, repair and return service, however the user will be responsible for all costs accrued.

If the Certified Service Partner cannot perform the required repairs under the offered extended warranty package, we will find alternative solutions for you, if possible, up to the extended warranty period you have purchased.

Please contact our Philips Customer Service Representative or local contact center (by Consumer care number) for more details.

Philips Customer Care Center number listed below.

• Local Standard Warranty Period	• Extended Warranty Period	• Total Warranty Period
• Depend on different Regions	• + 1 Year	• Local Standard warranty period +1
	• + 2 Years	• Local Standard warranty period +2
	• + 3 Years	• Local Standard warranty period +3

\*\*Proof of original purchase and extended warranty purchase required.

### Note

Please refer to Regulation & Service Information Manual for regional service hotline, which is available on the Philips website support page.

# 10. Troubleshooting & FAQs

## 10.1 Troubleshooting

This page deals with problems that can be corrected by a user. If the problem still persists after you have tried these solutions, contact Philips customer service representative.

### 1 Common Problems

#### No Picture (Power LED not lit)

- Make sure the power cord is plugged into the power outlet and into the back of the display.
- First, ensure that the power button on the back of the display is in the OFF position, then press it to the ON position.

#### No Picture (Power LED is White)

- Make sure the computer is turned on.
- Make sure the signal cable is properly connected to your computer.
- Make sure the display cable has no bent pins on the connect side. If yes, repair or replace the cable.
- The Energy Saving feature may be activated

#### Screen says



Check cable connection

- Make sure the display cable is properly connected to your computer. (Also refer to the Quick Start Guide).
- Check to see if the display cable has bent pins.

- Make sure the computer is turned on.

#### Visible signs of smoke or sparks

- Do not perform any troubleshooting steps
- Disconnect the monitor from mains power source immediately for safety
- Contact with Philips customer service representative immediately.

### 2 Imaging Problems

#### Image vibrates on the screen

- Check that the signal cable is properly securely connected to the graphics board or PC.

#### Image appears blurred, indistinct or too dark

- Adjust the contrast and brightness on On-Screen Display.

#### An "after-image", "burn-in" or "ghost image" remains after the power has been turned off.

- Uninterrupted display of still or static images over an extended period may cause "burn in", also known as "after-imaging" or "ghost imaging", on your screen. "Burn-in", "after-imaging", or "ghost imaging" is a well-known phenomenon in LCD panel technology. In most cases, the "burned in" or "after-imaging" or "ghost imaging" will disappear gradually over a period of time after the power has been switched off.
- Always activate a moving screen saver program when you leave your monitor unattended.
- Always activate a periodic screen refresh application if your LCD monitor will display unchanging static content.
- Failure to activate a screen saver, or a periodic screen refresh

application may result in severe “burn-in” or “after-image” or “ghost image” symptoms that will not disappear and cannot be repaired. The damage mentioned above is not covered under your warranty.

Image appears distorted. Text is fuzzy or blurred.

- Set the PC’s display resolution to the same mode as monitor’s recommended screen native resolution.

Green, red, blue, dark, and white dots appears on the screen

- The remaining dots are normal characteristic of the liquid crystal used in today’s technology, Please refer the pixel policy for more detail.

\* The “power on” light is too strong and is disturbing

- You can adjust “power on” light using the power LED Setup in OSD main Controls.

For further assistance, refer to the Service contact information listed in Regulation & Service Information Manual and contact Philips customer service representative.

\* [Functionality different according to display.](#)

### 3 Audio problem

No sound

- Check if audio cable is connected to PC and monitor correctly.
- Ensure audio is not muted. Press OSD “Menu”, select “Audio” then “Mute”. Check it on “Off” position.
- Press “Volume” in OSD main control to adjust the volume.

## 10.2 General FAQs

Q1: When I install my display what should I do if the screen shows 'Cannot display this video mode'?

Ans.: Recommended resolution for this display: 3840 X 2160 .

- Unplug all cables, then connect your PC to the display that you used previously.
- In the Windows Start Menu, select Settings/Control Panel. In the Control Panel Window, select the display icon. Inside the display Control Panel, select the 'Settings' tab. Under the setting tab, in box labelled 'desktop area', move the sidebar to 3840 X 2160 pixels.
- Open 'Advanced Properties' and set the Refresh Rate to 60 Hz, then click OK.
- Restart your computer and repeat step 2 and 3 to verify that your PC is set at 3840 X 2160 @ 60 Hz.
- Shut down your computer, disconnect your old display and reconnect your Philips LCD display.
- Turn on your display and then turn on your PC.

Q2: What is the recommended refresh rate for LCD display?

Ans.: Recommended refresh rate in LCD displays is 60 Hz, In case of any disturbance on screen, you can set it up to 75 Hz to see if that removes the disturbance.

Q3: What are the .inf and .icm files on the CD-ROM? How do I install the drivers (.inf and .icm)?

Ans.: These are the driver files for your monitor. Follow the instructions in your user manual to install the drivers. Your computer may

ask you for monitor drivers (.inf and .icm files) or a driver disk when you first install your monitor. Follow the instructions to insert the (companion CD-ROM) included in this package. Monitor drivers (.inf and .icm files) will be installed automatically.

Q4: How do I adjust the resolution?

Ans.: Your video card/graphic driver and display together determine the available resolutions. You can select the desired resolution under Windows® Control Panel with the "Display properties".

Q5: What if I get lost when I am making display adjustments via OSD?

Ans.: Simply press the  button, then select 'Setup' -> 'Reset' to recall all of the original factory settings.

Q6: Is the LCD screen resistant to scratches?

Ans.: In general it is recommended that the panel surface is not subjected to excessive shocks and is protected from sharp or blunt objects. When handling the display, make sure that there is no pressure or force applied to the panel surface side. This may affect your warranty conditions.



Q7: How should I clean the LCD surface?

Ans.: For normal cleaning, use a clean, soft cloth. For extensive cleaning, please use isopropyl alcohol. Do not use other

solvents such as ethyl alcohol, ethanol, acetone, hexane, etc.

Q8: Can I change the color setting of my display?

Ans.: Yes, you can change your color setting through OSD control as the following procedures,

- Press "" to show the OSD (On Screen display) menu
- Press "" to select the option "Color" then press "" to enter color setting, there are three settings as below.
  1. Color Temperature: The 7 settings are Native, 5000K, 6500K, 7500K, 8200K, 9300K and 11500K. With settings in the 5000K range the panel appears "warm, with a red-white color tone", while a 11500K temperature yields "cool, bluishwhite toning".
  2. sRGB: This is a standard setting for ensuring correct exchange of colors between different device (e.g. digital cameras, displays, printers, scanners, etc).
  3. User Define: The user can choose his/her preference color setting by adjusting red, green, blue color.

#### Note

A measurement of the color of light radiated by an object while it is being heated. This measurement is expressed in terms of absolute scale, (degrees Kelvin). Lower Kelvin temperatures such as 2004K are red; higher temperatures such as 9300K are blue. Neutral temperature is white, at 6504K.

Q9: Can I connect my LCD display to any PC, workstation or Mac?

Ans.: Yes. All Philips LCD displays are fully compatible with standard PCs, Macs and workstations. You may need a cable adapter to connect the display to your Mac system. Please contact your Philips sales representative for more information.

Q10: Are Philips LCD displays Plug-and-Play?

Ans.: Yes, the displays are Plug-and-Play compatible with Windows 10/8.1/8/7.

Q11: What is Image Sticking, or Image Burn-in, or After Image, or Ghost Image in LCD panels?

Ans.: Uninterrupted display of still or static images over an extended period may cause "Burn-in", also known as "after-imaging" or "ghost imaging", on your screen. "Burn-in", "after-imaging", or "ghost imaging" is a well-known phenomenon in LCD panel technology. In most cases, the "Burn-in" or "after-imaging" or "ghost imaging" will disappear gradually over a period of time after the power has been switched off.

Always activate a moving screen saver program when you leave your display unattended.

Always activate a periodic screen refresh application if your LCD display will display unchanging static content.

### Warning

Failure to activate a screen saver, or a periodic screen refresh application may result in severe "Burn-in" or "after-imaging" or "ghost image" symptoms that will not disappear and cannot be repaired. The damage mentioned above is not covered under your warranty.

Q12: Why is my display not showing sharp text, and is displaying jagged characters?

Ans.: Your LCD display works best at its native resolution of 3840 X 2160. For best display, please use this resolution.

Q13: How to unlock/lock my hot key?

Ans.: Please press  for 10 seconds to unlock/lock the hot key, by doing so, your display pops out "Attention" to show the unlock/lock status as shown below illustrators.



Display controls unlocked



Display controls locked

Q14: Where can I find Regulation & Service Information Manual mentioned in EDFU?

Ans.: Regulation & Service Information Manual can be download on the Philips website support page.



2021 © TOP Victory Investments Ltd. All rights reserved.

This product has been manufactured by and is sold under the responsibility of Top Victory Investments Ltd., and Top Victory Investments Ltd. is the warrantor in relation to this product. Philips and the Philips Shield Emblem are registered trademarks of Koninklijke Philips N.V. and are used under license.

Specifications are subject to change without notice.

Version: 329MIREIT