

PHILIPS

STE1000 series

STE1010, STE1020
STE1030, STE1040



Lea cuidadosamente el instructivo antes de usar su aparato

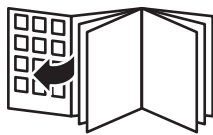

English 6
Azərbaycanca 21
Bahasa Indonesia 37
Bahasa Melayu 53
Čeština 69
Dansk 84
Deutsch 99
Eesti 115
Español 130
Français 146
Hrvatski 162
Italiano 177
Latviešu 194
Lietuviškai 209
Magyar 225
Nederlands 241
Norsk 257
O'zbek 272
Polski 288
Português 304
Português do Brasil 320
Română 336
Shqip 352
Slovenščina 367
Slovensky 382
Srpski 398
Suomi 413
Svenska 428
Tiếng Việt 443
Türkçe 459
Türkmençe 475
Ελληνικά 491
Български 507
Кыргызча 523
Македонски 539
Русский 556

Тоҷикӣ 572
Українська 588
Қазақша 604
Հայերեն 620
ភាសាខ្មែរ 636
ქართული ენა 653
简体中文 670
繁體中文 686
한국어 701
العربية 716
فارسی 731

Introduction

Congratulations on your purchase and welcome to Philips! To fully benefit from the support that Philips offers, register your product at www.philips.com/welcome. Read this user manual, the important information leaflet, and the quick start guide carefully before you use the appliance. Save them for future reference.

Product overview

STE1020, STE1030, STE1040

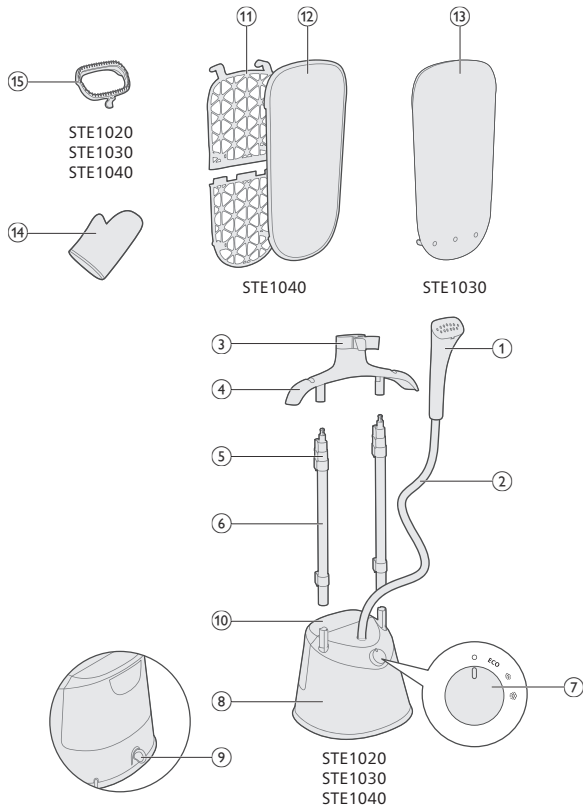

STE1010

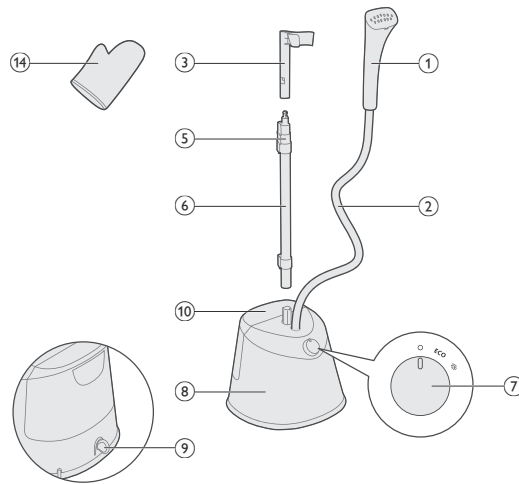

- 1 Steamer head
- 2 Steam supply hose
- 3 Steamer dock
- 4 Hanger (STE1020, 1030, 1040)
- 5 Pole lock clip
- 6 Pole
- 7 Steam dial
- 8 Base
- 9 De-calc knob
- 10 Water tank
- 11 Board (STE1040)
- 12 Cover (STE1040)
- 13 Mat (STE1030)
- 14 Glove
- 15 Brush (STE1020, STE1030, STE1040)

Preparing for use

Type of water to use

The appliance is suitable to be used with tap water. However, if you live in an area with hard water, we recommend that you mix an equal amount of tap water with distilled or demineralized water. This will prevent fast scale build up and prolong the lifetime of the appliance.

Do not add perfume, water from the tumble dryer, vinegar, starch, descaling agents, ironing aids, chemically descaled water or other chemicals, as they may cause water spitting, brown staining or damage to your appliance.

Warnings

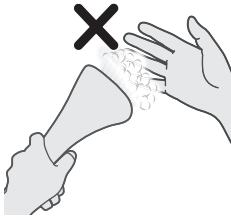

1 Do not place any part of the skin in direct contact with the steam.



2 Do not aim the steamer plate towards other persons.

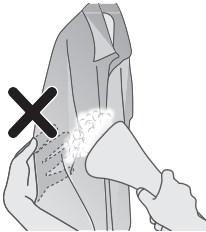

3 Do not hold your garment in a way which is in direct contact with the steam.



4 Do not use the steamer head in a downwards direction.

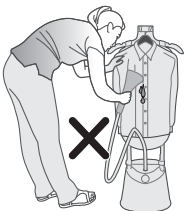

5 Do not bend the hose to steam the garment.

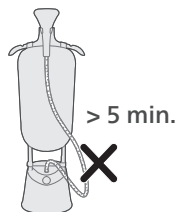

- 6 Do not leave the stand steamer unattended for more than 5 minutes.

Setting up the appliance

STE1010

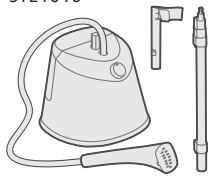

- 1 Take note of the parts available for your purchased appliance.

STE1020, STE1030
STE1040



STE1010

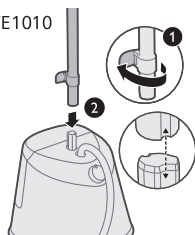

- 2 Unlock the bottom pole lock clips and insert the pole(s) onto the base. Ensure the profiles of the pole(s) and base pole stud(s) are aligned.

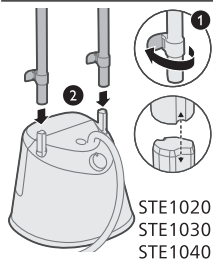

10 English

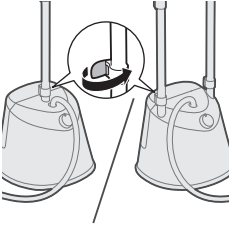

3 Lock the bottom pole lock clip(s).

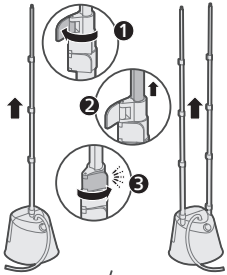

4 Unlock the remaining pole lock clips, fully extend the pole(s) upwards and lock it.

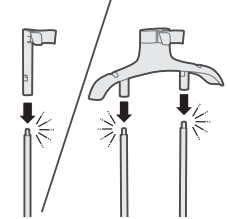

5 Insert the steamer dock onto the pole(s) until it locks in place ('click').

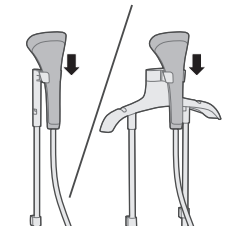

6 Place the steamer head onto the steamer dock.

Setting up the board

1 Take note of the parts available for your purchased appliance.

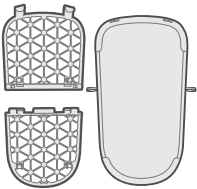

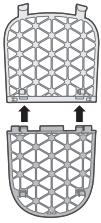

2 Align and insert the board clips until it lock in place ('click').



3 Align and insert the board cover through the board hooks.

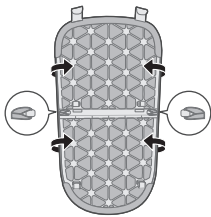

4 Hook up the board cover straps onto the hooks at the back of the board

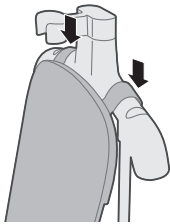

5 Place board onto the hanger.

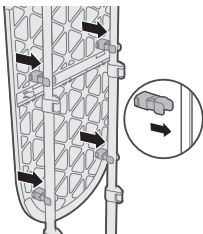

6 Secure the board onto the poles until it lock in place ('click').

12 English

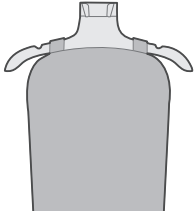

7 You can drape your clothes using the hanger.

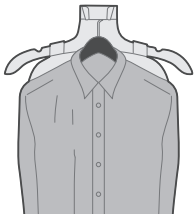
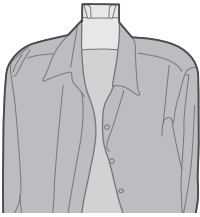

8 You can use your own hanger and place it on the steamer dock.

Setting the mat

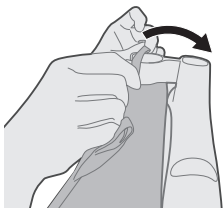

1 Insert the middle strap through the steamer dock.

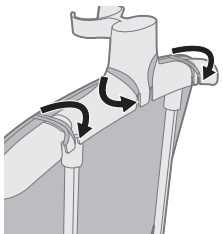

2 Secure the 3 straps on the hook at the back of the hanger.

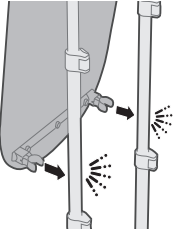

3 Secure the mat onto the poles until it locks in place ('click').

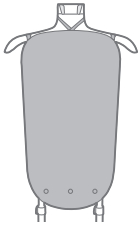

4 You can drape your clothes using the hanger.



5 You can use your own hanger and place it on the steamer dock.

Inserting the brush

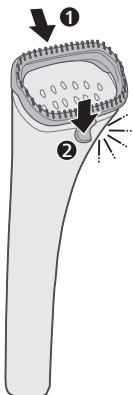

1 Align the track along the top of the steamer head and snap the catch on the bottom ('click').

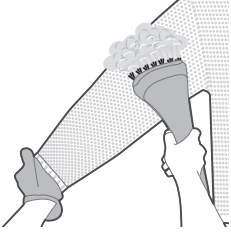

2 You can wear the glove and steam your clothes using the brush attachment.

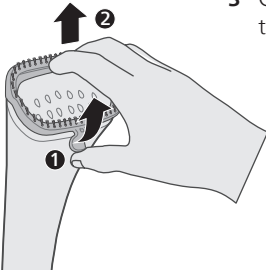

3 Grip and pull out the catch from the bottom of the steamer head to remove the brush attachment.

Filling the water tank

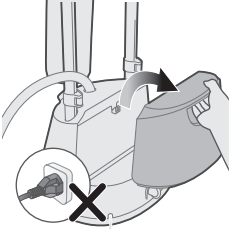

1 Do not plug in the appliance. Remove the water tank from the base.

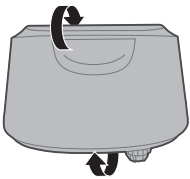

2 Flip the water tank with the water tank cap facing upwards.

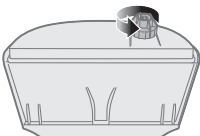

3 Unscrew the water tank cap anticlockwise to remove.

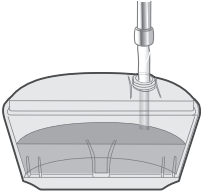

4 Fill up the water tank.

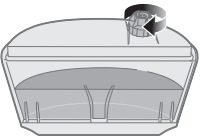

5 Screw the water tank cap clockwise to tighten.

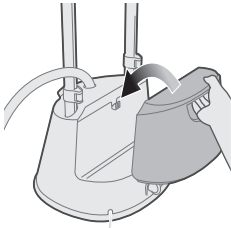

6 Align with the hook to place the water tank back to the base.

Changing the steam settings

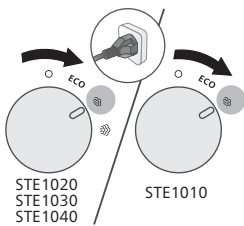

1 Ensure appliance is plugged in. Rotate the steam dial to the desired steam setting.

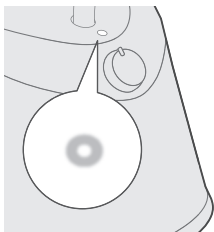

2 The light will turn steady to indicate the stand steamer is switched ON.

16 English

*STE1010/75: ~2 min

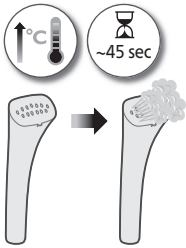

- 3 Wait for about 45 seconds for the stand steamer to heat up and emit steam (STE1010/75: about 2 minutes).

Ironing tips

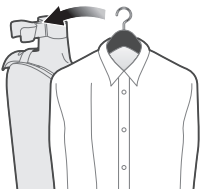

- 1 You can use your own hanger and place it on the steamer dock.

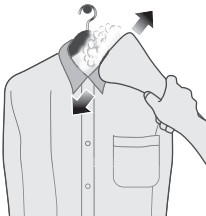

- 2 Move the steamer head in a parallel direction with the collar.



- 3 Move the steamer head in a horizontal direction with the yoke.

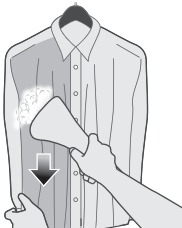

- 4 Stretch the garment. Move the steamer head in a downwards direction on the body front.



5 Move the steamer head in a upwards direction on a pocket.

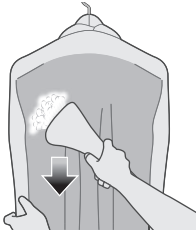

6 Stretch the garment. Move the steamer head in a downwards direction on the body back.

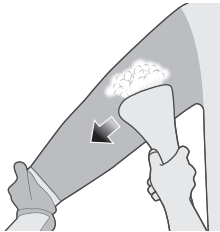

7 Stretch the garment. Move the steamer head in a parallel direction with the sleeve.

Cleaning and maintenance

Calc Collector

Your appliance has been designed with a Calc Collector system. You are recommended to do descaling once a month or more. This helps to maintain a strong steam performance and prevents dirt and stains coming out of the soleplate over time.

Tip: The Calc Collector system can be used at any time. If you live in a hard water area, use the function more frequently.

Performing the calc clean process

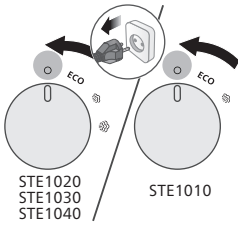

1 Ensure that the steam dial is at the OFF position and the appliance is unplugged.

2 Ensure that the iron has cooled down completely (> 1 hour).



3 Place the steamer close to a drain.

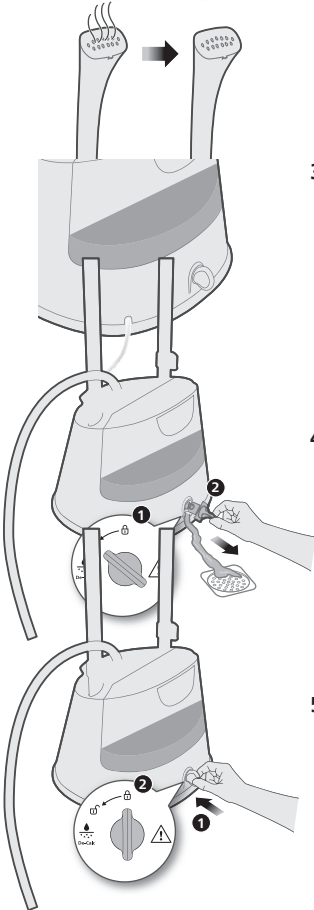

4 Turn the De-calc knob to the unlock position and remove the De-calc knob. Allow water to drain.

5 Insert and turn the De-calc knob to the lock position.

Cleaning and storing the stand steamer

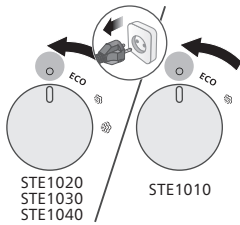

- 1 Ensure that the steam dial is at the OFF position and the appliance is unplugged.

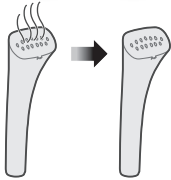

- 3 Wipe the steam place with a damp cloth.

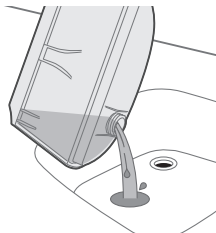
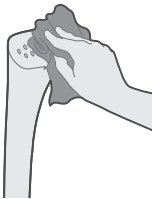

- 4 Empty the water tank completely.

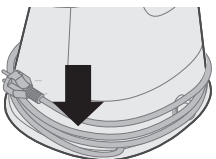

- 5 Wind the power cord around the base.

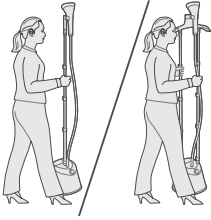

6 You can carry the stand steamer by the pole.

Trouble shooting

This chapter summarizes the most common problems you could encounter with the appliance. If you are unable to solve the problem with the information below, visit www.philips.com/support for a list of frequently asked questions or contact the Consumer Care Center in your country.

Problem	Possible cause	Solution
The appliance produces no steam or irregular steam.	The steamer has not heated up sufficiently.	Let the appliance heat up for approximately 45 seconds (STE1010/75: about 2 minutes).
	Steam has condensed in the hose.	Lift the steamer head to straighten the hose vertically. This allows any condensation to flow back.
	Low water level in the tank or the tank is not inserted properly.	Refill the water tank and insert it properly.
	Too much scale has built up in the appliance.	Perform de-calc process. Refer to Calc-Clean section.
Water droplets drip from the steamer head or the appliance produces a croaking sound.	You have left the steamer head and/or the steam supply hose in horizontal position for a long time.	Lift the steamer head to straighten the hose vertically. This allows any condensation to flow back.
	When the hose forms a U-shape, condensation in the hose cannot flow back into the water tank.	Lift the steamer head to straighten the hose vertically. This allows any condensation to flow back.
An excessive amount of water drips out of the steamer head when the appliance is heating up.	The water in the appliance is dirty or has been left inside the appliance for a long time.	Perform de-calc process. Refer to the Calc-Clean section.
Water leaks out from the steamer base.	You have not closed the water tank cap or de-calc knob securely. The water tank is not inserted properly.	Close the water tank cap or de-calc knob securely. Insert the tank properly.

Giriş

Philips-dən alış-veriş etdiyiniz üçün sizi təbrik edirik və "Philips-ə xoş gəlmisiniz" deyirik! Philips-in təklif etdiyi dəstəkdən tam şəkildə yararlanmaq üçün məhsulunuzu www.philips.com/welcome səhifəsində qeydiyyatdan keçirin. Cihazdan istifadəyə başlamazdan əvvəl bu təlimat kitabçasını, vacib məlumatlar bukletini və başlamaq haqqında qısa təlimatı oxuyun. Onları gələcəkdə istinad etmək üçün saxlayın.

Məhsul icmalı

STE1020, STE1030, STE1040

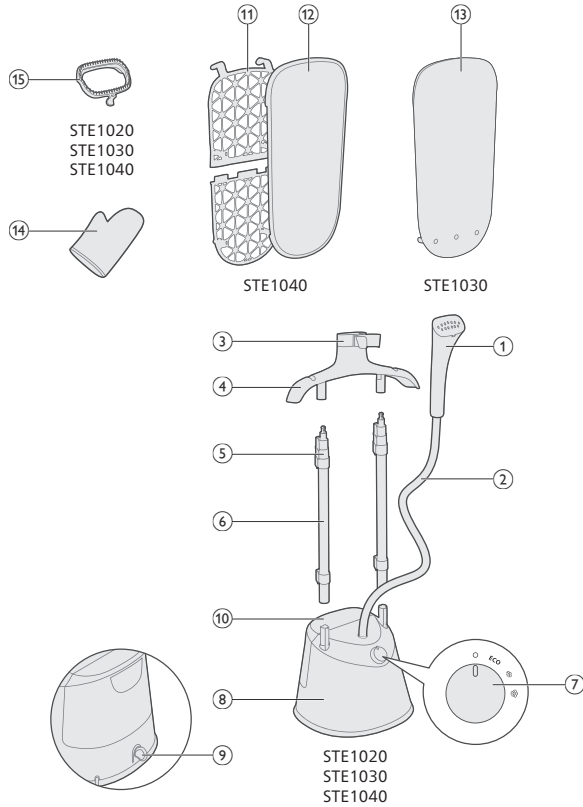

STE1010

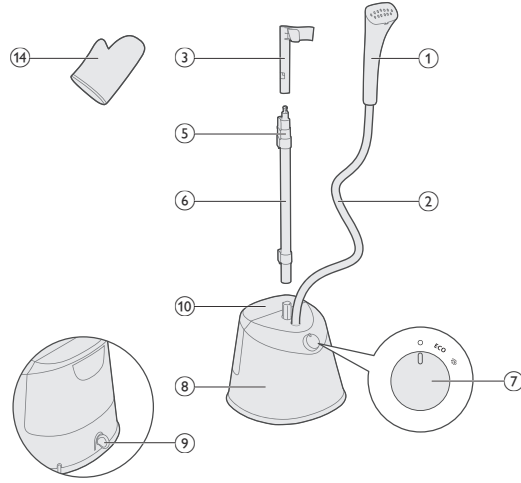

- 1 Buxar başlığı
- 2 Buxar təchizatı şlanqı
- 3 Buxar ucluğu
- 4 Asılqan (STE1020, 1030, 1040)
- 5 Dayaq kilidi qısqacı
- 6 Dayaq
- 7 Buxar vermə tənzimləyicisi
- 8 Baza
- 9 Ərp təmizləmə klapanı
- 10 Su çəni
- 11 Lövhə (STE1040)
- 12 Örtük (STE1040)
- 13 Altlıq (STE1030)
- 14 Əlcək
- 15 Fırça (STE1020, STE1030, STE1040)

İstifadəyə hazırlanır

İstifadə olunacaq suyun növü

Cihazı kran suyu ilə istifadə etmək tövsiyə edilir. Ancaq sərt suyu olan bölgədə yaşayırsınızsa, bərabər miqdarda kran suyunu distillə edilmiş və ya mineraldan təmizlənmiş su ilə qarışdırmağı məsləhət görürük. Bu, ərpın toplanmasının qarşısını alacaq və cihazın istismar müddətini uzadacaq.

Ətir, su, qurutma maşınından götürülmüş su, sirkə, nişasta, ərp təmizləyici vasitələr, ütüləmə vasitələri, kimyəvi təmizlənmiş su və ya digər kimyəvi maddələrdən istifadə etməyin, çünki onlar su damcılmasına, qəhvəyi rəngli ləkələnməyə və ya cihazınızın zədələnməsinə səbəb ola bilər.

Xəbərdarlıqlar

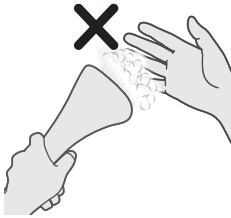

1 Dərinin heç bir hissəsini buxarla birbaşa təmas etdirməyin.



2 Buxar plitəsini başqa insanlara tərəf tutmayın.

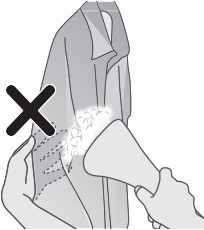

3 Paltarınızı birbaşa buxara məruz qalacaq şəkildə tutmayın.

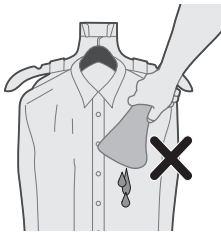

4 Buxar başlığını aşağıya doğru tutaraq istifadə etməyin.

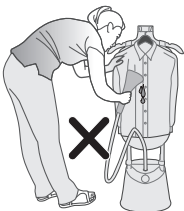

5 Paltara buxar vurmaq üçün şlanqı əyməyin.

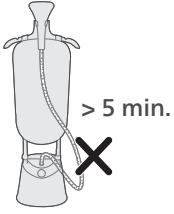

6 Buxar ütüsünü 5 dəqiqədən artıq nəzarətsiz qoymayın.

Cihazın quraşdırılması

STE1010

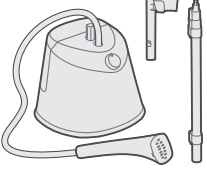

1 Satın aldığınız cihaz üçün mövcud olan hissələri qeyd edin.

STE1020, STE1030

STE1040

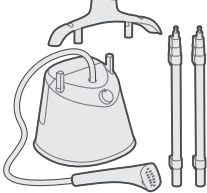

STE1010

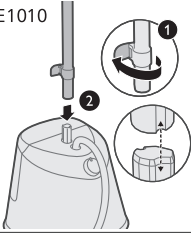

2 Alt dirək bağlama sxaclarını açın və dirəyi (dirəkləri) bazaya daxil edin. Dirəyin (dirəklərin) və bazanın dirək dayacağının (dayaqlarının) profillərinin düzləndirildiyindən əmin olun.

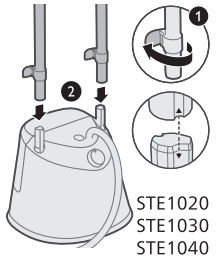

STE1020
STE1030
STE1040

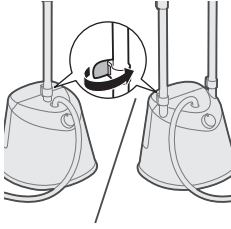

3 Alt dirək bağlama sıxac(lar)ını bağlayın.

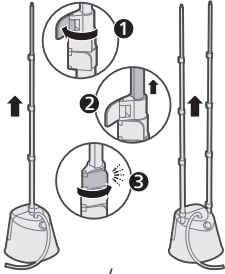

4 Qalan dirək bağlama sıxac(lar)ını açın, dirəyi (dirəkləri) yuxarıya doğru tam uzadaraq bağlayın.

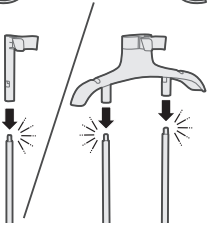

5 Buxar ucluğunu yerinə bağlanana ("oturana") qədər dirəyə (dirəklərə) daxil edin.

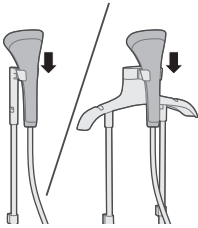

6 Buxar başlığını buxar ucluğunun üzərinə yerləşdirin.

Lövhenin quraşdırılması

1 Satın aldığınız cihaz üçün mövcud olan hissələri qeyd edin.

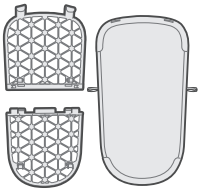

26 Azərbaycanca

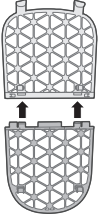

2 Lövə sıxaclarını yerinə bağlanana ("oturana") qədər düzləndirin və daxil edin.



3 Lövə örtüyünü lövhə qarmaqları vasitəsilə düzləndirin və daxil edin.

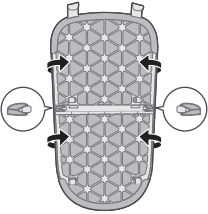

4 Lövənin örtük kəmərlərini lövhənin arxasındakı qarmaqlara bağlayın

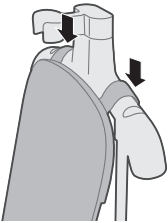

5 Lövəni asılqanın üzərinə yerləşdirin.

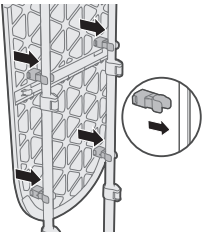

6 Lövəni yerinə bağlanana ("oturana") qədər dirəklərə bərkidin.

7 Asılıqandan istifadə etməklə paltarlarınızı asa bilərsiniz.

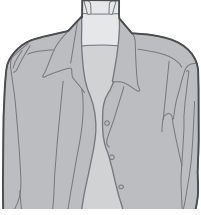
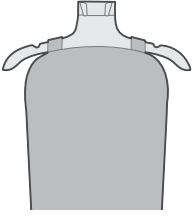

8 Öz asılıqanızdan istifadə edərək onu buxar ucluğuna yerləşdirə bilərsiniz.

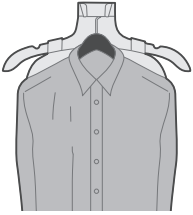

Altlığın quraşdırılması

1 Orta kəməri buxar ucluğundan keçirin.

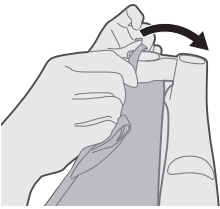

2 3 kəməri asılıqanın arxasındakı qarmaqda bərkidin.

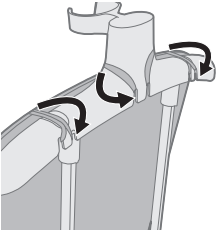

28 Azərbaycanca

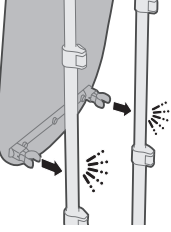

3 Altlığı yerinə bağlanana ("oturana") qədər dirəklərə bərkidin.

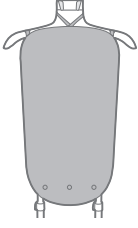

4 Asılıqdan istifadə etməklə paltarlarınızı asa bilərsiniz.



5 Öz asılıqınızdan istifadə edərək onu buxar ucluğuna yerləşdirə bilərsiniz.

Fırçanın daxil edilməsi

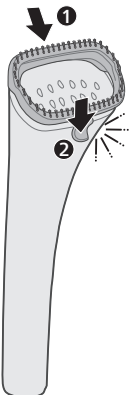

1 Yolu buxar başlığının yuxarı hissəsi boyunca düzləndirin və altdakı qapağı sıxın ("klikləyin").

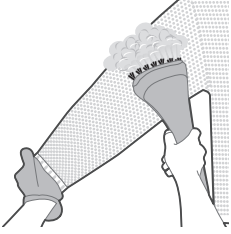

2 Əlcəyi taxmaq və fırça əlavəsindən istifadə etməklə paltarlarınıza buxar vura bilərsiniz.

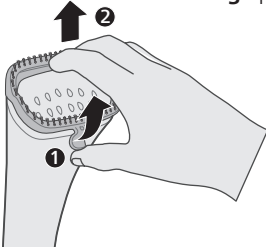

3 Fırça əlavəsini çıxarmaq üçün buxar başlığının altındakı qapağı sıxıb dartın.

Su çənini doldurmaq

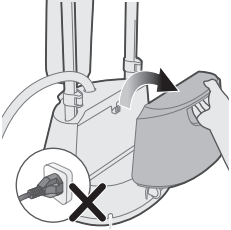

1 Cihazı elektrik şəbəkəsinə qoşmayın. Su çənini bazadan çıxarın.

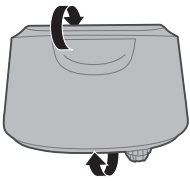

2 Qapağı yuxarıya tərəf olmaqla su çənini çevirin.

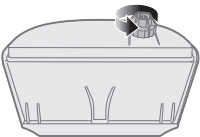

3 Çıxarmaq üçün su çəninin qapağını saat əqrəbinin əksi istiqamətində fırladın.

30 Azərbaycanca

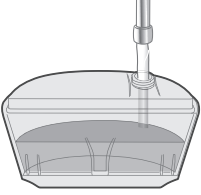

4 Su çənini doldurun.

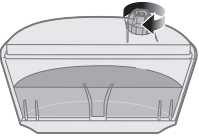

5 Bərkitmək üçün su çəninin qapağını saat əqrəbi istiqamətində fırladın.

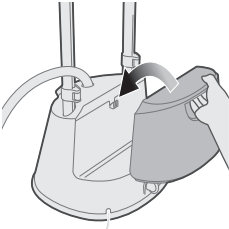

6 Su çənini yenidən bazaya yerləşdirmək üçün qarmaqla düzləndirin.

Buxar parametrlərinin dəyişdirilməsi

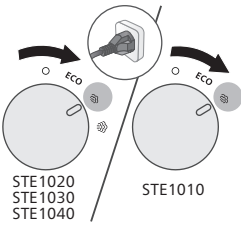

1 Cihazın elektrik şəbəkəsinə qoşulduğundan əmin olun. Buxar vermə tənzimləyicisini istədiyiniz buxar parametrinə çevirin.

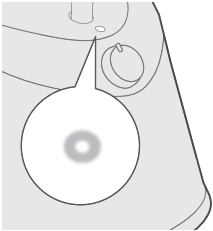

2 Buxar ütüsünün işə salındığını göstərmək üçün işıq davamlı olaraq yanacaq.

*STE1010/75: ~2 min

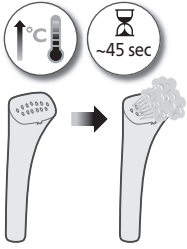

- 3 Buxar ütüsünün isinməsi və buxar çıxarması üçün təxminən 45 saniyə gözləyin (STE1010/75: təxminən 2 dəqiqə).

Ütüləmə haqqında ipucuları

- 1 Öz asılıqanızdan istifadə edərək onu buxar ucluğuna yerləşdirə bilərsiniz.

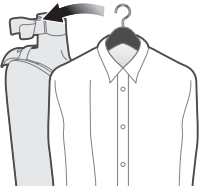

- 2 Buxar başlığını yaxa ilə paralel istiqamətdə hərəkət etdirin.

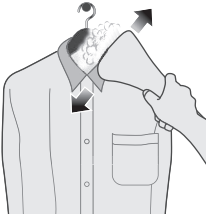

- 3 Buxar başlığını boyunluqla üfüqi istiqamətdə hərəkət etdirin.



- 4 Paltarı dartın. Buxar başlığını gövdənin ön hissəsi üzərində aşağıya doğru hərəkət etdirin.

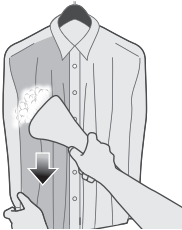



5 Buxar başlığını cib üzərində yuxarıya doğru hərəkət etdirin.

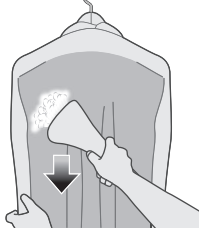

6 Paltarı dartın. Buxar başlığını gövdənin arxa hissəsi üzərində aşağıya doğru hərəkət etdirin.

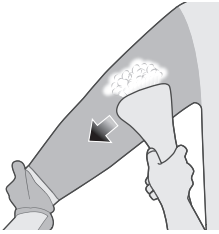

7 Paltarı dartın. Buxar başlığını qolla paralel istiqamətdə hərəkət etdirin.

Təmizlik və baxım

Ərp toplayıcı

Cihazınız ərp toplayıcı sistemlə dizayn olunmuşdur. Ayda bir dəfə və ya daha çox ərp təmizləməyiniz tövsiyə olunur. Bu, güclü buxar performansını qorumağa kömək edir və zamanla ütü altlığından kir və ləkələrin çıxmasının qarşısını alır.

Məsləhət: Ərp toplayıcı sistem istənilən vaxt istifadə edilə bilər. Yaşadığınız ərazidə su sərtdirsə, funksiyadan daha tez-tez istifadə edin.

Ərp təmizləmə prosesinin yerinə yetirilməsi

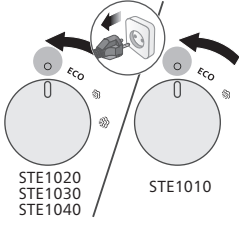

- 1 Buxar vermə tənzimləyicisinin OFF vəziyyətdə olduğundan və cihazın elektrik şəbəkəsindən ayrıldığından əmin olun.

- 2 Ütünün tamamilə soyuduğundan əmin olun (> 1 saat).



- 3 Buxar ütüsünü drenaj borusunun yaxınlığına qoyun.

- 4 Ərp təmizləmə klapanını açıq vəziyyətinə gətirin və çıxarın. Suyun boşalmasını gözləyin.

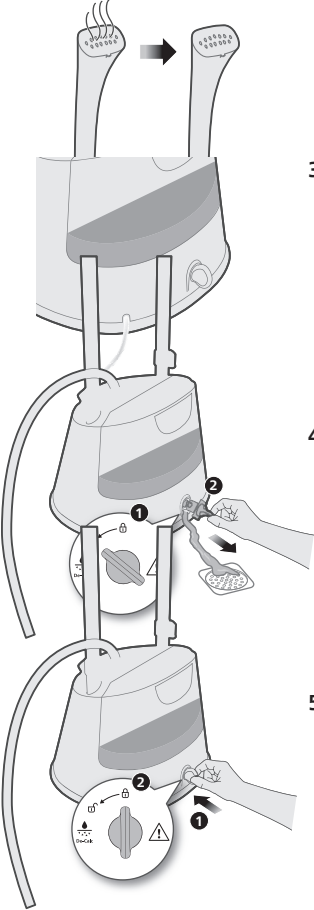

- 5 Ərp təmizləmə klapanını daxil edin və bağlı vəziyyətinə gətirin.

Buxar ütüsünün təmizlənməsi və saxlanması

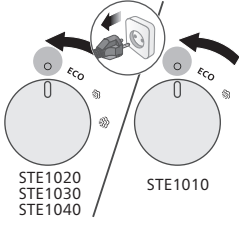

- 1 Buxar vermə tənzimləyicisinin OFF vəziyyətdə olduğundan və cihazın elektrik şəbəkəsindən ayrıldığından əmin olun.



- 2 Ütünün tamamilə soyuduğundan əmin olun (> 1 saat).

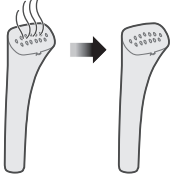

- 3 Buxar yerini nəm parça ilə silin.

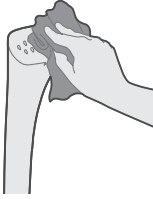

- 4 Su çənini tamamilə boşaldın.

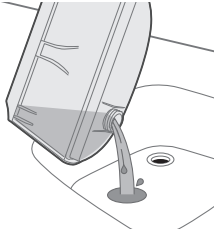

- 5 Elektrik naqilini bazanın ətrafına sarıyın.

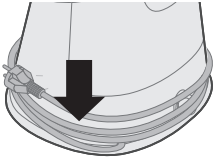

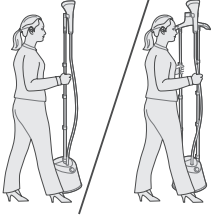

6 Buxar ütüsünü dirək vasitəsilə daşıya bilərsiniz.

Nasazlıqların aradan qaldırılması

Bu fəsilə cihazda qarşılaşa biləcəyiniz ən ümumi problemlər qeyd edilib. Aşağıdakı məlumatlarla problemi həll edə bilməyənlər, tez-tez verilən sualların siyahısına baxmaq üçün www.philips.com/support linkinə daxil olun və ya ölkənizdəki istehlakçılara Yardım Mərkəzi ilə əlaqə saxlayın.

Problem	Mümkün səbəb	Həll
Cihaz buxar yaratmır və ya davamlı şəkildə buxar yaratmır.	Buxar ütüsünün başlığı kifayət qədər isinmir.	Təxminən 45 saniyə cihazın qızmasını gözləyin (STE1010/75: təxminən 2 dəqiqə).
	Buxar şlanqda kondensasiyaya məruz qalıb.	Şlanqı düzəltmək üçün buxar başlığını şaquli şəkildə qaldırın. Bu, kondensatın geri axmasına imkan verir.
	Su qabında kifayət qədər su yoxdur və ya qab düzgün daxil edilməyib.	Su qabını yenidən doldurun və onu düzgün daxil edin.
	Cihazda həddindən artıq çox ərp yaranıb.	Ərpdən təmizləmə prosesini yerinə yetirin. Ərp təmizləmə bölməsinə baxın.
Buxar ütüsünün başlığından su damcıları axır və ya cihaz qur-qur səsi çıxır.	Buxar ütüsünün başlığını və/və ya buxar vermə şlanqını uzun müddət üfüqi vəziyyətdə saxlamısınız.	Şlanqı düzəltmək üçün buxar başlığını şaquli şəkildə qaldırın. Bu, kondensatın geri axmasına imkan verir.
	Şlanq U formasında olan zaman şlanqda olan kondensat su çəninə geri axa bilmir.	Şlanqı düzəltmək üçün buxar başlığını şaquli şəkildə qaldırın. Bu, kondensatın geri axmasına imkan verir.

36 Azərbaycanca

Cihaz isinən zaman buxar ütüsünün başlığından çox miqdarda su damcılarını əmələ gəlir.

Cihazdakı su çirklidir və ya uzun müddət cihazın içində qalıb.

Ərpdən təmizləmə prosesini yerinə yetirin. Ərp təmizləmə bölməsinə baxın.

Buxar təməmindən su sızır.

Su çəninin qapağını və ya ərp təmizləmə klapanını lazımi qaydada bağlamamısınız. Su qabını düzgün daxil edilməyib.

Su çəninin qapağını və ya ərp təmizləmə klapanını lazımi qaydada bağlayın Su qabını düzgün daxil edin.

Pendahuluan

Terima kasih telah membeli produk Philips! Untuk mendapatkan manfaat dukungan Philips secara penuh, daftarkan produk Anda di www.philips.com/welcome. Baca petunjuk pengguna ini, sebaran informasi penting, dan panduan mulai cepat dengan saksama sebelum Anda menggunakan alat ini. Simpanlah sebagai referensi jika dibutuhkan kelak.

Ringkasan produk

STE1020, STE1030, STE1040

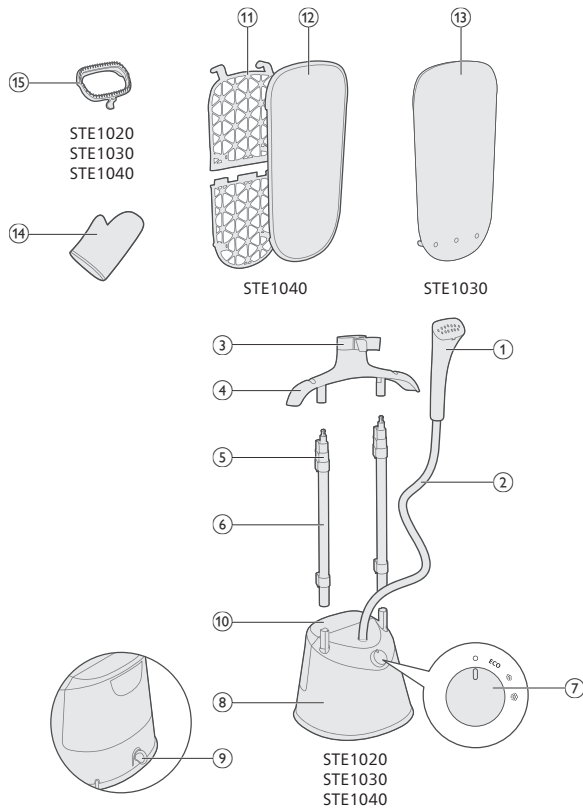

STE1010

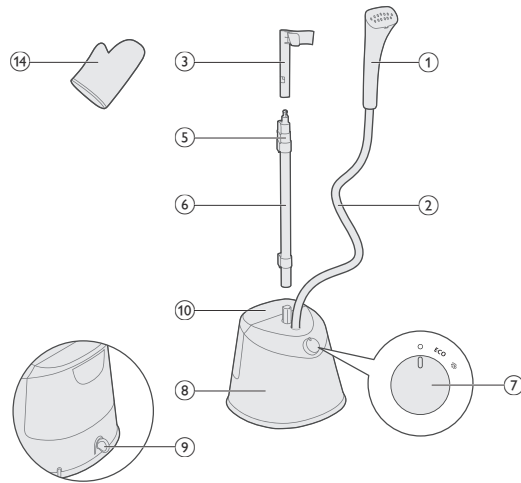

- 1 Kepala penyembur uap
- 2 Selang uap
- 3 Dok penyembur uap
- 4 Gantungan (STE1020, STE1030, STE1040)
- 5 Klip pengunci tiang
- 6 Tiang
- 7 Tombol uap
- 8 Bagian dasar alat
- 9 Kenop pembersihan kerak
- 10 Tangki air
- 11 Papan (STE1040)
- 12 Penutup (STE1040)
- 13 Alas (STE1030)
- 14 Sarung tangan
- 15 Sikat (STE1020, STE1030, STE1040)

Persiapan sebelum menggunakan

Jenis air yang digunakan

Alat ini dapat menggunakan air keran. Namun, jika Anda tinggal di daerah dengan kesadahan air yang tinggi, sebaiknya campurkan air keran dengan air suling/demineralisasi dengan perbandingan yang sama. Hal ini akan mencegah terbentuknya kerak dengan cepat dan memperpanjang masa pakai alat.

Jangan tambahkan pewangi, air dari pengering pakaian, cuka, kanji, zat pembersih kerak, bahan pelembut penyetrikaan, bahan kimia pembersih kerak, atau bahan kimia lain karena dapat menyebabkan air menyembur, menimbulkan noda cokelat, atau kerusakan pada alat.

Peringatan

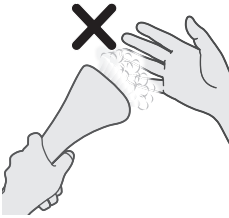

1 Jangan sampai uap mengenai kulit secara langsung.



2 Jangan mengarahkan pelat uap ke orang lain.

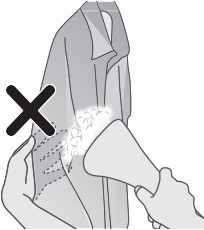

3 Jangan memegang pakaian yang membuatnya langsung terkena uap.

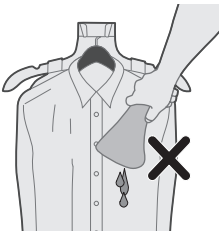

4 Jangan arahkan kepala penyembur uap ke bawah saat digunakan.

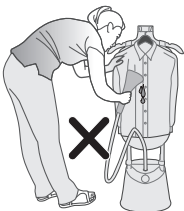

5 Jangan menekuk selang untuk menguapi pakaian.

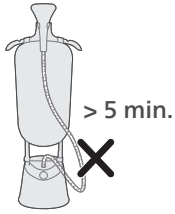

6 Jangan meninggalkan penyembur uap berdiri tanpa pengawasan lebih dari 5 menit.

Menyiapkan alat

STE1010

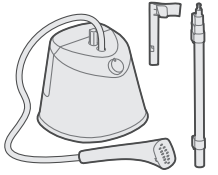

1 Pastikan kelengkapan komponen alat yang telah Anda beli.

STE1020, STE1030
STE1040



STE1010

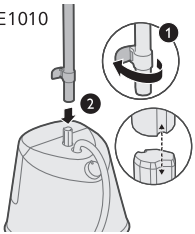

2 Buka kunci klip pengunci tiang bagian bawah dan masukkan tiang ke bagian dasar alat. Sejajarkan penampang tiang dan tonjolan tiang bagian dasar alat.

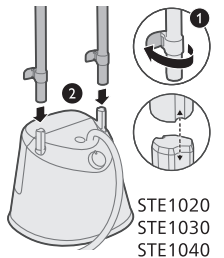

STE1020
STE1030
STE1040

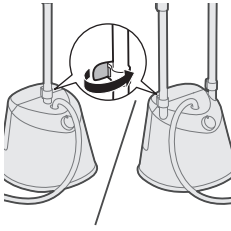

3 Kunci klip pengunci tiang bagian bawah.

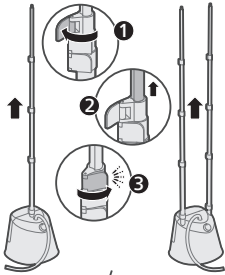

4 Buka kunci klip pengunci tiang lainnya, panjangkan tiang ke atas sepenuhnya, lalu kunci.

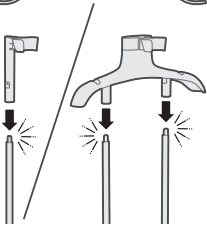

5 Masukkan dok penyembur uap ke dalam tiang hingga terkunci dengan benar (berbunyi 'klik').

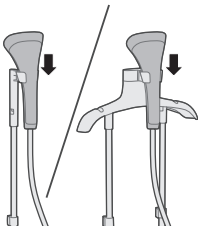

6 Letakkan kepala penyembur uap pada dok penyembur uap.

Menyiapkan papan

1 Pastikan kelengkapan komponen alat yang telah Anda beli.

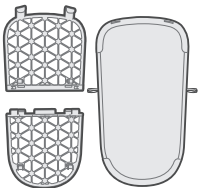

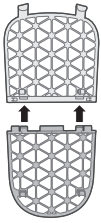

2 Sejajarkan dan masukkan klip papan hingga terkunci dengan benar (berbunyi 'klik').

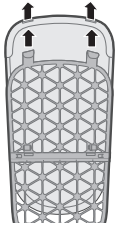

3 Sejajarkan dan masukkan penutup papan melalui kait papan.

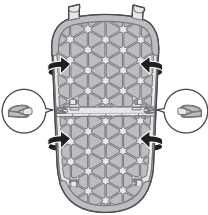

4 Kaitkan tali penutup papan ke kait di bagian belakang papan.

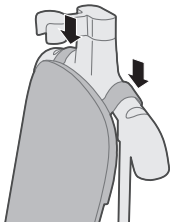

5 Taruh papan pada gantungan.

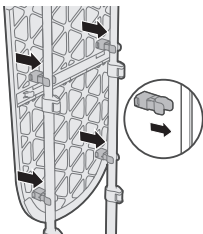

6 Kencangkan papan pada tiang hingga terkunci dengan benar (berbunyi 'klik').

- 7 Anda dapat menggantung pakaian menggunakan gantungan.

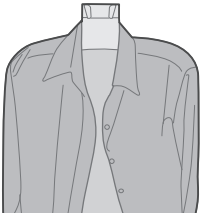
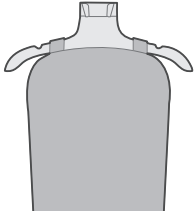

- 8 Anda dapat menggunakan gantungan Anda sendiri dan menaruhnya di dok penyembur uap.

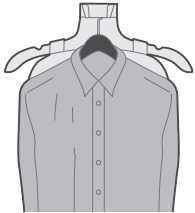

Menyiapkan alas

- 1 Masukkan tali tengah melalui dok penyembur uap.

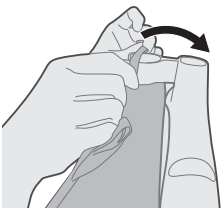

- 2 Pasang 3 tali pada kait di bagian belakang gantungan.

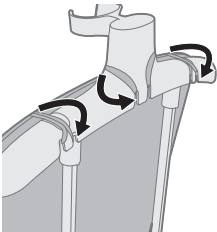

44 Bahasa Indonesia

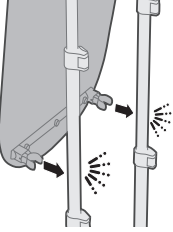

3 Pasang alas pada tiang hingga terkunci dengan benar (berbunyi 'klik').

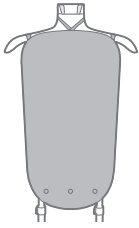

4 Anda dapat menggantung pakaian menggunakan gantungan.



5 Anda dapat menggunakan gantungan Anda sendiri dan menaruhnya di dok penyembur uap.

Memasang sikat

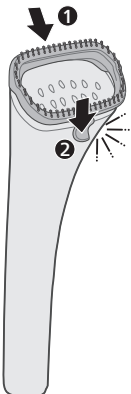

1 Sejajarkan jalur di sepanjang bagian atas kepala penyembur uap, lalu kunci pengait di bagian bawah (hingga berbunyi 'klik').

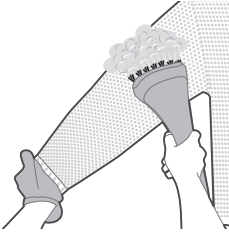

- 2 Anda dapat menggunakan sarung tangan dan menguapi pakaian menggunakan sambungan sikat.

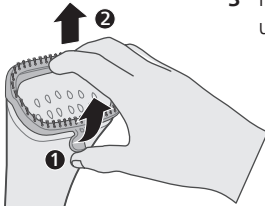

- 3 Pegang dan tarik keluar pengait dari bagian bawah kepala penyembur uap untuk melepas sambungan sikat.

Mengisi tangki air

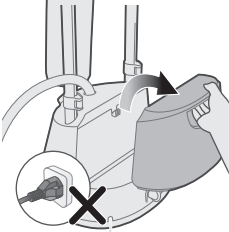

- 1 Jangan colokkan steker alat ke stopkontak. Keluarkan tangki air dari bagian dasar alat.

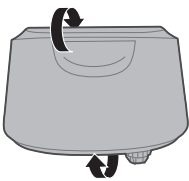

- 2 Balikkan tangki air dengan tutup tangki air menghadap ke atas.

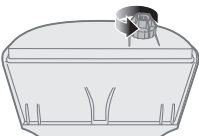

- 3 Putar tutup tangki air berlawanan arah jarum jam untuk melepasnya.

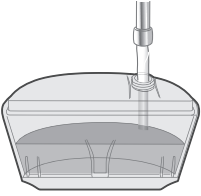

4 Isi tangki air.

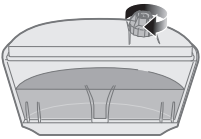

5 Putar tutup tangki air searah jarum jam untuk memasangnya.

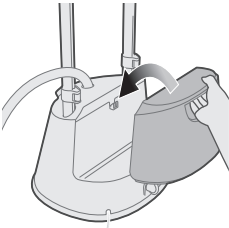

6 Sejajarkan dengan kaitnya untuk memasukkan kembali tangki air ke bagian dasar alat.

Mengubah pengaturan uap

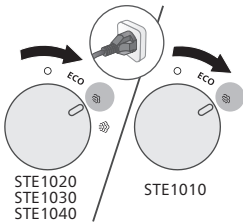

1 Pastikan steker alat telah dicolokkan ke stopkontak. Putar tombol uap ke pengaturan uap yang diinginkan.

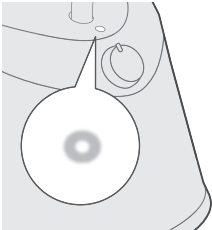

2 Lampu akan terus menyala yang menandakan penyembur uap berdiri sudah berada pada posisi NYALA.

*STE1010/75: ~2 min

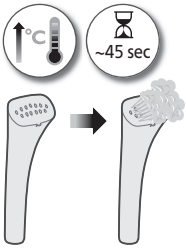

Tip menyetrika

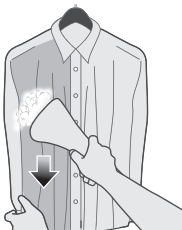
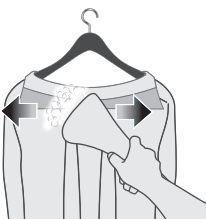
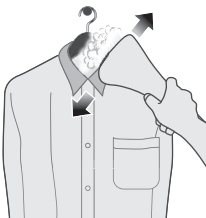
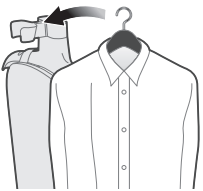

- 3 Tunggu sekitar 45 detik hingga penyembur uap berdiri memanans dan mengeluarkan uap (STE1010/75: sekitar 2 menit).

- 1 Anda dapat menggunakan gantungan Anda sendiri dan menaruhnya di dok penyembur uap.

- 2 Gerakkan kepala penyembur uap sejajar pada kerah baju.

- 3 Gerakkan kepala penyembur uap secara horizontal pada bagian potongan baju.

- 4 Rentangkan pakaian. Gerakkan kepala penyembur uap ke arah bawah pada bagian depan baju.



5 Gerakkan kepala penyembur uap ke arah atas pada saku.

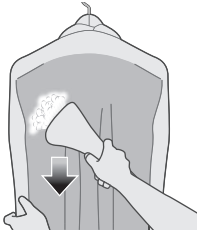

6 Rentangkan pakaian. Gerakkan kepala penyembur uap ke arah bawah pada bagian belakang baju.

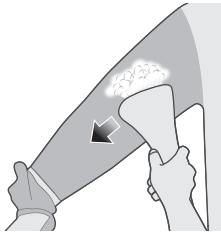

7 Rentangkan pakaian. Gerakkan kepala penyembur uap sejajar pada lengan baju.

Pembersihan dan pemeliharaan

Pengumpul Kerak

Alat ini dibekali sistem Pengumpul Kerak. Sebaiknya bersihkan kerak sebulan sekali atau lebih. Hal ini bertujuan agar uap yang dihasilkan tetap optimal dan mencegah munculnya kotoran serta noda dari tapak alat seiring waktu.

Tip: Sistem Pengumpul Kerak dapat digunakan kapan saja. Jika Anda tinggal di daerah dengan kesadahan air yang tinggi, gunakan fungsi ini lebih sering.

Melakukan proses pembersihan kerak

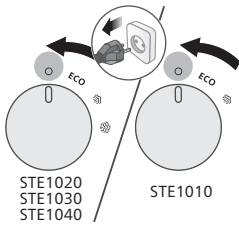

- 1 Pastikan tombol uap berada pada posisi MATI dan steker alat dicabut dari stopkontak.



- 2 Pastikan alat sudah benar-benar dingin (>1 jam).

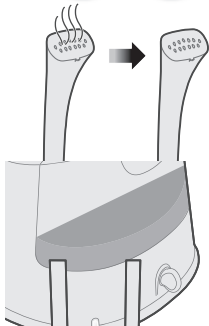

- 3 Taruh penyembur uap di dekat wastafel.

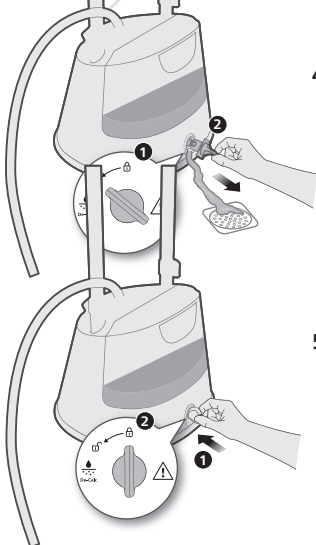

- 4 Putar kunci kenop Pembersihan Kerak ke posisi terbuka, lalu lepaskan kenop Pembersihan Kerak. Biarkan airnya mengalir keluar.

- 5 Pasang dan putar kenop Pembersihan Kerak ke posisi terkunci.

Membersihkan dan menyimpan penyembur uap berdiri

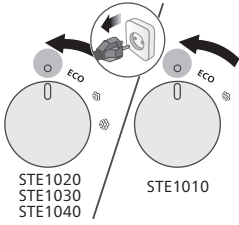

- 1 Pastikan tombol uap berada pada posisi MATI dan steker alat dicabut dari stopkontak.

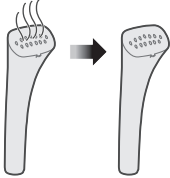

- 2 Pastikan alat sudah benar-benar dingin (>1 jam).

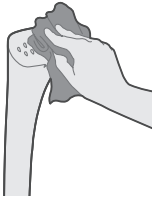

- 3 Seka area uap dengan kain lembap.



- 4 Kosongkan tangki air.

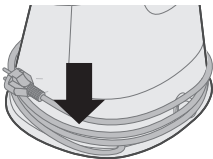

- 5 Lilitkan kabel listrik pada bagian dasar alat.

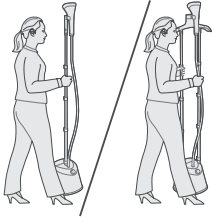

- 6 Anda dapat membawa penyembur uap berdiri dengan memegang tiangnya.

Mengatasi masalah

Bab ini berisi ringkasan masalah yang paling umum ditemui terkait alat. Jika Anda tidak dapat mengatasi masalah dengan mengacu pada informasi di bawah, kunjungi www.philips.com/support untuk mengetahui daftar pertanyaan yang sering diajukan atau hubungi Pusat Layanan Konsumen di negara Anda.

Masalah	Kemungkinan penyebab	Solusi
Alat tidak mengeluarkan uap atau uap yang dihasilkan tidak beraturan.	Penyembur uap belum cukup panas.	Biarkan alat memanaskan sekitar 45 detik (STE1010/75: sekitar 2 menit).
	Uap mengembun di dalam selang.	Angkat kepala penyembur uap untuk meluruskan selang secara vertikal. Uap yang mengembun akan mengalir kembali.
	Air yang ada di dalam tangki berada di bawah tanda MIN atau tangki tidak terpasang dengan benar.	Isi ulang tangki air dan pasang dengan benar.
Air menetes dari kepala penyembur uap atau alat mengeluarkan bunyi menguak.	Terlalu banyak tumpukan kerak di dalam alat.	Lakukan proses pembersihan kerak. Lihat bagian Pembersihan Kerak.
	Kepala penyembur uap dan/atau selang uap diletakkan pada posisi horizontal dalam waktu yang lama.	Angkat kepala penyembur uap untuk meluruskan selang secara vertikal. Uap yang mengembun akan mengalir kembali.
	Apabila selang membentuk huruf U, uap yang mengembun di dalam selang tidak dapat mengalir kembali ke dalam tangki air.	Angkat kepala penyembur uap untuk meluruskan selang secara vertikal. Uap yang mengembun akan mengalir kembali.

52 Bahasa Indonesia

Terlalu banyak air yang menetes keluar dari kepala penyembur uap saat alat memanaskan.

Air di dalam alat kotor atau berada terlalu lama di dalam alat.

Lakukan proses pembersihan kerak. Lihat bagian Pembersihan Kerak.

Air keluar dari bagian dasar alat penyembur uap.

Tutup tangki air atau kenop pembersihan kerak tidak kencang. Tangki air tidak dipasang dengan benar.

Kencangkan tutup tangki air atau kenop pembersihan kerak. Pasang tangki dengan benar.

Pengenalan

Tahniah atas pembelian anda dan selamat menggunakan Philips! Untuk mendapatkan manfaat sepenuhnya daripada sokongan yang ditawarkan oleh Philips, daftar produk anda di www.philips.com/welcome. Baca manual pengguna ini, risalah maklumat penting dan panduan permulaan ringkas dengan teliti sebelum anda menggunakan perkakas. Simpan untuk rujukan masa hadapan.

Gambaran keseluruhan produk

STE1020, STE1030, STE1040

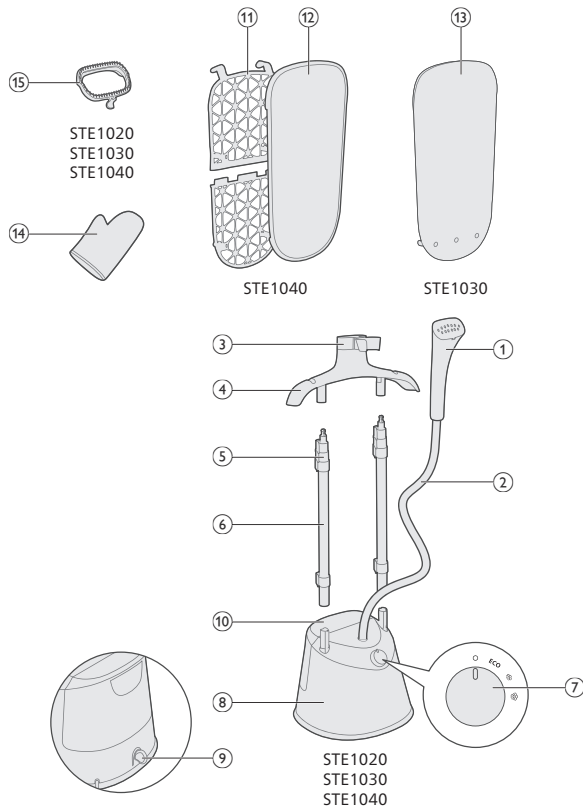

STE1010

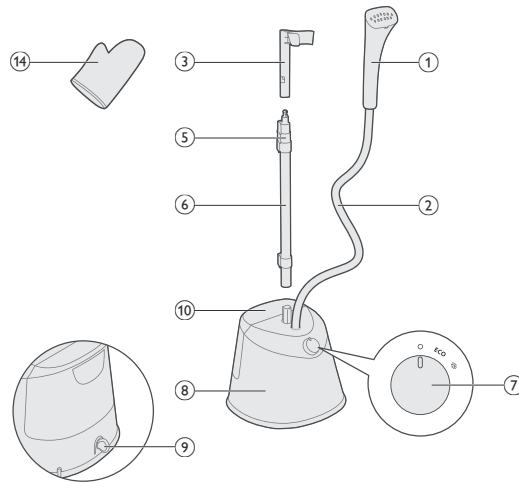

- 1 Kepala penstim
- 2 Hos bekalan stim
- 3 Dok penstim
- 4 Penyangkut (STE1020, STE1030, STE1040)
- 5 Klip pengunci dirian
- 6 Dirian
- 7 Tombol stim
- 8 Tapak
- 9 Tombol pembersihan kerak
- 10 Tangki air
- 11 Papan (STE1040)
- 12 Penutup (STE1040)
- 13 Alas (STE1030)
- 14 Sarung tangan
- 15 Berus (STE1020, STE1030, STE1040)

Bersedia untuk menggunakan

Jenis air untuk digunakan

Perkakas sesuai untuk digunakan dengan air paip. Walau bagaimanapun, jika anda tinggal di kawasan dengan air liat, kami menasihatkan agar anda mencampurkan air paip dengan air suling atau air tanpa mineral dalam jumlah yang sama. Langkah ini akan menghalang pembentukan karat yang cepat dan memanjangkan hayat perkakas anda.

Jangan tambahkan pewangi, air dari mesin pengering pakaian, cuka, kanji, agen penyahkerak, bahan bantu penyeterikaan, air dinyahkerak secara kimia atau bahan kimia lain kerana bahan ini

boleh menyebabkan air tersembur, kesan kotoran perang atau kerosakan pada perkakas anda.

Amaran

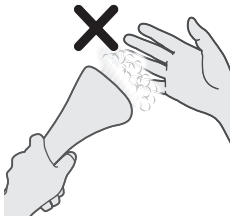

1 Jangan biarkan sebarang bahagian kulit bersentuhan terus dengan stim.



2 Jangan halakan plat stim kepada orang lain.

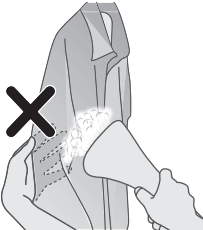

3 Jangan pegang pakaian anda dengan cara yang bersentuhan terus dengan stim.

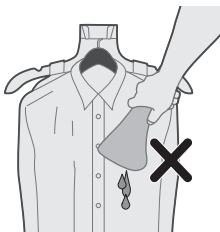

4 Jangan halakan kepala penstim ke arah bawah.



5 Jangan bengkokkan hos untuk menstim pakaian.

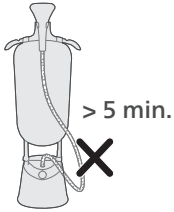

6 Jangan biarkan penstim dirian tanpa dijaga melebihi 5 minit.

Menyediakan perkakas

STE1010

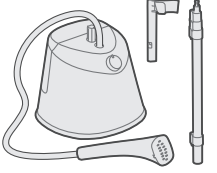

1 Catatkan bahagian-bahagian yang tersedia untuk perkakas yang anda beli.

STE1020, STE1030
STE1040



2 Buka kunci klip kunci dirian bawah dan masukkan dirian ke dalam tapak. Pastikan profil dirian dan stad dirian tapak dijajarkan.

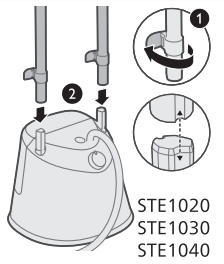
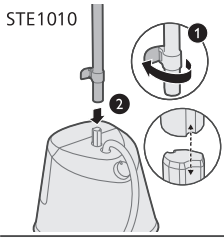

STE1020
STE1030
STE1040

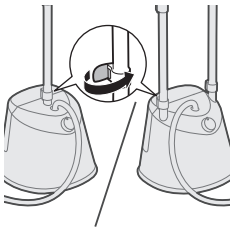

3 Kunci klip kunci dirian bawah.

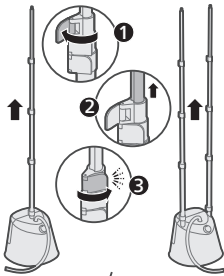

4 Buka kunci klip kunci dirian yang tinggal, panjangkan dirian ke atas sepenuhnya dan kuncikanya.

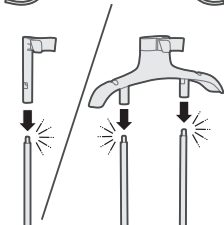

5 Masukkan dok penstim ke dalam dirian sehingga terkunci pada tempatnya ("klik").

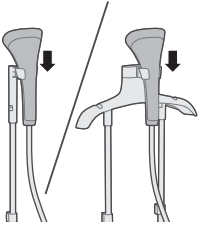

6 Letakkan kepala penstim di atas dok penstim.

Menyediakan papan

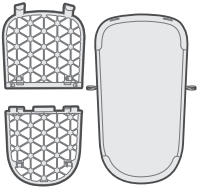

1 Catatkan bahagian-bahagian yang tersedia untuk perkakas yang anda beli.

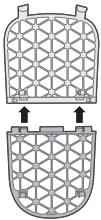

2 Jajarkan dan masukkan klip papan sehingga terkunci pada tempatnya ("klik").

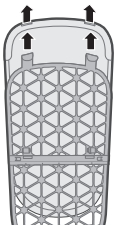

3 Jajarkan dan masukkan alas papan melalui cangkuk papan.

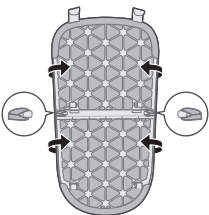

4 Cangkukkan tali alas papan ke atas cangkuk di bahagian belakang papan

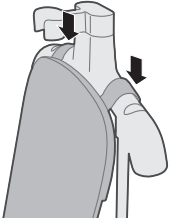

5 Letakkan papan pada penyangkut.

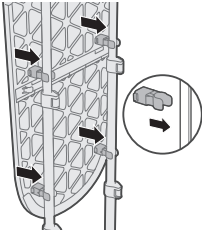

6 Ketatkan papan pada dirian sehingga terkunci pada tempatnya ("klik").

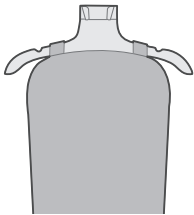

7 Anda boleh menggantung pakaian anda menggunakan penyangkut.

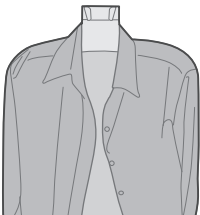

8 Anda boleh menggunakan penyangkut anda sendiri dan letakkannya di atas dok penstim.

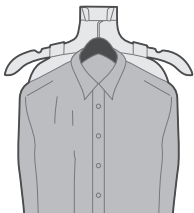

Menetapkan alas

- 1 Masukkan tali tengah melalui dok penstim.

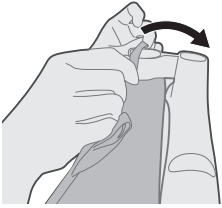

- 2 Ketatkan 3 tali pada cangkuk di bahagian belakang penyangkut.

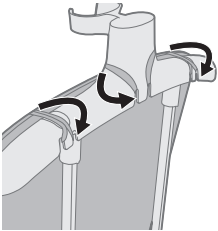

- 3 Ketatkan alas pada dirian sehingga terkunci di tempatnya ("klik").

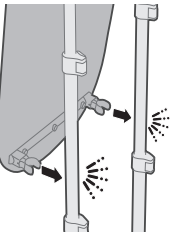

- 4 Anda boleh menggantung pakaian anda menggunakan penyangkut.

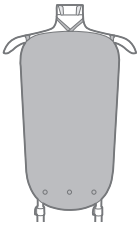



- 5 Anda boleh menggunakan penyangkut anda sendiri dan letakkannya di atas dok penstim.

Memasukkan berus

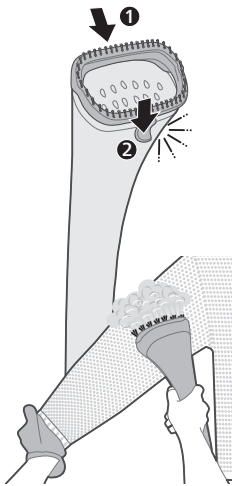

- 1 Jajarkan trek di sepanjang bahagian atas kepala penstim dan ketapkan selak di bahagian bawah ("klik").

- 2 Anda boleh memakai sarung tangan dan menstim pakaian menggunakan alat tambahan berus.

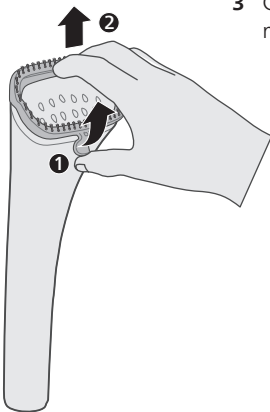

- 3 Genggam dan tarik keluar selak dari bahagian bawah kepala penstim untuk menanggalkan alat tambahan berus.

Mengisi tangki air

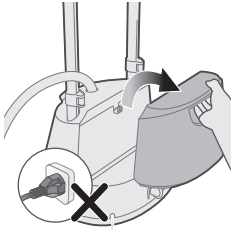

1 Jangan pasang palam perkakas. Keluarkan tangki air dari tapak.

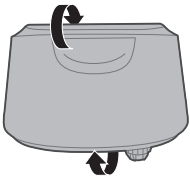

2 Terbalikkan tangki air dengan penutup tangki air menghadap ke atas.

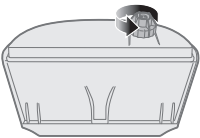

3 Buka skru penutup tangki air melawan arah jam untuk menanggalkannya.

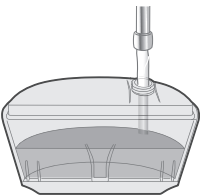

4 Isi tangki air sehingga penuh.

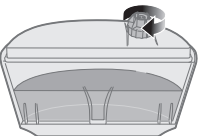

5 Ketatkan skru tangki air mengikut arah jam.

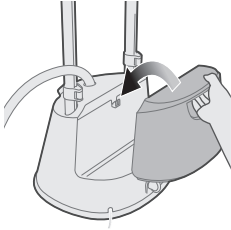

- 6 Jajarkan dengan cangkuk untuk meletakkan tangki air kembali ke tapak.

Menukar tetapan stim

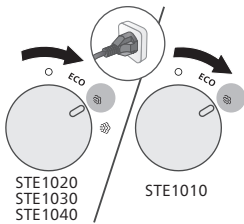

- 1 Pastikan plag perkakas dipasang. Putar tombol stim kepada tetapan stim yang dikehendaki.

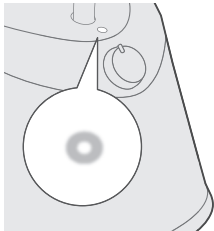

- 2 Lampu akan berhenti berkelip untuk menunjukkan penstim dirian DIHIDUPKAN.

*STE1010/75: ~2 min

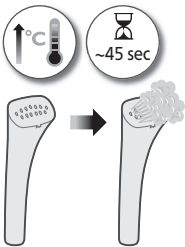

- 3 Tunggu selama kira-kira 45 saat untuk penstim dirian menjadi panas dan mengeluarkan stim (STE1010/75: kira-kira 2 minit).

Petua menyeterika

- 1 Anda boleh menggunakan penyangkut anda sendiri dan letakkannya di atas dok penstim.

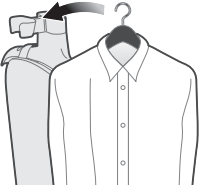

- 2 Gerakkan kepala penstim dalam arah selari dengan kolar.

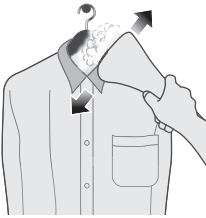

- 3 Gerakkan kepala penstim dalam arah mendatar dengan bahu mendatang.



- 4 Regangkan pakaian. Gerakkan kepala penstim dalam arah ke bawah di hadapan badan.

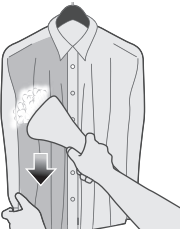

- 5 Gerakkan kepala penstim ke arah atas pada poket.



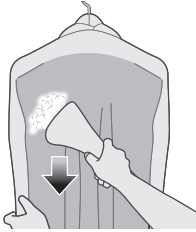

- 6 Regangkan pakaian. Gerakkan kepala penstim dalam arah ke bawah di bahagian belakang badan.

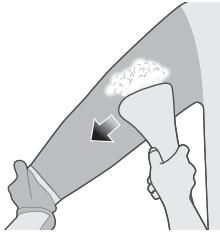

- 7 Regangkan pakaian. Gerakkan kepala penstim dalam arah selari dengan sarung.

Pembersihan dan penyelenggaraan

Pengumpul Kerak

Perkakas anda telah direka bentuk dengan sistem Pengumpul Kerak. Anda disyorkan untuk melakukan penyahkerakan sekali sebulan atau lebih. Ini membantu mengekalkan prestasi stim yang kuat dan mengelakkan habuk serta kotoran keluar dari plat tapak dari masa ke masa.

Petua: Sistem Pengumpul Kerak boleh digunakan pada bila-bila masa. Jika air di kawasan anda sangat liat, gunakan fungsi ini dengan lebih kerap.

Melakukan proses pembersihan kerak

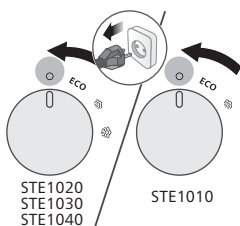

- 1 Pastikan tombol stim berada pada kedudukan MATI dan palam perkakas dicabut.

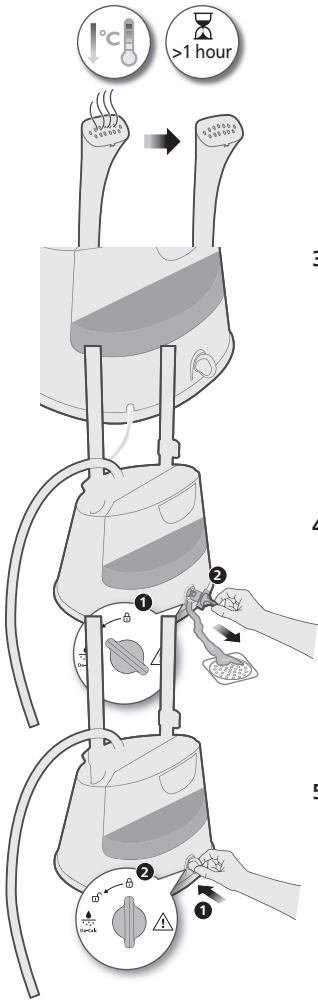

2 Pastikan seterika telah menjadi sejuk sepenuhnya (> 1 jam).

3 Letakkan penstim berhampiran dengan saliran.

4 Putarkan tombol Nyahkerak kepada kedudukan buka kunci dan keluarkan tombol Nyahkerak. Biarkan air disalurkan.

5 Masukkan dan putar tombol Nyahkerak kepada kedudukan kunci.

Membersihkan dan menyimpan penstim dirian

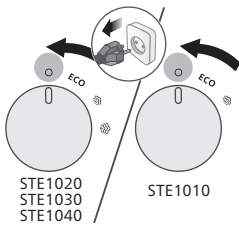

1 Pastikan tombol stim berada pada kedudukan MATI dan palam perkakas dicabut.

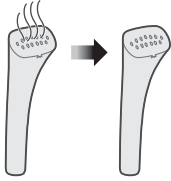

2 Pastikan seterika telah menjadi sejuk sepenuhnya (> 1 jam).

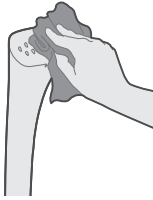

3 Lap tempat stim dengan kain lembap.



4 Kosongkan tangki air sepenuhnya.

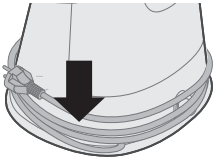

5 Lilitkan kord kuasa melingkari tapak penstim.

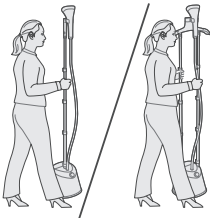

6 Anda boleh membawa penstim dirian dengan memegang dirian.

Penyelesaian masalah

Bab ini meringkaskan masalah paling lazim yang anda hadapi dengan perkakas. Jika anda tidak dapat menyelesaikan masalah dengan maklumat di bawah, lawati www.philips.com/support untuk mendapatkan senarai soalan lazim atau hubungi Pusat Layanan Pelanggan di negara anda.

Masalah	Penyebab yang mungkin	Penyelesaian
Perkakas tidak mengeluarkan stim atau mengeluarkan stim yang tidak sekata.	Penstim tidak memanaskan dengan secukupnya.	Biarkan perkakas menjadi panas selama kira-kira 45 saat (STE1010/75: kira-kira 2 minit).
	Stim telah terpeluwap di dalam hos.	Angkat kepala penstim untuk meluruskan hos secara menegak. Ini membolehkan sebarang pemeluwapan untuk mengalir semula.
	Air di dalam tangki tidak mencukupi atau tangki tidak dimasukkan dengan betul.	Isi semula tangki air dan masukkannya dengan betul.
Titisan air menitis daripada kepala penstim atau perkakas mengeluarkan bunyi menguak.	Terlalu banyak kerak telah menokok di dalam perkakas.	Jalankan proses pembersihan kerak. Rujuk bahagian Pembersihan Kerak.
	Anda telah membiarkan kepala penstim dan/atau hos bekalan stim dalam kedudukan mendarat dalam tempoh masa yang lama.	Angkat kepala penstim untuk meluruskan hos secara menegak. Ini membolehkan sebarang pemeluwapan untuk mengalir semula.
	Apabila hos membentuk bentuk U, pemeluwapan dalam hos tidak dapat mengalir semula ke dalam tangki air.	Angkat kepala penstim untuk meluruskan hos secara menegak. Ini membolehkan sebarang pemeluwapan untuk mengalir semula.
Banyak air menitis daripada kepala penstim apabila perkakas mula memanaskan.	Air di dalam perkakas adalah kotor atau telah dibiarkan di dalam perkakas dalam tempoh yang lama.	Jalankan proses pembersihan kerak. Rujuk bahagian Pembersihan Kerak.
Air keluar daripada tapak penstim.	Anda tidak menutup tutup tangki air atau tombol pembersihan kerak dengan ketat. Tangki air tidak dimasukkan dengan betul.	Tutup tutup tangki air atau tombol pembersihan kerak dengan ketat. Masukkan tangki dengan betul.

Úvod

Gratulujeme k nákupu a vítáme vás mezi uživateli výrobků společnosti Philips! Chcete-li využít všech výhod podpory nabízené společností Philips, zaregistrujte svůj výrobek na stránkách www.philips.com/welcome. Před použitím přístroje si pečlivě tuto uživatelskou příručku, leták s důležitými informacemi a stručnou příručku. Uchovejte je pro budoucí použití.

Přehled výrobku

STE1020, STE1030, STE1040

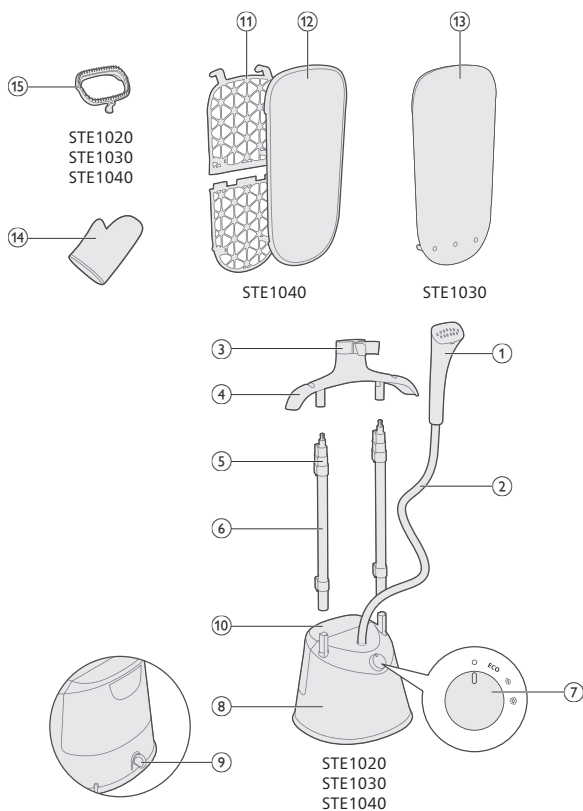

STE1010

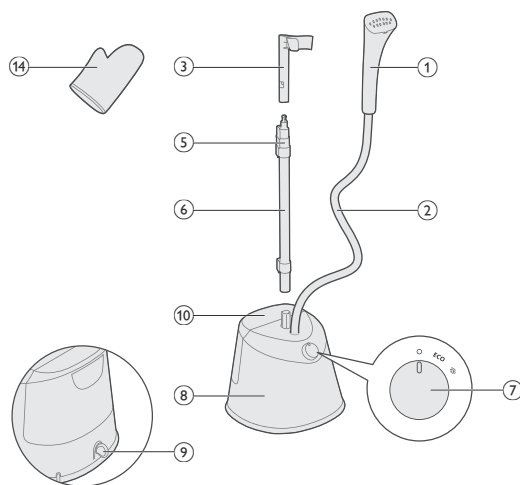

- 1 Hlavice napařovače
- 2 Hadice pro přívod páry
- 3 Dok napařovače
- 4 Věšák (STE1020, STE1030, STE1040)
- 5 Zámková pojistka
- 6 Tyč
- 7 Nastavení páry
- 8 Základna
- 9 Knoflík DE-CALC
- 10 Nádržka na vodu
- 11 Prkno (STE1040)
- 12 Obal (STE1040)
- 13 Podložka (STE1030)
- 14 Rukavice
- 15 Kartáč (STE1020, STE1030, STE1040)

Příprava k použití

Typ použitelné vody

Přístroj je určen pro použití s vodou z kohoutku. Pokud však žijete v oblasti s tvrdou vodou, doporučujeme smíchat stejné množství vody z vodovodu s destilovanou nebo demineralizovanou vodou. Zabráníte tak rychlému usazování vodního kamene a prodloužíte životnost přístroje.

Nepřidávejte parfém, vodu ze sušičky, ocet, škrob, odvěpňovací prostředky, přípravky pro usnadnění žehlení, vodu s chemicky odstraněným vodním kamenem nebo jiné chemikálie, protože by mohlo dojít k vystřikování, vzniku hnědých skvrn nebo poškození zařízení.

Varování

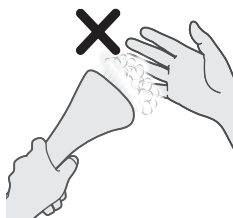

1 Holá kůže se nesmí dostat do kontaktu s párou.



2 Nemiřte proudem páry na jiné osoby.

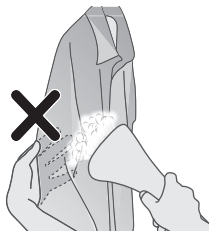

3 Nedržte oděvy tak, že jsou v přímém kontaktu s párou.

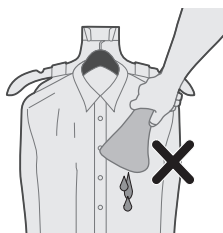

4 Nepoužívejte napařovací hlavici směrem dolů.

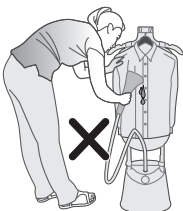

5 Neohýbejte hadici při napařování.

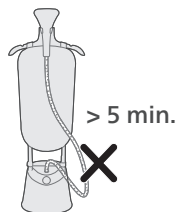

6 Nenechávejte napařovač bez dozoru déle než 5 minut.

Sestavení zařízení

STE1010

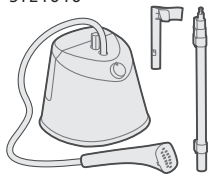

1 Všimněte si částí, které jsou pro vámi zakoupené zařízení k dispozici.

STE1020, STE1030
STE1040



STE1010

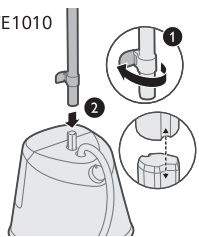

2 Odemkněte zámkovou pojistku a vložte tyč(e) do základny. Ujistěte se, že jsou kolíčky na tyči a na základně srovnané.

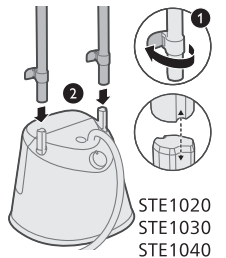

STE1020
STE1030
STE1040

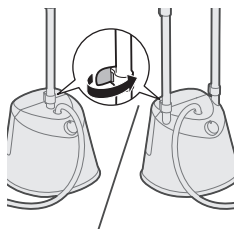

3 Uzamkněte spodní zámkovou pojistku.

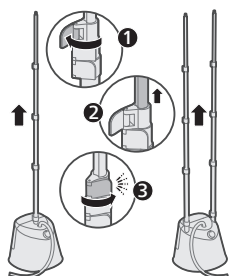

4 Odemkněte zbývající zámkové pojistky, plně roztáhněte tyč a zámkové pojistky opět zamkněte.

5 Dok napařovače pevně připevněte k tyči, dokud nezacvakne na místo.

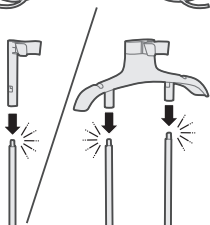

6 Nasadte na dok napařovače hlavici.

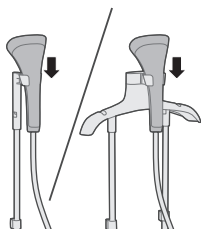

Sestavení prkna

1 Všímněte si částí, které jsou pro vámi zakoupené zařízení k dispozici.

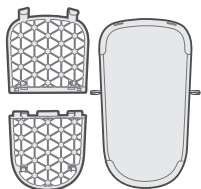

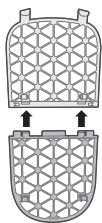

2 Srovnejte a nasadte zámký na prkno, dokud nezacvaknout na místo.

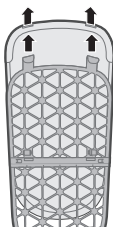

3 Srovnejte a nasadte na háčky prkna obal.

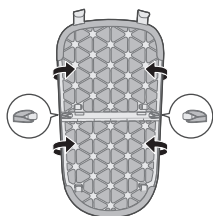

4 Poutka obalu zahákněte za háčky na zadní straně prkna

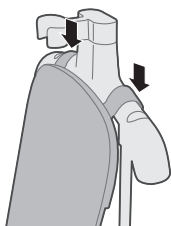

5 Na základnu nasadte prkno.

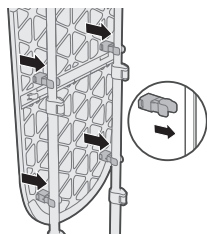

6 Prkno zajistěte, dokud neuslyšíte cvaknutí.

7 Pomocí věšáku můžete nechat oblečení viset.

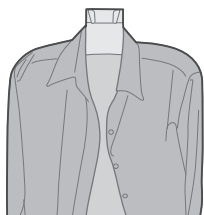
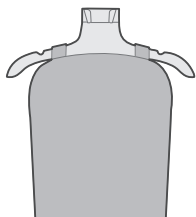

8 Můžete použít také vlastní věšák a umístit jej na dok napařovače.

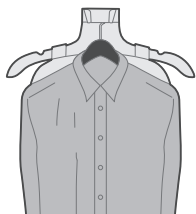

Složení podložky

1 Dokem napařovače vložte prostřední pásek.

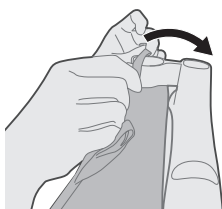

2 Upevněte 3 pásy na háčky na zadní straně věšáku.

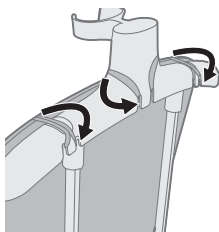

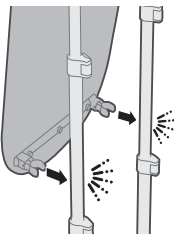

3 Podložku zajistěte, dokud neuslyšíte cvaknutí.

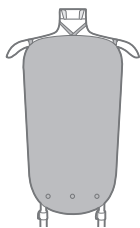

4 Pomocí věšáku můžete nechat oblečení viset.



5 Můžete použít také vlastní věšák a umístit jej na dok napařovače.

Vložení kartáče

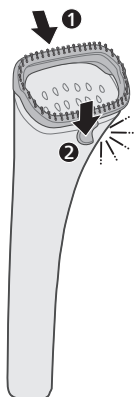

1 Srovnajte kartáč s horní stranou napařovače a zacvakněte ho na místo.

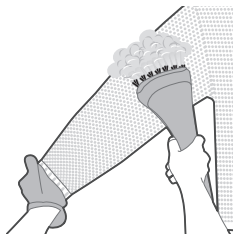

2 Můžete si vzít rukavici a napařovat oblečení pomocí kartáče.

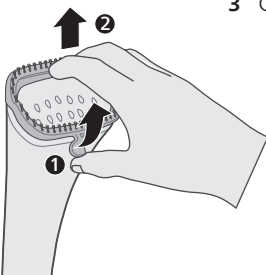

3 Chcete-li kartáč sejmout, vezměte jej a vytáhněte jej.

Naplnění nádržky na vodu

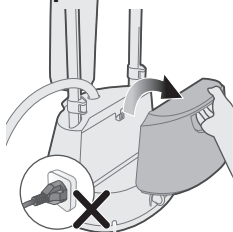

1 Nezapojte zařízení do zásuvky. Sejměte ze základny vodní nádržku.

2 Naplňte nádržku vodou, nádržku držte svisle.

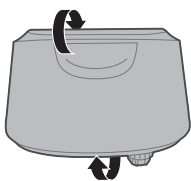

3 Víčko odšroubujte proti směru hodinových ručiček.

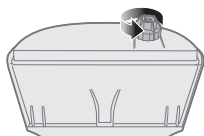

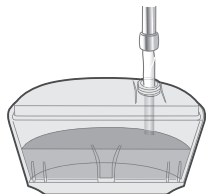

4 Naplňte nádržku na vodu.

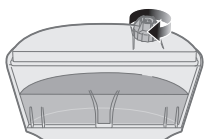

5 Znovu našroubujte víko.

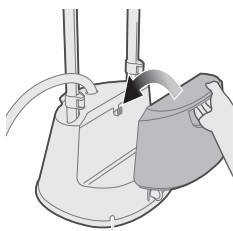

6 Srovnejte ji s háčkem a upevněte nádržku zpět na základnu.

Změna nastavení páry

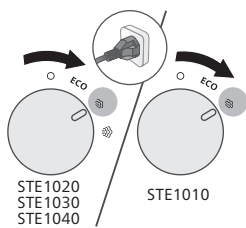

1 Ujistěte se, že je zařízení zapnuté. Otočte výběrníkem na požadované nastavení.

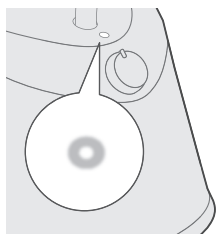

2 Kontrolka se rozsvítí, což indikuje, že je přístroj zapnutý.

*STE1010/75: ~2 min

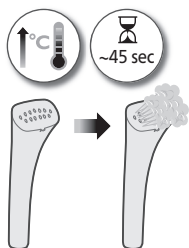

- 3 Počkejte asi 45 sekund, než se přístroj zahřeje a začne vydávat páru (STE1010/75: asi 2 minuty).

Tipy na žehlení

- 1 Můžete použít také vlastní věšák a umístit jej na dok napařovače.

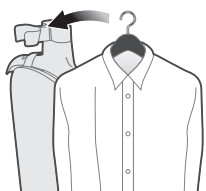

- 2 Pohybuje hlavicí paralelně s límečkem.

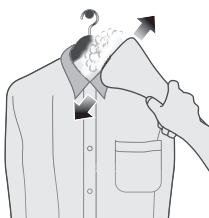

- 3 Pohybuje hlavicí horizontálně ve směru ramen.

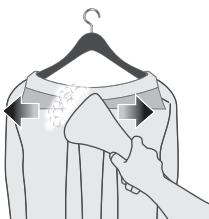

- 4 Natáhněte oděv. Pohybuje hlavicí směrem dolů po přední straně.

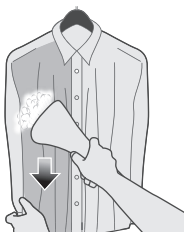



5 Pohybujte hlavicí směrem nahoru po kapsách.



6 Natáhněte oděv. Pohybujte hlavicí směrem dolů po zádech.

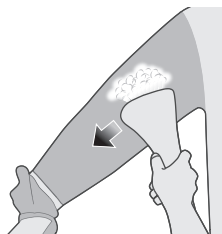

7 Natáhněte oděv. Pohybujte hlavicí paralelně s rukávy.

Čištění a údržba

Calc Collector

Váš přístroj je vybaven systémem Calc Collector. Doporučujeme provádět odstranění vodního kamene jednou měsíčně nebo častěji. To udržuje výkon napařování a předchází přenášení špíny a skvrn ze žehlicí plochy.

Tip: Systém Calc Collector můžete použít kdykoli. Pokud žijete v oblasti s tvrdou vodou, používejte tuto funkci častěji.

Proces odstranění vodního kamene

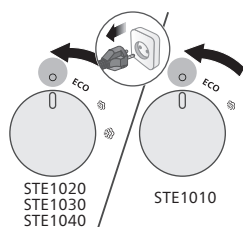

- 1 Ujistěte se, že nastavení páry je v pozici VYPNUTO a přístroj je vytažený ze zásuvky.



- 2 Ujistěte se, že je žehlička úplně vychladnutá (> 1 hod).

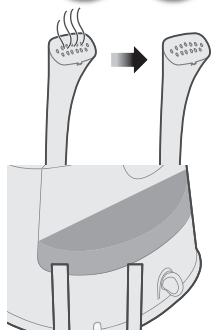

- 3 Umístěte napařovač blízko umyvadla.

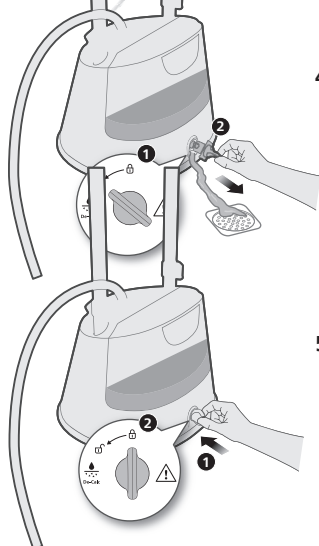

- 4 Otočte knoflíkem De-calc do pozice odemknuto a sejměte jej. Umožněte vodě vytéct.

- 5 Vložte knoflík De-calc zpět a otočte do pozice uzamknuto.

Čištění a skladování napařovače

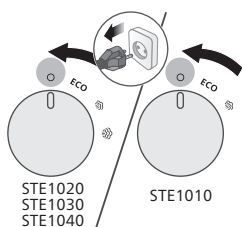

- 1 Ujistěte se, že nastavení páry je v pozici VYPNUTO a přístroj je vytažený ze zásuvky.

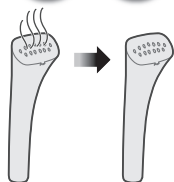

- 2 Ujistěte se, že je žehlička úplně vychladnutá (> 1 hod).

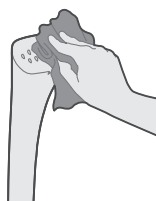

- 3 Otřete napařovací plochu vlhkým hadříkem.

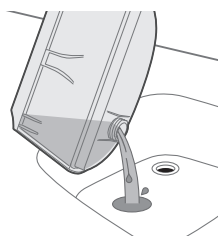

- 4 Vyprázdňte nádržku na vodu.

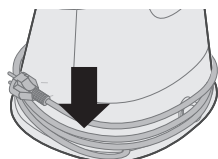

- 5 Napájecí kabel omotejte kolem základny.



6 Nyní můžete přenášet napařovač za tyč.

Odstraňování potíží

V této kapitole najdete nejběžnější problémy, s nimiž se můžete u přístroje setkat. Pokud se vám nepodaří problém vyřešit s pomocí následujících informací, navštivte webové stránky www.philips.com/support, kde naleznete seznam nejčastějších dotazů, nebo se obraťte na středisko péče o zákazníky ve své zemi.

Problém	Možná příčina	Řešení
Přístroj nevytváří žádnou páru nebo tak činí nepravidelně.	Napařovač není dostatečně zahřátý.	Nechte přístroj zhruba 45 sekund zahřívát (STE1010/75: asi 2 minuty).
	V hadici zkondenzovala pára.	Zvedněte hlavu napařovače, aby se hadice svisle narovнала. To umožní stéct kondenzaci zpátky.
	Pokud nejde nádržka do přístroje vložit, snižte hladinu vody.	Nádržku znova naplňte a vložte zpět do přístroje.
Z hlavy napařovače odkapává voda nebo přístroj vrže.	V přístroji se nahromadilo příliš mnoho vodního kamene.	Započnete proplachovací de-calc proces. Projděte si sekci Calc-Clean.
	Nechali jste hlavu napařovače nebo přírodní hadici páry příliš dlouho ve vodorovné poloze.	Zvedněte hlavu napařovače, aby se hadice svisle narovнала. To umožní stéct kondenzaci zpátky.
Když hadice vytvoří tvar U, kondenzace v hadici nemůže stékat zpět do vodní nádržky.	Když hadice vytvoří tvar U, kondenzace v hadici nemůže stékat zpět do vodní nádržky.	Zvedněte hlavu napařovače, aby se hadice svisle narovнала. To umožní stéct kondenzaci zpátky.
	Když se přístroj zahřívá, odkapává z hlavy napařovače nadměrné množství vody.	Voda v přístroji je špinavá nebo byla v přístroji příliš dlouhou dobu.
Ze základny napařovače uniká voda.	Nezavřeli jste pevně víčko vodní nádržky nebo knoflík snadného proplachování. Vodní nádržka není řádně nasazená.	Zavřete víčko vodní nádržky nebo knoflík snadného proplachování. Vložte nádržku na vodu správným způsobem.

Indledning

Tillykke med dit køb, og velkommen til Philips! Hvis du vil have fuldt udbytte af den support, som Philips tilbyder, kan du registrere dit produkt på www.philips.com/welcome. Læs denne brugervejledning, folderen med vigtige oplysninger og lynhåndbogen omhyggeligt igennem, inden apparatet tages i brug. Gem dem til senere brug.

Produktoversigt

STE1020, STE1030, STE1040

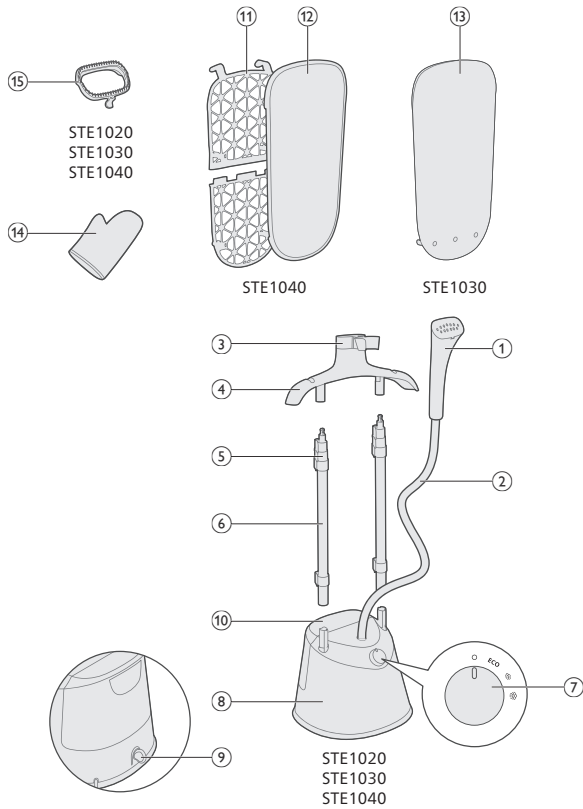

STE1010

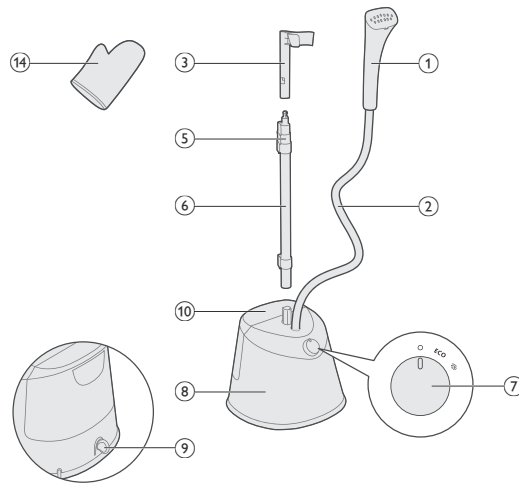

- 1 Damphoved
- 2 Dampslange
- 3 Damperdock
- 4 Bøjle (STE1020, STE1030, STE1040)
- 5 Spændebånd
- 6 Stang
- 7 Dampvælger
- 8 Base
- 9 Afkalkningsknap
- 10 Vandbeholder
- 11 Bræt (STE1040)
- 12 Betræk (STE1040)
- 13 Måtte (STE1030)
- 14 Handske
- 15 Børste (STE1020, STE1030, STE1040)

Klargøring

Type af vand, der skal bruges

Apparatet er velegnet til brug med postevand. Hvis du bor i et område med hårdt vand, anbefaler vi dog, at du blander lige dele postevand og destilleret eller demineraliseret vand. Dette vil forhindre hurtig kalkaflejring og forlænge apparatets levetid.

Tilsæt ikke parfume, vand fra en tørretumbler, eddike, stivelse, afkalkningsmiddel, strygemiddel, kemisk afkalket vand eller andre kemikalier, da de kan medføre vandstænk, brune pletter eller skader på apparatet.

Advarsler

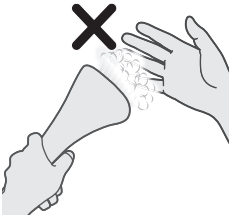

1 Lad ikke nogen del af huden komme i direkte kontakt med dampen.



2 Ret ikke damppladen mod andre personer.

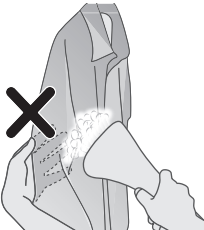

3 Hold ikke tøjet på en måde, der er i direkte kontakt med dampen.

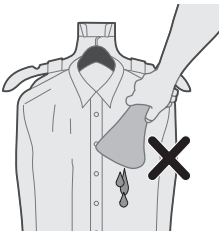

4 Brug ikke damphovedet i nedadgående retning.

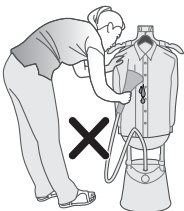

5 Bøj ikke slangen for at dampe tøjet.

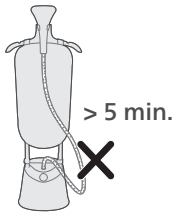

6 Lad ikke damperen stå uden opsyn i mere end 5 minutter.

Opsætning af apparatet

STE1010

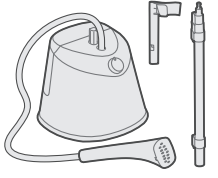

1 Vær opmærksom på de tilgængelige dele til det købte apparat.

STE1020, STE1030
STE1040



STE1010

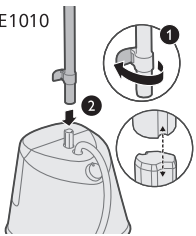

2 Lås låseklemmerne på den nederste stang op, og indsæt stængerne på basen. Sørg for, at profilerne på stængerne og støtteboltene flugter.

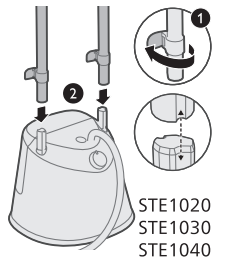

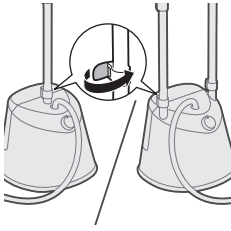

3 Lås låseklemmerne på den nederste stang.

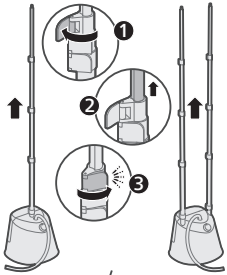

4 Lås de resterende låseklemmer på stangen op, træk stangen helt op, og lås den.

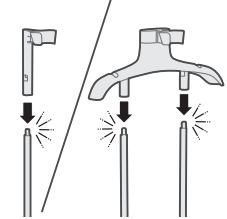

5 Sæt damperen på stangen, indtil den låses på plads ("klik").

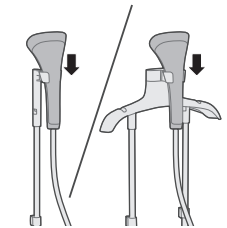

6 Sæt dampovedet i damperdocken.

Opsætning af brættet

1 Vær opmærksom på de tilgængelige dele til det købte apparat.

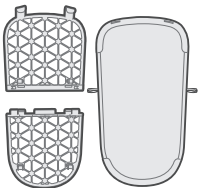

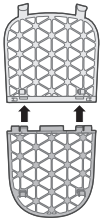

2 Juster og indsæt brætclipsene, indtil de låses på plads ("klik").

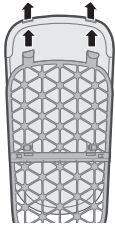

3 Juster og indsæt brætdækslet gennem brætkrogene.

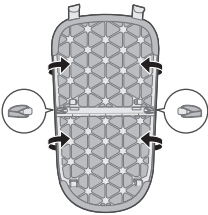

4 Sæt stropperne på brætbetrækket fast på krogene bag på brættet

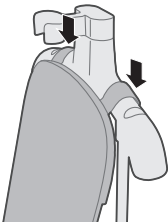

5 Placer brættet på bøjljen.

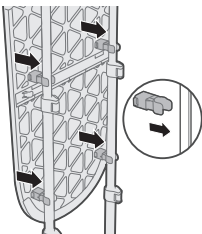

6 Fastgør brættet på stængerne, indtil det låses på plads ("klik").

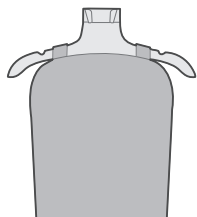

7 Du kan hænge dit tøj ved hjælp af bøjlen.

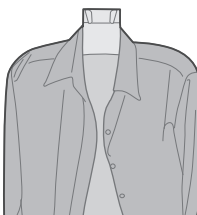

8 Du kan bruge din egen bøjle og placere den på damperdocken.

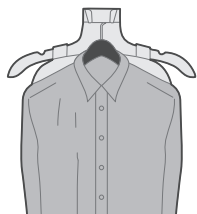

Indstilling af måtten

1 Før den midterste strop gennem docken.

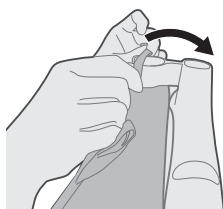

2 Fastgør de 3 stropper på krogen bag på bøjlen.

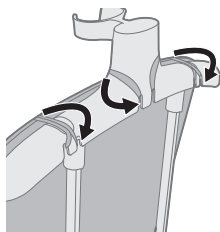

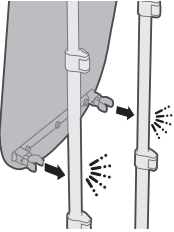

3 Fastgør måtten på stængerne, indtil den låses på plads ("klik").

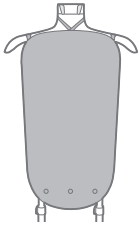

4 Du kan hænge dit tøj ved hjælp af bøjlen.



5 Du kan bruge din egen bøjle og placere den på damperdocken.

Isætning af børsten

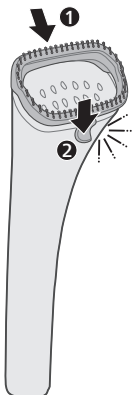

1 Juster sporet langs toppen af damperhovedet, og klik på låsen i bunden ("klik").

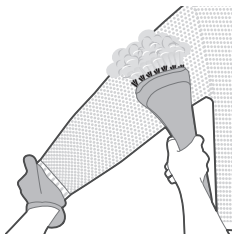

2 Du kan bruge handsken og dampe dit tøj med børstetilbehøret.

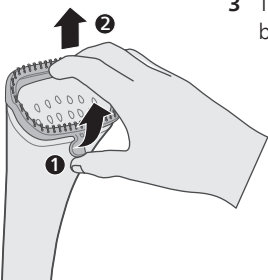

3 Tag fat i og træk låsen ud fra bunden af damperhovedet for at fjerne børstetilbehøret.

Påfyldning af vandtanken

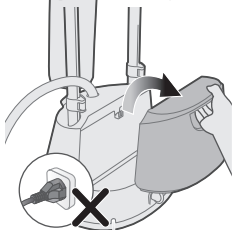

1 Tilslut ikke apparatet. Fjern vandtanken fra basen.

2 Vend vandtanken med vandtankens dæksel opad.

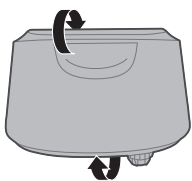

3 Skru vandtankens dæksel af mod uret for at afmontere det.

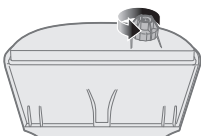

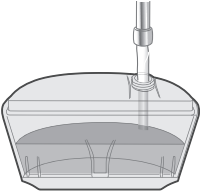

4 Fyld vandtanken.

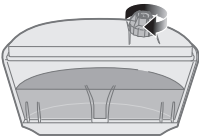

5 Skru vandtankens dæksel med uret for at fastspænde.

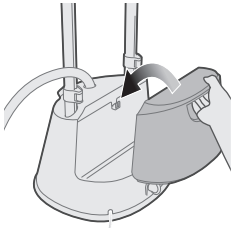

6 Flugt med krogen for at sætte vandtanken tilbage på basen.

Ændring af dampindstillinger

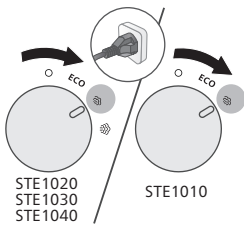

1 Sørg for, at apparatet er sat i stikkontakten. Drej dampvælgeren til den ønskede dampindstilling.

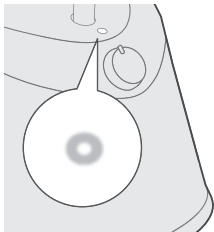

2 Lampen lyser konstant for at indikere, at damperen er tændt.

*STE1010/75: ~2 min

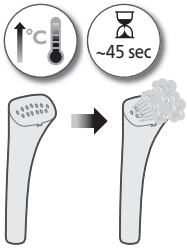

3 Vent i ca. 45 sekunder, indtil damperen varmer op og udsender damp (STE1010/75: ca. 2 minutter).

Tip til strygning

1 Du kan bruge din egen bøjle og placere den på damperdocken.

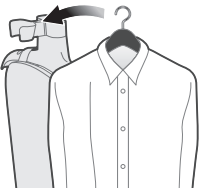

2 Bevæg dampovedet parallelt med kraven.

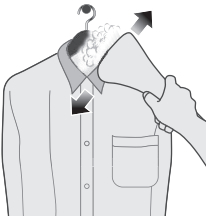

3 Bevæg dampovedet vandret med bærestykket.



4 Stræk tøjet. Bevæg damperhovedet nedad på fronten.

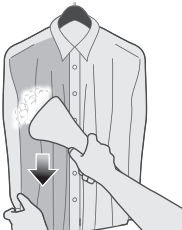



5 Bevæg damperhovedet opad på en lomme.

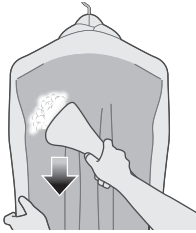

6 Stræk tøjet. Bevæg damperhovedet nedad på bagsiden.

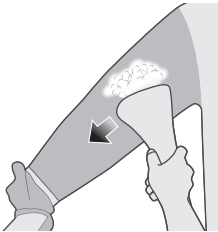

7 Stræk tøjet. Bevæg damperhovedet parallelt med ærmet.

Rengøring og vedligeholdelse

Kalkopsamler

Dit apparat er udstyret med et system til kalkopsamling. Det anbefales at afkalke en gang om måneden eller mere. Derved bibeholdes en imponerende dampproduktion, og det forhindres, at der med tiden kommer snavs og pletter ud fra strygesålen.

Tip: Systemet til kalkopsamling kan bruges når som helst. Hvis du bor i et område med hårdt vand, skal du bruge funktionen oftere.

Sådan fungerer Calc-Clean-funktionen

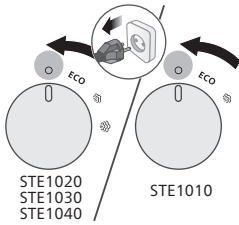

1 Sørg for, at dampvælgeren er i positionen OFF, og at apparatet er taget ud af stikkontakten.

2 Sørg for, at strygejernet er kølet helt ned (> 1 time).



3 Placer damperen tæt på et afløb.

4 Drej De-Calc-knappen til den oplåste position, og fjern De-Calc-knappen. Lad vandet løbe ud.

5 Isæt De-Calc-knappen, og drej den til den låste position.

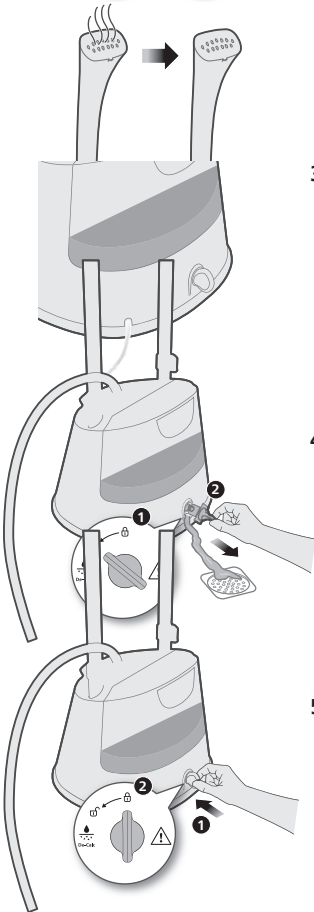

Rengøring og opbevaring af damperen

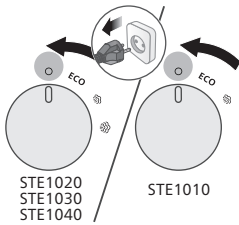

- 1 Sørg for, at dampvælgeren er i positionen OFF, og at apparatet er taget ud af stikkontakten.

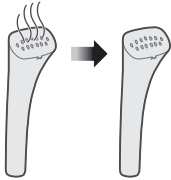

- 2 Sørg for, at strygejernet er kølet helt ned (> 1 time).

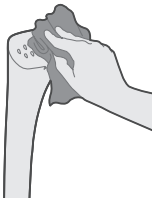

- 3 Tør stedet, hvor du har brugt damperen, af med en fugtig klud.

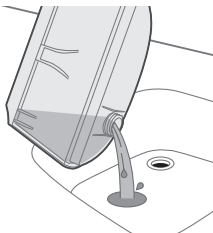

- 4 Tøm vandbeholderen helt.

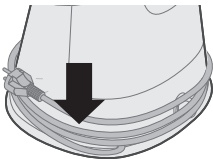

- 5 Rul netledningen rundt om basen.

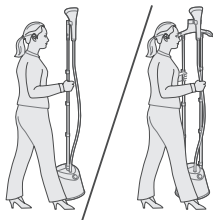

6 Du kan bære damperen i stangen.

Fejlfinding

I dette kapitel beskrives de mest almindelige problemer, der kan opstå med dit apparat. Hvis du ikke kan løse problemet ved hjælp af nedenstående oplysninger, kan du se en liste over ofte stillede spørgsmål på www.philips.com/support. Du er også altid velkommen til at kontakte dit lokale Philips Kundecenter.

Problem	Mulig årsag	Løsning
Apparatet producerer ingen damp eller uregelmæssig damp.	Dampkogereren er ikke varmet tilstrækkeligt op.	Lad apparatet varme op i ca. 45 sekunder (STE1010/75: ca. 2 minutter).
	Der er kondenseret damp i slangen.	Løft stofdamperens hoved for at trække slangen lodret ud. Dette gør, at kondensvand kan løbe tilbage.
	Lav vandstand i tanken, eller tanken er ikke isat korrekt.	Genopfyld vandtanken, og sæt den ordentligt i.
Der drypper vand fra stofdamperens hoved, eller apparatet udsender en kvækkende lyd.	Der er dannet for meget kalk i apparatet.	Udfør afkalkningsprocessen. Se afsnittet Calc-Clean.
	Du har efterladt stofdamperens hoved og/eller damptilførselsslangen i vandret position i lang tid.	Løft stofdamperens hoved for at trække slangen lodret ud. Dette gør, at kondensvand kan løbe tilbage.
	Når slangen er U-formet, kan kondens i slangen ikke løbe tilbage til vandtanken.	Løft stofdamperens hoved for at trække slangen lodret ud. Dette gør, at kondensvand kan løbe tilbage.
En stor mængde vand drypper ud af stofdamperens hoved, når apparatet varmer op.	Vandet i apparatet er snavset eller har stået i apparatet i for lang tid.	Udfør afkalkningsprocessen. Se afsnittet Calc-Clean.
Der kommer vand ud af stofdamperens base.	Du har ikke lukket vandtankens dæksel eller afkalkningsknappen ordentligt. Vandtanken er ikke indsat korrekt.	Luk vandtankens dæksel eller afkalkningsknappen ordentligt. Indsæt tanken korrekt.

Einführung

Herzlichen Glückwunsch zu Ihrem Kauf und willkommen bei Philips! Um das Kundendienstangebot von Philips vollständig nutzen zu können, sollten Sie Ihr Produkt unter www.philips.com/welcome registrieren. Lesen Sie diese Betriebsanleitung, das wichtige Informationsblatt und die Schnellstartanleitung sorgfältig durch, bevor Sie das Gerät verwenden. Bewahren Sie sie zur späteren Verwendung auf.

Produktübersicht

STE1020, STE1030, STE1040

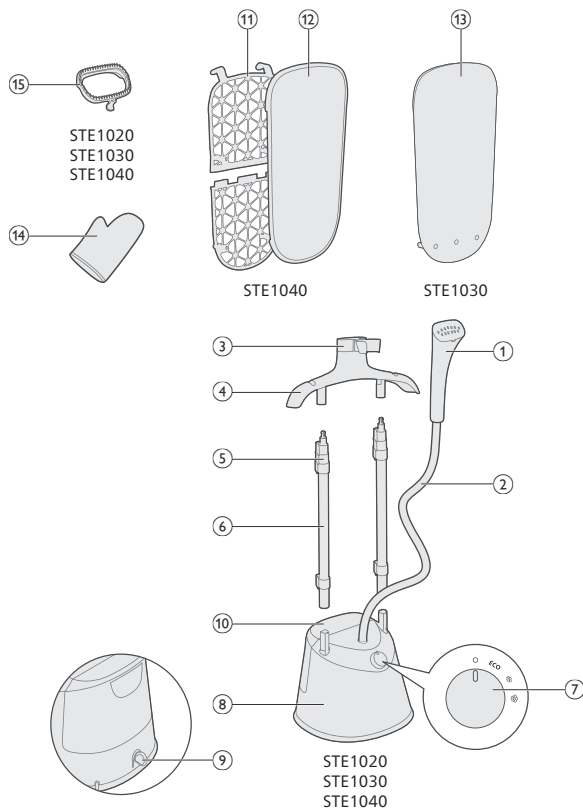

STE1010

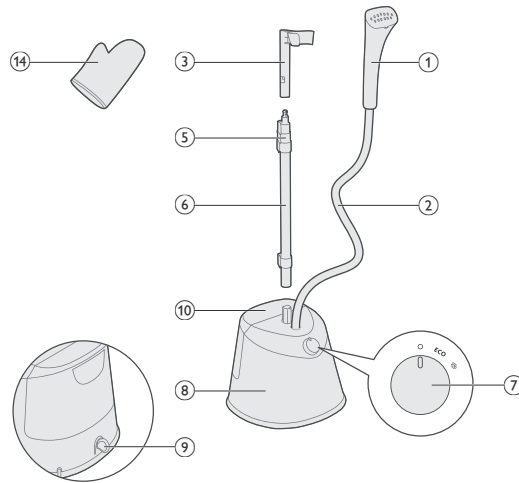

- 1 Kopf der Dampfeinheit
- 2 Verbindungsschlauch
- 3 Dampfeinheit-Dock
- 4 Kleiderbügel (STE1020, STE1030, STE1040)
- 5 Stangenhalterungsclip
- 6 Stange
- 7 Dampfgregler
- 8 Sockel
- 9 De-Calc-Verschluss
- 10 Wasserbehälter
- 11 Bügelbrett (STE1040)
- 12 Abdeckung (STE1040)
- 13 Matte (STE1030)
- 14 Handschuh
- 15 Bürste (STE1020, STE1030, STE1040)

Für den Gebrauch vorbereiten

Zu verwendende Wasserart

Ihr Gerät kann mit Leitungswasser verwendet werden. Wenn Sie jedoch in einem Bereich mit hartem Wasser leben, empfehlen wir Ihnen, eine gleiche Menge Leitungswasser mit destilliertem oder entmineralisiertem Wasser zu mischen. Dadurch wird eine schnelle Kalkablagerung verhindert und die Lebensdauer des Geräts verlängert.

Geben Sie kein Parfüm, Wasser aus dem Wäschetrockner, Essig, Stärke, Entkalkungsmittel, Bügelhilfsmittel, chemisch entkalktes Wasser oder andere Chemikalien hinzu, da dies zu Austreten von Wasser, braunen Flecken oder Schäden am Gerät führen kann.

Warnhinweise

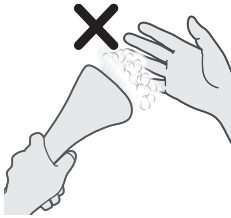

1 Keinen Teil der Haut in direkten Kontakt mit dem Dampf bringen.



2 Die Dampfplatte nicht auf andere Personen richten.

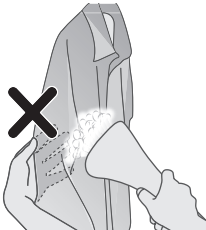

3 Ihre Kleidung nicht so halten, dass sie in direkten Kontakt mit dem Dampf kommt.



4 Den Kopf der Dampfeinheit nicht nach unten zeigend verwenden.

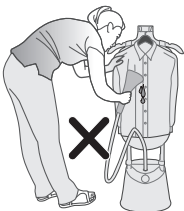

5 Den Schlauch nicht knicken, um das Kleidungsstück zu dampfen.

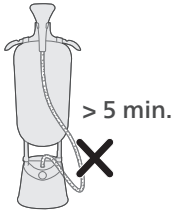

6 Die Stand-Dampfeinheit nicht länger als 5 Minuten unbeaufsichtigt lassen.

Vorbereiten des Geräts

STE1010

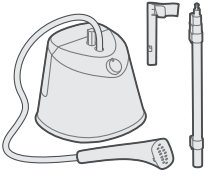

1 Machen Sie sich mit den Teilen vertraut, die für das von Ihnen erworbene Gerät verfügbar sind.

STE1020, STE1030
STE1040



STE1010

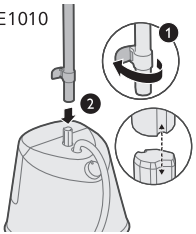

2 Lösen Sie die unteren Stangenhalterungsclips und setzen Sie die Stange(n) in die Basis ein. Stellen Sie sicher, dass die Profile der Stange(n) und die Noppe(n) der Basisstangen aneinander ausgerichtet sind.

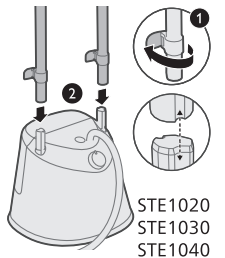

STE1020
STE1030
STE1040

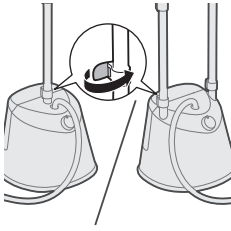

3 Verriegeln Sie den/die unteren Stangenhalterungsclip(s).

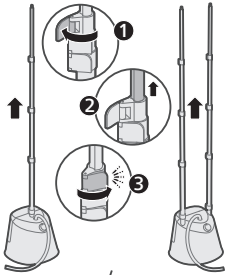

4 Lösen Sie die verbleibenden Stangenhalterungsclips, ziehen Sie die Stange(n) vollständig nach oben und verriegeln Sie sie.

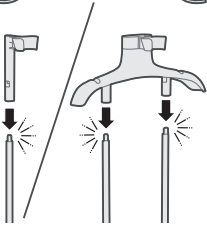

5 Setzen Sie das Dampfheit-Dock auf die Stange(n), bis es hörbar einrastet.

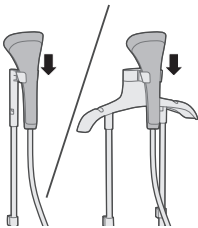

6 Stellen Sie den Kopf der Dampfheit auf das Dampfheit-Dock.

Vorbereiten des Bretts

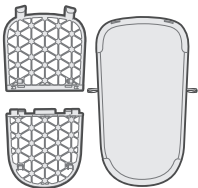

1 Machen Sie sich mit den Teilen vertraut, die für das von Ihnen erworbene Gerät verfügbar sind.

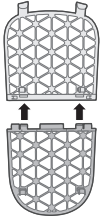

2 Richten Sie die Clips des Bügelbretts aus und setzen Sie sie ein, bis sie hörbar einrasten.



3 Richten Sie die Brettdeckung aus und führen Sie sie durch die Bretthaken ein.

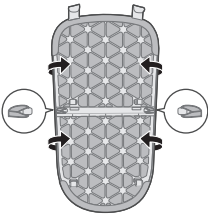

4 Haken Sie die Bänder der Bügelbrettdeckung an den Haken an der Rückseite des Bretts ein.

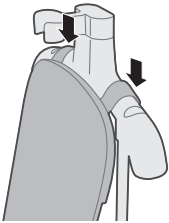

5 Setzen Sie das Brett auf die Halterung.

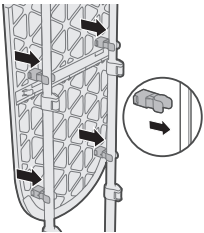

6 Befestigen Sie das Brett an den Stangen, bis es hörbar einrastet.

- 7 Sie können Ihre Kleidung auf den Kleiderbügel hängen.

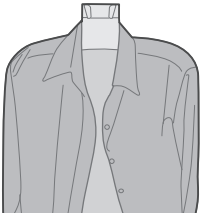
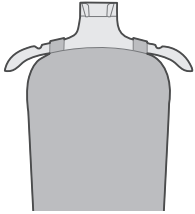

- 8 Sie können Ihren eigenen Kleiderbügel verwenden und diesen auf das Dampfseinheit-Dock hängen.

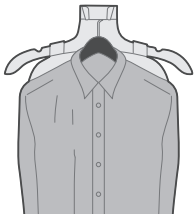

Vorbereiten der Matte

- 1 Führen Sie das mittlere Band durch das Dampfseinheit-Dock.

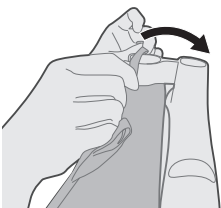

- 2 Befestigen Sie die 3 Bänder am Haken an der Rückseite des Kleiderbügels.

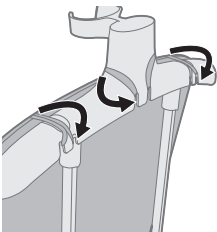

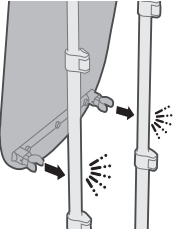

3 Befestigen Sie die Matte an den Stangen, bis sie hörbar einrastet.

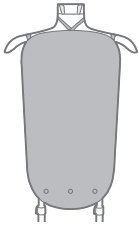

4 Sie können Ihre Kleidung auf den Kleiderbügel hängen.



5 Sie können Ihren eigenen Kleiderbügel verwenden und diesen auf das Dampfheiß-Dock hängen.

Einsetzen der Bürste

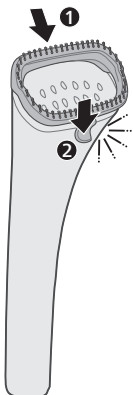

1 Richten Sie die Schiene oben am Kopf der Dampfheißheit aus und lassen Sie die Verriegelung an der Unterseite hörbar einrasten.

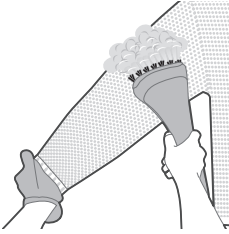

- 2 Sie können den Handschuh verwenden und Ihre Kleidung mit dem Bürstenkopf dampfen.

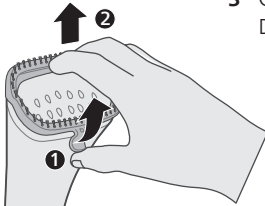

- 3 Greifen Sie nach der Verriegelung an der Unterseite des Kopfs der Dampfeinheit und ziehen Sie sie heraus, um den Bürstenkopf zu entfernen.

Füllen des Wasserbehälters

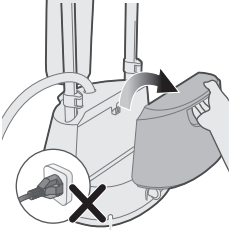

- 1 Stecken Sie das Gerät nicht ein. Nehmen Sie den Wasserbehälter aus der Basis.

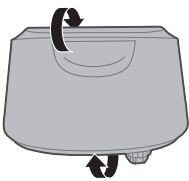

- 2 Drehen Sie den Wasserbehälter mit dem Verschluss des Wasserbehälters nach oben.

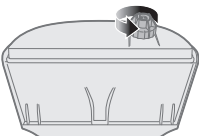

- 3 Schrauben Sie den Verschluss des Wasserbehälters gegen den Uhrzeigersinn ab, um ihn zu entfernen.

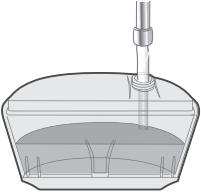

4 Füllen Sie den Wasserbehälter.

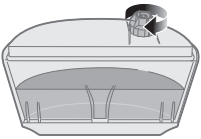

5 Schrauben Sie den Verschluss des Wasserbehälters im Uhrzeigersinn fest.

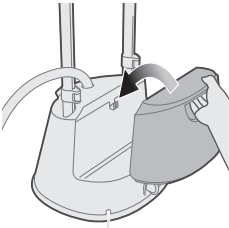

6 Richten Sie den Wasserbehälter am Haken aus, um ihn wieder an der Basis zu befestigen.

Ändern der Dampfeinstellungen

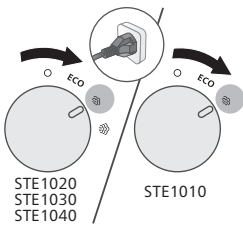

1 Stellen Sie sicher, dass das Gerät angeschlossen ist. Drehen Sie den Dampfgregler auf die gewünschte Dampfeinstellung.

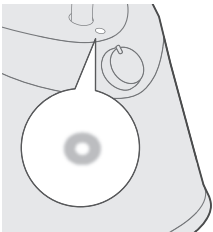

2 Die Anzeige leuchtet dauerhaft, um anzuzeigen, dass die Stand-Dampfeinheit **INGESCHALTET** ist.

*STE1010/75: ~2 min

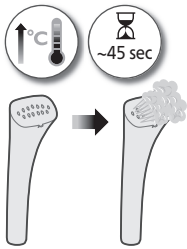

- 3 Warten Sie etwa 45 Sekunden bis der Stand-Dampfglätter sich erwärmt hat und geben Sie Dampf ab (STE1010/75: etwa 2 Minuten).

Bügeltipps

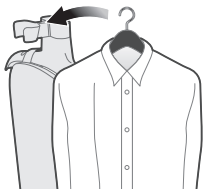

- 1 Sie können Ihren eigenen Kleiderbügel verwenden und diesen auf das Dampfleinheit-Dock hängen.

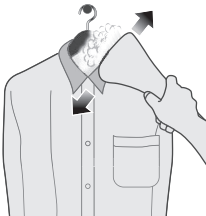

- 2 Bewegen Sie den Kopf der Dampfleinheit parallel zum Kragen.

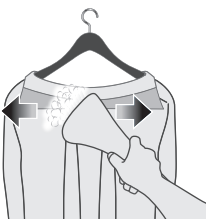

- 3 Bewegen Sie den Kopf der Dampfleinheit horizontal zum Bügel.

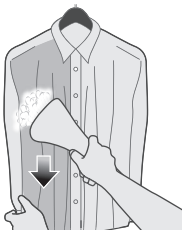

- 4 Dehnen Sie das Kleidungsstück. Bewegen Sie den Kopf der Dampfleinheit auf der Vorderseite nach unten.



5 Bewegen Sie den Kopf der Dampfheit auf einer Tasche nach oben.

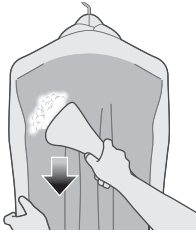

6 Dehnen Sie das Kleidungsstück. Bewegen Sie den Kopf der Dampfheit auf der Rückseite nach unten.

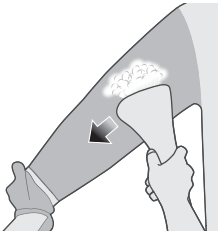

7 Dehnen Sie das Kleidungsstück. Bewegen Sie den Kopf der Dampfheit parallel zum Ärmel.

Reinigung und Wartung

Kalksammler

Ihr Gerät umfasst ein Kalksammlersystem. Es wird empfohlen, einmal im Monat oder häufiger zu entkalken. Damit soll die Dampfleistung möglichst lange Zeit erhalten bleiben und sichergestellt werden, dass Schmutz und Flecken nicht nach einiger Zeit aus der Bügelsohle austreten.

Tipp: Das Kalksammlersystem kann jederzeit verwendet werden. Wenn Sie in einer Region mit hartem Wasser leben, sollten Sie die Funktion häufiger anwenden.

Ausführen des Calc-Clean-Vorgangs

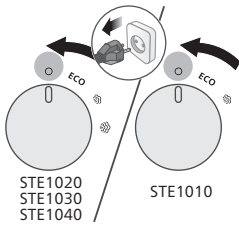

- 1 Stellen Sie sicher, dass sich der Dampfregler in der Position „AUS“ befindet und das Gerät vom Stromnetz getrennt ist.



- 2 Vergewissern Sie sich, dass das Bügeleisen vollständig abgekühlt ist (> 1 Stunde).

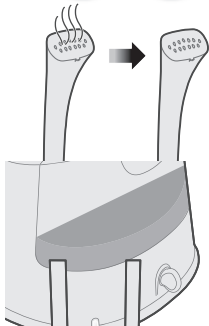

- 3 Platzieren Sie die Dampfleinheit nahe eines Abflusses.

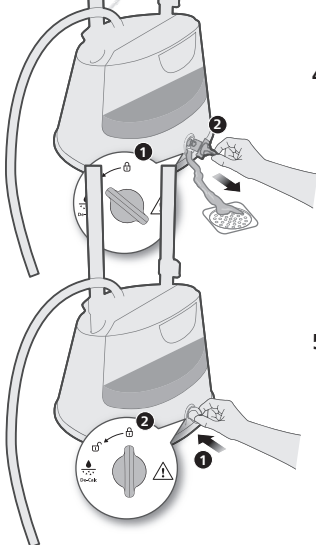

- 4 Drehen Sie den De-Calc-Verschluss in die Entriegelungsposition und entfernen Sie den De-Calc-Verschluss. Lassen Sie das Wasser ablaufen.

- 5 Setzen Sie den De-Calc-Verschluss ein und drehen Sie ihn in die Verriegelungsposition.

Reinigen und Aufbewahren der Stand-Dampfweiche

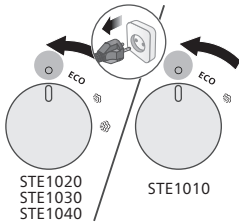

- 1 Stellen Sie sicher, dass sich der Dampfregler in der Position „AUS“ befindet und das Gerät vom Stromnetz getrennt ist.

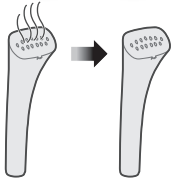

- 2 Vergewissern Sie sich, dass das Bügeleisen vollständig abgekühlt ist (> 1 Stunde).

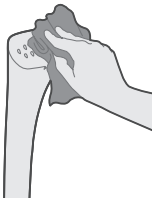

- 3 Reinigen Sie die Dampfplatte mit einem feuchten Tuch.

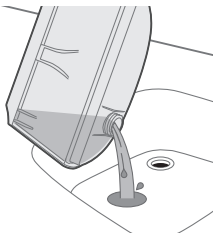

- 4 Leeren Sie den Wassertank vollständig.

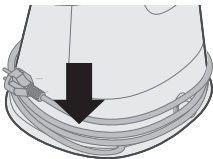

- 5 Wickeln Sie das Netzkabel um die Basis.

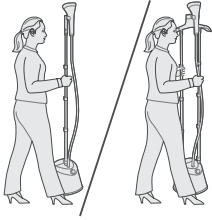

- 6 Sie können die Stand-Dampfeinheit an der Stange tragen.

Fehlerbehebung

In diesem Kapitel sind die häufigsten Probleme aufgeführt, die beim Gebrauch Ihres Geräts auftreten können. Sollten Sie ein Problem mithilfe der nachstehenden Informationen nicht beheben können, besuchen Sie unsere Website unter www.philips.com/support, auf der Sie eine Liste mit häufig gestellten Fragen finden, oder wenden Sie sich an das Service-Center in Ihrem Land.

Problem	Mögliche Ursache	Lösung
Das Gerät erzeugt keinen oder ungleichmäßigen Dampf.	Die Dampfeinheit heizt nicht ausreichend auf.	Lassen Sie das Gerät etwa 45 Sekunden aufwärmen (STE1010/75: etwa 2 Minuten).
	Dampf hat sich im Schlauch kondensiert.	Heben Sie den Kopf der Dampfeinheit an, sodass der Schlauch vertikal verläuft. So kann eventuelles Kondenswasser zurückfließen.
	Niedriger Wasserstand im Behälter, oder der Behälter wurde nicht richtig eingesetzt.	Füllen Sie den Wasserbehälter wieder auf, und setzen Sie ihn richtig ein.
	Es hat sich zu viel Kalk im Gerät abgelagert.	Führen Sie den De-Calc-Vorgang durch. Siehe Abschnitt „Calc-Clean“.
Vom Kopf der Dampfeinheit tropft Wasser bzw. das Gerät erzeugt einen krächzenden Ton.	Sie haben den Kopf der Dampfeinheit und/oder den Dampfzufuhrschlauch längere Zeit in horizontaler Position belassen.	Heben Sie den Kopf der Dampfeinheit an, sodass der Schlauch vertikal verläuft. So kann eventuelles Kondenswasser zurückfließen.
	Wenn der Schlauch eine U-Form bildet, kann vorhandenes Kondenswasser im Schlauch nicht zurück in den Wasserbehälter fließen.	Heben Sie den Kopf der Dampfeinheit an, sodass der Schlauch vertikal verläuft. So kann eventuelles Kondenswasser zurückfließen.

Eine übermäßige Menge Wasser tropft aus dem Kopf der Dampfeinheit, wenn das Gerät aufgeheizt wird.

Das Wasser im Gerät ist verschmutzt oder wurde für längere Zeit im Gerät gelassen.

Führen Sie den De-Calc-Vorgang durch. Weitere Informationen finden Sie im Abschnitt „Calc-Clean“.

Wasser tritt aus der Basis der Dampfeinheit aus.

Sie haben den Verschluss des Wasserbehälters oder den De-Calc-Verschluss nicht ordnungsgemäß verschlossen. Der Wasserbehälter ist nicht ordnungsgemäß eingesetzt.

Schließen Sie den Verschluss des Wasserbehälters oder den De-Calc-Verschluss ordnungsgemäß. Setzen Sie den Behälter ordnungsgemäß ein.

Tutvustus

Õnnitleme ostu puhul ja tervitame Philipsi poolt! Philipsi pakutava tootetoote eeliste täielikuks kasutamiseks registreerige oma toode veebilehel www.philips.com/welcome. Enne seadme kasutamist lugege hoolikalt käesolevat kasutusjuhendit, olulist teabelehte ja kiirkasutusjuhendit. Hoidke see edaspidiseks alles.

Toote ülevaade

STE1020, STE1030, STE1040

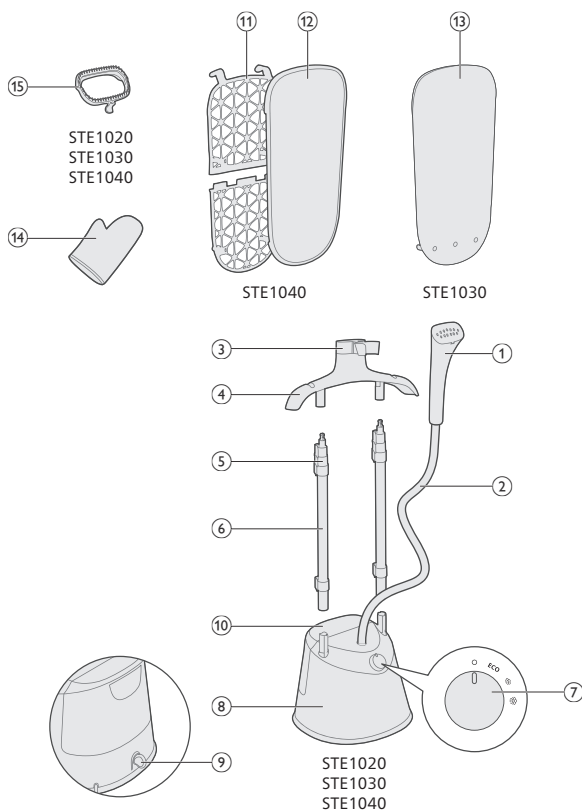

STE1010

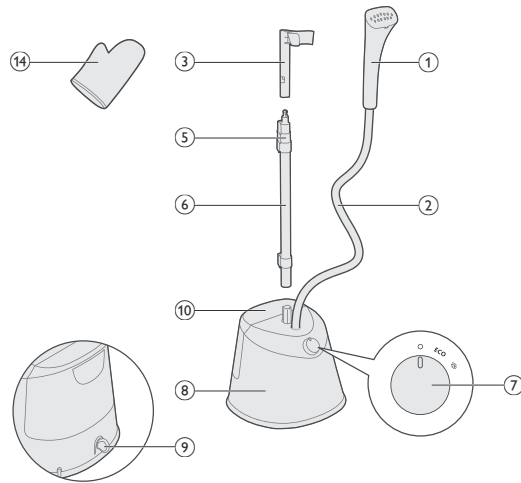

- 1 Auruti otsak
- 2 Auruvoolik
- 3 Auruti dokk
- 4 Riidepuu (STE1020, STE1030, STE1040)
- 5 Posti lukustusklamber
- 6 Vars
- 7 Auruvalits
- 8 Alus
- 9 Katlakivi eemaldamise nupp
- 10 Veepaak
- 11 Laud (STE1040)
- 12 Kate (STE1040)
- 13 Matt (STE1030)
- 14 Kinnas
- 15 Hari (STE1020, STE1030, STE1040)

Kasutamiseks valmistumine

Kasutatava vee tüüp

Seadmes võib kasutada kraanivett. Kui elate kareda veega piirkonnas, soovime teil segada võrdses koguses kraanivett destilleeritud või demineraliseeritud veega. See hoiab ära katlakivi kiire moodustumise ja pikendab seadme tööiga.

Märkus: ärge kasutage veepaagis parfüümi, trummelkuivatist pärinevat vett, äädikat, tärklisi, katlakivieemaldusvahendit, triikimist hõlbustavaid vahendeid, keemiliselt katlakivist puhastatud vett ega muid kemikaale, kuna need võivad tekitada veepritsmeid, pruune plekke või seadet kahjustada.

Hoiatused

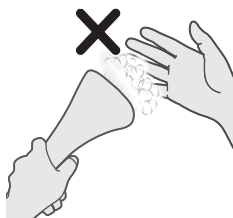

1 Ärge asetage ühtegi nahaosa otsekontakti auruga.



2 Ärge suunake auruplaati teiste inimeste poole.

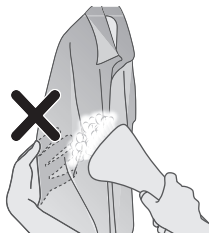

3 Ärge hoidke oma rõivast viisil, mis on otseses kontaktis auruga.

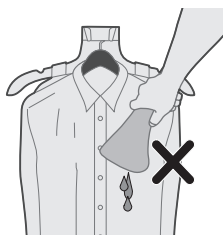

4 Ärge kasutage auruti otsakut suunaga allapoole.

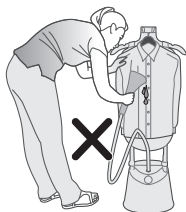

5 Ärge painutage voolikut riideseme aurutamiseks.

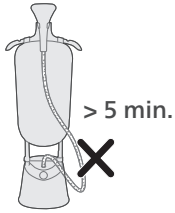

6 Ärge jätke seisvat aurutit järelevalveta rohkem kui 5 minutiks.

Seadme seadistamine

STE1010

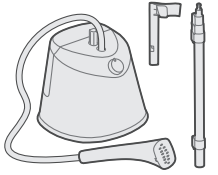

1 Pange tähele, millised osad on teie ostetud seadme jaoks saadaval.

STE1020, STE1030
STE1040



STE1010

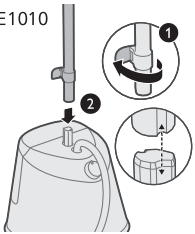

2 Avage alumised posti lukustusklambrid ja asetage post alusele. Veenduge, et varda(varraste) ja alusvarda(varraste) profiilid on joondatud.

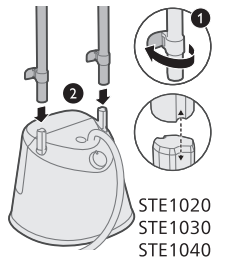

STE1020
STE1030
STE1040

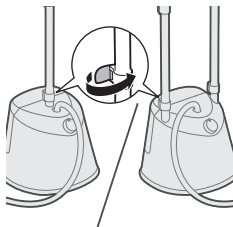

3 Lukustage alumine posti lukustusklamber.

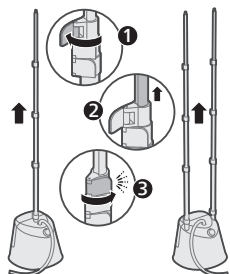

4 Avage ülejäänud posti lukustusklambrid, pikendage posti(d) ülespoole ja lukustage.

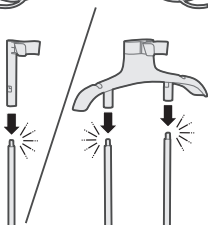

5 Sisestage auruti dokk posti(de)le, kuni see lukustub (kostub klõps).

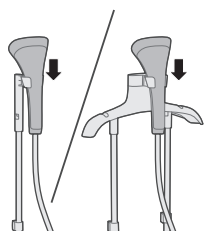

6 Asetage auruti otsak auruti dokile.

Laua valmispanek

1 Pange tähele, millised osad on teie ostetud seadme jaoks saadaval.

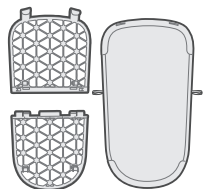

120 Eesti

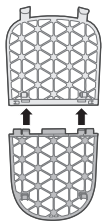

2 Joondage ja sisestage klambrid, kuni need oma kohale lukustuvad (kostub klõps).

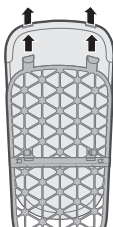

3 Joondage ja sisestage triikraua kate läbi laua konksude.

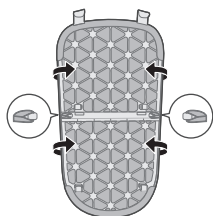

4 Kinnitage laua katterihmad laua taga asuvate konksude külge

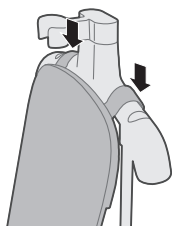

5 Asetage laud riidepuule.

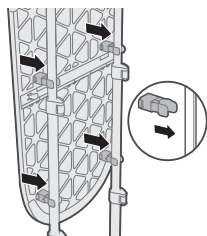

6 Kinnitage laud postide külge, kuni see oma kohale lukustub (kostub klõps).

7 Te võite oma riideid riidepuuga liigutada.

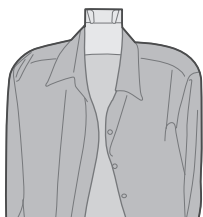
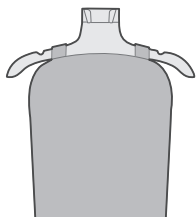

8 Võite kasutada oma riidepuud ja asetada see auruti dokile.

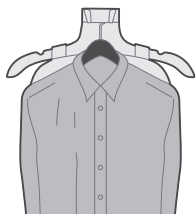

Mati seadistamine

1 Sisestage keskmine rihm läbi auruti doki.

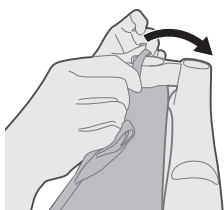

2 Kinnitage kolm rihma konsul riidepuu tagaküljel.

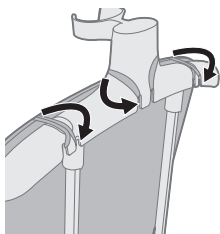

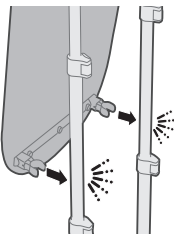

3 Kinnitage matt posti(de)le, kuni see lukustub (kostub klõps).

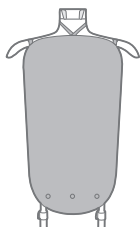

4 Te võite oma riideid riidepuuga liigutada.



5 Võite kasutada oma riidepuud ja asetada see auruti dokile.

Harja sisestamine

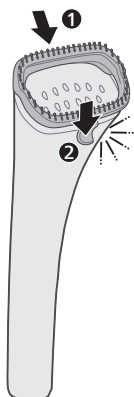

1 Joondage rada mööda auruti otsaku ülemist osa ja lükake alumine otsak paika (kostub klõps).

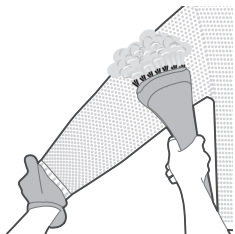

2 Võite kanda kinnast ja aurutada oma riideid harjaotsikuga.

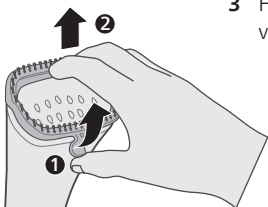

3 Harja kinnituse eemaldamiseks haarake ja tõmmake auruti otsak põhjast välja.

Veepaagi täitmine

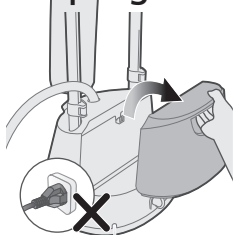

1 Ärge ühendage seadet vooluvõrku. Võtke veepaak alusest välja.

2 Keerake veepaak nii, et veepaagi kork oleks ülespoole suunatud.

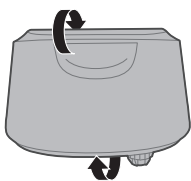

3 Eemaldamiseks keerake veepaagi kork lahti vastupäeva.

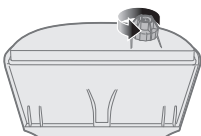

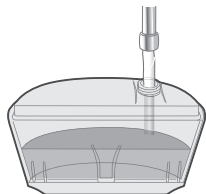

4 Täitke veepaak.

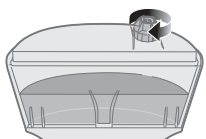

5 Keerake veepaagi kork pingutamiseks kellaosuti suunas.

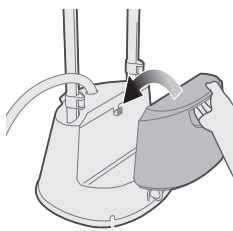

6 Joondage konksuga, et veepaak tagasi alusele asetada.

Auruseadete muutmine

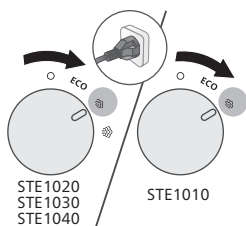

1 Veenduge, et seade oleks vooluvõrku ühendatud. Keerake auruvälits soovitud auruseadele.

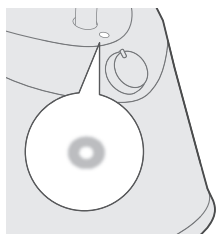

2 Märkutuli hakkab püsivalt põlema, näidates, et alusega auruti on SISSE lülitatud.

*STE1010/75: ~2 min

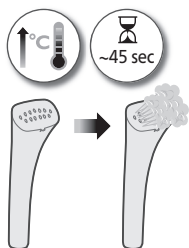

- 3 Oodake 45 sekundit, kuni alusega auruti kuumeneb ja väljutab auru (STE1010/75: umbes kaks minutit).

Triikimisnõuanded

- 1 Võite kasutada oma riidepuud ja asetada see auruti dokile.

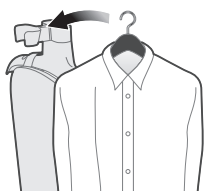

- 2 Liigutage auruti otsakut kraega paralleelses suunas.

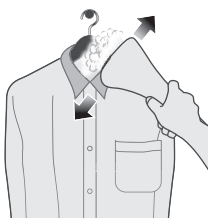

- 3 Liigutage auruti otsakut hargiga horisontaalsuunas.

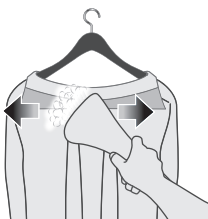

- 4 Venitage riiet. Liigutage auruti otsakut keha esiküljel allapoole.

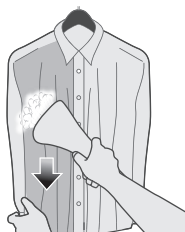



5 Liigutage auruti otsakut tasku suunas ülespoole.



6 Venitage riiet. Liigutage auruti otsakut keha tagaküljel allapoole.

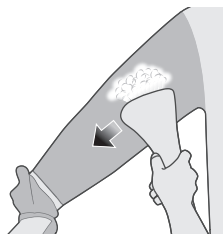

7 Venitage riiet. Liigutage auruti otsakut varrukaga paralleelselt.

Puhastamine ja korrashoid

Katlakivi koguja

Teie seade on disainitud katlakivi koguja süsteemiga. Soovitav on teha katlakivi puhastust üks kord kuus või rohkem. See aitab säilitada tugevat aurutamisvõimsust ning vältida aja jooksul mustuse tallale kogunemist ja plekke.

Nõuanne: Calc Collectori funktsiooni saab kasutada igal ajal. Kui elate kohas, kus vesi on kare, kasutage funktsiooni sagedamini.

Pärast katlakivi eemaldamist

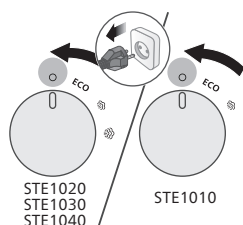

1 Veenduge, et auruvalits on OFF-asendis ja seade on lahti ühendatud.



2 Veenduge, et triikraud on täielikult jahtunud (> 1 tund).

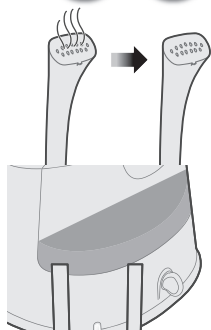

3 Asetage auruti äravoolu lähedusse.

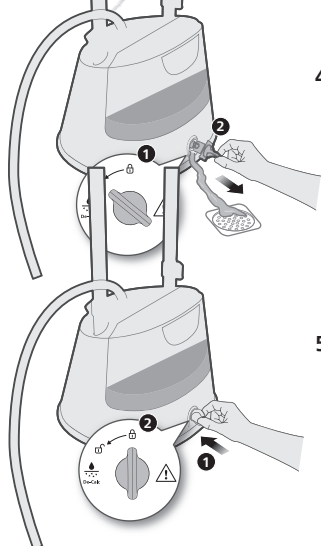

4 Keerake katlakivi eemaldamise nupp avamisasendisse ja eemaldage katlakivi eemaldamise nupp. Laske veel välja voolata.

5 Sisestage ja keerake katlakivi eemaldamise nupp lukustusasendisse.

Alusega auruti puhastamine ja hoiustamine

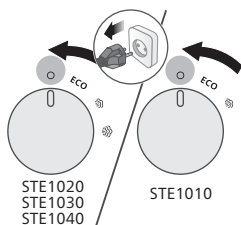

1 Veenduge, et auruvälits on OFF-asendis ja seade on lahti ühendatud.



2 Veenduge, et triikraud on täielikult jahtunud (> 1 tund).

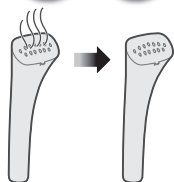

3 Puhastage auru kohta niiske lapiga.

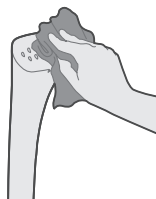

4 Tühjendage veepaak täielikult.

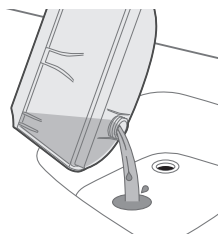

5 Kerige toitejuhe ümber aluse.

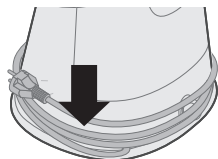

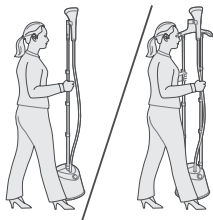

6 Võite alusega aurutit kanda postist.

Veaotsing

See peatükk annab ülevaate üldistest probleemidest, mis võivad selle seadmega seoses tekkida. Kui te ei suuda alljärgneva teabe abil ise probleemi lahendada, külastage veebilehte www.philips.com/support, kus on loetelu korduma kippuvatest küsimustest, või võtke ühendust oma riigi klienditeeninduskeskusega.

Probleem	Võimalik põhjus	Lahendus
Seade ei tekitab auru või on aur ebaregulaarne.	Auruti ei ole piisavalt kuumenenud.	Laske seadmel umbes 45 sekundit kuumeneda (STE1010/75: umbes kaks minutit).
	Aur on voolikusse kondenseerunud.	Tõstke aurutit, et voolik vertikaalsuunas välja sirutuks. Nii saab kondensvesi tagasi voolata.
	Madal veetase paagis või paak ei ole korralikult sisestatud.	Täitke veepaak uuesti ja sisestage see õigesti.
Auruti otsakust tilgub vett või tekitab seade krooksuvat heli.	Seadmesse on kogunenud liiga palju katlakivi.	Eemaldage katlakivi. Vaadake lõiku katlakivi eemaldamine.
	Olete auruti otsaku ja/või auruvooliku pikaks ajaks horisontaalasendisse jätnud.	Tõstke aurutit, et voolik vertikaalsuunas välja sirutuks. Nii saab kondensvesi tagasi voolata.
	Kui voolik paikneb U-kujuliselt, ei saa voolikusse kogunev kondensvesi tagasi veepaaki voolata.	Tõstke aurutit, et voolik vertikaalsuunas välja sirutuks. Nii saab kondensvesi tagasi voolata.
Seadme soojenemise ajal tilgub auruti otsakust liiga palju vett.	Seadmes olev vesi on must või liiga kauaks seadmesse jäetud.	Eemaldage katlakivi. Vaadake lõiku „katlakivi eemaldamine“.
Auruti alusest lekib vett.	Te ei ole veepaagi korki või katlakivi eemaldamise nuppu korralikult sulgenud. Veepaak pole korralikult paigaldatud.	Sulgege veepaagi kork või katlakivi eemaldamise nupp korralikult. Sisestage veepaak õigesti.

Introducción

Le damos la enhorabuena por su adquisición y la bienvenida a Philips. Para poder beneficiarse por completo de la asistencia que ofrece Philips, registre el producto en www.philips.com/welcome. Lea con atención este manual de usuario, el folleto de información importante y la guía de inicio rápido antes de utilizar el aparato. Consérvelos por si necesitara consultarlos en el futuro.

Descripción del producto

STE1020, STE1030, STE1040

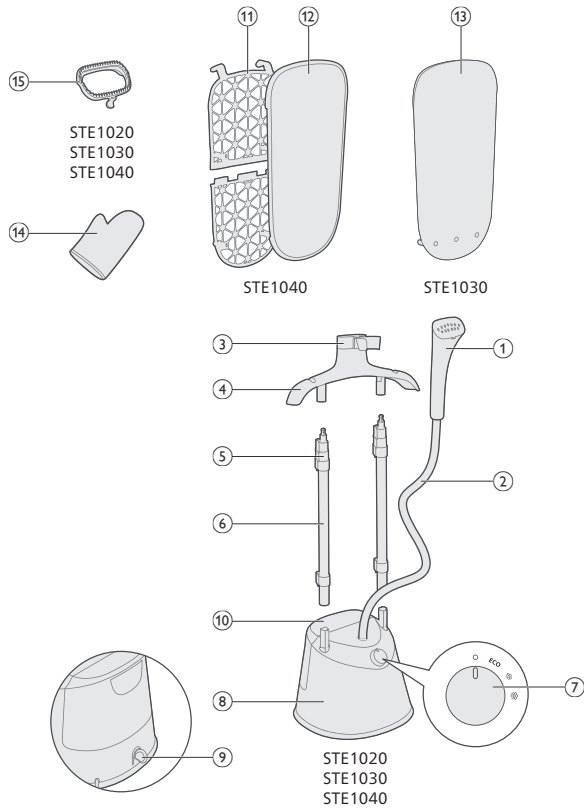

STE1010

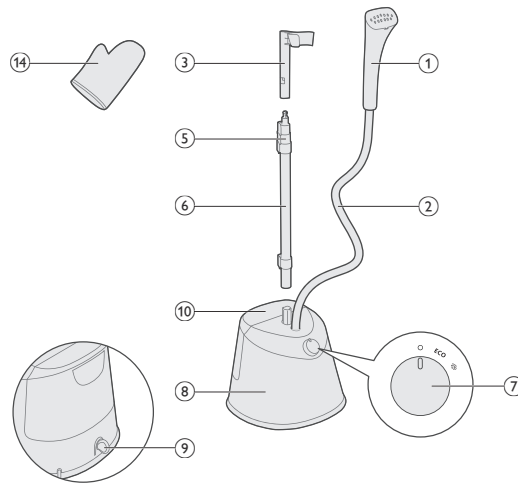

- 1 Cabezal del vaporizador
- 2 Manguera de vapor
- 3 Base del vaporizador
- 4 Percha (STE1020, STE1030, STE1040)
- 5 Pinza de bloqueo del poste
- 6 Poste
- 7 Control del vapor
- 8 Base
- 9 Rueda De-calc
- 10 Depósito de agua
- 11 Tabla (STE1040)
- 12 Cubierta (STE1040)
- 13 Alfombra (STE1030)
- 14 Guante
- 15 Cepillo (STE1020, STE1030, STE1040)

Preparación para su uso

Tipo de agua que puede utilizar

El aparato es adecuado para su uso con agua del grifo. Sin embargo, si vive en una zona con agua dura, le recomendamos que mezcle agua del grifo con agua destilada o desmineralizada a partes iguales. Esto evitará que se acumule cal rápidamente y prolongará la vida útil del aparato.

No añadas perfume, agua de la secadora, vinagre, almidón, productos desincrustantes ni otros productos químicos, ya que pueden provocar fugas de agua, manchas marrones o daños en el aparato.

Advertencias

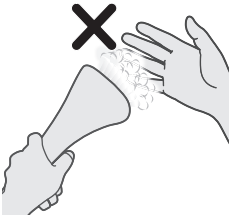

1 No permita que ninguna parte de su piel entre en contacto directo con el vapor.



2 No apunte la placa de vapor hacia otras personas.

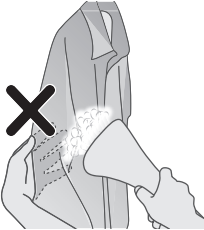

3 No sostenga la prenda de manera que entre en contacto directo con el vapor.

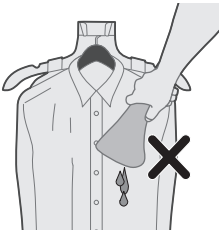

4 No utilice el cabezal del vaporizador boca abajo.

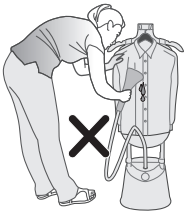

5 No doble la manguera para vaporizar la prenda.

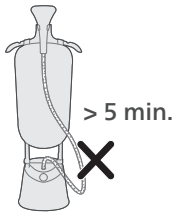

- 6 No deje el vaporizador vertical sin supervisión durante más de 5 minutos.

Montaje del aparato

STE1010

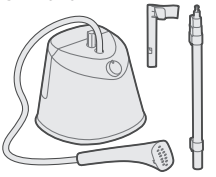

- 1 Tome nota de las piezas disponibles para su aparato.

STE1020, STE1030
STE1040



STE1010

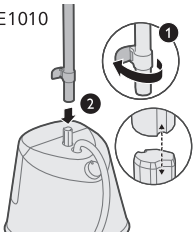

- 2 Desbloquee las pinzas de bloqueo del poste inferior e inserte el poste o postes en la base. Asegúrese de que los perfiles de los postes y los montantes de la base estén alineados.

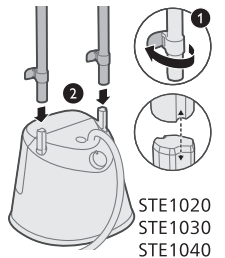

STE1020
STE1030
STE1040

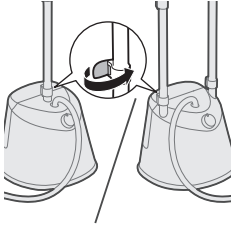

3 Bloquee las pinzas de bloqueo inferiores del poste.

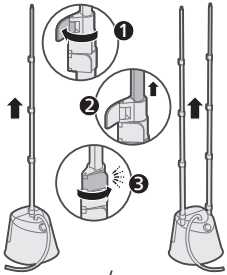

4 Desbloquee las demás pinzas de bloqueo del poste, extienda completamente los postes hacia arriba y bloquéelos.

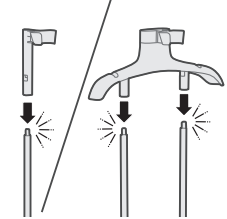

5 Inserte la base del vaporizador en los postes hasta que encaje en su lugar con un "clic".

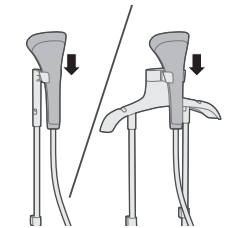

6 Coloque el cabezal del vaporizador en la base del vaporizador.

Montaje de la tabla

1 Tome nota de las piezas disponibles para su aparato.

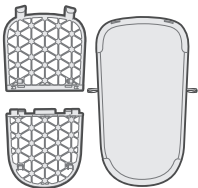

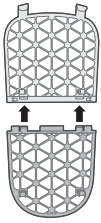

2 Alinee e inserte las pinzas de la tabla hasta que encajen en su lugar con un "clic".

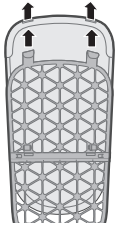

3 Alinee e inserte la cubierta de la tabla a través de los ganchos de la tabla.

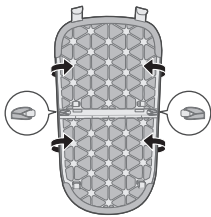

4 Cuelgue las correas de la cubierta de la tabla de los ganchos de la parte posterior de la tabla.

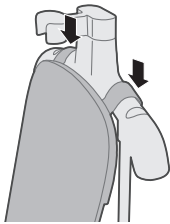

5 Coloque la tabla en la percha.

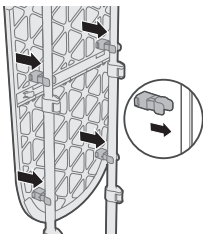

6 Fije la tabla en los postes hasta que se bloquee en su lugar con un "clic".

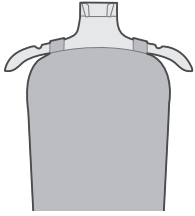

7 Puede colgar la ropa usando la percha.

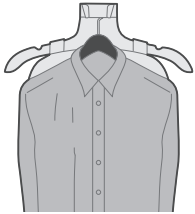
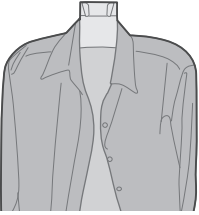

8 Puede utilizar su propia percha y colocarla en la base de la vaporera.

Ajuste de la alfombrilla

1 Inserte la correa central por encima de la base del vaporizador.

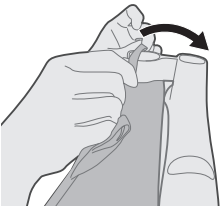

2 Asegure las 3 correas en el gancho posterior de la percha.

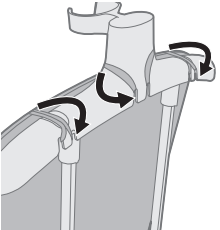

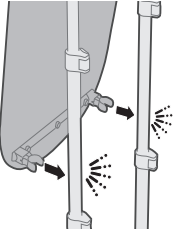

3 Fije la alfombrilla en los postes hasta que se bloquee en su lugar con un "clic".

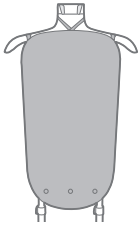

4 Puede colgar la ropa usando la percha.



5 Puede utilizar su propia percha y colocarla en la base de la vaporera.

Inserción del cepillo

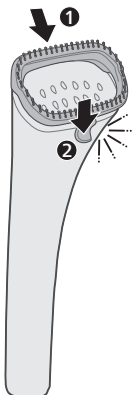

1 Alinee el reborde a lo largo de la parte superior del cabezal del vaporizador y ajuste el pestillo inferior hasta oír un "clic".

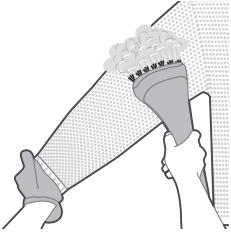

2 Puede ponerse el guante para vaporizar su ropa con el cepillo.

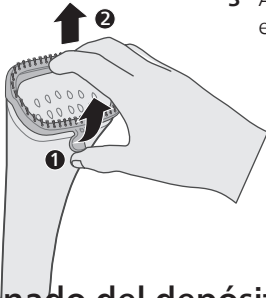

3 Agarre y tire del pestillo inferior del cabezal del vaporizador para desacoplar el cepillo.

Llenado del depósito de agua

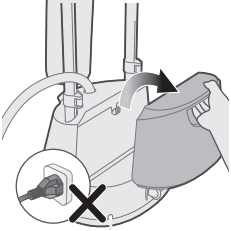

1 No enchufe el aparato. Extraiga el depósito de agua de la base.

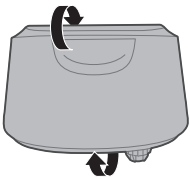

2 Gire el depósito de agua con el tapón orientado hacia arriba.

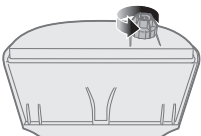

3 Desenrosque el tapón del depósito de agua en sentido antihorario para retirarlo.

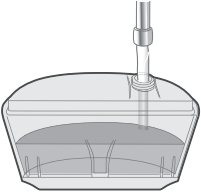

4 Llene el depósito de agua.

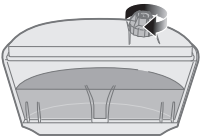

5 Enrosque el tapón del depósito de agua en sentido horario para apretarlo.

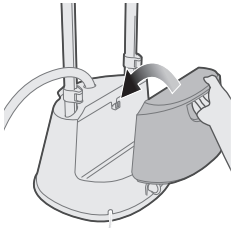

6 Alinee el depósito de agua con el gancho para volver a colocarlo en la base.

Cambio de las posiciones de vapor

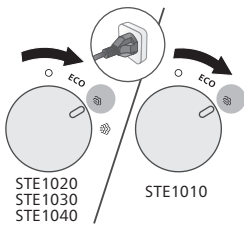

1 Asegúrese de que el aparato esté enchufado. Gire el control del vapor hasta la posición deseada.

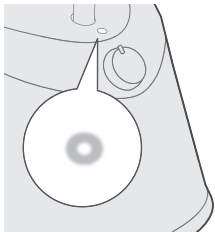

2 La luz se encenderá fija para indicar que el vaporizador vertical está encendido.

*STE1010/75: ~2 min

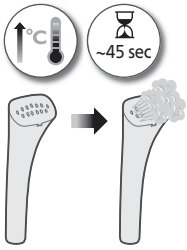

- 3 Espere unos 45 segundos hasta que el vaporizador vertical se caliente y emita vapor (unos 2 minutos con el STE1010/75).

Consejos de planchado

- 1 Puede utilizar su propia percha y colocarla en la base de la vaporera.

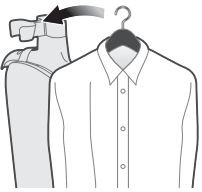

- 2 Mueva el cabezal del vaporizador en dirección paralela al cuello.

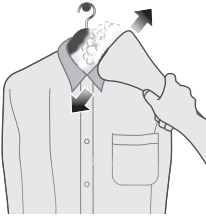

- 3 Mueva el cabezal del vaporizador en dirección horizontal sobre el canesú.



- 4 Estire la prenda. Mueva el cabezal del vaporizador hacia abajo a lo largo de la parte frontal de la prenda.

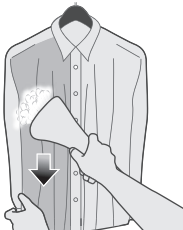



5 Mueva el cabezal del vaporizador hacia arriba sobre el bolsillo.

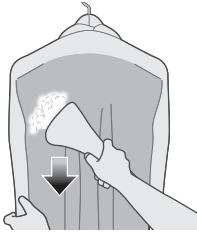

6 Estire la prenda. Mueva el cabezal del vaporizador hacia abajo a lo largo de la parte posterior de la prenda.

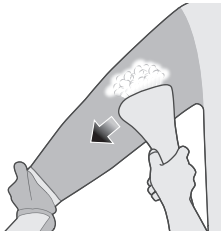

7 Estire la prenda. Mueva el cabezal del vaporizador en dirección paralela a las mangas.

Limpieza y mantenimiento

Colector de cal

El aparato incorpora un sistema colector de cal. Se recomienda descalcificar una vez al mes o más. Esto ayuda a mantener un rendimiento de vapor fuerte y evita que salgan manchas y suciedad de la suela con el tiempo.

Consejo: El sistema colector de cal se puede utilizar en cualquier momento. Si vive en una zona con agua dura, es recomendable que utilice la función más a menudo.

Proceso Calc-Clean

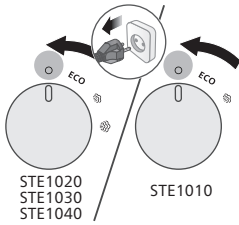

- 1 Asegúrese de que el control de vapor esté en la posición de apagado y el aparato desenchufado.

- 2 Asegúrese de que la plancha se haya enfriado completamente (1 hora o más).



- 3 Coloque la vaporera cerca de un desagüe.

- 4 Gire la rueda De-calc a la posición de desbloqueo y retírela. Deje desaguar.

- 5 Inserte y gire la rueda De-calc a la posición de bloqueo.

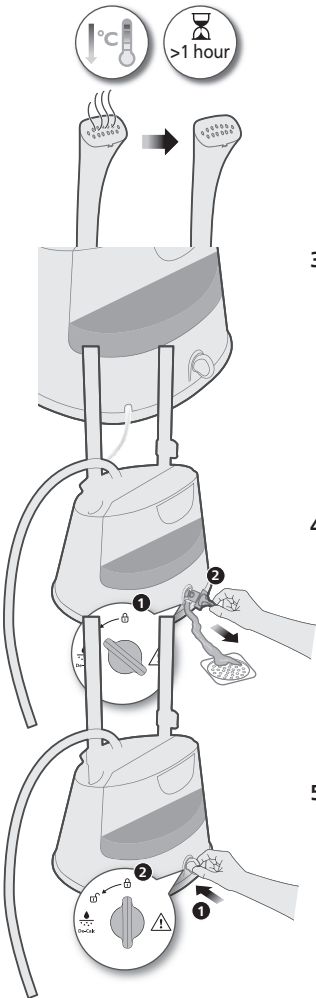

Limpieza y almacenamiento del vaporizador vertical

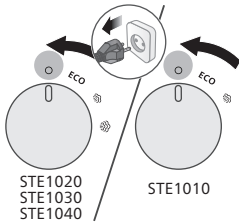

- 1 Asegúrese de que el control de vapor esté en la posición de apagado y el aparato desenchufado.

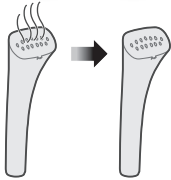

- 2 Asegúrese de que la plancha se haya enfriado completamente (1 hora o más).

- 3 Frote la placa de vapor con un paño húmedo.

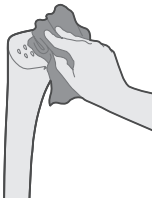

- 4 Vacíe el depósito de agua completamente.

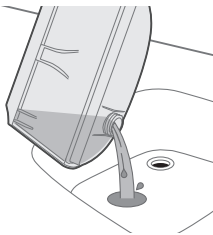

- 5 Enrolle el cable de alimentación alrededor de la base.

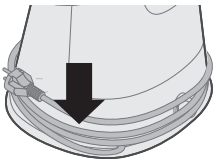

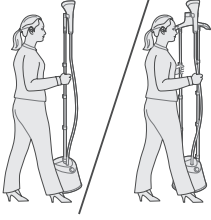

6 Puede transportar el vaporizador vertical sujetándolo por el poste.

Resolución de problemas

Este capítulo resume los problemas más comunes que podría encontrarse con el aparato. Si no puede resolver el problema con la siguiente información, visite www.philips.com/support para consultar una lista de preguntas más frecuentes, o póngase en contacto con el servicio de atención al cliente en su país.

Problema	Posible causa	Solución
El aparato no genera vapor o el flujo de vapor es irregular.	El vaporizador no se ha calentado lo suficiente.	Deje que el aparato se caliente durante unos 45 segundos (unos 2 minutos con el STE1010/75).
	El vapor se ha condensado en el tubo.	Levante el cabezal del vaporizador para que el tubo quede estirado verticalmente. De esta forma se elimina la condensación del vapor.
	Hay un nivel de agua bajo en el depósito o este no está insertado correctamente.	Vuelva a llenar el depósito de agua y colóquelo correctamente.
	Se ha acumulado demasiada cal en el aparato.	Realice el proceso de eliminación de los depósitos de cal. Consulte la sección Calc-Clean.
La boca del vaporizador desprende gotas de agua o el aparato produce un sonido áspero.	Ha dejado el cabezal del vaporizador o el tubo de distribución del vapor en posición horizontal durante un período prolongado.	Levante el cabezal del vaporizador para que el tubo quede estirado verticalmente. De esta forma se elimina la condensación del vapor.
	Cuando la disposición del tubo presenta forma de U, la condensación en el tubo impide la vuelta del vapor al depósito de agua.	Levante el cabezal del vaporizador para que el tubo quede estirado verticalmente. De esta forma se elimina la condensación del vapor.

Mientras el aparato se calienta, sale demasiada agua del cabezal del vaporizador.

El agua del aparato está sucia o lleva demasiado tiempo dentro del aparato.

Realice el proceso de eliminación de los depósitos de cal. Consulte la sección Calc-Clean.

La base del vaporizador presenta una fuga de agua.

No ha cerrado el tapón del depósito de agua o enroscado la rueda Easy De-Calc correctamente. El depósito de agua no se ha colocado correctamente.

Cierre el tapón del depósito de agua o enrosque la rueda Easy De-Calc correctamente. Inserte el depósito correctamente.

México:

Importado por: Importadora Amazon México S. de R.L. de C.V. Boulevard Manuel Ávila Camacho N.º 261 Piso 5, Colonia Polanco I Sección, Miguel Hidalgo, Ciudad de México, C.P. 11510, México. CIC ☎ 0800 837 0900

Colombia:

Importado y comercializado por: Continente SAS. Dirección: CL 69 VIA 40 301, Atlántico, Barranquilla, Colombia. Teléfono: 6053851332 Colombia CIC ☎ 01 8000 423 558

Panamá:

Panamá CIC ☎ (507) 800 203 5534

Introduction

Félicitations pour votre achat et bienvenue chez Philips ! Pour profiter pleinement de l'assistance offerte par Philips, enregistrez votre produit à l'adresse suivante : www.philips.com/welcome. Lisez attentivement ce mode d'emploi, la brochure « Informations importantes » et le guide de démarrage rapide avant d'utiliser l'appareil. Conservez-les pour une consultation ultérieure.

Présentation du produit

STE1020, STE1030, STE1040

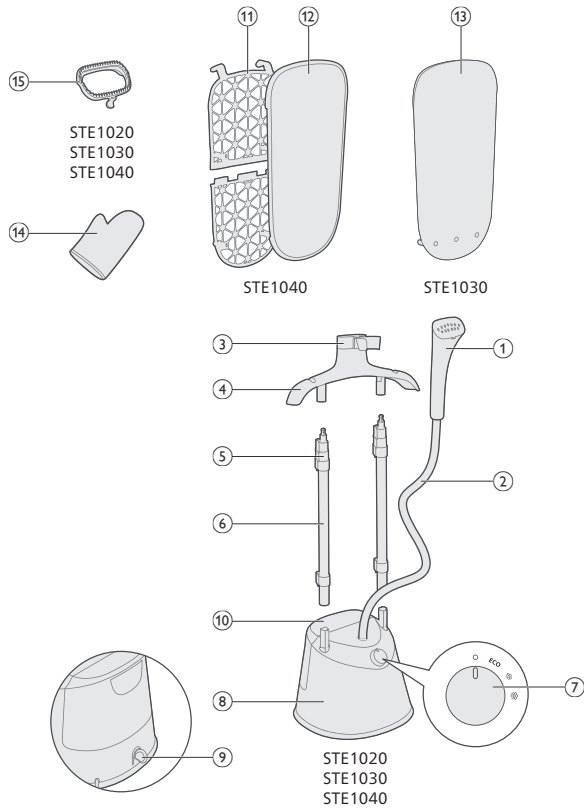

STE1010

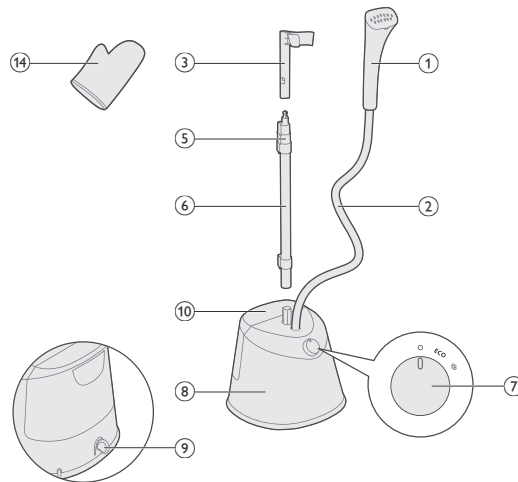

- 1 Tête du défroisseur
- 2 Cordon d'arrivée de la vapeur
- 3 Support du défroisseur
- 4 Cintre (STE1020, STE1030, STE1040)
- 5 Clip de sécurité du mât
- 6 Mât
- 7 Sélecteur de vapeur
- 8 Base
- 9 Bouton de détartrage
- 10 Réservoir d'eau
- 11 Planche (STE1040)
- 12 Housse (STE1040)
- 13 Tapis (STE1030)
- 14 Gant
- 15 Brosse (STE1020, STE1030, STE1040)

Avant utilisation

Type d'eau à utiliser

Cet appareil accepte l'eau du robinet. Cependant, si vous vivez dans une région où l'eau est dure, nous vous recommandons de mélanger une quantité égale d'eau du robinet et d'eau distillée ou déminéralisée. Cela permettra d'éviter l'accumulation rapide de calcaire et prolongera la durée de vie de l'appareil.

N'utilisez pas de parfum, d'eau provenant d'un sèche-linge, de vinaigre, d'amidon, de détartrants, de produits d'aide au repassage ou d'autres agents chimiques car ils peuvent entraîner des projections d'eau, des taches marron ou endommager votre appareil.

Avertissements

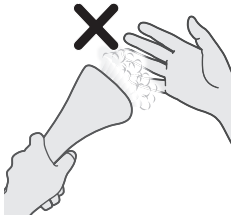

1 Ne placez aucune partie de la peau en contact direct avec la vapeur.



2 Ne dirigez pas la plaque vapeur vers d'autres personnes.



3 Ne tenez pas votre vêtement de manière à ce qu'il soit en contact direct avec la vapeur.

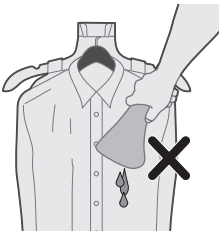

4 N'utilisez pas la tête du défroiseur en l'orientant vers le bas.

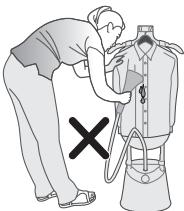

5 Ne pliez pas le cordon pour défroiser le vêtement.

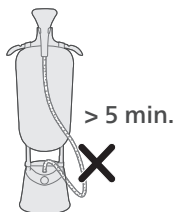

- 6 Ne laissez pas le défroisseur sur pied sans surveillance pendant plus de 5 minutes.

Installation de l'appareil

STE1010

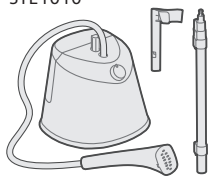

- 1 Tenez compte des pièces disponibles pour l'appareil que vous venez d'acheter.

STE1020, STE1030
STE1040



STE1010

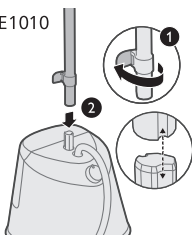

- 2 Ouvrez les clips de sécurité en bas du ou des mâts et insérez ces derniers sur la base. Assurez-vous que les profils du ou des mâts sont alignés avec le ou les montants de la base.

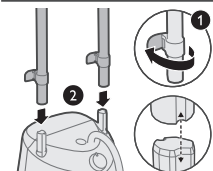

STE1020
STE1030
STE1040

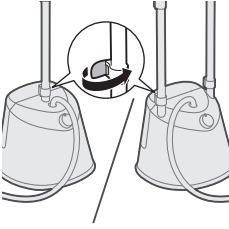

3 Fermez le ou les clips de sécurité en bas du mât ou des mâts.

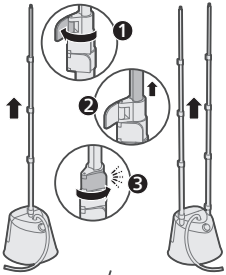

4 Ouvrez les autres clips de sécurité de mât, déployez complètement le ou les mâts vers le haut, puis refermez-les.

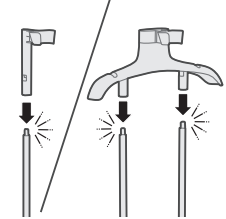

5 Insérez le support du défroisseur sur le ou les mâts jusqu'à ce qu'il s'enclenche (« clic »).

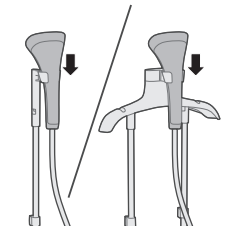

6 Placez la tête du défroisseur sur son support.

Installation de la planche

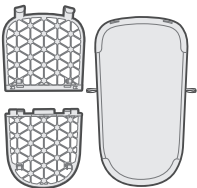

1 Tenez compte des pièces disponibles pour l'appareil que vous venez d'acheter.

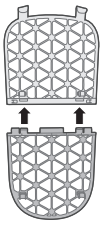

2 Alignez et insérez les clips de la planche jusqu'à ce qu'ils s'enclenchent (« clic »).

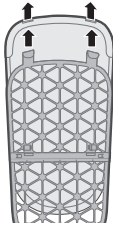

3 Alignez et insérez la housse au niveau des crochets de la planche.

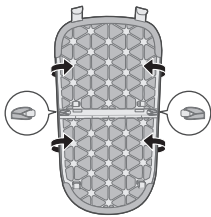

4 Accrochez les lanières de la housse aux crochets situés au dos de la planche

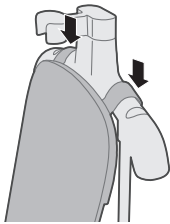

5 Placez la planche sur le cintre.

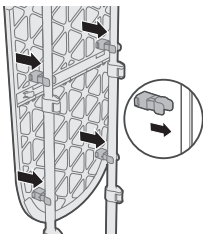

6 Fixez la planche sur les mâts jusqu'à ce qu'elle s'enclenche (« clic »).

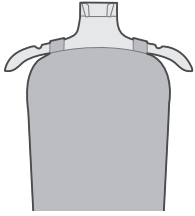

7 Vous pouvez disposer vos vêtements sur le cintre.

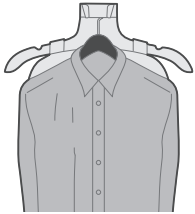
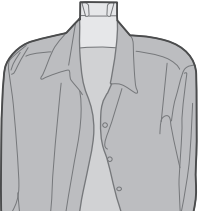

8 Vous pouvez utiliser votre propre cintre et le placer sur le support du défroisseur.

Installation du tapis

1 Insérez la lanière centrale au niveau du support du défroisseur.

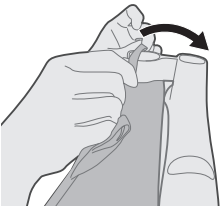

2 Fixez les 3 lanières sur les crochets à l'arrière du cintre.

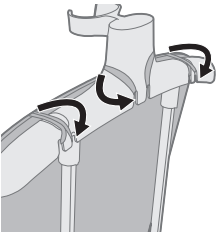

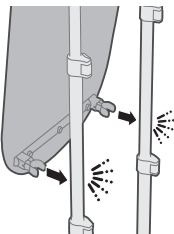

3 Fixez le tapis sur les mâts jusqu'à ce qu'il s'enclenche (« clic »).

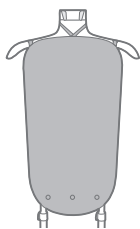

4 Vous pouvez disposer vos vêtements sur le cintre.



5 Vous pouvez utiliser votre propre cintre et le placer sur le support du défroisseur.

Insertion de la brosse

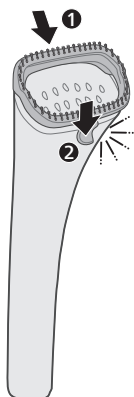

1 Aligned le rail sur la partie supérieure de la tête du défroisseur et enclenchez le loquet en dessous (« clic »).

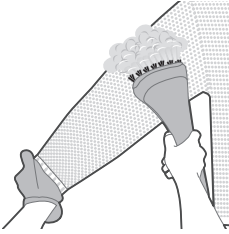

2 Vous pouvez porter le gant et défroisser vos vêtements à l'aide de la brosse.

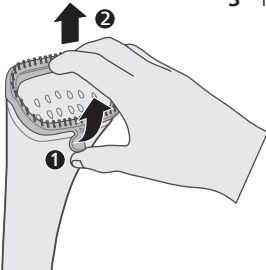

3 Tirez sur le loquet situé sous la tête du défroisseur pour retirer la brosse.

Remplissage du réservoir

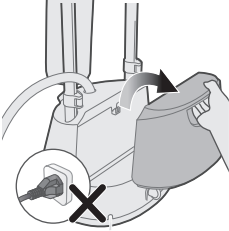

1 Ne branchez pas l'appareil. Retirez le réservoir d'eau de la base.

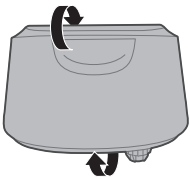

2 Retournez le réservoir d'eau en orientant le bouchon vers le haut.

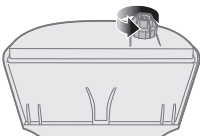

3 Retirez le bouchon du réservoir d'eau en le dévissant dans le sens inverse des aiguilles d'une montre.

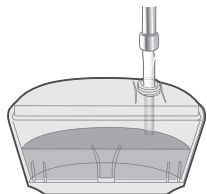

4 Remplissez le réservoir d'eau.

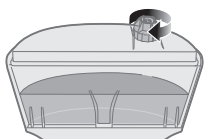

5 Revissez le bouchon du réservoir d'eau dans le sens des aiguilles d'une montre et serrez-le.

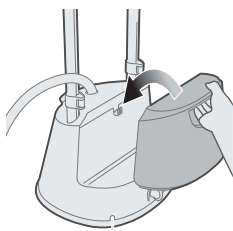

6 Alignez le réservoir d'eau avec le crochet pour le placer sur la base.

Modification des réglages de vapeur

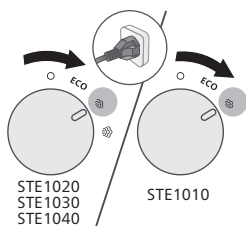

1 Assurez-vous que l'appareil est branché. Tournez le sélecteur de vapeur sur le réglage souhaité.

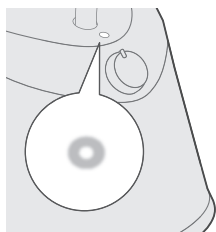

2 Le voyant s'allume en continu pour indiquer que le défroisseur sur pied est allumé.

*STE1010/75: ~2 min

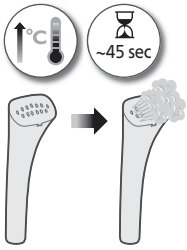

- 3 Attendez environ 45 secondes que le défroisseur sur pied chauffe et diffuse de la vapeur (STE1010/75: 2 minutes environ).

Conseils pour le repassage

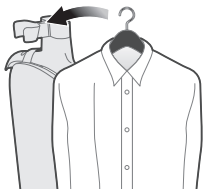

- 1 Vous pouvez utiliser votre propre cintre et le placer sur le support du défroisseur.

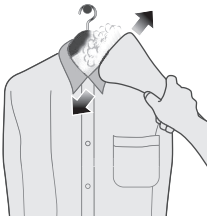

- 2 Déplacez la tête du défroisseur le long du col.

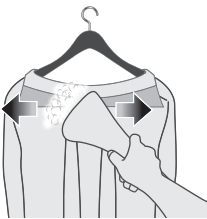

- 3 Déplacez la tête du défroisseur à l'horizontale sur l'empiècement.

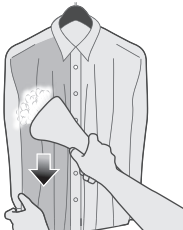

- 4 Étirez le vêtement. Déplacez la tête du défroisseur vers le bas sur l'avant du vêtement.



5 Déplacez la tête du défroisseur vers le haut sur les poches.

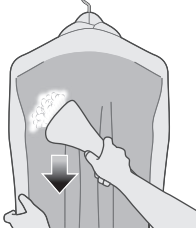

6 Étirez le vêtement. Déplacez la tête du défroisseur vers le bas sur le dos du vêtement.

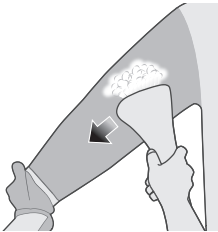

7 Étirez le vêtement. Déplacez la tête du défroisseur le long des manches.

Nettoyage et entretien

Collecteur de calcaire

Votre appareil est équipé d'un collecteur de calcaire. Il est recommandé d'effectuer un détartrage au moins une fois par mois. Cela permet de maintenir des performances élevées de vapeur et d'éviter que saletés et taches s'échappent de la semelle au fil du temps.

Conseil : Le collecteur de calcaire peut être utilisé à tout moment. Si vous habitez dans une région où l'eau est calcaire, utilisez cette fonction plus fréquemment.

Réalisation de la procédure de détartrage

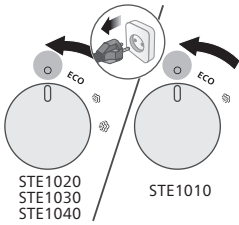

1 Assurez-vous que le sélecteur de vapeur est réglé sur la position ARRÊT et que l'appareil est débranché.



2 Assurez-vous que le fer a complètement refroidi (> 1 heure).

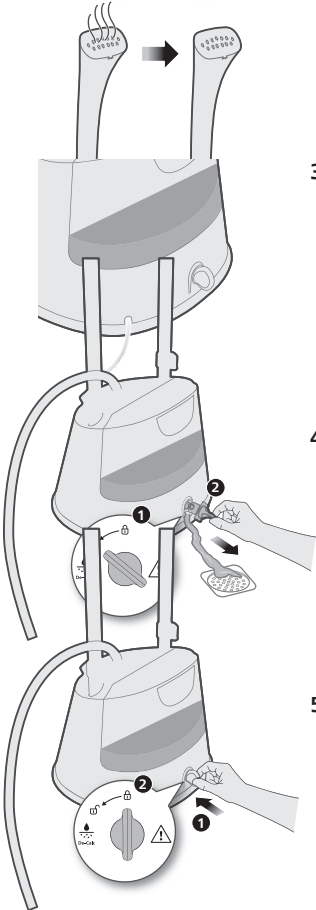

3 Placez le défroisseur près d'une canalisation.

4 Tournez le bouton de détartrage et retirez-le. Laissez l'eau s'écouler.

5 Remettez et fermez le bouton de détartrage.

Nettoyage et rangement du défroisseur sur pied

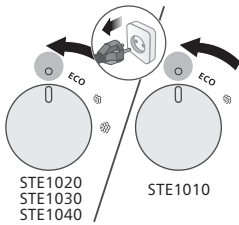

- 1 Assurez-vous que le sélecteur de vapeur est réglé sur la position ARRÊT et que l'appareil est débranché.

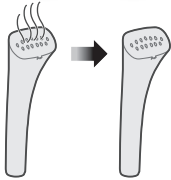

- 2 Assurez-vous que le fer a complètement refroidi (> 1 heure).

- 3 Essayez la plaque vapeur à l'aide d'un chiffon humide.

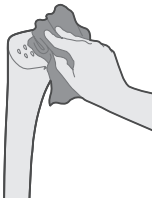

- 4 Videz entièrement le réservoir d'eau.

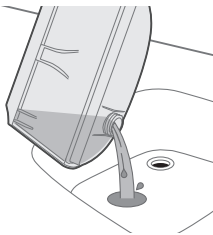

- 5 Enroulez le cordon d'alimentation autour de la base.

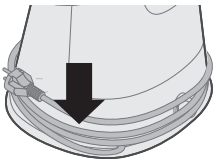

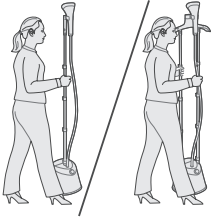

- 6 Vous pouvez porter le défroisseur sur pied en le tenant par le mât.

Dépannage

Cette rubrique présente les problèmes les plus courants que vous pouvez rencontrer avec votre appareil. Si vous ne parvenez pas à résoudre le problème à l'aide des informations ci-dessous, rendez-vous sur www.philips.com/support pour consulter les questions fréquemment posées ou contactez le Service Consommateurs de votre pays.

Problème	Cause possible	Solution
L'appareil ne produit pas de vapeur ou une vapeur irrégulière.	Le défroisseur n'a pas suffisamment chauffé.	Laissez l'appareil chauffer pendant environ 45 secondes (STE1010/75: 2 minutes environ).
	De la vapeur s'est condensée dans le cordon.	Soulevez la tête du défroisseur pour redresser le cordon verticalement. Cela permet à la condensation de s'écouler.
	Le réservoir n'a pas assez d'eau ou n'est pas inséré correctement.	Remplissez à nouveau le réservoir et insérez-le correctement.
	Un excès de calcaire s'est formé dans l'appareil.	Procédez au détartrage. Reportez-vous à la section Détartrage.
Des gouttes d'eau s'écoulent de la tête du défroisseur ou l'appareil émet un bruit rauque.	Vous avez laissé la tête du défroisseur et/ou le cordon d'arrivée de la vapeur en position horizontale pendant une longue période.	Soulevez la tête du défroisseur pour redresser le cordon verticalement. Cela permet à la condensation de s'écouler.
	Lorsque le cordon forme un U, la condensation présente dans celui-ci ne peut pas retourner dans le réservoir d'eau.	Soulevez la tête du défroisseur pour redresser le cordon verticalement. Cela permet à la condensation de s'écouler.

Une quantité excessive d'eau s'écoule de la tête du défroisseur lorsque l'appareil chauffe.

L'eau présente dans l'appareil est sale ou a stagné trop longtemps dans l'appareil.

Procédez au détartrage. Reportez-vous à la section Détartrage.

De l'eau coule de la base du défroisseur.

Vous n'avez pas fermé correctement le bouchon du réservoir ou le bouton de détartrage. Le réservoir d'eau n'a pas été inséré correctement.

Fermez correctement le bouchon du réservoir d'eau ou le bouton de détartrage. Insérez le réservoir correctement.

Uvod

Čestitamo Vam na kupnji i dobro došli u Philips! Kako biste potpuno iskoristili podršku koju nudi Philips, registrirajte svoj proizvod na www.philips.com/welcome. Prije uporabe aparata pažljivo pročitajte ovaj korisnički priručnik, letak s važnim informacijama i kratke upute. Spremite ih za buduće potrebe.

Pregled proizvoda

STE1020, STE1030, STE1040

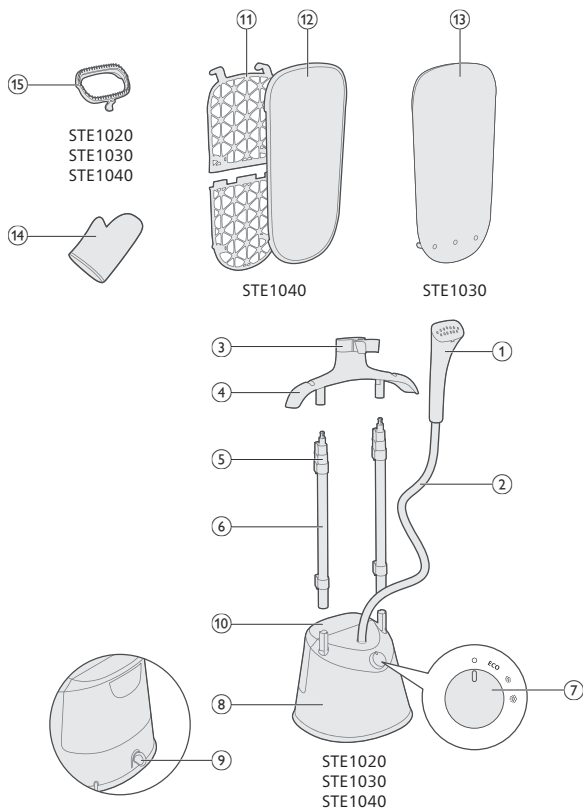

STE1010

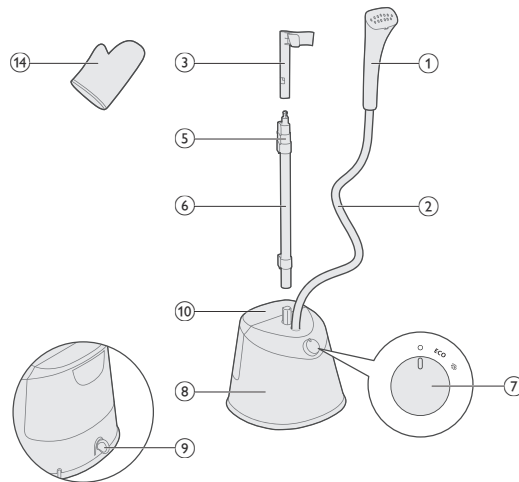

- 1 Glava steamer glačala
- 2 Crijevo za dovod pare
- 3 Baza steamer glačala
- 4 Vješalica (STE1020, STE1030, STE1040)
- 5 Kopča za fiksiranje šipke
- 6 Šipka
- 7 Regulator pare
- 8 Podnožje
- 9 Regulator De-calc
- 10 Spremnik za vodu
- 11 Daska (STE1040)
- 12 Navlaka (STE1040)
- 13 Podloga (STE1030)
- 14 Rukavica
- 15 Četka (STE1020, STE1030, STE1040)

Priprema za uporabu

Vrsta vode koju treba upotrebljavati

Aparat je prikladan za uporabu s vodom iz slavine. Međutim, ako živite u području s vrlo tvrdom vodom, preporučujemo da miješate jednaku količinu destilirane ili demineralizirane vode s vodom iz slavine. Time ćete spriječiti brzo nakupljanje kamenca te produljiti životni vijek svog aparata.

Nemojte dodavati parfem, vodu iz sušilice, ocat, izbjeljivač, sredstva protiv kamenca, sredstva za olakšavanje glačanja, vodu koja je kemijski očišćena od kamenca ili druge kemikalije jer mogu uzrokovati naglo izbacivanje vode, smeđe mrlje ili oštećenje aparata.

Upozorenja

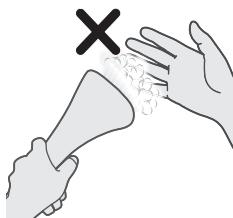

1 Nijednim dijelom kože nemojte izravno dodirivati paru.



2 Parnu ploču nemojte usmjeravati prema drugim osobama.

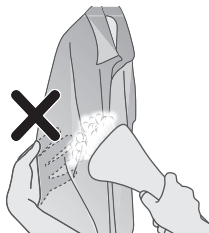

3 Odjevni predmet nemojte držati tako da dolazi u izravan kontakt s parom.

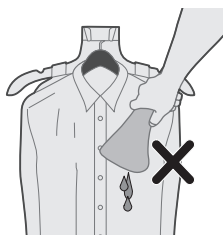

4 Glavu steamer glačala nemojte upotrebljavati u smjeru prema dolje.

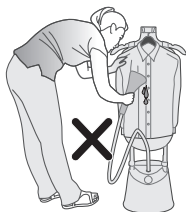

5 Nemojte savijati crijevo kako biste odjevni predmet glačali parom.

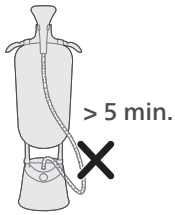

- 6 Samostojeće steamer glačalo nemojte ostavljati bez nadzora duže od 5 minuta.

Postavljanje aparata

STE1010

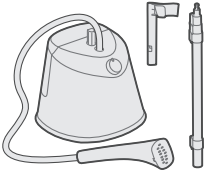

- 1 Pregledajte dijelove dostupne za aparat koji ste kupili.

STE1020, STE1030
STE1040



STE1010

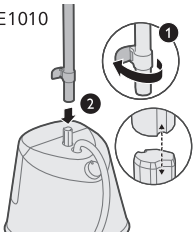

- 2 Otpustite donje kopče za fiksiranje šipke i postavite šipke na podnožje. Pazite da profili šipki budu poravnati s izbočenim držačima na podnožju.

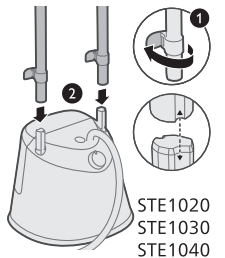

STE1020
STE1030
STE1040

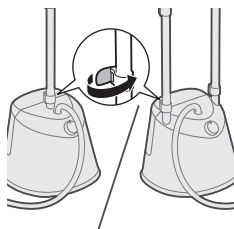

3 Fiksirajte donje kopče za fiksiranje šipke.

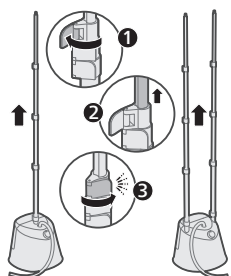

4 Otpustite preostale kopče za fiksiranje šipke, potpuno produžite šipke prema gore i fiksirajte ih.

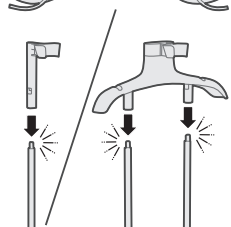

5 Umećite bazu steamer glačala na šipke dok ne sjedne na mjesto („klik“).

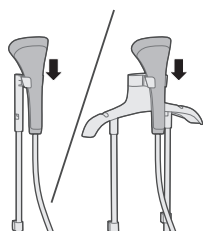

6 Glavu steamer glačala stavite na bazu steamer glačala.

Postavljanje daske

1 Pregledajte dijelove dostupne za aparat koji ste kupili.

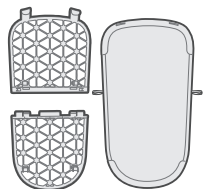

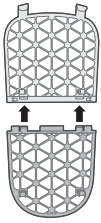

2 Poravnajte i umećite kopče daske dok ne sjednu na mjesto („klik“).

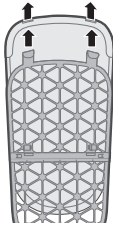

3 Poravnajte navlaku za dasku i umetnite je kroz kuke na dasci.

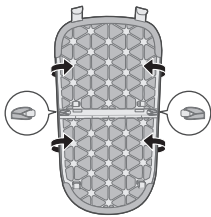

4 Pričvrstite trake navlake za dasku za kuke na stražnjoj strani daske

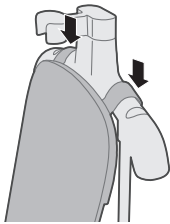

5 Stavite dasku na vješalicu.

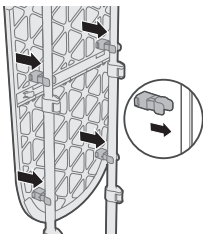

6 Pričvrstite dasku za šipke tako da sjedne na mjesto („klik“).

7 Odjeću možete postaviti na vješalicu.

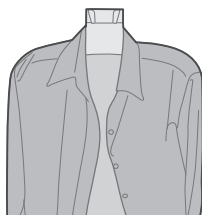
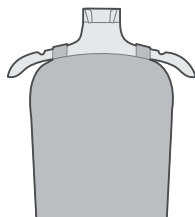

8 Možete upotrijebiti svoju vješalicu i postaviti je na bazu steamer glačala.

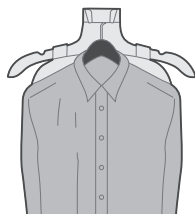

Postavljanje podloge

1 Umetnite srednju traku kroz bazu steamer glačala.

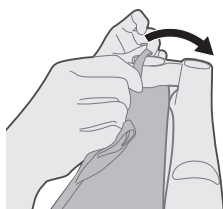

2 Pričvrstite 3 trake za kuku sa stražnje strane vješalice.

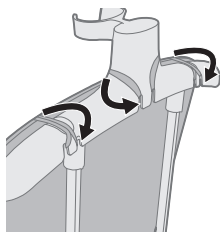

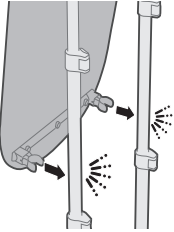

3 Pričvrstite podlogu na šipke tako da sjedne na mjesto („klik“).

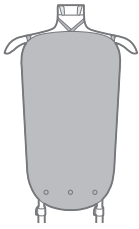

4 Odjeću možete postaviti na vješalicu.



5 Možete upotrijebiti svoju vješalicu i postaviti je na bazu steamer glačala.

Umetanje četke

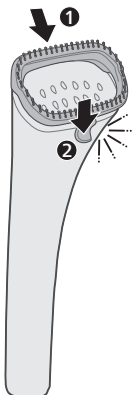

1 Poravnajte rub s gornjim dijelom glave steamer glačala i pritisnite kopču na donjem dijelu tako da sjedne na mjesto („klik“).

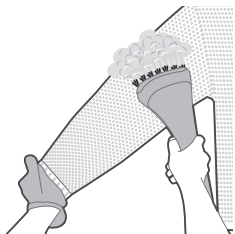

2 Možete nositi rukavicu i glačati odjeću parom s pomoću nastavka s četkom.

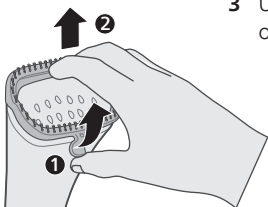

3 Uхватite i povucite kopču s donjeg dijela glave steamer glačala kako biste odvojili nastavak s četkom.

Punjenje spremnika za vodu

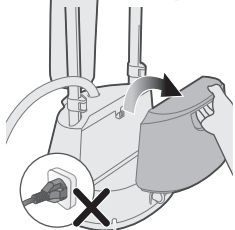

1 Nemojte ukopčavati aparat. Odvojite spremnik za vodu od podnožja.

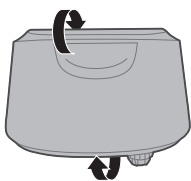

2 Okrenite spremnik za vodu tako da poklopac spremnika za vodu bude usmjeren prema gore.

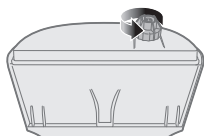

3 Odvijte poklopac spremnika za vodu u smjeru suprotnom od kazaljke na satu kako biste ga odvojili.

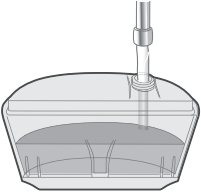

4 Napunite spremnik za vodu

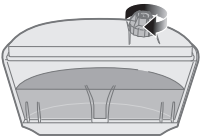

5 Vratite poklopac na spremnik za vodu i okrećite ga u smjeru kazaljke na satu kako biste ga zategnuli.

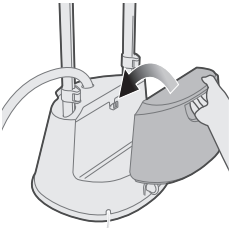

6 Poravnajte s kukom kako biste spremnik za vodu vratili na podnožje.

Promjena postavki pare

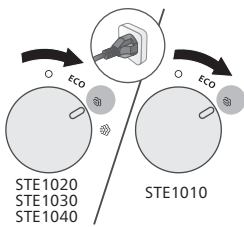

1 Provjerite je li aparat ukopčan u napajanje. Okrenite regulator pare na željenu postavku pare.

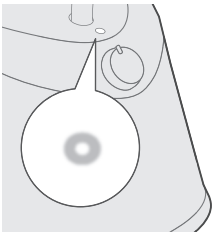

2 Indikator će početi svijetliti naznačujući da je samostojeće steamer glačalo uključeno.

*STE1010/75: ~2 min

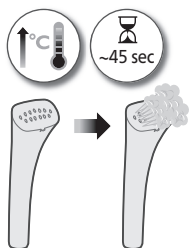

- 3 Pričekajte oko 45 sekundi da se samostojeće steamer glačalo zagrije i počne ispuštati paru (STE1010/75: otprilike 2 minute).

Savjeti za glačanje

- 1 Možete upotrijebiti svoju vješalicu i postaviti je na bazu steamer glačala.

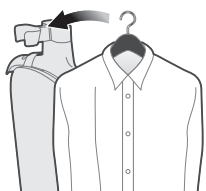

- 2 Pomičite glavu steamer glačala paralelno s ovratnikom.

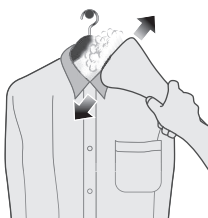

- 3 Pomičite glavu steamer glačala vodoravno sa stražnjom stranom ovratnika.

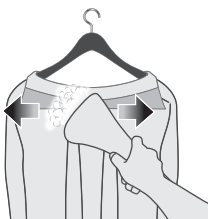

- 4 Zategnite odjevni predmet. Pomičite glavu steamer glačala prema dolje prednjom stranom odjevnog predmeta.

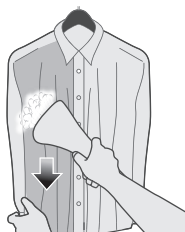



5 Na džepovima glavu steamer glačala pomičite prema gore.

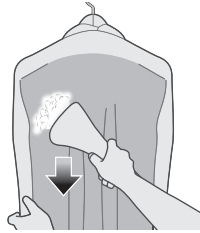

6 Zategnite odjevni predmet. Pomičite glavu steamer glačala prema dolje stražnjom stranom odjevnog predmeta.

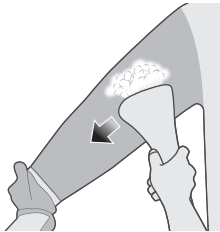

7 Zategnite odjevni predmet. Pomičite glavu steamer glačala paralelno s rukavom.

Čišćenje i održavanje

Sustav za sakupljanje kamenca

Vaš aparat dizajniran je sa sustavom za sakupljanje kamenca. Preporučuje se da kamenca uklanjate jednom ili više puta mjesečno. Time se pomaže održavanje snažnog mlaza pare te sprječava ispadanje prljavštine i kamenca iz ploče za glačanje do kojeg s vremenom dolazi.

Savjet: Sustav za sakupljanje kamenca možete upotrebljavati bilo kada. Ako stanujete u području s tvrdom vodom, češće upotrebljavajte funkciju.

Postupak čišćenja kamena

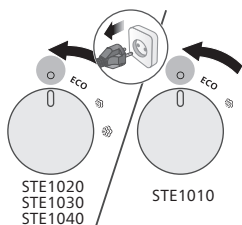

1 Provjerite je li regulator pare u položaju za isključivanje i je li aparat iskopčan.

2 Provjerite je li se glačalo potpuno ohladilo (> 1 sat).



3 Stavite steamer glačalo blizu odvoda.

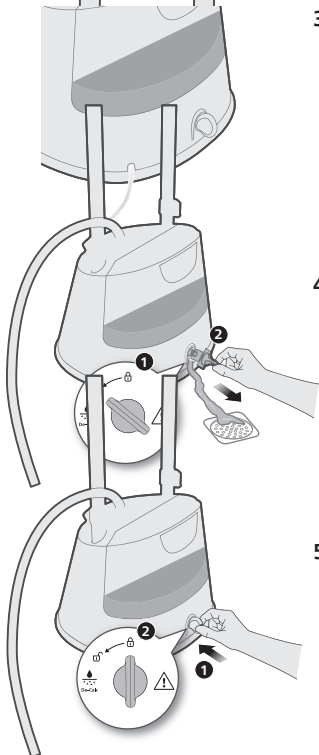

4 Okrenite regulator za De-calc u položaj za otključavanje i odvojite ga. Pustite da voda iscuri.

5 Umetnite regulator De-calc i okrenite ga u položaj za zaključavanje.

Čišćenje i spremanje samostojećeg steamer glačala

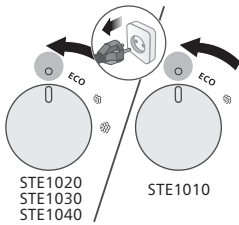

1 Provjerite je li regulator pare u položaju za isključivanje i je li aparat iskopčan.

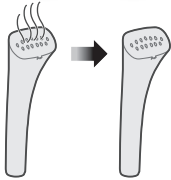

2 Provjerite je li se glačalo potpuno ohladilo (> 1 sat).

3 Obrišite ploču za glačanje vlažnom krpom.

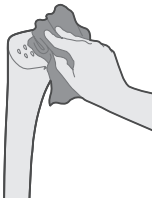

4 Potpuno ispraznite spremnik za vodu.

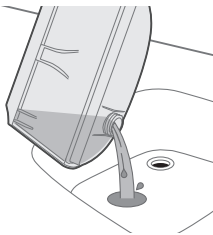

5 Kabel za napajanje omotajte oko podnožja.

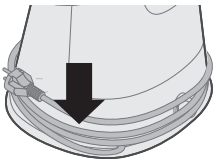

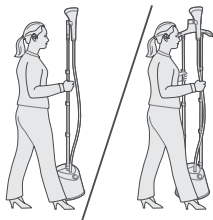

6 Samostojeće steamer glačalo možete nositi držeći ga za šipku.

Rješavanje problema

U ovom poglavlju opisani su uobičajeni problemi vezani uz uporabu aparata. Ako problem ne možete riješiti s pomoću informacija u nastavku, posjetite www.philips.com/support kako biste pronašli popis čestih pitanja ili se obratite centru za korisničku podršku u svojoj državi.

Problem	Mogući uzrok	Rješenje
Aparat ne proizvodi paru ili proizvodi neravnomjernu paru.	Steamer glačalo nije se dovoljno zagrijalo.	Ostavite aparat da se zagrijava približno 45 sekundi (STE1010/75: otprilike 2 minute).
	Para se kondenzirala u crijevu.	Podignite glavu steamer glačala kako biste okomito izravnali crijevo. Tako će se kondenzirana voda vratiti.
	Niska razina vode u spremniku ili spremnik nije pravilno umetnut.	Napunite spremnik za vodu i pravilno ga umetnite.
	U aparatu se nakupilo previše kamenca.	Izvršite postupak uklanjanja kamenca. Pogledajte odjeljak za čišćenje kamenca.
Kapi vode kapaju iz glave steamer glačala ili aparat stvara zvuk koji podsjeća na kreštanje.	Predugo ste ostavili glavu steamer glačala i/ili crijevo za dovod pare u vodoravnom položaju.	Podignite glavu steamer glačala kako biste okomito izravnali crijevo. Tako će se kondenzirana voda vratiti.
	Kad se crijevo savije u obliku slova U, kondenzirana voda u njemu ne može se vratiti u spremnik za vodu.	Podignite glavu steamer glačala kako biste okomito izravnali crijevo. Tako će se kondenzirana voda vratiti.
Previše vode kapa iz glave steamer glačala dok se aparat zagrijava.	Voda u aparatu prljava je ili je predugo stajala u aparatu.	Izvršite postupak uklanjanja kamenca. Pogledajte odjeljak za čišćenje kamenca.
Voda curi iz podnožja steamer glačala.	Niste dobro zatvorili poklopac spremnika za vodu ili regulator decalc. Spremnik za vodu nije pravilno umetnut.	Dobro zatvorite poklopac spremnika za vodu ili regulator decalc. Pravilno umetnite spremnik za vodu.

Introduzione

Congratulazioni per l'acquisto. Ti diamo il benvenuto in Philips! Per trarre il massimo vantaggio dall'assistenza fornita da Philips, registrare il proprio prodotto sul sito: www.philips.com/welcome. Leggere attentamente il presente manuale utente, l'importante brochure informativa e la guida rapida prima di utilizzare l'apparecchio e conservarli per riferimenti futuri.

Panoramica del prodotto

STE1020, STE1030, STE1040

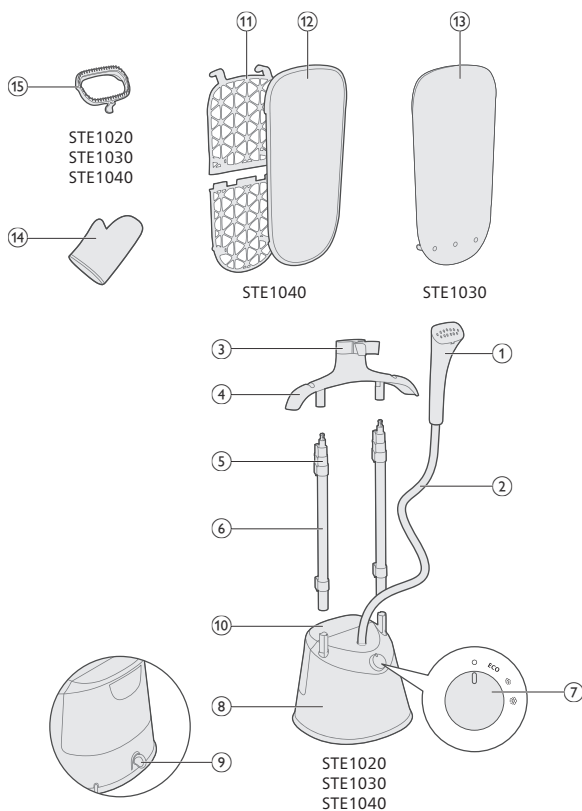

STE1010

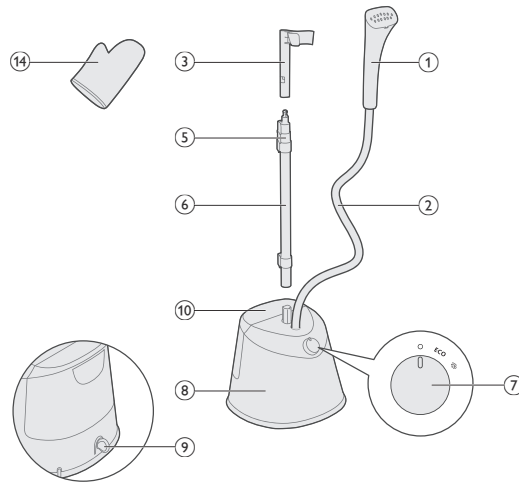

- 1 Bocchetta del sistema di stiratura a vapore
- 2 Tubo del vapore
- 3 Supporto della bocchetta
- 4 Appendiabiti (STE1020, STE1030, STE1040)
- 5 Gancio di fissaggio dell'asta
- 6 Asta
- 7 Manopola del vapore
- 8 Base
- 9 Manopola De-Calc
- 10 Serbatoio dell'acqua
- 11 Asse da stiro (STE1040)
- 12 Rivestimento (STE1040)
- 13 Tappetino (STE1030)
- 14 Guanto
- 15 Spazzola (STE1020, STE1030, STE1040)

Preparazione per l'uso

Tipo di acqua da utilizzare

È possibile usare l'apparecchio con l'acqua del rubinetto. Tuttavia, se si vive in aree caratterizzate dalla presenza di acqua dura, si consiglia di mescolare l'acqua del rubinetto con la stessa quantità di acqua distillata o demineralizzata. Ciò consentirà di evitare la rapida formazione di calcare e di prolungare la vita dell'apparecchio.

Non aggiungere profumo, acqua proveniente dall'asciugatrice, aceto, amido, agenti decalcificanti, prodotti per la stiratura, acqua decalcificata chimicamente o altre sostanze chimiche, poiché

potrebbero causare la fuoriuscita di acqua, la comparsa di macchie marroncine oppure danni all'apparecchio.

Avvertenza



1 Non esporre alcuna area della pelle a diretto contatto con il vapore.



2 Non rivolgere mai la piastra del vapore verso altre persone.



3 Non tenere l'indumento a diretto contatto con il vapore.

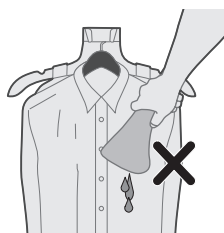

4 Non utilizzare la bocchetta del sistema di stiratura a vapore rivolta verso il basso.



5 Non piegare il tubo per vaporizzare l'indumento.

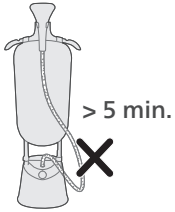

6 Non lasciare il sistema di stiratura a vapore verticale incustodito per più di 5 minuti.

Installazione dell'apparecchio

STE1010

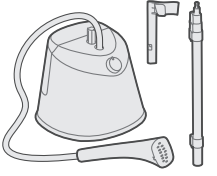

1 Prendere nota dei vari componenti disponibili per l'apparecchio acquistato.

STE1020, STE1030
STE1040



2 Sbloccare il/i gancio/i di fissaggio dell'asta inferiori e fissare l'asta/le aste alla base. Assicurarsi che i profili dell'asta/delle aste e i perni della base siano allineati.

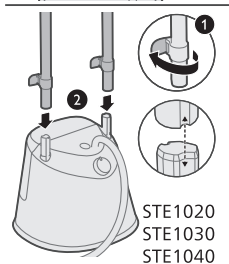
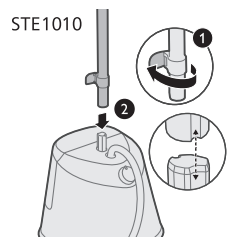

STE1020
STE1030
STE1040

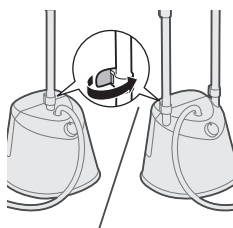

3 Bloccare il/i gancio/i di fissaggio dell'asta inferiori.

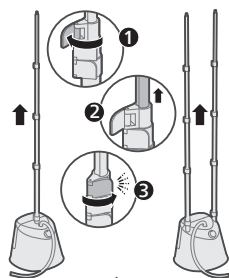

4 Sbloccare gli altri ganci di fissaggio dell'asta, estendere completamente l'asta/le aste verso l'alto e bloccarle.

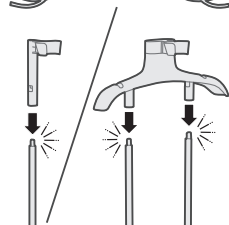

5 Fissare il supporto della bocchetta all'asta/alle aste e farlo scattare in posizione con un "clac".

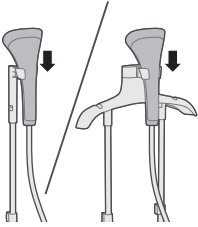

6 Appendere la bocchetta del sistema di stiratura a vapore al supporto.

Posizionamento dell'asse da stiro

1 Prendere nota dei vari componenti disponibili per l'apparecchio acquistato.

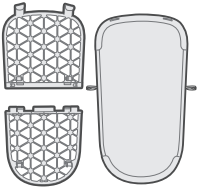

2 Allineare e fissare le clip dell'asse facendole scattare in posizione con un "clic".

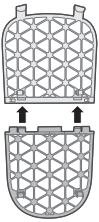

3 Allineare e fissare il rivestimento dell'asse ai ganci dell'asse.

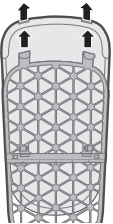

4 Agganciare i cordini del rivestimento dell'asse ai ganci sul retro dell'asse.

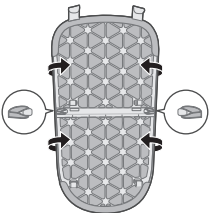

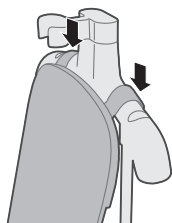

5 Posizionare l'asse sull'appendiabiti.

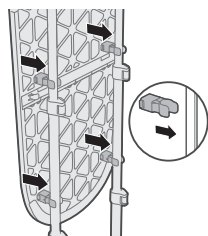

6 Fissare l'asse alle aste e farla scattare in posizione con un "clic"



7 È possibile appendere gli indumenti all'appendiabiti.

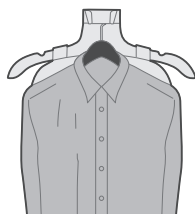
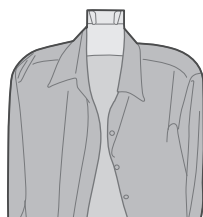

8 È inoltre possibile utilizzare una propria gruccia e posizionarla sul supporto della bocchetta.

Posizionamento del tappetino

1 Agganciare il cordino centrale al supporto della bocchetta.

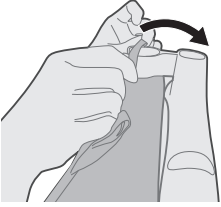

2 Agganciare gli altri 3 cordini ai ganci sul retro dell'appendiabiti.

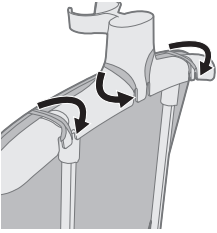

3 Fissare il tappetino alle aste e farlo scattare in posizione con un "clic".

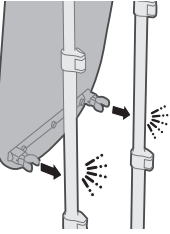

4 È possibile appendere gli indumenti all'appendiabiti.

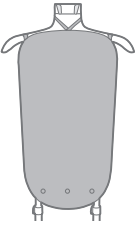



- 5 È inoltre possibile utilizzare una propria gruccia e posizionarla sul supporto della bocchetta.

Inserimento della spazzola

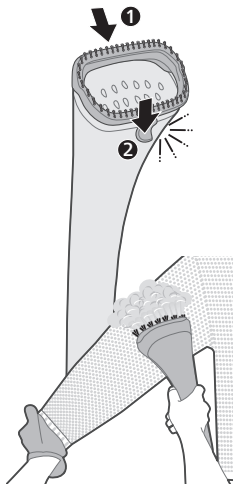

- 1 Allineare il binario lungo la parte superiore della bocchetta e fare scattare il gancio sulla parte inferiore in posizione con un "clic".

- 2 È possibile indossare il guanto e vaporizzare gli indumenti utilizzando l'accessorio spazzola.

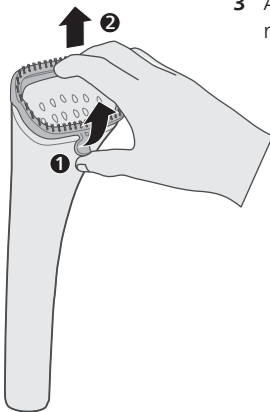

- 3 Afferrare ed estrarre il gancio sulla parte inferiore della bocchetta per rimuovere l'accessorio spazzola.

Riempimento del serbatoio dell'acqua

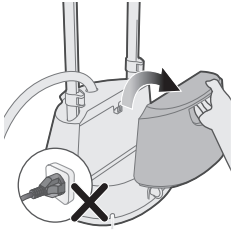

1 Non collegare l'apparecchio alla presa di corrente. Estrarre il serbatoio dell'acqua dalla base.

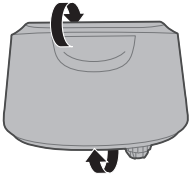

2 Capovolgere il serbatoio dell'acqua con il tappo rivolto verso l'alto.

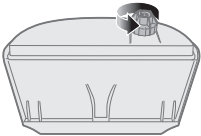

3 Svitare il tappo del serbatoio dell'acqua in senso antiorario per rimuoverlo.

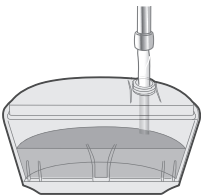

4 Riempire il serbatoio dell'acqua.

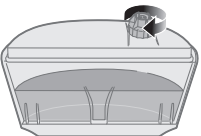

5 Avvitare il tappo del serbatoio dell'acqua in senso orario per serrarlo.

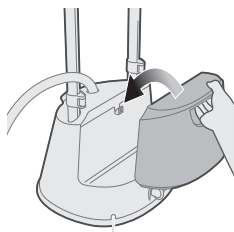

- 6 Allineare il serbatoio dell'acqua con il gancio per riposizionarlo sulla base.

Modifica delle impostazioni del vapore

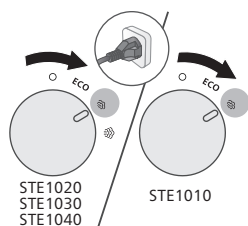

- 1 Assicurarsi che l'apparecchio sia collegato alla presa di corrente. Ruotare la manopola del vapore sull'impostazione desiderata.

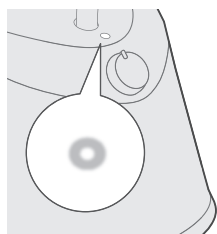

- 2 La spia si accende fissa a indicare che il sistema di stiratura a vapore verticale è ACCESO.

*STE1010/75: ~2 min

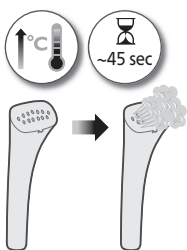

- 3 Attendere circa 45 secondi affinché il sistema di stiratura a vapore verticale si riscaldi ed emetta vapore (per il modello STE1010/75, attendere circa 2 minuti).

Consigli per la stiratura

- 1 È inoltre possibile utilizzare una propria gruccia e posizionarla sul supporto della bocchetta.

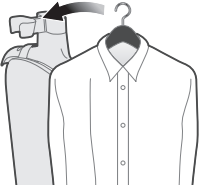

- 2 Muovere la bocchetta in direzione parallela al colletto.

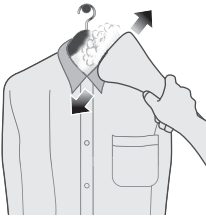

- 3 Muovere la bocchetta in direzione orizzontale al carré/sprone.



- 4 Tendere l'indumento. Muovere la bocchetta verso il basso lungo la parte anteriore dell'indumento.

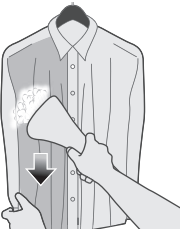

- 5 Muovere la bocchetta verso l'alto soffermandosi sulla tasca.





6 Tendere l'indumento. Muovere la bocchetta verso il basso lungo la parte posteriore dell'indumento.

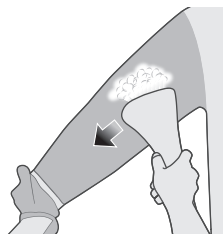

7 Tendere l'indumento. Muovere la bocchetta in direzione parallela alla manica.

Pulizia e manutenzione

Raccoglitore per la pulizia anticalcare

L'apparecchio è dotato di un sistema di pulizia anticalcare. Si consiglia di eseguire la rimozione del calcare almeno una volta al mese. Ciò consente di mantenere prestazioni elevate in termini di vapore e impedisce che dalla piastra fuoriesca sporco e compaiano macchie con il passare del tempo.

Suggerimento: il sistema di pulizia anticalcare può essere utilizzato in qualsiasi momento. Se l'acqua presente nella zona in cui si abita è molto dura, utilizzare la funzione più frequentemente.

Procedura Calc-Clean

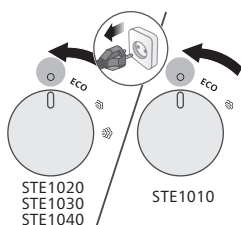

1 Assicurarsi che la manopola del vapore sia posizionata su OFF e che l'apparecchio sia scollegato dalla presa di corrente.

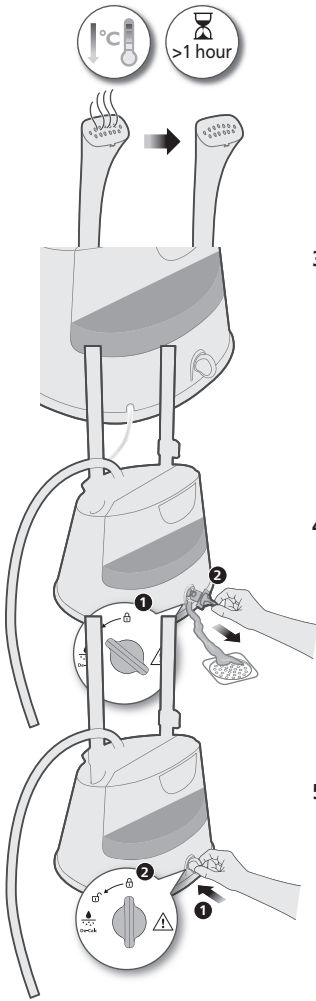

2 Assicurarsi che il ferro si sia raffreddato completamente (> 1 ora).

3 Posizionare il sistema di stiratura a vapore vicino a uno scarico.

4 Ruotare la manopola De-Calc in posizione di sblocco e rimuoverla. Lasciare scorrere l'acqua.

5 Reinscrivere e ruotare la manopola De-Calc in posizione di blocco.

Pulizia e conservazione del sistema di stiratura a vapore verticale

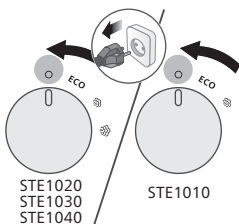

1 Assicurarsi che la manopola del vapore sia posizionata su OFF e che l'apparecchio sia scollegato dalla presa di corrente.

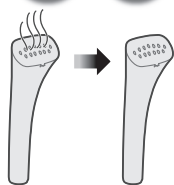

2 Assicurarsi che il ferro si sia raffreddato completamente (> 1 ora).

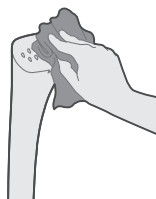

3 Pulire la piastra del vapore con un panno umido.



4 Svuotate completamente il serbatoio dell'acqua.

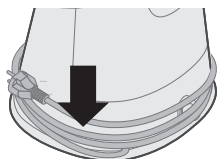

5 Avvolgere il cavo di alimentazione attorno alla base.

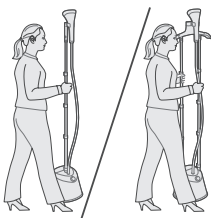

6 È possibile trasportare il sistema di stiratura a vapore verticale afferrandolo dall'asta.

Risoluzione dei problemi

In questo capitolo vengono riportati i problemi più comuni legati all'uso dell'apparecchio. Se non è possibile risolvere il problema con le informazioni riportate di seguito, visitare il sito www.philips.com/support per un elenco di domande frequenti oppure contattare il centro assistenza clienti del proprio paese.

Problema	Possibile causa	Soluzione
L'apparecchio non produce vapore o il flusso di vapore è irregolare.	Il sistema di stiratura a vapore non si è riscaldato sufficientemente.	Lasciare riscaldare l'apparecchio per circa 45 secondi (per il modello STE1010/75, attendere circa 2 minuti).
	Il vapore si è condensato all'interno del tubo flessibile.	Solleverare la bocchetta del sistema di stiratura a vapore per raddrizzare il tubo flessibile in verticale. Così facendo, eventuali condense possono defluire verso il basso.
	Basso livello dell'acqua nel serbatoio o serbatoio non inserito correttamente.	Riempire il serbatoio dell'acqua e inserirlo correttamente.
	All'interno dell'apparecchio si è accumulato troppo vapore.	Eseguire la procedura di rimozione del calcare. Fare riferimento alla sezione dedicata alla funzione Calc-Clean.
Gocce d'acqua fuoriescono dalla bocchetta del sistema di stiratura a vapore o l'apparecchio produce un suono di gorgoglio.	La bocchetta e/o il tubo flessibile del sistema di stiratura a vapore sono stati lasciati in posizione orizzontale per un tempo prolungato.	Solleverare la bocchetta del sistema di stiratura a vapore per raddrizzare il tubo flessibile in verticale. Così facendo, eventuali condense possono defluire verso il basso.
	Quando il tubo flessibile forma una "U", la condensa che si forma all'interno del tubo non può defluire nel serbatoio dell'acqua.	Solleverare la bocchetta del sistema di stiratura a vapore per raddrizzare il tubo flessibile in verticale. Così facendo, eventuali condense possono defluire verso il basso.

Una quantità eccessiva di acqua fuoriesce dalla bocchetta del sistema di stiratura a vapore quando l'apparecchio si riscalda.

L'acqua all'interno dell'apparecchio è sporca o è stata lasciata nel serbatoio per un periodo di tempo prolungato.

Eseguire la procedura di rimozione del calcare. Fare riferimento alla sezione dedicata alla funzione Calc-Clean.

L'acqua fuoriesce dalla base del sistema di stiratura a vapore.

Il cappuccio del serbatoio dell'acqua o la manopola De-Calc non sono stati chiusi correttamente. Il serbatoio dell'acqua non è stato inserito correttamente.

Chiudere completamente il cappuccio del serbatoio dell'acqua e la manopola De-Calc. Inserire il serbatoio in maniera corretta.

Ievads

Apsveicam ar pirkumu un laipni lūdzam Philips! Lai pilnībā izmantotu Philips piedāvātā atbalsta iespējas, reģistrējiet produktu vietnē www.philips.com/welcome. Pirms ierīces lietošanas uzmanīgi izlasiet šo lietotāja rokasgrāmatu, brošūru ar svarīgu informāciju un īso lietošanas pamācību. Saglabājiet šos dokumentus turpmākām uzziņām.

Produkta pārskats

STE1020, STE1030, STE1040

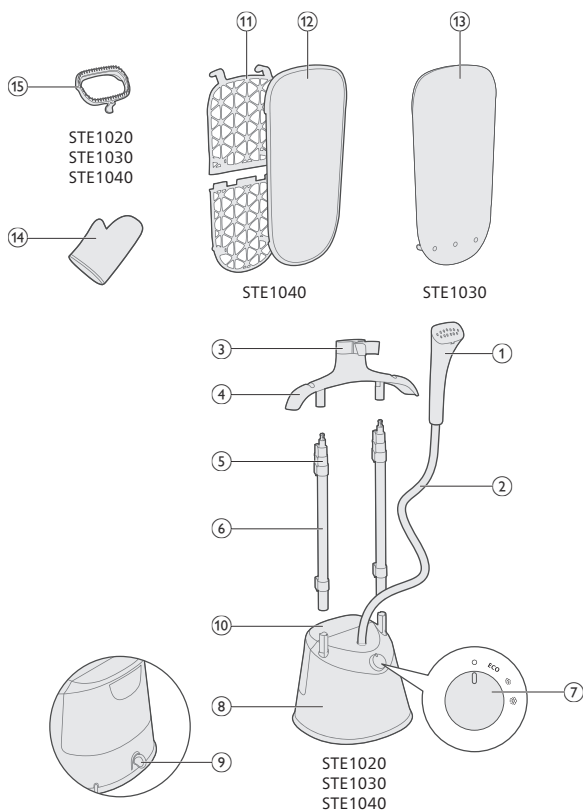

STE1010

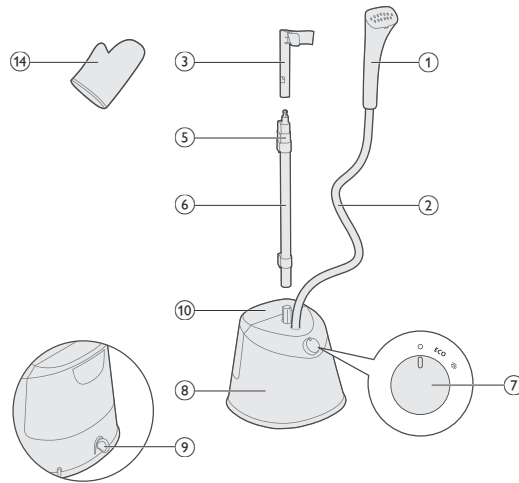

- 1 Tvaicētāja galviņa
- 2 Tvaika padeves šļūtene
- 3 Tvaicētāja turētājs
- 4 Pakaramais (STE1020, STE1030, STE1040)
- 5 Balsta fiksators
- 6 Balsts
- 7 Tvaika regulators
- 8 Pamatne
- 9 Katlākmeņa attīrīšanas aizbāznis
- 10 Ūdens tvertne
- 11 Plāksne (STE1040)
- 12 Pārsegs (STE1040)
- 13 Virskārta (STE1030)
- 14 Cimds
- 15 Suka (STE1020, STE1030, STE1040)

Sagatavošana lietošanai

Izmantojamais ūdens veids

Ierīce ir piemērota lietošanai ar krāna ūdeni. Tomēr, ja dzīvojat apvidū ar cietu ūdeni, mēs iesakām sajaukt vienādu daudzumu krāna ūdens ar destilētu vai demineralizētu ūdeni. Tādējādi tiks novērsta ātra kalcākmens nogulšņu veidošanās, un tiks pagarināts ierīces darbmūžs.

Neizmantojiet smaržas, ūdeni no žāvētāja, etiķi, cieti, atkaļķošanas līdzekļus, gludināšanas palīg līdzekļus, ķīmiski atkaļķotu ūdeni vai citas ķīmikālijas, jo tās var izraisīt ūdens smidzināšanos, brūnus traipus vai ierīces bojājumus.

Brīdinājumi

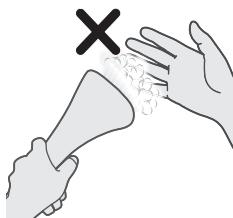

1 Raugieties, lai āda nenonāktu tiešā saskarē ar tvaiku.



2 Nevērsiet tvaika plātņi pret citiem cilvēkiem.



3 Neturiet apģērbu tā, lai āda caur apģērbu varētu nonākt saskarē ar tvaiku.

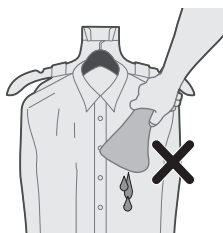

4 Neizmantojiet tvaicētāja galviņu, pavērstu uz leju.

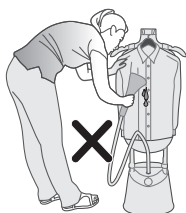

5 Apģērba tvaicēšanas laikā nelokiet šļūteni.

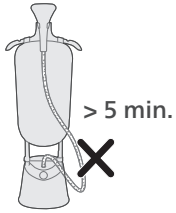

- 6 Neatstājiet tvaicētāju ar statīvu bez uzraudzības ilgāk par 5 minūtēm.

Aprīkojuma uzstādīšana

STE1010

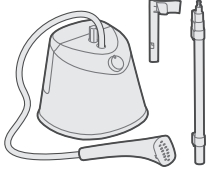

- 1 Izpētiet, kādas detaļas ir pieejamas jūsu iegādātajai ierīcei.

STE1020, STE1030
STE1040



STE1010

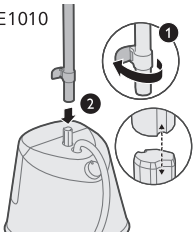

- 2 Atbrīvojiet apakšējā balsta fiksatorus un ievietojiet balstu(-us) pamatnē. Pārliecinieties, ka balsta(-u) un pamatnes balsta tapas(-u) profili ir savstarpēji salāgoti.

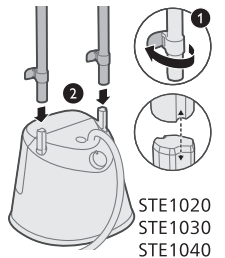

STE1020
STE1030
STE1040

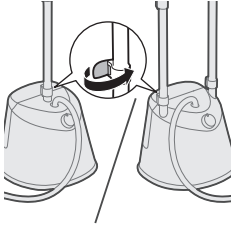

3 Nofiksējiet apakšējā balsta fiksatoru(-us).

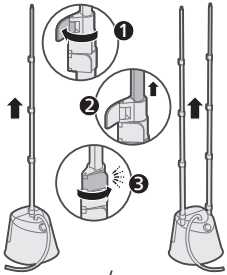

4 Atbrīvojiet pārējos balsta fiksatorus, izvelciet balstu(-us) visā garumā un nostipriniet fiksatorus.

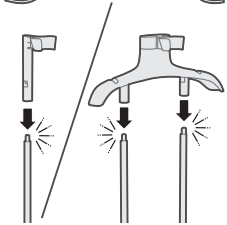

5 Uzlieciet tvaicētāja turētāju uz balsta(-iem), līdz tas ar klikšķi nofiksējas savā vietā.

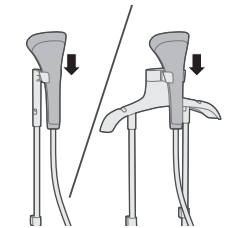

6 Ievietojiet tvaicētāja galviņu tvaicētāja turētājā.

Plāksnes sagatavošana

1 Izpētiet, kādas detaļas ir pieejamas jūsu iegādātajai ierīcei.

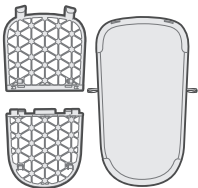

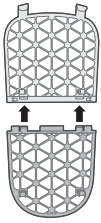

2 Salāgojiet un ievietojiet plāksnes fiksatorus, līdz tie ar klikšķi nofiksējas.

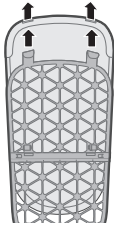

3 Salāgojiet un uzlieciet plāksnes pārsegu, izvelkot cauri plāksnes āķus.

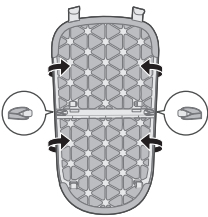

4 Aizāķējiet plāksnes pārsega stiprinājumus aiz āķiem plāksnes aizmugurē.

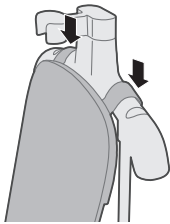

5 Novietojiet plāksni uz pakaramā.

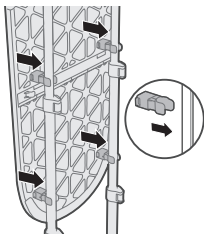

6 Spiediet plāksni pie balstiem, līdz tā ar klikšķi nofiksējas.

200 Latviešu

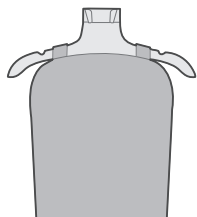

7 Varat pakarināt savas drēbes uz pakaramā.

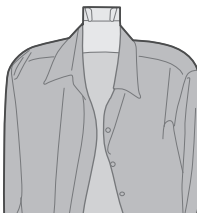

8 Varat arī izmantot savu pakaramo un novietot to uz tvaicētāja turētāja.

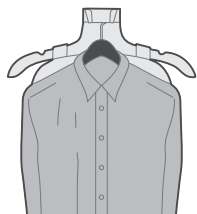

Virskārtas sagatavošana

1 Velciet vidējo stiprinājumu caur tvaicētāja turētāju.

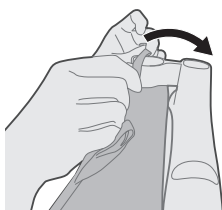

2 Nofiksējiet visus 3 stiprinājumus uz āķiem pakaramā aizmugurē.

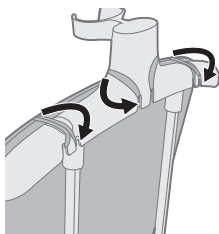

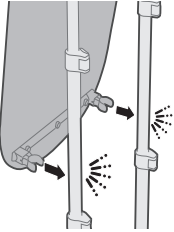

3 Spiediet virskārtu pie balstiem, līdz tā ar klikšķi nofiksējas.

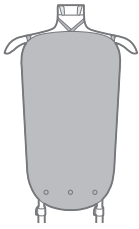

4 Varat pakarināt savas drēbes uz pakaramā.



5 Varat arī izmantot savu pakaramo un novietot to uz tvaicētāja turētāja.

Sukas ievietošana

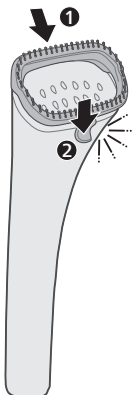

1 Salāgojiet suku ar sliedi tvaicētāja galviņas augšdaļā un tad nostipriniet to ar fiksatoru suku apakšdaļā, līdz atskan klikšķis.

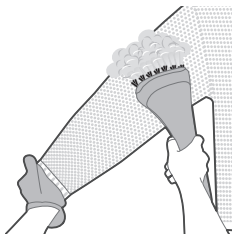

2 Varat uzvilkt cimdu un tvaicēt drēbes, izmantojot suku uzgali.

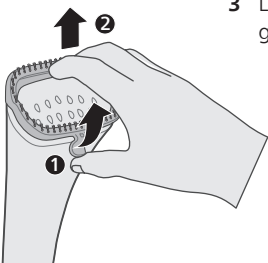

3 Lai noņemtu suku uzgali, satveriet un novelciet fiksatoru no tvaicētāja galviņas apakšas.

Ūdens tvertnes uzpildīšana

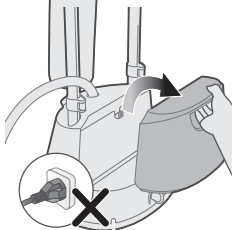

1 Nepievienojiet ierīci strāvas avotam. Atvienojiet ūdens tvertni no ierīces pamatnes.

2 Pagrieziet ūdens tvertni, lai tās vāciņš būtu pavērsts uz augšu.

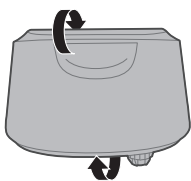

3 Lai noņemtu ūdens tvertnes vāciņu, skrūvējiet to pretēji pulksteņrādītāju kustības virzienam.

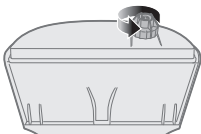

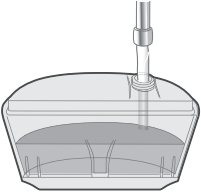

4 Ielejiet ūdens tvertnē ūdeni.

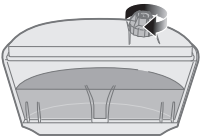

5 Lai aizvērtu ūdens tvertnes vāciņu, skrūvējiet to pulksteņrādītāju kustības virzienā.

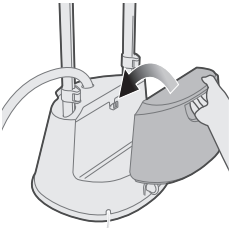

6 Salāgojiet ar āķi, lai piestiprinātu ūdens tvertni atpakaļ pie pamatnes.

Tvaika iestatījumu maiņa

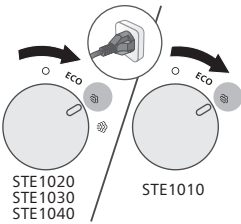

1 Ierīcei ir jābūt pievienotai strāvas avotam. Pagrieziet tvaika regulatoru uz vēlamo tvaika iestatījumu.

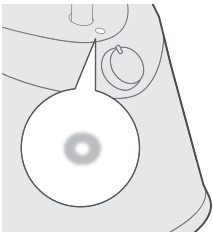

2 Gaismas indikators degs nemirgojot, šādi parādot, ka tvaicētājs ar statīvu ir ieslēgts.

*STE1010/75: ~2 min

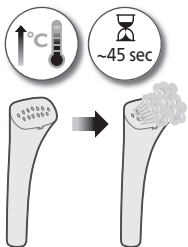

- 3 Gaidiet apmēram 45 sekundes, līdz tvaicētājs ar statīvu uzkarst un sāk izdalīt tvaiku (STE1010/75: aptuveni 2 minūtes).

Gludināšanas padomi

- 1 Varat arī izmantot savu pakaramo un novietot to uz tvaicētāja turētāja.

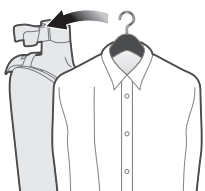

- 2 Virziet tvaicētāja galviņu paralēli apkaklei.

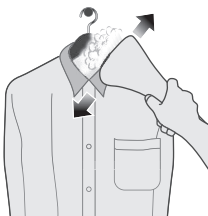

- 3 Virziet tvaicētāja galviņu horizontāli pār plecu joslu.

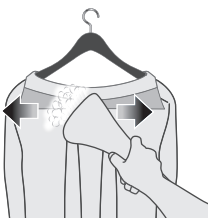

- 4 Nostiepiet apģērbu. Virziet tvaicētāja galviņu lejup pār apģērba priekšpusi.

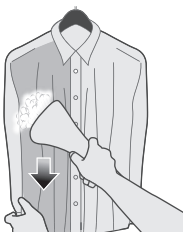



5 Virziet tvaicētāja galviņu augšup pār kabatu.

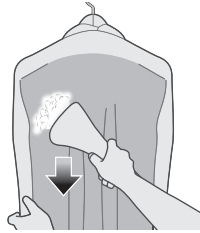

6 Nostiepiet apģērbu. Virziet tvaicētāja galviņu lejup pār apģērba aizmuguri.

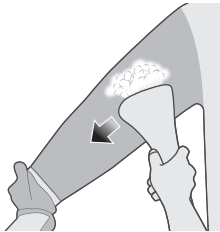

7 Nostiepiet apģērbu. Virziet tvaicētāja galviņu paralēli pār piedurknēm.

Tīrīšana un kopšana

Katlakmens savācējs

Ierīce ir aprīkota ar katlakmens savākšanas sistēmu. Katlakmens attīrīšanu ieteicams veikt reizi mēnesī vai biežāk. Tas palīdz uzturēt spēcīgu tvaika veiktspēju un novērš netīrumu un traipu izplūšanu no gludināšanas virsmas laika gaitā.

Padoms. Katlakmens savākšanas sistēmu var izmantot jebkurā laikā. Ja dzīvojat reģionā, kur ir ciets ūdens, izmantojiet šo funkciju biežāk.

Katlakmens attīrīšana

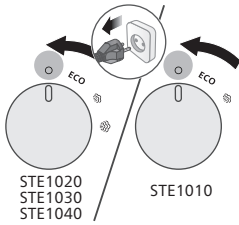

1 Tvaika regulatoram jābūt IZSLĒGTĀ pozīcijā un ierīcei atvienotai no strāvas avota.

2 Gludeklim jābūt pilnībā atdzisušam (> 1 stunda).



3 Novietojiet tvaika gludekli blakus notekai.

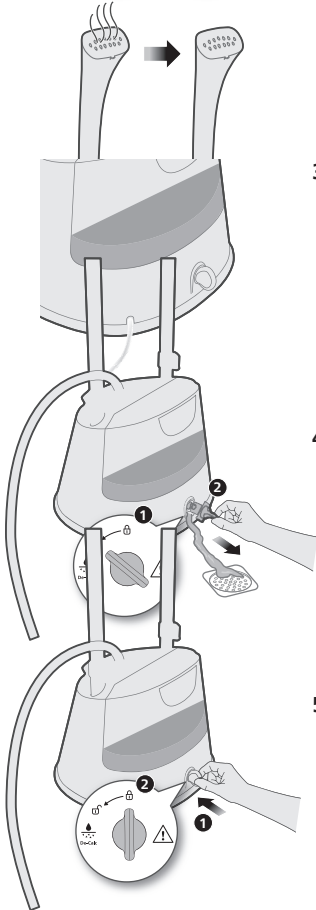

4 Pagrieziet katlakmens attīrīšanas aizbāzni atbloķētā pozīcijā un izņemiet to. Ļaujiet ūdenim iztecēt.

5 Ievietojiet un pagrieziet katlakmens attīrīšanas aizbāzni bloķētā pozīcijā.

Tvaicētāja un statīva tīrīšana un glabāšana

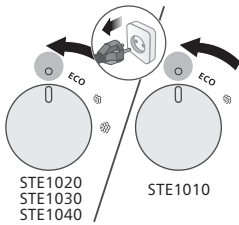

- 1 Tvaika regulatoram jābūt IZSLĒGTĀ pozīcijā un ierīcei atvienotai no strāvas avota.

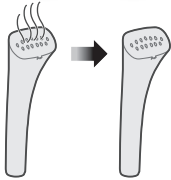

- 2 Gludeklim jābūt pilnībā atdzisušam (> 1 stunda).

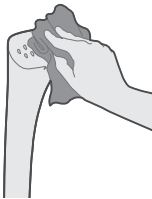

- 3 Noslaukiet tvaika izvades vietu ar mitru drānu.

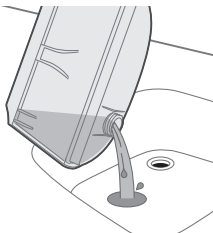

- 4 Pilnībā iztukšojiet ūdens tvertni.

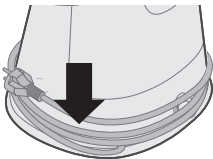

- 5 Aptiniet strāvas vadu ap pamatni.

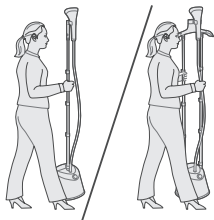

6 Tvaicētāja statīvu var pārnēsāt aiz balsta.

Problēmu novēršana

Šajā nodaļā apkopota informācija par izplatītām problēmām, kas var rasties ierīces darbībā. Ja nevarat novērst problēmu, izmantojot tālāk sniegto informāciju, apmeklējiet vietni www.philips.com/support, lai skatītu bieži uzdoto jautājumu sarakstu, vai arī sazinieties ar klientu apkalpošanas centru savā valstī.

Problēma	Iespējamais cēlonis	Risinājums
Ierīce nerada tvaiku vai dara to neregulāri.	Tvaicētājs nav pietiekami uzsilis.	Ļaujiet ierīcei uzsilt aptuveni 45 sekundes (STE1010/75: aptuveni 2 minūtes).
	Šļūtenē ir kondensējies tvaiks.	Paceliet tvaicētāja galviņu, lai iztaisnotu šļūteni vertikāli. Tādējādi kondensāts ieplūdis atpakaļ ierīcē.
	Zems ūdens līmenis tvertnē, vai tvertne nav pareizi ievietota.	Vēlreiz uzpildiet ūdens tvertni un ievietojiet to pareizi.
	Ierīcē ir uzkrājies pārāk daudz katlakmens nogulšņu.	Veiciet katlakmens attīrīšanas procesu. Skatiet sadaļu par katlakmens attīrīšanu.
No tvaicētāja galviņas pil ūdens, vai ierīce rada dīvainu skaņu.	Esat pārāk ilgi atstājis tvaicētāja galviņu un/vai tvaika padeves šļūteni horizontālā pozīcijā.	Paceliet tvaicētāja galviņu, lai iztaisnotu šļūteni vertikāli. Tādējādi kondensāts ieplūdis atpakaļ ierīcē.
	Kad šļūtene izveido U formas izliekumu, šļūtenē esošais kondensāts nevar atplūst atpakaļ ūdens tvertnē.	Paceliet tvaicētāja galviņu, lai iztaisnotu šļūteni vertikāli. Tādējādi kondensāts ieplūdis atpakaļ ierīcē.
Ierīces uzsilšanas laikā no tvaicētāja galviņas izplūst liels daudzums ūdens.	Ierīcē esošais ūdens ir netīrs vai atradies ierīcē ilgu laiku.	Veiciet katlakmens attīrīšanas procesu. Skatiet sadaļu par katlakmens tīrīšanu.
No tvaicētāja pamatnes izplūst ūdens.	Nav pareizi aizvērts ūdens tvertnes vāciņš vai katlakmens attīrīšanas aizbāznis. Ūdens tvertne nav pareizi ievietota.	Aizveriet ūdens tvertnes vāciņu vai katlakmens attīrīšanas aizbāzni pareizi. Pareizi ievietojiet ūdens tvertni.

Įvadas

Sveikiname įsigijus „Philips“ gaminį ir sveiki atvykę! Norėdami pasinaudoti „Philips“ siūloma pagalba, užregistruokite savo gaminį adresu www.philips.com/welcome. Prieš naudodamiesi prietaisu atidžiai perskaitykite šį naudotojo vadovą, svarbios informacijos lapelį ir trumpąjį naudojimo pradžios vadovą. Saugokite juos, nes gali prireikti ateityje.

Gaminio apžvalga

STE1020, STE1030, STE1040

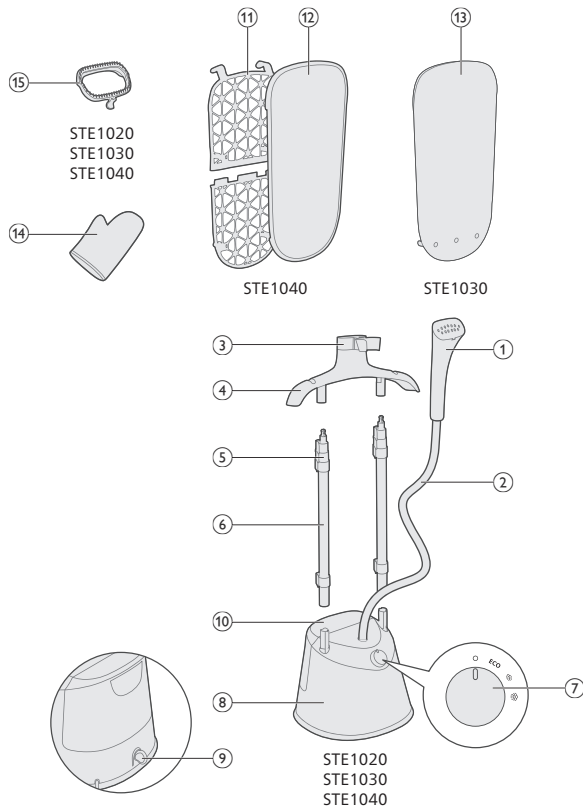

STE1010

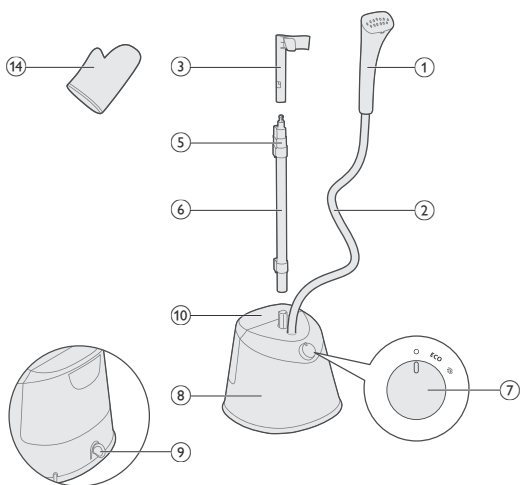

- 1 Garintuvo antgalis
- 2 Garų tiekimo žarnelė
- 3 Garintuvo stovas
- 4 Pakabas (STE1020, STE1030, STE1040)
- 5 Rėmo fiksatorius
- 6 Rėmas
- 7 Garų reguliavimo ratukas
- 8 Pagrindas
- 9 Kalkių šalinimo rankenėlė
- 10 Vandens bakelis
- 11 Lenta (STE1040)
- 12 Danga (STE1040)
- 13 Paklotas (STE1030)
- 14 Pirštinė
- 15 Šepetys (STE1020, STE1030, STE1040)

Paruošimas naudoti

Naudojamas vanduo

Prietaisas naudojamas su vandentiekio vandeniu. Tačiau, jei gyvenate vietovėje, kurioje vanduo yra kietas, rekomenduojame sumaišyti vienodą kiekį vandentiekio ir distiliuoto arba demineralizuoto vandens. Tokiu būdu kalkių nuosėdos susidarys lėčiau ir pailginsite prietaiso tarnavimo laiką.

Nenaudokite kvėpalų, vandens iš džiovyklės, acto, krakmolo, kalkių šalinimo priemonių, pagalbinių lyginimo priemonių, cheminiu būdu nuo kalkių išvalyto vandens ir kitų chemikalų, nes dėl jų vanduo gali imti taškytis, palikti rudų dėmių arba sugadinti prietaisą.

Perspėjimai

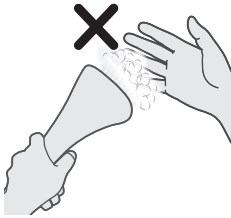

1 Saugokite odą nuo tiesioginio kontakto su garais.



2 Nenukreipkite garinio pado į kitus asmenis.

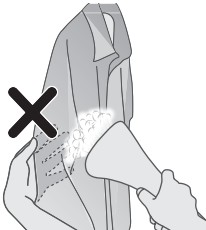

3 Nelaikykite drabužio taip, kad jis tiesiogiai liestųsi su garais.

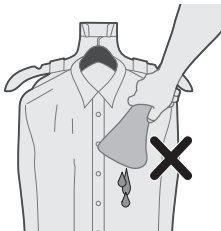

4 Nenaudokite garintuvo antgalio nukreipę jį žemyn.

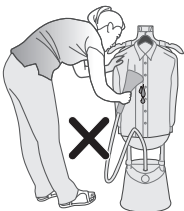

5 Garindami drabužį nesulenkite žarnos.

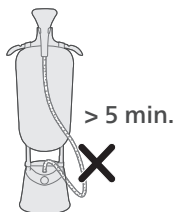

6 Nepalikite pastatomo garintuvo be priežiūros ilgiau nei 5 min.

Prietaiso nustatymas

STE1010

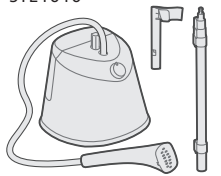

1 Atkreipkite dėmesį į įsigyto prietaiso dalis.

STE1020, STE1030
STE1040



STE1010

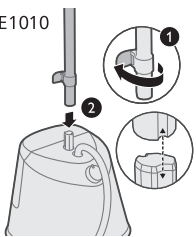

2 Atfiksukite apatinio rėmo fiksatorius ir įstatykite rėmą (-us) į pagrindą. Įsitinkinkite, kad rėmo (-ų) ir pagrindo rėmo (-ų) profiliai yra sulygiuoti.

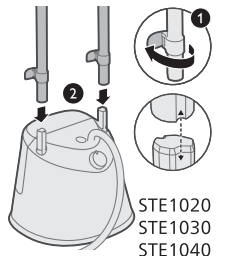

STE1020
STE1030
STE1040

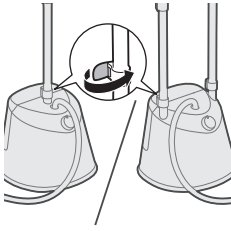

3 Užfiksuokite apatinio rėmo fiksiatorių (-ius).

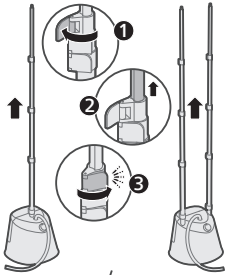

4 Atfiksuokite likusius rėmo fiksiatorius, iki galo ištraukite rėmą (-us) į viršų ir užfiksuokite.

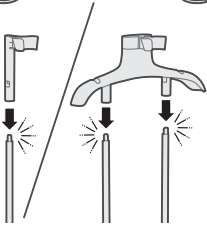

5 Įstatykite garintuvo stovą į rėmą (-us) taip, kad užsifikuotų (išgirsite spragtelėjimą).

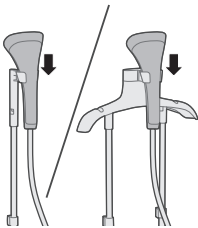

6 Padėkite garintuvo antgalį ant garintuvo stovo.

Lentos nustatymas

1 Atkreipkite dėmesį į įsigyto prietaiso dalis.

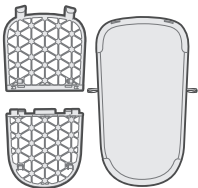

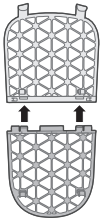

2 Sulygiuokite ir įstatykite lentos fiksatorius taip, kad užsifikuotų (išgirsite spragtelėjimą).

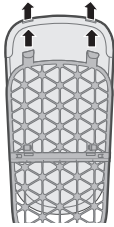

3 Sulygiuokite ir uždenkite lentą dangą, prakišdami ją pro lentos kabliukus.

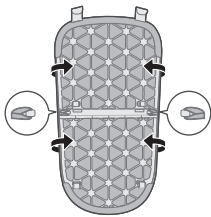

4 Užkabinkite lentos dangos dirželius ant lentos gale esančių kabliukų.

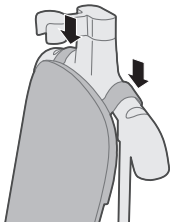

5 Uždėkite lentą ant pakabo.

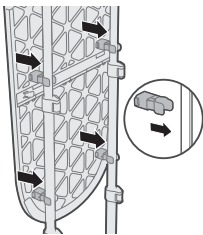

6 Pritvirtinkite lentą prie rėmų taip, kad užsifikuotų (išgirsite spragtelėjimą).

7 Galite pakabinti drabužius ant pakabo.

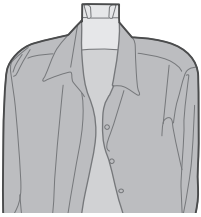
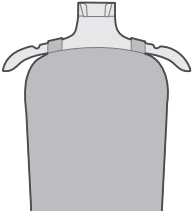

8 Galite naudoti savo pakabą ir pakabinti jį ant garintuvo stovo.

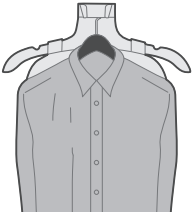

Patiesalo tiesimas

1 Prakiškite vidurinį dirželį per garintuvo stovą.

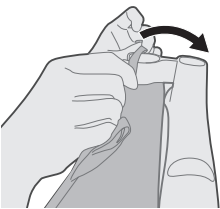

2 Pritvirtinkite 3 dirželius prie kabliuko, esančio pakabo gale.

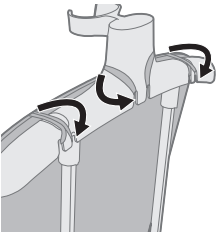

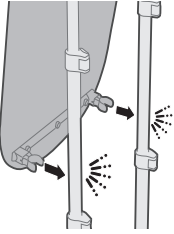

3 Pritvirtinkite paklotą prie rėmų taip, kad užsifikuotų (išgirsite spragtelėjimą).

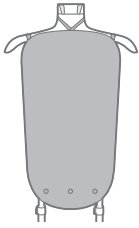

4 Galite pakabinti drabužius ant pakabo.



5 Galite naudoti savo pakabą ir pakabinti jį ant garintuvo stovo.

Šepečio įdėjimas

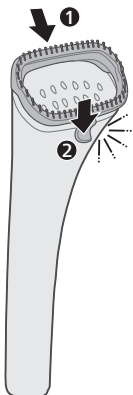

1 Sulygiuokite bėgelį išilgai garintuvo antgalio viršaus ir užspauskite fiksatorių apačioje (išgirsite spragtelėjimą).

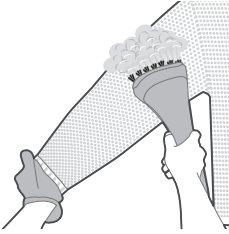

2 Galite garinti drabužius mūvėdami pirštines ir naudodami šepetį.

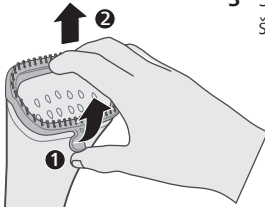

3 Suimkite ir ištraukite fiksatorių iš garintuvo antgalio apačios, kad nuimtumėte šepetį.

Vandens bakelio pripildymas

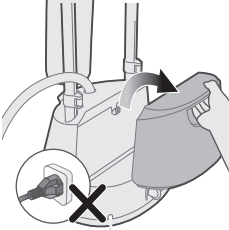

1 Neprijunkite prietaiso prie elektros lizdo. Ištraukite vandens bakelį iš pagrindo.

2 Apverskite vandens bakelį taip, kad jo dangtelis būtų nukreiptas į viršų.

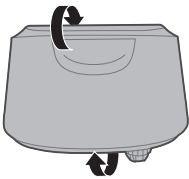

3 Atsukite vandens bakelio dangtelį prieš laikrodžio rodyklę, kad jį nuimtumėte.

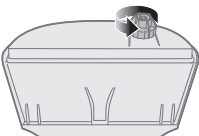

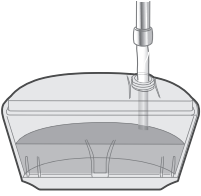

4 Pripildykite vandens bakelį.

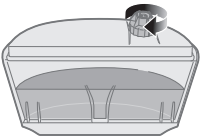

5 Užsukite vandens bakelio dangtelį pagal laikrodžio rodyklę.

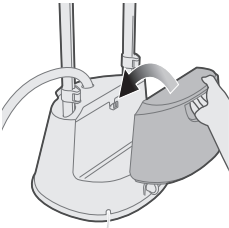

6 Sulygiuokite su kabliuku, kad galėtumėte įdėti vandens bakelį atgal į pagrindą.

Garų nustatymų keitimas

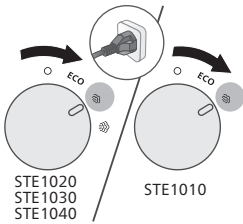

1 Įsitikinkite, kad prietaisas prijungtas prie elektros tinklo. Pasukite garų reguliavimo ratuką į norimą padėtį.

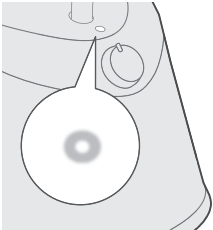

2 Lemputė pradės nuolat šviesti. Tai reiškia, kad pastatomas garintuvas yra ĮJUNGTAS.

*STE1010/75: ~2 min

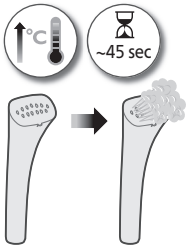

- 3 Palaukite apie 45 sek., kol pastatomas garintuvas įkails ir pradės skleisti garus (STE1010/75: apie 2 min.).

Patarimai lyginant

- 1 Galite naudoti savo pakabą ir pakabinti jį ant garintuvo stovo.

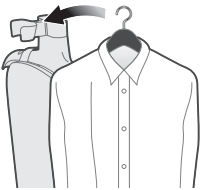

- 2 Braukite garintuvo antgaliu lygiagrečiai apykaklei kryptimi.

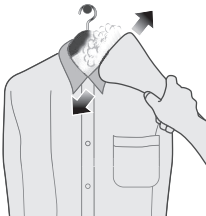

- 3 Braukite garintuvo antgaliu horizontalia papetei kryptimi.



- 4 Išštempkite drabužį. Braukite garintuvo antgaliu žemyn korpuso priekyje.

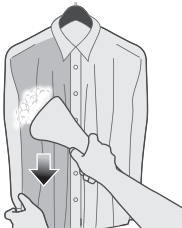



5 Braukite garintuvo antgaliu vertikaliai ant kišenės.

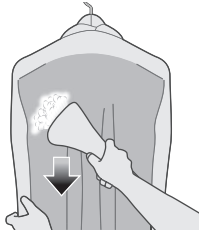

6 Ištempkite drabužį. Braukite garintuvo antgaliu žemyn korpuso užpakalinėje pusėje.

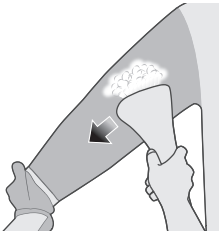

7 Ištempkite drabužį. Braukite garintuvo antgaliu lygiagrečiai rankovei kryptimi.

Valymas ir priežiūra

Kalkių nuosėdų kolektorius

Jūsų prietaise yra kalkių nuosėdų kolektoriaus sistema. Šalinti kalkes rekomenduojama kartą per mėnesį ar dažniau. Tokiu būdu palaikomas efektyvus garų veikimas ir laikui bėgant apsaugoma nuo nešvarumų ir dėmių atsiradimo ant lygintuvo pado.

Patarimas. Kalkių nuosėdų kolektoriaus sistemą galima naudoti bet kada. Jei gyvenate vietovėje, kurioje vanduo yra kietas, naudokite šią funkciją dažniau.

Kalkių nuosėdų valymas

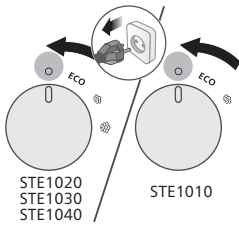

- 1 Įsitinkinkite, kad garų reguliavimo ratukas yra IŠJUNGTOJE padėtyje, o prietaisas – atjungtas nuo elektros lizdo.



- 2 Įsitinkinkite, kad lygintuvas visiškai atvėso (> 1 val.).

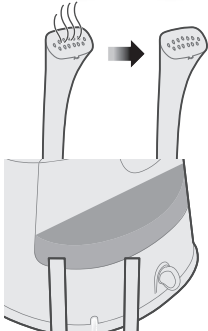

- 3 Padėkite garintuvą arti išpylimo vietos.

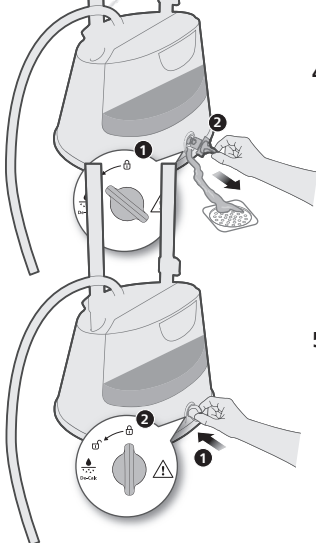

- 4 Pasukite kalkių šalinimo rankenėlę į atfiksuoatą padėtį ir ją ištraukite. Leiskite vandeniui išbėgti.

- 5 Įdėkite kalkių šalinimo rankenėlę ir pasukite ją į užrakinimo padėtį.

Pastatomo garintuvo valymas ir laikymas

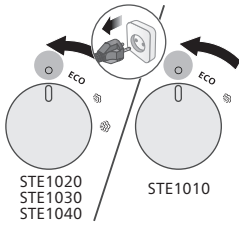

1 Įsitikinkite, kad garų reguliavimo ratukas yra IŠJUNGTOJE padėtyje, o prietaisas – atjungtas nuo elektros lizdo.

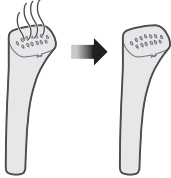

2 Įsitikinkite, kad lygintuvus visiškai atvėso (> 1 val.).

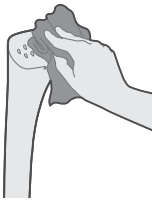

3 Garų išleidimo vietą nušluostykite drėgna šluoste.

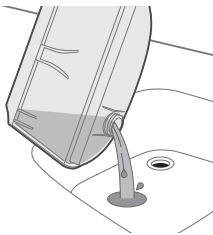

4 Visiškai ištuštinkite vandens bakelį.

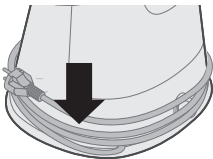

5 Apvyniokite maitinimo laidą aplink pagrindą.

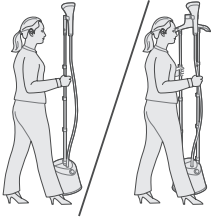

6 Pastatomą garintuvą galite nešti laikydami už rėmo.

Trikčių diagnostika

Šiame skyriuje trumpai aprašomos dažniausios problemos, kurios kyla naudojant šį prietaisą. Jei toliau pateikta informacija nepadeda išspręsti problemos, apsilankykite adresu www.philips.com/support, ten rasite dažnai užduodamų klausimų sąrašą, arba kreipkitės į savo šalies klientų aptarnavimo centrą.

Problema	Galima priežastis	Sprendimas
Prietaisas negeneruoja garų arba jų srautas nepastovus.	Garintuvus nepakankamai įkaitęs.	Palaukite maždaug 45 sek., kol prietaisas įkais (STE1010/75: apie 2 min.).
	Žarnoje susikaupė garų kondensato.	Pakelkite garintuvo antgalį, kad žarną ištiesintumėte vertikaliai. Taip susikaupęs kondensatas nutekės atgal.
	Mažai vandens bakelyje arba bakelis netinkamai įdėtas.	Pripildykite bakelį vandens ir tinkamai jį įdėkite.
	Prietaise susikaupė per daug kalkių nuosėdų.	Pašalinkite kalkių nuosėdas. Skaitykite skyrių apie kalkių nuosėdų šalinimą.
Iš garintuvo antgalio laša vanduo arba prietaisas skleidžia kvarkimo garsą.	Garintuvo antgalį ir (arba) garų tiekimo žarną ilgai laikėte horizontalioje padėtyje.	Pakelkite garintuvo antgalį, kad žarną ištiesintumėte vertikaliai. Taip susikaupęs kondensatas nutekės atgal.
	Jei žarna sulenкта „U“ raidės forma, joje susidaręs kondensatas negali nutekėti atgal į vandens bakelį.	Pakelkite garintuvo antgalį, kad žarną ištiesintumėte vertikaliai. Taip susikaupęs kondensatas nutekės atgal.

224 Lietuviškai

Kai prietaisas kaista, per garintuvo antgalį teka daug vandens.

Prietaise esantis vanduo yra nešvarus arba vanduo buvo ilgai laikomas prietaiso viduje.

Pašalinkite kalkių nuosėdas. Skaitykite skyrių apie kalkių nuosėdų šalinimą.

Vanduo teka per garintuvo pagrindą.

Tinkamai neuždarėte vandens bakelio dangtelio arba kalkių nuosėdų šalinimo rankenėlės. Netinkamai įstatytas vandens bakelis.

Sandariai uždarykite vandens bakelio dangtelį arba kalkių nuosėdų šalinimo rankenėlę. Tinkamai įdėkite bakelį.

Bevezetés

A Philips köszönti Önt! Gratulálunk a vásárláshoz! A Philips által biztosított teljes körű támogatáshoz regisztrálja termékét a www.philips.com/welcome oldalon. Kérjük, a készülék használata előtt figyelmesen olvassa el ezt a felhasználói kézikönyvet, a Fontos tudnivalók című ismertetőt és a rövid üzembe helyezési útmutatót. Őrizze meg őket későbbi használatra.

A termék rövid bemutatása

STE1020, STE1030, STE1040

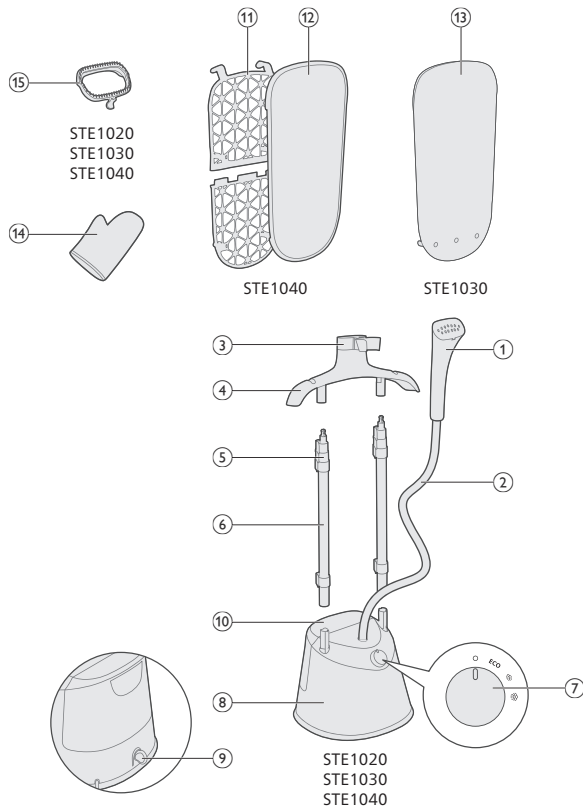

STE1010

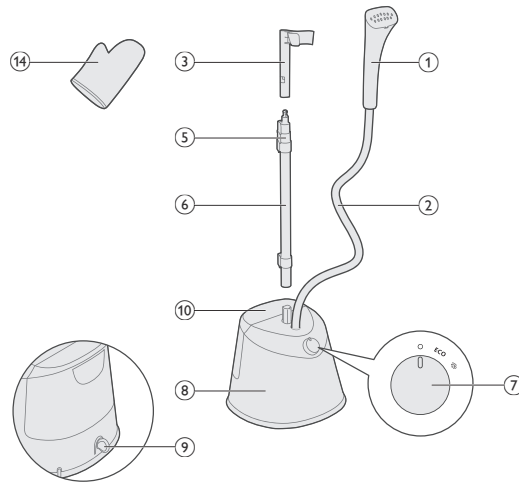

- 1 Gőzölőfej
- 2 Gőzadagoló tömlő
- 3 Gőzölődokkoló
- 4 Vállfa (STE1020, STE1030, STE1040)
- 5 Rúdzáró kapocs
- 6 Rúd
- 7 Gőzszabályozó tárcsa
- 8 Talpazat
- 9 Vízkőmentesítő gomb
- 10 Víztartály
- 11 Vasalódeszka (STE1040)
- 12 Huzat (STE1040)
- 13 Alátét (STE1030)
- 14 Kesztyű
- 15 Kefe (STE1020, STE1030, STE1040)

Előkészítés a használatra

A használandó víz típusa

A készüléket csapvízzel való használatra tervezték. Ha azonban kemény vizet tartalmazó területen él, javasoljuk, hogy a csapvízhez adjon azonos mennyiségű desztillált vagy ioncserélt vizet. Ez megakadályozza a gyors vízkőlerakódást, és meghosszabbítja a készülék élettartamát.

Ne adjon hozzá parfümöt, szárítógépből származó vizet, ecetet, keményítőt, vízkőmentesítő szert, vasalási segédanyagokat, vegyileg vízkőmentesített vizet és más vegyi anyagokat, mivel ezek vízszivárgáshoz, barna foltok képződéséhez, illetve a készülék károsodásához vezethetnek.

Figyelmeztetés

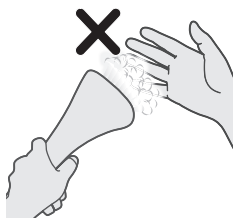

1 Bőrének semmilyen része ne kerüljön közvetlen kapcsolatba a gőzzel.



2 Ne irányítsa a gőzölőfejet más személyek felé.

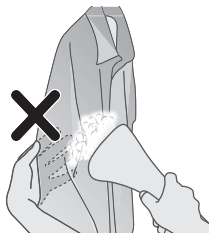

3 Ne tartsa úgy a ruhadarabot, hogy az közvetlenül érintkezzen a gőzzel.

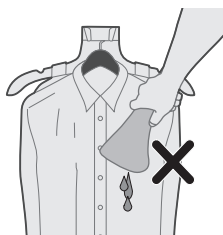

4 A gőzölőfejet használatkor ne fordítsa lefelé.

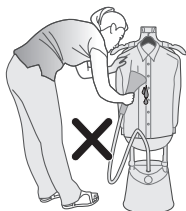

5 Ruhadarab gőzölésekor ne hajlítsa meg a tömlőt.

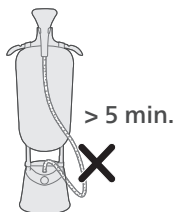

6 Az álló gőzölőt ne hagyja 5 percnél hosszabb ideig felügyelet nélkül.

A készülék összeszerelése

STE1010

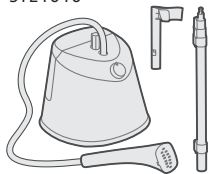

1 Tekintse át a megvásárolt készülék részeit.

STE1020, STE1030
STE1040



STE1010

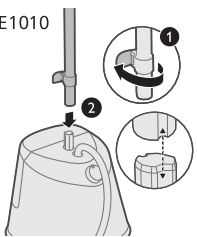

2 Oldja ki az alsó rúd zárókapcsait, és helyezze a rudakat a talapzatra. Ügyeljen arra, hogy a rudak és a talpzat csapjai egy vonalban legyenek.

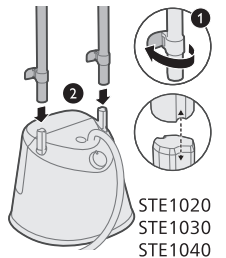

STE1020
STE1030
STE1040

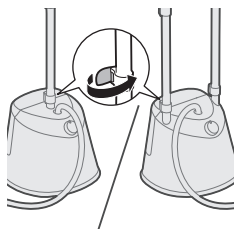

3 Reteszelve az alsó rúd zárókapcsait.

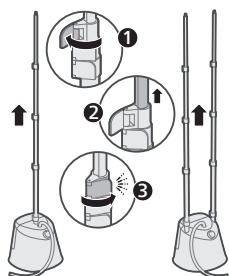

4 Oldja ki a másik rúd zárókapcsait, húzza ki teljesen a rudat, majd rögzítse.

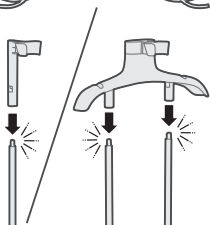

5 Helyezze a gőzlődokkolót a rudakra, amíg az a helyén nem rögzül („bekattan”).

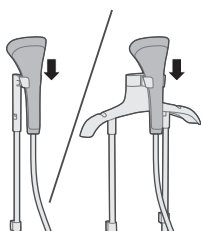

6 Helyezze a gőzlőfejet a gőzlődokkolóra.

A vasalódeszka összeszerelése

1 Tekintse át a megvásárolt készülék részeit.

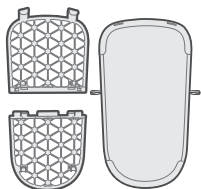

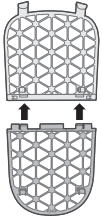

2 Igazítsa egymáshoz a vasalódeszka kapcsait, majd illessze össze a két részt (amíg „bekattannak”).

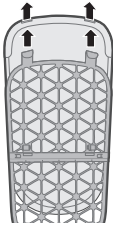

3 Az akasztókon keresztül helyezze fel a huzatot.

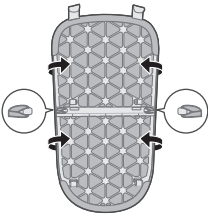

4 A huzat pántjait rögzítse a vasalódeszka hátulján lévő fülekhez.

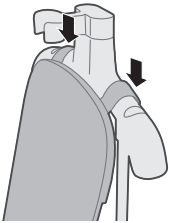

5 Helyezze a vasalódeszkát a vállfára.

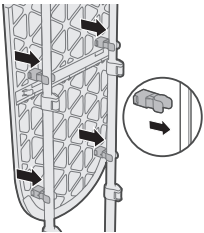

6 Rögzítse a vasalódeszkát a rudakhoz (amíg „bekattan”).

7 A vállfa segítségével kivasalhatja a ruháit.

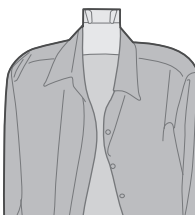

8 Használhatja saját vállfáját is, amit a gőzölődokkolóra akaszthat.

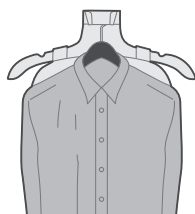

Az alátét felhelyezése

1 Bújtassa át a középső pántot a gőzölődokkolón.

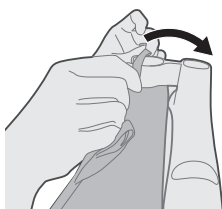

2 Rögzítse a 3 pántot a vállfa hátulján lévő fülekhez.

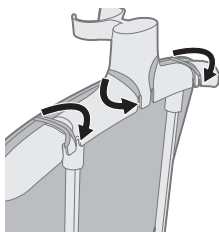

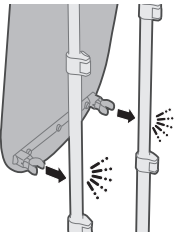

3 Rögzítse az alátétet a rudakhoz (amíg „bekattan”).

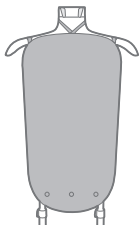

4 A vállfa segítségével kivasalhatja a ruháit.



5 Használhatja saját vállfáját is, amit a gőzölődokkolóra akaszthat.



A kefe felhelyezése

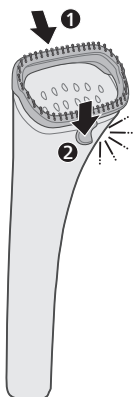

1 Igazítsa a sít a gőzölőfej tetejéhez, majd pattintsa be a kefe alján lévő reteszt (amíg „bekattan”).

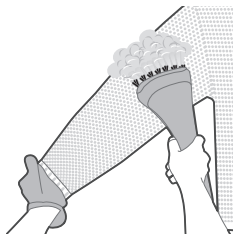

2 A kesztyűt viselve a kefetartozékkal átgőzölheti a ruháit.

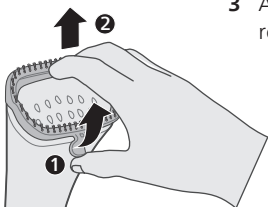

3 A kefetartozék eltávolításához fogja meg és húzza ki a gőzölőfej alján lévő reteszt.

A víztartály feltöltése

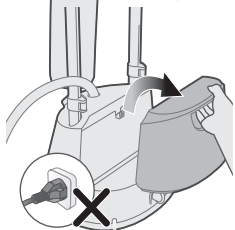

1 A készülék ne csatlakozzon a hálózati áramforráshoz. Távolítsa el a víztartályt a talapzatról.

2 Fordítsa meg a víztartályt úgy, hogy a víztartály kupakja felfelé nézzen.

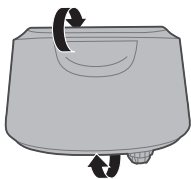

3 Az óramutató járásával ellentétes irányban csavarja le a víztartály kupakját.

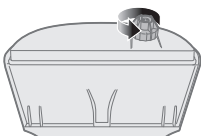

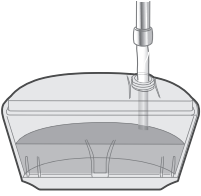

4 Töltse fel a víztartályt.

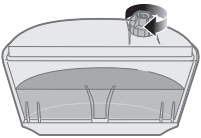

5 Az óramutató járásával megegyező irányban csavarja be a víztartály kupakját.

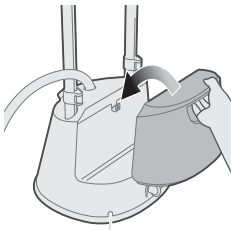

6 A víztartály visszahelyezésekor igazítsa azt a talapzaton lévő fülhöz.

Gőzbeállítás módosítása

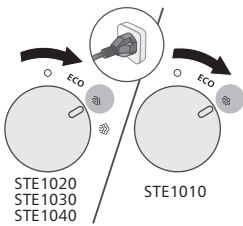

1 Győződjön meg róla, hogy a készülék csatlakoztatva van a hálózati áramforráshoz. Forgassa el a gőztárcsát a kívánt gőzbeállításra.

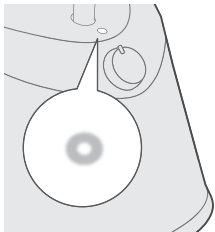

2 A jelzőlámpa folyamatosan világít, jelezve, hogy az álló gőzölő be van kapcsolva.

*STE1010/75: ~2 min

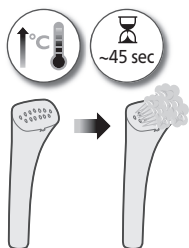

- 3 Várjon körülbelül 45 másodpercet, amíg az álló gőzlő felmelegszik és gőzt bocsát ki (STE1010/75: kb. 2 perc).

Vasalási tippek

- 1 Használhatja saját vállfáját is, amit a gőzlődokkolóra akaszthat.

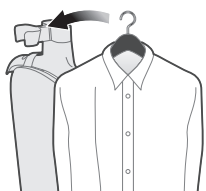

- 2 A gallérnál a gőzlőfejet azzal párhuzamosan mozgassa.

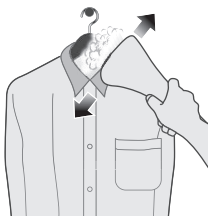

- 3 A hát felső részén a gőzlőfejet vízszintes irányba mozgassa.

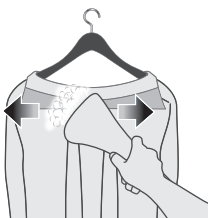

- 4 Feszítse ki a ruhadarabot. Az elülső részén a gőzlőfejet lefelé mozgassa.

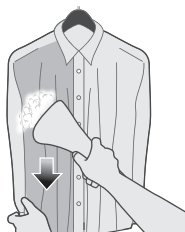



5 A zsebnél a gőzlőfejet felfelé mozgassa.



6 Feszítse ki a ruhadarabot. A háti részén a gőzlőfejet lefelé mozgassa.

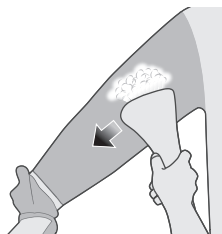

7 Feszítse ki a ruhadarabot. Az ujjnál a gőzlőfejet azzal párhuzamosan mozgassa.

Tisztítás és karbantartás

Vízkögyűjtő

A készülék vízkögyűjtő rendszerrel rendelkezik. Legalább havonta egyszer ajánlott a készülék vízkömentesítését elvégezni. Ez elősegíti az erőteljes gőzlési teljesítmény fenntartását és megakadályozza, hogy idővel szennyeződés távozzon a vasalótálpból.

Tipp: A vízkögyűjtő rendszer bármikor használható. Ha kemény víz jellemezte területen él, használja gyakrabban a funkciót.

Vízkömentesítés végrehajtása

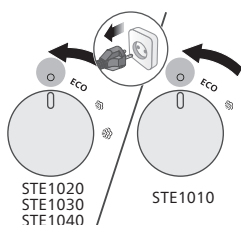

- 1 Győződjön meg arról, hogy a gőzszabályzó tárcsa OFF (Ki) állásban van, és a készülék le van választva a hálózati áramforrásról.



- 2 Győződjön meg arról, hogy a gőzlőfej teljesen lehűlt (>1 óra).

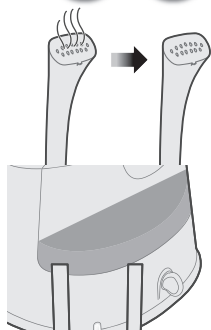

- 3 Helyezze a gőzlőt egy lefolyó közelébe.

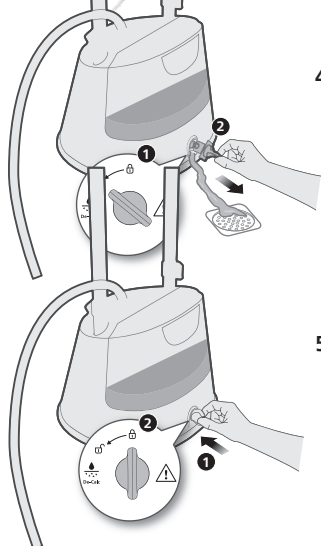

- 4 Fordítsa a vízkömentesítő gombot nyitott állásba, majd távolítsa el. Hagyja a vizet kifolyni.

- 5 Helyezze be, és elfordítva rögzítse a vízkömentesítő gombot.

Az álló gőzölő tisztítása és tárolása

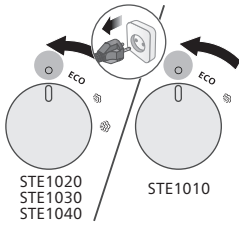

- 1 Győződjön meg arról, hogy a gőzszabályzó tárcsa OFF állásban van, és a készülék le van választva a hálózati áramforrásról.

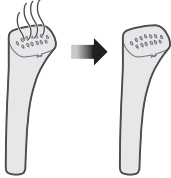

- 2 Győződjön meg arról, hogy a gőzölőfej teljesen lehűlt (>1 óra).

- 3 Nedves ruhával törölje le a gőzölőfejet.

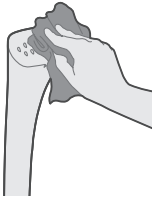

- 4 Ürítse ki teljesen a víztartályt.

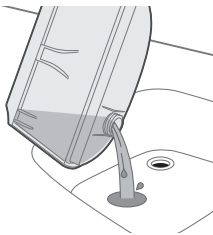

- 5 Tekerje a tápkábelt a talapzat köré.

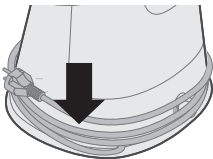

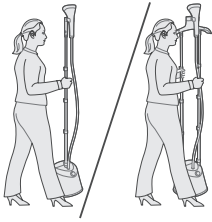

6 Az álló gőzölőt a rúdnál fogva hordozhatja.

Hibaelhárítás

Ez a fejezet részletesen foglalkozik a készülékkel kapcsolatban leggyakrabban felmerülő problémákkal. Ha az alábbi útmutató segítségével nem tudja elhárítani a hibát, látogasson el a www.philips.com/support weboldalra a gyakran ismétlődő kérdések listájáért, vagy forduljon az országában illetékes vevőszolgálathoz.

Probléma	Lehetséges ok	Megoldás
A készülékből nem jön gőz, vagy a gőz egyenetlen.	A készülék nem melegedett fel kellő mértékben.	Körülbelül 45 másodpercig hagyja a készüléket felmelegedni (STE1010/75: kb. 2 perc).
	A gőz lecsapódott a csőben.	Emelje fel a gőzölőfejet, hogy a cső függőleges helyzetbe kerüljön. Ekkor a lecsapódott víz visszafolyik.
	Alacsony a víz szintje a tartályban, vagy a tartály nincs megfelelően behelyezve.	Töltse meg, majd helyezze vissza megfelelően a víztartályt.
	Túl sok vízkő halmozódott fel a készülékben.	Végezze el a vízkő-mentesítési folyamatot. Lásd a vízkőmentesítésről szóló részt.
A gőzölőfejből víz csöpög, vagy a készülék szörccsögő hangot ad.	A gőzölőfej és/vagy a gőzellátó cső túl sokáig volt vízszintes helyzetben.	Emelje fel a gőzölőfejet, hogy a cső függőleges helyzetbe kerüljön. Ekkor a lecsapódott víz visszafolyik.
	Ha a cső U alakot vesz fel, a benne lecsapódó víz nem tud visszafolyni a víztartályba.	Emelje fel a gőzölőfejet, hogy a cső függőleges helyzetbe kerüljön. Ekkor a lecsapódott víz visszafolyik.

240 Magyar

A készülék melegedése közben sok víz távozik a gőzölőfejből.

A készülékben lévő víz szennyezett, vagy túl sok ideig volt a készülékben.

Végezze el a vízkő-mentesítési folyamatot. Lásd a vízkőmentesítésről szóló részt.

A készülék talpazatából víz szivárog.

Nem megfelelően zárta le a víztartály fedelét vagy a vízkőmentesítő gombját. A víztartály nem megfelelően van a gőzfejlesztőbe helyezve.

Zárja le a víztartály fedelét vagy a vízkőmentesítő gombját. Helyezze be megfelelően a tartályt.

Introductie

Gefeliciteerd met uw aankoop en welkom bij Philips! Registreer uw product op www.philips.com/welcome om optimaal gebruik te kunnen maken van de door Philips geboden ondersteuning. Lees deze gebruiksaanwijzing, het boekje met belangrijke informatie en de snelstartgids zorgvuldig door voor u het apparaat gebruikt. Bewaar ze om deze indien nodig later te kunnen raadplegen.

Productoverzicht

STE1020, STE1030, STE1040

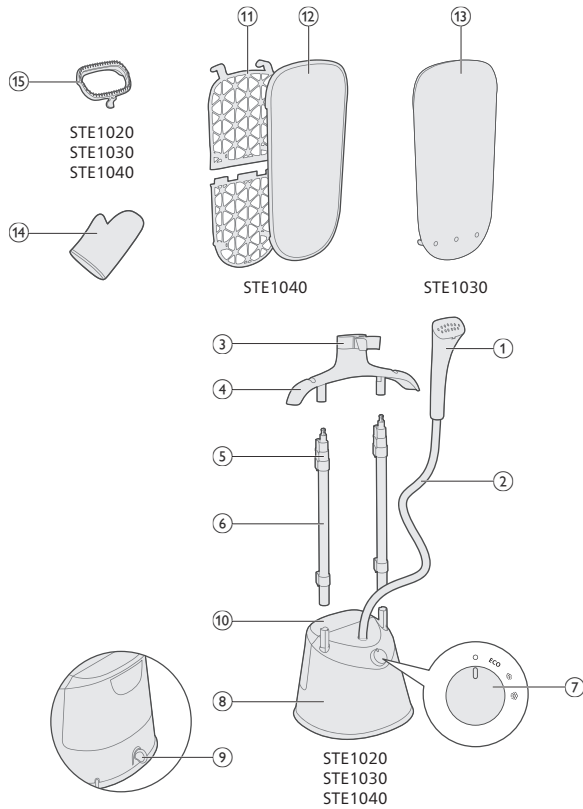

STE1010

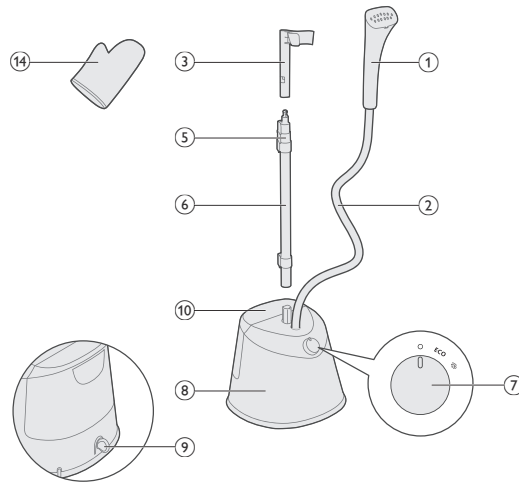

- 1 Stoomkop
- 2 Stoomtoevoerslang
- 3 Stomervoet
- 4 Hanger (STE1020, STE1030, STE1040)
- 5 Stangvergrendelingsklem
- 6 Stang
- 7 Stoomregelaar
- 8 Voet
- 9 De-calc-knop
- 10 Waterreservoir
- 11 Plank (STE1040)
- 12 Hoos (STE1040)
- 13 Mat (STE1030)
- 14 Handschoen
- 15 Borstel (STE1020, STE1030, STE1040)

Klaarmaken voor gebruik

Te gebruiken watersoort

Het apparaat is geschikt voor gebruik met kraanwater. Als u echter in een gebied met hard water woont, raden wij u aan kraanwater te mengen met een gelijke hoeveelheid gedestilleerd of gedemineraliseerd water. Dit voorkomt snelle vorming van kalkaanslag en verlengt de levensduur van het apparaat.

Voeg geen parfum, water uit de wasdroger, azijn, stijfsel, ontkalkingsmiddelen, strijkconcentraat, chemisch ontkalkt water of andere chemicaliën toe. Hierdoor kan het apparaat water gaan spetteren, bruine vlekken veroorzaken of beschadigd raken.

Waarschuwingen

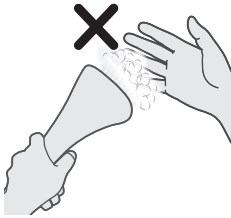

1 Breng geen enkel deel van de huid in direct contact met de stoom.



2 Richt de stoomplaat niet op andere personen.

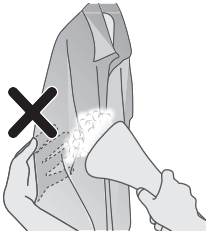

3 Houd uw kledingstuk niet zo vast dat het in direct contact komt met de stoom.

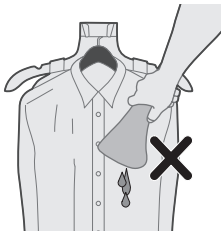

4 Gebruik de stoomkop niet in neerwaartse richting.

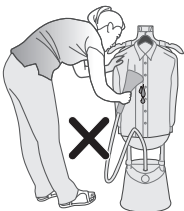

5 Buig de slang niet om het kledingstuk te stomen.

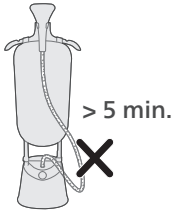

6 Laat de stomer met standaard niet langer dan 5 minuten onbeheerd achter.

Het apparaat in elkaar zetten

STE1010

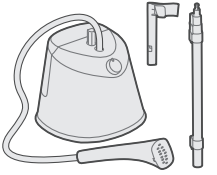

1 Controleer de beschikbare onderdelen voor uw gekochte apparaat.

STE1020, STE1030
STE1040



STE1010

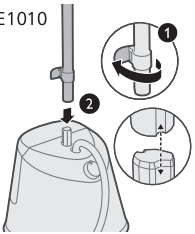

2 Ontgrendel de vergrendelklemmen van de onderste stang en plaats de stang(en) op de voet. Zorg ervoor dat de profielen van de stang(en) en de stangbout(en) van de voet uitgelijnd zijn.

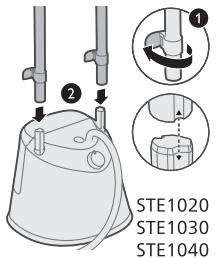

STE1020
STE1030
STE1040

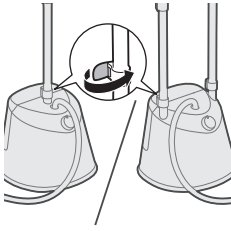

3 Vergrendel de vergrendelklem(men) van de onderste stang.

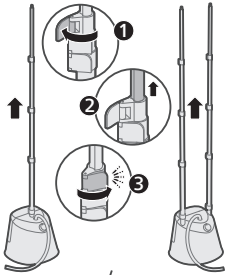

4 Ontgrendel de resterende vergrendelklemmen, schuif de stang(en) volledig omhoog en vergrendel deze.

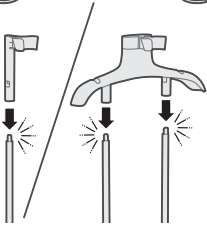

5 Plaats de stomervoet op de stang(en) totdat deze vastklikt ('klik').

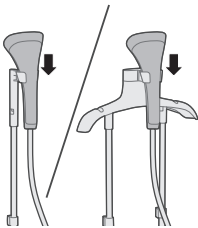

6 Plaats de stoomkop op de stomervoet.

De plank in elkaar zetten

1 Controleer de beschikbare onderdelen voor uw gekochte apparaat.

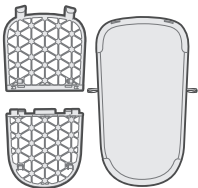

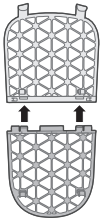

2 Lijn de klemmen uit en plaats ze tot deze vastklikken ('klik').

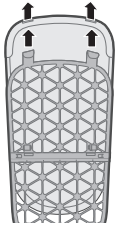

3 Lijn de hoes uit en steek hem door de haken van de plank.

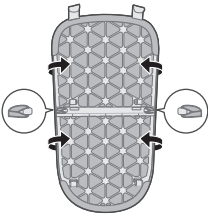

4 Maak de banden van de hoes vast aan de haken aan de achterkant van de plank.

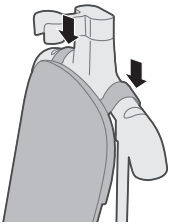

5 Plaats de plank op de hanger.

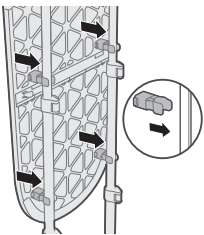

6 Plaats de plank op de stangen totdat deze vastklikt ('klik').

7 U kunt uw kleding draperen met behulp van de hanger.

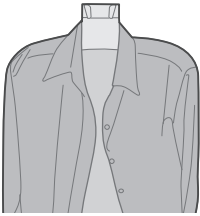
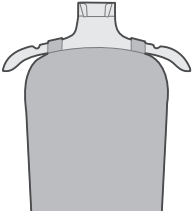

8 U kunt uw eigen kleeerhanger gebruiken en deze op de stomervoet plaatsen.

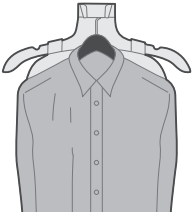

De mat plaatsen

1 Steek de middelste band door de stomervoet.

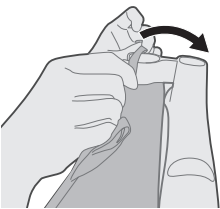

2 Bevestig de 3 banden aan de haak aan de achterkant van de hanger.

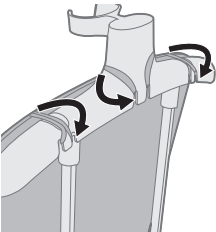

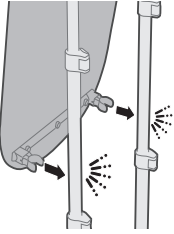

3 Bevestig de mat aan de stangen totdat deze vastklikt ('klik').

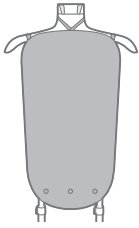

4 U kunt uw kleding draperen met behulp van de hanger.



5 U kunt uw eigen klerhanger gebruiken en deze op de stomervoet plaatsen.



De borstel plaatsen

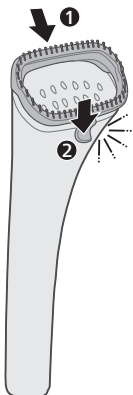

1 Lijn de baan uit langs de bovenkant van de stoomkop en klik de vergrendeling aan de onderkant vast ('klik').

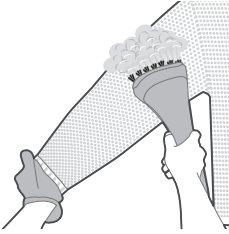

2 U kunt de handschoen dragen en uw kleding stomen met de opzetborstel.

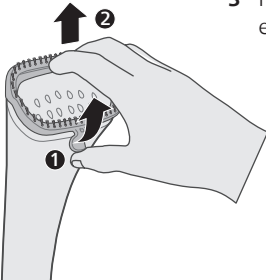

3 Pak de vergrendeling aan de onderkant van de stoomkop vast en trek deze eruit om de opzetborstel te verwijderen.

Het waterreservoir vullen

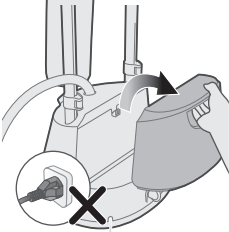

1 Laat het apparaat niet aan staan. Verwijder het waterreservoir van de voet.

2 Kantel het waterreservoir met de dop naar boven.

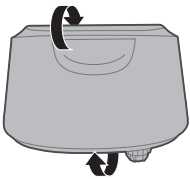

3 Draai de dop van het waterreservoir tegen de klok in los om het reservoir te verwijderen.

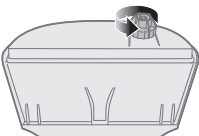

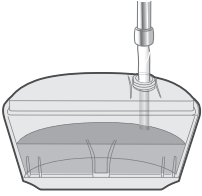

4 Vul het waterreservoir.

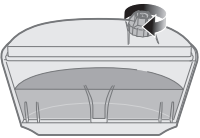

5 Draai de dop van het waterreservoir met de klok mee dicht.

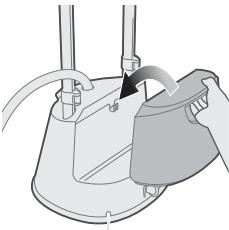

6 Lijn uit met de haak om het waterreservoir terug te plaatsen op de voet.

De stoominstellingen wijzigen

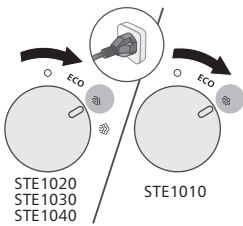

1 Zorg ervoor dat de stekker in het stopcontact zit. Draai de stoomregelaar naar de gewenste stoomstand.

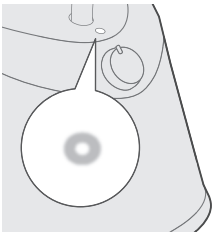

2 Het lampje gaat branden om aan te geven dat de stomer is ingeschakeld.

*STE1010/75: ~2 min

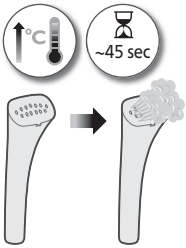

- 3 Wacht ongeveer 45 seconden tot de stomer is opgewarmd en stoom afgeeft (STE1010/75: ongeveer 2 minuten).

Tips voor het strijken

- 1 U kunt uw eigen kleerhanger gebruiken en deze op de stomervoet plaatsen.

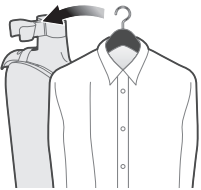

- 2 Beweeg de stoomkop in parallelle richting met de kraag.

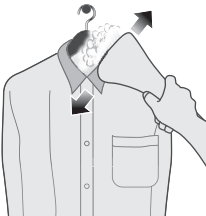

- 3 Beweeg de stoomkop in horizontale richting met het schouderstuk.



- 4 Rek het kledingstuk uit. Beweeg de stoomkop in een neerwaartse richting op de voorkant van het kledingstuk.

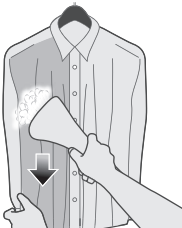



5 Beweeg de stoomkop in opwaartse richting op een zak.

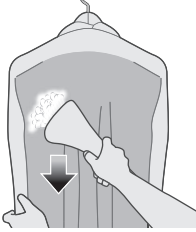

6 Rek het kledingstuk uit. Beweeg de stoomkop in neerwaartse richting op de achterkant van het kledingstuk.

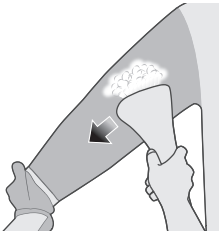

7 Rek het kledingstuk uit. Beweeg de stoomkop in een parallelle richting met de mouw.

Schoonmaken en onderhoud

Calc Collector

Uw apparaat is uitgerust met een Calc Collector-systeem. We raden u aan om het apparaat een of meerdere keren per maand te ontkalken. Hierdoor blijft het apparaat voldoende stoom leveren en voorkomt u dat de zoolplaat na verloop van tijd vuil en vlekken veroorzaakt.

Tip: U kunt het Calc Collector-systeem altijd gebruiken. Als u in een gebied met hard water woont, gebruik de functie dan vaker.

Het uitvoeren van de Calc-clean-procedure

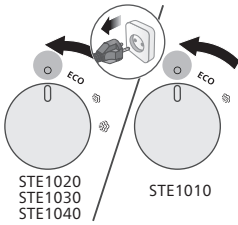

- 1 Zorg ervoor dat de stoomregelaar op OFF staat en haal de stekker uit het stopcontact.



- 2 Zorg ervoor dat het strijkijzer volledig is afgekoeld (> 1 uur).

- 3 Plaats de stomer dicht bij een afvoer.

- 4 Draai de De-calc-knop naar de ontgrendelingsstand en verwijder de De-calc-knop. Laat het water weglopen.

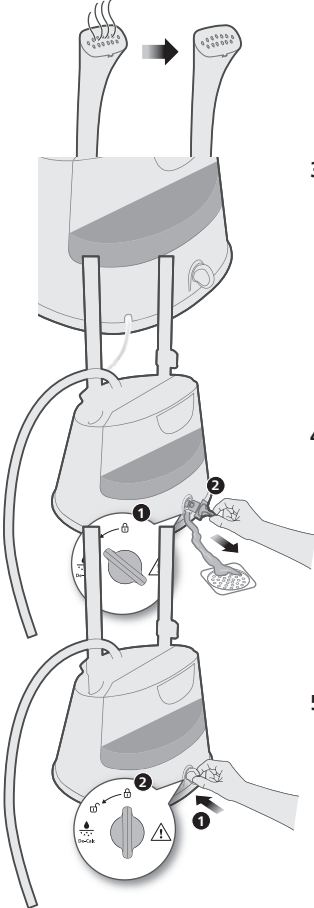

- 5 Plaats de De-calc-knop en draai deze in de vergrendelstand.

De stomer reinigen en opbergen

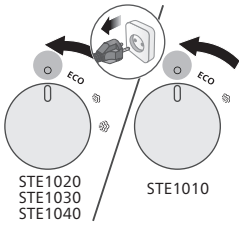

1 Zorg ervoor dat de stoomregelaar op OFF staat en haal de stekker uit het stopcontact.

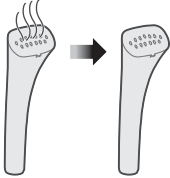

2 Zorg ervoor dat het strijkijzer volledig is afgekoeld (> 1 uur).

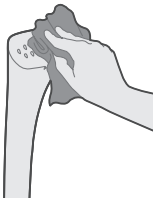

3 Veeg de stomer schoon met een vochtige doek.

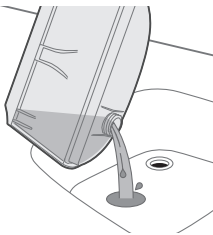

4 Leeg het waterreservoir.

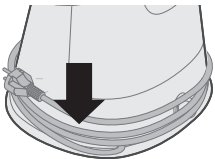

5 Wikkel het netsnoer rond de voet.

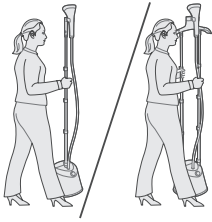

6 Je kunt de stomer aan de stang dragen.

Problemen oplossen

Dit hoofdstuk behandelt in het kort de problemen die u kunt tegenkomen tijdens het gebruik van uw apparaat. Als u het probleem niet met de onderstaande informatie kunt oplossen, gaat u naar www.philips.com/support voor een lijst met veelgestelde vragen of neemt u contact op met het Consumer Care Centre in uw land.

Probleem	Mogelijke oorzaak	Oplossing
Het apparaat produceert onregelmatige of geen stoom.	De stomer is niet voldoende opgewarmd.	Laat het apparaat ongeveer 45 seconden opwarmen (STE1010/75: ongeveer 2 minuten).
	Er is stoom in de slang gecondenseerd.	Til de stomer op om de slang verticaal recht te trekken. Hierdoor kan het condenswater terugstromen.
	Het waterniveau in het reservoir is laag of het reservoir is niet goed geplaatst.	Vul het waterreservoir en plaats het op de juiste manier.
Er lekken waterdruppels uit de stoomkop of het apparaat maakt een krassend geluid.	Er heeft zich te veel kalk opgebouwd in het apparaat.	Voer het ontkalkingsproces uit. Bekijk het gedeelte 'Calc-Clean'.
	U hebt de stoomkop en/of de stoomtoevoerslang lange tijd horizontaal laten liggen.	Til de stomer op om de slang verticaal recht te trekken. Hierdoor kan het condenswater terugstromen.
	Wanneer de slang een U-vorm heeft, kan de condens die zich in de slang bevindt, niet teruglopen in het waterreservoir.	Til de stomer op om de slang verticaal recht te trekken. Hierdoor kan het condenswater terugstromen.

256 Nederlands

Een grote hoeveelheid water druppelt uit de stoomkop wanneer het apparaat opwarmt.

Het water in het apparaat is vuil of heeft te lang in het apparaat gezeten.

Voer het ontkalkingsproces uit. Bekijk het gedeelte 'Calc-Clean'.

Er lekt water uit het voetstuk van de stomer.

U hebt de dop van het waterreservoir of de de-calc-knop niet goed gesloten. Het waterreservoir is niet goed geplaatst.

Sluit de dop van het waterreservoir of de de-calc-knop goed. Plaats het reservoir op de juiste manier.

Innledning

Gratulerer med kjøpet, og velkommen til Philips! Hvis du vil dra full nytte av brukerstøtten som Philips tilbyr, kan du registrere produktet ditt på www.philips.com/welcome. Les denne brukerhåndboken, det viktige informasjonsheftet og hurtigstartveiledningen nøye før du bruker apparatet. Ta vare på disse for fremtidig bruk.

Produktoversikt

STE1020, STE1030, STE1040

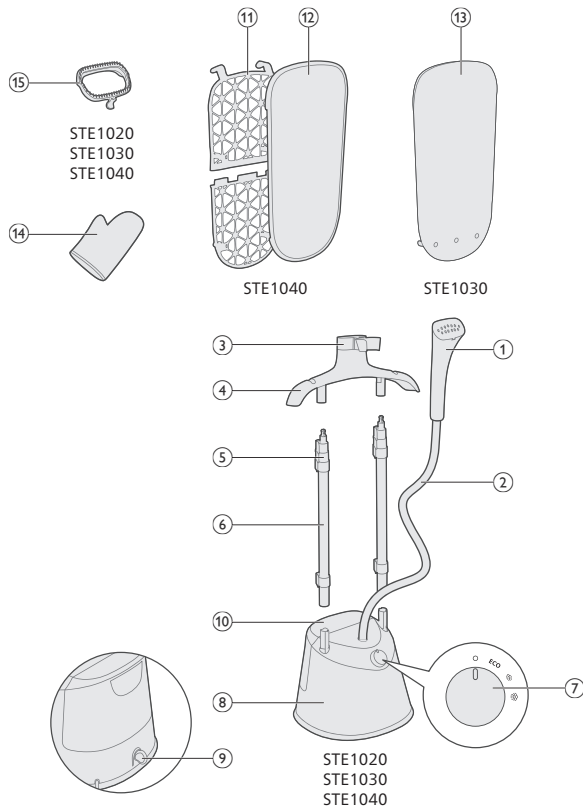

STE1010

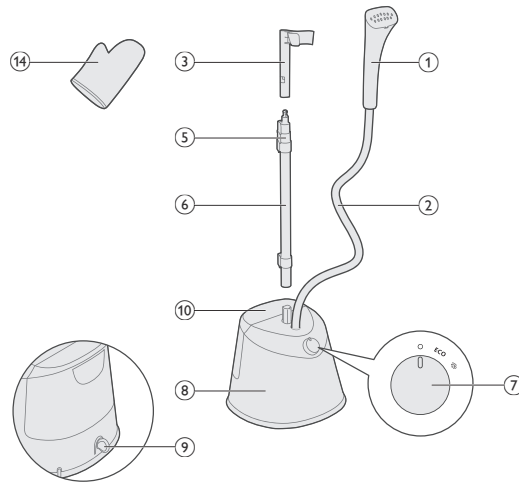

- 1 Damphode
- 2 Dampslange
- 3 Dampdokk
- 4 Kleshenger (STE1020, STE1030, STE1040)
- 5 Stangens låseklemme
- 6 Stang
- 7 Damphjul
- 8 Sokkel
- 9 De-calc-knott
- 10 Vannbeholder
- 11 Brett (STE1040)
- 12 Omslag (STE1040)
- 13 Matte (STE1030)
- 14 Hanske
- 15 Børste (STE1020, STE1030, STE1040)

Bruksforberedelse

Vanntypen som skal brukes

Dette apparatet egnet for bruk med springvann. Hvis du bor i et område med hardt vann, anbefaler vi at du blander en like stor mengde springvann med destillert eller demineralisert vann. Dette hindrer en rask dannelse av kalkavleiringer, mens apparatet får forlenget levetiden sin.

Ikke legg til parfyme, vann fra tørketrommelen, eddik, stivelse, avkalkingsmidler, strykemidler, kjemisk avkalket vann eller andre kjemikalier, siden dette kan føre til vannsprut, brune flekker eller skade på apparatet

Advarsler

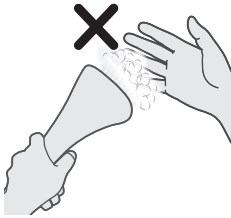

1 Ikke plasser noen del av huden i direkte kontakt med dampen.



2 Ikke rett dampplaten mot andre personer.

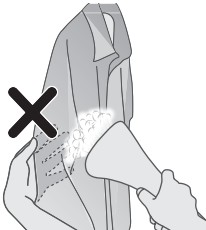

3 Ikke hold plagget på en måte som er i direkte kontakt med dampen.

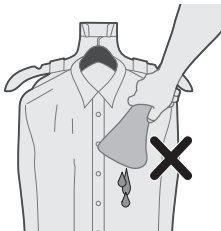

4 Ikke bruk damphodet i nedgående retning.

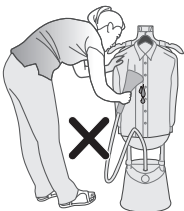

5 Ikke bøy slangen for å dampe plagget.

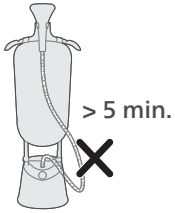

6 Ikke la dampenheten stå uten tilsyn i mer enn 5 minutter.

Oppsett av apparatet

STE1010

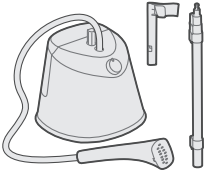

1 Legg merke til delene som er tilgjengelige for det kjøpte apparatet.

STE1020, STE1030
STE1040



STE1010

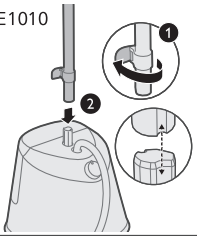

2 Lås opp den nederste stangens låseklemmer og sett stengene inn i sokkelen. Sørg for at profilene til stengene og sokkelboltene er i samsvar.

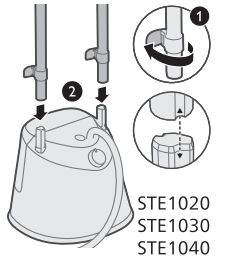

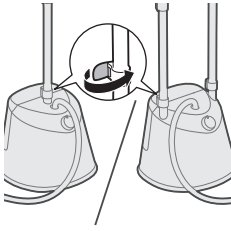

3 Lås låseklemmene nederst for stengene.

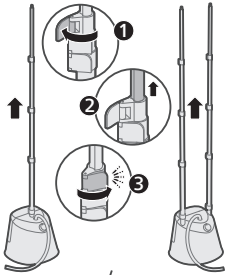

4 Lås opp de gjenværende låseklemmene for stengene, trekk helt ut stengene og lås dem.

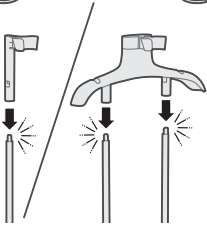

5 Sett dampdokken på stengene til den låses på plass (klikk).

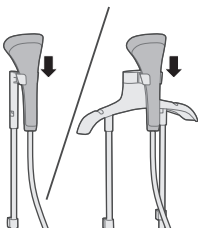

6 Plasser damphodet på dampdokken.

Oppsett av brett

1 Legg merke til delene som er tilgjengelige for det kjøpte apparatet.

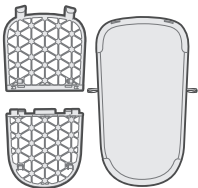

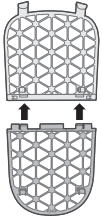

2 Juster og sett inn brettklammene til de låses på plass (klikk).

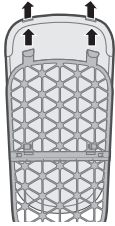

3 Juster og sett inn brettdekslet gjennom brettkrokene.

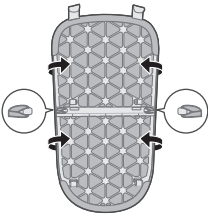

4 Fest brettdekselstroppene på krokene på baksiden av brettet

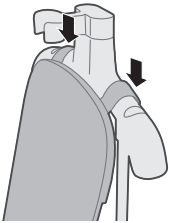

5 Plasser brettet på kleshengeren.

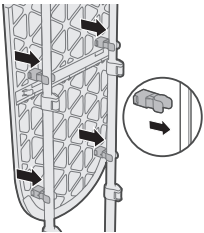

6 Fest brettet på stengene til det låses på plass (klikk).

7 Du kan henge klærne ved hjelp av kleshengeren.

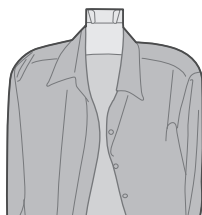
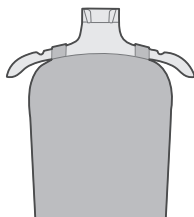

8 Du kan bruke din egen kleshenger og plassere den på dampdokken.

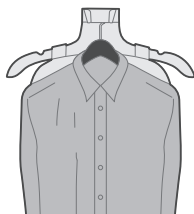

Oppsett av matten

1 Sett inn den midtre stroppen gjennom dampdokken.

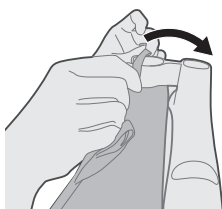

2 Fest de tre stroppene på kroken på baksiden av kleshengeren.

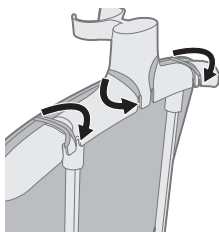

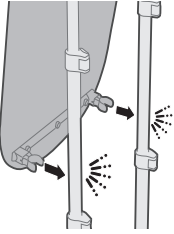

3 Fest matten på stengene til den låses på plass (klikk).

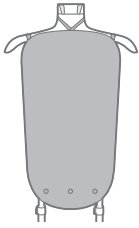

4 Du kan henge klærne ved hjelp av kleshengeren.



5 Du kan bruke din egen kleshenger og plassere den på dampdokken.

Sette inn børsten

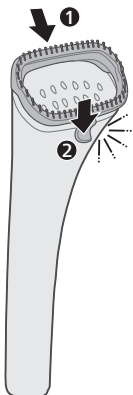

1 Juster sporet langs toppen av damphodet, og fest den på bunnen (klikk).

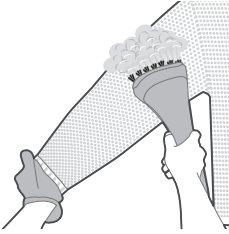

2 Du kan bruke hansken og dampe klærne med børstetilbehøret.

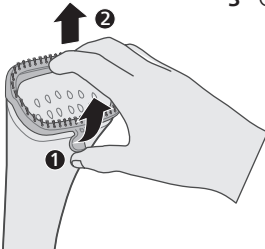

3 Grip og trekk ut låsen fra bunnen av damphodet for å fjerne børstetilbehøret.

Oppfylling av vannbeholderen

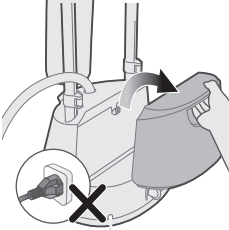

1 Ikke koble til apparatet. Fjern vannbeholderen fra sokkelen.

2 Vend vannbeholderen med vannbeholderlokket vendt oppover.

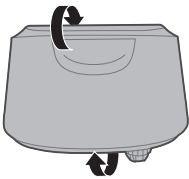

3 Skru av vannbeholderlokket mot klokken for å fjerne det.

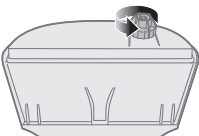

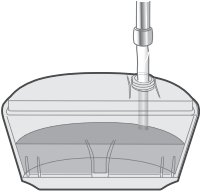

4 Fyll opp vannbeholderen.

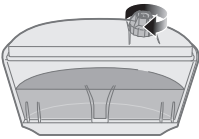

5 Skru lokket på vannbeholderen med klokken for å stramme til.

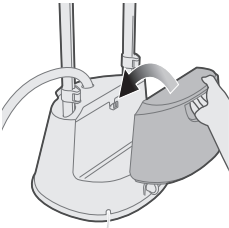

6 Juster med kroken for å plassere vannbeholderen tilbake på sokkelen.

Endre dampinnstillingene

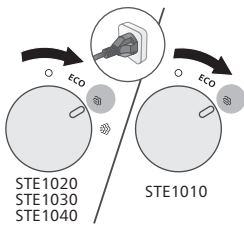

1 Kontroller at apparatet er koblet til. Drei dampbryteren til ønsket dampinnstilling.

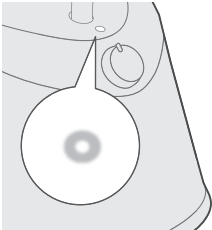

2 Lampen vil lyse kontinuerlig for å vise at stativdampenheten er slått PÅ.

*STE1010/75: ~2 min

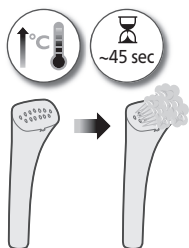

Stryketips

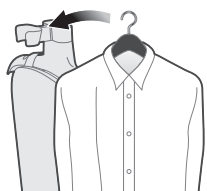

- 3 Vent rundt 45 sekunder for at stativdamphenheten skal varmes opp og avgir damp (STE1010/75: rundt 2 minutter).

- 1 Du kan bruke din egen kleshenger og plassere den på dampdokken.

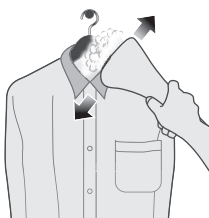

- 2 Beveg damphodet i parallell retning med kragen.

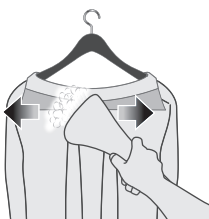

- 3 Beveg damphodet i en horisontal retning mot skuldrene.

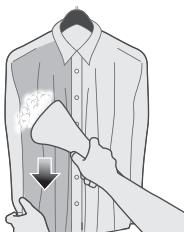

- 4 Strekk plagget. Beveg damphodet nedover på forsiden av plagget.



5 Beveg damphodet oppover på en lomme.

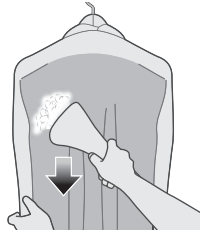

6 Strekk plagget. Beveg damphodet nedover på kroppens bakside.

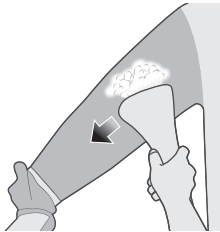

7 Strekk plagget. Beveg damphodet parallelt med ermet.

Rengjøring og vedlikehold

Calc Collector

Apparatet er utformet med et kalksamlingsystem. Det anbefales å avkalke én gang i måneden eller mer. Dette bidrar til å opprettholde en sterk dampytelse og hindrer at smuss og flekker kommer ut av strykesålen etter hvert som du bruker produktet.

Tips: Calc Collector-systemet kan brukes når som helst. Hvis du bor i et område med hardt vann, bør du bruke funksjonen oftere.

Utførelse av kalkrengjøringsprosessen

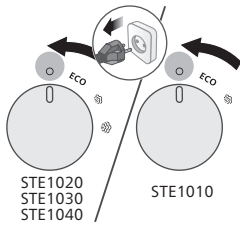

1 Kontroller at dampbryteren er i AV-stillingen, og at apparatet er koblet fra.



2 Kontroller at strykejernet er helt avkjølt (> 1 time).

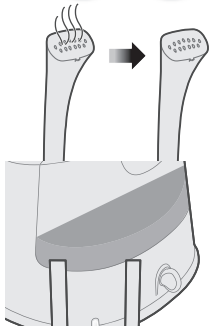

3 Plasser dampenheten nærme et sluk.

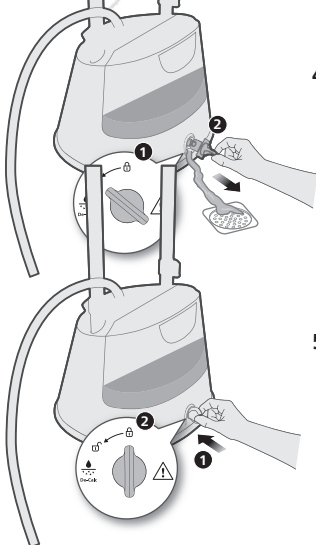

4 Vri De-calc-knotten til opplåst stilling, og fjern De-calc-knotten. La vannet renne ut.

5 Sett inn og vri De-calc-knotten til låst stilling.

Rengjøre og oppbevare stativdamphenheten

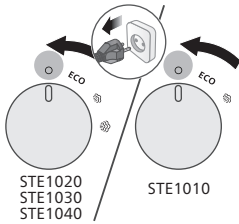

1 Kontroller at dampbryteren er i AV-stillingen, og at apparatet er koblet fra.

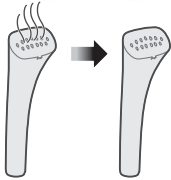

2 Kontroller at strykejernet er helt avkjølt (> 1 time).

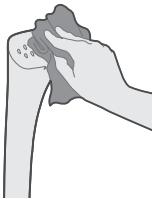

3 Tørk over dampenheten med en fuktig klut.

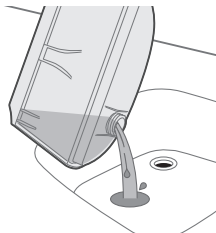

4 Tøm vannbeholderen.

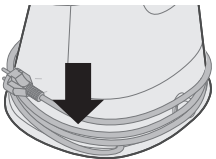

5 Surr ledningen rundt sokkelen.

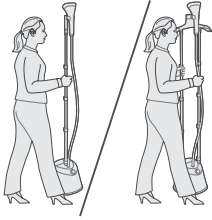

6 Du kan bære stativdampenheten med stangen.

Feilsøking

Dette kapittelet oppsummerer de vanligste problemene du kan oppleve med apparatet. Hvis du ikke kan løse problemet ved hjelp av informasjonen nedenfor, kan du gå til www.philips.com/support for å se en liste over vanlige spørsmål, eller du kan kontakte forbrukerstøtten i landet der du bor.

Problem	Mulig årsak	Løsning
Apparatet avgir ikke damp eller uregelmessig damp.	Dampenheten er ikke tilstrekkelig oppvarmet.	La apparatet varmes opp i rundt 45 sekunder (STE1010/75: rundt 20 minutter).
	Damp har kondensert i slangen.	Løft damphodet for strekke ut slangen i loddrett posisjon. Dette gjør at kondensen renner tilbake.
	Lavt vannivå i beholderen eller tanken er ikke satt ordentlig inn.	Fyll på vannbeholderen, og sett den ordentlig på plass.
Det drypper vann ut av damphodet, eller apparatet lager en pipelyd.	Apparatet har for store kalkavleiringer.	Utfør avkalkingsprosessen. Se Calc-Clean-avsnittet.
	Du har holdt damphodet og/eller dampslangen i loddrett posisjon altfor lenge.	Løft damphodet for strekke ut slangen i loddrett posisjon. Dette gjør at kondensen renner tilbake.
En stor mengde vann drypper ut av damphodet når apparatet varmes opp.	Når slangen danner en U-form, kan ikke kondensen som ligger i slangen, renne tilbake til beholderen.	Løft damphodet for strekke ut slangen i loddrett posisjon. Dette gjør at kondensen renner tilbake.
	Vannet i apparatet er skittent eller har stått i apparatet altfor lenge.	Utfør avkalkingsprosessen. Se Calc-Clean-avsnittet.
Vann lekker ut fra sokkelen til dampenheten.	Du har ikke lukket lokket til vannbeholderen eller vridd håndtaket for kalkrens ordentlig. Vannbeholderen er ikke satt inn riktig.	Lukk lokket til vannbeholderen og vri håndtaket for kalkrens ordentlig. Plasser beholderen riktig.

Kirish

Xaridingiz muborak bo'lsin va Philips'ga xush kelibsiz! Philips taklif qiladigan qo'llab-quvvatlash xizmatidan foydalanish uchun jihozingizni www.philips.com/welcome saytida ro'yxatdan o'tkazing. Qurilmani ishlatishdan oldin ushbu qo'llanmani, muhim ma'lumot risolasini va tez ishga tushirish bo'yicha ko'rsatmalarni diqqat bilan o'qib chiqing. Ularni kelgusida ma'lumot uchun saqlab qo'ying.

Mahsulot sharxi

STE1020, STE1030, STE1040

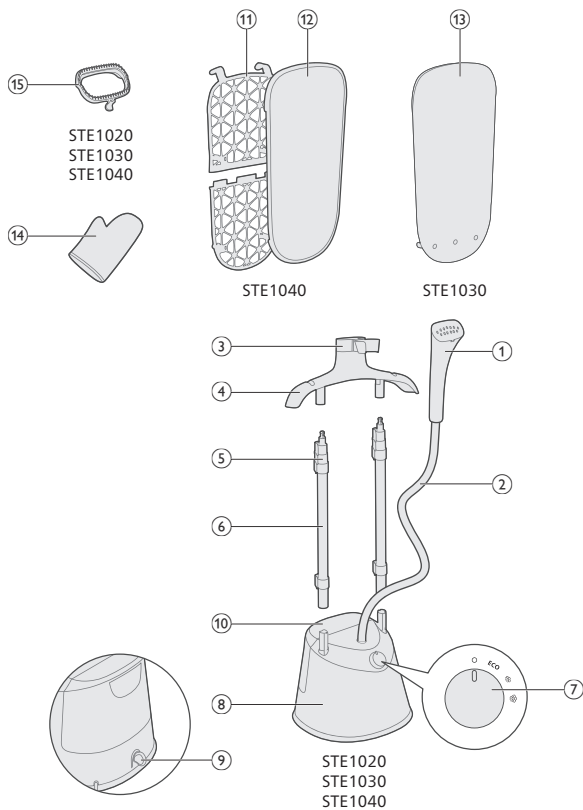

STE1010

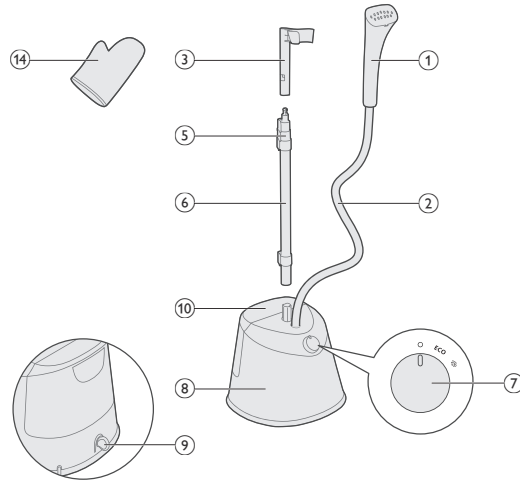

- 1 Bug'latkich kallagi
- 2 Bug' ta'minoti shlangi
- 3 Bug'latkich doki
- 4 Ilgak (STE1020, STE1030, STE1040)
- 5 Tirgak qisqich
- 6 Tirgak
- 7 Bug' murvati
- 8 Asos
- 9 Cho'kmadan tozalash murvati
- 10 Suv baki
- 11 Panel (STE1040)
- 12 Qoplama (STE1040)
- 13 To'shama (STE1030)
- 14 Qo'lqop
- 15 Cho'tka (STE1020, STE1030, STE1040)

Ishlatishga tayyorlash

Ishlatiladigan suv turi

Jihozga vodoprovod suvini ham ishlatish mumkin. Biroq, agar siz suvi qattiq hududlarda yashasangiz, teng miqdordagi distillangan yoki demineralizatsiyalangan suv bilan aralashtirishni tavsiya qilamiz. Bu cho'kmaning tez to'planishining oldini oladi va jihazning xizmat muddatini oshiradi.

Xushbo'y, quritish mashinasining suvi, sirka, kraxmal, cho'kmalarni tozalash vositalari, dazmol qilish vositalari, kimyoviy cho'kmalardan tozalangan suv yoki boshqa kimyoviy moddalarni quymang, chunki ular sizib chiqishi, jigarrang dog'lar hosil qilishi yoki jihazingizga shikast yetishiga sabab bo'lishi mumkin.

Ogohlantirishlar

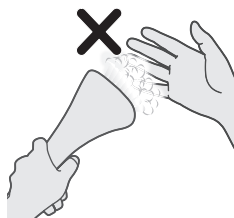

1 Terining biror qismi bug'ga tegishiga imkon bermang.



2 Bug' plastinasini boshqa odamlarga qaratmang.



3 Kiyimingizni bug' bilan bevosita tegib turadigan qilib tutmang.

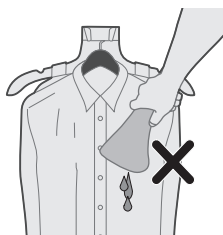

4 Bug'latkich kallagini pastga qaratib ishlatmang.

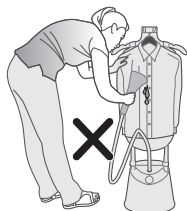

5 Kiyimni bug'lash uchun shlangini egmang.

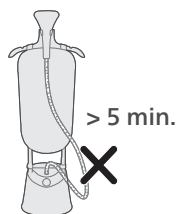

6 Stendli bug'latkichni 5 daqiqadan ortiq qoldirib ketmang.

Jihozni sozlash

STE1010

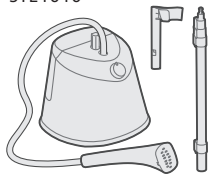

1 Xarid qilingan jihaz uchun mavjud qismlarni hisobga oling.

STE1020, STE1030
STE1040



STE1010

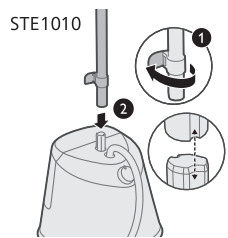

2 Pastki qutb qulf qisqichlarini qulfdan oching va qutb(lar)ni asosga kiriting. Qutb(lar) profillar va asos qutb ship(lari) tekislanishini ta'minlang.

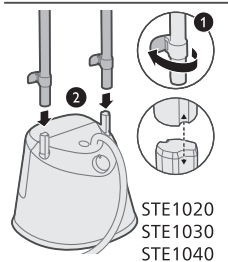

STE1020
STE1030
STE1040

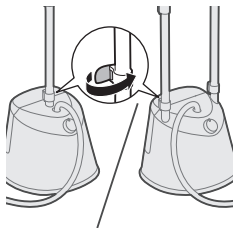

3 Pastki qutb qulf qisqich(lari)ni qulflang.

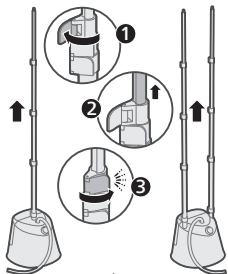

4 Qolgan qutb qulf qisqichlarini qulfdan oching, qutb(lar)ni to'liq tepaga uzaytiring va qulflang.

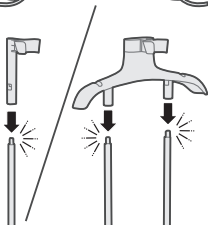

5 Bug'latkich dokini qutblarga joyiga qulflanguncha ("tiq etib tushguncha") qo'ying.

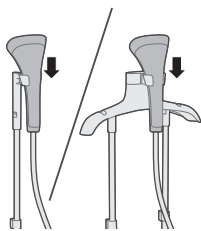

6 Bug'latkich kallagini bug'latkich dokiga joylang.

Plastinani sozlash

1 Xarid qilingan jihoz uchun mavjud qismlarni hisobga oling.

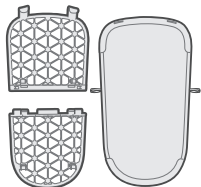

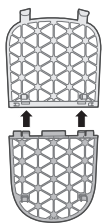

2 Joyiga qulflanguncha ("tiq etib tushguncha") plastina qisqichlarini tekislab qo'ying.

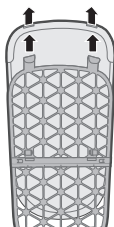

3 Plastina ilgaklari orqali plastina qoplamasini tekislang va qo'ying.

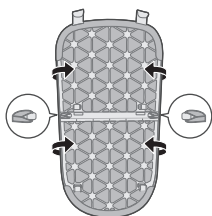

4 Plastinaning orqasiga ilgaklarni plastina qoplamasi tasmlariga ilib qo'ying

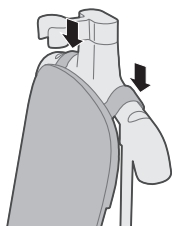

5 Plastinani ilgakka qo'ying.

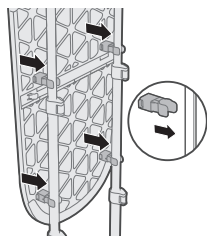

6 Joyiga qulflanguncha ("tiq etib tushguncha") plastinani qutblarga mahkamlang.

7 Ilgak yordamida kiyimlaringizni burishingiz mumkin.

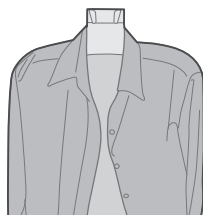
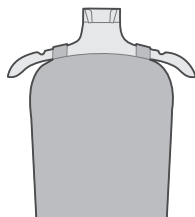

8 O'z ilgagingizdan foydalanishingiz yoki bug'latkich dokiga qo'yishingiz mumkin.

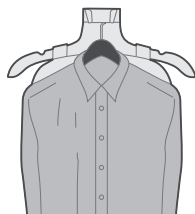

To'shamani sozlash

1 Bug'latkich doki orqali o'rta tasmani qo'ying.

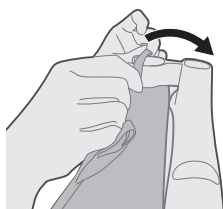

2 Ilgakning orqasidagi ilmoqqa 3 ta tasmani mahkamlang.

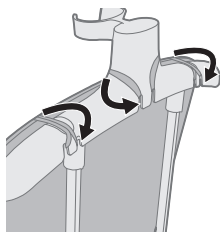

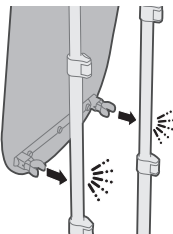

3 Joyiga qulflanguncha ("tiq etib tushguncha") to'shamani qutblarga mahkamlang.

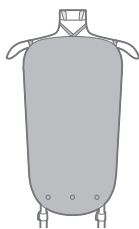

4 Ilgak yordamida kiyimlaringizni burishingiz mumkin.



5 O'z ilgagingizdan foydalanishingiz yoki bug'latkich dokiga qo'yishingiz mumkin.

Cho'tkani qo'yish

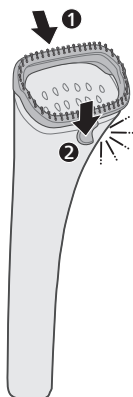

1 Yo'nalishni bug'latkich kallagining yuqori qismi bo'ylab tekislang va tagidan tutqichni ("tiq etib tushguncha") mahkamlang.

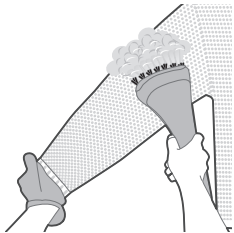

2 Qo'lqop kiyishingiz va cho'tkali biriktirma yordamida kiyimlaringizni bug'latishingiz mumkin.

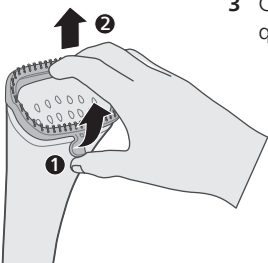

3 Cho'tka biriktirmasini olib tashlash uchun bug'latkich kallagining pastki qismidan tutqichni tuting va torting.

Suv bakini to'ldirish

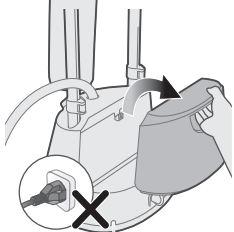

1 Jihozni ulamang. Suv bakini asosdan yechib oling.

2 Suv bakini tepaga qaratib suv bakini eging.

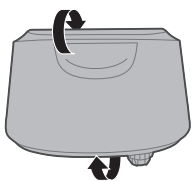

3 Yechib olish uchun suv bakini soat miliga qarshi burang.

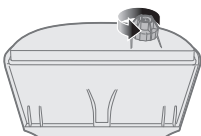

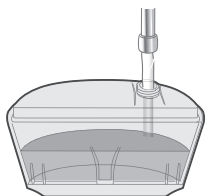

4 Suv bakini to'ldiring.

5 Qotirish uchun suv baki qopqog'ini soat miliga qarshi burang.

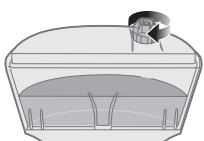

6 Suv bakini asosga qaytarish uchun ilgak bilan tekislang.

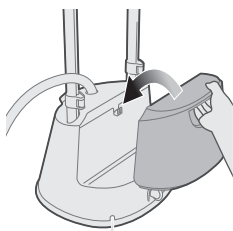

Bug' sozlamalarini o'zgartirish

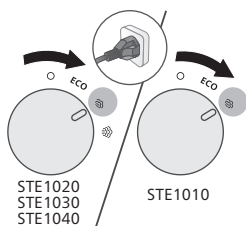

1 Jihoz tarmoqqa ulanishini ta'minlang. Bug'latkich murvatini istalgan bug'lash sozlamasiga buring.

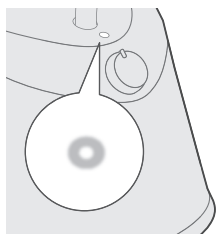

2 Stendli bug'latkich YONIQ ekanini ko'rsatish uchun chiroq sekin yonadi.

*STE1010/75: ~2 min

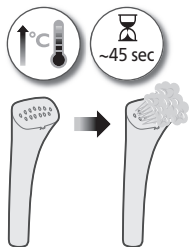

3 Stendli bug'latkich qizishi va bug' chiqarishi uchun taxminan 45 soniya kuting (STE1010/75: 2 daqiqa vaqt olad).

Dazmollash bo'yicha tavsiyalar

1 O'z ilgagingizdan foydalanishingiz yoki bug'latkich dokiga qo'yishingiz mumkin.

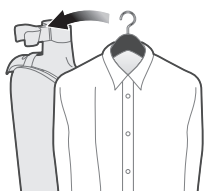

2 Bug'latkich kallagini yoqa bilan parallel yo'nalishda harakatlantiring.

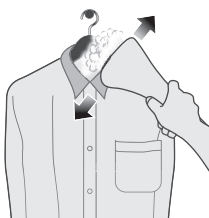

3 Bug'latkich kallagini xomut bilan gorizontal yo'nalishda harakatlantiring.

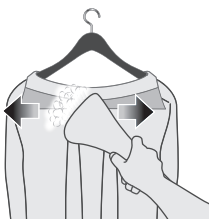

4 Kiyimni cho'zing. Bug'latkich kallagini tana oldida pastga yo'nalishda harakatlantiring.

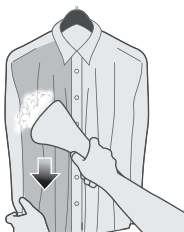



- 5 Bug'latkich kallagini cho'ntakda yuqoriga qaragan yo'nalishda harakatlantiring.

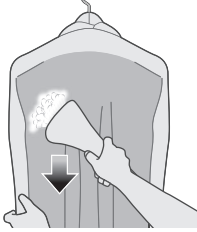

- 6 Kiyimni cho'zing. Bug'latkich kallagini pastga yo'nalishda tana orqasi bo'ylab harakatlantiring.

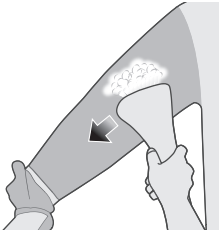

- 7 Kiyimni cho'zing. Bug'latkich kallagini yengda parallel yo'nalishda harakatlantiring.

Tozalash va texnik xizmat ko'rsatish

Qasmoq kollektori

Jihozingiz Qasmoq kollektori tizimi bilan ishlab chiqilgan. Oyiga bir yoki bir necha marta qasmoqdan tozalash tavsiya etiladi. Bu bug'ning kuchli ishlashini ta'minlashga yordam beradi va vaqt o'tishi bilan asos plitasidan kir va dog'lar chiqishining oldini oladi.

Maslahat: Qasmoq kollektor tizimi istalgan vaqtda ishlatilishi mumkin. Suvi qattiq mintaqada yashasangiz, funksiyadan tez-tez foydalaning.

Qasmoqdan tozalash jarayonini amalga oshirish

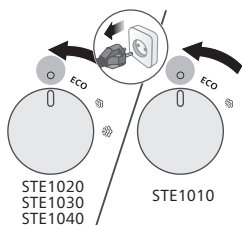

1 Bug'latkich murvati OFF holatda va jihoz tarmoqdan uzilganiga ishonch hosil qiling.

2 Dazmol butunlay sovitilishini ta'minlang (> 1 soat).



3 Bug'latkichni oqavaga yaqin joylang.

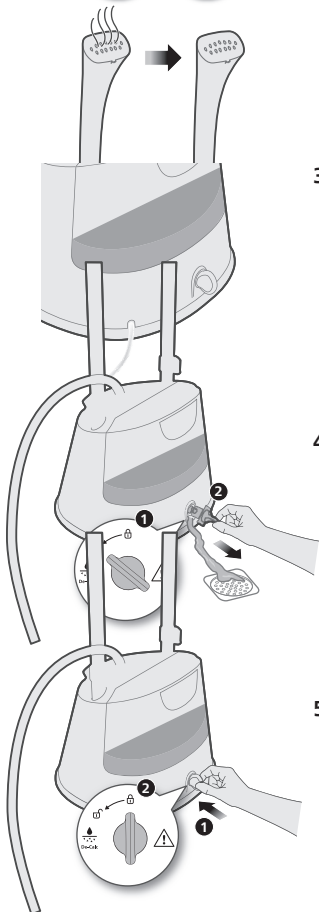

4 Qasmoqdan tozalash murvatini qulfdan ochish holatiga buring va Qasmoqdan tozalash murvatini oling. Suv to'kilishiga imkon bering.

5 Qasmoqdan tozalash murvatini qulf holatiga qo'ying va qulflang.

Stendli bug'latkichni tozalash va saqlash

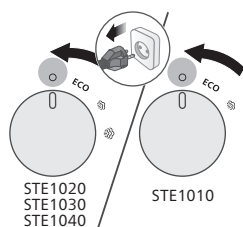

1 Bug'latkich murvati OFF holatda va jihoz tarmoqdan uzilganiga ishonch hosil qiling.



2 Dazmol butunlay sovitilishini ta'minlang (> 1 soat).

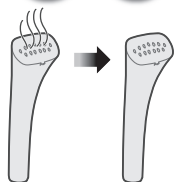

3 Bug'latkichni joyida nam mato bilan arting.

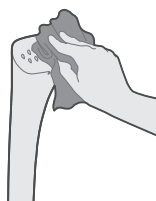

4 Suv bakini butunlay bo'shating.

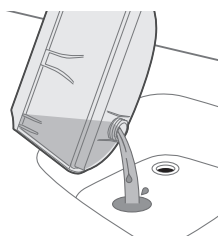

5 Asos atrofiga quvvat shnurini o'rab qo'ying.

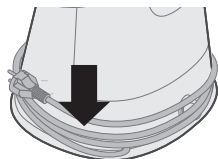

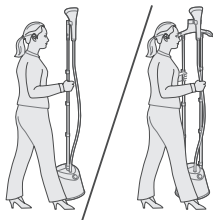

6 Stendli bug'latkichni qutbidan ushlab ko'tarishingiz mumkin.

Nosozliklarni aniqlash

Bu bobda jihozda uchraydigan eng keng tarqalgan muammolar umumlashtirilgan. Agar quyidagi ma'lumotga asoslanib muammoni hal qila olmasangiz, savol-javoblar ro'yxati uchun www.philips.com/support manziliga kiring yoki mamlakatingizdagi mijozlarga xizmat ko'rsatish markazi bilan bog'laning.

Muammo	Ehtimoliy sabab	Yechim
Jihoz bug' chiqarmaydi yoki bug' chiqishi bir maromda emas.	Bug'latkich yetarli darajada qizimayapti.	Jihozni taxminan 45 soniya qizdiring (STE1010/75: 2 daqiqa vaqt olad).
	Bug' shlangda kondensatsiyalangan.	Shlangni vertikal tekislash uchun bug'latkich kallagini ko'taring. Bu kondensatsiyaning qaytib oqib ketishiga imkon beradi.
	Bakda suv miqdori oz yoki bak to'g'ri o'rnatilmagan.	Bakni to'ldiring va to'g'ri joylang.
	Jihozda juda ko'p miqdorda cho'kmalar hosil bo'lgan.	Cho'kmalardan tozalash jarayonini bajaring. Qasmoqdan tozalash bo'limiga qarang.
Bug'latkich kallagidan suv tomchilamoqda yoki jihoz qurillagan tovush chiqarmoqda.	Siz bug'latkich kallagini va/yoki bug' ta'minoti shlangini uzoq vaqt gorizontol holatda qoldirgansiz.	Shlangni vertikal tekislash uchun bug'latkich kallagini ko'taring. Bu kondensatsiyaning qaytib oqib ketishiga imkon beradi.
	Shlang U-shakl hosil qilganda, shlangdagi kondensatsiya suv bakiga qaytib oqib tusha olmaydi.	Shlangni vertikal tekislash uchun bug'latkich kallagini ko'taring. Bu kondensatsiyaning qaytib oqib ketishiga imkon beradi.

Jihoz qizishni boshlaganida bug'latkich kallagidan ko'p miqdordagi suv oqib tushmoqda.

Jihoz ichidagi suv ifloslangan yoki uzoq vaqtdan beri jihoz ichida qolgan.

Cho'kmalardan tozalash jarayonini bajaring. Qasmoqdan tozalash bo'limiga qarang.

Bug'latkich asosidan suv sizib chiqmoqda.

Siz suv baki qopqog'i yoki cho'kmadan tozalash murvatini mahkam yopmagansiz. Suv baki to'g'ri o'rnatilmagan.

Suv baki qopqog'ini yoki cho'kmadan tozalash murvatini mahkam yoping. Bakni to'g'ri joylang.

Wstęp

Gratulujemy zakupu i witamy wśród klientów firmy Philips! Aby w pełni skorzystać z obsługi świadczonej przez firmę Philips, należy zarejestrować zakupiony produkt na stronie www.philips.com/welcome. Przed użyciem urządzenia zapoznaj się dokładnie z niniejszą instrukcją obsługi, ulotką informacyjną oraz skróconą instrukcją obsługi. Zachowaj te dokumenty na przyszłość.

Opis produktu

STE1020, STE1030, STE1040

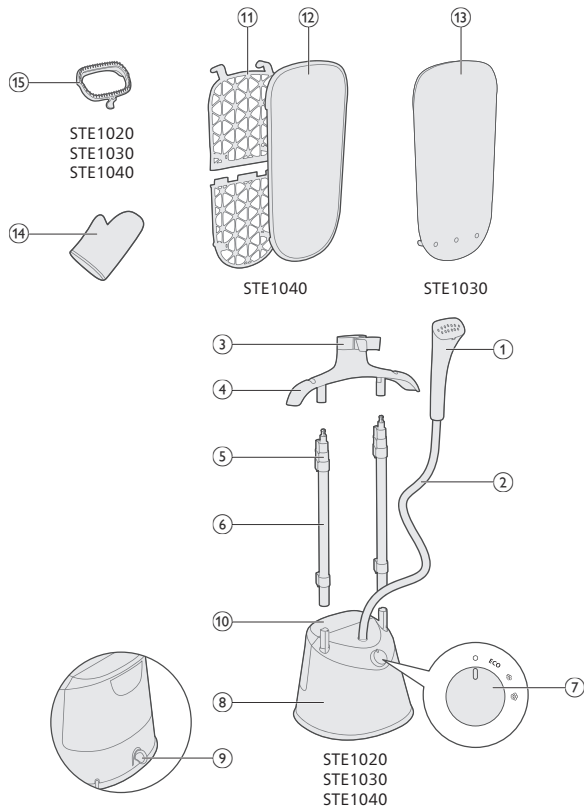

STE1010

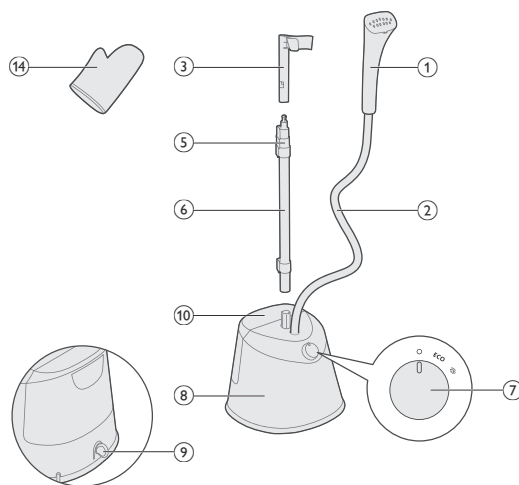

- 1 Dysza parowa
- 2 Wąż dopływowy pary
- 3 Stacja dokująca steamera
- 4 Wieszak (STE1020, STE1030, STE1040)
- 5 Zacisk blokujący stojaka
- 6 Stojak
- 7 Pokrętło pary
- 8 Podstawa
- 9 Pokrętło de-calc
- 10 Zbiornik wody
- 11 Deska (STE1040)
- 12 Osłona (STE1040)
- 13 Mata (STE1030)
- 14 Rękawica
- 15 Szczotka (STE1020, STE1030, STE1040)

Przygotowanie do użycia

Rodzaj używanej wody

Urządzenie jest przystosowane do wody z kranu. Jeśli jednak mieszkasz w miejscu, w którym występuje twarda woda, zalecamy wymieszanie wody z kranu z taką samą ilością wody destylowanej lub demineralizowanej. Zapobiegnie to osadzeniu się kamienia i wydłuży żywotność urządzenia.

Nie należy dodawać perfum, wody z suszarek bębnowych, octu, krochmalu, środków do usuwania kamienia lub ułatwiających prasowanie, wody odwapnionej chemicznie ani żadnych innych środków chemicznych, gdyż może to spowodować wyciek wody, powstawanie brązowych plam lub uszkodzenie urządzenia.

Ostrzeżenia

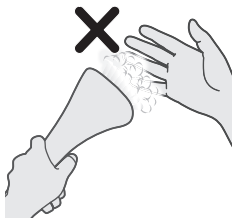

1 Nie umieszczaj żadnej części ciała w bezpośrednim kontakcie z parą.



2 Nie kieruj płyty parowej w stronę innych osób.



3 Nie trzymaj odzieży w sposób, który naraża ją na bezpośredni kontakt z parą.

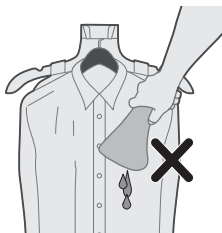

4 Nie używaj głowicy parowej skierowanej ku dołowi.

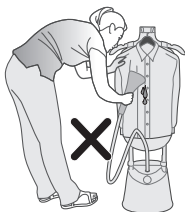

5 Nie zginaj węża podczas prasowania odzieży.

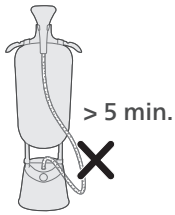

- 6 Nie pozostawiaj podstawy steamera bez nadzoru dłużej niż 5 minut.

Konfiguracja urządzenia

STE1010

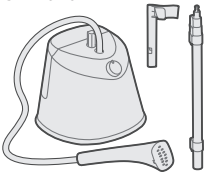

- 1 Zwróć uwagę na części dostępne dla zakupionego urządzenia.

STE1020, STE1030
STE1040



STE1010

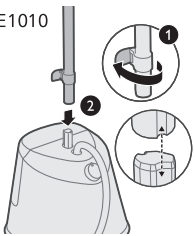

- 2 Odblokuj zaciski blokujące stojaka i umieść stojak na podstawie. Upewnij się, że profile stojaka lub kołków stojaka podstawy są wyrównane.

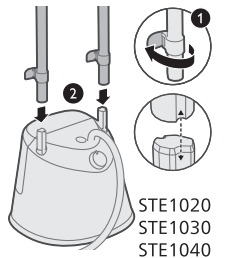

STE1020
STE1030
STE1040

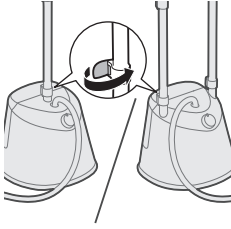

3 Zablokuj dolne zaciski blokujące stojaka.

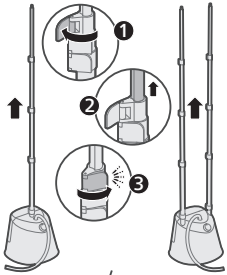

4 Odblokuj pozostałe zaciski blokujące stojaka, całkowicie wysuń stojak do góry i zablokuj go.

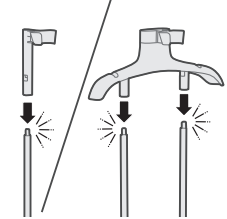

5 Umieść stację dokującą steamera na stojaku, aż zatrzaśnie się we właściwym położeniu (usłyszysz „kliknięcie”).

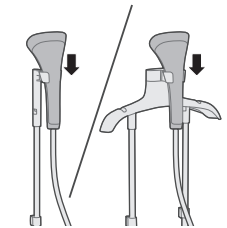

6 Umieść głowicę parową w stacji dokującej steamera.

Rozstawianie deski

1 Zwróć uwagę na części dostępne dla zakupionego urządzenia.

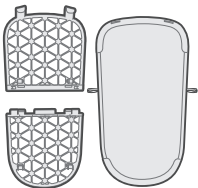

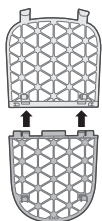

2 Wyrównaj i włóż zaczepy deski, aż zatrzasną się we właściwym położeniu (usłyszysz „kliknięcie”).

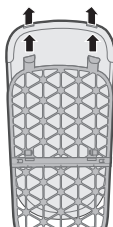

3 Wyrównaj i włóż pokrywę deski przez zaczepy deski.

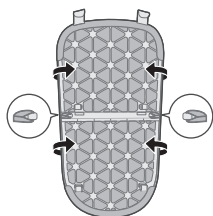

4 Zaczep paski pokrywy deski na haczykach z tyłu deski.

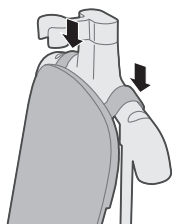

5 Umieść deskę na wieszaku.

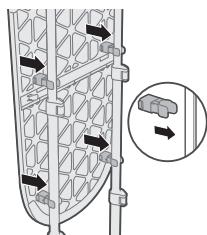

6 Przymocuj deskę do stojaków, aż zatrzaśnie się we właściwym położeniu (usłyszysz „kliknięcie”).

7 Na wieszaku możesz zawiesić ubrania.

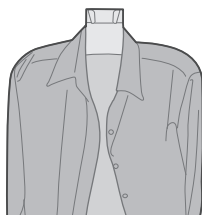
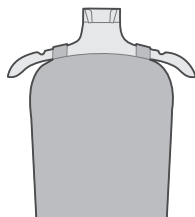

8 Możesz użyć własnego wieszaka i umieścić go na stacji dokującej steamera.

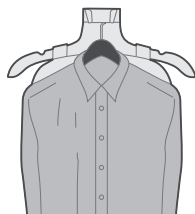

Przygotowanie maty

1 Przelóż środkowy pasek przez stację dokującą steamera.

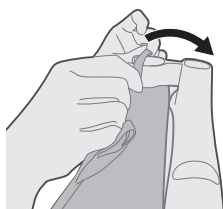

2 Zamocuj 3 paski na haku z tyłu wieszaka.

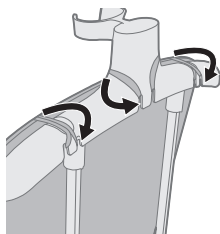

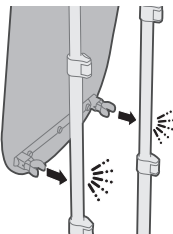

- 3** Zamocuj matę na stojakach, aż zatrzaśnie się we właściwym położeniu (usłyszysz „kliknięcie”).

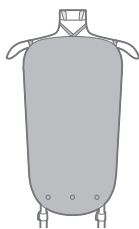

- 4** Na wieszaku możesz zawiesić ubrania.



- 5** Możesz użyć własnego wieszaka i umieścić go na stacji dokującej steamera.

Wkładanie szczotki

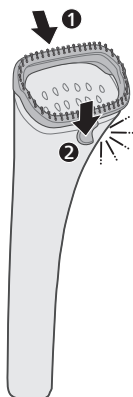

- 1** Wyrównaj szczotkę wzdłuż górnej części głowicy parownicy i zatrzaśnij zatrask na dole ("kliknięcie").

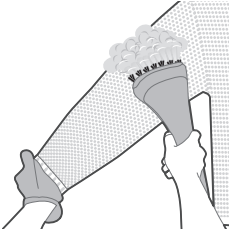

2 Możesz założyć rękawicę i prasować ubrania przy użyciu nasadki ze szczotką.

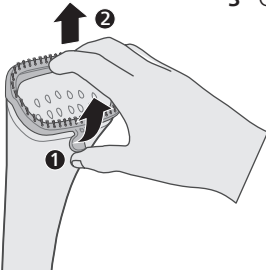

3 Chwyć i wyciągnij zatrzask z dołu głowicy parownicy, aby wyjąć szczotkę.

Napełnianie zbiornika wody

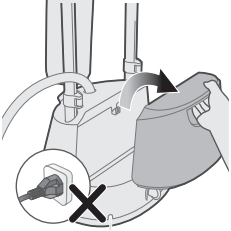

1 Nie podłączaj urządzenia. Wyjmij zbiornik wody z podstawy.

2 Obróć zbiornik wody tak, aby korek zbiornika był skierowany do góry.

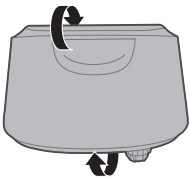

3 Odkręć korek zbiornika wody w lewo, aby go zdjąć.

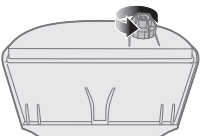

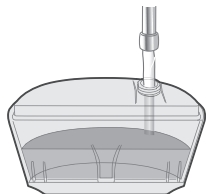

4 Napełnij zbiornik wody.

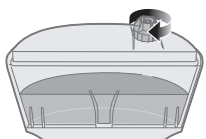

5 Dokręć korek zbiornika wody w prawo.

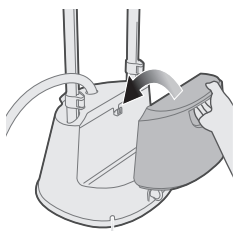

6 Wyrównaj z hakiem, aby umieścić zbiornik wody z powrotem w podstawie.

Zmiana ustawień pary

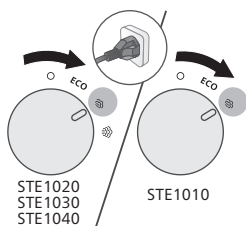

1 Upewnij się, że urządzenie jest podłączone. Obróć pokrętko pary, aby wybrać żądane ustawienie pary.

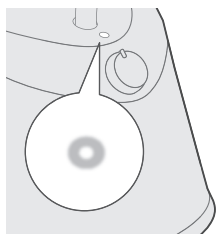

2 Wskaźnik zacznie świecić światłem ciągłym, sygnalizując, że steamer jest WŁĄCZONY.

*STE1010/75: ~2 min

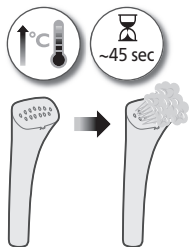

3 Poczekaj około 45 sekund, aż steamer się rozgrzeje i zacznie wytwarzać parę (STE1010/75: ok. 2 minuty).

Wskazówki dotyczące prasowania

1 Możesz użyć własnego wieszaka i umieścić go na stacji dokującej steamera.

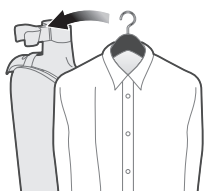

2 Przesuń dyszę parową w kierunku równoległym do kołnierza.

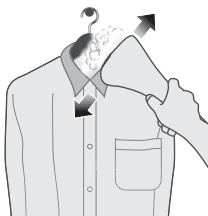

3 Przesuń dyszę parową w kierunku poziomym do karczku.

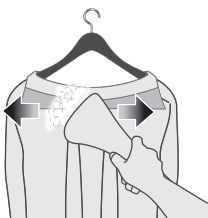

4 Rozciągnij ubranie. Przesuń dyszę parową w dół na przedniej części odzieży.

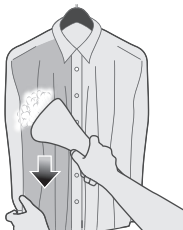



5 Przesuń dyszę parową do góry na kieszeni.

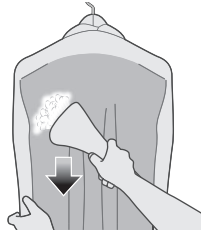

6 Rozciągnij ubranie. Przesuń dyszę parową w dół na tylnej części odzieży.

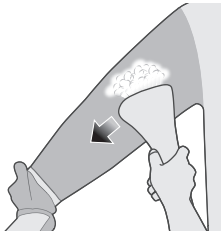

7 Rozciągnij ubranie. Przesuń dyszę parową w kierunku równoległym do rękawa.

Czyszczenie i konserwacja

Calc Collector

Urządzenie zostało zaprojektowane z systemem Calc Collector. Zaleca się usuwanie kamienia raz w miesiącu lub częściej. Pozwala to uzyskać maksymalną ilość pary, a także uniknąć powstawania brudu i zanieczyszczeń wpływających ze stopy żelazka przez długi okres eksploatacji.

Wskazówka: systemu Quick Calc Release można użyć w dowolnym momencie. Jeśli mieszkasz miejscu, w którym występuje twarda woda, używaj tej funkcji częściej.

Uruchamianie procesu usuwania kamienia.

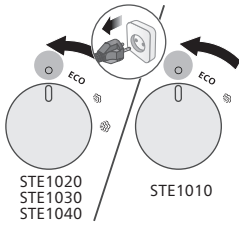

1 Upewnij się, że pokrętko pary znajduje się w pozycji WYŁ., a urządzenie jest odłączone od zasilania.

2 Upewnij się, że żelazko całkowicie ostygło (> 1 godzina).



3 Umieść steamer w pobliżu odpływu.

4 Obróć pokrętko de-calc do pozycji odblokowania i zdejmij pokrętko de-calc. Pozwól wodzie spłynąć.

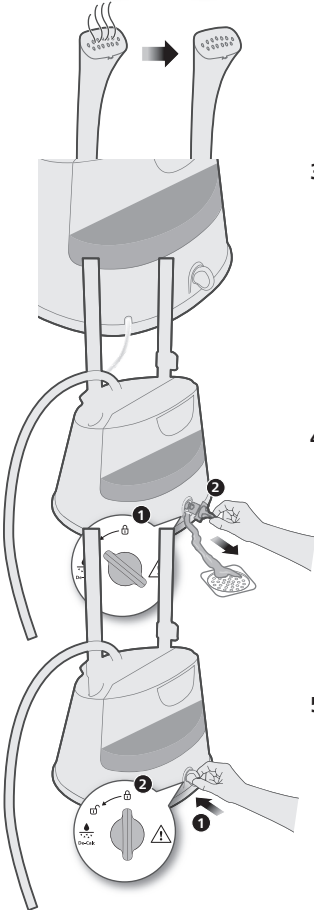

5 Włóż i przekręć pokrętko de-calc do pozycji blokady.

Czyszczenie i przechowywanie podstawy steamera

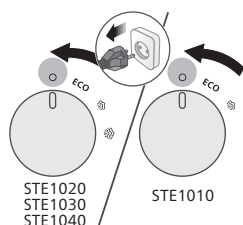

- 1 Upewnij się, że pokrętko pary znajduje się w pozycji WYŁ., a urządzenie jest odłączone od zasilania.

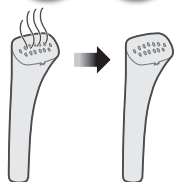

- 2 Upewnij się, że żelazko całkowicie ostygło (> 1 godzina).

- 3 Wytrzyj pozostałości pary wilgotną szmatką.

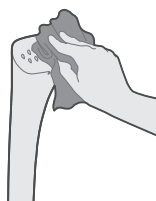

- 4 Całkowicie opróżnij zbiornik wody.

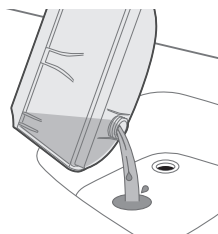

- 5 Owiń przewód zasilający wokół podstawy.

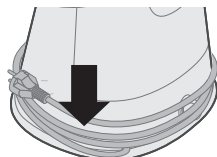

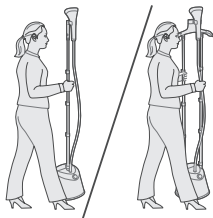

6 Podstawę steamera można przenosić za stojak.

Rozwiązywanie problemów

W tym rozdziale opisano najczęstsze problemy, z którymi można się zetknąć, korzystając z urządzenia. Jeśli poniższe wskazówki okażą się niewystarczające do rozwiązania problemu, odwiedź stronę www.philips.com/support, na której znajduje się lista często zadawanych pytań, lub skontaktuj się z Centrum Obsługi Klienta w swoim kraju.

Problem	Prawdopodobna przyczyna	Rozwiązanie
Urządzenie nie wytwarza pary lub wytwarza ją w nieregularnych ilościach.	Steamer nie nagrzał się dostatecznie.	Poczekaj około 45 sekund, aż urządzenie się nagrzej (STE1010/75: ok. 2 minuty).
	Para skropliła się w węży.	Unieś dyszę parową i wyprostuj wąż w pionie. Umożliwi to na odprowadzenie skroplonej pary wodnej.
	Niski poziom wody w zbiorniku lub zbiornik nie jest prawidłowo włożony.	Napełnij zbiornik wody i włóż go prawidłowo.
Z dyszy parowej wydobywają się krople wody, a czasem urządzenie wydaje niepokojący dźwięk.	Wewnątrz urządzenia nagromadziła się zbyt duża ilość kamienia	Użyj funkcji de-calc. Patrz rozdział Calc-Clean.
	Dyszę parową i/lub wąż pary pozostawiono w pozycji poziomej na długi czas.	Unieś dyszę parową i wyprostuj wąż w pionie. Umożliwi to na odprowadzenie skroplonej pary wodnej.
	Gdy wąż przybierze kształt litery „U”, odprowadzenie skroplonej pary wodnej z węża do zbiornika wody jest niemożliwe.	Unieś dyszę parową i wyprostuj wąż w pionie. Umożliwi to na odprowadzenie skroplonej pary wodnej.

Nadmierna ilość wody kapie z dyszy parowej podczas nagrzewania się urządzenia.

Woda w urządzeniu jest brudna lub pozostawała w nim przez długi czas.

Użyj funkcji de-calc. Patrz rozdział Calc-Clean.

Woda wycieka z podstawy steamera.

Korek zbiornika wody lub pokrętło de-calc nie zostały prawidłowo zamknięte. Zbiornik wody nie został prawidłowo włożony

Dokładnie zakręć korek zbiornika wody lub pokrętło de-calc. Włóż prawidłowo zbiornik.

Introdução

Parabéns pela sua aquisição e bem-vindo à Philips! Para tirar o máximo partido da assistência oferecida pela Philips, registre o seu produto em www.philips.com/welcome. Leia cuidadosamente este manual do utilizador, o folheto informativo importante e o guia de início rápido antes de utilizar o aparelho. Guarde-os para referência futura.

Visão geral do produto

STE1020, STE1030, STE1040

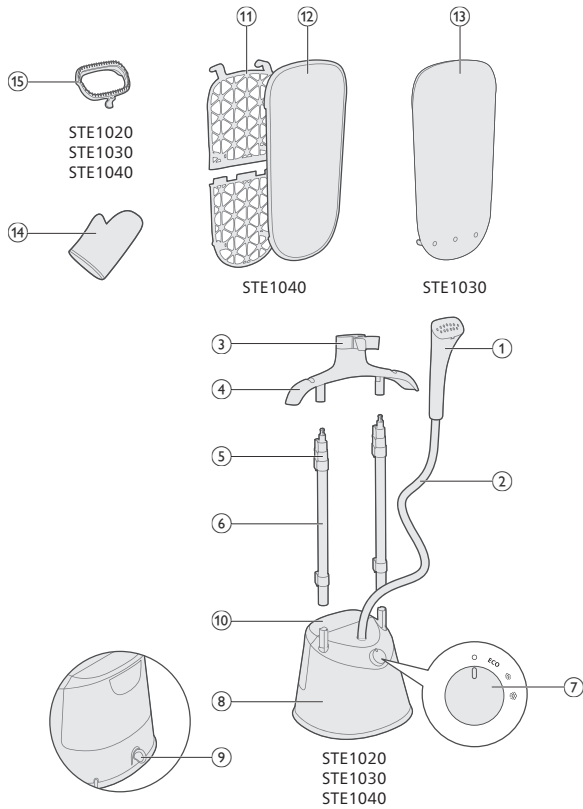

STE1010

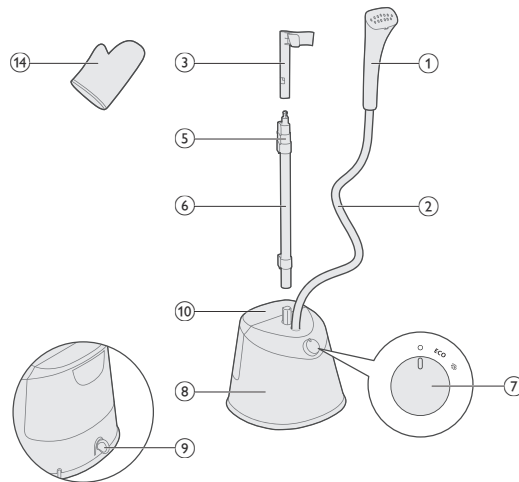

- 1 Cabeça do vaporizador
- 2 Tubo flexível de fornecimento de vapor
- 3 Suporte do vaporizador
- 4 Cabide (STE1020, STE1030, STE1040)
- 5 Clipe de bloqueio do varão
- 6 Varão
- 7 Seletor de vapor
- 8 Base
- 9 Botão de descalcificação
- 10 Depósito de água
- 11 Tábua (STE1040)
- 12 Tampa (STE1040)
- 13 Capa (STE1030)
- 14 Luva
- 15 Escova (STE1020, STE1030, STE1040)

Preparar para a utilização

Tipo de água a utilizar

O aparelho pode ser utilizado com água canalizada. No entanto, se viver numa área com água dura, recomendamos que misture água canalizada e água destilada ou desmineralizada em partes iguais. Isso evita a acumulação rápida de calcário e prolonga a vida útil do aparelho.

Não adicione perfume, água de uma máquina de secar, vinagre, goma, agentes anticalcário, produtos para ajudar a engomar, água descalcificada quimicamente nem outros químicos, pois estes podem causar expelição de água, manchas castanhas ou danos no aparelho.

Avisos

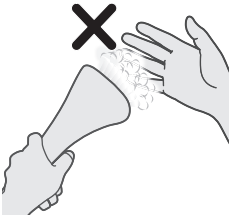

1 Não coloque qualquer parte da pele em contacto direto com o vapor.



2 Não aponte a placa de vapor para outras pessoas.

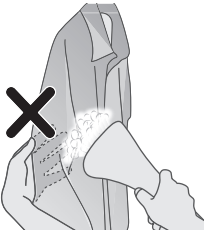

3 Não segure a peça de roupa de uma forma que esteja em contacto direto com o vapor.

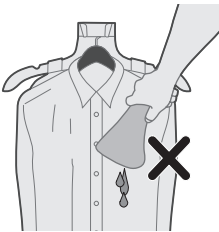

4 Não utilize a cabeça do vaporizador virada para baixo.

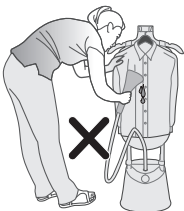

5 Não dobre a mangueira para vaporizar a peça de roupa.

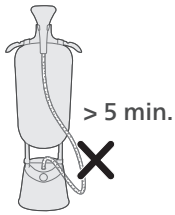

- 6 Não deixe o vaporizador vertical sem supervisão durante mais de 5 minutos.

Montar o aparelho

STE1010

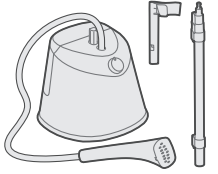

- 1 Consulte as peças disponíveis para o aparelho que adquiriu.

STE1020, STE1030
STE1040



STE1010

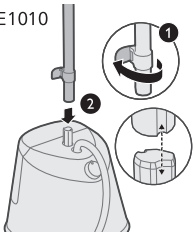

- 2 Desbloqueie os cliques de bloqueio dos varões inferiores e insira os varões na base. Certifique-se de que os perfis dos varões e os pinos dos varões da base estão alinhados.

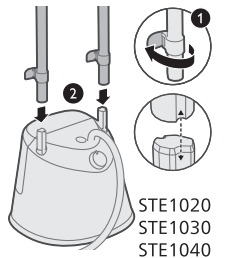

STE1020
STE1030
STE1040

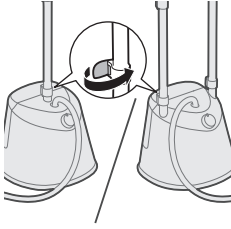

3 Bloqueie os cliques de bloqueio dos varões inferiores.

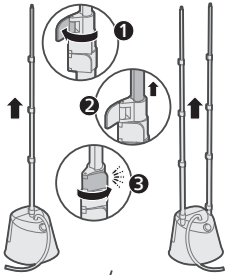

4 Desbloqueie os restantes cliques de bloqueio dos varões, estenda completamente os varões para cima e bloqueie-os.

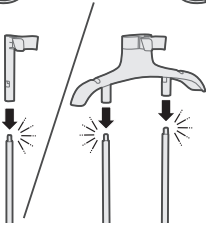

5 Introduza o suporte do vaporizador nos varões até encaixar na devida posição (deve ouvir um "clique").

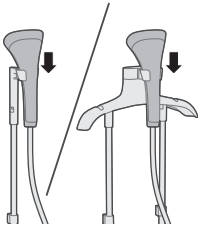

6 Coloque a cabeça do vaporizador na base do vaporizador.

Montar a tábua

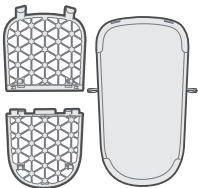

1 Consulte as peças disponíveis para o aparelho que adquiriu.

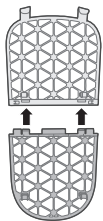

2 Alinhe e insira os cliques da tábua até encaixarem na devida posição (deve ouvir um "clique").

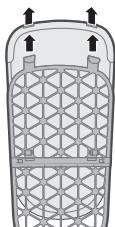

3 Alinhe e insira a capa da tábua através dos ganchos da tábua.

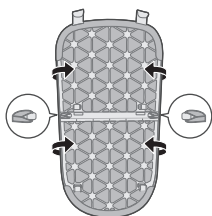

4 Prenda as fitas da capa da tábua aos ganchos na parte de trás da tábua

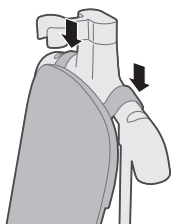

5 Coloque a tábua no cabide.

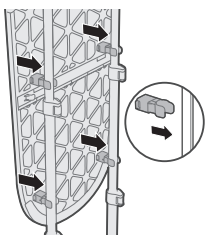

6 Encaixe a tábua nos varões, na devida posição (deve ouvir um "clique").

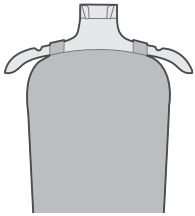

7 Pode passar as suas roupas utilizando o cabide.

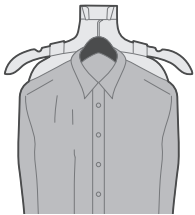
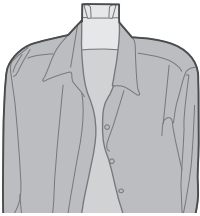

8 Pode utilizar o seu próprio cabide e colocá-lo no suporte do vaporizador.

Colocar a capa

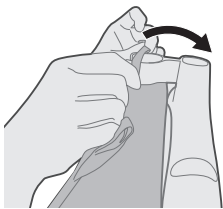

1 Faça passar o suporte do vaporizador pela fita do meio.

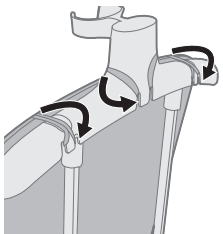

2 Prenda as 3 fitas no gancho à parte de trás do cabide.

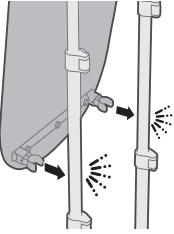

3 Encaixe a capa nos varões, na devida posição (deve ouvir um "clique").



4 Pode passar as suas roupas utilizando o cabide.



5 Pode utilizar o seu próprio cabide e colocá-lo no suporte do vaporizador.

Inserir a escova

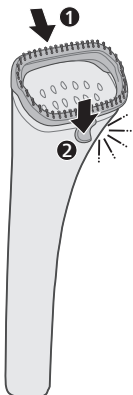

1 Alinhe com a marca na parte superior da cabeça do vaporizador e encaixe a lingueta na parte inferior (deve ouvir um "clique").

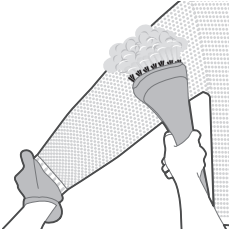

2 Pode usar a luva e vaporizar a roupa utilizando o acessório da escova.

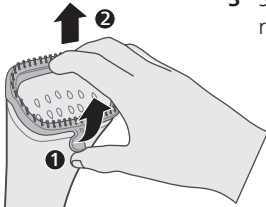

3 Segure e puxe a lingueta da parte inferior da cabeça do vaporizador para remover o acessório da escova.

Encher o depósito de água

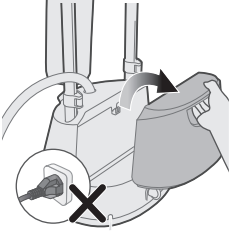

1 Não ligue o aparelho à corrente. Retire o depósito de água da base.

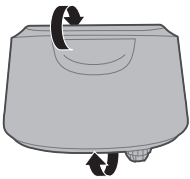

2 Vire o depósito de água com a tampa do depósito de água voltada para cima.

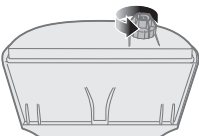

3 Desenrosque a tampa do depósito de água, para a esquerda, para a retirar.

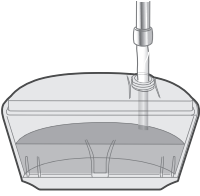

4 Encha o depósito de água.

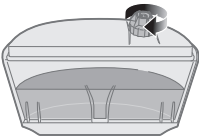

5 Enrosque a tampa do depósito de água, para a direita, para apertar.

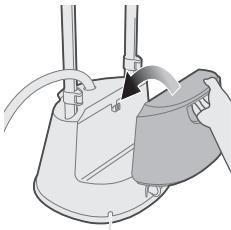

6 Alinhe com o gancho para voltar a colocar o depósito de água na base.

Alterar as regulações de vapor

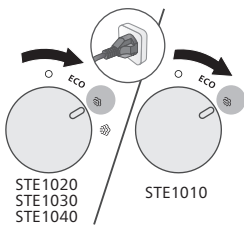

1 Certifique-se de que o aparelho está ligado à corrente. Rode o seletor de vapor para a regulação de vapor pretendida.

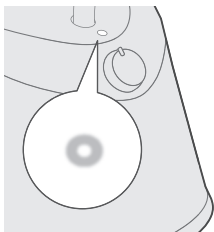

2 A luz mantém-se continuamente acesa para indicar que o vaporizador vertical está LIGADO.

*STE1010/75: ~2 min

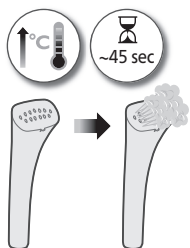

- 3 Aguarde cerca de 45 segundos para que o vaporizador aqueça e emita vapor (STE1010/75: cerca de 2 minutos).

Sugestões sobre engomar

- 1 Pode utilizar o seu próprio cabide e colocá-lo no suporte do vaporizador.

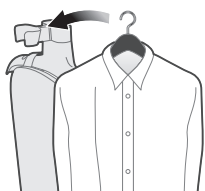

- 2 Mova a cabeça do vaporizador numa direção paralela ao colarinho.

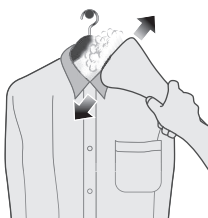

- 3 Mova a cabeça do vaporizador numa direção horizontal às pregas.

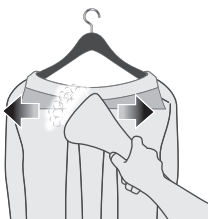

- 4 Estique a peça de roupa. Mova a cabeça do vaporizador numa direção descendente na parte da frente.

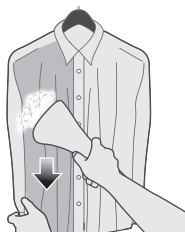



5 Mova a cabeça do vaporizador numa direção ascendente num bolso.

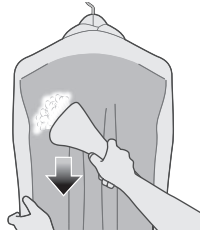

6 Estique a peça de roupa. Mova a cabeça do vaporizador numa direção descendente na parte de trás.

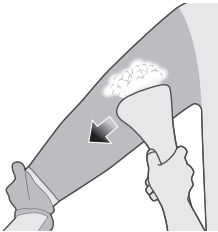

7 Estique a peça de roupa. Mova a cabeça do vaporizador numa direção paralela à manga.

Limpeza e manutenção

Coletor de calcário

O seu aparelho foi concebido com um sistema coletor de calcário. Recomenda-se que descalcifique o aparelho, pelo menos, uma vez por mês. Isto ajuda a manter o bom desempenho do vapor e evita que, com o tempo, a sujidade e as manchas atravessem a base e passem para a roupa.

Sugestão: o sistema coletor de calcário pode ser utilizado em qualquer altura. Caso viva numa zona de água dura, utilize a função com mais regularidade.

Executar o processo de descalcificação

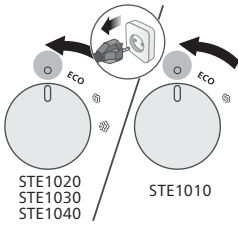

1 Certifique-se de que o seletor de vapor está na posição desligada (OFF) e de que o aparelho está desligado da ficha.

2 Certifique-se de que o ferro arrefeceu completamente (> 1 hora).

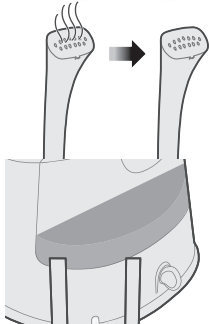

3 Coloque o vaporizador perto de um ralo.

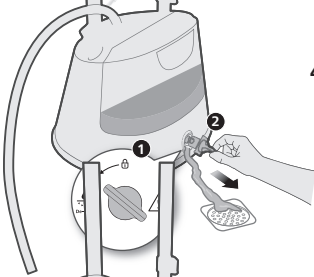

4 Rode o botão de descalcificação para a posição de desbloqueio e retire o botão de descalcificação. Deixe a água escorrer.

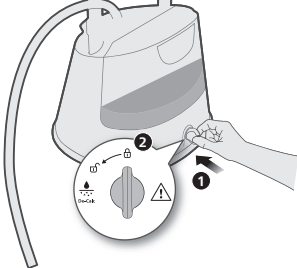

5 Insira e rode o botão de descalcificação para a posição de bloqueio.

Limpar e guardar o vaporizador vertical

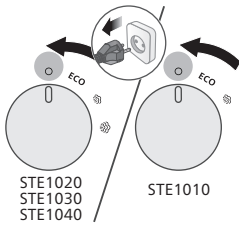

- 1 Certifique-se de que o seletor de vapor está na posição desligada (OFF) e de que o aparelho está desligado da ficha.

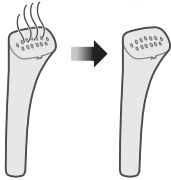

- 2 Certifique-se de que o ferro arrefeceu completamente (> 1 hora).

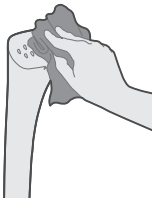

- 3 Limpe a placa de vapor com um pano húmido.



- 4 Esvazie totalmente o depósito de água.

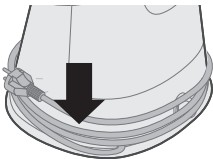

- 5 Enrole o cabo de alimentação à volta da base.

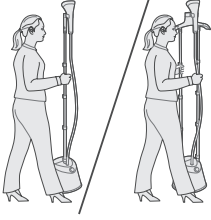

6 Pode transportar o vaporizador vertical pelos varões.

Resolução de problemas

Este capítulo resume os problemas mais comuns que podem surgir no aparelho. Se não conseguir resolver o problema com as informações fornecidas abaixo, visite www.philips.com/support para consultar uma lista de perguntas frequentes ou contacte o Centro de Apoio ao Cliente no seu país.

Problema	Possível causa	Solução
O aparelho não produz vapor ou produz vapor de modo irregular.	O vaporizador ainda não aqueceu o suficiente.	Deixe o aparelho aquecer durante aproximadamente 45 segundos (STE1010/75: cerca de 2 minutos).
	O vapor condensou no tubo flexível.	Levante a cabeça do vaporizador para esticar o tubo flexível na vertical. Isto permite que uma eventual condensação flua para trás.
	Nível de água reduzido no depósito ou o depósito não está introduzido corretamente.	Encha o depósito de água e introduza-o corretamente.
A cabeça do vaporizador liberta gotas de água ou o aparelho produz um ruído áspero.	Acumulou-se demasiado calcário no aparelho.	Execute processo de descalcificação. Consulte a secção Calc-Clean.
	Deixou a cabeça do vaporizador e/ou o tubo flexível de fornecimento de vapor na posição horizontal durante demasiado tempo.	Levante a cabeça do vaporizador para esticar o tubo flexível na vertical. Isto permite que uma eventual condensação flua para trás.
	Se o tubo flexível estiver em forma de U, a condensação no tubo não pode voltar a fluir para o depósito de água.	Levante a cabeça do vaporizador para esticar o tubo flexível na vertical. Isto permite que uma eventual condensação flua para trás.

É libertada uma quantidade excessiva de gotas de água pela cabeça do vaporizador quando o aparelho está a aquecer.

A água no aparelho está suja ou foi deixada dentro do aparelho durante demasiado tempo.

Execute processo de descalcificação. Consulte a secção Calc-Clean.

Sai água pela base do vaporizador.

Não fechou bem a tampa do depósito de água ou o botão de descalcificação. O depósito de água não está encaixado corretamente.

Fechete seguramente a tampa do depósito de água ou o botão de descalcificação. Introduza o depósito corretamente.

Introdução

Parabéns pela sua aquisição e bem-vindo à Philips! Para aproveitar ao máximo o suporte oferecido pela Philips, registre seu produto em www.philips.com/welcome. Leia atentamente este manual do usuário, o folheto de informações importantes e o guia de início rápido antes de usar o aparelho. Guarde-os para consultas futuras.

Visão geral do produto

STE1020, STE1030, STE1040

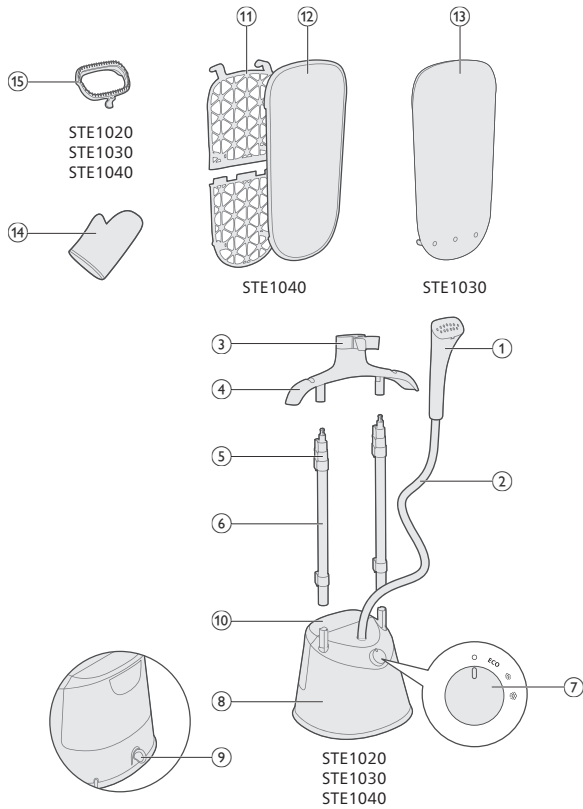

STE1010

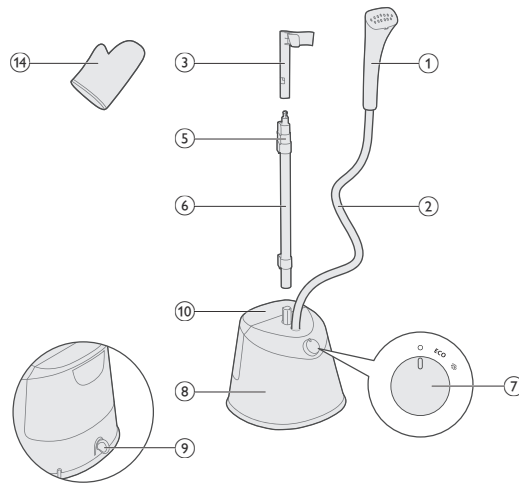

- 1 Bocal do vaporizador
- 2 Mangueira de fornecimento de vapor
- 3 Base para o vaporizador
- 4 Cabide (STE1020, STE1030, STE1040)
- 5 Hastes do clipe de travamento
- 6 Haste
- 7 Botão de vapor
- 8 Base
- 9 Botão de remoção de impurezas
- 10 Reservatório de água
- 11 Tábua de passar (STE1040)
- 12 Capa (STE1040)
- 13 Apoio (STE1030)
- 14 Luva
- 15 Escova (STE1020, STE1030, STE1040)

Preparação para o uso

Tipo de água usado

O aparelho é adequado para uso com água corrente. No entanto, se você mora em uma área com água dura, recomendamos misturar uma quantidade igual de água da torneira com água destilada ou desmineralizada. Isso evitará o acúmulo rápido de impurezas e prolongará a vida útil do aparelho.

Não adicione perfume, água da secadora, vinagre, amido, agentes removedores de impurezas, produtos para passar roupas, água quimicamente descalcificada ou outros produtos químicos, pois podem causar jatos de água, manchas escuras ou danos ao aparelho.

Avisos



1 Não coloque qualquer parte da pele em contato direto com o vapor.



2 Não aponte a placa de vapor para outras pessoas.



3 Não segure a peça de roupa de forma que esteja em contato direto com o vapor.

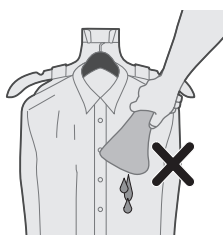

4 Não utilize o bocal do vaporizador apontado para baixo.

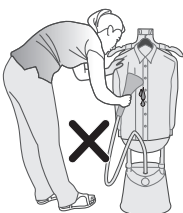

5 Não dobre a mangueira para vaporizar a peça de roupa.

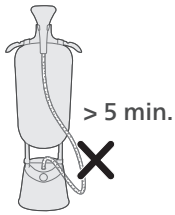

- 6 Não deixe a vaporizador vertical sem supervisão por mais de 5 minutos.

Montagem do aparelho

STE1010

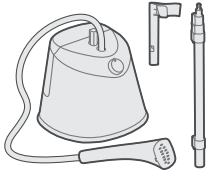

- 1 Observe as peças disponíveis para o aparelho que você adquiriu.

STE1020, STE1030
STE1040



STE1010

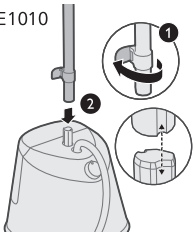

- 2 Desbloqueie as hastes dos cliques de travamento inferior e insira a(s) haste(s) na base. Certifique-se de que os perfis da(s) haste(s) e o(s) pino(s) da haste de base estejam alinhados.

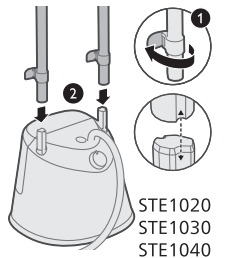

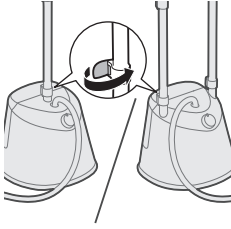

3 Bloqueie o(s) clipe(s) de travamento da haste inferior.

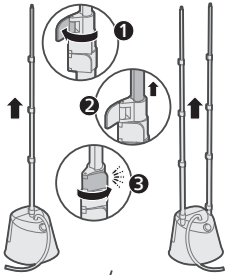

4 Desbloqueie os cliques de travamento restantes da haste, estenda completamente a(s) haste(s) para cima e trave-os.

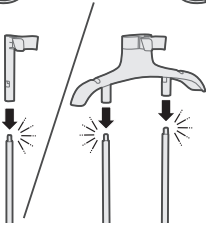

5 Insira a base do vaporizador na(s) haste(s) até fixá-la no lugar (você ouvirá um "clique").

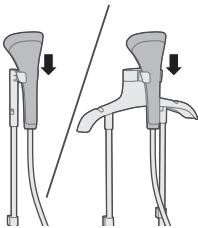

6 Coloque o bocal do vaporizador sobre a base do vaporizador.

Montagem da tábua

1 Observe as peças disponíveis para o aparelho que você adquiriu.

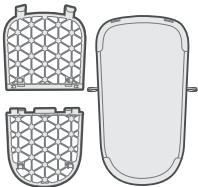

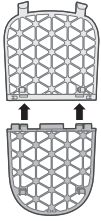

2 Alinhe e insira os cliques da tábua até fixá-la no lugar (você ouvirá um "clique").



3 Alinhe e insira a capa da tábua de passar através dos ganchos da tábua.

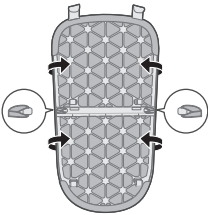

4 Prenda as tiras da capa da tábua de passar aos ganchos na parte de trás da tábua.

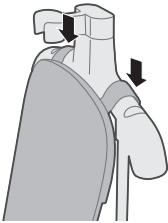

5 Coloque a tábua no cabide.

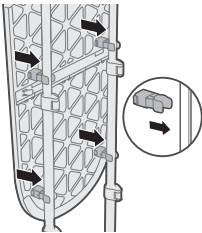

6 Firme a tábua de passar às hastas até fixá-la no lugar (você ouvirá um "clique").

7 Você pode pendurar as suas roupas usando o cabide.

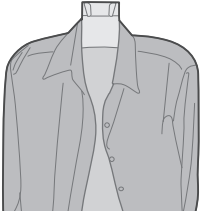
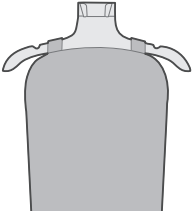

8 Você pode utilizar o seu próprio cabide e colocá-lo sobre a base do vaporizador.

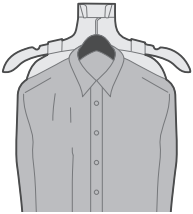

Posicionamento do apoio

1 Prenda a tira do meio na base do vaporizador.

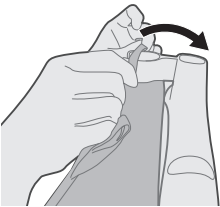

2 Prenda as três tiras no gancho da parte de trás do cabide.

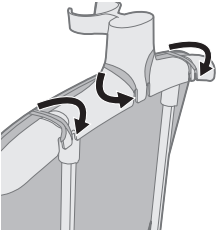

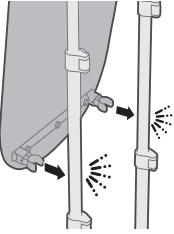

3 Prenda o apoio às hastes até fixá-lo no lugar (você ouvirá um "clique").



4 Você pode pendurar as suas roupas usando o cabide.



5 Você pode utilizar o seu próprio cabide e colocá-lo sobre a base do vaporizador.

Inserção da escova

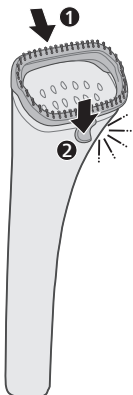

1 Alinhe o tubo ao longo da parte superior do bocal do vaporizador e encaixe o trinco da parte inferior (você ouvirá um "clique").

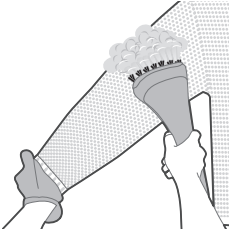

2 Você pode usar a luva e vaporizar as suas roupas utilizando a escova.

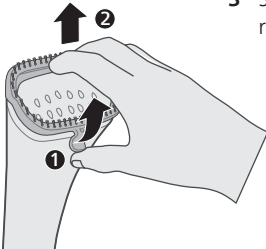

3 Segure e puxe o trinco da parte inferior do bocal do vaporizador para remover a escova.

Abastecimento do reservatório de água

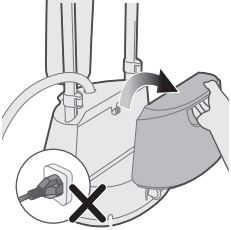

1 Não conecte o aparelho. Remova o reservatório de água da base.

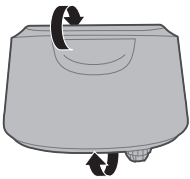

2 Vire o reservatório de água com a tampa virada para cima.

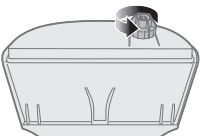

3 Desrosqueie a tampa do reservatório de água no sentido anti-horário para removê-la.

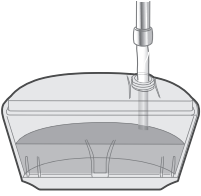

4 Encha o reservatório de água.

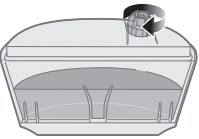

5 Rosqueie a tampa do reservatório de água no sentido horário para apertá-la.

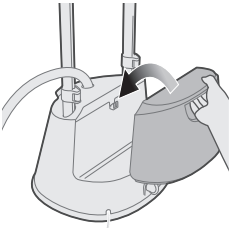

6 Alinhe com o gancho para colocar o reservatório de água de volta à base.

Alteração das configurações de vapor

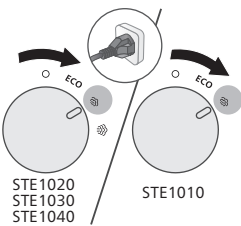

1 Certifique-se de que o aparelho esteja conectado. Gire o botão de vapor para o ajuste de vapor desejado.

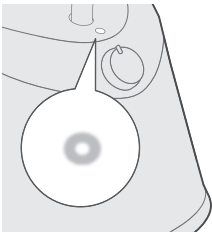

2 A luz se acenderá para indicar que o vaporizador vertical está LIGADO.

*STE1010/75: ~2 min

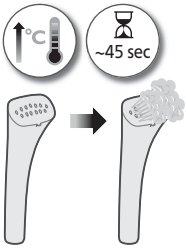

- 3 Aguarde cerca de 45 segundos para que o vaporizador vertical aqueça e emita vapor (STE1010/75: cerca de 2 minutos).

Dicas para passar roupas

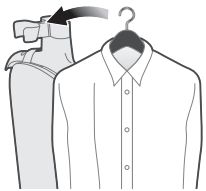

- 1 Você pode utilizar o seu próprio cabide e colocá-lo sobre a base do vaporizador.

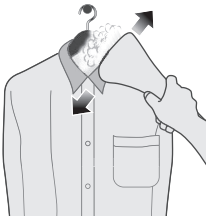

- 2 Mova o bocal do vaporizador em uma direção paralela ao colarinho.

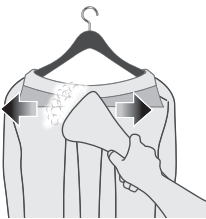

- 3 Mova o bocal do vaporizador em uma direção horizontal ao jugo.

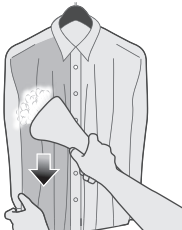

- 4 Estique a peça de roupa. Mova o bocal do vaporizador para baixo sobre a parte da frente da peça de roupa.



5 Mova o bocal do vaporizador para cima sobre um bolso.

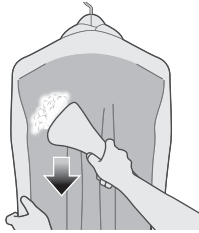

6 Estique a peça de roupa. Mova o bocal do vaporizador para baixo sobre a parte de trás da peça de roupa.

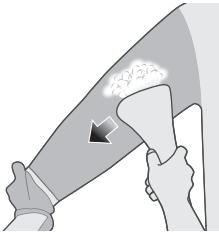

7 Estique a peça de roupa. Mova o bocal do vaporizador numa direção paralela à manga.

Limpeza e manutenção

Coletor de calcário

O seu aparelho foi projetado com um sistema de coleta de calcário. Recomendase que faça a remoção de impurezas uma vez por mês ou mais. Isso ajuda a manter um bom desempenho do vapor e a evitar que manchas e sujeiras saiam da base ao longo do tempo.

Dica: O sistema de coleta de calcário pode ser usado a qualquer momento. Se você vive em uma área de água dura, use a função com mais frequência.

Execução do processo de remoção de impurezas

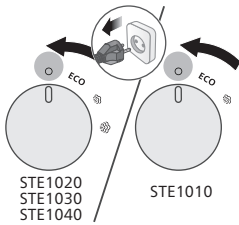

- 1 Certifique-se de que o botão de vapor esteja na posição DESLIGADO e de que o aparelho esteja desconectado.



- 2 Certifique-se de que o ferro tenha esfriado completamente (> 1 hora).

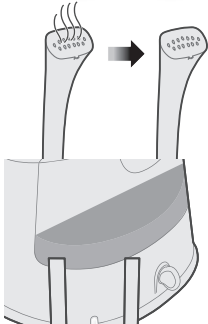

- 3 Coloque o vaporizador próximo a um ralo.

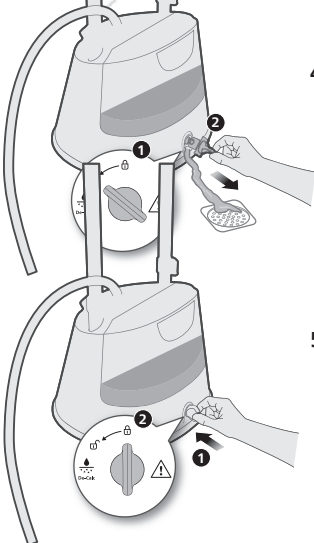

- 4 Gire o botão de remoção de impurezas para a posição de destravamento e retire o botão de remoção de impurezas. Deixe a água drenar.

- 5 Insira e gire o botão de remoção de impurezas para a posição de travamento.

Limpeza e armazenamento do vaporizador vertical

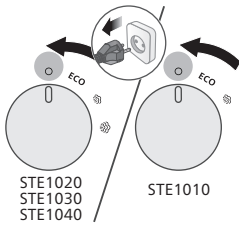

- 1 Certifique-se de que o botão de vapor esteja na posição DESLIGADO e de que o aparelho esteja desconectado.

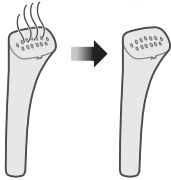

- 2 Certifique-se de que o ferro tenha esfriado completamente (> 1 hora).

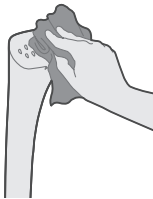

- 3 Limpe o local do vapor com um pano úmido.



- 4 Esvazie o reservatório de água completamente.

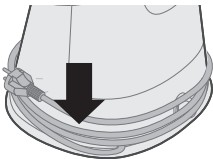

- 5 Enrole o cabo de energia ao redor da base.

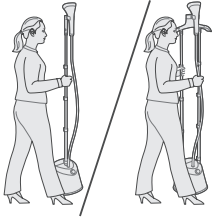

6 Você pode transportar o vaporizador vertical segurando-o pela haste.

Solução de problemas

Este capítulo resume os problemas mais comuns que você pode entrar no aparelho. Caso você não consiga solucionar o problema com as informações abaixo, acesse www.philips.com/support para obter uma lista de perguntas frequentes ou entre em contato com a Central de Atendimento ao Cliente do seu país.

Problema	Possível causa	Solução
O aparelho não produz vapor ou vapor irregular.	O vaporizador não aqueceu o suficiente.	Deixe o aparelho aquecer por aproximadamente 45 segundos (STE1010//75: cerca de 2 minutos).
	O vapor se condensou na mangueira.	Levante o bocal do vaporizador para posicionar a mangueira verticalmente. Isso permite que o vapor concentrado seja liberado.
	Baixo nível de água no reservatório ou o reservatório não está inserido corretamente.	Encha novamente o reservatório de água e insira-o corretamente.
	Muito acúmulo de impurezas no aparelho.	Execute o processo de remoção de impurezas. Consulte a seção "Função Calc-Clean".
Pingos de água caem do bocal do vaporizador ou o aparelho emite um ruído estranho.	Você deixou o bocal do vaporizador e/ou a mangueira de fornecimento de vapor na posição horizontal durante um longo período.	Levante o bocal do vaporizador para posicionar a mangueira verticalmente. Isso permite que o vapor concentrado seja liberado.
	Se a mangueira estiver dobrada, o vapor concentrado na mangueira não voltará para o reservatório de água.	Levante o bocal do vaporizador para posicionar a mangueira verticalmente. Isso permite que o vapor concentrado seja liberado.

Uma quantidade excessiva de água sai do bocal do vaporizador quando o aparelho está aquecendo.

A água no aparelho está suja ou foi deixada no interior do aparelho durante um longo período.

Execute o processo de remoção de impurezas. Consulte a seção "Função Calc-Clean".

Ocorre vazamento de água da base do vaporizador.

A tampa do reservatório de água ou o botão de remoção de impurezas não foi fechado corretamente. O reservatório de água não foi inserido corretamente.

Feche a tampa do reservatório de água ou o botão de remoção de impurezas corretamente. Insira o reservatório de água corretamente.

Introducere

Felicitări pentru achiziție și bun venit la Philips! Pentru a beneficia pe deplin de asistența oferită de Philips, înregistrează-ți produsul la www.philips.com/welcome. Citește cu atenție acest manual de utilizare, pagina cu informații importante și ghidul de inițiere rapidă înainte de a utiliza aparatul. Păstrează-le pentru consultare ulterioară.

Prezentare generală a produsului

STE1020, STE1030, STE1040

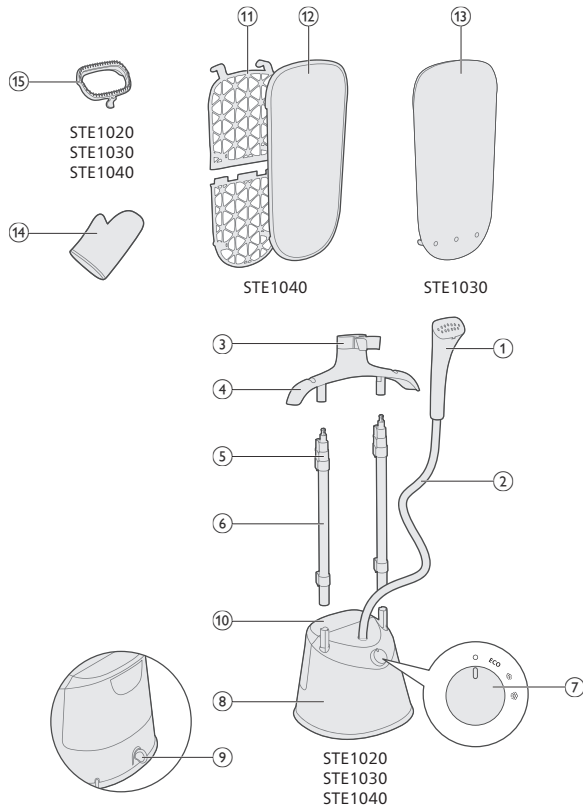

STE1010

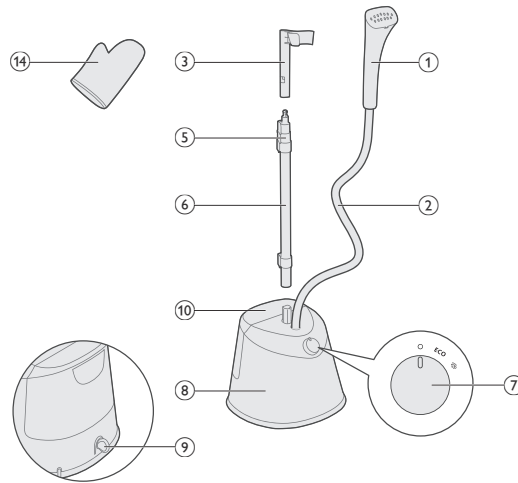

- 1 Cap de aparat de călcat cu aburi
- 2 Furtun de alimentare cu abur
- 3 Doc pentru aparatul de călcat cu aburi
- 4 Umeraș (STE1020, STE1030, STE1040)
- 5 Clemă de blocare a piciorului
- 6 Picior
- 7 Buton de abur
- 8 Bază
- 9 Buton de detartrare
- 10 Rezervorul de apă
- 11 Masă (STE1040)
- 12 Husă (STE1040)
- 13 Covoraș (STE1030)
- 14 Mănușă
- 15 Perie (STE1020, STE1030, STE1040)

Pregătirea pentru utilizare

Tipul de apă de utilizat

Aparatul poate fi folosit cu apă de la robinet. Totuși, dacă locuiești într-o zonă cu apă dură, îți recomandăm să amesteci o cantitate egală de apă de la robinet cu apă distilată sau demineralizată. Acest lucru va preveni acumularea rapidă a calcarului și va prelungi durata de viață a aparatului.

Nu adăuga parfum, apă din mașina de uscat prin centrifugare, oțet, amidon, agenți de detartrare, aditivi de călcare, apă dedurizată chimic sau alte substanțe chimice, deoarece acestea pot provoca vărsarea apei, colorarea în maro sau deteriorarea aparatului tău.

Avertismente

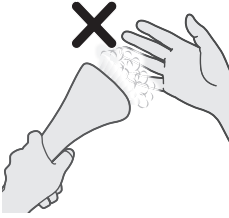

1 Nu atinge direct aburul cu nicio parte a pielii.



2 Nu îndrepta placa de aburi spre alte persoane.

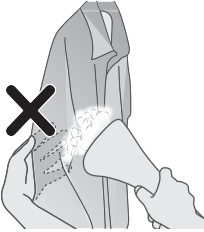

3 Nu ține articolul vestimentar astfel încât să intre în contact direct cu aburul.

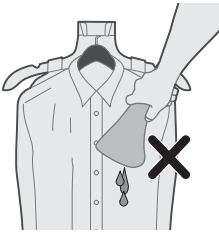

4 Nu folosi capul aparatului de călcat cu aburi îndreptat în jos.

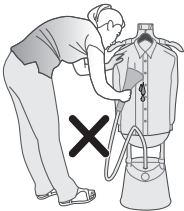

5 Nu îndoi furtunul pentru a călca articolul vestimentar.

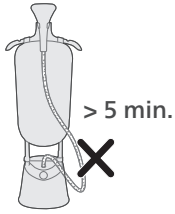

- 6 Nu lăsa aparatul de călcat cu aburi vertical nesupravegheat mai mult de 5 minute.

Instalarea aparatului

STE1010

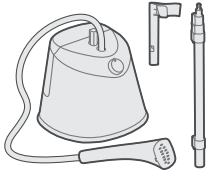

- 1 Inventariază piesele disponibile pentru aparatul cumpărat de tine.

STE1020, STE1030
STE1040



STE1010

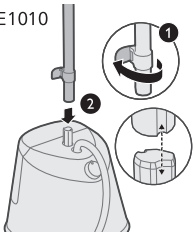

- 2 Deblochează clemenele inferioare de blocare a piciorului și introdu piciorul/picioarele în bază. Asigură-te că profilurile piciorului/picioarelor și știfturile pentru picioare ale bazei sunt alinierte.

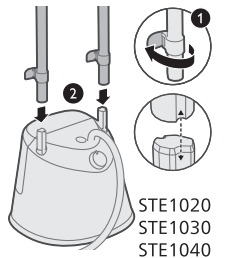

STE1020
STE1030
STE1040

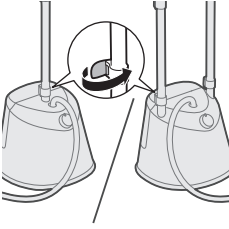

3 Blochează clemele inferioare de blocare a piciorului.

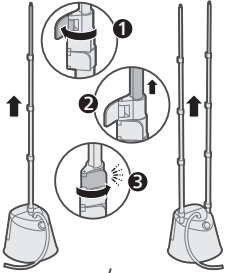

4 Deblochează clemele de blocare a piciorului rămase, extinde complet piciorul/picioarele în sus și blochează-l(e).

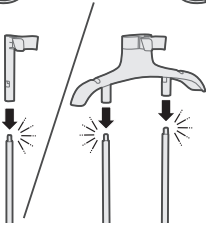

5 Introdu docul aparatului de călcat cu aburi pe picior/picioare până când se blochează pe poziție (face clic).

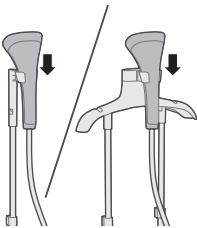

6 Așază capul aparatul de călcat cu aburi pe docul aparatului de călcat cu aburi.

Instalarea mesei

1 Inventariază piesele disponibile pentru aparatul cumpărat de tine.

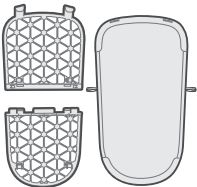

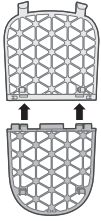

2 Aliniază și introdu clemele mesei până când se blochează pe poziție (fac clic).



3 Aliniază și introdu husa mesei prin cârligele mesei.

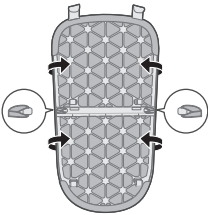

4 Așață benzile husei pentru masă de cârligele de pe partea posterioară a mesei

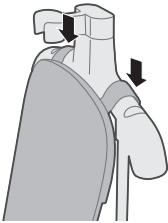

5 Așază masa pe umerăș.

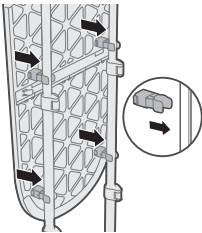

6 Fixează masa pe picioare până când se blochează pe poziție (face clic).

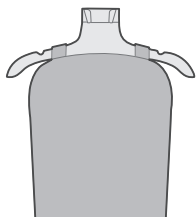

7 Poți agăța hainele folosind umerașul.

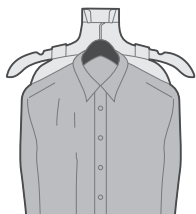
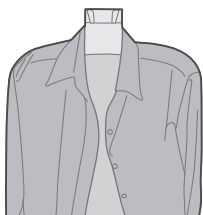

8 Poți folosi propriul umeraș și îl poți agăța de docul aparatului de călcat cu aburi.

Instalarea covorașului

1 Introdu banda din mijloc prin docul aparatului de călcat cu aburi

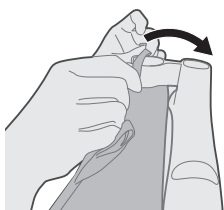

2 Fixează cele 3 benzi pe cârligul din partea posterioară a umerașului.

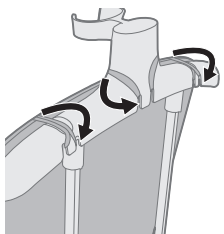

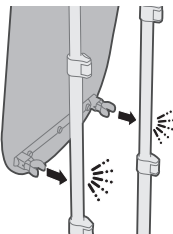

3 Fixează covorașul pe picioare până când se blochează pe poziție (face clic).

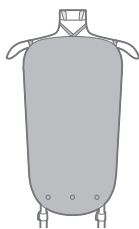

4 Poți agăța hainele folosind umerășul.



5 Poți folosi propriul umerăș și îl poți agăța de docul aparatului de călcat cu aburi.

Introducerea periei

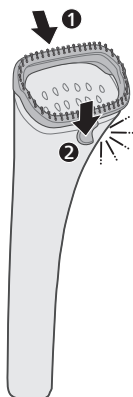

1 Aliniază șina de-a lungul părții superioare a capului aparatului de călcat cu aburi și fixează clema în partea inferioară (face clic).

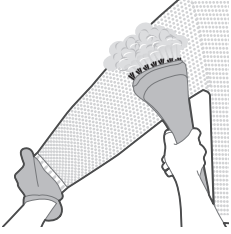

2 Poți purta mănușa și poți călca hainele folosind accesoriul perie.

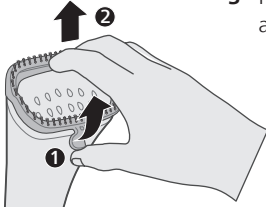

3 Prinde și trage clema din partea inferioară a capului aparatului de călcat cu aburi pentru a scoate accesoriul perie.

Umplerea rezervorului de apă

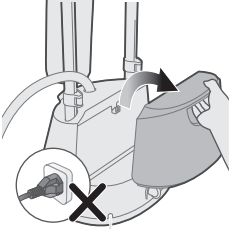

1 Nu conecta aparatul la priză. Scoate rezervorul de apă din bază.

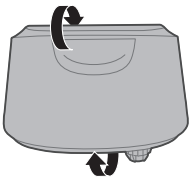

2 Întoarce rezervorul de apă, cu capacul rezervorului orientat în sus.

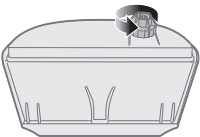

3 Deșurubează capacul rezervorului în sens antiorar pentru a-l scoate.

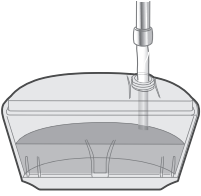

4 Umple rezervorul de apă.

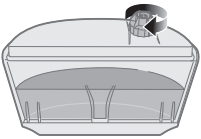

5 Înșurubează capacul rezervorului în sens orar pentru a-l strânge.

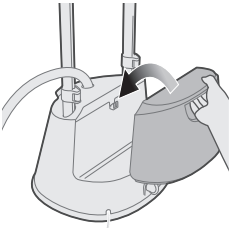

6 Aliniază cu cârligul pentru a așeza rezervorul de apă înapoi în bază.

Modificarea setărilor de abur

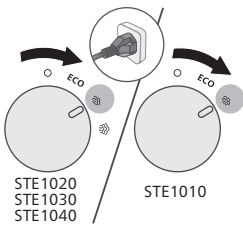

1 Asigură-te că aparatul este conectat la priză. Rotește selectorul de abur la setarea de abur dorită.

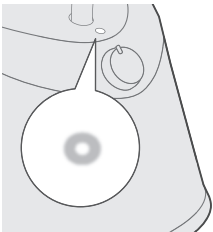

2 Indicatorul se va aprinde continuu pentru a indica faptul că aparatul de călcat vertical cu abur este pornit.

*STE1010/75: ~2 min

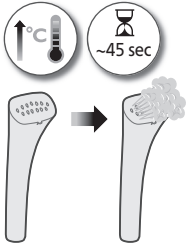

- 3 Așteaptă aproximativ 45 de secunde pentru ca aparatul de călcat vertical cu abur să se încălzească și să producă abur (STE1010/75: circa 2 minute).

Sfaturi pentru călcat

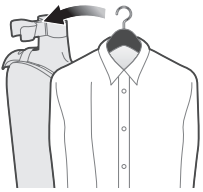

- 1 Poți folosi propriul umeraș și îl poți agăța de docul aparatului de călcat cu aburi.

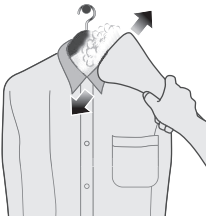

- 2 Deplasează capul aparatului de călcat cu aburi în direcție paralelă cu gulerul.



- 3 Deplasează capul aparatului de călcat cu aburi în direcție orizontală cu platca.

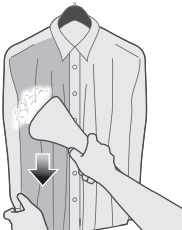

- 4 Întinde articolul vestimentar. Deplasează capul aparatului de călcat cu aburi în jos pe partea din față a articolului vestimentar.



5 Deplasează capul aparatului de călcat cu aburi în sus pe un buzunar.

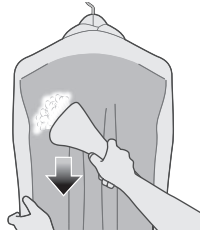

6 Întinde articolul vestimentar. Deplasează capul aparatului de călcat cu aburi în jos pe partea din spate a articolului vestimentar.

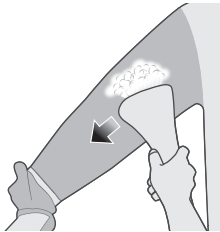

7 Întinde articolul vestimentar. Deplasează capul aparatului de călcat cu aburi în direcție paralelă cu mâneca.

Curățare și întreținere

Colector de calcar

Aparatul tău este proiectat cu un sistem de colectare a calcarului. Îți recomandăm să efectuezi detartrarea o dată pe lună sau mai des. Acest lucru te ajută să menții o performanță puternică a aburului și previne ieșirea murdăriei și a petelor din talpă în timp.

Sugestie: Sistemul de colectare a calcarului poate fi folosit în orice moment. Dacă locuiești într-o zonă cu apă dură, folosește funcția mai frecvent.

Efectuarea procesului de curățarea a calcarului

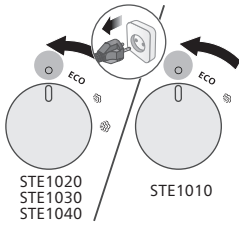

1 Asigură-te că selectorul de abur este la poziția oprit și aparatul este deconectat de la priză.

2 Asigură-te că fierul de călcat s-a răcit complet (> 1 oră).

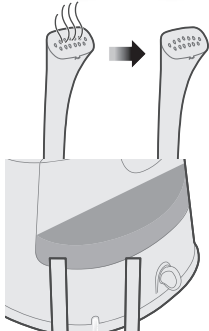

3 Apropie aparatul de călcat cu aburi de o scurgere.

4 Rotește butonul de detartrare la poziția deblocat și scoate butonul de detartrare. Lasă apa să se scurgă.

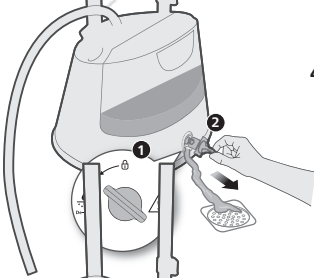

5 Introdu și rotește butonul de detartrare la poziția blocat.

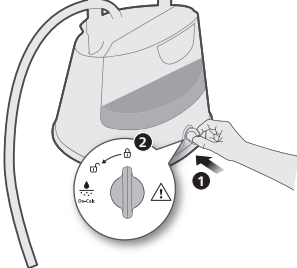

Curățarea și depozitarea aparatului de călcat cu aburi vertical

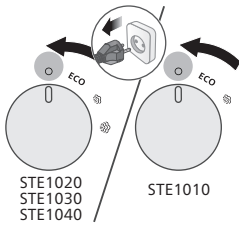

- 1 Asigură-te că selectorul de abur este la poziția oprit și aparatul este deconectat de la priză.

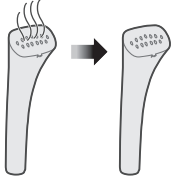

- 2 Asigură-te că fierul de călcat s-a răcit complet (> 1 oră).

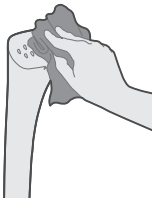

- 3 Șterge zona de aburi cu o lavetă umedă.



- 4 Golește complet rezervorul de apă.

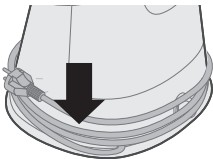

- 5 Înfășoară cablul de alimentare în jurul bazei.

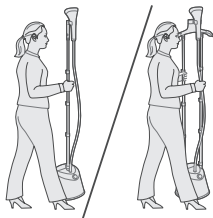

- 6 Poți transporta aparatul de călcat cu aburi vertical ținându-l de picior.

Depanare

Acest capitol descrie cele mai frecvente probleme pe care le poți avea la utilizarea aparatului. Dacă nu poți rezolva problema cu ajutorul informațiilor de mai jos, accesează www.philips.com/support, unde vei găsi o listă de întrebări frecvente, sau contactează Centrul de asistență pentru clienți din țara ta.

Problemă	Cauză posibilă	Soluție
Aparatul nu produce abur sau produce abur neregulat.	Aparatul de călcat cu abur nu s-a încălzit suficient.	Lasă aparatul să se încălzească timp de aproximativ 45 de secunde (STE1010/75: circa 2 minute).
	Aburul a format condens în furtun.	Ridică capul aparatului de călcat cu abur pentru a ține furtunul drept pe verticală. Astfel condensul se poate scurge înapoi.
	Nivel de apă scăzut în rezervor sau rezervorul nu este introdus corespunzător.	Reumple rezervorul de apă și introdu-l corespunzător.
	S-a acumulat prea mult calcar în aparat.	Efectuează procesul de detartrare. Consultă secțiunea Calc-Clean.
Se scurg picături de apă din aparatul de călcat vertical cu abur sau aparatul produce un sunet de cârâit.	Ai lăsat capul aparatului de călcat cu abur și/sau furtunul de alimentare cu abur în poziție orizontală pe o perioadă îndelungată.	Ridică capul aparatului de călcat cu abur pentru a ține furtunul drept pe verticală. Astfel condensul se poate scurge înapoi.
	Când furtunul se așază în formă de U, condensul din furtun nu se poate scurge înapoi în rezervorul de apă.	Ridică capul aparatului de călcat cu abur pentru a ține furtunul drept pe verticală. Astfel condensul se poate scurge înapoi.

O cantitate excesivă de apă se scurge din capul aparatului de călcat cu abur când aparatul se încălzește.

Apa din aparat este murdară sau a fost lăsată în aparat pentru mult timp.

Efectuează procesul de detartrare. Consultă secțiunea Calc-Clean.

Apa se scurge din baza aparatului de călcat vertical cu abur.

Nu ai închis bine capacul rezervorului de apă sau butonul de detartrare. Rezervorul de apă nu este introdus corect.

Închide bine capacul rezervorului de apă și butonul de detartrare. Introdu corespunzător rezervorul.

Hyrje

Urime për blerjen dhe mirë se vini te Philips! Për të përfituar plotësisht nga mbështetja që ofron Philips, regjistroni produktin në faqen www.philips.com/welcome. Lexojini me kujdes manualin e përdorimi, fletëpalosjen e informacionit të rëndësishëm dhe manualin e shpejtë përpara se ta përdorni pajisjen. Ruajini për referencë në të ardhmen.

Përmbledhje e produktit

STE1020, STE1030, STE1040

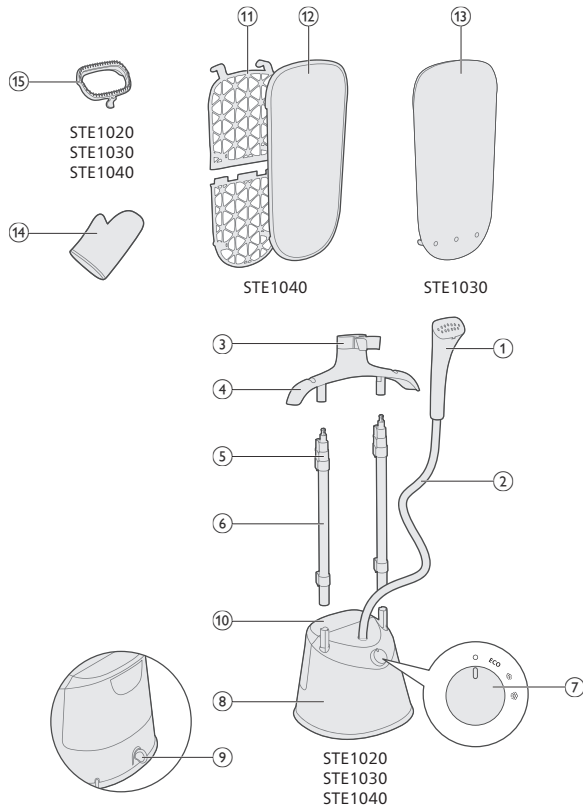

STE1010

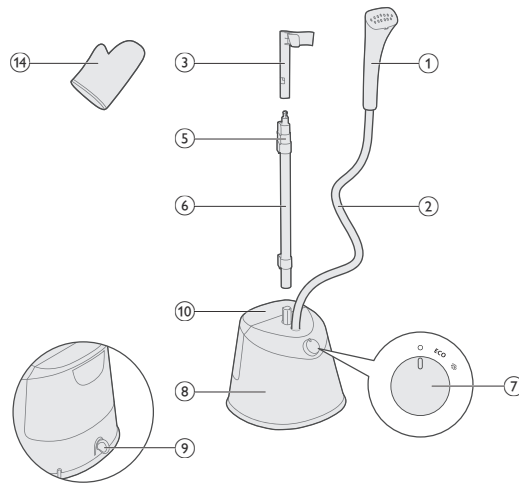

- 1 Koka avulluese
- 2 Zorra e avullit
- 3 Platforma e avulluesit
- 4 Varësja (STE1020, STE1030, STE1040)
- 5 Kapësja e fiksimit të shufrës
- 6 Këmba
- 7 Disku i avullit
- 8 Bazamenti
- 9 Çelësi i pastrimit të çmërsit
- 10 Depozita e ujit
- 11 Dërrasa (STE1040)
- 12 Mbulesa (STE1040)
- 13 Shtroja (STE103X)
- 14 Doreza
- 15 Furça (STE1020, STE1030, STE1040)

Përgatitja për përdorim

Lloji i ujit për përdorim

Pajisja është e përshtatshme për përdorim me ujë rubineti. Por megjithatë, nëse banoni në zona me ujë të fortë, ne rekomandojmë të përzieni një sasi të barabartë uji nga çezma me ujë të distiluar ose të çmëruar. Kjo parandalon formimin e shpejtë të bigorrit dhe rrit jetëgjatësinë e pajisjes.

Mos shtoni parfum, ujë nga tharësja e rrobave, uthull, niseshte, solucione zhgëlqerëzimi, solucione për hekurosje, ujë të pastruar nga gëlqerja me procese kimike, pasi këto mund të shkaktojnë dalje të ujit, njollosjen apo dëmtimin e pajisjes suaj.

Paralajmërimet

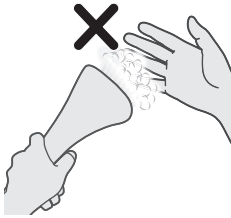

1 Mos vendosni asnjë pjesë të lëkurës në kontakt të drejtpërdrejtë me avullin.



2 Mos e drejtoni pllakën me avull drejt personave të tjerë.

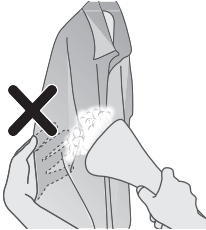

3 Mos e mbani veshjen në një mënyrë që është në kontakt të drejtpërdrejtë me avullin.

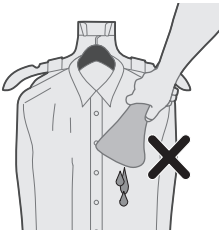

4 Mos e përdorni kokën e avulluesit në drejtim poshtë.

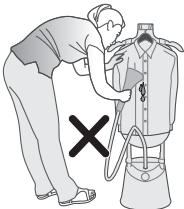

5 Mos e përkulni zorrën për të avulluar rrobat.

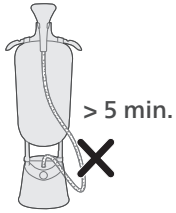

- 6 Mos e lini avulluesin pa mbikëqyrje për më shumë se 5 minuta.

Përgatitja e pajisjes

STE1010

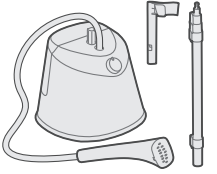

- 1 Kini parasysh pjesët që ofrohen për pajisjen e blerë.

STE1020, STE1030
STE1040



STE1010

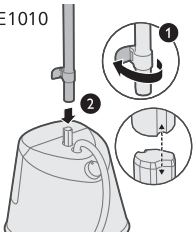

- 2 Shkëqni kapëset e kyçjes së shufrës së poshtme dhe futni shufrat në bazament. Sigurohuni që profilet e shufrave dhe mbërthesat e shufrave të bazamentit të jenë në vijë.

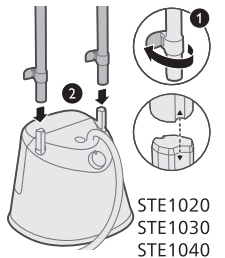

STE1020
STE1030
STE1040

356 Shqip

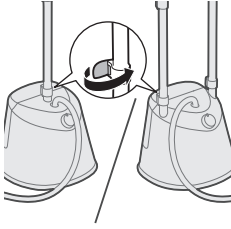

3 Këçni kapëset e këqjes së shufrës së poshtme.

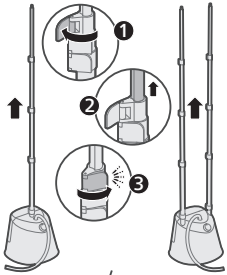

4 Shkëçni kapëset e këqjes së shufrave të mbetura, hapini plotësisht shufrat lart dhe këçini.

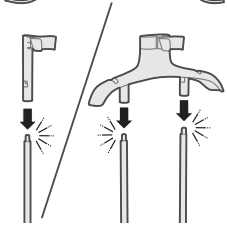

5 Fusni platformën e avulluesit në shufra derisa të këçet në vend ("klik").

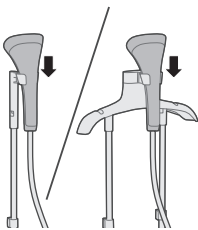

6 Vendoseni kokën e avulluesit në platformën e avulluesit.

Përgatitja e dërrasës

1 Kini parasysh pjesët që ofrohen për pajisjen e blerë.

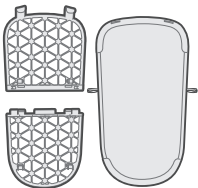

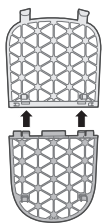

2 Drejtoni dhe futni kapëset e dërrasës derisa të kyçet në vend ("klik").

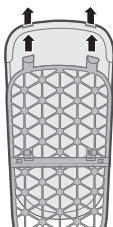

3 Drejtoni dhe futni mbulesën e dërrasës përmes grepave të dërrasës.

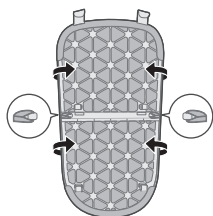

4 Kapni rripat e mbulesës së dërrasës në grepat në pjesën e pasme të dërrasës

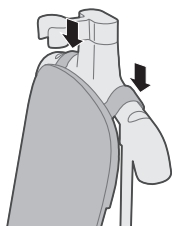

5 Vendoseni dërrasën në varëse.

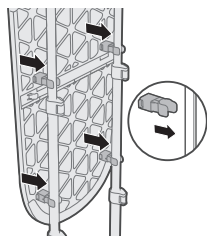

6 Sigurojeni dërrasën mbi shufra derisa të kyçet në vend ("klik").

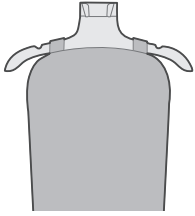

7 Mund t'i mbështillni rrobat duke përdorur varësen.

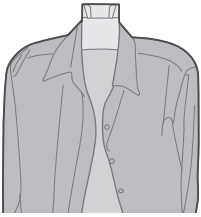

8 Mund të përdorni varësen dhe ta vendosni në platformën e avulluesit.

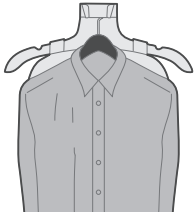

Përgatitja e shtrrojës

1 Fusni rripin e mesëm përmes platformës së avulluesit.

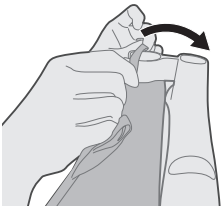

2 Siguroni 3 rripat në grep në pjesën e pasme të varëses.

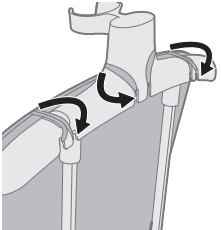

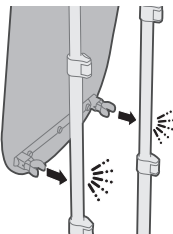

3 Sigurojeni shtrojën mbi shufra derisa të kyçet në vend ("klik").



4 Mund t'i mbështillni rrobat duke përdorur varësen.



5 Mund të përdorni varësen dhe ta vendosni në platformën e avulluesit.

Futja e fuqës

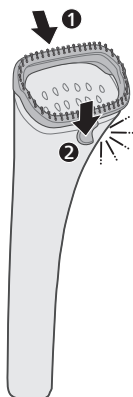

1 Drejtoni fushën përgjatë pjesës së sipërme të kokës së avulluesit dhe mbërtheni kapësen në fund ("klik").

360 Shqip

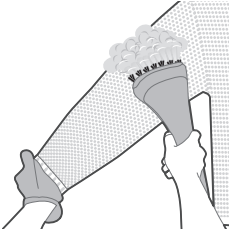

2 Mund të vishni dorezën dhe t'i avulloni rrobat duke përdorur aksesoren e furçës.

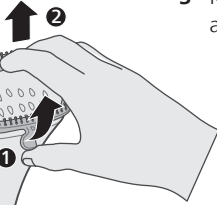

3 Kapni dhe nxirri kapësen nga fundi i kokës së avulluesit për të hequr aksesoren e furçës.

Mbushja e depozitës së ujit

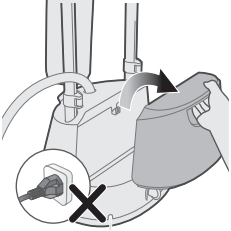

1 Mos e futni pajisjen në prizë. Hiqeni depozitën e ujit nga bazamenti.

2 Kthejeni depozitën e ujit me kapakun për lart.

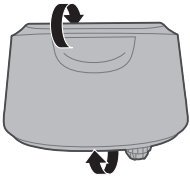

3 Zhvidhosni kapakun e depozitës së ujit në drejtim kundërorar për ta hequr.

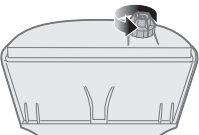

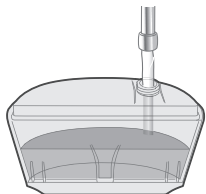

4 Mbushni depozitën e ujit.

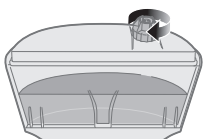

5 Vidhosni kapakun e depozitës së ujit në drejtim orar për ta shtrënguar.

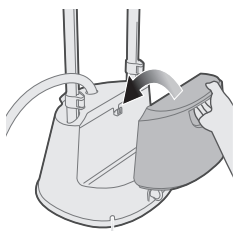

6 Drejtojeni me grepin për ta vendosur depozitën e ujit përsëri në bazament.

Ndryshimi i cilësimeve të avullit

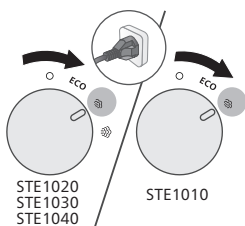

1 Sigurohuni që pajisja të jetë futur në prizë. Rrotulloni çelësin e avullit në cilësimin e dëshiruar të avullit.

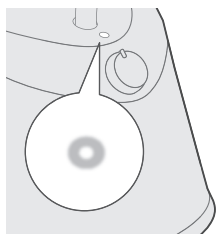

2 Drita do të qëndrojë ndezur për të treguar se avulluesi me bazament është i ndezur.

362 Shqip

*STE1010/75: ~2 min

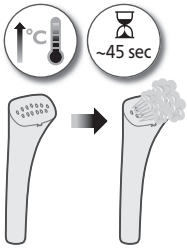

- 3 Prisni për rreth 45 sekonda që avulluesi me bazament të nxehtet dhe të lëshojë avull (STE1010/75: rreth 2 minuta).

Këshilla për hekurosjen

- 1 Mund të përdorni varësen dhe ta vendosni në platformën e avulluesit.

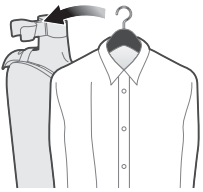

- 2 Lëvizni kokën e avulluesit në një drejtim paralel me jakën.

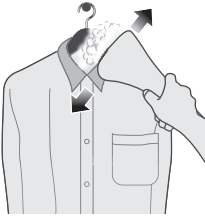

- 3 Lëvizni kokën e avulluesit në drejtim horizontal me boleronë.

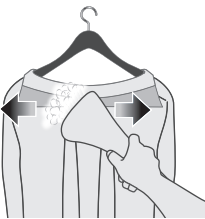

- 4 Tëndosni rrobën. Lëvizni kokën e avulluesit në drejtim poshtë në pjesën e përparme të trupit.

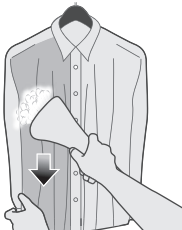



5 Lëvizni kokën e avulluesit në drejtim lart në një xhep.



6 Tendosni rrobën. Lëvizni kokën e avulluesit në drejtim poshtë në pjesën e pasme të trupit.

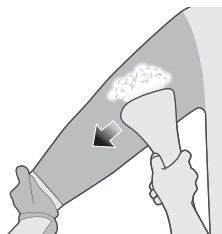

7 Tendosni rrobën. Lëvizni kokën e avulluesit në drejtim paralel me mëngën.

Pastrimi dhe mirëmbajtja

Calc Collector

Pajisja juaj është projektuar me një sistem Calc Collector. Rekomandohet ta bëni zhgëlqerimin një herë në muaj ose më shpesh. Kjo ndihmon për të mbajtur një performancë të lartë me avull dhe parandalon papastërtinë dhe njollat që dalin nga pllaka me kalimin e kohës.

Këshillë: Sistemi Calc Collector mund të përdoret në çdo kohë. Nëse banoni në zonë me ujë të rëndë, përdoreni më shpesh si funksion.

Kryerja e procesit të zhgëlqerimit

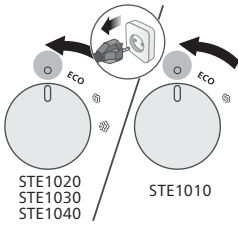

1 Sigurohuni që disku i avullit të jetë në pozicionin fikur dhe pajisja të jetë hequr priza.

2 Sigurohuni që hekuri të jetë ftohur plotësisht (>1 orë).



3 Vendoseni avulluesin pranë një ene shkarkimi.

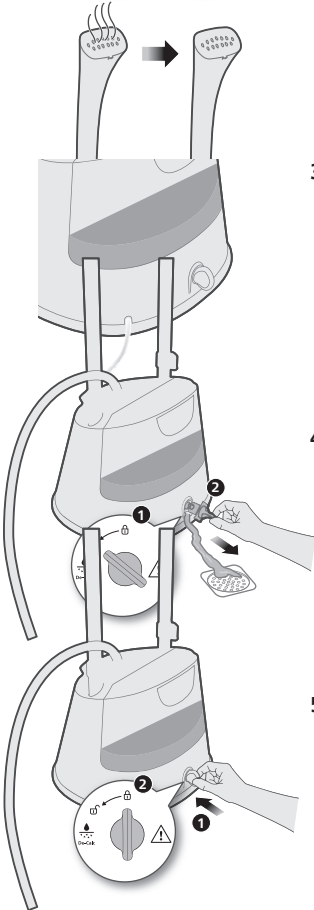

4 Kthejeni dorezën De-calc në pozicionin e shkyçjes dhe hiqni çelësin De-calc. Lëreni ujin të shkarkohet.

5 Fusni dhe rrotulloni dorezën De-calc në pozicionin e kyçjes.

Pastrimi dhe ruajtja e avulluesit me bazament

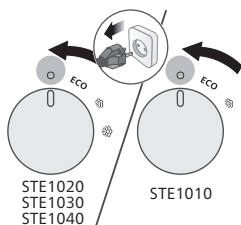

- 1 Sigurohuni që disku i avullit të jetë në pozicionin fikur dhe pajisja të jetë hequr priza.

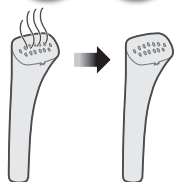

- 2 Sigurohuni që hekuri të jetë ftohur plotësisht (>1 orë).

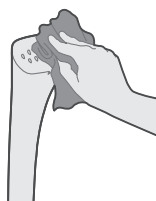

- 3 Fshijeni vendin e avullit me një leckë të lagur.

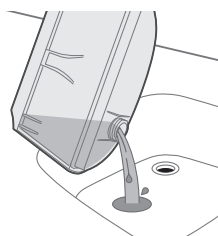

- 4 Zbrazni plotësisht depozitën e ujit.

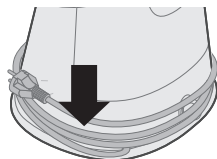

- 5 Mbështilleni kordonin elektrik rreth bazamentit.

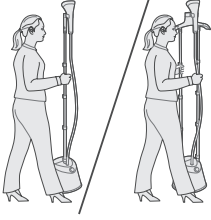

6 Mund ta mbani avulluesin me bazament pranë shufrës.

Diagnostikimi

Ky kapitull përmbledh problemet më të shpeshta që mund të hasni me pajisjen. Nëse nuk keni mundësi ta zgjidhni problemin me informacionin e mëposhtëm, vizitoni www.philips.com/support për një listë të pyetjeve të shpeshta ose kontaktoni me qendrën e shërbimit të klientit për shtetin tuaj.

Problemi	Shkaku i mundshëm	Zgjidhja
Pajisja nuk prodhon avull ose prodhon avull të çrregullt.	Avulluesi nuk është ngrohur mjaftueshëm.	Lëreni pajisjen të ngrohet për rreth 45 sekonda (STE1010/75: rreth 2 minuta).
	Avulli është kondensuar në zorrë.	Ngrijeni kokën avulluese për ta drejtuar vertikalisht zorrën. Kjo lejon që kondensimi i mundshëm të rrjedhë prapa.
	Ka nivel të ulët uji në depozitë ose depozita nuk është futur mirë.	Rimbushni depozitën e ujit dhe futeni mirë.
	Është krijuar shumë çmërs në pajisje.	Kryeni procesin e pastrimit të çmërsit. Shihni seksionin Calc-Clean.
Pikon ujë nga koka avulluese, ndonjëherë pajisja lëshon tingull kërcitës.	E keni lënë kokën avulluese dhe/ose zorrën e furnizimit me avull në pozicion horizontal për një kohë të gjatë.	Ngrijeni kokën avulluese për ta drejtuar vertikalisht zorrën. Kjo lejon që kondensimi i mundshëm të rrjedhë prapa.
	Kur zorra merr formë U, kondensimi në zorrë nuk mund të rrjedhë përsëri në depozitë.	Ngrijeni kokën avulluese për ta drejtuar vertikalisht zorrën. Kjo lejon që kondensimi i mundshëm të rrjedhë prapa.
Një sasi e tepërt uji rrjedh nga koka e avullit kur pajisja nxehet.	Uji në pajisje është i ndotur ose ka mbetur brenda pajisjes për një kohë të gjatë.	Kryeni procesin e pastrimit të çmërsit. Shihni seksionin Calc-Clean.
Del ujë nga bazamenti i avulluesit.	Nuk e keni mbyllur mirë kapakun e depozitës së ujit ose çelësin e pastrimit të çmërsit. Depozita e ujit nuk është futur siç duhet.	Mbylleni mirë kapakun e depozitës së ujit ose çelësin e pastrimit të çmërsit. Futeni depozitën siç duhet.

Uvod

Čestitamo vam za nakup in dobrodošli pri Philipsu! Da bi v celoti izkoristili vse prednosti Philipsove podpore, izdelek registrirajte na www.philips.com/welcome. Pred uporabo aparata natančno preberite ta uporabniški priročnik, letak s pomembnimi informacijami in vodnik za hiter začetek. Shranite jih za poznejšo uporabo.

Pregled izdelka

STE1020, STE1030, STE1040

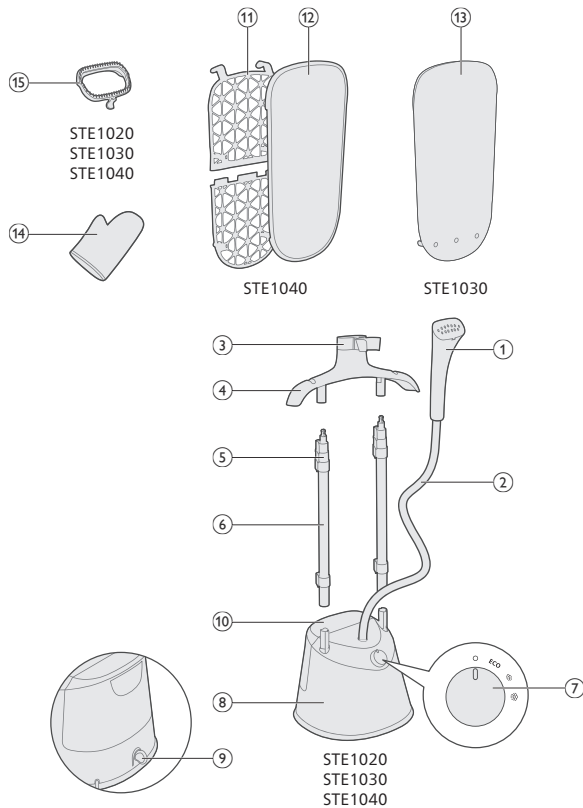

STE1010

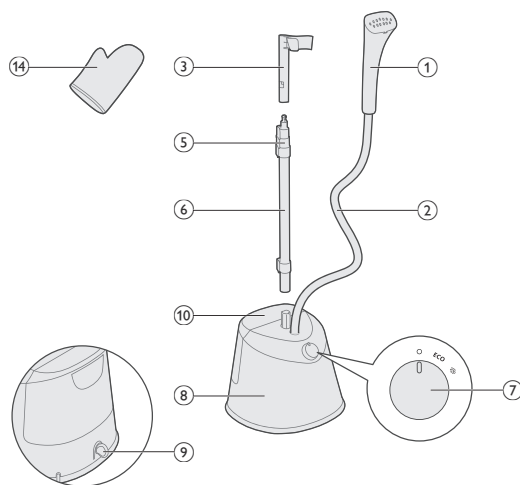

- 1 Glava parne enote
- 2 Cev za dovod pare
- 3 Odložišče parne enote
- 4 Obešalnik (STE1020, STE1030, STE1040)
- 5 Zaklepna sponka za drog
- 6 Drog
- 7 Regulator pare
- 8 Podstavek
- 9 Gumb za odstranjevanje vodnega kamna
- 10 Posoda za vodo
- 11 Deska (STE1040)
- 12 Prevleka (STE1040)
- 13 Podlaga (STE1030)
- 14 Rokavica
- 15 Krtača (STE1020, STE1030, STE1040)

Priprava pred uporabo

Vrsta vode, ki jo morate uporabiti

Aparat je primeren za uporabo z vodo iz pipe. Če živite na območju s trdo vodo, vam priporočamo, da zmešate enako količino vode iz pipe in destilirane ali demineralizirane vode. S tem preprečite hitro nabiranje vodnega kamna in podaljšate življenjsko dobo aparata.

Ne dodajajte dišav, vode iz sušilnika, kisa, škroba, sredstev za odstranjevanje vodnega kamna, dodatkov za likanje, kemično omeščane vode ali drugih kemikalij, ker to lahko povzroči uhajanje vode, pojav rjavih madežev ali poškodbo aparata.

Opozorila

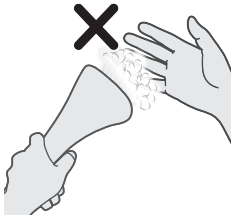

1 Nobenega dela kože ne izpostavljajte neposrednemu stiku s paro.



2 Plošče parne enote ne usmerjajte proti drugim osebam.

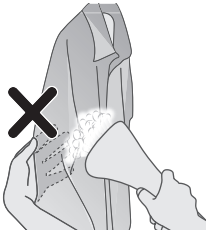

3 Oblečil ne držite na mestu, ki je v neposrednem stiku s paro.



4 Glave parne enote ne uporabljajte obrnjene navzdol.

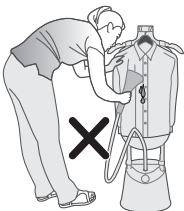

5 Med parnim likanjem oblačil ne zvijajte cevi.

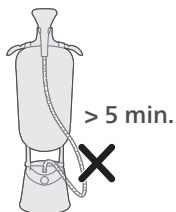

- 6 Pokončnega parnega likalnika ne pustite brez nadzora več kot 5 minut.

Sestavljanje aparata

STE1010

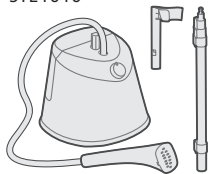

- 1 Oglejte si dele, ki so na voljo za kupljeni aparat.

STE1020, STE1030
STE1040



STE1010

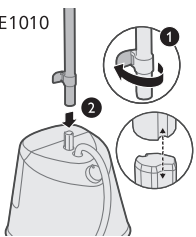

- 2 Sprostite spodnji zaklepni sponki na drogovih in drog(-ova) vstavite v podstavek. Prepričajte se, da so profili droga (-ov) in nastavka (-ov) v podstavku poravnani.

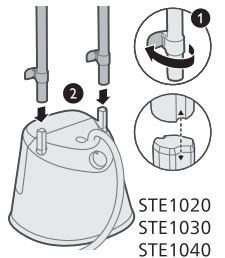

STE1020
STE1030
STE1040

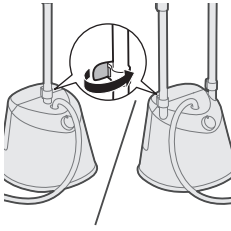

3 Spodnjo zaklepno sponko(-e) na drogu(-ovih) zaklenite.

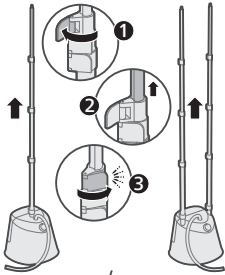

4 Sprostite preostale zaklepne zaponke na drogu(-ovih), drog(-ova) povsem izvlecite navzgor in ga/ju zaklenite.

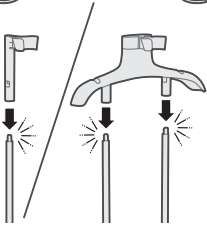

5 Vstavite odložišče parne enote v drog(-ova) tako, da se zaskoči ("klik").

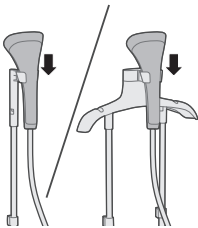

6 Glavo parne enote odložite na namensko odložišče.

Sestavljanje likalne deske

1 Oglejte si dele, ki so na voljo za kupljeni aparat.

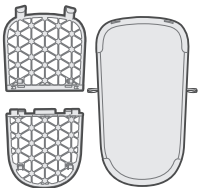

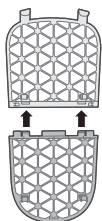

2 Poravnajte in vstavite zaponke deske, da se zaskočijo na svoje mesto ("klik").

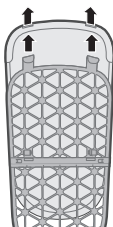

3 Poravnajte in vstavite kljukice deske skozi odprtine v prevleki.

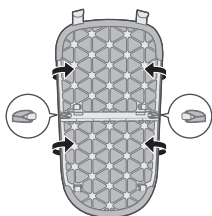

4 Zapnite jermene prevleke za desko za kljukice na hrbtni strani deske.

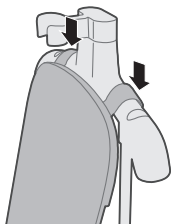

5 Desko obesite na obešalnik.

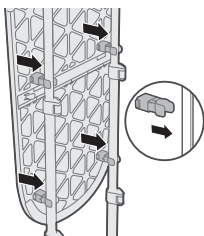

6 Pritrdite desko na drogova tako, da se zaskoči na svoje mesto ("klik").

7 Oblečila lahko obesite na obešalnik.

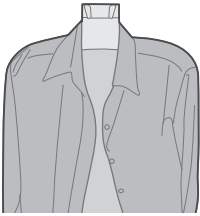
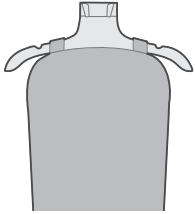

8 Uporabite lahko tudi svoj obešalnik in ga obesite na odložišče parne enote.

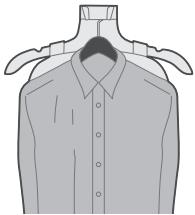

Namestitev podlage

1 Srednji jermen namestite čez odložišče parne enote.

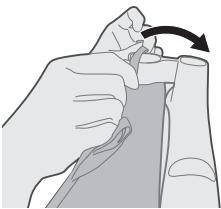

2 Ostale 3 jermene pritrdite na zaponke na hrbtni strani obešalnika.

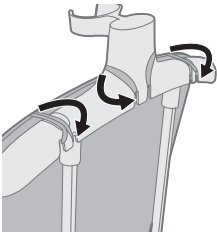

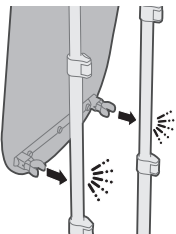

3 Podlago pritrdite na drogova tako, da se zaskoči na svoje mesto ("klik").

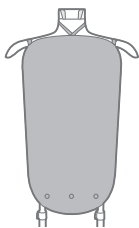

4 Oblečila lahko obesite na obešalnik.



5 Uporabite lahko tudi svoj obešalnik in ga obesite na odložišče parne enote.

Namestitev krtiče

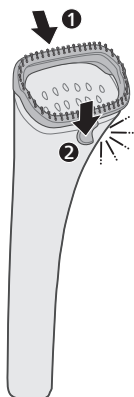

1 Poravnajte utor na zgornji strani glave parne enote in zatakните zaponko na spodnji strani ("klik").

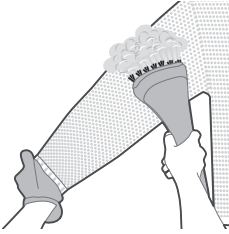

2 Oblečila lahko parno likate s krtačnim nastavkom, če uporabljate rokavico.

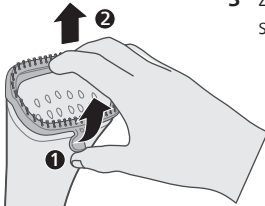

3 Za odstranitev krtačnega nastavka primite in povlecite zaponko na spodnji strani glave parne enote.

Polnjenje posode za vodo

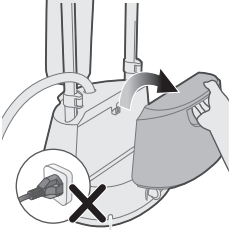

1 Aparata ne priključujte na električno vtičnico. Iz podstavka odstranite posodo za vodo.

2 Posodo za vodo obrnite, tako da je pokrovček usmerjen navzgor.

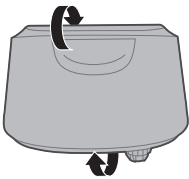

3 Pokrovček odvijte v levo in ga snemite.

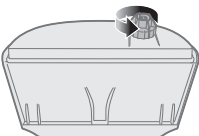

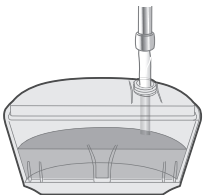

4 Napolnite posodo za vodo.

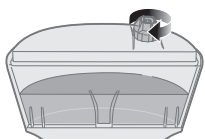

5 Privijte pokrovček posode za vodo in ga zatisnite.

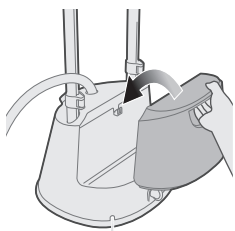

6 Posodo za vodo poravnajte z zaponko in jo vstavite v podstavek.

Spreminjanje nastavitve pare

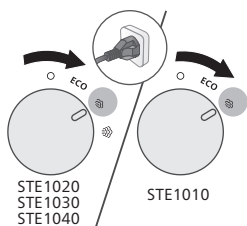

1 Aparat priključite na električno vtičnico. Gumb za izbiro pare obrnite na zeleno nastavitve pare.

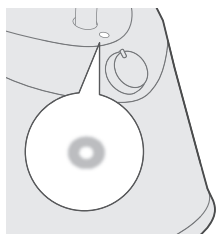

2 Lučka bo neprekinjeno svetila, kar pomeni, da je pokončni parni likalnik **VKLOPLJEN**.

*STE1010/75: ~2 min

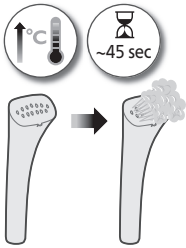

- 3 Počakajte približno 45 sekund, da se pokončni parni likalnik segreje in začne oddajati paro (STE1010/75: približno 2 minuti).

Namigi za likanje

- 1 Uporabite lahko tudi svoj obešalnik in ga obesite na odložišče parne enote.

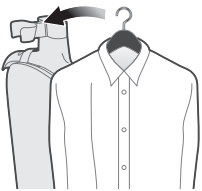

- 2 Glavo parne enote pomikajte vzporedno z ovratnim obrobkom.

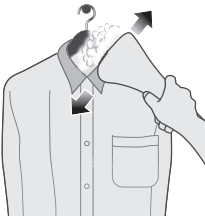

- 3 Glavo parne enote pomikajte vodoravno z ovratnikom.

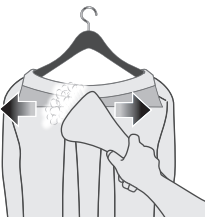

- 4 Oblečilo raztegnite. Na sprednji strani stana pomikajte glavo parne enote navzdol.

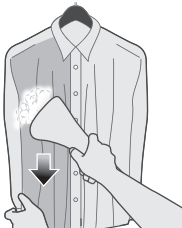



5 Nad žepom pomikajte glava parne enote navzgor.



6 Oblačilo raztegnite. Na hrbtni strani stana pomikajte glavo parne enote navzdol.

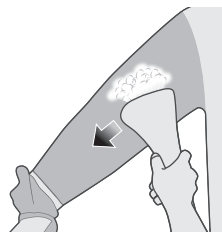

7 Oblačilo raztegnite. Glavo parne enote pomikajte vzporedno z rokavom.

Čiščenje in vzdrževanje

Zbiralnik vodnega kamna

Aparat ima vgrajen sistem za zbiranje vodnega kamna. Priporočamo odstranitev vodnega kamna enkrat mesečno ali pogosteje. To pomaga ohranjati močan izpust pare in preprečuje morebitno iztekanje umazanije in madežev iz likalne plošče.

Namig: Sistem za zbiranje vodnega kamna lahko uporabite kadarkoli. Če živite na območju s trdo vodo, funkcijo uporabite pogosteje.

Izvajanje postopka čiščenja vodnega kamna

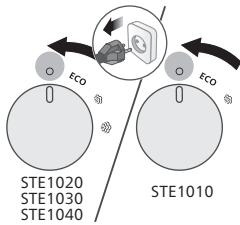

- 1 Prepričajte se, da je gumb za paro v IZKLOPLJENEM položaju in aparat izključen iz električne vtičnice.

- 2 Prepričajte se, da se je likalnik povsem ohladil (> 1 ura).

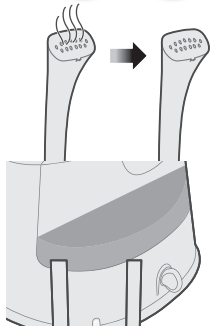

- 3 Parni likalnik postavite blizu odtoka.

- 4 Gumb za izpiranje obrnite v odklenjeni položaj in ga odstranite. Počakajte, da voda odteče.

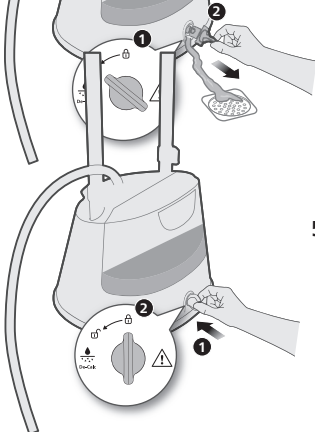

- 5 Vstavite gumb za izpiranje in ga obrnite v zaklenjeni položaj.

Čiščenje in shranjevanje pokončnega parnega likalnika

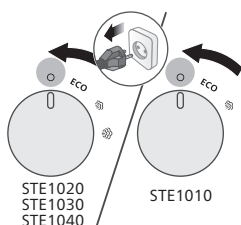

- 1 Prepričajte se, da je gumb za paro v IZKLOPLJENEM položaju in aparat izključen iz električne vtičnice.

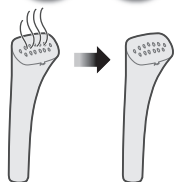

- 2 Preprijajte se, da se je likalnik povsem ohladil (> 1 ura).

- 3 Šobe za paro obrišite z vlažno krpo.

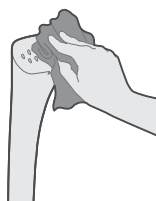

- 4 Posodo za vodo povsem izpraznite.

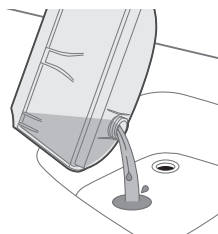

- 5 Napajalni kabel navijte okoli podstavka.

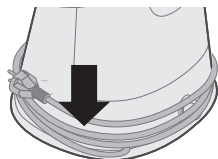

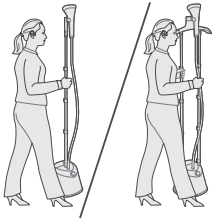

6 Pokončni parni likalnik lahko med nošenjem držite za drog.

Odpravljanje težav

To poglavje vsebuje povzetek najpogostejših težav, ki se lahko pojavijo pri uporabi aparata. Če težav s temi nasveti ne morete odpraviti, na strani www.philips.com/support poiščite seznam pogostih vprašanj ali se obrnite na center za pomoč uporabnikom v svoji državi.

Težava	Možni vzrok	Rešitev
Aparat ne proizvaja pare ali jo proizvaja neenakomerno.	Parna enota se ni dovolj ogrela.	Aparat naj se segreva približno 45 sekund (STE1010/75: približno 2 minuti).
	Para je v cevi kondenzirala.	Dvignite glavo parne enote, da cev poravnate navpično. Tako bo morebiten kondenzat odtekel nazaj v posodo.
	Nivo vode v posodi je nizek ali pa posoda ni pravilno vstavljena.	Posodo za vodo napolnite in jo pravilno vstavite.
Iz glave parne enote kaplja voda ali aparat oddaja nenavaden zvok.	V aparatu se je nabralo preveč vodnega kamna.	Izvedite postopek odstranjevanja vodnega kamna. Glejte razdelek o odstranjevanju vodnega kamna.
	Glavo parne enote in/ali cev za dovajanje pare ste dolgo časa pustili v vodoravnem položaju.	Dvignite glavo parne enote, da cev poravnate navpično. Tako bo morebiten kondenzat odtekel nazaj v posodo.
	Ko se cev upogne v obliko črke U, kondenzat v cevi ne more teči nazaj v posodo za vodo.	Dvignite glavo parne enote, da cev poravnate navpično. Tako bo morebiten kondenzat odtekel nazaj v posodo.
Ko se aparat segreva, iz glave parne enote močno kaplja voda.	Voda v aparatu je umazana oziroma je dolgo časa v aparatu.	Izvedite postopek odstranjevanja vodnega kamna. Glejte razdelek o odstranjevanju vodnega kamna.
Iz podstavka parne enote kaplja voda.	Šepa posode za vodo ali gumba za izpiranje niste pravilno zaprli. Posoda za vodo ni pravilno vstavljena.	Čep posode za vodo ali gumb za izpiranje pravilno zaprite. Pravilno vstavite posodo za vodo.

Úvod

Blahoželáme vám ku kúpe a vítame vás medzi používateľmi produktov spoločnosti Philips! Ak chcete naplno využiť podporu ponúkanú spoločnosťou Philips, zaregistrujte svoj produkt na lokalite www.philips.com/welcome. Pred použitím zariadenia si prečítajte tento návod na použitie, leták s dôležitými informáciami a stručný návod pri spustení. Odložte si ich na neskoršie použitie. Odložte si ich na neskoršie použitie.

Prehľad produktu

STE1020, STE1030, STE1040

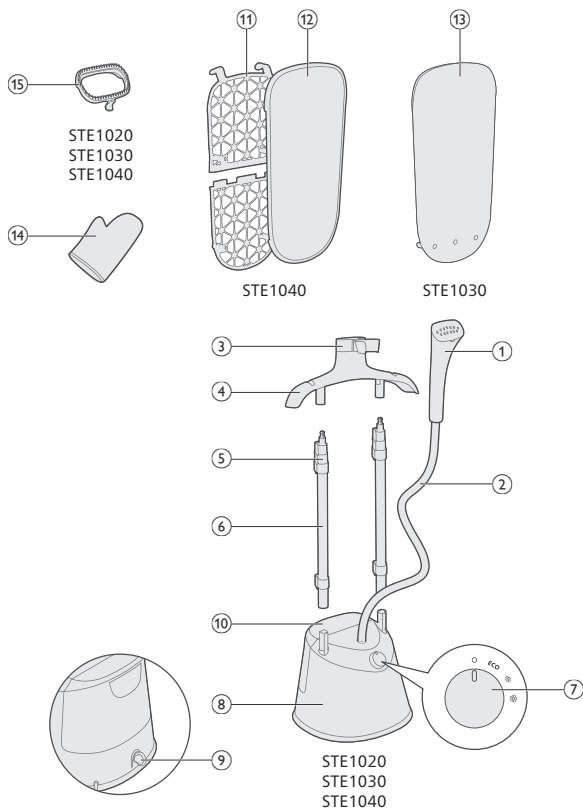

STE1010

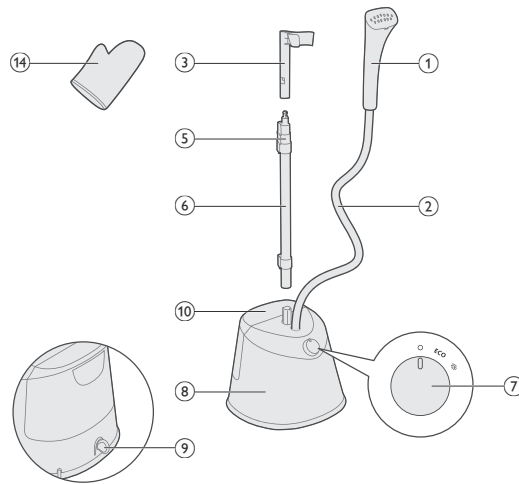

- 1 Naparovacia hlavica
- 2 Hadica na prívod pary
- 3 Parný dok
- 4 Vešiak (STE1020, STE1030, STE1040)
- 5 Svorka zámku tyče
- 6 Tyč
- 7 Parný ovládač
- 8 Základňa
- 9 Gombík Odstraňovač vodného kameňa
- 10 Zásobník na vodu
- 11 Doska (STE1040)
- 12 Kryt (STE1040)
- 13 Podložka (STE1030)
- 14 Rukavica
- 15 Kefka (STE1020, STE1030, STE1040)

Príprava na použitie

Typ vody, ktorý sa má používať

Zariadenie je vhodné na použitie s vodou z vodovodu. Ak však žijete v oblasti s tvrdou vodou, odporúčame vám zmiešať vodu z vodovodu s rovnakým množstvom destilovanej alebo demineralizovanej vody. Predídete tak rýchlemu usadzovaniu vodného kameňa a predĺžite životnosť zariadenia.

Neprikladajte parum, vodu zo sušičky, ocot, škrob, prostriedky na odstránenie vodného kameňa, prostriedky na uľahčenie žehlenia, chemicky zmäkčenú vodu ani žiadne iné chemické látky, pretože môžu spôsobiť prskanie vody, hnedé sfarbenie alebo poškodenie spotrebiča.

Varovania

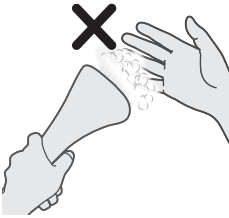

1 Vyhnite sa akémukoľvek priamemu kontaktu pary s pokožkou.



2 Zabezpečte, aby parná plocha nesmerovala na iné osoby.

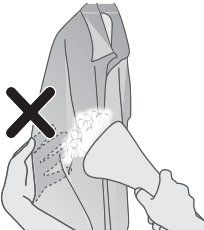

3 Odev nedržte tak, aby sa nachádzal v priamom kontakte s parou.

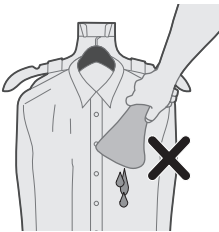

4 Nepoužívajte naparovaciu hlavicu smerom nadol.

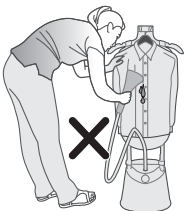

5 Pri naparovaní odevu hadicu neohýbajte.

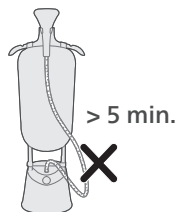

- 6 Nenechávajte stojanový naparovač bez dozoru dlhšie ako 5 minút.

Nastavenie zariadenia

STE1010

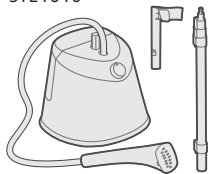

- 1 Pozrite a všimnite si, aké súčasti sú k dispozícii pre zakúpený spotrebič.

STE1020, STE1030
STE1040



STE1010

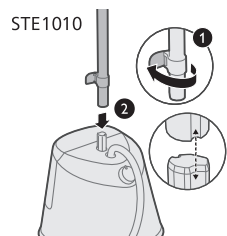

- 2 Odomknite svorky zámku spodnej tyče a nasadte tyč(e) na základňu. Zabezpečte, že profily tyče (tyčí) a základnej tyče (základných tyčí) sú zarovnané.

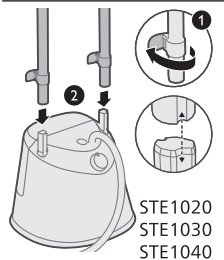

STE1020
STE1030
STE1040

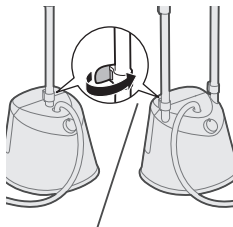

3 Uzamknite svorku (svorky) zámku spodnej tyče.

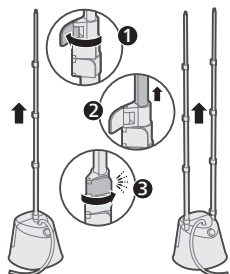

4 Odomknite zvyšné svorky zámku tyče. Tyč(e) úplne vysuňte smerom nahor a zaistite ju.

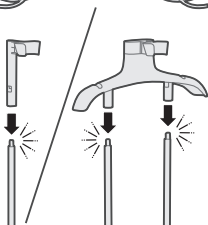

5 Nasadte parný dok na tyč(e), kým sa nezaistí („zacvakne“).

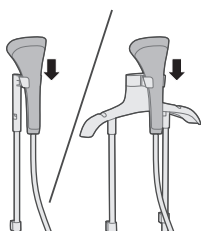

6 Umiestnite naparovaciu hlavicu na parný dok.

Nastavenie dosky

1 Pozrite a všimnite si, aké súčasti sú k dispozícii pre zakúpený spotrebič.

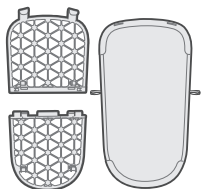

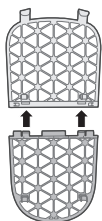

2 Zarovnajte a zasunite svorky dosky, kým sa nezaistia („zacvaknú“).

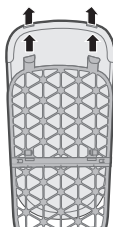

3 Zarovnajte a zasunite kryt dosky cez háčiky dosky.

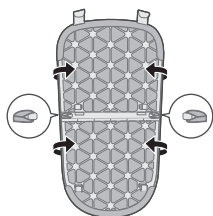

4 Pripevnite popruhy krytu dosky na háčiky na zadnej strane dosky

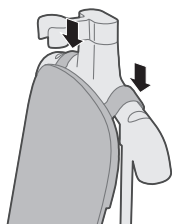

5 Umiestnite dosku na vešiak.

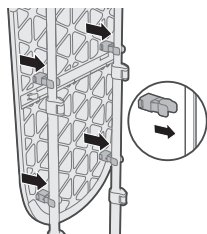

6 Pripevnite dosku na tyče, kým sa nezaistí („zacvakne“).

7 Pomocou vešiaka môžete oblečenie zavesiť.

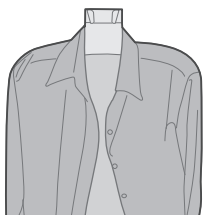
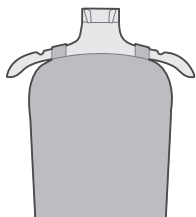

8 Môžete použiť vlastný vešiak a umiestniť ho na parný dok.

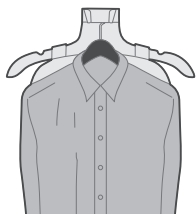

Nastavenie podložky

1 Stredný popruh zasunúť cez parný dok.

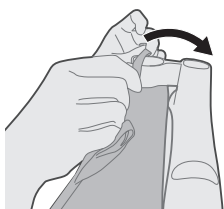

2 Upevnite 3 popruhy na háčik na zadnej strane vešiaka.

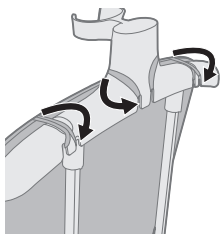

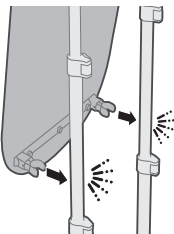

3 Upevnite podložku na tyče, kým sa nezaistí na svojom mieste („zacvakne“).

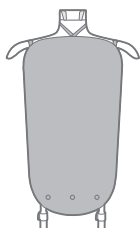

4 Pomocou vešiaka môžete oblečenie zavesiť.



5 Môžete použiť vlastný vešiak a umiestniť ho na parný dok.

Založenie kefky

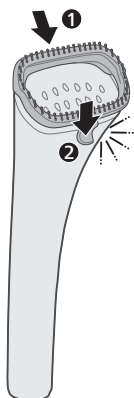

1 Zarovnajte dráhu pozdĺž hornej časti naparovacej hlavice a zacvaknite západku na spodnej strane („zacvakne“).

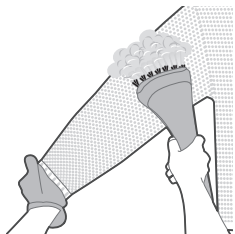

2 Môžete si nasadiť rukavicu a pomocou kefového nadstavca naparovať oblečenie.

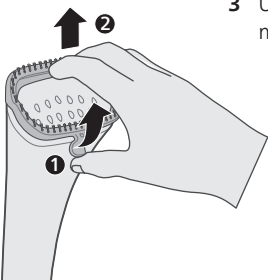

3 Uchopte a vyťahnite zámok zo spodnej časti naparovacej hlavice, aby ste mohli vybrať kefový nástavec.

Plnenie zásobníka na vodu

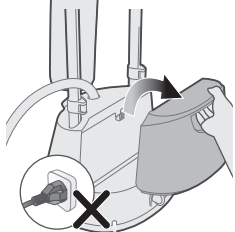

1 Zariadenie nezapájajte do siete. Odstráňte zásobník na vodu zo základne.

2 Zásobník na vodu obráťte tak, aby uzáver smeroval nahor.

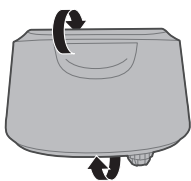

3 Odistite uzáver zásobníka na vodu proti smeru hodinových ručičiek a odstráňte ho.

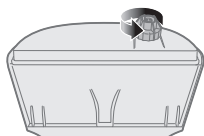

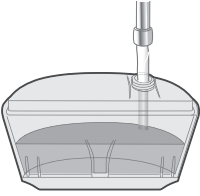

4 Naplňte zásobník na vodu.

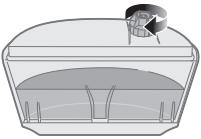

5 Zaskrutkujte uzáver zásobníka na vodu v smere hodinových ručičiek na upevnenie.

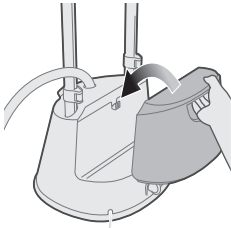

6 Pomocou háčika zarovnajzte zásobník na vodu a umiestnite ho späť na základňu.

Zmena nastavenia pary

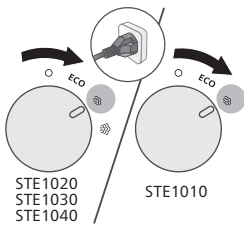

1 Uistite sa, že je zariadenie zapojené do siete. Otočte parný ovládač na požadované nastavenie pary.

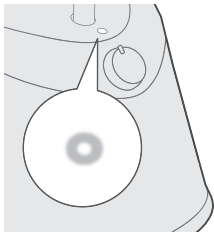

2 Svetelná kontrolka bude svietiť stále, čo signalizuje, že parný stojan je zapnutý.

*STE1010/75: ~2 min

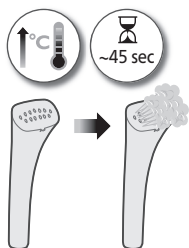

- 3 Počkajte približne 45 sekúnd, kým sa stojanový naparovač zahreje a uvoľní paru (STE1010/75: približne 2 minúty).

Tipy na žehlenie

- 1 Môžete použiť vlastný vešiak a umiestniť ho na parný dok.

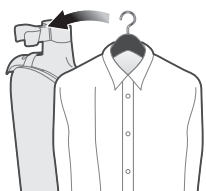

- 2 Naparovaciu hlavicu pohybuje v rovnobežnom smere s golierom.

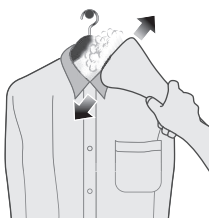

- 3 Naparovaciu hlavicu pohybuje v horizontálnom smere pomocou jarma.

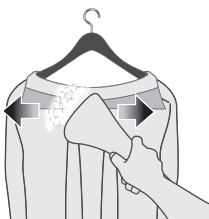

- 4 Napnite odev. Pohybuje naparovacou hlavicou smerom nadol na prednej časti tela.

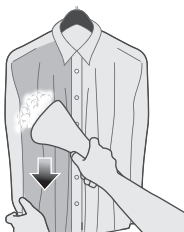



5 Pohybujte naparovacou hlavicou smerom nahor po vrecku.

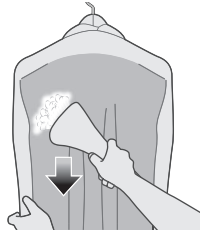

6 Napnite odev. Pohybujte naparovacou hlavicou smerom nadol po zadnej časti tela.

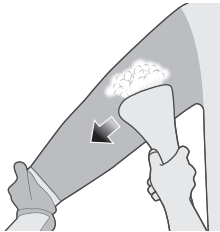

7 Napnite odev. Pohybujte naparovacou hlavicou v rovnobežnom smere s rukávom.

Čistenie a údržba

Odstraňovač vodného kameňa

Vaše zariadenie bolo navrhnuté so systémom odstraňovania vodného kameňa. Vodný kameň odporúčame odstraňovať raz za mesiac alebo častejšie. To pomáha udržiavať silný výkon pary a zabraňuje tomu, aby sa zo žehliacej plochy časom uvoľnili nečistoty a zanechali škvrny.

Tip: Funkciu odstraňovania vodného kameňa môžete použiť kedykoľvek. Ak žijete v oblasti s tvrdou vodou, funkciu používajte častejšie.

Vykonávanie procesu odstraňovania vodného kameňa

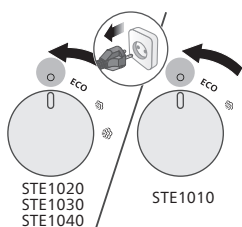

- 1 Uistite sa, že je parný ovládač v polohe OFF a zariadenie je odpojené od elektrickej siete.

- 2 Uistite sa, že žehlička úplne vychladla (> 1 hodina).



- 3 Naparovač umiestnite v blízkosti odtoku.

- 4 Otočte gombík Odstraňovač vodného kameňa do polohy odblokovania a odstráňte gombík Odstraňovač vodného kameňa. Vodu nechajte odtečť.

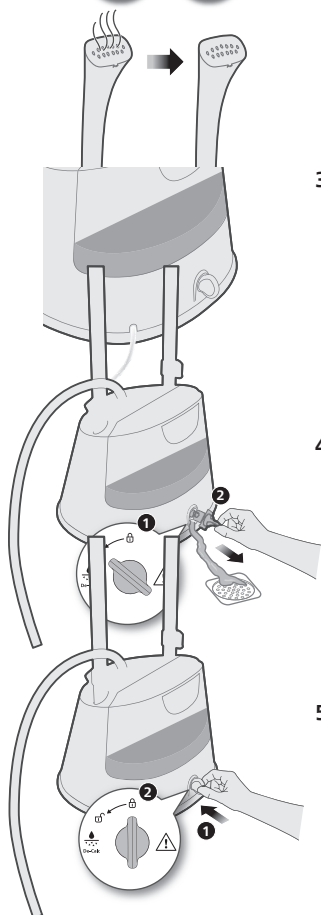

- 5 Vložte a otočte gombík Odstraňovač vodného kameňa do polohy uzamknutia.

Čistenie a skladovanie stojanového naparovača

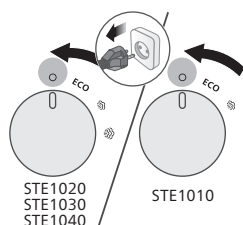

- 1 Uistite sa, že je parný ovládač v polohe OFF a zariadenie je odpojené od elektrickej siete.

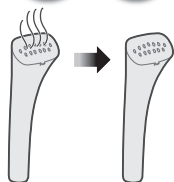

- 2 Uistite sa, že žehlička úplne vychladla (> 1 hodina).

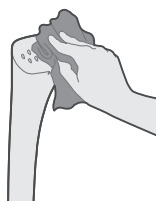

- 3 Miesto na paru utrite vlhkou utierkou.

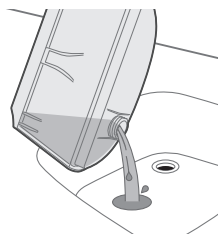

- 4 Zásobník na vodu úplne vyprázdnite.

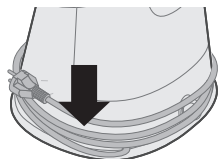

- 5 Napájací kábel omotajte okolo základne.

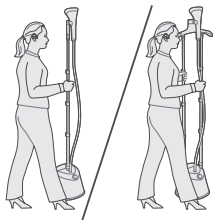

6 Stojanový naparovač môžete prenášať pomocou uchopenia tyče.

Riešenie problémov

Táto kapitola uvádza najbežnejšie problémy, s ktorými by ste sa pri používaní spotrebiča mohli stretnúť. Ak neviete problém vyriešiť pomocou nižšie uvedených informácií, navštívte webovú stránku www.philips.com/support, na ktorej nájdete zoznam často kladených otázok, alebo sa obráťte na Stredisko starostlivosti o zákazníkov vo svojej krajine.

Problém	Možná príčina	Riešenie
Zariadenie nevytvára paru alebo ju vytvára nepravidelne.	Naparovač sa dostatočne nezahrial.	Zariadenie nechajte zahriať počas približne 45 sekúnd (STE1010/75: približne 2 minúty).
	V hadici skondenzovala para.	Zdvihnite naparovaciu hlavicu a narovnajete hadicu do zvislej polohy. Vďaka tomu sa umožní spätný tok akejkoľvek kondenzácie.
	Nízka hladina vody v zásobníku alebo je zásobník nesprávne založený.	Naplňte zásobník na vodu a správne ho zložte.
	V zariadení sa nahromadilo príliš veľa vodného kameňa.	Vykonajte proces odstraňovania vodného kameňa. Pozrite časť Odstraňovanie vodného kameňa.
Z naparovacej hlavice odkvapkáva voda a zariadenie vydáva chrapot.	Nechali ste naparovaciu hlavicu a/hadicu na prívod pary dlho vo vodorovnej polohe.	Zdvihnite naparovaciu hlavicu a narovnajete hadicu do zvislej polohy. Vďaka tomu sa umožní spätný tok akejkoľvek kondenzácie.
	Keď hadica vytvorí tvar písmena U, kondenzát v hadici nemôže prúdiť späť do nádrže na vodu.	Zdvihnite naparovaciu hlavicu a narovnajete hadicu do zvislej polohy. Vďaka tomu sa umožní spätný tok akejkoľvek kondenzácie.

Pri zahrievaní zariadenia kvapká z
naparovacej hlavice nadmerné
množstvo vody.

Voda v zariadení je znečistená
alebo zostala v spotrebiči dlhší čas.

Vykonajte proces odstraňovania
vodného kameňa. Pozrite časť
Odstraňovanie vodného kameňa.

Zo základne naparovača vyteká
voda.

Uzáver zásobníka na vodu alebo
gombík na odstraňovanie
vodného kameňa ste nezatvorili
bezpečne. Zásobník na vodu nie je
správne založený.

Bezpečne zatvorte uzáver
zásobníka na vodu alebo gombík
na odstraňovanie vodného
kameňa. Zásobník správne založte.

Uvod

Čestitamo na kupovini i dobro došli u Philips! Da biste na najbolji način iskoristili podršku koju nudi kompanija Philips, registrujte proizvod na www.philips.com/welcome. Pažljivo pročitajte ovaj korisnički priručnik, brošuru sa važnim informacijama i vodič za brzi početak pre upotrebe aparata. Sačuvajte ih kao referencu za ubuduće.

Pregled proizvoda

STE1020, STE1030, STE1040

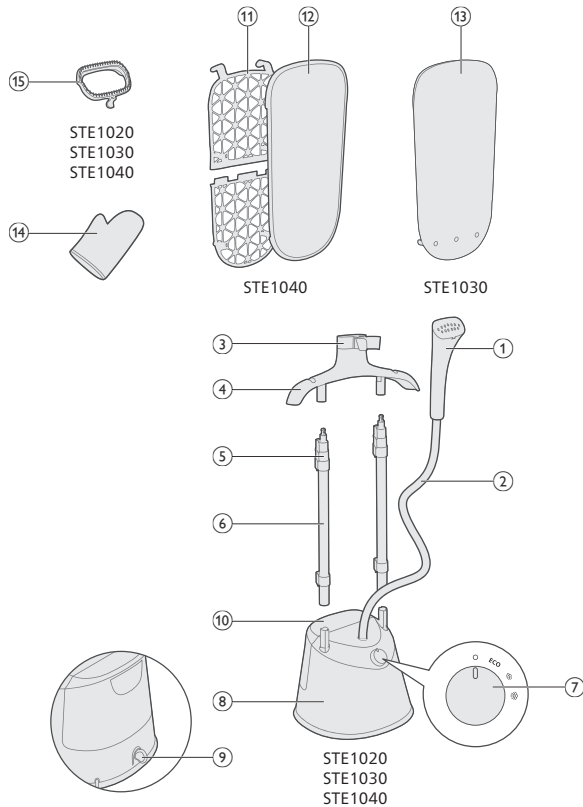

STE1010

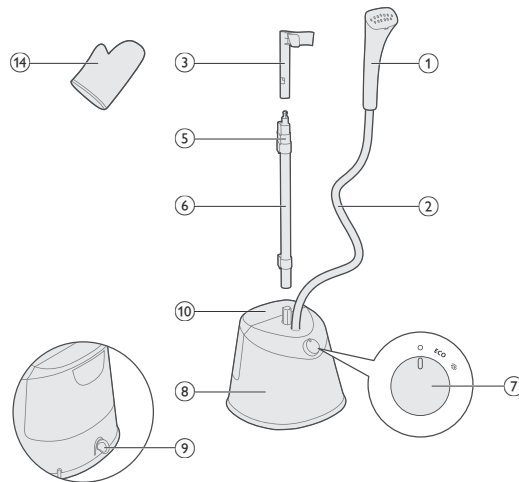

- 1 Glava aparata za peglanje parom
- 2 Crevo za dovod pare
- 3 Baza aparata za peglanje parom
- 4 Vešalica (STE1020, STE1030, STE1040)
- 5 Hvataljka za fiksiranje šipke
- 6 Šipka
- 7 Regulator pare
- 8 Postolje
- 9 Regulator za uklanjanje kamenca
- 10 Rezervoar za vodu
- 11 Daska (STE1040)
- 12 Navlaka (STE1040)
- 13 Podloga (STE1030)
- 14 Rukavica
- 15 Četka (STE1020, STE1030, STE1040)

Pre upotrebe

Tip vode koji bi trebalo koristiti

Ovaj aparat je prikladan za korišćenje sa vodom iz česme. Međutim, ako živite u oblasti sa tvrdom vodom, preporučujemo da pomešate jednake količine vode sa česme i destilovane ili demineralizovane vode. To će sprečiti brzo stvaranje naslaga kamenca i produžiti radni vek aparata.

Nemojte da dodajete parfem, vodu iz mašine za sušenje veša, sirće, štirik, sredstva za uklanjanje kamenca, aditive za peglanje, vodu čiji je sadržaj kamenca smanjen hemijskim putem niti druge hemikalije zato što to može da dovede do prskanja vode, pojave braon fleka ili oštećenja aparata.

Upozorenja

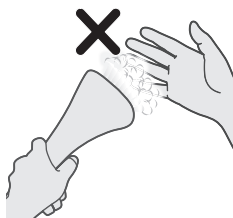

1 Nemojte da dovodite nijedan deo kože u direktan kontakt sa parom.



2 Ploču za nanošenje pare nemojte da okrećete prema drugim osobama.

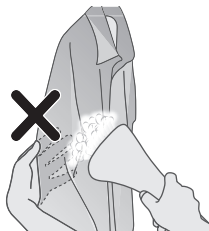

3 Nemojte da držite odevni predmet tako da bude u direktnom kontaktu sa parom.

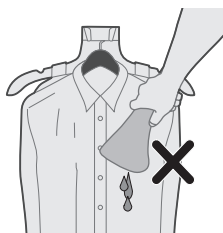

4 Nemojte da koristite ploču za nanošenje pare okrenutu nadole.

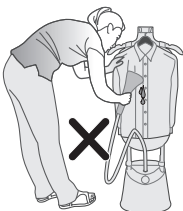

5 Nemojte da savijate crevo da biste parom tretirali odevni predmet.

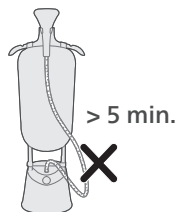

- 6 Nemojte da ostavljate stojeći aparat za peglanje parom bez nadzora duže od 5 minuta.

Podešavanje aparata

STE1010

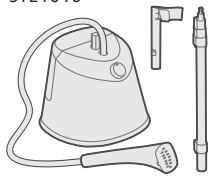

- 1 Pregledajte delove dostupne za aparat koji ste kupili.

STE1020, STE1030
STE1040



STE1010

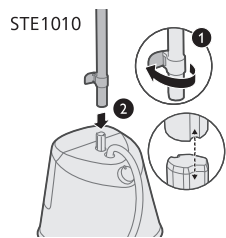

- 2 Otpustite donje hvataljke za fiksiranje šipke i postavite šipke na postolje. Proverite da li su poravnati profili šipki i držači šipki na postolju.

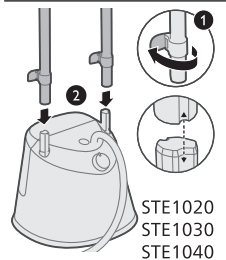

STE1020
STE1030
STE1040

402 Srpski

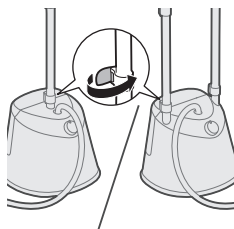

3 Fiksirajte donje hvataljke za fiksiranje šipke.

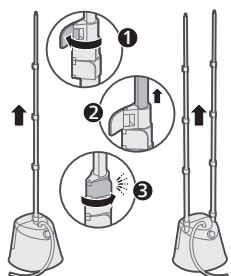

4 Otpustite preostale hvataljke za fiksiranje šipke, potpuno izvucite šipke nagore i fiksirajte ih.

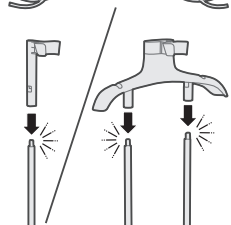

5 Postavite bazu aparata za peglanje parom na šipke tako da legne na mesto („klik“).

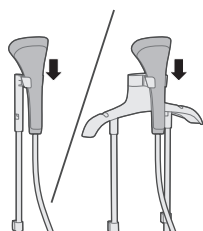

6 Postavite glavu aparata za peglanje parom na bazu.

Podešavanje daske

1 Pregledajte delove dostupne za aparat koji ste kupili.

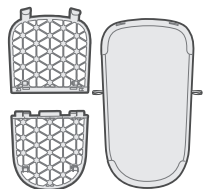

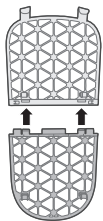

2 Poravnajte i umetnite štipaljke daske tako da legnu na mesto („klik“).

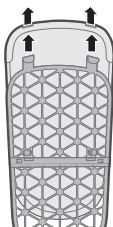

3 Poravnajte i postavite navlaku daske pomoću kukica na dasci.

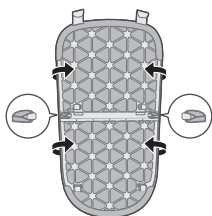

4 Zakačite trake navlake daske na kukice sa zadnje strane daske

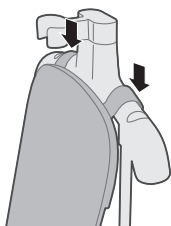

5 Postavite dasku na vešalicu.

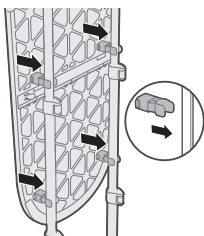

6 Postavite dasku na šipke tako da legne na mesto („klik“).

7 Možete da okačite odevne predmete na vešalicu.

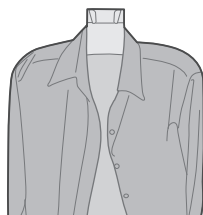
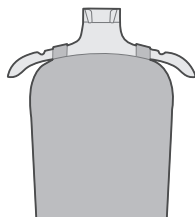

8 Možete da koristite svoju vešalicu koju ćete staviti na bazu aparata za peglanje parom.

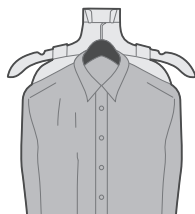

Podešavanje podloge

1 Umetnite srednju traku kroz bazu aparata za peglanje parom.

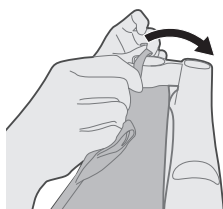

2 Zakačite 3 trake na kukice sa zadnje strane vešalice.

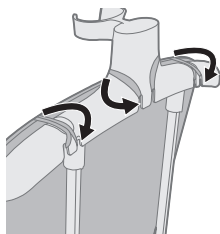

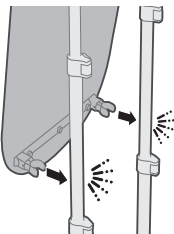

3 Postavite podlogu na šipke tako da legne na mesto („klik“).

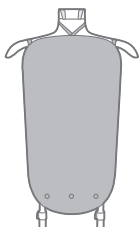

4 Možete da okačite odevne predmete na vešalicu.



5 Možete da koristite svoju vešalicu koju ćete staviti na bazu aparata za peglanje parom.

Umetanje četke

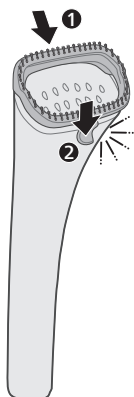

1 Poravnajte ivicu duž gornje strane glave aparata za peglanje parom i zakačite kopču sa donje strane („klik“).

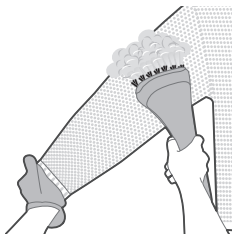

- 2 Možete da nosite rukavicu i da peglate odeću parom pomoću dodatka sa četkom.

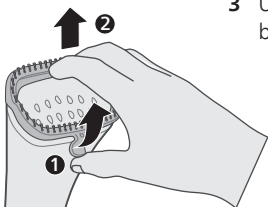

- 3 Uхватite i povucite kopču sa donje strane glave aparata za peglanje parom da biste uklonili dodatak sa četkom.

Punjenje rezervoara za vodu

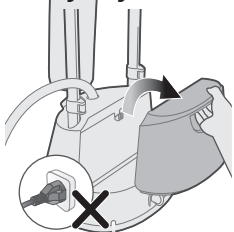

- 1 Nemojte da priključite aparat. Uklonite rezervoar za vodu sa postolja.

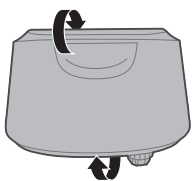

- 2 Okrenite rezervoar za vodu, tako da poklopac rezervoara bude okrenut nagore.

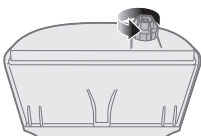

- 3 Okrećite poklopac rezervoara za vodu suprotno od smera kazaljke na satu da biste ga uklonili.

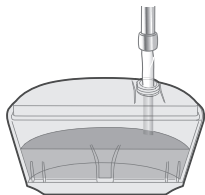

4 Napunite rezervoar za vodu.

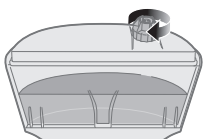

5 Zavrnite poklopac rezervoara za vodu u smeru kazaljke na satu da biste ga pritegnuli.

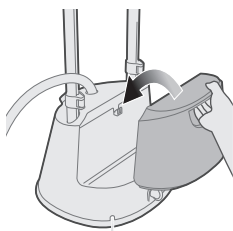

6 Poravnajte sa kukom da biste vratili rezervoar za vodu na postolje.

Menjanje postavki pare

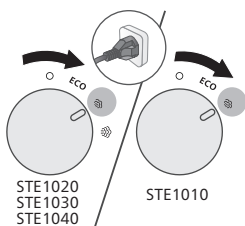

1 Uverite se da je aparat priključen na napajanje. Okrenite regulator pare na željenu postavku pare.

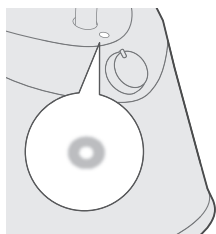

2 Svetlo će početi da svetli, što ukazuje na to da je stojeći aparat za peglanje parom uključen.

*STE1010/75: ~2 min

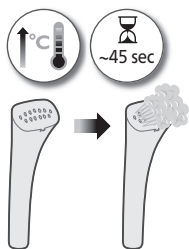

- 3 Sačekajte približno 45 sekundi da se stojeći aparat za peglanje parom zagreje i da počne da emituje paru (STE1010/75: približno 2 minuta).

Saveti za peglanje

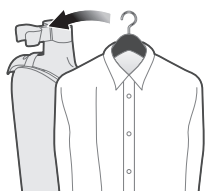

- 1 Možete da koristite svoju vešalicu koju ćete staviti na bazu aparata za peglanje parom.

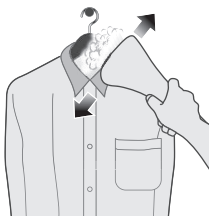

- 2 Pomerajte glavu aparata za peglanje parom paralelno sa kragnom.

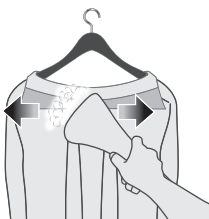

- 3 Pomerajte glavu aparata za peglanje parom horizontalno u odnosu na rameni umetak.

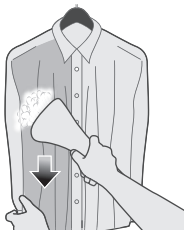

- 4 Rastegnite odevni predmet. Pomerajte glavu aparata za peglanje parom nadole sa prednje strane.



5 Pomerajte glavu aparata za peglanje parom nagore na džepovima.

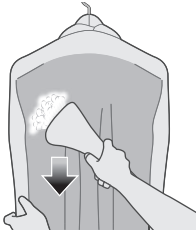

6 Rastegnite odevni predmet. Pomerajte glavu aparata za peglanje parom nadole sa zadnje strane.

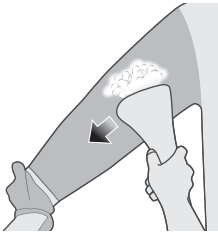

7 Rastegnite odevni predmet. Pomerajte glavu aparata za peglanje parom paralelno sa rukavima.

Čišćenje i održavanje

Posuda za kamenac

Aparat je dizajniran sa sistemom posude za kamenac. Preporučuje se da čišćenje kamenca obavljate jednom mesečno ili češće. To pomaže u održavanju snažnog mlaza pare i sprečava da prljavština i fleke vremenom počnu da izlaze iz grejne ploče.

Koristan savet: Sistem sa posudom za kamenac možete da upotrebite u svakom trenutku. Ako živite u oblasti gde je voda tvrda, ovu funkciju koristite češće.

Obavljanje procesa čišćenja kamenca

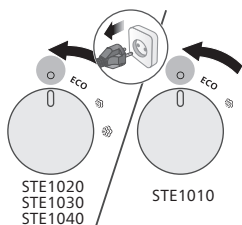

- 1 Proverite da li je regulator pare u isključenom položaju i da li je aparat isključen sa napajanja.

- 2 Uverite se da pegla potpuno ohladila (> 1 sat).



- 3 Postavite aparat za peglanje parom blizu odvoda.

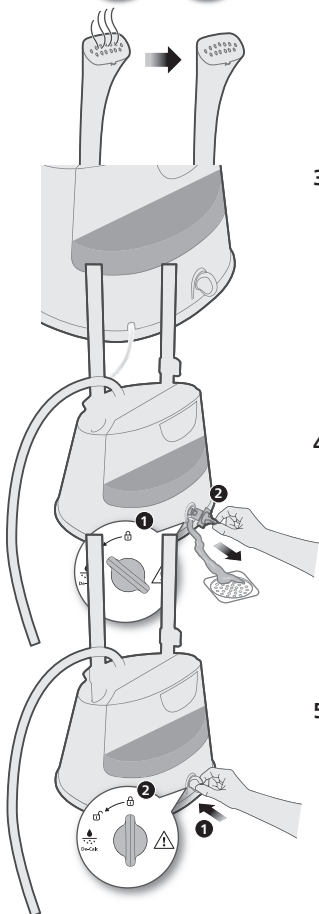

- 4 Okrenite regulator za čišćenja kamenca u otključan položaj i uklonite regulator za čišćenje kamenca. Pustite da voda isteče.

- 5 Umetnite i okrenite regulator za čišćenje kamenca u zaključan položaj.

Čišćenje i odlaganje stojećeg aparata za peglanje parom

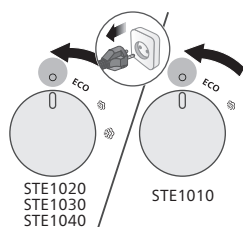

- 1 Proverite da li je regulator pare u isključenom položaju i da li je aparat isključen sa napajanja.

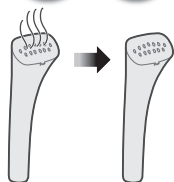

- 2 Uverite se da pegla potpuno ohladila (> 1 sat).

- 3 Mesto gde izlazi para obrišite vlažnom krpom.

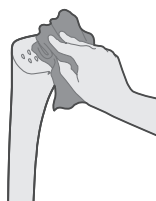

- 4 Potpuno ispraznite rezervoar za vodu.

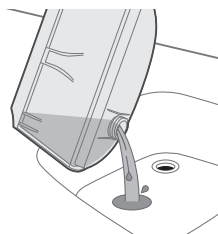

- 5 Namotajte kabl za napajanje oko postolja.

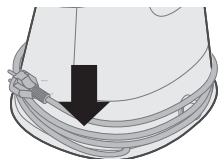

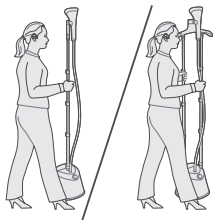

6 Stojeći aparat za peglanje parom možete da nosite za šipku.

Rešavanje problema

U ovom poglavlju ukratko su navedeni najčešći problemi do kojih može da dođe sa aparatom. Ako ne uspete da rešite problem pomoću informacija navedenih u nastavku, posetite www.philips.com/support da biste pronašli listu najčešćih pitanja ili se obratite centru za korisničku podršku u svojoj zemlji.

Problem	Mogući uzrok	Rešenje
Aparat ne proizvodi paru ili daje isprekidanu paru.	Aparat za paru se nije dovoljno zagrejao.	Ostavite aparat da se zagreva približno 45 sekundi (STE1010/75: približno 2 minuta).
	Došlo je do kondenzovanja pare u crevu.	Podignite glavu aparata za paru da biste vertikalno ispravili crevo. To omogućava da se kondenzovana tečnost vrati.
	Nizak nivo vode u rezervoaru ili rezervoar nije pravilno postavljen.	Napunite rezervoar za vodu i pravilno ga postavite.
	U aparatu se nakupilo previše kamenca.	Obavite proces čišćenja kamenca. Pogledajte odeljak za čišćenje kamenca.
Kapljice vode izlaze iz glave aparata za paru ili aparat proizvodi zvuk nalik kreštanju.	Predugo ste ostavili glavu aparata za paru i/ili crevo za dovod pare u horizontalnom položaju.	Podignite glavu aparata za paru da biste vertikalno ispravili crevo. To omogućava da se kondenzovana tečnost vrati.
	Kada crevo formira oblik slova U, tečnost koja se kondenzuje u njemu ne može da se vraća u rezervoar za vodu.	Podignite glavu aparata za paru da biste vertikalno ispravili crevo. To omogućava da se kondenzovana tečnost vrati.
Veća količina vode kaplje iz glave aparata za paru tokom zagrevanja.	Voda u aparatu je prljava ili predugo stoji u aparatu.	Obavite proces čišćenja kamenca. Pogledajte odeljak za čišćenje kamenca.
Voda curi iz postolja aparata za paru.	Niste čvrsto zatvorili poklopac rezervoara za vodu ili regulator za uklanjanje kamenca. Rezervoar za vodu nije pravilno ubačen.	Čvrsto zatvorite poklopac rezervoara za vodu ili regulator za uklanjanje kamenca. Pravilno umetnite rezervoar.

Johdanto

Onnittelut ostoksestasi ja tervetuloa Philips-tuotteen käyttäjäksi! Hyödynnä Philipsin tukipalveluita rekisteröimällä tuotteesi osoitteessa www.philips.com/welcome. Lue tämä käyttöopas, Tärkeitä tietoja -lehtinen ja pikaopas huolellisesti ennen laitteen käyttöä. Säilytä ne myöhempää tarvetta varten.

Tuotteen yleiskuvaus

STE1020, STE1030, STE1040

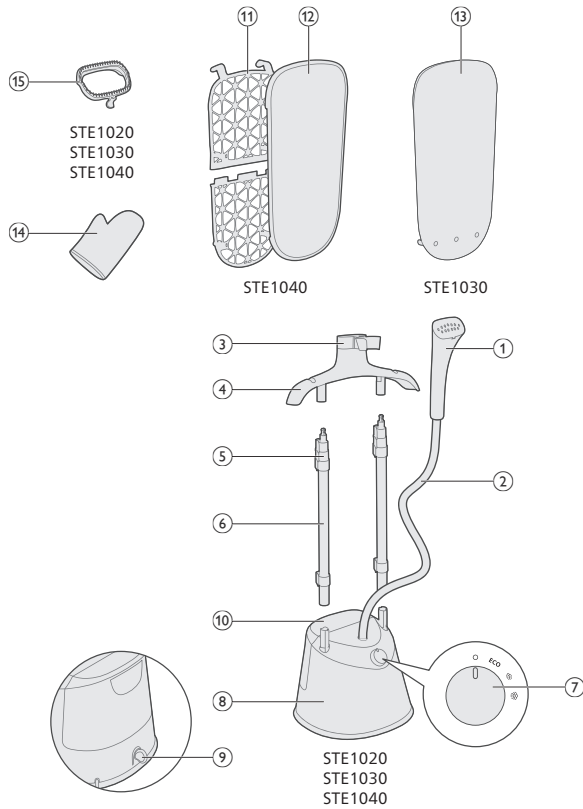

STE1010

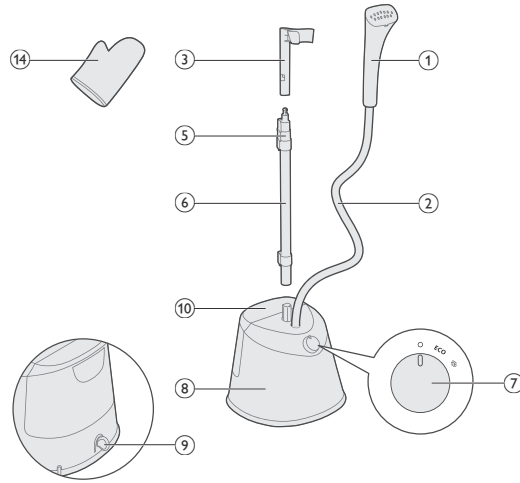

- 1 Höyrystimen pää
- 2 Höyryletku
- 3 Höyrystimen telakka
- 4 Ripustin (STE1020, STE1030, STE1040)
- 5 Varren lukitsin
- 6 Varsi
- 7 Höyryvalitsin
- 8 Jalusta
- 9 Kalkinpoistonuppi
- 10 Vesisäiliö
- 11 Lauta (STE1040)
- 12 Suojus (STE1040)
- 13 Alusta (STE1030)
- 14 Käsine
- 15 Harja (STE1020, STE1030, STE1040)

Käyttönoton valmistelu

Käytettävä vesityyppi

Laite soveltuu vesijohtoveden käyttöön. Jos asut kovan veden alueella, suosittelemme sekoittamaan vesijohtoveteen saman verran tislattua tai suoloista puhdistettua vettä. Tämä estää kalkin nopeaa kertymistä ja pidentää laitteen käyttöikä.

Älä käytä hajustettua vettä, kuivausrummun vettä tai vettä, johon on lisätty etikkaa, tärkkiä, kalkinpoistoaineita, silitysaineita, kemiallisesti puhdistettua vettä tai muita kemikaaleja, koska se voi vahingoittaa laitetta tai aiheuttaa veden pirskahtelua ja ruskeita tahroja silitettävään kankaaseen.

Varoitukset

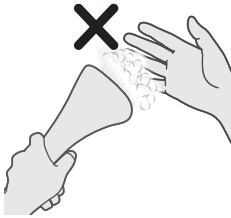

1 Älä altista ihoa suoraan kosketukseen höyryn kanssa.



2 Älä suuntaa höyrylevyä kohti muita ihmisiä.

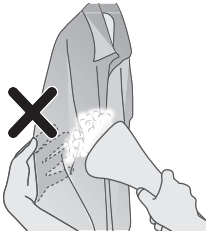

3 Älä aseta vaatetta niin, että se on suorassa kosketuksessa höyryn kanssa.

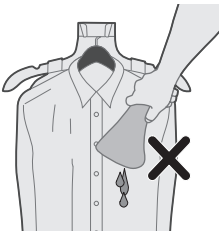

4 Älä käytä höyrystintä siten, että sen pää on suunnattu alaspäin.

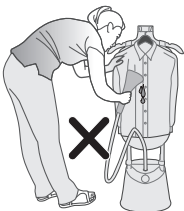

5 Älä taivuta letkua, kun höyrytät vaatetta.

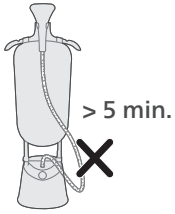

6 Älä jätä telinemallista höyrystintä ilman valvontaa yli viiden minuutin ajaksi.

Laitteen asentaminen

STE1010

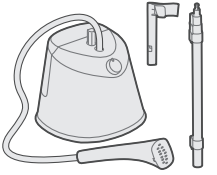

1 Huomioi laitteeseen saatavilla olevat osat.

STE1020, STE1030
STE1040



STE1010

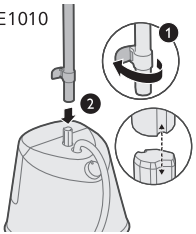

2 Avaa alaosan varsilukitsimet ja aseta varsi/varret jalustaan. Varmista, että varsi/varret ja jalustan tapit on kohdennettu.

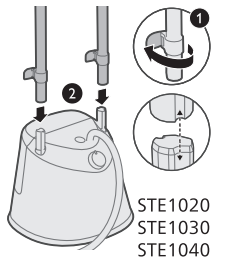

STE1020
STE1030
STE1040

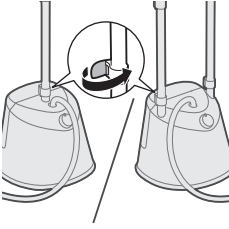

3 Lukitse alaosan varsilukitsimet.

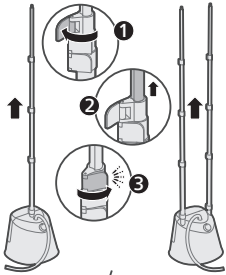

4 Avaa loput varsilukitsimet, vedä varsi/varret täyteen pituuteen ja lukitse paikoilleen.

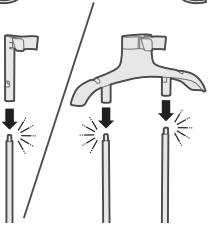

5 Kiinnitä höyrystimen telakka varteen/varsiin siten, että se lukittuu napsahtaen paikalleen.

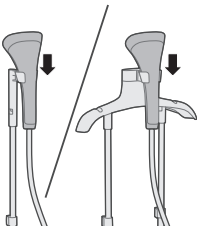

6 Aseta höyrystimen pää telakkaan.

Laudan asentaminen

1 Huomioi laitteeseen saatavilla olevat osat.

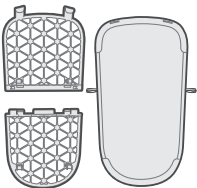

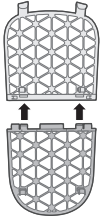

2 Kohdista ja kiinnitä laudan pidikkeet siten, että ne napsahtavat paikoilleen.

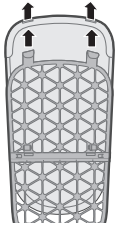

3 Kohdista ja kiinnitä laudanpäällinen laudan koukkuihin.

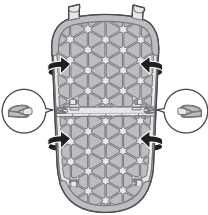

4 Kiinnitä laudanpäällisen hihnat laudan takaosassa oleviin koukkuihin.

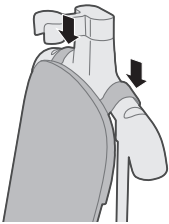

5 Aseta lauta ripustimeen.

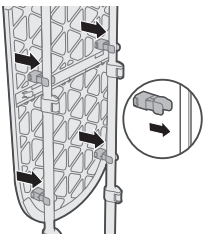

6 Kiinnitä lauta varsiin siten, että se napsahtaa paikalleen.

7 Voit ripustaa vaatteesi ripustimen avulla.

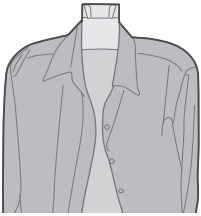
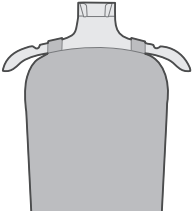

8 Voit käyttää omaa ripustinta asettamalla sen höyrytimen telakkaan.

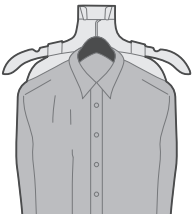

Alustan asentaminen

1 Aseta keskimäinen hihna höyrytimen telakan läpi.

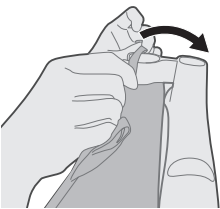

2 Kiinnitä kolme hihnaa ripustimen takaosan koukkuun.

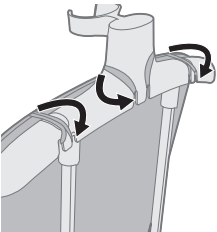

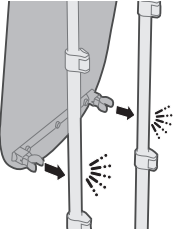

3 Kiinnitä alusta varsiin siten, että se napsahtaa paikalleen.

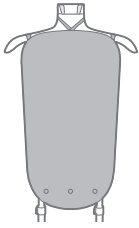

4 Voit ripustaa vaatteesi ripustimen avulla.



5 Voit käyttää omaa ripustinta asettamalla sen höyrystimen telakkaan.

Harjan asentaminen

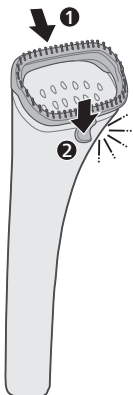

1 Kohdista harjan urat höyrystimen pään yläosan kanssa ja napsauta alaosan salpa kiinni.

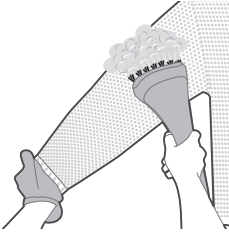

- 2 Voit käyttää harjaa vaatteiden höyryttämiseen, jolloin on suositeltavaa käyttää käsinettä.

- 3 Irrota harja vetämällä höyrytimen pään alaosassa oleva salpa auki.

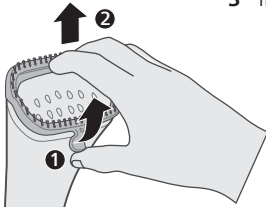

Vesisäiliön täyttäminen

- 1 Älä kytke laitetta virtalähteeseen. Irrota vesisäiliö jalustasta.

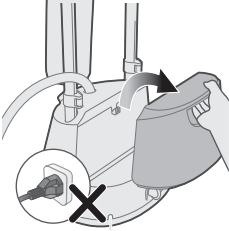

- 2 Käännä vesisäiliö siten, että vesisäiliön korkki osoittaa ylöspäin.

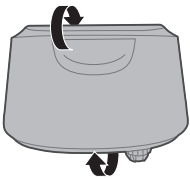

- 3 Irrota vesisäiliön korkki kiertämällä sitä vastapäivään.

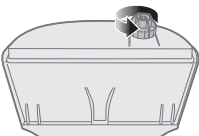

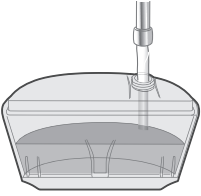

4 Täytä vesisäiliö.

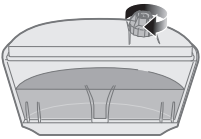

5 Kiinnitä vesisäiliön korkki takaisin paikalleen kiertämällä sitä myötäpäivään.

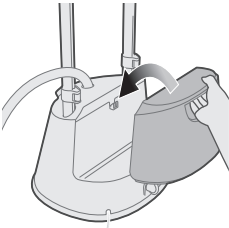

6 Aseta vesisäiliö takaisin jalustaan kohdistamalla se koukkuun.

Höyryasetusten valinta

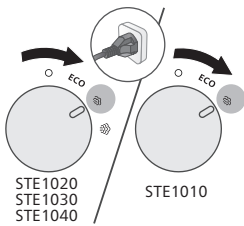

1 Varmista, että laite on kytketty pistorasiaan. Käännä höyryvalitsin haluamasi höyryasetuksen kohdalle.

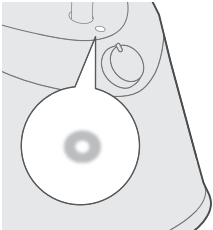

2 Kun merkkivalo palaa tasaisesti, telinehöyrystin on käynnissä.

*STE1010/75: ~2 min

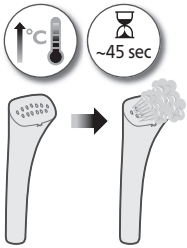

Silitysvinukkejä

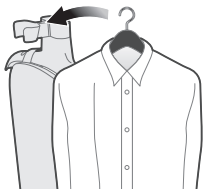

3 Odota noin 45 sekuntia, jotta telinehöyrystin ehtii lämmetä ja alkaa tuottaa höyryä (STE1010/75: noin 2 minuuttia).

1 Voit käyttää omaa ripustinta asettamalla sen höyrystimen telakkaan.

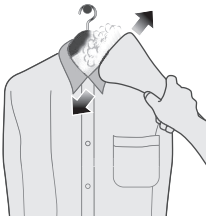

2 Liikuta höyrystimen päätä samansuuntaisesti kauluksen kanssa.



3 Liikuta höyrystimen päätä samansuuntaisesti kaarrokkeen kanssa.

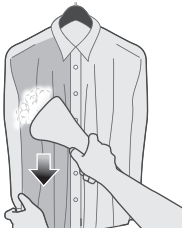

4 Venytä vaatetta. Liikuta höyrystimen päätä alaspäin vaatteen etuosaa pitkin.



5 Liikuta höyrystimen päätä ylöspäin taskun kohdalla.

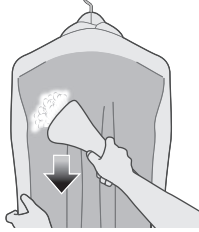

6 Venytä vaatetta. Liikuta höyrystimen päätä alaspäin vaateen takakappaleen kohdalla.

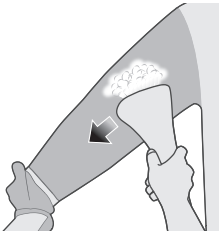

7 Venytä vaatetta. Liikuta höyrystimen päätä samansuuntaisesti hihan kanssa.

Puhdistus ja huolto

Kalkinkerääjä

Laitteessa on kalkinkeräysjärjestelmä. Kalkinpoisto on suositeltavaa tehdä vähintään kerran kuukaudessa. Tämä ylläpitää laitteen höyryntuottotehoa ja estää lian ja tahrojen kertymisen pitkän käyttöiän aikana.

Vihje: Kalkinkeräysjärjestelmää voi käyttää milloin tahansa. Jos asut kovan veden alueella, käytä toimintoa useammin.

Kalkin poistaminen laitteesta

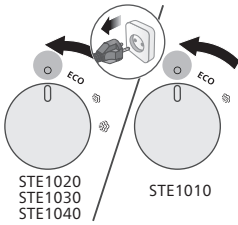

- 1 Varmista, että höyryvalitsin on käännetty OFF-asentoon ja että laite on irrotettu pistorasiasta.



- 2 Varmista, että höyrystin on kokonaan jäähtynyt (> 1 tunti).

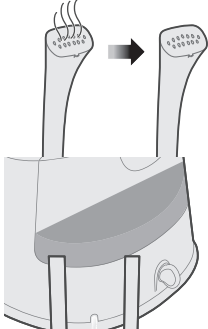

- 3 Aseta höyrystin lähelle viemäriä.

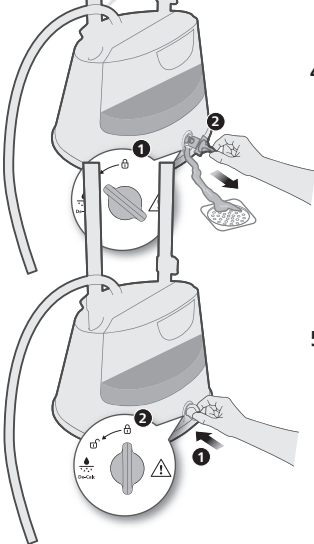

- 4 Käännä kalkinpoistonuppi lukituksen avausasentoon ja irrota kalkinpoistonuppi. Anna veden valua ulos.

- 5 Aseta kalkinpoistonuppi takaisin ja käännä se lukitusasentoon.

Telinemallisen höyrystimen puhdistus ja säilytys

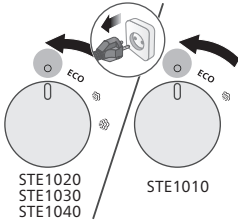

- 1 Varmista, että höyrövalitsin on käännetty OFF-asentoon ja että laite on irrotettu pistorasiasta.

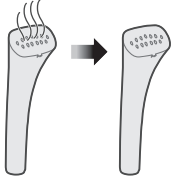

- 2 Varmista, että höyrystin on kokonaan jäähtynyt (> 1 tunti).

- 3 Pyyhi höyrölevy kostealla liinalla.

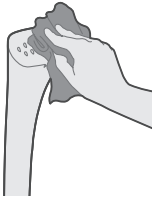

- 4 Tyhjennä vesisäiliö kokonaan.

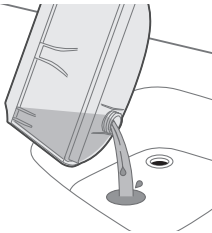

- 5 Kierrä virtajohto laitteen ympärille.

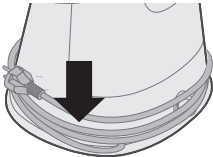

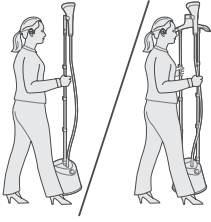

6 Voit kantaa telinehöyrystintä varresta.

Vianmääritys

Tämä osio esittää lyhyesti yleisimmät ongelmat, joita saatat kohdata käyttäessäsi laitetta. Jos et löydä ongelmaasi ratkaisua seuraavista tiedoista, lue osoitteesta www.philips.com/support vastauksia usein kysytyihin kysymyksiin tai ota yhteys paikalliseen kuluttajapalvelukeskukseen.

Ongelma	Mahdollinen syy	Ratkaisu
Laitteesta ei tule höyryä tai höyryä ei tule tasaisesti.	Höyrystini ei ole kuumentunut riittävästi.	Anna laitteen lämmetä noin 45 sekunnin ajan (STE1010/75: noin 2 minuuttia).
	Höyry on tiivistynyt vedeksi letkuun.	Suorista letku pystyasennossa nostamalla höyrystimen päätä. Näin tiivistynyt vesi valuu takaisin vesisäiliöön.
	Vesisäiliössä on vähän vettä tai säiliö ei ole kiinnitetty oikein.	Täytä vesisäiliö ja aseta se oikein.
	Laitteeseen on kertynyt liikaa kalkkia.	Tee kalkinpoisto uudelleen. Katso ohjeet kalkinpoisto-osioista.
Höyrystimen päästä tippuu vesipisaroita tai laitteesta kuuluu kurnuttavaa ääntä.	Olet jättänyt höyrystimen pään ja/tai höyryletkun vaaka-asentoon pitkäksi aikaa.	Suorista letku pystyasennossa nostamalla höyrystimen päätä. Näin tiivistynyt vesi valuu takaisin vesisäiliöön.
	Koska höyryletku on taipunut, letkuun tiivistynyt vesi ei pääse virtaamaan takaisin vesisäiliöön.	Suorista letku pystyasennossa nostamalla höyrystimen päätä. Näin tiivistynyt vesi valuu takaisin vesisäiliöön.
Höyrystimen päästä tippuu liikaa vesipisaroita laitteen lämmitessä.	Laitteen vesi ei ole puhdasta tai vesi on ollut laitteen sisällä liian pitkään.	Tee kalkinpoisto uudelleen. Katso ohjeet kalkinpoisto-osioista.
Höyrystimen tukiasemasta valuu vettä.	Et ole sulkenut vesisäiliön korkkia tai kalkinpoistonuppia kunnolla. Vesisäiliö ei ole kunnolla paikallaan.	Sulje vesisäiliön korkki tai kalkinpoistonuppi kunnolla. Aseta säiliö kunnolla paikalleen.

Introduktion

Vi gratulerar till ditt köp och hälsar dig välkommen till Philips! Genom att registrera din produkt på www.philips.com/welcome kan du dra nytta av Philips support. Läs noggrant igenom den här användarhandboken, den viktiga informationsbroschyren och snabbstartshandboken innan du använder apparaten. Spara dem för framtida bruk.

Produktöversikt

STE1020, STE1030, STE1040

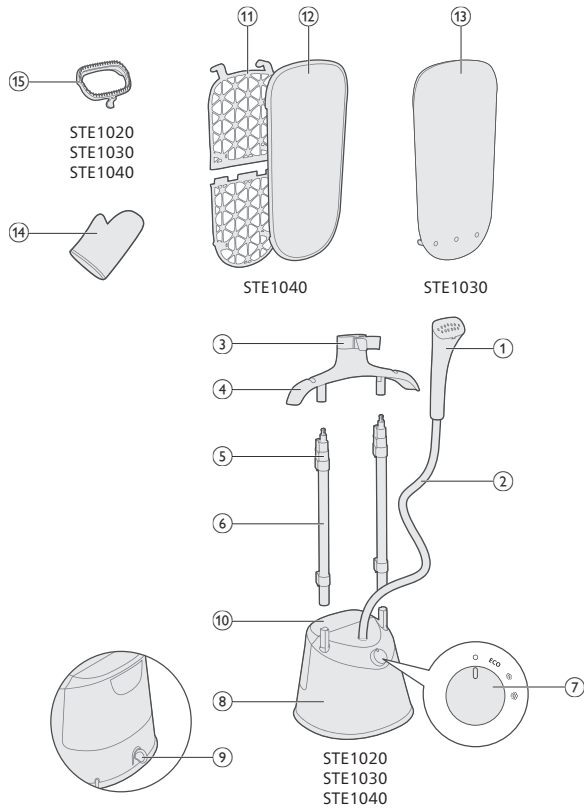

STE1010

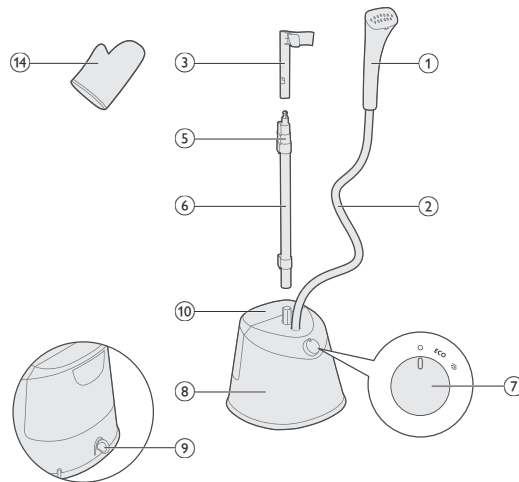

- 1 Ånghuvud
- 2 Ångslang
- 3 Ångdocka
- 4 Galge (STE1020, STE1030, STE1040)
- 5 Låsklämma för ben
- 6 Stång
- 7 Ångvred
- 8 Basenhet
- 9 Avkalkningsknapp
- 10 Vattenbehållare
- 11 Bräda (STE1040)
- 12 Skydd (STE1040)
- 13 Stödmatta (STE1030)
- 14 Handske
- 15 Borste (STE1020, STE1030, STE1040)

Förberedelser inför användning

Typ av vatten som kan användas

Apparaten kan användas med kranvatten. Om du bor i ett område med hårt vatten rekommenderar vi dock att du blandar en lika stor mängd kranvatten med destillerat eller demineraliserat vatten. Detta förhindrar att kalkavlagringar snabbt bildas och förlänger apparatens livslängd.

Använd inte parfym, vatten från torktumlare, ättika, stärkelse, avkalkningsmedel, strykhjälpmiddel, kemiskt avkalkat vatten eller andra kemikalier eftersom det kan orsaka vattenstänk, bruna fläckar eller skada på apparaten.

Varningar

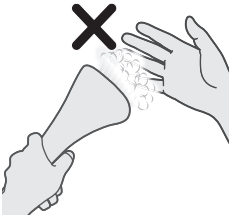

1 Se till att ingen del av huden har direktkontakt med ångan.



2 Rikta inte ångplattan mot andra personer.

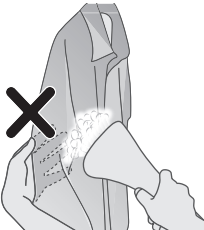

3 Håll inte plagget på ett sätt så att det har direktkontakt med ångan.



4 Använd inte ånghuvudet i nedåtriktat läge.

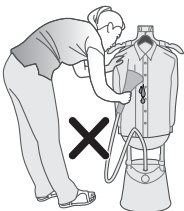

5 Böj inte slangen för att ånga plagget.

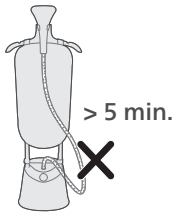

- 6 Lämna inte den stående steamern oövervakad i mer än fem minuter.

Konfigurera apparaten

STE1010

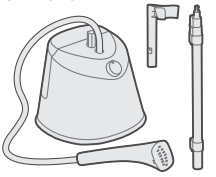

- 1 Notera de tillgängliga delarna till din köpta apparat.

STE1020, STE1030
STE1040



STE1010

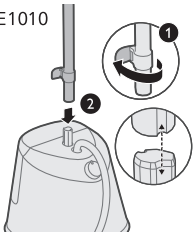

- 2 Lås upp de nedre låsklämmorna på stängen och för in stängen/stängerna i basenheten. Se till att profilerna på stängen/stängerna och basstängens fäste är i linje.

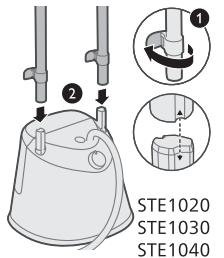

STE1020
STE1030
STE1040

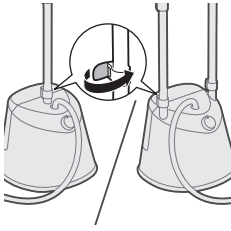

3 Lås de nedre låsklämmorna på stången.

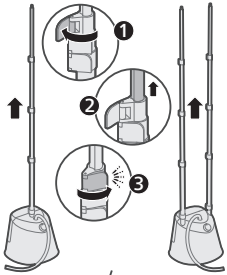

4 Lås upp återstående låsklämmor till stången/stängerna, dra ut stången helt och lås den/dem.

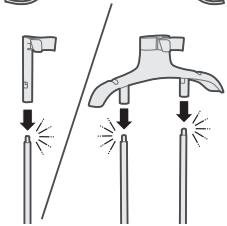

5 För in ångdockan i stången/stängerna tills den låses på plats (ett klickljud hörs).

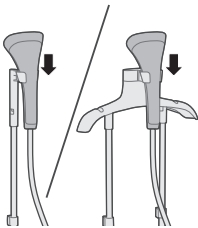

6 Placera ånghuvudet på ångdockan.

Montera brädan

1 Notera de tillgängliga delarna till din köpta apparat.

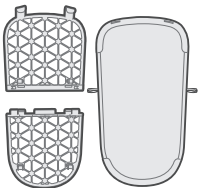

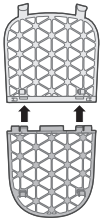

2 Rikta in och för in brädklämmorna tills de låses på plats (ett klickljud hörs).

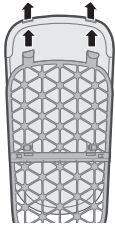

3 Rikta in och för in brädöverdragets genom brädans krokarna.

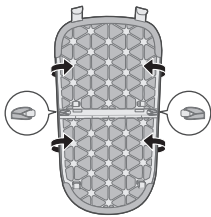

4 Haka fast brädöverdragets remmar på krokarna på brädans baksida.

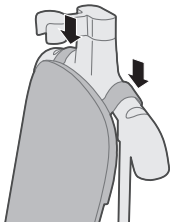

5 Placera brädan på galgen.

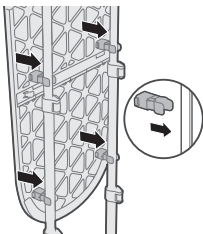

6 Fäst brädan på stängerna (ett klickljud hörs).

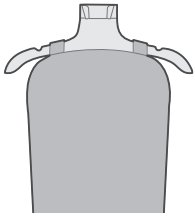

7 Du kan hänga kläderna över galgen.

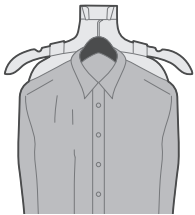
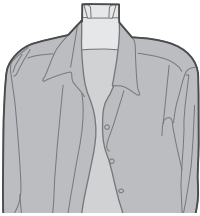

8 Du kan använda en egen galge och hänga den på ångdockan.

Montera stödmattan

1 För mittenremmen genom ångdockan.

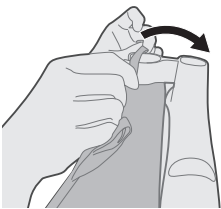

2 Fäst de tre remmarna på kroken på galgens baksida.

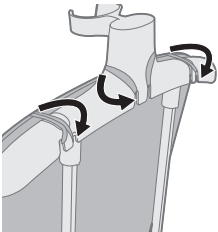

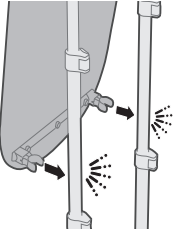

- 3** Fäst stödmattan på stängerna till dess att den låses på plats (ett klickljud hörs).

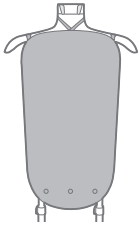

- 4** Du kan hänga kläderna över galgen.



- 5** Du kan använda en egen galge och hänga den på ångdockan.

Montera borsten

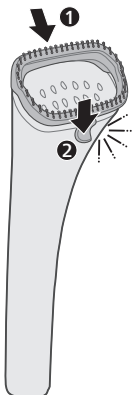

- 1** Rikta in spåret längs ånghuvudets övre del och tryck fast haken på den nedre delen (ett klickljud hörs).

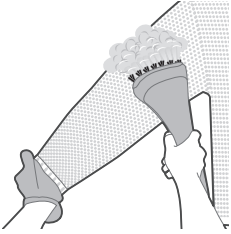

2 Du kan bära handsken och ånga kläderna med borstillbehöret.

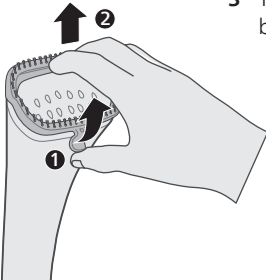

3 Ta tag i och dra ut haken från ånghuvudets nedre del för att ta bort borstillbehöret.

Fylla vattenbehållaren

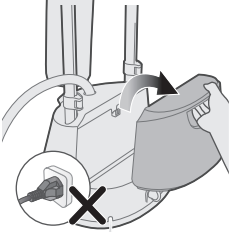

1 Anslut inte apparaten. Ta bort vattenbehållaren från basenheten.

2 Vänd på vattenbehållaren så att vattenbehållarlocket är vänt uppåt.

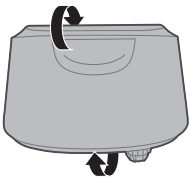

3 Skruva loss vattenbehållarlocket moturs.

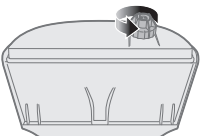

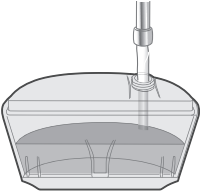

4 Fyll vattenbehållaren.

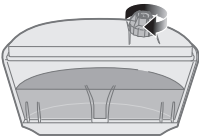

5 Skruva fast vattenbehållarlocket medurs.

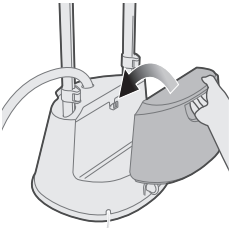

6 Rikta in med kroken för att sätta tillbaka vattenbehållaren i basenheten.

Ändra ånginställningar

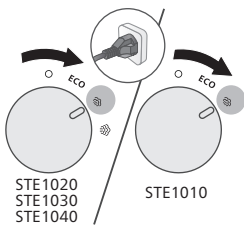

1 Kontrollera att apparaten är ansluten. Vrid ångvredet till önskad ånginställning.

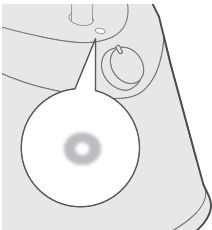

2 Lampan lyser för att indikera att den stående steamern är påslagen.

*STE1010/75: ~2 min

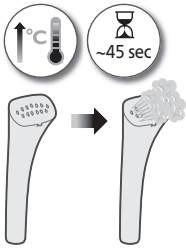

- 3 Vänta i cirka 45 sekunder på att den stående steamern värms upp och avger ånga (STE1010/75: cirka 2 minuter).

Stryktips

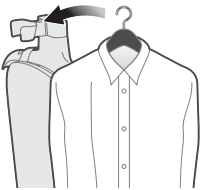

- 1 Du kan använda en egen galge och hänga den på ångdockan.

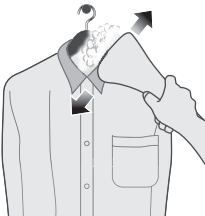

- 2 Flytta ånghuvudet parallellt med kragen.

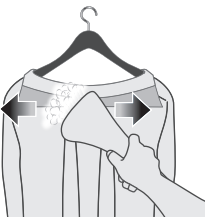

- 3 Flytta ånghuvudet horisontalt med oket.

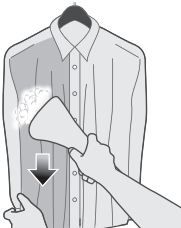

- 4 Sträck ut plagget. Flytta ånghuvudet nedåt på plaggets framsida.



5 Flytta ånghuvudet uppåt på fickor.

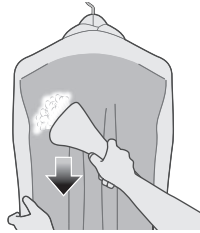

6 Sträck ut plagget. Flytta ånghuvudet nedåt på plaggets baksida.

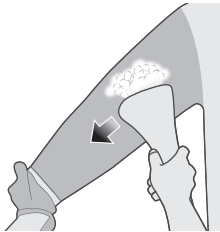

7 Sträck ut plagget. Flytta ånghuvudet parallellt med ärmen.

Rengöring och underhåll

Kalkuppsamlare

Apparaten har utformats med ett kalkuppsamlingssystem. Du rekommenderas avkalka en gång i månaden eller oftare. Systemet ser till att ångfunktionen fungerar optimalt och förhindrar att stryksulan avger smuts och bildar fläckar.

Tips: Kalkuppsamlingssystemet kan användas när som helst. Använd funktionen oftare om du bor i ett område med hårt vatten.

Utföra avkalkningsprocessen

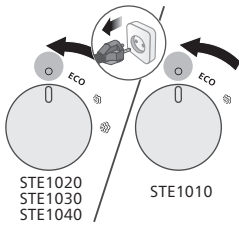

1 Kontrollera att ångvredet är i läget AV och att apparaten är urkopplad.



2 Kontrollera att ånghuvudet är helt kallt (> 1 timme).

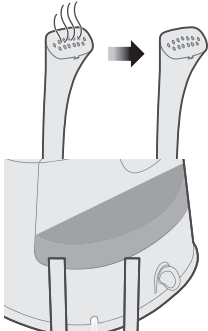

3 Placera steamern nära ett avlopp.

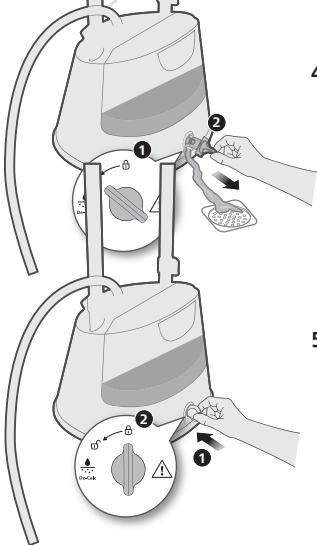

4 Vrid avkalkningsvredet till upplåsningsläget och ta bort avkalkningsvredet. Låt vattnet rinna ut.

5 För in avkalkningsvredet och vrid det till låst läge.

Rengöra och förvara den stående steamern

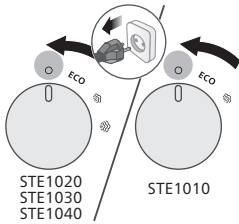

1 Kontrollera att ångvredet är i läget AV och att apparaten är urkopplad.

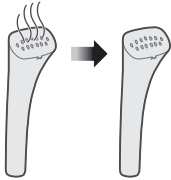

2 Kontrollera att ånghuvudet är helt kallt (> 1 timme).

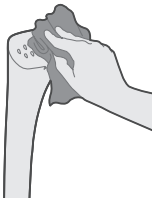

3 Torka av ånghuvudet med en fuktig trasa.

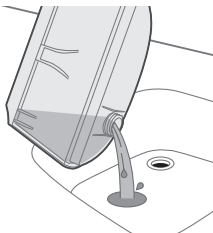

4 Töm vattenbehållaren helt.

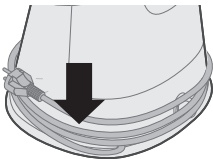

5 Linda strömsladden runt basenheten.

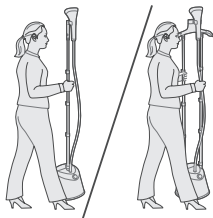

6 Du kan bära den stående steamern i stånden.

Felsökning

I det här kapitlet sammanfattas de vanligaste problemen som du kan råka ut för med apparaten. Om du inte kan lösa problemet med hjälp av informationen nedan kan du gå till www.philips.com/support där det finns en lista med vanliga frågor. Du kan även kontakta kundtjänst i ditt land.

Problem	Möjlig orsak	Lösning
Apparaten producerar ingen ånga eller oregelbunden ånga.	Steamern har inte värmts upp tillräckligt.	Låt apparaten värmas upp i cirka 45 sekunder (STE1010/75: cirka 2 minuter).
	Ånga har kondenserats i slangen.	Lyft upp ånghuvudet fört att sträcka ut slangen vågrätt. Kondensen förs då tillbaka.
	Låg vattennivån i behållaren eller behållaren har inte monterats på rätt sätt.	Fyll på vattenbehållaren igen och för in den ordentligt.
	För mycket kalk har byggts upp i apparaten.	Genomför avkalkningsprocessen. Se avsnittet om avkalkning.
Vatten droppar från ånghuvudet eller apparaten ger ifrån sig ett kraxande ljud.	Ånghuvudet och/eller ångslangen har varit i vågrätt läge under för lång tid.	Lyft upp ånghuvudet fört att sträcka ut slangen vågrätt. Kondensen förs då tillbaka.
	När slangen är u-formad kan kondens i slangen inte föras tillbaka till vattentanken.	Lyft upp ånghuvudet fört att sträcka ut slangen vågrätt. Kondensen förs då tillbaka.
En massa vatten droppar ut från ånghuvudet när apparaten värms upp.	Vattnet i apparaten är smutsigt eller har lämnats i apparaten under en längre tid.	Genomför avkalkningsprocessen. Se avsnittet om avkalkning.
Vatten läcker från steamerns basenhet.	Du har inte satt fast vattenbehållarlocket eller avkalkningsvredet på rätt sätt. Vattenbehållaren är felmonterad.	Sätt fast vattenbehållarlocket eller avkalkningsvredet på rätt sätt. Sätt fast behållaren korrekt.

Giới thiệu

Chúc mừng bạn đã mua hàng và chào mừng bạn đến với Philips! Để có được lợi ích đầy đủ từ sự hỗ trợ do Philips cung cấp, hãy đăng ký sản phẩm tại www.philips.com/welcome. Hãy đọc kỹ sách hướng dẫn sử dụng này, tờ rơi thông tin quan trọng và hướng dẫn sử dụng nhanh trước khi bạn sử dụng thiết bị. Hãy cất giữ để tiện tham khảo sau này.

Tổng quan về sản phẩm

STE1020, STE1030, STE1040

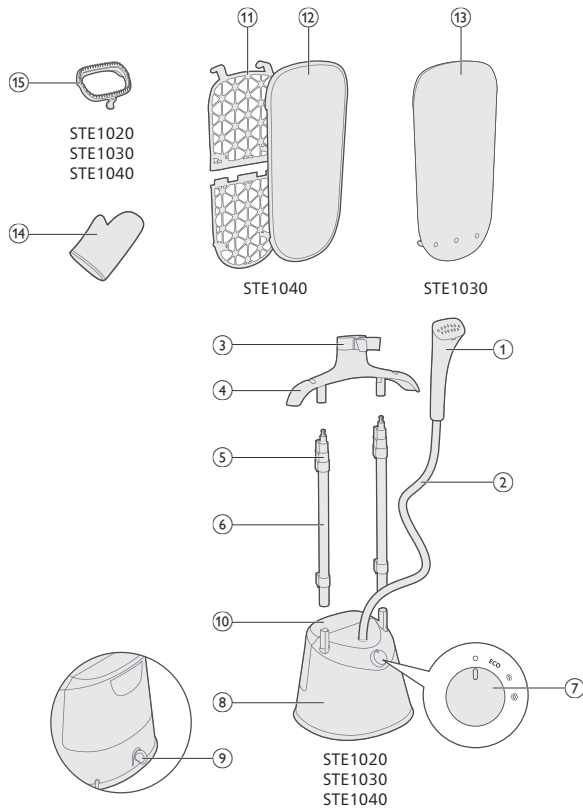

STE1010

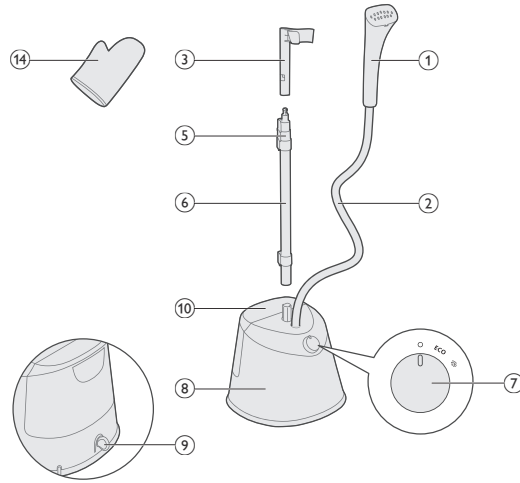

- 1 Đầu bàn ủi hơi nước
- 2 Ống cấp hơi phun
- 3 Đầu kẹp bàn ủi hơi nước
- 4 Móc treo (STE1020, STE1030, STE1040)
- 5 Kẹp khóa trụ
- 6 Trụ
- 7 Nút điều chỉnh hơi phun
- 8 Đế
- 9 Nút tắt cặn
- 10 Ngăn chứa nước
- 11 Ván ủi (STE1040)
- 12 Vỏ bọc (STE1040)
- 13 Tấm lót (STE1030)
- 14 Găng tay
- 15 Bàn chải (STE1020, STE1030, STE1040)

Chuẩn bị sử dụng

Loại nước được sử dụng

Thiết bị thích hợp để sử dụng với nước máy. Tuy nhiên, nếu bạn sống ở khu vực có nước cứng, bạn nên hòa một lượng bằng nhau nước máy và nước cất hoặc nước đã khử khoáng. Việc này sẽ ngăn tích tụ cặn nhanh và giúp kéo dài tuổi thọ của thiết bị.

Không thêm nước hoa, nước từ máy sấy đảo, giấm, hồ vôi, chất làm sạch cặn, chất phụ trợ ủi, nước đã được tẩy sạch bằng hóa chất hoặc các hóa chất khác, do các chất này có thể gây tình trạng phun nước, ổ vàng hoặc làm hỏng thiết bị của bạn.

Cảnh báo

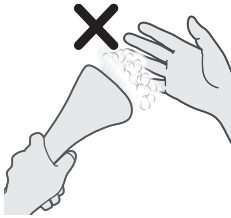

1 Không để bất kỳ phần nào của da tiếp xúc trực tiếp với hơi nước.



2 Không hướng mặt để ủi về phía người khác.

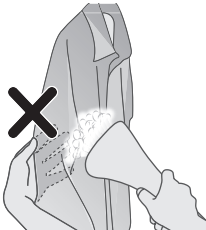

3 Không cầm quần áo ở vị trí tiếp xúc trực tiếp với hơi nước.



4 Không sử dụng đầu bàn ủi hơi nước hướng xuống dưới.

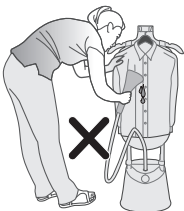

5 Không uốn cong ống khi ủi quần áo.

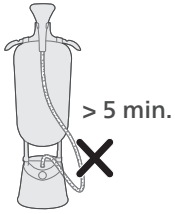

6 Không để bàn ủi hơi nước trụ đứng hoạt động mà không có người theo dõi quá 5 phút.

Lắp ráp thiết bị

STE1010

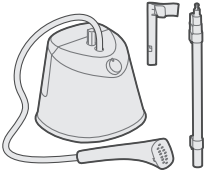

1 Hãy lưu ý các bộ phận được cung cấp kèm theo thiết bị bạn đã mua.

STE1020, STE1030
STE1040



STE1010

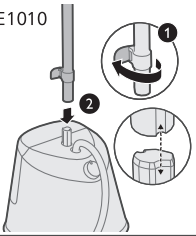

2 Mở khóa các kẹp khóa trụ dưới cùng và lắp (các) trụ vào đế. Đảm bảo canh (các) trụ và (các) chốt trụ để thẳng hàng với nhau.

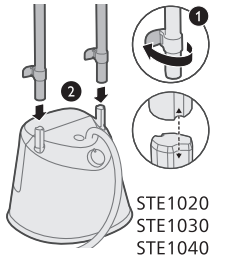

STE1020
STE1030
STE1040

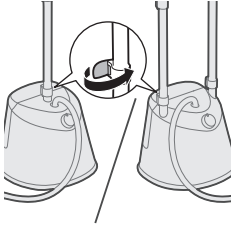

3 Khóa (các) kẹp khóa trụ dưới cùng.

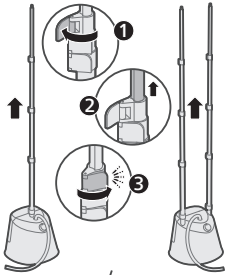

4 Mở khóa các kẹp khóa trụ còn lại, kéo (các) trụ lên trên hết cỡ và khóa lại.

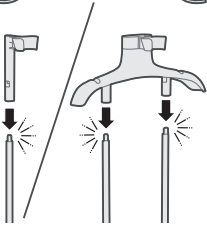

5 Lắp đầu kẹp bàn ủi hơi nước vào (các) trụ cho đến khi đầu kẹp khớp vào đúng vị trí (nghe tiếng tách).

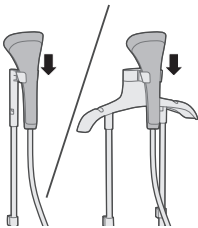

6 Gắn đầu bàn ủi hơi nước lên đầu kẹp.

Lắp ráp ván ủi

1 Hãy lưu ý các bộ phận được cung cấp kèm theo thiết bị bạn đã mua.

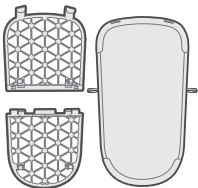

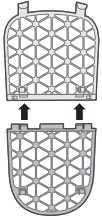

2 Canh thẳng hàng và lắp các kẹp ván úi vào đúng vị trí (nghe tiếng tách).



3 Canh thẳng hàng và lắp vỏ bọc ván úi bằng các móc ván úi.

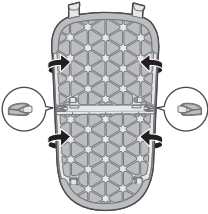

4 Móc dây đai của vỏ bọc ván úi vào các móc ở mặt sau của ván úi

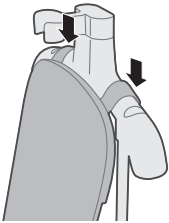

5 Treo ván úi lên móc treo.

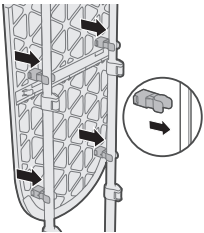

6 Cố định ván úi vào các trụ vào đúng vị trí (nghe tiếng tách).

7 Bạn có thể sử dụng móc treo để treo quần áo.

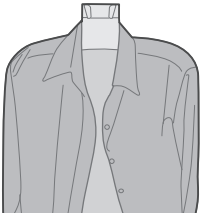
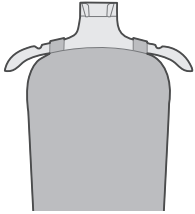

8 Bạn có thể sử dụng móc treo riêng của bạn và móc lên đầu kẹp bàn ủi hơi nước.

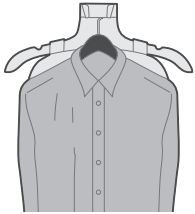

Lắp ráp tấm lót

1 Lồng dây đai ở giữa qua đầu kẹp bàn ủi hơi nước.

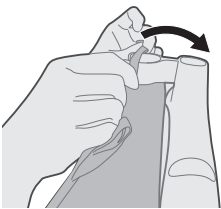

2 Cố định 3 dây đai vào móc phía sau móc treo.

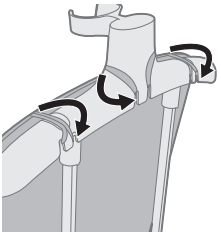

450 Tiếng Việt

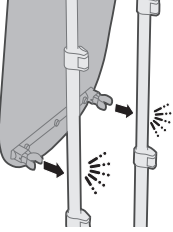

3 Cố định tấm lót vào các trụ ở đúng vị trí (nghe tiếng tách).

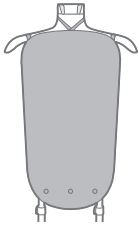

4 Bạn có thể sử dụng móc treo để treo quần áo.



5 Bạn có thể sử dụng móc treo riêng của bạn và móc lên đầu kẹp bàn ủi hơi nước.

Gắn bàn chải

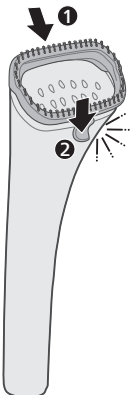

1 Căn chỉnh rãnh dọc theo định đầu bàn ủi hơi nước và gắn chốt ở phía dưới (nghe tiếng tách).

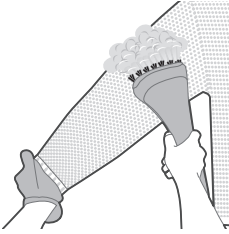

2 Bạn có thể đeo găng tay và ủi quần áo bằng cách sử dụng phụ kiện bàn chải.

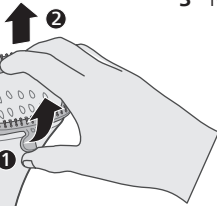

3 Nắm và kéo chốt dưới đầu bàn ủi ra để tháo phụ kiện bàn chải.

Châm nước vào ngăn chứa nước

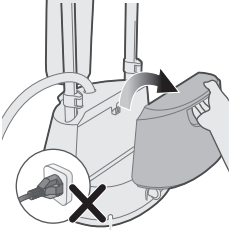

1 Không cắm điện thiết bị. Tháo ngăn chứa nước ra khỏi đế.

2 Lật ngăn chứa nước với nắp ngăn chứa nước hướng lên trên.

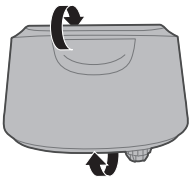

3 Vận nắp ngăn chứa nước ngược chiều kim đồng hồ để tháo ra.

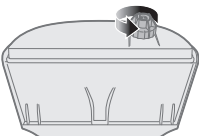

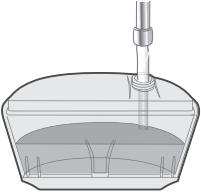

4 Châm đầy nước vào ngăn chứa nước.

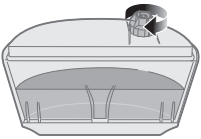

5 Vặn nắp ngăn chứa nước theo chiều kim đồng hồ để vặn chặt.

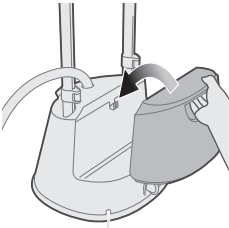

6 Canh ngăn chứa nước thẳng hàng với móc khi gắn vào lại để.

Thay đổi các cài đặt hơi nước

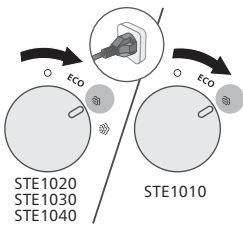

1 Đảm bảo thiết bị đã được cắm điện. Xoay núm điều chỉnh hơi phun đến cài đặt hơi nước mong muốn.

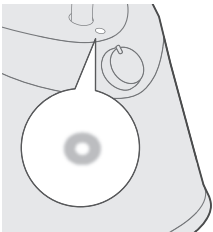

2 Đèn sẽ sáng liên tục để cho biết bàn ủi hơi nước trụ đứng đã được BẬT.

*STE1010/75: ~2 min

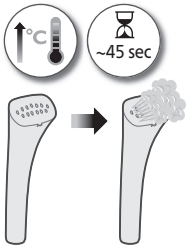

Mẹo ủi

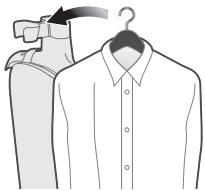

- 3 Chờ khoảng 45 giây để bàn ủi hơi nước trụ đứng nóng lên và tỏa hơi nước (STE1010/75: khoảng 2 phút).

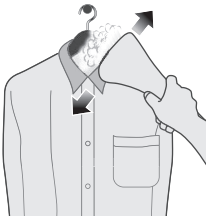

- 1 Bạn có thể sử dụng móc treo riêng của bạn và móc lên đầu kẹp bàn ủi hơi nước.



- 2 Di chuyển đầu bàn ủi hơi nước theo hướng song song với cổ áo.

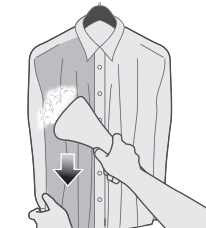

- 3 Di chuyển đầu bàn ủi hơi nước theo hướng nằm ngang với cầu vai.

- 4 Kéo căng quần áo. Di chuyển đầu bàn ủi hơi nước theo hướng xuống mặt trước thân áo.



5 Di chuyển đầu bàn ủi hơi nước theo hướng lên trên trên túi.

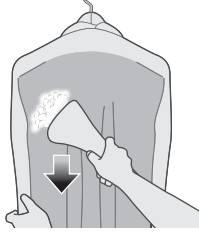

6 Kéo căng quần áo. Di chuyển đầu bàn ủi hơi nước theo hướng xuống mặt sau thân áo.

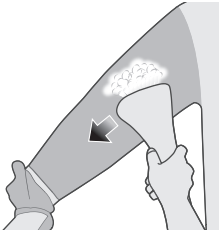

7 Kéo căng quần áo. Di chuyển đầu bàn ủi hơi nước theo hướng song song với tay áo.

Vệ sinh và bảo dưỡng

Hệ thống Thu gom cặn vôi

Thiết bị của bạn đã được thiết kế với hệ thống Thu gom cặn vôi. Bạn nên thực hiện tẩy cặn mỗi tháng một lần hoặc thường xuyên hơn. Tẩy cặn và vệ sinh thường xuyên giúp duy trì hiệu suất hơi nước mạnh và ngăn bụi bẩn bám vào mặt đế của bàn ủi theo thời gian.

Mẹo: Có thể sử dụng hệ thống Thu gom cặn vôi bất kỳ lúc nào. Hãy sử dụng chức năng này thường xuyên hơn nếu bạn sống ở khu vực có nước cứng.

Thực hiện quá trình tẩy cặn

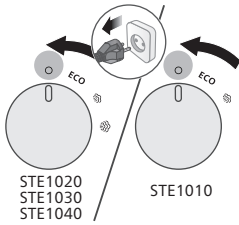

1 Đảm bảo nút điều chỉnh hơi phun ở nấc TẮT và đã rút phích cắm thiết bị.



2 Đảm bảo bàn ủi đã nguội hoàn toàn (> 1 giờ).

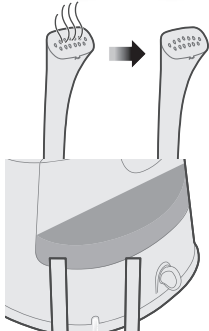

3 Đặt bàn ủi hơi nước gần lỗ thoát nước.

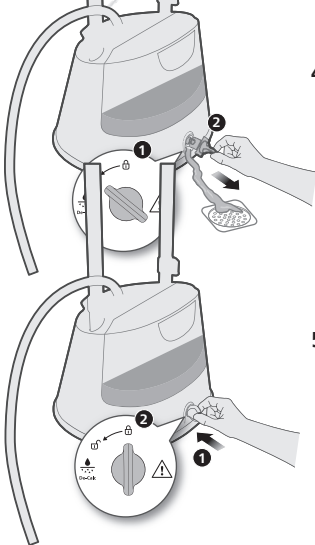

4 Xoay nút tẩy cặn đến vị trí mở khóa và tháo nút tẩy cặn. Xả nước ra.

5 Lắp và xoay nút tẩy cặn đến vị trí khóa.

Vệ sinh và bảo quản bàn ủi hơi nước trụ đứng

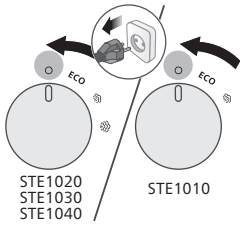

1 Đảm bảo núm điều chỉnh hơi phun ở nấc TẮT và đã rút phích cắm thiết bị.



2 Đảm bảo bàn ủi đã nguội hoàn toàn (> 1 giờ).

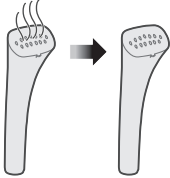

3 Dùng miếng vải ẩm lau mặt đế ủi.

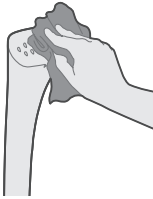

4 Đổ hết nước trong ngăn chứa nước.

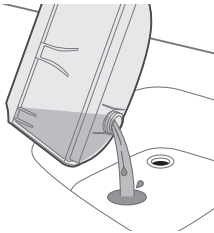

5 Quấn dây điện quanh đế.

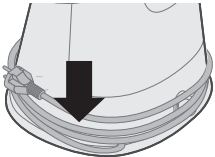

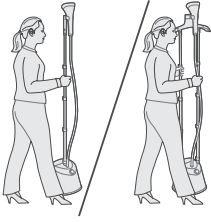

6 Bạn có thể cầm phần trụ để xách bàn ủi hơi nước trụ đứng.

Khắc phục sự cố

Chương này tóm tắt các sự cố thường gặp phải với thiết bị này. Nếu bạn không thể xử lý vấn đề bằng các thông tin bên dưới, hãy truy cập www.philips.com/support để xem danh sách các câu hỏi thường gặp hoặc liên hệ với Trung tâm Chăm sóc Khách hàng tại quốc gia bạn.

Sự cố	Nguyên nhân có thể	Giải pháp
Thiết bị tạo hơi phun không đều hoặc không có hơi phun.	Bàn ủi hơi nước vẫn chưa đủ nóng.	Để thiết bị nóng lên trong khoảng 45 giây (STE1010/75: khoảng 2 phút).
	Hơi phun bị nghẽn lại trong ống cấp.	Nhấc đầu bàn ủi lên để kéo thẳng ống cấp theo chiều dọc. Việc này sẽ giúp xử lý những chỗ bị tắc nghẽn.
	Ngăn chứa sắp hết nước hoặc ngăn chứa nước không được lắp đúng cách.	Châm lại nước vào ngăn chứa nước và lắp ngăn chứa đúng cách.
	Tích tụ quá nhiều cặn vôi trong thiết bị.	Thực hiện quá trình tẩy cặn. Tham khảo mục Thực hiện quá trình tẩy cặn.
Nước nhỏ giọt từ đầu bàn ủi hoặc thiết bị tạo tiếng xả khí.	Bạn đã để đầu bàn ủi và/hoặc ống cấp hơi phun nằm ngang trong một thời gian dài.	Nhấc đầu bàn ủi lên để kéo thẳng ống cấp theo chiều dọc. Việc này sẽ giúp xử lý những chỗ bị tắc nghẽn.
	Khi ống cấp hơi phun gấp thành hình chữ U, nước ngưng tụ có trong ống không thể chảy ngược vào lại ngăn chứa nước.	Nhấc đầu bàn ủi lên để kéo thẳng ống cấp theo chiều dọc. Việc này sẽ giúp xử lý những chỗ bị tắc nghẽn.

458 Tiếng Việt

Có nước đọng lại rỉ ra từ đầu bàn ủi khi thiết bị nóng lên.

Nước chứa trong bàn ủi là nước bắn hoặc nước để lâu ngày.

Thực hiện quá trình tẩy cặn. Tham khảo mục Thực hiện quá trình tẩy cặn.

Nước rỉ ra từ phía bên dưới đế.

Bạn chưa đóng chặt nắp ngăn chứa nước hoặc nút tẩy cặn. Ngăn chứa nước không được lắp đúng cách.

Đóng chặt nắp ngăn chứa nước hoặc nút tẩy cặn. Lắp ngăn chứa nước đúng cách.

STE1010

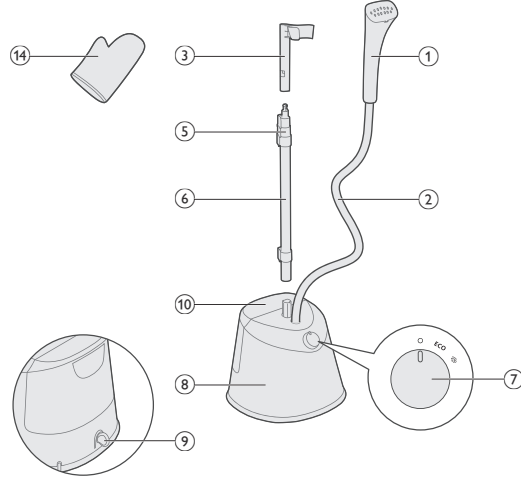

- 1 Buhar üretici başlığı
- 2 Buhar hortumu
- 3 Buhar üretici istasyonu
- 4 Askı (STE1020, STE1030, STE1040)
- 5 Bacak kilit klipsi
- 6 Bacak
- 7 Buhar düğmesi
- 8 Taban
- 9 De-calc düğmesi
- 10 Su haznesi
- 11 Masa (STE1040)
- 12 Kılıf (STE1040)
- 13 Mat (STE1030)
- 14 Eldiven
- 15 Fırça (STE1020, STE1030, STE1040)

Cihazın kullanıma hazırlanması

Kullanılabilir su türleri

Cihaz musluk suyuyla kullanıma uygundur. Ancak su sertliği yüksek olan bir bölgede yaşıyorsanız musluk suyunu eşit miktarda damıtılmış veya demineralize suyla karıştırmanızı öneririz. Bu, hızlı kireç birikmesini önleyerek cihazın ömrünü uzatacaktır.

Suyun sızmasına veya kahverengi lekelerle sebep olabileceğinden ve cihazınıza zarar verebileceğinden parfüm, kurutma makinesinde biriken su, sirke, kola, kireç çözücü maddeler, ütümeye yardımcı ürünler, kimyasal olarak kireçten arındırılmış su veya başka kimyasallar eklemeyin.

Uyarılar

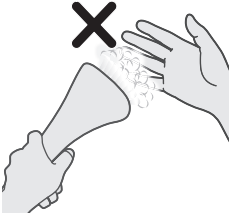

1 Cildinizin hiçbir kısmını buharla doğrudan temas ettirmeyin.



2 Buhar plakasını başka kişilere doğrultmayın.

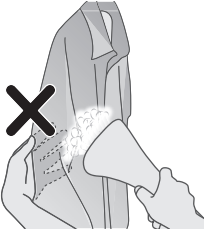

3 Giysinizi buharla doğrudan temas edecek şekilde tutmayın.



4 Buhar üretici başlığını aşağı yönde kullanmayın.

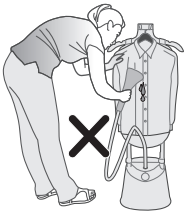

5 Giysiye buhar vermek için hortumu bükmeyin.

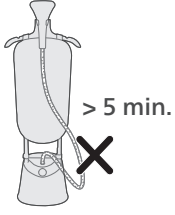

6 Standlı buhar üreticini 5 dakikadan uzun süre gözetimsiz bırakmayın.

Cihazın kurulması

STE1010

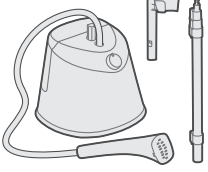

1 Satın aldığınız cihaz için mevcut olan parçalara dikkat edin.

STE1020, STE1030
STE1040



STE1010

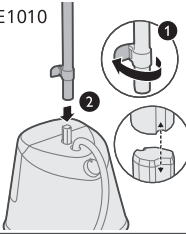

2 Alt bacak kilit klipslerini açın ve bacakları tabana yerleştirin. Bacakların ve taban bacak direklerinin profillerinin hizalandığından emin olun.

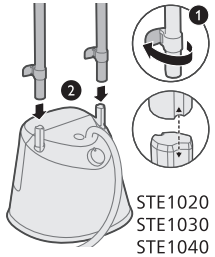

STE1020
STE1030
STE1040

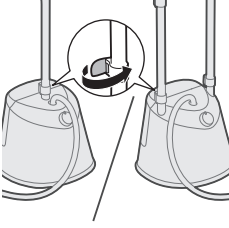

3 Alt bacak kilit klipslerini kilitleyin.

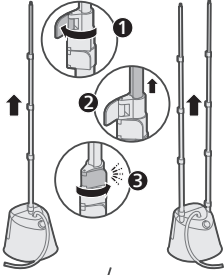

4 Kalan bacak kilit klipslerini açın, bacakları tamamen yukarı doğru uzatın ve kilitleyin.

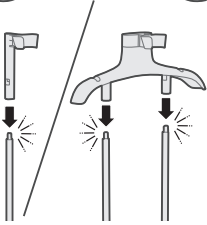

5 Buhar üretici istasyonunu yerine kilitleneneye kadar bacakların üzerine bastırın ("klik" sesi duyulur).

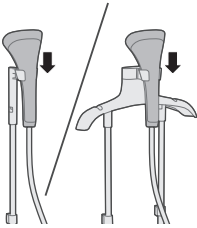

6 Buhar üretici başlığını buhar üretici istasyonunun üzerine yerleştirin.

Masanın kurulması

1 Satın aldığınız cihaz için mevcut olan parçalara dikkat edin.

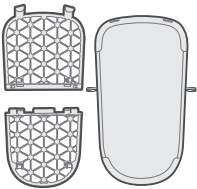

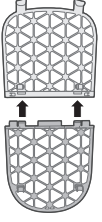

2 Masa klipslerini hizalayın ve yerine kilitlenene kadar bastırın ("klik" sesi duyulur).



3 Masa kılıfını masa kancalarıyla hizalayın ve yerleştirin.

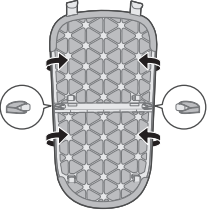

4 Masa kılıfı askılarını masanın arkasındaki kancalara takın

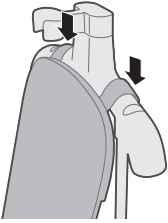

5 Masayı askının üzerine yerleştirin.

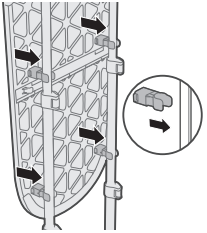

6 Masayı, yerine kilitlenene kadar bacaklara doğru bastırın ("klik" sesi duyulur).

7 Askıyı kullanarak kıyafetlerinizi asabilirsiniz.

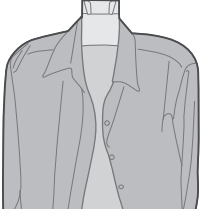
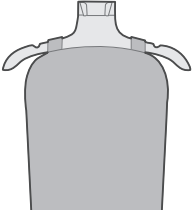

8 Kendi askınızı kullanabilir ve buhar üretici istasyonuna yerleştirebilirsiniz.

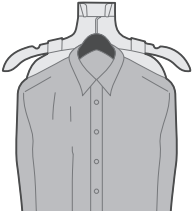

Matın ayarlanması

1 Orta askıyı buhar üretici istasyonundan geçirin.

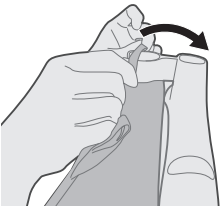

2 3 askıyı askının arkasındaki kancaya sabitleyin.

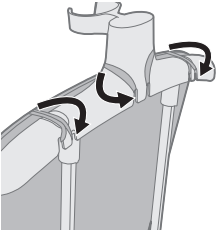

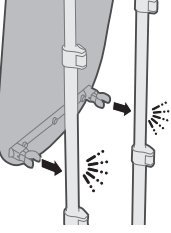

3 Matı, yerine kilitlenene kadar bacaklara sabitleyin ("klik" sesi duyulur).

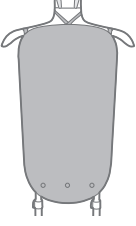

4 Askıyı kullanarak kıyafetlerinizi asabilirsiniz.



5 Kendi askınızı kullanabilir ve buhar üretici istasyonuna yerleştirebilirsiniz.

Fırçanın takılması

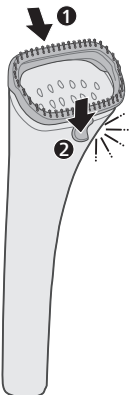

1 Kenarları buhar üretici başlığının üst kısmı boyunca hizalayın ve alttaki mandalı bastırarak yerine oturtun ("klik" sesi duyulur).

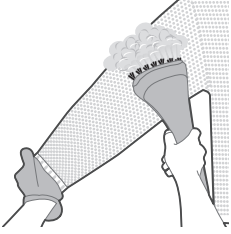

2 Eldiveni takabilir ve giysilerinizi fırça aparatını kullanarak buharlayabilirsiniz.

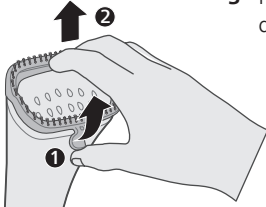

3 Fırça aparatını çıkarmak için mandalı buhar üretici başlığının altından tutun ve dışarı çekin.

Su haznesinin doldurulması

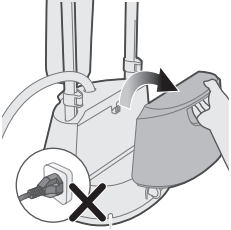

1 Cihazın fişini prize takmayın. Su haznesini tabandan çıkarın.

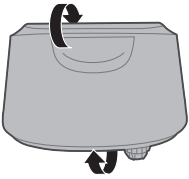

2 Su haznesini, su haznesi kapağı yukarı bakacak şekilde çevirin.

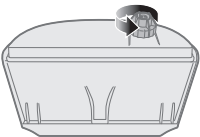

3 Su haznesi kapağını çıkarmak için saat yönünün tersine çevirin.

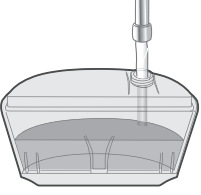

4 Su haznesini doldurun.

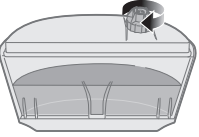

5 Su haznesi kapağını sıkmak için saat yönünde çevirin.

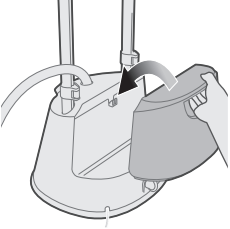

6 Kancayla hizalayarak su haznesini tekrar tabana yerleştirin.

Buhar ayarlarının değiştirilmesi

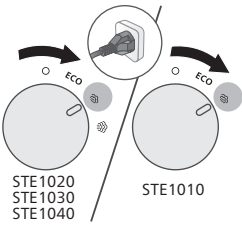

1 Cihazın prize takılı olduğundan emin olun. Buhar düğmesini istediğiniz buhar ayarına getirin.

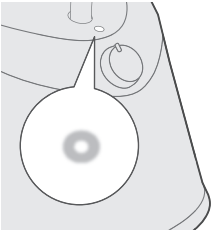

2 Standlı buhar üreticinin AÇIK olduğunu göstermek için ışık sabit bir şekilde yanar.

*STE1010/75: ~2 min

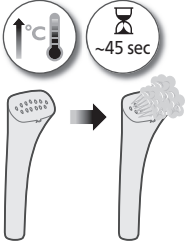

- 3 Standlı buhar üreticinin ısınması ve buhar yayması için yaklaşık 45 saniye bekleyin (STE1010/75: yaklaşık 2 dakika).

Ütüleme ipuçları

- 1 Kendi askınızı kullanabilir ve buhar üretici istasyonuna yerleştirebilirsiniz.

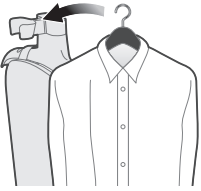

- 2 Buhar üretici başlığını yakaya paralel yönde hareket ettirin.

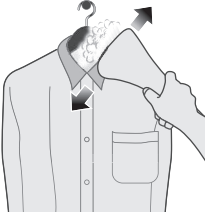

- 3 Buhar üretici başlığını giysinin robasına yatay yönde hareket ettirin.

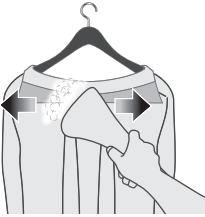

- 4 Giysiyi gerdirin. Buhar üretici başlığını gövdenin ön tarafında aşağı yönde hareket ettirin.

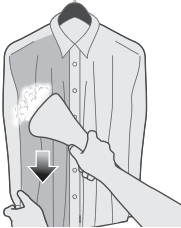



5 Buhar üretici başlığını cep üzerinde yukarı doğru hareket ettirin.

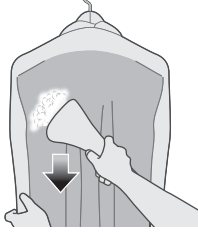

6 Giysiyi gerdirin. Buhar üretici başlığını gövdenin arka tarafında aşağı yönde hareket ettirin.

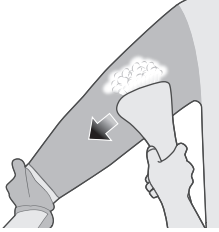

7 Giysiyi gerdirin. Buhar üretici başlığını giysinin koluna paralel yönde hareket ettirin.

Temizlik ve bakım

Kireç Toplayıcı

Cihazınız bir Kireç Toplayıcı sistemine sahip şekilde tasarlanmıştır. Ayda bir veya daha sık aralıklarla kireç temizleme işlemi yapmanız önerilir. Bu özellik, güçlü bir buhar performansı sağlarken zamanla tabandan kir ve leke gelmesini engeller.

İpucu: Kireç Toplayıcı sistemi istenildiği zaman kullanılabilir. Suyun sert olduğu bir bölgede yaşıyorsanız bu işlevi daha sık kullanın.

Kireç temizleme işleminin gerçekleştirilmesi

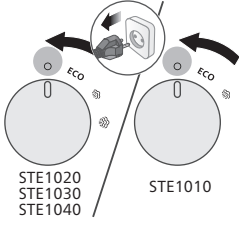

- 1 Buhar düğmesinin KAPALI konumda olduğundan ve cihazın fişinin çekildiğinden emin olun.

- 2 Ütünün tamamen soğuduğundan emin olun (en az 1 saat).

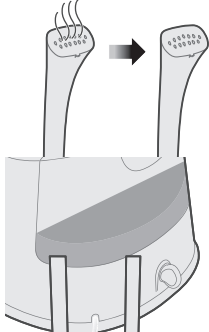

- 3 Buhar üreticiyi giderin yakınına yerleştirin.

- 4 De-calc düğmesini kilit açma konumuna getirin ve De-calc düğmesini çıkarın. Suyun boşalmasını bekleyin.

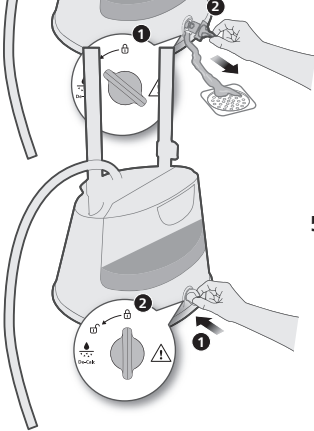

- 5 De-calc düğmesini takın ve kilit konumuna getirin.

Standlı buhar üreticinin temizlenmesi ve saklanması

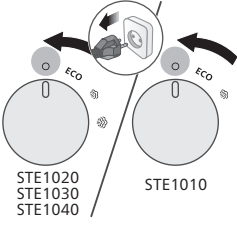

- 1 Buhar düğmesinin KAPALI konumda olduğundan ve cihazın fişinin çekildiğinden emin olun.

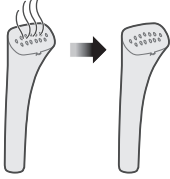

- 2 Ütünün tamamen soğuduğundan emin olun (en az 1 saat).

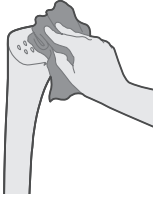

- 3 Buhar plakasını nemli bir bezle silin.

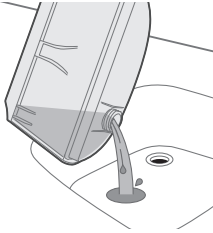

- 4 Su haznesini tamamen boşaltın.

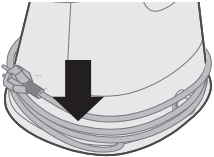

- 5 Güç kablosunu tabanın etrafına sarın.

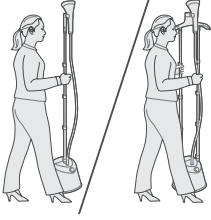

6 Standlı buhar üreticiyi bacağından tutarak taşıyabilirsiniz.

Sorun giderme

Bu bölümde cihaz ile ilgili en sık karşılaşılan sorunlar özetlenmiştir. Sorunu aşağıdaki bilgilerle çözemezseniz sık sorulan sorular listesi için www.philips.com/support adresini ziyaret edin veya ülkenizdeki Tüketici Destek Merkezi ile iletişime geçin.

Sorun	Olası neden	Çözüm
Cihaz hiç buhar üretmiyor veya düzensiz buhar üretiyor.	Buhar üretici yeterince ısınmamıştır.	Cihazın ısınması için yaklaşık 45 saniye bekleyin (STE1010/75: yaklaşık 2 dakika).
	Hortumda buhar yoğunlaşmıştır.	Hortumu düzleştirerek dik konuma için buhar üretici başlığını kaldırın. Bu sayede hortumda yoğunlaşan su, su haznesine geri akar.
	Haznedeki su miktarı yeterli değildir veya hazne düzgün takılmamıştır.	Su haznesini doldurun ve düzgün şekilde takın.
	Cihazda çok fazla kireç birikmiştir.	De-calc işlemini gerçekleştirin. Kireç Temizleme bölümüne bakın.
Buhar üretici başlığından su damlacıkları akıyor veya cihaz garip sesler çıkarıyor.	Buhar üretici başlığı ve/veya buhar hortumu uzun süre yatay konumda bırakılmıştır.	Hortumu düzleştirerek dik konuma için buhar üretici başlığını kaldırın. Bu sayede hortumda yoğunlaşan su, su haznesine geri akar.
	Hortum U şeklini aldığı anda hortumda yoğunlaşan su, su haznesine geri akamaz.	Hortumu düzleştirerek dik konuma için buhar üretici başlığını kaldırın. Bu sayede hortumda yoğunlaşan su, su haznesine geri akar.

474 Türkçe

Cihaz ısınırken buhar üretici başlığından aşırı miktarda su damlıyor.

Cihazdaki su kirlidir veya uzun süre cihazın içinde kalmıştır.

De-calc işlemini gerçekleştirin. Kireç Temizleme bölümüne bakın.

Buhar üreticinin tabanından su damlıyor.

Su haznesinin kapağı veya de-calc düğmesi sıkıca kapatılmamıştır. Su haznesi düzgün takılmamıştır.

Su haznesinin kapağını ve de-calc düğmesini sıkıca kapatın. Su haznesini düzgün bir şekilde takın.

Giriş

Satyn almagyňyz bilen gutlaýarys we Philips dünýäsine hoş geldiňiz! Philips tarapyndan hödürlenilýän goldawdan doly peýdalanmak üçin önümiňizi www.philips.com/welcome salgysynda bellige aldyryň. Enjamy ulanmazdan ozal şu ulanyjy gollanmasyny, möhüm maglumat kagyzyňy we çalt başlangyç ýolbeledini üns bilen okaň. Olary geljekde gollanmak üçin saklaň.

Önüme umumy syn

STE1020, STE1030, STE1040

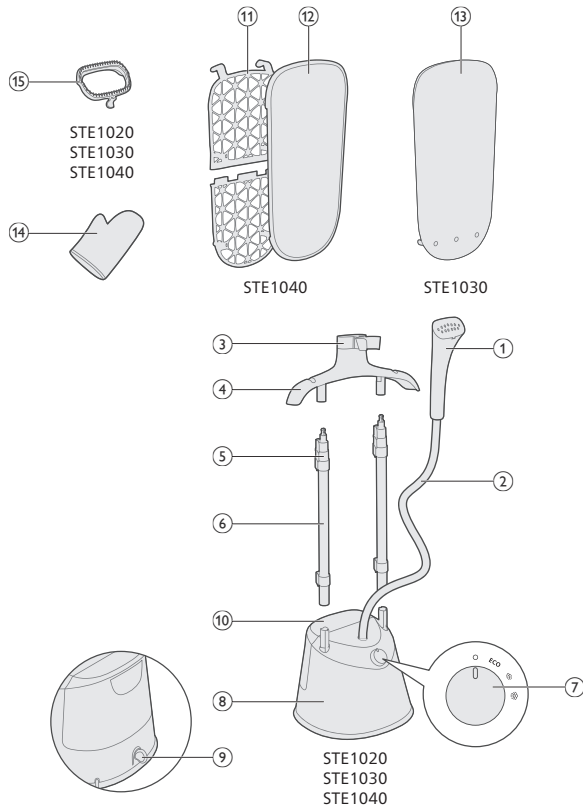

STE1010

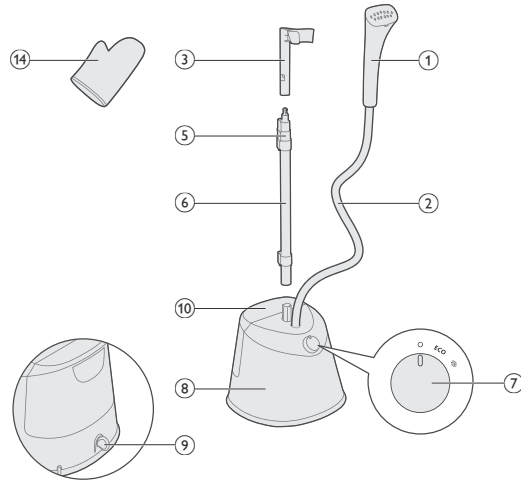

- 1 Bug çykarýan ujy
- 2 Bug üpjünçilik şlangy
- 3 Bugly ütügiň esasy
- 4 Asgýç (STE1020, STE1030, STE1040)
- 5 Sütüne berkidiji gysgýç
- 6 Sütün
- 7 Bugy düzýän nurbat
- 8 Esas
- 9 Çökündileri aýyrmakda ulanylýan nurbat
- 10 Suw gaby
- 11 Tagta (STE1040)
- 12 Örtük (STE1040)
- 13 Düşekçe (STE1030)
- 14 Ellik
- 15 Çotga (STE1020, STE1030, STE1040)

Ulanyşa taýýarlamak

Ulanylmalý suwuň görnüşi

Enjamy agyz suw üpjünçiligi arkaly gelýän suw bilen ulanmak ýerlikli bolar. Emma, ýaşayan ýeriňizde gaty suw bar bolsa, şäheriň suw ulgamyndan gelýän suw bilen distillirlenen ýa-da mineralsyzlaşdyrylan suwy deň möçberde goşmagyňyzy maslahat berýäris. Şeýtmek enjamda galyndylaryň çalt emele gelmeginiň önüni alar we enjamyň ömrüni uzaldar.

Ys beriji, guradyjy enjamdan çykan suw, sirke, krahmal, galyndyny aýyryan serişdeler, ütüketmekde kömekçi serişdeler, himiki taýdan galyndysy aýrylan suw ýa-da başga himikatlary ulanmaň, sebäbi

olar suwuň dammagyna, goňur tegmillere ýa-da enjamyňyza zeper ýetmegine sebäp bolup biler.

Duýduryşlar

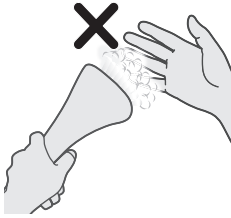

1 Deriniň hiç bir böleginiň bug bilen gönümel galtaşmagyna ýol bermäň.



2 Bug çykarýan plastinasyny başga adamlara gönükdirmäň.

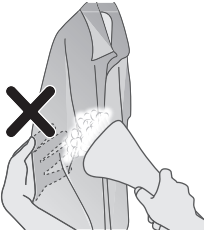

3 Geýimiňizi bug bilen gönümel galtaşar ýaly edip tutmaň.

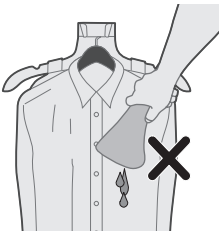

4 Bug çykarýan uýy aşak gönükdirilen ýagdaýda ulanmaň.



5 Geýimi bug bilen ütüklemek üçin şlangy eplemäň.

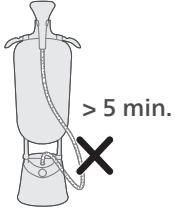

6 Aýakda durýan bugly ütügi 5 minutdan köp gözegçiliksiz galdyрмаň.

Enjamy sazlamak

STE1010

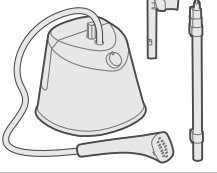

1 Satyn alan enjamyňyz üçin elýeter bölekleri belläp alyň.

STE1020, STE1030
STE1040

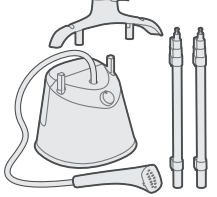

2 Aşaky sütüne gulplaýan gysgyçlary açyň we sütün(ler)i baza geýdiriň. Sütün(ler)iň profilleri bilen esasdaky sütüniň söýeg(ler)iniň biri-birine gabat gelýändigine göz ýetiriň.

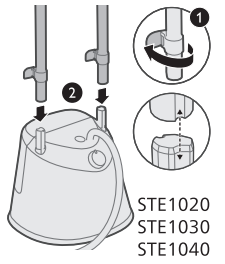
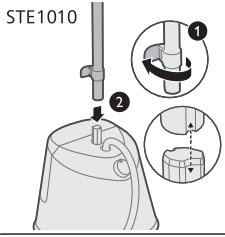

STE1020
STE1030
STE1040

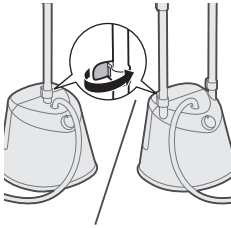

3 Aşaky sütünä gulplaýan gysgyç(lar)y gulplaň.

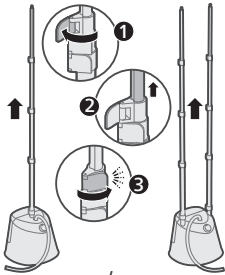

4 Galan sütünä gulplaýan gysgyçlary açyň, sütün(ler)i ýokarlygyna soňuna çenli uzaldyň we gulplaň.

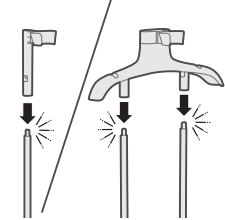

5 Bugly ütügiň esasyny ýerine oturýança ("şyrk" sesi) sütün(ler)e geýdiriň.

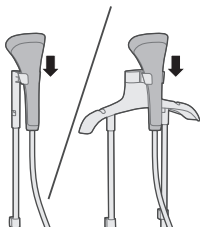

6 Bug çykarýan ujuny bugly ütügiň esasynda ýerleşdiriň.

Tagtany sazlamak

1 Satyn alan enjamyňyz üçin elýeter bölekleri belläp alyň.

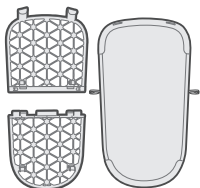

2 Tagtanyň gysgyçlaryny gabatlaň we ýerine oturýança ("şyrk" sesi) olary ýerine geýdiriň.

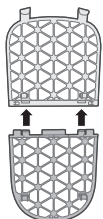

3 Tagtanyň örtüginu tagtanyň gaňyrçaklaryndan geçirip gabatlaň we dakyň.

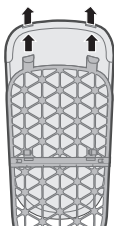

4 Tagtanyň örtüginu saklaýan gaýýşlary tagtanyň arkasyndaky gaňyrçaklara ildiriň

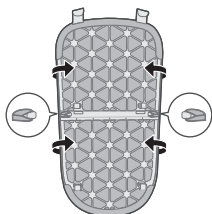

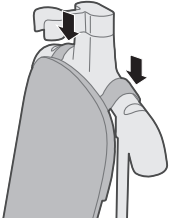

5 Tagtany asgyja ýerleşdiriň.

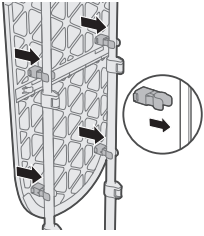

6 Tagtany ýerine oturýança ("şyrk" sesi) sütünlere berkidiň.

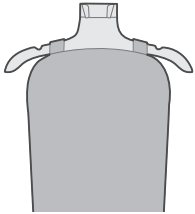

7 Asgyjy ulanmak arkaly geýimleriňizi asyp bilersiňiz.

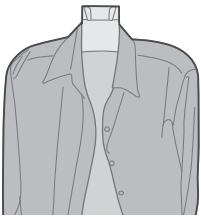

8 Öz asgyjyňyzy ulanyp we ony bugly üstügiň esasyňyň ýokarsynda ýerleşdirip bilersiňiz.

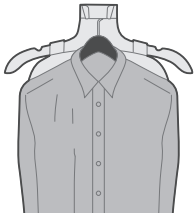

Düşekçäni sazlamak

1 Ortaky gaýysy bugly ütügiň esasyndan geçiriň.

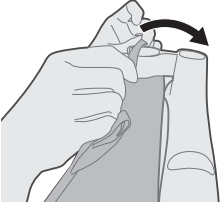

2 3 gaýysy tagtanyň arkasyndaky gaňyrçaga berkidiň.

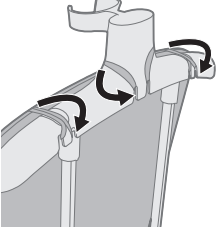

3 Düşekçe ýerine oturýança ("şyrk" sesi) ony sütünlere berkidiň.

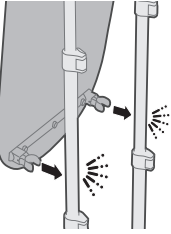

4 Asgyjy ulanmak arkaly geýimleriňizi asyp bilersiňiz.

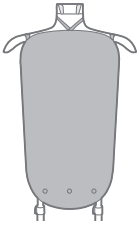



- 5 Öz asgyjyňyzy ulanyp we ony bugly üstügiň esasynyň ýokarsynda ýerleşdirip bilersiňiz.

Çotgany dakmak

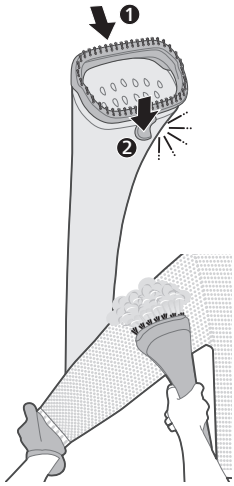

- 1 Gönükdirijini bug çykarýan ujuň depesine gabatlaň we ilgiji iň aşagyna ildiriň ("şyrk" sesi).

- 2 Ellik geýip we çotga nasadkasyny ulanmak bilen geýimleriňizi bugly ütöklöp bilersiňiz.

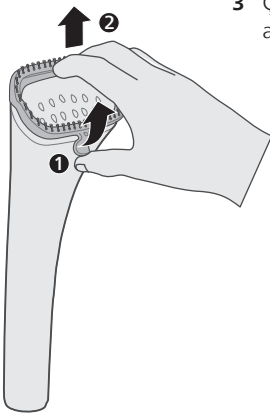

- 3 Çotga nasadkasyny aýyrmak üçin ilgiji garbaň we ony bug çykarýan ujuň aşagyndan çekip çykaryň.

Suw gabyny doldurmak

1 Enjamy toga dakmaň. Suw gabyny esasan aýryň.

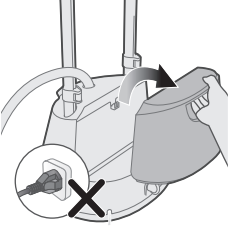

2 Suw gaby ýokary seredip duran ýagdaýda suw gabyny dolduryň.

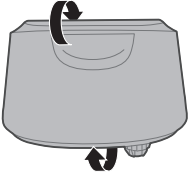

3 Suw gabynyň gapagyny aýyrmak üçin ony sagadyň diliniň tersine towlaň.

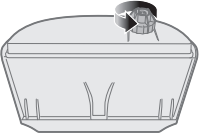

4 Suw gabyny dolduryň.

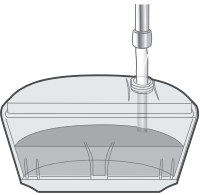

5 Suw gabynyň gapagyny berkitmek üçin ony sagadyň diliniň ugruna aýlaň.

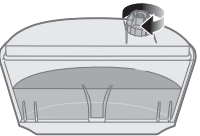

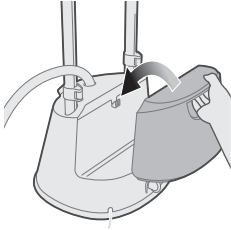

- 6 Suw gabyny esasdaky ýerine ýerleşdirmek üçin gaňyrçak bilen gabatlaň.

Bug sazlamalaryny üýtgetmek

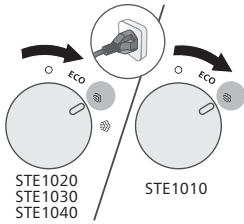

- 1 Enjamyň toga dakylandygyna göz ýetiriň. Bugy düzýän nurbady islenilýän bug sazlamasyna aýlaň.

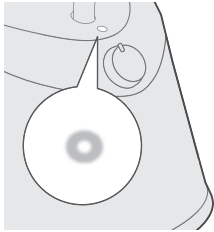

- 2 Bugly ütügiň AÇYKDYGYNY görkezmek üçin çyra birsyhly ýanyp durar.

*STE1010/75: ~2 min

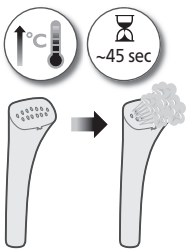

- 3 Aýakda durýan bugly ütügiň gyzmagy we bug çykarmagy üçin 45 sekunt töweregi garaşyň (STE1010/75: 2 minut wagt alýar).

Ütüklemek boýunça peýdaly maslahatlar

- 1 Öz asgyjyňyzy ulanyp we ony bugly üstügiň esasyň ýokarsynda ýerleşdirip bilersiňiz.

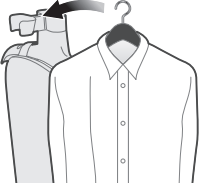

- 2 Bug çykarýan ujuny ýaka bilen ugurdaş hereket etdiriň.

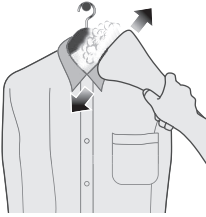

- 3 Bug çykarýan ujuny manžet bilen kese ugurda hereket etdiriň.



- 4 Geýimi çekiň. Bug çykarýan ujuny geýimiň öň tarapynda aşaklygyna hereket etdiriň.

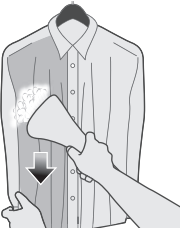

- 5 Bug çykarýan ujuny jübiniň üstünde ýokarlygyna hereket etdiriň.



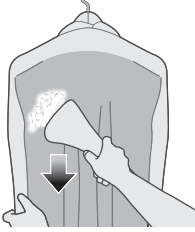

6 Geýimi çekiň. Bug çykarýan ujuny geýimiň arkasynda aşaklygyna hereket etdiriň.

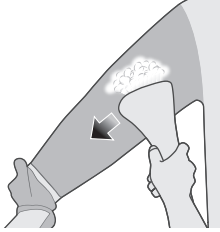

7 Geýimi çekiň. Bug çykarýan ujuny ýeň bilen ugurdaş hereket etdiriň.

Arassalamak we abatlamak

Çökündini ýygnaýjy

Enjamyňyz çökündini ýygnaýjy ulgam bilen işlenip düzüldi. Aýda bir gezek ýa-da has köp çökündini aýyrmak maslahat berilýär. Bu enjamdan güýçli buguň öndürilmegini üpjün etmäge we wagtyň geçmegi bilen ütügiň dabanyndan hapalaryň hem-de tegmilleriň çykmagynyň önüni almaga ýardam berýär.

Maslahat: Çökündini ýygnaýjy ulgamy islendik wagt ulanyp bolýar. Ýaşayan sebitiňizdäki suw talh bolsa, funksiýany has ýyggy ulanyň.

Çökündini aýyrmagy ýerine ýetirmek

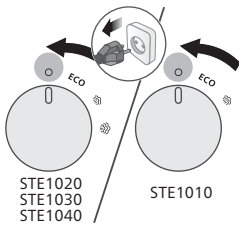

1 Buggy düzýän nurbadyň OFF (Öçürilen) ýagdaýdadygyna we enjamyň tokdan aýrylandygyna göz ýetiriň.

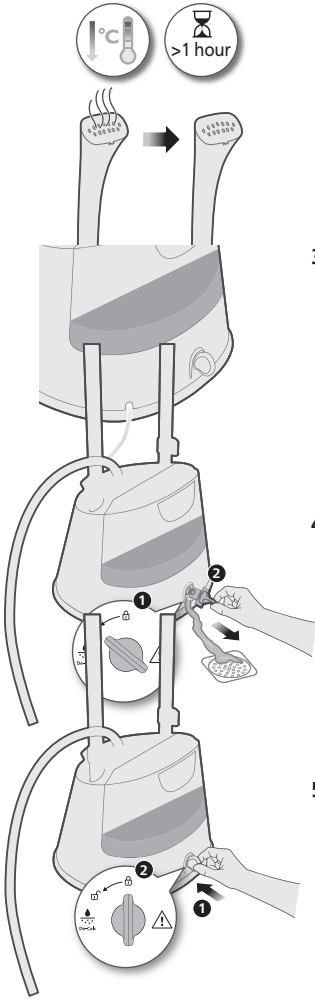

2 Ütügiň doly sowandygyna (> 1 sagat) göz ýetiriň.

3 Bugly ütügi nowajygyň golaýyna ýerleşdiriň.

4 Çökündileri aýyrmakda ulanylýan nurbady gulpy açylan ýagdaýa aýlaň we çökündileri aýyrmakda ulanylýan nurbady aýryň. Suwuň akmagyna maý beriň.

5 Çökündileri aýyrmakda ulanylýan nurbady dakyň we gulp ýagdaýyna aýlaň.

Aýakda durýan bugly ütügi arassalamak we saklamak

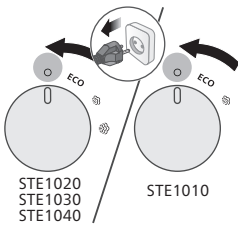

1 Bugy düzýän nurbadyň OFF (Öçürilen) ýagdaýdadygyna we enjamyň tokdan aýrylandygyna göz ýetiriň.

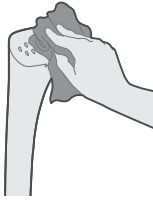
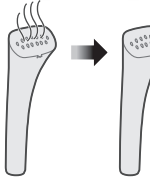

2 Ütügiň doly sowandygyna (> 1 sagat) göz ýetiriň.

3 Bug çykýan ýerini çygly mata bilen süpüriň.

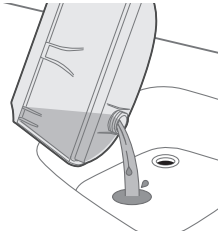

4 Suw gabyny doly boşadyň.

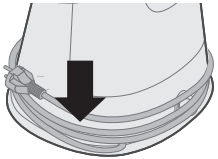

5 Elektrik kabelini esasyň daşyna saraň.

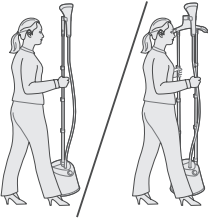

6 Aýakda durýan bugly ütügi sütüninden tutup göterip bilersiňiz.

Näsazlyklary anyklaýyş

Bu bölümde enjamda öňüňize çykyp biljek umumy meseleler barada gysgaça maglumat berilýär. Aşakda berlen maglumatlar bilen meseläni çözüp bilmeseňiz, köp soralyan soraglaryň sanawyny görmek üçin www.philips.com/support salgysyna giriň ýa-da ýurduňyzdaky Müşderiler bilen işleşmek boýunça merkeze ýüz tutuň.

Näsazlyk	Ähtimal sebäbi	Çözüň
Enjam bug çykarmaýar ýa-da çykarýan bugy endigan däl.	Enjam ýeterlik derejede gyzmandyr.	Enjamyň takmynan 45 sekuntlap gyzmagyna garaşyň (STE1010/75: 2 minut wagt alýar).
	Bug şlanganyň içinde suwa öwrülipdir.	Şlangy dik ýagdaýa getirmek üçin bug çykaryjy ujuny ýokary galdyryň. Bu bugdan dörän suwuň yzyna akmagyna mümkinçilik berýär.
	Gapdaky suw az ýa-da gap göwnejaý dakylmandyr.	Suw gabyny gaýtadan dolduryň we ony ýerine göwnejaý dakyň.
	Enjamyň içinde çendenaşa köp galyndy ýygnaýpdyr.	Galyndylary aýyrmagy ýerine ýetiriň. Çökündileri aýyrmak baradaky bölüme serediň.
Bug çykaryjy ujundan suw damjalary damýar ýa-da enjamdan jygyldy sesi çykýar.	Bug çykarýan ujuny we/ýa-da bug üpjünçilik şlangasyny çendenaşa uzak wagtlap kese ýagdaýda goýupsyňyz.	Şlangy dik ýagdaýa getirmek üçin bug çykaryjy ujuny ýokary galdyryň. Bu bugdan dörän suwuň yzyna akmagyna mümkinçilik berýär.
	Şlanga U şekilli eplenende şlanganyň içinde bugdan emele gelen suw yzyna, suw gabyna akyp bilmeyär.	Şlangy dik ýagdaýa getirmek üçin bug çykaryjy ujuny ýokary galdyryň. Bu bugdan dörän suwuň yzyna akmagyna mümkinçilik berýär.
Enjam gyzýan wagty bug çykarýan ujundan çendenaşa köp suw damýar.	Enjamyň içindäki suw hapa ýa-da uzak wagtlap enjamyň içinde durupdyr.	Galyndylary aýyrmagy ýerine ýetiriň. Çökündileri aýyrmak baradaky bölüme serediň.
Bug çykýan esasdan suw damýar.	Suw gabynyň gapagyny ýa-da galyndylary aýyrmakda ulanylýan nurbady berk ýapmansyňyz. Suw gaby ýerine göwnejaý dakylmandyr.	Suw gabynyň gapagyny ýa-da galyndylary aýyrmakda ulanylýan nurbady berk ýapyň. Gaby ýerine göwnejaý edip dakyň.

Εισαγωγή

Συγχαρητήρια για την αγορά σας και καλώς ήρθατε στη Philips! Για να επωφεληθείτε πλήρως από την υποστήριξη που προσφέρει η Philips, δηλώστε το προϊόν σας στη διεύθυνση www.philips.com/welcome. Διαβάστε προσεκτικά αυτό το εγχειρίδιο χρήσης, το φυλλάδιο σημαντικών οδηγιών και τον οδηγό γρήγορης έναρξης προτού χρησιμοποιήσετε τη συσκευή. Φυλάξτε τα για μελλοντική αναφορά.

Επισκόπηση προϊόντος

STE1020, STE1030, STE1040

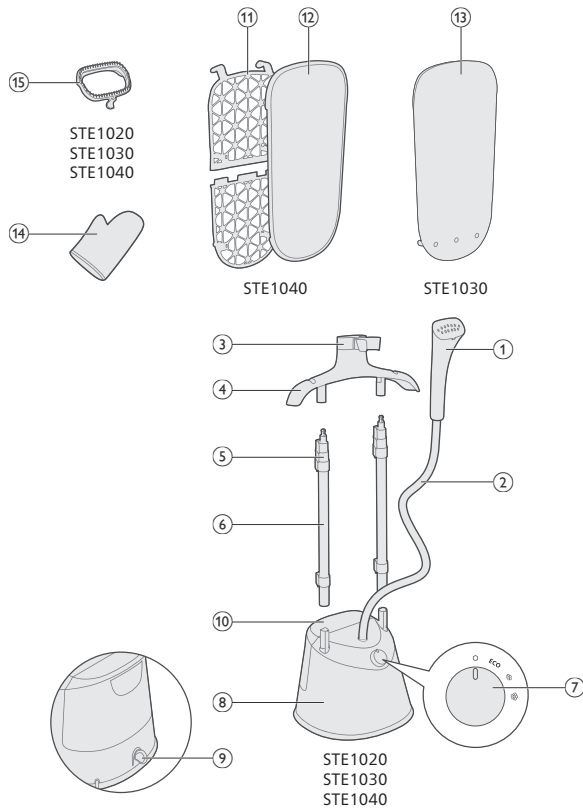

STE1010

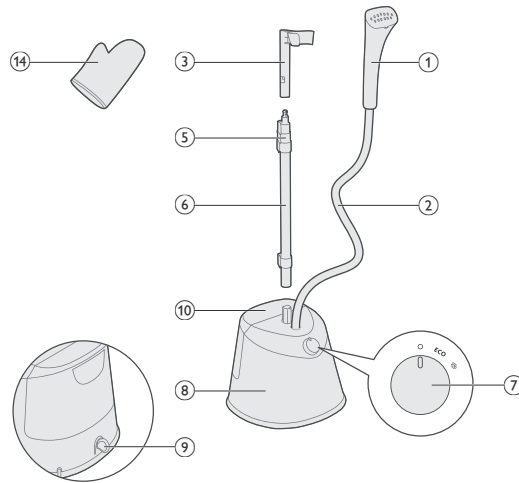

- 1 Κεφαλή ατμού
- 2 Σωλήνας τροφοδοσίας ατμού
- 3 Βάση ατμοσιδερωτή
- 4 Κρεμάστρα (STE1020, STE1030, STE1040)
- 5 Κλιπ ασφάλισης κολώνας
- 6 Κολώνα
- 7 Κομπιτί ατμού
- 8 Βάση
- 9 Κομπιτί αφαλάτωσης
- 10 Δοχείο νερού
- 11 Σιδερώστρα (STE1040)
- 12 Κάλυμμα (STE1040)
- 13 Επιφάνεια (STE1030)
- 14 Γάντι
- 15 Βούρτσα (STE1020, STE1030, STE1040)

Προετοιμασία για χρήση

Τύπος νερού για χρήση

Η συσκευή είναι κατάλληλη για χρήση με νερό βρύσης. Ωστόσο, αν ζείτε σε μια περιοχή με σκληρό νερό, σας συνιστούμε να αναμείξετε ίση ποσότητα νερού βρύσης με αποσταγμένο ή απιονισμένο νερό. Αυτό θα αποτρέψει την ταχεία συσσώρευση αλάτων και θα παρατείνει τη διάρκεια ζωής της συσκευής.

Μην χρησιμοποιείτε άρωμα, το νερό από το στεγνωτήριο, ξύδι, κόλλα κολλαρίσματος, ουσίες αφαλάτωσης, υγρά σιδερώματος, χημικά αφαλατωμένο νερό ή άλλα χημικά, καθώς οι ουσίες αυτές ενδέχεται να προκαλέσουν διαρροή νερού, καφέ κηλίδες ή βλάβη στη συσκευή.

Προειδοποιήσεις

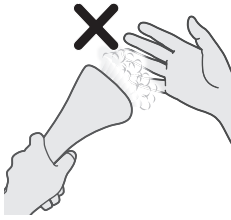

1 Μην φέρνετε κανένα μέρος του δέρματος σε άμεση επαφή με τον ατμό.



2 Μην στρέψετε την πλάκα ατμού προς άλλα άτομα.

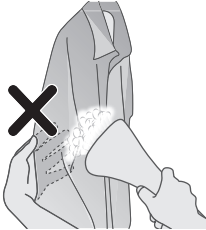

3 Μην κρατάτε το ρούχο σας με τρόπο ώστε να έρχεται σε άμεση επαφή με τον ατμό.

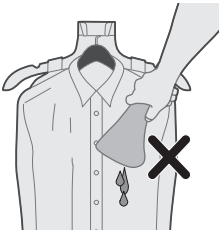

4 Μην χρησιμοποιείτε την κεφαλή του ατμοσιδερωτή προς τα κάτω.

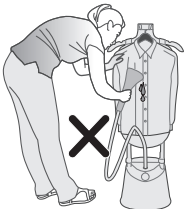

5 Μην λυγίζετε τον σωλήνα για να σιδερώσετε με ατμό το ρούχο.

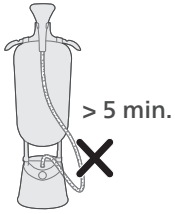

6 Μην αφήνετε τον ατμοσιδερωτή χωρίς επίβλεψη για περισσότερο από 5 λεπτά.

Ρύθμιση της συσκευής

STE1010

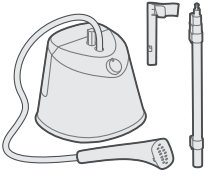

1 Σημειώστε τα εξαρτήματα που διατίθενται για τη συσκευή που αγοράσατε.

STE1020, STE1030
STE1040



STE1010

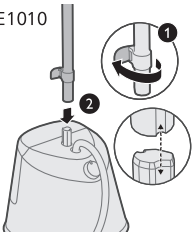

2 Απασφαλίστε τα κάτω κλιπ ασφάλισης κολώνας και εισαγάγετε τις κολώνες στη βάση. Βεβαιωθείτε ότι τα προφίλ των κολώνων και οι υποδοχές των κολώνων βάσης είναι ευθυγραμμισμένα.

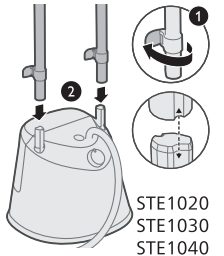

STE1020
STE1030
STE1040

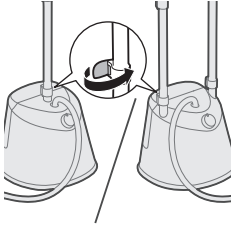

3 Ασφαλίστε τα κάτω κλιπ ασφάλισης της κολώνας.

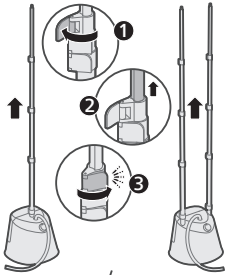

4 Απασφαλίστε τα υπόλοιπα κλιπ ασφάλισης της κολώνας, εκτείnete πλήρως τις κολώνες προς τα πάνω και ασφαλίστε τις.

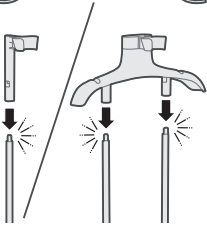

5 Τοποθετήστε τη βάση του ατμοσιδερωτή στις κολώνες μέχρι να ασφαλίσει στη θέση της ("κλικ").

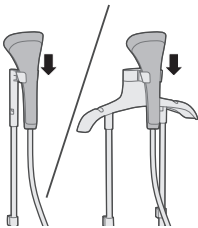

6 Τοποθετήστε την κεφαλή του ατμοσιδερωτή στη βάση του ατμοσιδερωτή.

Ρύθμιση της σιδερώστρας

1 Σημειώστε τα εξαρτήματα που διατίθενται για τη συσκευή που αγοράσατε.

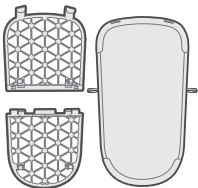

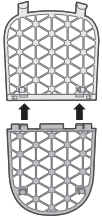

2 Ευθυγραμμίστε και τοποθετήστε τα κλιπ της σιδερώστρας μέχρι να ασφαλίσει στη θέση της ("κλικ").



3 Ευθυγραμμίστε και τοποθετήστε το κάλυμμα της σιδερώστρας μέσα από τα άγκιστρα της σιδερώστρας.

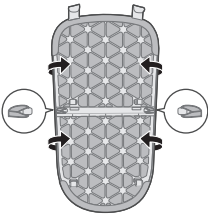

4 Συνδέστε τους μίαντες του καλύμματος της σιδερώστρας στα άγκιστρα που βρίσκονται στο πίσω μέρος της σιδερώστρας

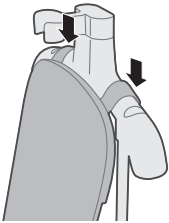

5 Τοποθετήστε τη σιδερώστρα στην κρεμάστρα.

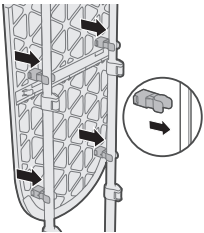

6 Ασφαλίστε τη σιδερώστρα στην κολώνα μέχρι να ασφαλίσει στη θέση της ("κλικ").

- 7 Μπορείτε να κρεμάσετε τα ρούχα σας στην κρεμάστρα.

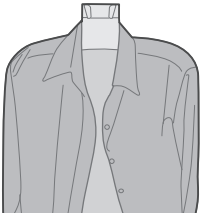
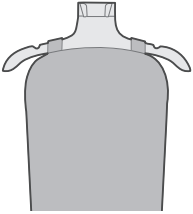

- 8 Μπορείτε να χρησιμοποιήσετε τη δική σας κρεμάστρα και να την τοποθετήσετε στη βάση του ατμοσιδερωτή.

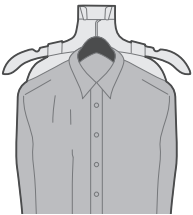

Τοποθέτηση της επιφάνειας

- 1 Τοποθετήστε τον μεσαίο ιμάντα μέσα από τη βάση του ατμοσιδερωτή.

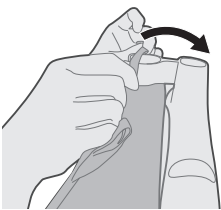

- 2 Ασφαλίστε τους 3 ιμάντες στο άγκιστρο στο πίσω μέρος της κρεμάστρας.

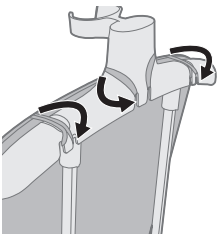

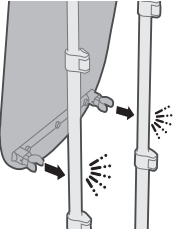

3 Ασφαλίστε την επιφάνεια στην κολώνα μέχρι να ασφαλίσει στη θέση της ("κλικ").

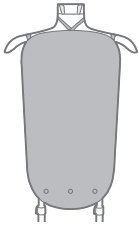

4 Μπορείτε να κρεμάσετε τα ρούχα σας στην κρεμάστρα.



5 Μπορείτε να χρησιμοποιήσετε τη δική σας κρεμάστρα και να την τοποθετήσετε στη βάση του ατμοσιδερωτή.

Τοποθέτηση της βούρτσας

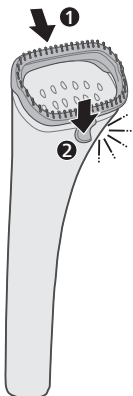

1 Ευθυγραμμίστε τη διαδρομή κατά μήκος του πάνω μέρους της κεφαλής του ατμοσιδερωτή και κουμπώστε το εξάρτημα συγκράτησης στο κάτω μέρος ("κλικ").

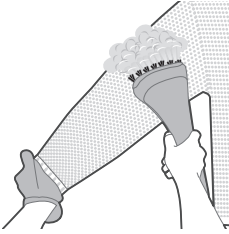

- 2 Μπορείτε να φορέσετε το γάντι και να σιδερώσετε με ατμό τα ρούχα σας χρησιμοποιώντας το εξάρτημα βούρτσας.

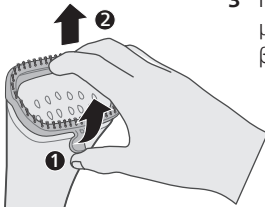

- 3 Πιάστε και τραβήξτε προς τα έξω το εξάρτημα συγκράτησης από το κάτω μέρος της κεφαλής του ατμοσιδερωτή για να αφαιρέσετε το εξάρτημα βούρτσας.

Γέμισμα του δοχείου νερού

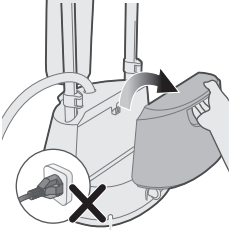

- 1 Μην συνδέετε τη συσκευή στην πρίζα. Αφαιρέστε το δοχείο νερού από τη βάση.

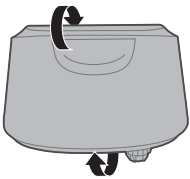

- 2 Αναποδογυρίστε το δοχείο νερού με το καπάκι του δοχείου νερού στραμμένο προς τα πάνω.

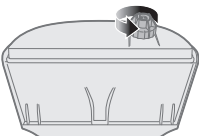

- 3 Ξεβιδώστε το καπάκι του δοχείου νερού αριστερόστροφα για να το αφαιρέσετε.

500 Ελληνικά

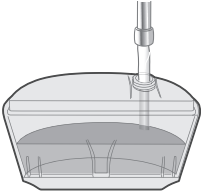

4 Γεμίστε το δοχείο νερού.

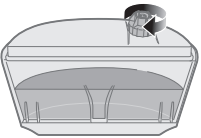

5 Βιδώστε το καπάκι του δοχείου νερού δεξιόστροφα για να το σφίξετε.

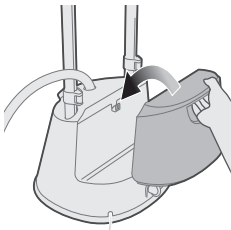

6 Ευθυγραμμίστε με το άγκιστρο για να τοποθετήσετε το δοχείο νερού πίσω στη βάση.

Αλλαγή των ρυθμίσεων ατμού

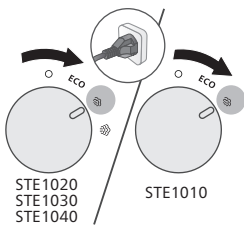

1 Βεβαιωθείτε ότι η συσκευή είναι συνδεδεμένη στην πρίζα. Περιστρέψτε το κουμπί ατμού στην επιθυμητή ρύθμιση ατμού.

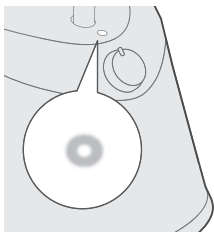

2 Η λυχνία ανάβει σταθερά για να υποδείξει ότι ο ατμοσιδερωτής είναι ενεργοποιημένος.

*STE1010/75: ~2 min

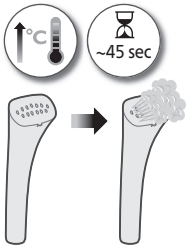

- 3 Περιμένετε περίπου 45 δευτερόλεπτα μέχρι ο ατμοσιδερωτής να ζεσταθεί και να παρέχει ατμό (STE1010/75: περίπου 2 λεπτά).

Συμβουλές σιδερώματος

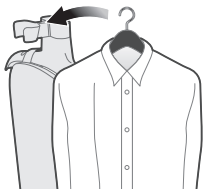

- 1 Μπορείτε να χρησιμοποιήσετε τη δική σας κρεμάστρα και να την τοποθετήσετε στη βάση του ατμοσιδερωτή.

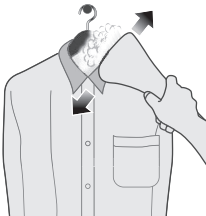

- 2 Μετακινήστε την κεφαλή του ατμοσιδερωτή παράλληλα με τον γιακά.



- 3 Μετακινήστε την κεφαλή του ατμοσιδερωτή οριζόντια με τον γιακά.

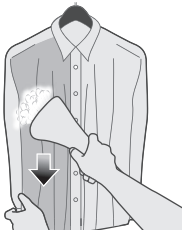

- 4 Τεντώστε το ρούχο. Μετακινήστε την κεφαλή του ατμοσιδερωτή προς τα κάτω στο μπροστινό μέρος του σώματος.



5 Μετακινήστε την κεφαλή του ατμοσιδερωτή προς τα πάνω σε τσέπη.

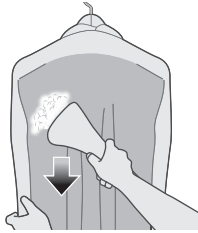

6 Τεντώστε το ρούχο. Μετακινήστε την κεφαλή του ατμοσιδερωτή προς τα κάτω στο πίσω μέρος του σώματος.

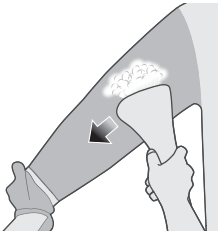

7 Τεντώστε το ρούχο. Μετακινήστε την κεφαλή του ατμοσιδερωτή παράλληλα με το μανίκι.

Καθαρισμός και συντήρηση

Δοχείο συγκέντρωσης αλάτων

Η συσκευή σας έχει σχεδιαστεί με ένα σύστημα συγκέντρωσης αλάτων. Συνιστάται να κάνετε αφαλάτωση μία φορά τον μήνα ή περισσότερο. Αυτό συμβάλλει στη διατήρηση της ισχυρής απόδοσης ατμού και εμποδίζει τη συσσώρευση βρωμιάς και λεκέδων στην πλάκα με την πάροδο του χρόνου.

Συμβουλή: Το σύστημα συγκέντρωσης αλάτων μπορεί να χρησιμοποιηθεί οποιαδήποτε στιγμή. Αν ζείτε σε περιοχή με σκληρό νερό, πρέπει να χρησιμοποιείτε τη λειτουργία ακόμη πιο συχνά.

Εκτέλεση της διαδικασίας καθαρισμού αλάτων

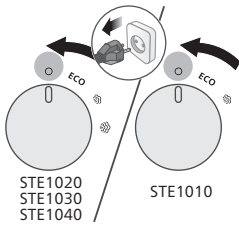

- 1 Βεβαιωθείτε ότι το κουμπί ατμού βρίσκεται στη θέση απενεργοποίησης και ότι η συσκευή δεν είναι συνδεδεμένη στην πρίζα.



- 2 Βεβαιωθείτε ότι το σίδερο έχει κρυσώσει εντελώς (> 1 ώρα).

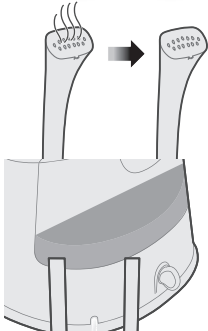

- 3 Τοποθετήστε τον ατμοσιδερωτή κοντά σε ένα σιφόνι.

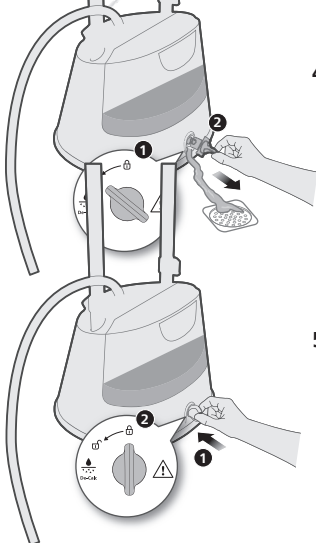

- 4 Γυρίστε το κουμπί αφαλάτωσης στη θέση ξεκλειδώματος και αφαιρέστε το κουμπί αφαλάτωσης. Αφήστε το νερό να αδειάσει.

- 5 Τοποθετήστε και γυρίστε το κουμπί αφαλάτωσης στη θέση ασφάλισης.

Καθαρισμός και αποθήκευση του ατμοσιδερωτή

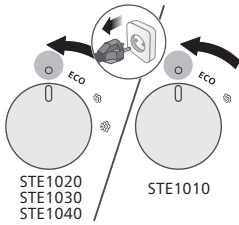

- 1 Βεβαιωθείτε ότι το κουμπί ατμού βρίσκεται στη θέση απενεργοποίησης και ότι η συσκευή δεν είναι συνδεδεμένη στην πρίζα.

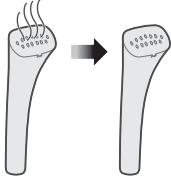

- 2 Βεβαιωθείτε ότι το σίδερο έχει κρυσώσει εντελώς (> 1 ώρα).

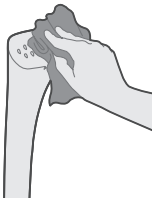

- 3 Σκουπίστε την πλάκα ατμού με ένα νωπό πανί.

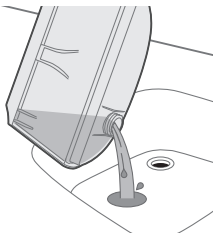

- 4 Αδειάστε εντελώς το δοχείο νερού.

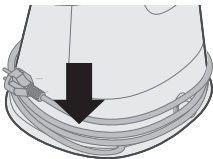

- 5 Τυλίξτε το καλώδιο ρεύματος γύρω από τη βάση.

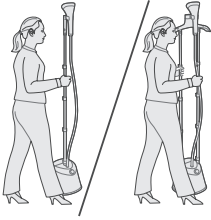

6 Μπορείτε να μεταφέρετε τον ατμοσιδερωτή από την κολώνα.

Αντιμετώπιση προβλημάτων

Σε αυτό το κεφάλαιο συνοψίζονται τα πιο συνήθη προβλήματα που μπορεί να αντιμετωπίσετε με τη συσκευή. Αν δεν μπορέσετε να λύσετε το πρόβλημα με τις παρακάτω πληροφορίες, ανατρέξτε στη λίστα συχνών ερωτήσεων στη διεύθυνση www.philips.com/support ή επικοινωνήστε με το Κέντρο Εξυπηρέτησης Καταναλωτών στη χώρα σας.

Πρόβλημα	Πιθανή αιτία	Λύση
Η συσκευή δεν παράγει ατμό ή παράγει ακανόνιστο ατμό.	Ο ατμοσιδερωτής δεν έχει ζεσταθεί επαρκώς.	Αφήστε τη συσκευή να ζεσταθεί για περίπου 45 δευτερόλεπτα (STE1010/75: περίπου 2 λεπτά).
	Ο ατμός έχει συμπυκνωθεί στον εύκαμπτο σωλήνα.	Σηκώστε την κεφαλή του ατμοσιδερωτή για να ισιώσετε κατακόρυφα τον εύκαμπτο σωλήνα. Με αυτόν τον τρόπο, τυχόν συμπύκνωση ρέει προς τα πίσω.
	Η στάθμη νερού είναι χαμηλή ή το δοχείο δεν έχει τοποθετηθεί σωστά.	Ξαναγεμίστε το δοχείο νερού και τοποθετήστε το σωστά.
	Υπερβολική συσσώρευση αλάτων στη συσκευή.	Εκτελέστε τη διαδικασία αφαλάτωσης. Ανατρέξτε στην ενότητα για τον καθαρισμό αλάτων.
Από την κεφαλή του ατμοσιδερωτή βγαίνουν σταγόνες νερού ή η συσκευή παράγει έναν τραχύ ήχο.	Έχετε αφήσει την κεφαλή του ατμοσιδερωτή ή/και τον εύκαμπτο σωλήνα παροχής ατμού σε οριζόντια θέση για μεγάλο χρονικό διάστημα.	Σηκώστε την κεφαλή του ατμοσιδερωτή για να ισιώσετε κατακόρυφα τον εύκαμπτο σωλήνα. Με αυτόν τον τρόπο, τυχόν συμπύκνωση ρέει προς τα πίσω.

Όταν ο εύκαμπτος σωλήνας σχηματίζει ένα U, η συμπύκνωση στο εσωτερικό του εύκαμπτου σωλήνα δεν μπορεί να επιστρέψει στο δοχείο νερού.

Σηκώστε την κεφαλή του ατμοσιδερωτή για να ισιώσετε κατακόρυφα τον εύκαμπτο σωλήνα. Με αυτόν τον τρόπο, τυχόν συμπύκνωση ρέει προς τα πίσω.

Όταν ζεσταίνεται η συσκευή, από την κεφαλή του ατμοσιδερωτή βγαίνει υπερβολική ποσότητα νερού.

Το νερό στη συσκευή είναι βρώμικο ή έχει μείνει στο εσωτερικό της συσκευής για μεγάλο χρονικό διάστημα.

Εκτελέστε τη διαδικασία αφαλάτωσης. Ανατρέξτε στην ενότητα για τον καθαρισμό αλάτων.

Τρέχει νερό από τη βάση του ατμοσιδερωτή.

Δεν έχετε κλείσει καλά το καπάκι του δοχείου νερού ή το κουμπί αφαλάτωσης. Το δοχείο νερού δεν έχει τοποθετηθεί σωστά.

Κλείστε καλά το καπάκι του δοχείου νερού ή το κουμπί αφαλάτωσης. Τοποθετήστε σωστά το δοχείο.

Въведение

Поздравления за покупката и добре дошли във Philips! За да се възползвате изцяло от предлаганата от Philips поддръжка, регистрирайте продукта си на www.philips.com/welcome. Прочетете това ръководство за потребителя, листовката с важна информация и ръководство за бърз старт внимателно, преди да използвате уреда. Запазете ги за бъдеща справка.

Общ преглед на продукта

STE1020, STE1030, STE1040

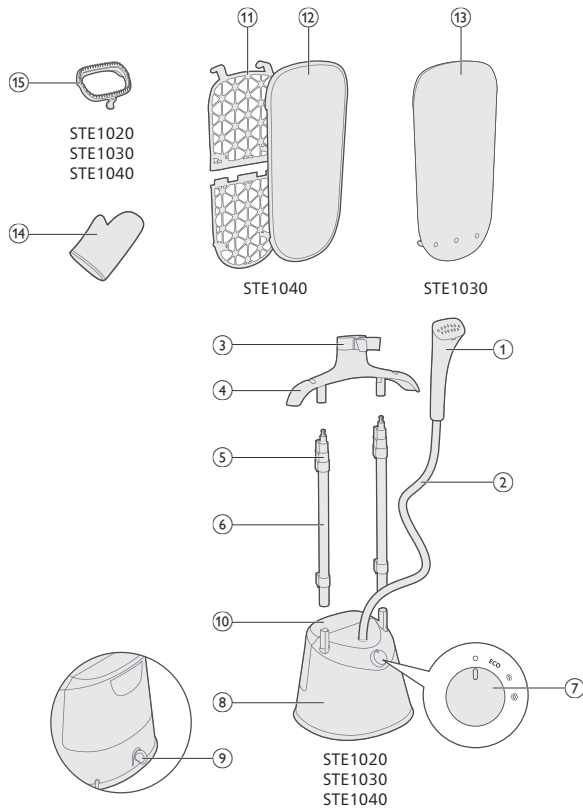

STE1010

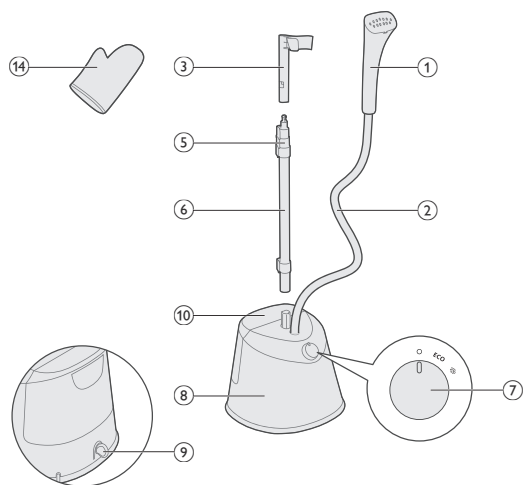

- 1 Глава на уреда за пара
- 2 Маркуч за подаване на пара
- 3 Постапка за уреда за пара
- 4 Закачалка (STE1020, STE1030, STE1040)
- 5 Скоба за заключване на прът
- 6 Прът
- 7 Парен регулатор
- 8 База
- 9 Бутон за премахване на накип
- 10 Воден резервоар
- 11 Дъска (STE1040)
- 12 Покритие (STE1040)
- 13 Подложка (STE1030)
- 14 Ръкавица
- 15 Четка (STE1020, STE1030, STE1040)

Подготовка за употреба

Тип вода за използване

Уредът е подходящ за използване с чешмяна вода. Ако обаче живеете в зона с твърда вода, препоръчваме да смесите равно количество чешмяна вода с дестилирана или деминерализирана вода. Това ще предотврати бързото натрупване на накип и ще удължи живота на уреда.

Не добавяйте парфюм, вода от сушилна машина, оцет, нишесте, препарати за отстраняване на котлен камък, помощни препарати за гладене, химически декалцирана вода или други химикали, тъй като те могат да причинят изхвърляне на вода, кафяво оцветяване или повреда на вашия уред.

Предупреждения

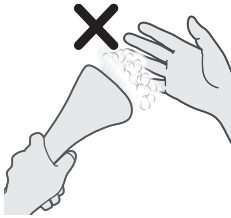

1 Не поставяйте никака част от кожата в пряк контакт с парата.



2 Не насочвайте плочата за пара към други хора.

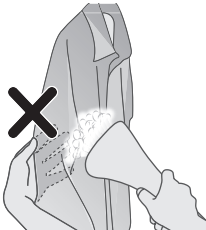

3 Не дръжте дрехата по начин, при който ръката ви да е в пряк контакт с парата.

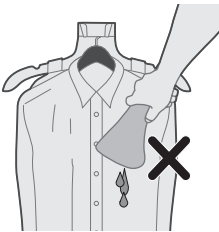

4 Не използвайте главата на уреда за пара надолу.

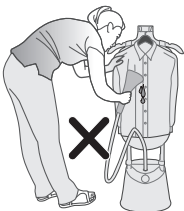

5 Не огъвайте маркуча, за да обработите дрехата с пара.

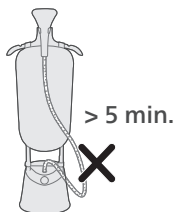

- 6 Не оставяйте стоящия уред за гладене с пара без надзор за повече от 5 минути.

Сглобяване на уреда

STE1010

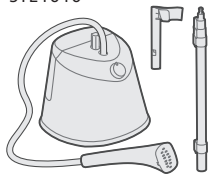

- 1 Обърнете внимание на наличните части за закупения от вас уред.

STE1020, STE1030
STE1040



STE1010

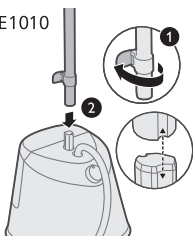

- 2 Отключете долните скоби за заключване на пръта и поставете пръта(ите) върху основата. Уверете се, че профилите на пръта(ите) и накрайниците за прътите на основата са подравнени.

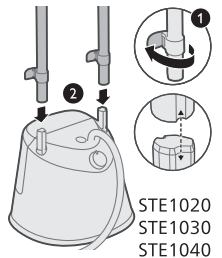

STE1020
STE1030
STE1040

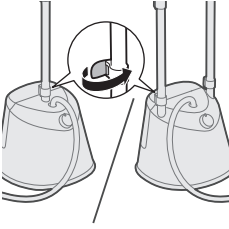

3 Заклучете долните скоби за заключване на прътите.

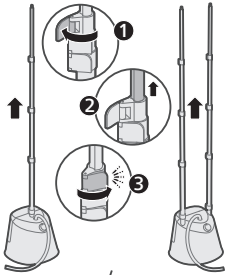

4 Отключете останалите заключващи скоби на прътите, издърпайте напълно пръта(ите) нагоре и го(ги) заклучете.

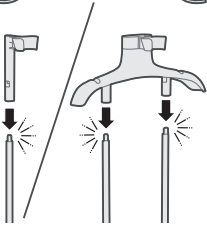

5 Поставете поставката за уреда за пара върху пръта(ите), докато се заклучи на място (с щракване).

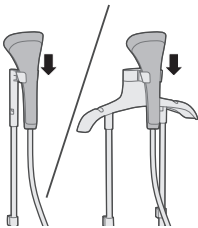

6 Поставете главата на уреда за пара върху поставката за уреда за пара.

Сглобяване на дъската

1 Обърнете внимание на наличните части за закупения от вас уред.

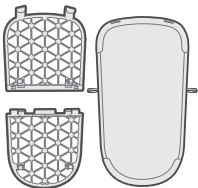

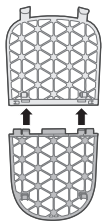

2 Подравнете и поставете щипките на дъската, докато се застопорят на място (с щракване).

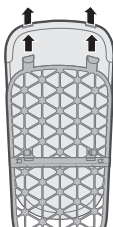

3 Подравнете и поставете покритието на дъската през куките на дъската.

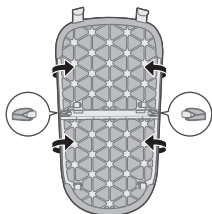

4 Закачете лентите на покритието на дъската за куките в задната част на дъската

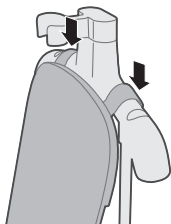

5 Поставете дъската върху закачалката.

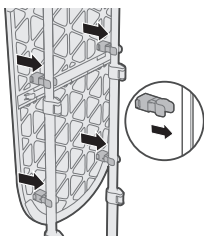

6 Закрепете дъската към прътите, докато се застопори на място (с щракване).

7 Можете да закачите дрехите си на закачалката.

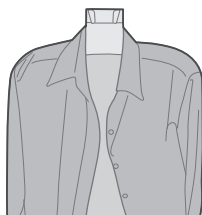
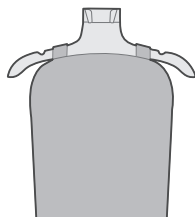

8 Можете да използвате своя собствена закачалка и да я поставите на поставката за уреда за пара.

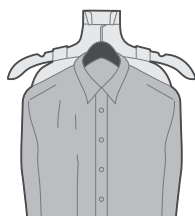

Сглобяване на подложката

1 Вкарайте средната лента през поставката за уреда за пара.

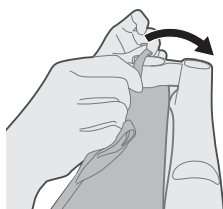

2 Закрепете 3-те ленти на куката в задната част на закачалката.

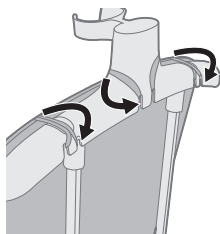

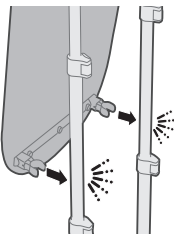

3 Закрепете подложката към прътите, докато се застопори на място (с щракване).

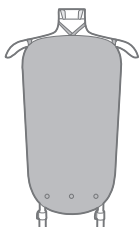

4 Можете да закачите дрехите си на закачалката.



5 Можете да използвате своя собствена закачалка и да я поставите на поставката за уреда за пара.

Поставяне на четката

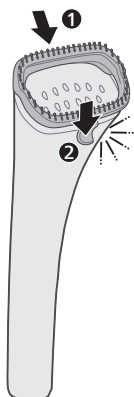

1 Подравнете прореза по протежение на горната част на главата на уреда за пара и щракнете езичето в долната част (с щракване).

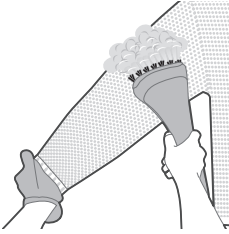

- 2 Можете да носите ръкавицата и да гладите дрехите си с пара с помощта на четката.

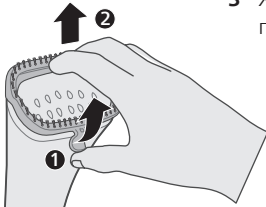

- 3 Хванете и издърпайте езичето от долната част на главата на уреда за пара, за да извадите четката.

Пълнене на водния резервоар

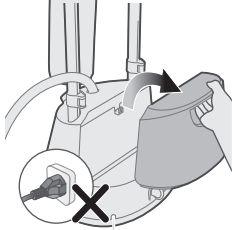

- 1 Не включвайте щепсела на уреда в контакта. Свалете водния резервоар от основата.

- 2 Обърнете водния резервоар с капачката нагоре.

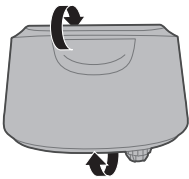

- 3 Отвийте капачката на водния резервоар по посока, обратна на часовниковата стрелка, за да я свалите.

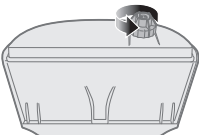

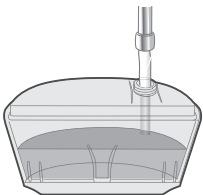

4 Напълнете водния резервоар.

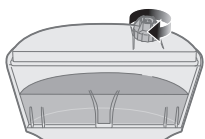

5 Завийте капачката на водния резервоар по посока на часовниковата стрелка, за да я затегнете.

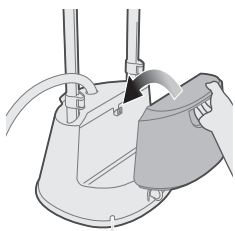

6 Подравнете куката, за да поставите водния резервоар обратно на основата.

Промяна на настройките за пара

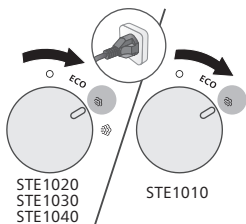

1 Уверете се, че уредът е включен към електрическата мрежа. Завъртете парния регулатор до желаната настройка за пара.

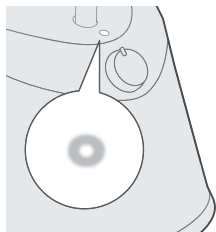

2 Светлината ще светне постоянно, за да покаже, че стоящият уред за гладене с пара е включен.

*STE1010/75: ~2 min

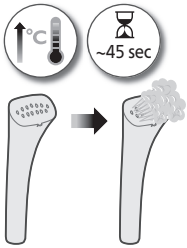

- 3 Изчакайте около 45 секунди стоящият уред за гладене с пара да загрее и да започне да отделя пара (STE1010/75: около 2 минути).

Съвети за гладене

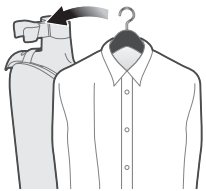

- 1 Можете да използвате своя собствена закачалка и да я поставите на поставката за уреда за пара.

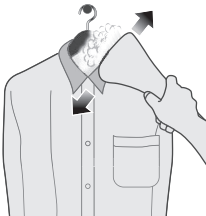

- 2 Преместете главата на уреда за пара успоредно на яката.



- 3 Преместете главата на уреда за пара хоризонтално на платката.

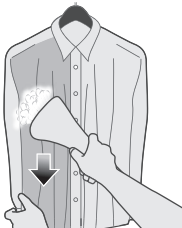

- 4 Изпънете дрехата. Преместете главата на уреда за пара надолу към предната част.



5 Преместете главата на уреда за пара нагоре по джоба.



6 Изпънете дрехата. Преместете главата на уреда за пара надолу към задната част.

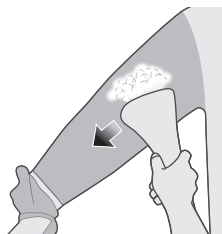

7 Изпънете дрехата. Преместете главата на уреда за пара успоредно на ръкава.

Почистване и поддръжка

Събиране на накип

Вашият уред е проектиран със система за събиране на накип. Препоръчително е да премахвате накипа веднъж в месеца или по-често. Това спомага за поддържане на силно пароотдаване и предпазва от замърсявания и петна, появяващи се от гладещата повърхност с течение на времето.

Съвет: Системата за премахване на накип може да се използва по всяко време. В случай че живеете в област с твърда вода, използвайте функцията по-често.

Извършване на процеса по почистване на накип

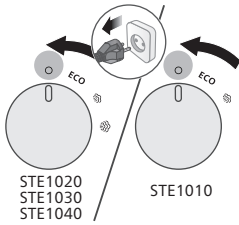

- 1 Уверете се, че парният регулатор е в положение "ИЗКЛ." и уредът е изключен от електрическата мрежа.



- 2 Уверете се, че ютията е изстинала напълно (> 1 час).

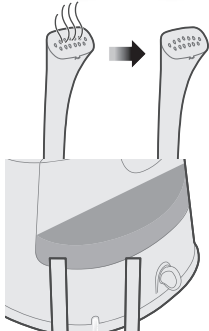

- 3 Поставете уреда за пара близо до отходен канал.

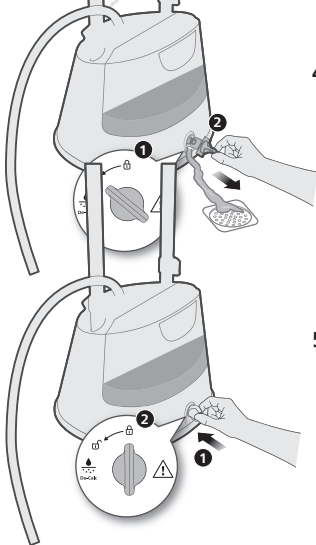

- 4 Завъртете бутона за премахване на накип в отключено положение и извадете бутона за премахване на накип. Оставете водата да се изтече.

- 5 Вкарайте и завъртете бутона за премахване на накип в заключено положение.

Почистване и съхраняване на стоящия уред за гладене с пара

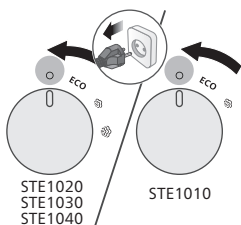

- 1 Уверете се, че парният регулатор е в положение "ИЗКЛ." и уредът е изключен от електрическата мрежа.

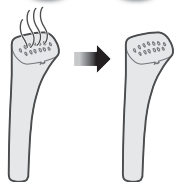

- 2 Уверете се, че ютията е изстинала напълно (> 1 час).

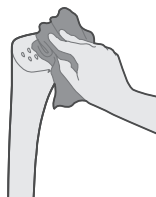

- 3 Избършете изхода за пара с влажна кърпа.



- 4 Източете водния резервоар напълно.

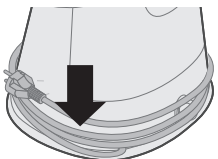

- 5 Навийте захранващия кабел около основата.

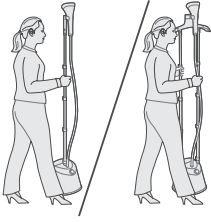

6 Можете да пренасяте стоящия уред за гладене с пара за пръта.

Отстраняване на неизправности

В тази глава са обобщени най-често срещаните проблеми, на които можете да се натъкнете при ползване на уреда. Ако не можете да разрешите проблема с помощта на информацията по-долу, посетете www.philips.com/support за списък с често задавани въпроси или се свържете с центъра за обслужване на потребители във вашата държава.

Проблем	Възможна причина	Решение
Уредът не изпуска пара или я изпуска нередовно.	Устройството не се е нагрело достатъчно.	Оставете уреда да се загрее за около 45 секунди (STE1010/75: около 2 минути).
	В маркуча има кондензирана пара.	Повдигнете главата на уреда за пара, за да изправите маркуча вертикално. Това позволява на конденза да изтече обратно.
	Ниско ниво на водата в резервоара или резервоарът не е поставен правилно.	Напълнете водния резервоар и го поставете правилно.
	В уреда има твърде много натрупан накип.	Извършете процеса за премахване на накип. Вижте раздела "Почистване на накип".
От главата за пара изтичат капки вода или уредът издава клокощещ звук.	Оставили сте главата за пара и/или маркуча за подаване на пара в хоризонтална позиция продължително време.	Повдигнете главата на уреда за пара, за да изправите маркуча вертикално. Това позволява на конденза да изтече обратно.
	Когато маркучът образува формата U, кондензът в него не може да изтича обратно във водния резервоар.	Повдигнете главата на уреда за пара, за да изправите маркуча вертикално. Това позволява на конденза да изтече обратно.

522 Български

От главата за пара изтича прекомерно количество вода, докато уредът загрява.

Водата в уреда е замърсена или е оставена в уреда за продължително време.

Извършете процеса за премахване на накип. Вижте раздела "Почистване на накип".

От основата на уреда за пара изтича вода.

Не сте затворили добре капачето на водния резервоар или бутона за премахване на накип. Водният резервоар не е поставен правилно.

Затворете добре капачето на водния резервоар или бутона за премахване на накип. Поставете резервоара, както трябва.

Киришүү

Сатып алганыңыз үчүн куттуктайбыз жана Philips'ке кош келиңиз! Philips сунуштаган колдоону толук пайдалануу үчүн өнүмүңүздү www.philips.com/welcome баракчасынан каттоодон өткөрүңүз. Шайманды колдонуудан мурун, колдонуучунун нускамасын, маанилүү маалымат китепчесин жана тез баштоо көрсөтмөсүн кунт коюп окуп чыгыңыз. Аларды келечекте колдонуу үчүн сактап коюңуз.

Өнүмдүн кыскача сүрөттөлүшү

STE1020, STE1030, STE1040

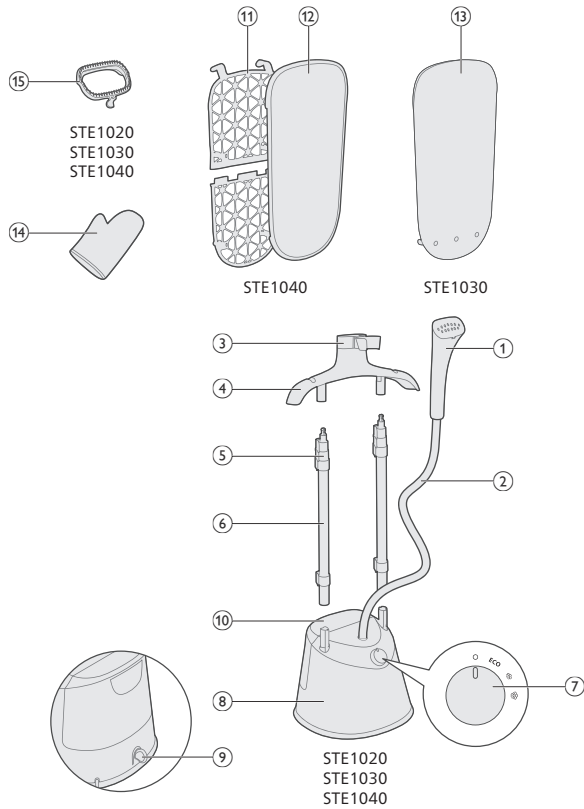

STE1010

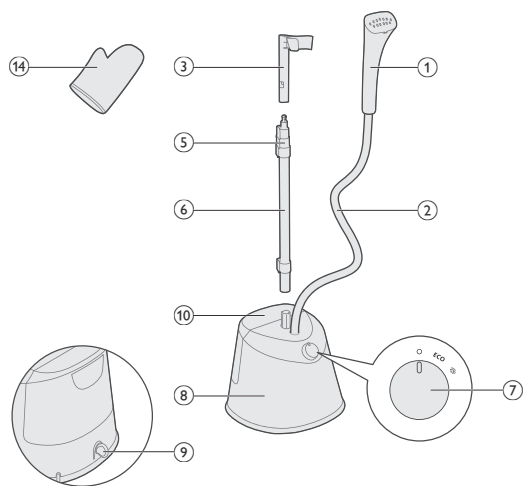

- 1 Буулагычтын башы
- 2 Буу жеткирүүчү шланг
- 3 Буулагычты кармагыч
- 4 Илгич (STE1020, STE1030, STE1040)
- 5 Таякчаны бекитүүчү кыпчытма
- 6 Таякча
- 7 Бууну жөнгө салуу бурагычы
- 8 Шаймандын түбү
- 9 Кебээрдөн тазалоо бурагычы
- 10 Суу челеги
- 11 Такта (STE1040)
- 12 Капкак (STE1040)
- 13 Төшөлмө (STE1030)
- 14 Мээлей
- 15 Щётка (STE1020, STE1030, STE1040)

Колдонууга даярдоо

Колдонула турган суунун түрү

Шайманды крандагы суу менен колдонууга болот. Ошентсе да, эгер катуу суу аккан аймакта жашасаңыз, кран суусу менен тузсуздандырылган же деминералдаштырылган сууну бирдей өлчөмдө аралаштырууну сунуштайбыз. Бул таштын уюп калышынан сактап, шаймандын иштөө мөөнөтүн узартат.

Атыр, кургаткычтан сыгылган суу, уксус, крахмал, кебээр кетируучү каражат, үтүктөө каражаттары, химиялык жол менен тазаланган суу же башка химикаттарды колдонбоңуз.

Анткени алар суунун тамчылашына, күрөң тактын калышына же шаймандын бузулушуна алып келиши мүмкүн.

Эскертүүлөр

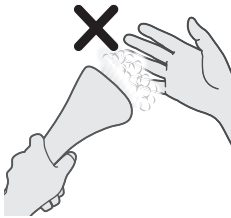

1 Териңиздин бир да бөлүгүн бууга түздөн-түз тийгизбеңиз.



2 Буу чыгуучу жагын башка адамдарга каратпаңыз.

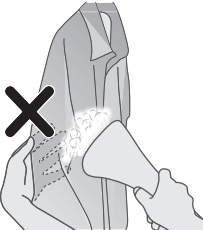

3 Кийимиңизди буу түздөн-түз тийип калгыдай кылып кармабаңыз.

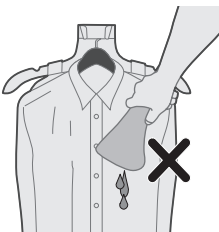

4 Буулагычтын башын ылдый каратып колдонбонуз.

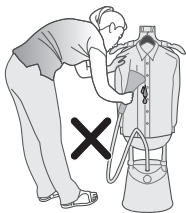

5 Кийимдерди буулоо үчүн шлангды бүктөбөңүз.

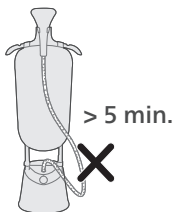

6 Вертикалдуу буулагычты 5 мүнөттөн ашык кароосуз калтырбаңыз.

Шайманды орнотуу

STE1010

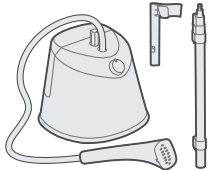

1 Сатып алган шаймандарыңыз менен кошо берилген бөлүктөрүнө көңүл буруңуз.

STE1020, STE1030

STE1040

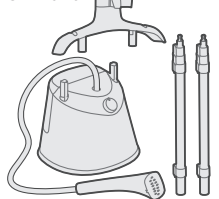

2 Тирөөчтүн төмөнкү бекиткичтерин бөгөттөн чыгарып, тирөөчтү(-төрдү) шайманга отургузуңуз. Тирөөчтүн(-төрдүн) профилдери менен негизинин тирөөч илгеги(-тери) тегиз келгенин текшерипиз.

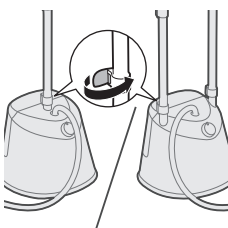
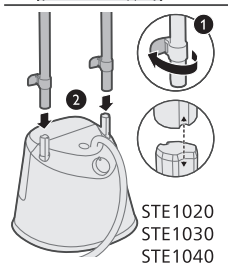
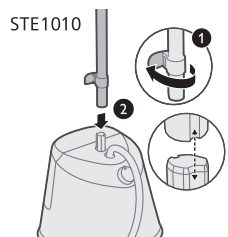

3 Тирөөчтүн төмөнкү бекиткичин(-терин) бөгөттөңүз.

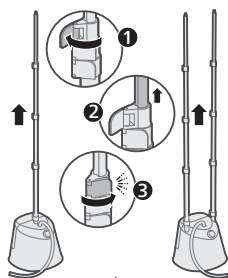

4 Тирөөчтүн калган бекиткичтерин бөгөттөн чыгарып, тирөөчтү(-төрдү) толугу менен өйдө карай узартып алып, аны бекитиңиз.

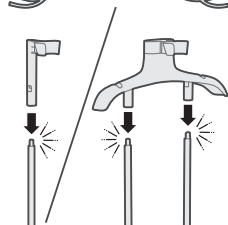

5 Буулагыч кармагычын тирөөчкө(-төргө) ал бекигенче (“чыкылдагыча”) кыстарыңыз.

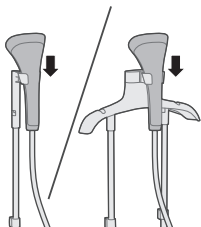

6 Буулагычтын башын буулагыч кармагычына жайгаштырыңыз.

Тактаны орнотуу

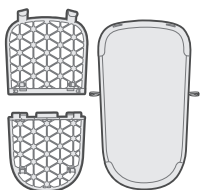

1 Сатып алган шаймандарыңыз менен кошо берилген бөлүктөрүнө көңүл буруңуз.

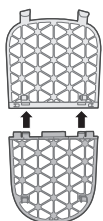

2 Тактаны бекиткичтерине теңдеп, ордуна келгиче (“чыкылдагыча”) салыңыз.

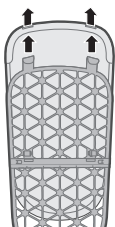

3 Тактанын капкагын тактанын илмектерине теңдеп салыңыз.

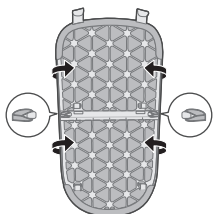

4 Тактанын капкагындагы боолорду тактанын артындагы илмектерге бекитиңиз

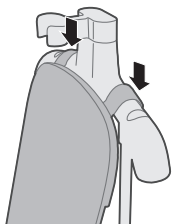

5 Тактаны илгичке жайгаштырыңыз.

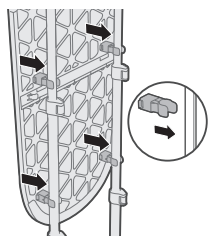

6 Тактаны тирөөчөтөргө ордуна келгиче (“чыкылдагыча”) салыңыз.

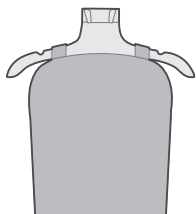

7 Кийимдериңизди илгичке илсеңиз болот.

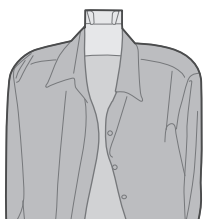

8 Өзүңүздүн илгичиңизди колдонуп, аны буулагыч кармагычына жайгаштырсаңыз болот.

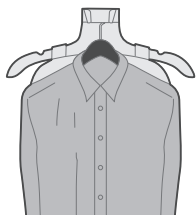

Төшөлмөнү орнотуу

1 Ортоңку боону буулагыч кармагычына кийгизиңиз.

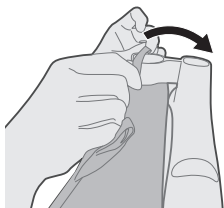

2 3 боону илгичтин артындагы илмекке бекитиңиз.

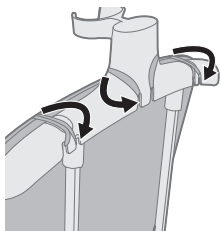

3 Төшөлмөнү тирөөчкө ордуна келгиче ("чыкылдагыча") салыңыз.

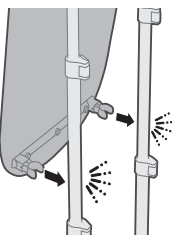

4 Кийимдериңизди илгичке илсеңиз болот.

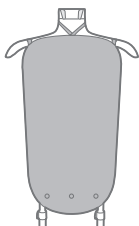



- 5 Өзүңүздүн илгичиңизди колдонуп, аны буулагыч кармагычына жайгаштырсаңыз болот.

Щётканы орнотуу

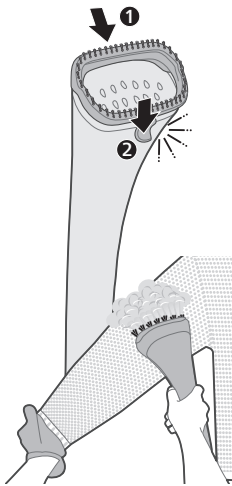

- 1 Буулагычтын башынын үстүнө изи боюнча теңдеп, төмөн жагындагы бекиткичти бекитиңиз (“чыкылдатыңыз”).

- 2 Колкап кийип, щётка тиркемесин колдонуп, кийимиңизди бууласаңыз болот.

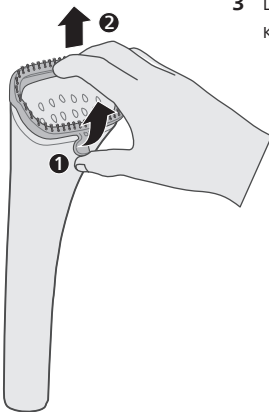

- 3 Щётка тиркемесин алып салуу үчүн буулагычтын башынын астындагы карматкычы кармап, сууруп алыңыз.

Суу челегин толтуруу

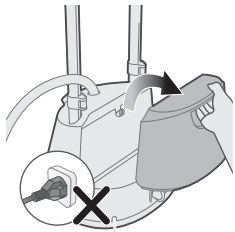

1 Шайманды электр тармагына туташтырбаңыз. Суу челегин шаймандан чыгарыңыз.

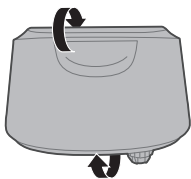

2 Суу челегинин капкагы өйдө карагандай кылып, суу челегин оодарыңыз.

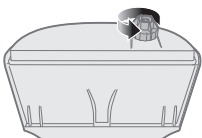

3 Суу челегинин капкагын алып салуу үчүн капкакты саат жебесине каршы бураңыз.

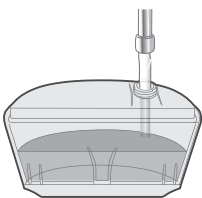

4 Суу челегин толтуруңуз.

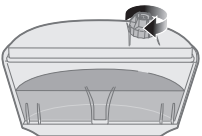

5 Суу челегинин капкагын бекитүү үчүн аны сааттын жебеси боюнча бураңыз.

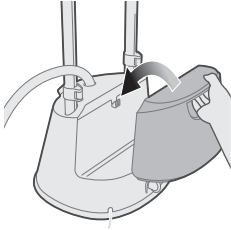

6 Суу челегин кайра шайманга орнотуу үчүн илгичке тегиздеңиз.

Буулагычтын жөндөөлөрүн өзгөртүү

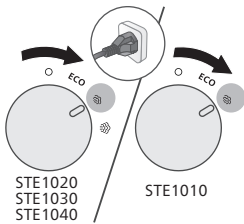

1 Шаймандын электр тармагына туташкандыгын текшерипиз. Бууну жөнгө салуу бурагычын керектүү буу чыгаруу жөндөөсүнө каратып бураңыз.

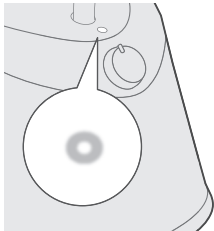

2 Индикатор туруктуу күйүп, буулагыч күйгүзүлгөнүн көрсөтөт.

*STE1010/75: ~2 min

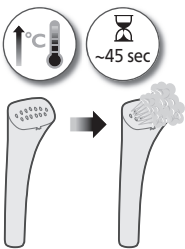

3 Вертикалдуу буулагыч ысып, буу чыкканча 45 секунд күтө туруңуз (STE1010/75: болжол менен 2 мүнөт).

Үтүктөө үчүн кеңештер

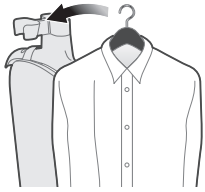

1 Өзүңүздүн илгичиңизди колдонуп, аны буулагыч кармагычына жайгаштырсаңыз болот.

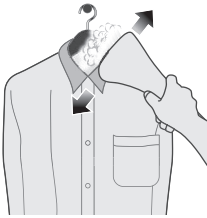

2 Буулагычтын башын жакасына параллелдүү багытта жылдырыңыз.



3 Буулагычтын башын кийимдин кокеткасы боюнча туурасынан жылдырыңыз.

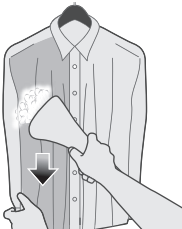

4 Кийимди тартыңыз. Буулагычтын башын кийимдин алдыңкы жагы боюнча ылдый карай жылдырыңыз.



5 Буулагычтын башын чөнтөгүнөн өйдөнү карай жылдырыңыз.

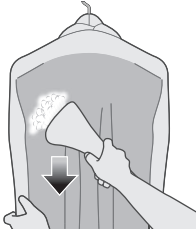

6 Кийимди тартыңыз. Буулагычтын башын кийимдин арткы жагы боюнча ылдый карай жылдырыңыз.

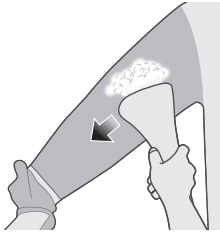

7 Кийимди тартыңыз. Буулагычтын башын жең менен параллелдүү багытта жылдырыңыз.

Тазалоо жана тейлөө

Кебээрди чогулткуч

Шайманыңыз “Кебээрди чогулткуч” системасы менен жабдылган. Айына бир же андан көп жолу кебээрден тазалоо сунушталат. Бул буунун жакшы чыгышын камсыз кылып, убакыттын өтүшү менен үтүктүн таманынан кир нерселер жана тактардын чыгышына жол бербейт.

Кеңеш: “Кебээрди чогулткуч” системасын каалаган учурда колдоно аласыз. Эгерде сиз суунун катуулугу жогору аймакта жашасаңыз, бул функцияны тез-тезден колдонунуз.

Кебээрден тазалоо процессин аткаруу

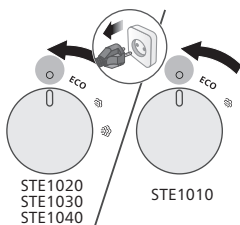

1 Бууну жөнгө салуу бурагычы OFF абалында экенин жана шайман розеткадан ажыратылганын текшериңиз.

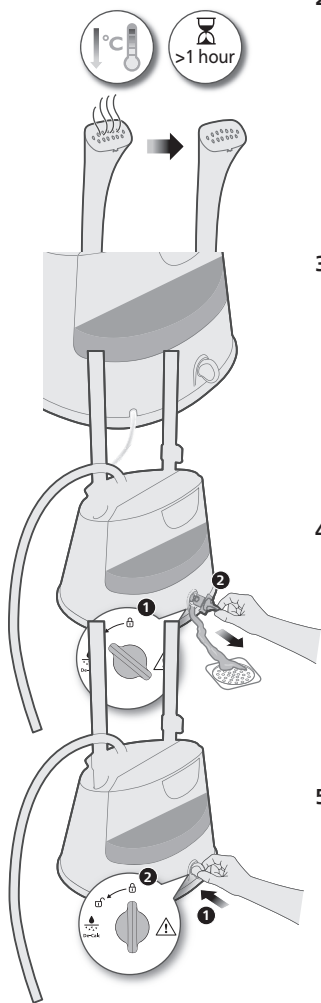

2 Үтүк толугу менен муздаганын текшериңиз (> 1 саат).

3 Буулагычтагы суу агып кеткидей жайгаштырыңыз.

4 Кебээрдөн тазалоо бурагычын бөгөттөн чыгаруу абалына келтирип, Кебээрдөн тазалоо бурагычын алып салыңыз. Сууну агызып салыңыз.

5 Кебээрдөн тазалоо бурагычын кулпулоо абалына келтириңиз.

Вертикалдуу буулагычты тазалоо жана сактоо

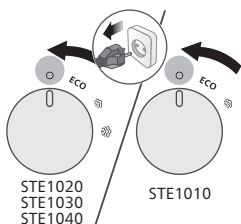

1 Бууну жөнгө салуу бурагычы OFF абалында экенин жана шайман розеткадан ажыратылганын текшериңиз.

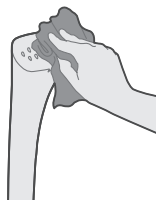
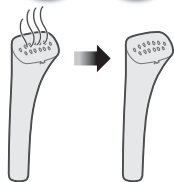

2 Үтүк толугу менен муздаганын текшериңиз (> 1 саат).

3 Буу болгон жерди нымдуу чүпүрөк менен сүртүңүз.



4 Суу челегин толугу менен бошотуңуз.

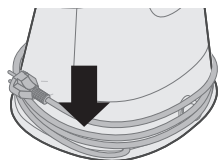

5 Электр шнурун шайманды тегерете ороңуз.

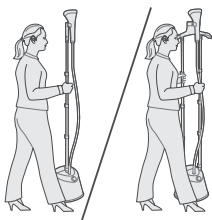

6 Вертикалдуу буулагычты тирөөчүнөн көтөрсөңүз болот.

Көйгөйлөрдү жоюу

Бул бөлүм сиз шайманды иштетүүдө кез келген жалпы көйгөйлөрдү камтыйт. Эгер маселени төмөндөгү маалымат менен чече албасаңыз, www.philips.com/support баракчасынан көп берилүүчү суроолорду караңыз же өз өлкөңүздөгү Кардарларды тейлөө борборуна кайрылыңыз.

Көйгөй	Болжолдуу себеп	Көйгөйдү чечүү
Шайман буу чыгарбай жатат же буунун чыгуусу туруктуу эмес.	Буулагыч жетишерлик деңгээлде ысыган жок.	Шайманды болжол менен 45 секунд ысытып алыңыз (STE1010/75: болжол менен 2 мүнөт).
	Шлангда буу тер болуп калып калган.	Шлангды тигинен түздөө үчүн буулагычтын башын көтөрүңүз. Бул конденсаттын кайра агып чыгышына жол ачат.
	Челекте суунун деңгээли төмөн же челек туура салынган эмес.	Челекке суу толтуруп, аны туура салыңыз.
	Шайманда өтө көп кебээр чогулуп калган.	Кебээрден тазалоо процессин аткарыңыз. “Кебээрден тазалоо” бөлүмүн караңыз.
Буулагычтын башынан суу тамчылап, кээде шаймандан чыкыраган үн чыгып жатат.	Буулагычтын башын жана/же буу жеткирүүчү шлангды көп убакытка туурасынан коюп койгонсуз.	Шлангды тигинен түздөө үчүн буулагычтын башын көтөрүңүз. Бул конденсаттын кайра агып чыгышына жол ачат.
	Шланг U-формасында болуп калганда, шлангдагы конденсат суу челегине кайра агып түшө албайт.	Шлангды тигинен түздөө үчүн буулагычтын башын көтөрүңүз. Бул конденсаттын кайра агып чыгышына жол ачат.
Шайман ысып жатканда буулагычтын башынан ашыкча көлөмдөгү суу тамчылап турат.	Шаймандын ичиндеги суу кир же шаймандын ичинде көп убакыт туруп калган.	Кебээрден тазалоо процессин аткарыңыз. “Кебээрден тазалоо” бөлүмүн караңыз.
Буулагычтын түбүнөн суу агып жатат.	Суу челегинин капкагын же de-calc бурагычын бекем жапкан эмессиз. Суу челеги туура салынган эмес.	Суу челегинин капкагын же de-calc бурагычын бекем жабыңыз. Челекти туура салыңыз.

Вовед

Ви честитаме за купувањето и добре дојдовте во Philips! За да ја искористите целосната поддршка што ја нуди Philips, регистрирајте го вашиот производ на www.philips.com/welcome. Внимателно прочитајте го ова упатство за користење, брошурата со важни информации и водичот за брз почеток пред да го користите апаратот. Зачувајте ги за идни потреби.

Преглед на производот

STE1020, STE1030, STE1040

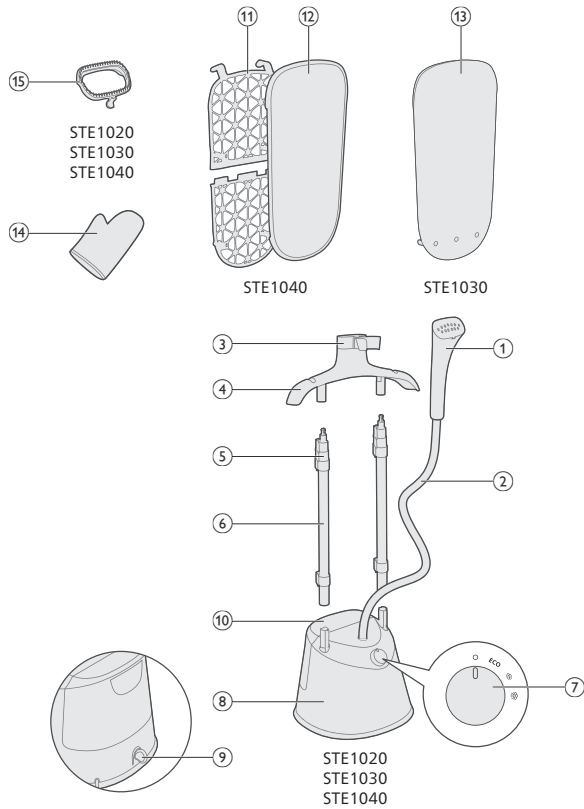

STE1010

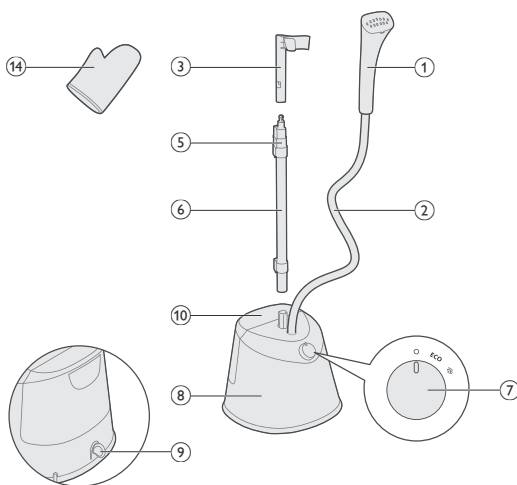

- 1 Глава на апаратот за пареа
- 2 Црево за довод на пареа
- 3 Држач за апарат за пареа
- 4 Закачалка (STE1020, STE1030, STE1040)
- 5 Штипка за блокирање на држачите
- 6 Држач
- 7 Регулатор за пареа
- 8 Основа
- 9 Регулатор за отстранување бигор
- 10 Резервоар за вода
- 11 Штица (STE1040)
- 12 Капак (STE1040)
- 13 Подлога (STE1030)
- 14 Ракавица
- 15 Четка (STE1020, STE1030, STE1040)

Подготовка за употреба

Тип вода што треба да ја користите

Апаратот може да се користи со вода од чешма. Меѓутоа, ако живеете во подрачје со тврда вода, ви препорачуваме да измешате еднаква количина вода од чешма со дестилирана или деминерализирана вода. Ова ќе спречи брзо таложење на бигор и ќе го продолжи работниот век на апаратот.

Не додавајте парфимирана вода, вода од машина за сушење алишта, оцет, штирак, средства за отстранување бигор, адитиви за пеглање, вода што е хемиски исчистена од бигор или други хемикалии, затоа што можат да предизвикаат нагло

исфрлување на вода, појава на кафени дамки или оштетување на апаратот.

Предупредувања

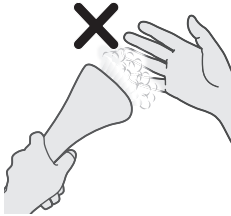

1 Не дозволувајте некој дел од кожата да дојде во директен контакт со пареата.



2 Не насочувајте ја парната плоча кон други луѓе.

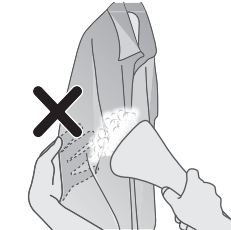

3 Не држете ја облеката на начин на којшто ќе биде во директен контакт со пареата.



4 Не користете ја главата на апаратот за пареа надолу.



5 Не виткајте го цреовото за да примените пареа на парче облека.

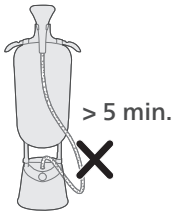

6 Не оставајте го стоечкиот апарат за пареа без надзор повеќе од 5 минути.

Поставување на апаратот

STE1010

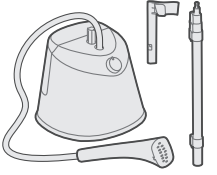

1 Забележете ги достапните делови за купениот апарат.

STE1020, STE1030
STE1040



2 Отклучете ги долните штипки за блокирање на држачите и вметнете ги држачите на основата. Проверете дали профилите на држачите и нитните на основата на држачите се порамнети.

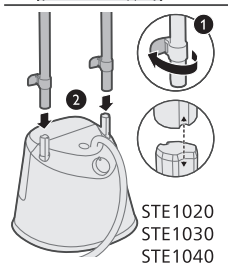
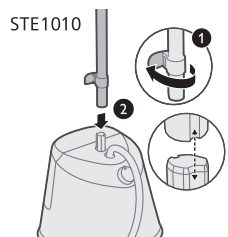

STE1020
STE1030
STE1040

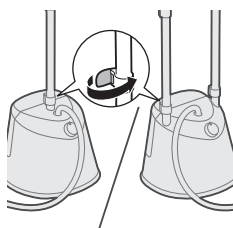

3 Заклучете ги долните штипки за блокирање на држачите.

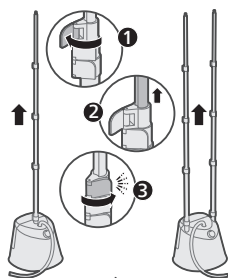

4 Заклучете ги преостанатите штипки за блокирање на држачите, целосно раширете ги држачите нагоре и заклучете ги.

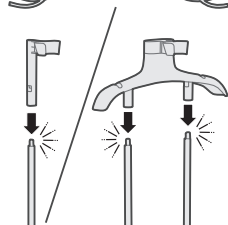

5 Вметнете го држачот за апаратот за пареа сè додека не дојде на своето место (со „кликнување“).

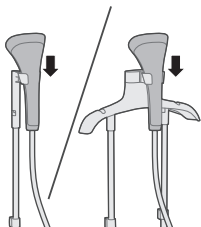

- 6 Ставете ја главата на апаратот за пареа на држачот за апаратот за пареа.

Поставување на штицата

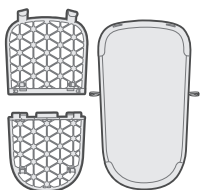

- 1 Забележете ги достапните делови за купениот апарат.

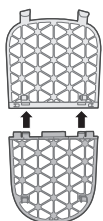

- 2 Порамнете ги и вметнете ги штипките за штицата сè додека не дојдат на свое место (со „кликнување“).

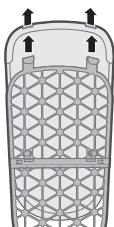

- 3 Порамнете ја и вметнете ја навлаката на штицата преку куките на штицата.

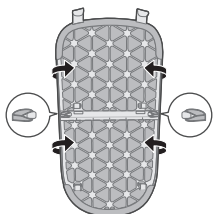

- 4 Закачете ги лентите на навлаката на штицата на куките на задниот дел од штицата

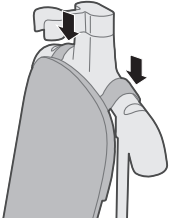

5 Ставете ја штицата на закачалка.

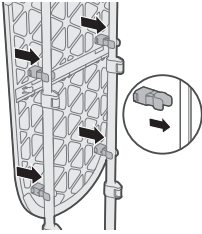

6 Прицврстете ја штицата на држачите сè додека не дојде на своето место (со „кликнување“).

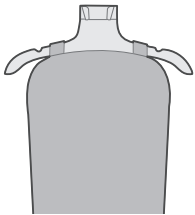

7 Можете да ги закачите алиштата со закачалката.

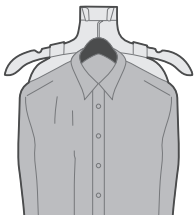
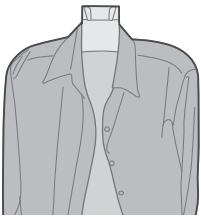

8 Можете да користите своја закачалка што можете да ја поставите на држачот за апаратот за пареа.

Поставување на подлогата

- 1 Вметнете ја средната лента преку држачот за апаратот за пареа.

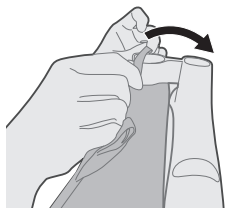

- 2 Прицврстете ги 3-те ленти на куката на задниот дел од закачалката.

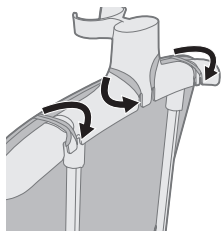

- 3 Прицврстете ја подлогата на држачите сè додека не дојде на своето место (со „кликнување“).

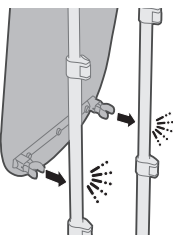

- 4 Можете да ги закачите алиштата со закачалката.

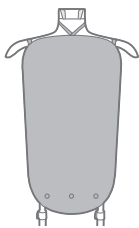



- 5 Можете да користите своја закачалка што можете да ја поставите на држачот за апаратот за пареа.

Вметнување на четката

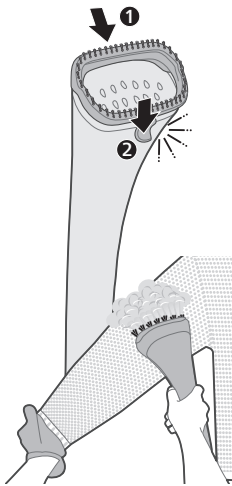

- 1 Порамнете ја шината долж горниот дел на главата на апаратот за пареа и затворете го делот за прицврстување на долниот дел (со „кликнување“).

- 2 Можете да ја носите ракавицата и да применувате пареа на облеката со додатокот со четка.

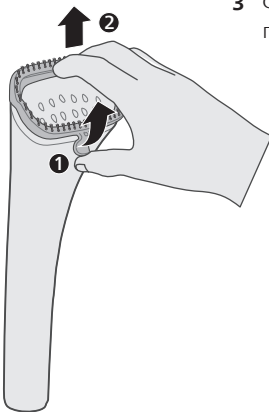

- 3 Фатете го и извлечете го делот за прицврстување од долниот дел на главата на апаратот за пареа за да го извлечете додатокот со четка.

Полнење на резервоарот за вода

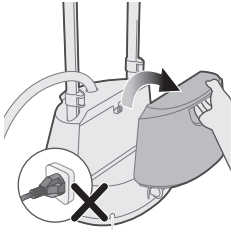

1 Немојте да го приклучувате апаратот. Отстранете го резервоарот за вода од основата.

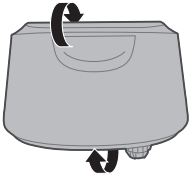

2 Превртете го резервоарот за вода на начин на којшто капачето на резервоарот за вода ќе биде завртено нагоре.

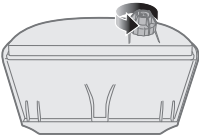

3 Одвртете го капачето на резервоарот за вода во правец спротивен на стрелките на часовникот за да го отстраните.

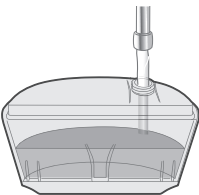

4 Наполнете го резервоарот за вода.

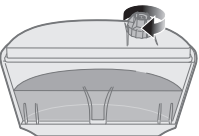

5 Завртете го капачето во правец на стрелките на часовникот за да го затегнете.

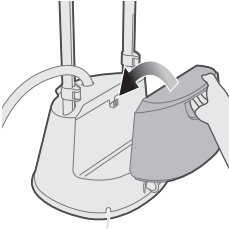

- 6 Порамнете со куката за да го поставите резервоарот за вода назад на основата.

Менување на поставките за пареа

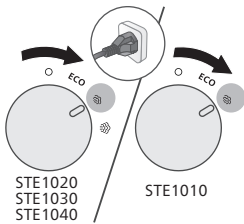

- 1 Проверете дали апаратот е приклучен. Ротирајте го регулаторот за пареа на посакуваната поставка за пареа.

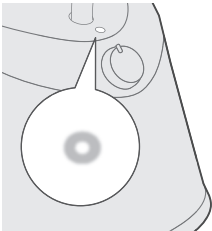

- 2 Светлото ќе свети постојано за да назначи дека самостоечкиот апарат за пареа е ВКЛУЧЕН.

*STE1010/75: ~2 min

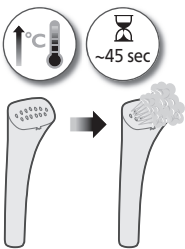

- 3 Почекајте 45 секунди за самостоечкиот апарат за пареа да се загрее и да почне да испушта пареа (STE1010/75: приближно 2 минути).

Совети за пеглање

- 1 Можете да користите своја закачалка што можете да ја поставите на држачот за апаратот за пареа.

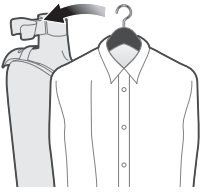

- 2 Движете ја главата на апаратот за пареа во паралелна насока со јаката.

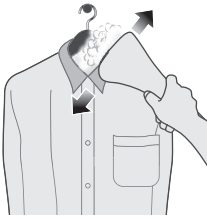

- 3 Движете ја главата на апаратот за пареа во хоризонтална насока со рамениците.



- 4 Истегнете ја облеката. Движете ја главата на апаратот за пареа надолу долж предниот дел на телото.

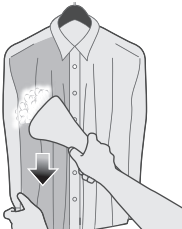

- 5 Движете ја главата на апаратот за пареа нагоре на џеб.



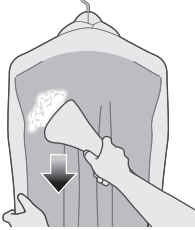

6 Истегнете ја облеката. Движете ја главата на апаратот за пареа надолу долж грбот.

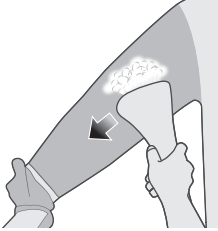

7 Истегнете ја облеката. Движете ја главата на апаратот за пареа во паралелна насока со ракавот.

Чистење и одржување

Собирач на бигор

Вашиот апарат е дизајниран со систем за собирање на бигор. Се препорачува да отстранувате бигор најмалку еднаш месечно. Тоа помага во одржувањето силен млаз на пареа и спречува излегување на нечистотии и дамки од грејната плоча со текот на времето.

Совет: Системот за собирање на бигор може да се користи во кое било време. Ако живеете во подрачје со тврда вода, користете ја функцијата почесто.

Извршување на постапката за чистење бигор

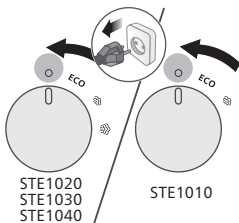

1 Проверете дали регулаторот за пареа е на положба OFF (ИСКЛУЧЕНО) и дека апаратот е исклучен.

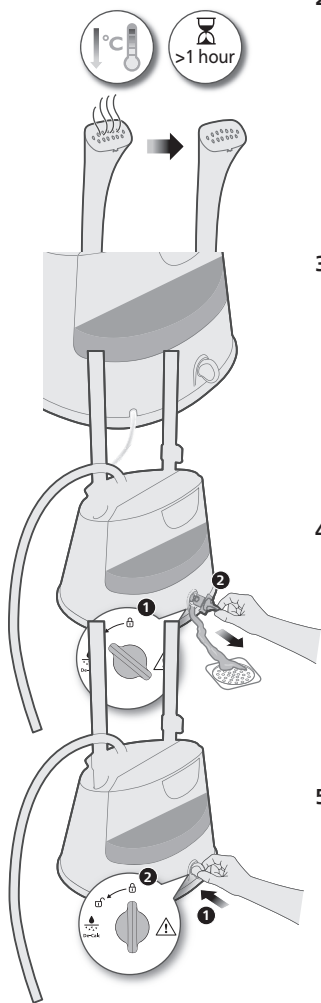

2 Проверете дали пеглата целосно се оладила (> 1 час).

3 Ставете го апаратот за пареа до одвод.

4 Завртете го регулаторот за отстранување бигор на отклучена положба и отстранете го копчето за отстранување бигор. Оставете ја водата да истече.

5 Вметнете го и завртете го регулаторот за отстранување бигор на заклучена положба.

Чистење и складирање на стоечкиот апарат за пареа

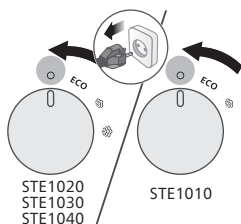

1 Проверете дали регулаторот за пареа е на положба OFF (ИСКЛУЧЕНО) и дека апаратот е исклучен.

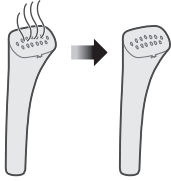

2 Проверете дали пеглата целосно се оладила (> 1 час).

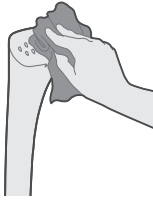

3 Избришете ја површината за пара со влажна крпа.



4 Целосно испразнете го резервоарот за вода.

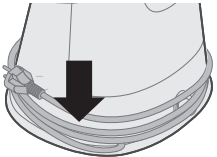

5 Обвиткајте го кабелот за напојување околу основата.

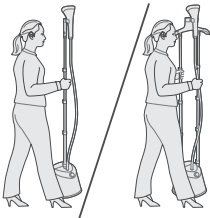

6 Можете да го носите стоечкиот апарат за пара за држачот.

Решавање проблеми

Во ова поглавје се опишани најчестите проблеми со кои може да се соочите при користење на апаратот. Ако не можете да го решите проблемот со помош на информациите наведени подолу, посетете ја веб-страницата www.philips.com/support за да најдете листа на најчести прашања или контактирајте со центарот за корисничка поддршка во вашата земја.

Проблем	Можна причина	Решение
Апаратот не произведува пареа или испушта нерамномерна пареа.	Апаратот за пареа не е доволно загреан.	Почекајте приближно 45 секунди за да се загрее апаратот (STE1010/75: приближно 2 минути).
	Во цревото се кондензирала пареа.	Подигнете ја главата на апаратот за пареа за да го исправите цревото вертикално. Ова овозможува кондензираната течност да се врати назад.
	Ниско ниво на вода во резервоарот или резервоарот не е правилно вметнат.	Дополнете го резервоарот за вода и вметнете го правилно.
	Во апаратот се наталожило премногу бигор.	Извршете ја постапката за чистење бигор. Погледнете во делот Calc-Clean (Отстранување бигор).
Од главата на апаратот за пареа капе вода или апаратот испушта звук на крескање.	Главата на апаратот за пареа и/или цревото за довод на пареа сте ги оставиле во хоризонтална положба долго време.	Подигнете ја главата на апаратот за пареа за да го исправите цревото вертикално. Ова овозможува кондензираната течност да се врати назад.
	Ако цревото се свитка во форма на буквата U, кондензираната течност во него не може да се врати во резервоарот за вода.	Подигнете ја главата на апаратот за пареа за да го исправите цревото вертикално. Ова овозможува кондензираната течност да се врати назад.

Од главата на апаратот за пареа капе прекумерна количина на вода кога апаратот се загрева.

Водата во апаратот е нечиста или предолго стои во апаратот.

Извршете ја постапката за чистење бигор. Погледнете во делот Calc-Clean (Отстранување бигор).

Истекува вода од основата на апаратот за пареа.

Не сте го затвориле цврсто капачето на резервоарот за вода или регулаторот за отстранување бигор. Резервоарот за вода не е правилно вметнат.

Цврсто затворете го капачето на резервоарот за вода или регулаторот за отстранување бигор. Вметнете го резервоарот правилно.

Введение

Поздравляем с покупкой и приветствуем в клубе Philips! Чтобы воспользоваться всеми преимуществами поддержки Philips, зарегистрируйте продукт на сайте www.philips.com/welcome. Перед использованием прибора внимательно ознакомьтесь с данной инструкцией по эксплуатации, важной информацией в буклете и с кратким руководством пользователя. Сохраните их для дальнейшего использования.

Обзор изделия

STE1020, STE1030, STE1040

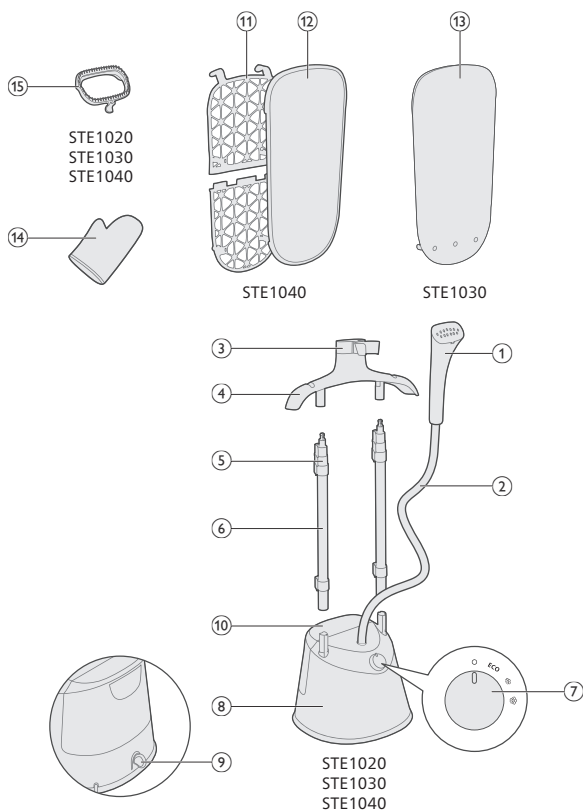

STE1010

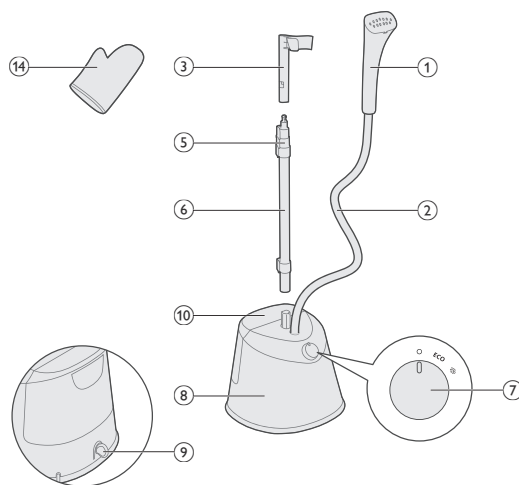

- 1 Сопло отпаривателя
- 2 Шланг подачи пара
- 3 Крепление отпаривателя
- 4 Вешалка (STE1020, STE1030, STE1040)
- 5 Зажим для стойки
- 6 Стойка
- 7 Регулятор подачи пара
- 8 Основание
- 9 Клапан очистки от накипи
- 10 Резервуар для воды
- 11 Доска (STE1040)
- 12 Чехол (STE1040)
- 13 Коврик (STE1030)
- 14 Рукавица
- 15 Щетка (STE1020, STE1030, STE1040)

Подготовка к использованию прибора

Тип используемой воды

Прибор пригоден для использования с водопроводной водой. Однако если вы живете в регионе с жесткой водой, рекомендуется смешивать водопроводную воду с деминерализованной водой в равных пропорциях. Это поможет избежать быстрого образования накипи и продлит срок службы прибора.

Во избежание появления протечек, коричневых пятен или повреждения прибора не используйте духи, воду из сушильной машины, уксус, крахмал, средства очистки от накипи, добавки

для глажения, химические вещества и воду, подвергшуюся очистке от накипи с использованием химических средств.

Предупреждения

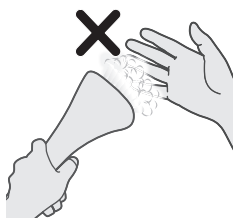

1 Избегайте прямого контакта пара с кожей.



2 Не направляйте насадку отпаривателя на других людей.



3 Располагайте одежду таким образом, чтобы избежать прямого контакта с паром.

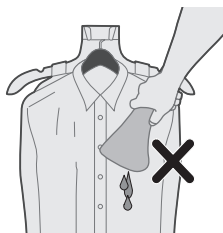

4 Не направляйте головку отпаривателя вниз при отпаривании.

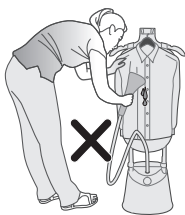

5 Не сгибайте шланг при отпаривании одежды.

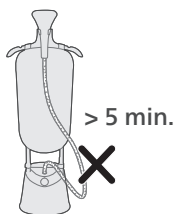

6 Не допускайте непрерывной работы вертикального отпаривателя в течение 5 минут или более.

Сборка прибора

STE1010

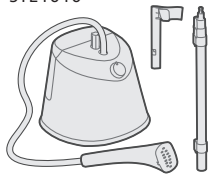

1 Посмотрите, из каких компонентов состоит приобретенный вами прибор.

STE1020, STE1030

STE1040



2 Разблокируйте нижние зажимы-фиксаторы на штангах и установите штанги в основание. Убедитесь, что штанги вошли в пазы на основании и установились ровно.

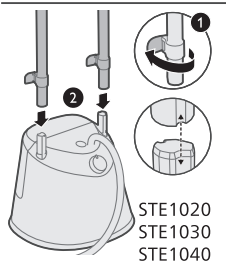
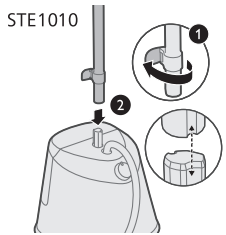

STE1020
STE1030
STE1040

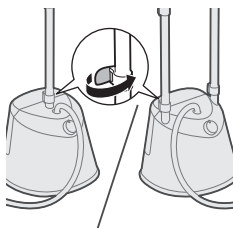

3 Заблокируйте нижние зажимы-фиксаторы на штанге.

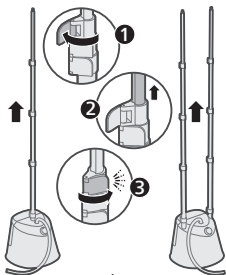

4 Разблокируйте оставшиеся зажимы-фиксаторы штанги, полностью выдвиньте штанги вверх и зафиксируйте их.

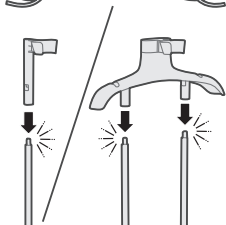

5 Установите крепление отпаривателя на штанги до щелчка.

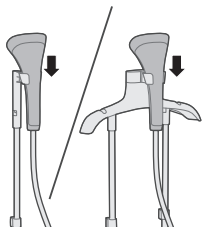

- 6 Установите на крепление головку отпаривателя.

Установка доски

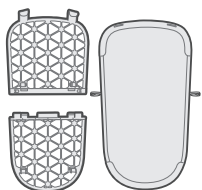

- 1 Посмотрите, из каких компонентов состоит приобретенный вами прибор.

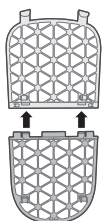

- 2 Совместите и вставьте зажимы доски до щелчка.

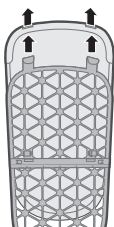

- 3 Совместите и вставьте чехол доски через крюки.

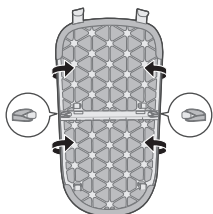

- 4 Закрепите на крюках задней стороны доски петли чехла

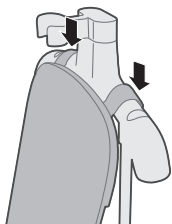

5 Установите доску на вешалку.

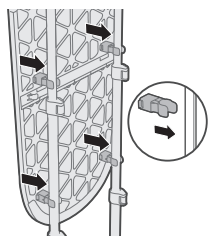

6 Закрепите доску на штангах до щелчка.

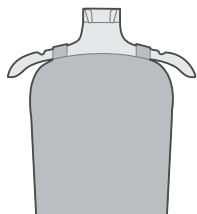

7 Вы можете вешать вещи на вешалку.

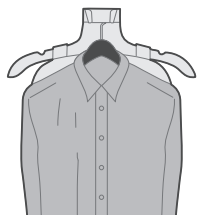
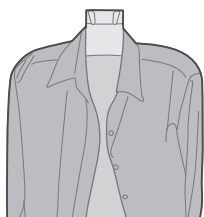

8 Можете использовать свою вешалку и расположить ее на креплении отпаривателя.

Размещение коврика

- 1 Проденьте центральную петлю через крепление отпаривателя.

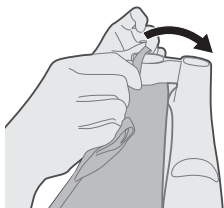

- 2 Закрепите 3 петли на крюках на задней стороне вешалки.

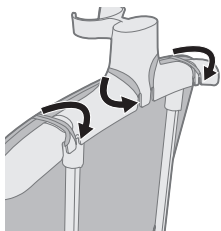

- 3 Прикрепите коврик к штангам до щелчка.

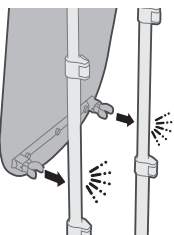

- 4 Вы можете вешать вещи на вешалку.





- 5 Можете использовать свою вешалку и расположить ее на креплении отпаривателя.

Установка щетки

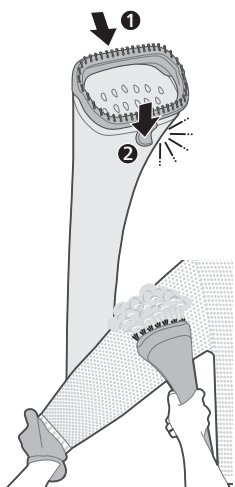

- 1 Совместите направляющую в верхней части головки отпаривателя с пазом в нижней части и вставьте до щелчка.

- 2 Вы можете надеть перчатки и отпаривать вещи с помощью насадки-щетки.

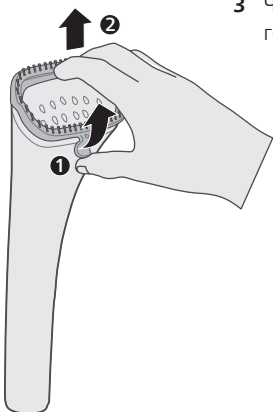

- 3 Чтобы снять насадку-щетку, возьмитесь и потяните за насадку вверх с головки отпаривателя.

Заполнение резервуара для воды

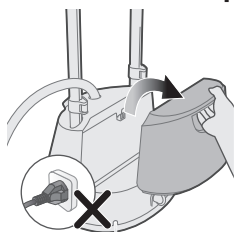

1 Не подключайте прибор к электросети. Снимите резервуар для воды с основания.

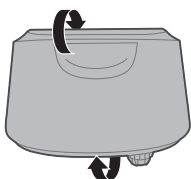

2 Переверните резервуар крышкой вверх.

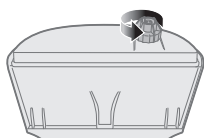

3 Выкрутите крышку против часовой стрелки.

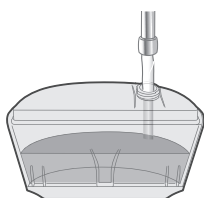

4 Наполните резервуар для воды.

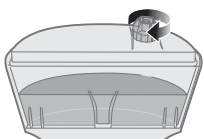

5 Закрутите крышку по часовой стрелке.

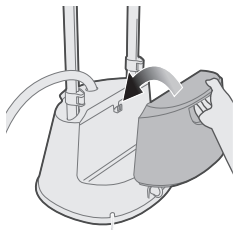

- 6 Совместите паз с крючком, чтобы установить резервуар для воды в основание прибора.

Изменение настроек подачи пара

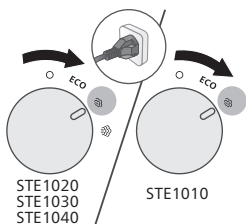

- 1 Убедитесь, что прибор подключен к сети. Поверните регулятор подачи пара в нужное положение.

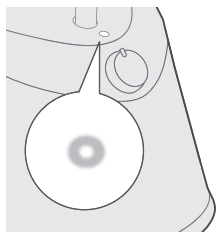

- 2 Индикатор загорится ровным светом, обозначая, что вертикальный отпариватель включен.

*STE1010/75: ~2 min

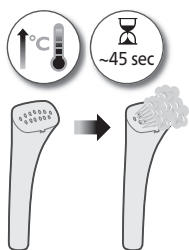

- 3 Подождите около 45 секунд, пока вертикальный отпариватель не нагреется и не начнет подавать пар (около 2 минут для модели STE1010/75).

Советы по отпариванию

- 1 Можете использовать свою вешалку и расположить ее на креплении отпаривателя.

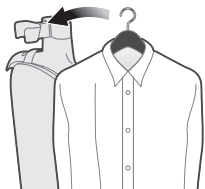

- 2 Перемещайте головку отпаривателя параллельно воротнику.

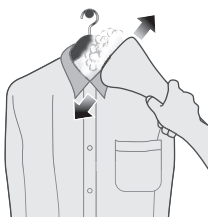

- 3 Перемещайте головку отпаривателя горизонтально вдоль кокетки.

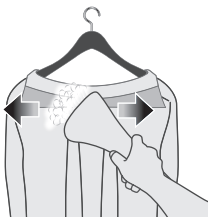

- 4 Растяните вещь. Перемещайте головку отпаривателя вниз вдоль переднего края вещи.

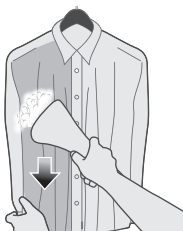

- 5 Перемещайте головку отпаривателя вверх при отпаривании карманов.





- 6 Растяните вещь. Перемещайте головку отпаривателя вниз вдоль заднего края вещи.

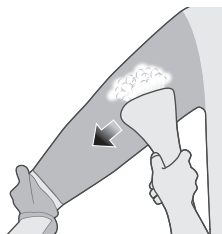

- 7 Растяните вещь. Перемещайте головку отпаривателя параллельно рукаву.

Очистка и уход

Система сборки накипи

Ваш прибор оснащен системой сборки накипи. Рекомендуется выполнять очистку от накипи не реже раза в месяц. Благодаря этому подача мощного пара остается эффективной, а грязь и частицы накипи не поступают из отверстий подошвы.

Совет. Система сборки накипи доступна для активации в любое время. Если вы живете в регионе с жесткой водой, используйте ее чаще.

Выполнение очистки от накипи

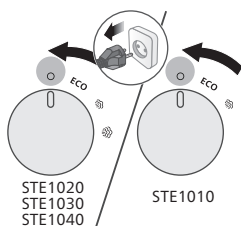

- 1 Убедитесь, что регулятор подачи пара находится в положении ВЫКЛ., а прибор отключен от электросети.

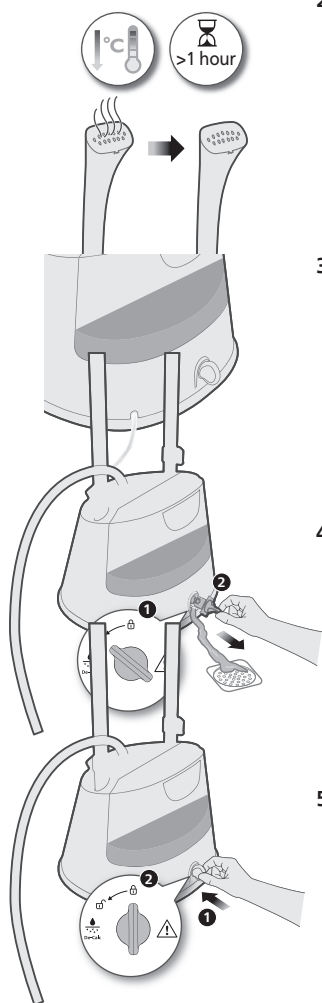

2 Убедитесь, что прибор полностью остыл (свыше 1 часа).

3 Поместите отпариватель возле сливного отверстия.

4 Поверните клапан De-calc в позицию разблокировки и извлеките его. Слейте воду.

5 Вставьте и поверните клапан De-calc в положение блокировки.

Очистка и хранение вертикального отпаривателя

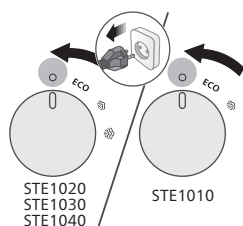

1 Убедитесь, что регулятор подачи пара находится в положении ВЫКЛ., а прибор отключен от электросети.

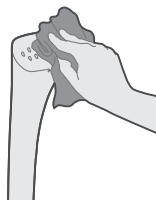
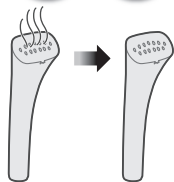

2 Убедитесь, что прибор полностью остыл (свыше 1 часа).

3 Очистите внешний корпус влажной тканью.



4 Вылейте всю воду из резервуара.

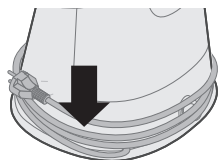

5 Намотайте сетевой шнур вокруг основания.

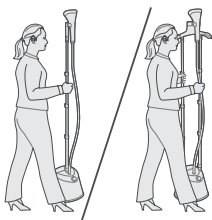

6 Вертикальный отпариватель можно переносить за штангу.

Устранение неисправностей

В данной главе приведены проблемы, которые наиболее часто возникают при эксплуатации прибора. Если самостоятельно справиться с возникшими проблемами не удастся, см. список часто задаваемых вопросов на веб-странице www.philips.com/support или обратитесь в центр поддержки потребителей в вашей стране.

Проблема	Возможная причина	Решение
Подача пара происходит нерегулярно или отсутствует.	Отпариватель не нагрелся до необходимой температуры.	Дайте прибору нагреться в течение примерно 45 секунд (около 2 минут для модели STE1010/75).
	Пар сконденсировался в шланге.	Поднимите сопло отпаривателя вертикально, чтобы распрямить шланг. В таком положении весь конденсат попадет обратно в резервуар для воды.
	Воды в резервуаре недостаточно или резервуар не установлен должным образом.	Пополните резервуар для воды и вставьте его должным образом.
	В приборе скопилось слишком много накипи.	Выполните процедуру очистки от накипи. См. раздел об очистке от накипи.
Из сопла отпаривателя капает вода или прибор издает булькающий звук.	Сопло отпаривателя и/или шланг подачи пара долго находились в горизонтальном положении.	Поднимите сопло отпаривателя вертикально, чтобы распрямить шланг. В таком положении весь конденсат попадет обратно в резервуар для воды.
	Если шланг принимает U-образную форму, скопившийся конденсат не может поступать обратно в резервуар для воды.	Поднимите сопло отпаривателя вертикально, чтобы распрямить шланг. В таком положении весь конденсат попадет обратно в резервуар для воды.
Во время нагрева прибора из сопла поступают капли воды.	В приборе используется грязная вода, или вода находилась в приборе в течение длительного времени.	Выполните процедуру очистки от накипи. См. раздел об очистке от накипи.
Из основания отпаривателя вытекает вода.	Не закрыта крышка резервуара для воды или клапан очистки. Резервуар для воды установлен неправильно.	Закройте крышку резервуара для воды и клапан очистки от накипи. Установите резервуар для воды должным образом.

Муқаддима

Шуморо барои харид табрик меғӯем ва ба Philips хуш омадед! Барои пурра истифода бурдан аз дастгирие, ки Philips пешниҳод мекунад, маҳсулоти худро дар он сабти ном кунед www.philips.com/welcome. Пеш аз истифода бурдани дастгоҳ ин дастури корбар, варақаи иттилооти муҳим ва дастури оғози зудро бодикқат хонед. Онҳоро барои истинод дар оянда захира кунед.

Шарҳи маҳсулот

STE1020, STE1030, STE1040

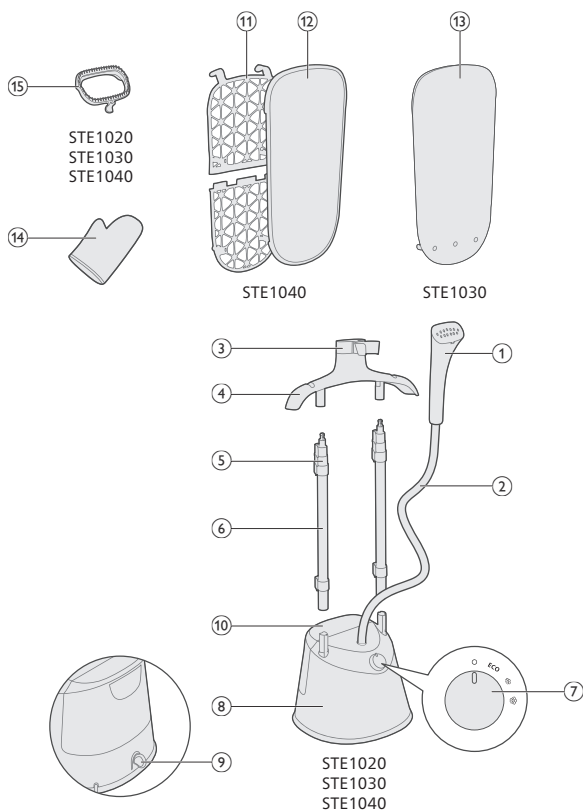

STE1010

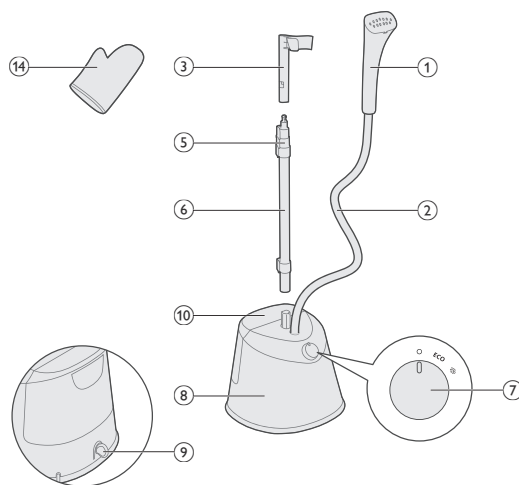

- 1 Сараки деги буғӣ (пароварка)
- 2 Шланги таъмини буғ
- 3 Пойгоҳи бухоркунанда
- 4 Овезак (STE1020, STE1030, STE1040)
- 5 Қулф барои мустаҳкам кардани сутун
- 6 Сутун
- 7 Танзимгари буғ
- 8 Қисми поёнӣ (замина)
- 9 Клапани De-calc
- 10 Зарфи об
- 11 Доска (STE1040)
- 12 Муқова (STE1040)
- 13 Мат (STE1030)
- 14 Дастпӯшак
- 15 Чутка (STE1020, STE1030, STE1040)

Омодагӣ ба истифода

Навъи об барои истифода

Дастгоҳ барои истифода бо оби лӯла мувофиқ аст. Аммо, агар шумо дар як минтақаи оби сахт зиндагӣ кунед, мо ба шумо тавсия медиҳем, ки миқдори баробари оби лӯларо бо оби софшуда ё деминерализатсияшуда омехта кунед. Ин имкон медиҳад, ки зуд ҷамъшавии оҳаксанг пешгирӣ карда шавад ва мӯҳлати хизмати дастгоҳ дароз карда шавад.

Оби хушбӯй, об аз мошини хушккунак, сирко, крахмал, маводҳо барои тозакунии аз карахш, асбобҳои дарзмолкунӣ, оби кимиёвӣ ва дигар моддаҳои кимиёвиро истифода набаред,

зеро ин метавонад боиси рехтани об, доғи қаҳваранг ё вайрон шудани дастгоҳи шумо гардад.

Огоҳӣ

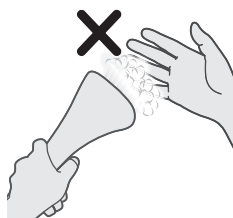

1 Ҳеҷ як қисми пӯст бояд дар тамоси мустақим бо буғ набошад.



2 Табақи буғро ба сӯи шахсони дигар нагузored.



3 Либоси худро тавре нигоҳ дored, ки бевосита бо буғ тамос нагирад.

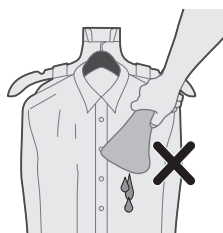

4 Сари дарзмоли буғиро ба самти поён истифода набаред.

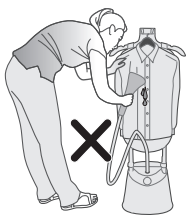

5 Барои дарзмол кардани либос шлангро ҳам накунад.

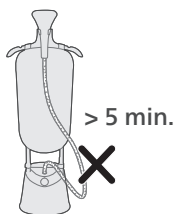

6 Деги буғиро дар давоми зиёда аз 5 дақиқа беназорат нагузored.

Танзими дастгоҳ

STE1010

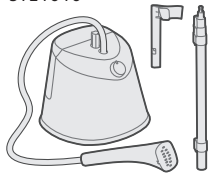

1 Лутфан қисмҳои барои дастгоҳи харидашуда дастрас бударо ба назар гиред.

STE1020, STE1030

STE1040

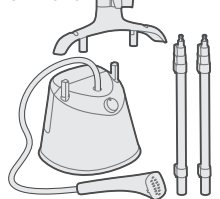

2 Қулфҳои тиргақҳои поёниро кушоед ва сутун(ҳо)-ро ба пойгоҳ гузored. Боварӣ ҳосил кунед, ки профилҳои сутун(ҳо) ва сутун(ҳо)-и дастгирӣ мувофиқанд.

576 Тоҷикӣ

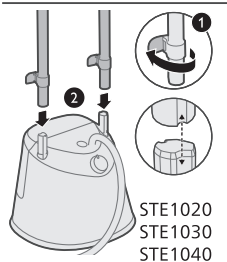
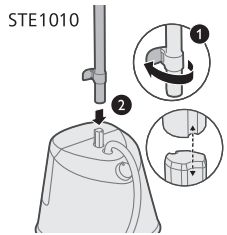

STE1020
STE1030
STE1040

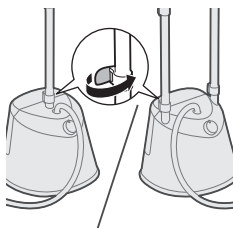

3 Қулф(ҳо) барои мустаҳкам кардани сутунро қулф кунед.

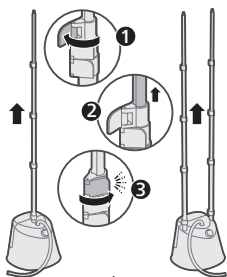

4 Қулф(ҳо) барои мустаҳкам кардани сутуни боқимондаро кушоед, сутун(ҳо)-ро ба боло дароз кунед ва онро маҳкам кунед.

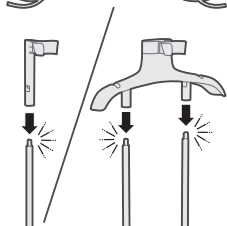

5 Васлкунаки дарзмоли буғиро ба сутун(ҳо) гузоред, то он даме, ки дар ҷои худ қулф шавад ("клик").

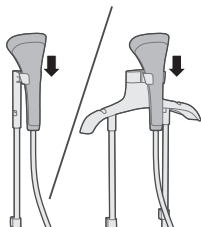

- 6 Сараки дарзмоли буғиро ба пойгоҳи бухоркунанда монед.

Танзими доска

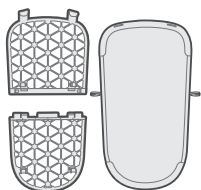

- 1 Лутфан қисмҳои барои дастгоҳи харидашуда дастрас бударо ба назар гиред.

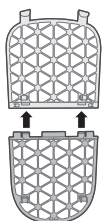

- 2 Қулфҳои доскаро ҳамвор кунед то он даме, ки он дар ҷои худ қулф шавад ("клик").

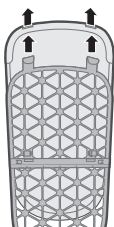

- 3 Сарпӯши тахтаро ба воситаи овозақҳои доска мувофиқ кунед ва гузоред.

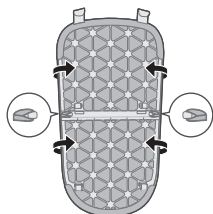

- 4 Тасмаҳои сарпӯши тахтаро ба овозақҳои қафои доска пайваст кунед

578 Тоҷикӣ

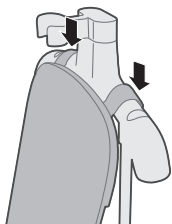

5 Доскаро ба болои овезак ҷойгир кунед.

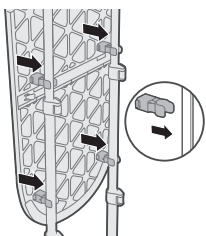

6 Доскаро ба сунунҳо маҳкам кунед, то он даме, ки он дар ҷои худ қулф шавад ("клик").

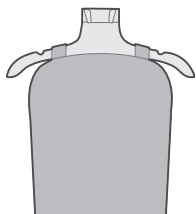

7 Шумо метавонед либосҳои худро бо истифода аз овезак пушонед.

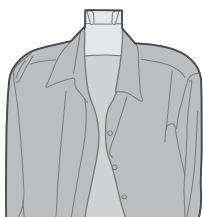

8 Шумо метавонед овезаки шахсии худро истифода баред ва онро дар истгоҳи дарзмоли буғӣ ҷойгир кунед.

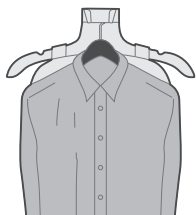

Танзими мат

- 1 Тасмаи миёнаро ба воситаи васлаки дарзмоли буғӣ гузоред.

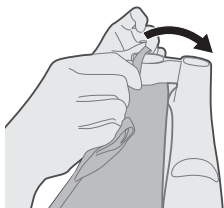

- 2 3 тасмаро дар овезаки, ки дар қафои овезак ҷойгир аст, маҳкам кунед.

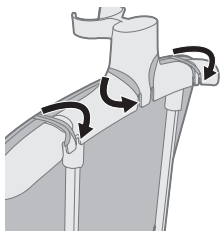

- 3 Матро ба сутунҳо то он даме, ки дар ҷои худ баста шавад, маҳкам кунед ("клик").

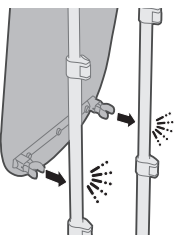

- 4 Шумо метавонед либосҳои худро бо истифода аз овезак пушонед.





- 5 Шумо метавонед овозаки шахсии худро истифода баред ва онро дар истгоҳи дарзмоли буғӣ ҷойгир кунед.

Ҷойгиркунии чутка

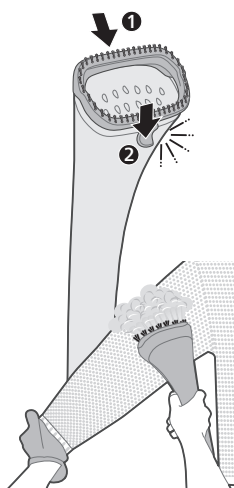

- 1 Дастурро бо болои сараки дарзмоли буғӣ мувофиқ кунед ва қулфи дар поён бударо ба қор баред ("клик").

- 2 Шумо метавонед дастпӯшак пӯшед ва бо истифода аз замимаи чутка либосҳои худро дарзмон кунед.

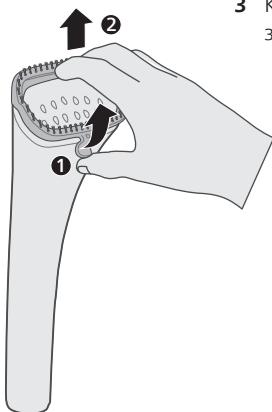

- 3 Қулфи қаъри замимаи дарзмоли буғиро гирифта, барои хориҷ кардани замимаи чутка онро кашед.

Пур кардани зарфи об

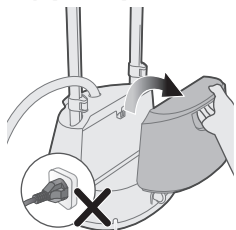

1 Дастгоҳро дар васлаки барқӣ нагузored. Зарфи обро аз пойгоҳ хориҷ кунед.

2 Зарфҳои обро бо сарпӯши зарфи об ба боло тоб диҳед.

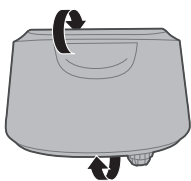

3 Сарпӯши зарфи обро ба муқобили ақрабаки соат кушоед, то хориҷ кунед.

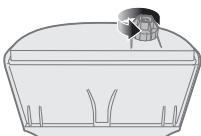

4 Зарфи обро бо об пур кунед.

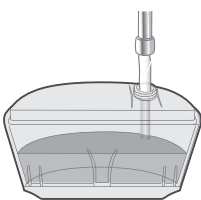

5 Сарпӯши зарфи обро бо ақрабаки соат тоб диҳед, то сахттар кунед.

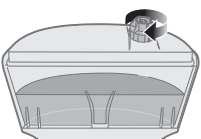

582 Тоҷикӣ

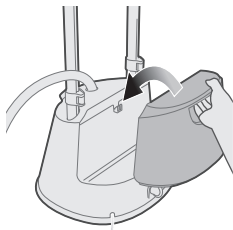

- 6 Бо овозак мувофиқ кунед, то зарфи обро ба пойгоҳ баргардонед.

Иваз кардани танзмоти дарзмоли буғӣ

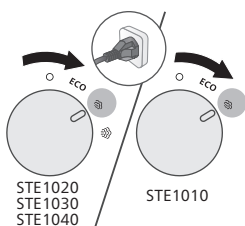

- 1 Боварӣ ҳосил кунед, ки дастгоҳ ба шабака пайваст аст. Танзимаи буғро ба танзмоти дилхоҳи буғ табдил диҳед.

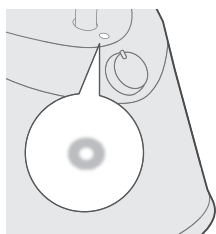

- 2 Чароғ устуворона фурузон мешавад, ки нишондиҳандаи он аст, кидарзмоли буғӣ фаъол аст.

*STE1010/75: ~2 min

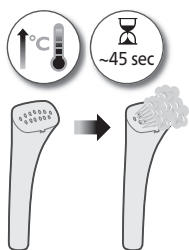

- 3 Тақрибан 45 сония мунтазир шавед, ки дарзмоли буғӣ гарм шавад ва буғ хориҷ кунад (STE1010/75: 2 дақиқа мегирад).

Маслиҳатҳо барои дарзмолкунӣ

- 1 Шумо метавонед овезаки шахсии худро истифода баред ва онро дар истоғои дарзмоли буғӣ ҷойгир кунед.

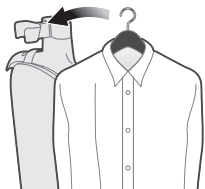

- 2 Сараки дарзмоли буғиро ба самти параллел бо гиребон ҳаракат кунед.

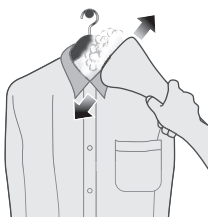

- 3 Сараки дарзмоли буғиро бо ҳамут ба самти уфуқӣ ҳаракат кунед.

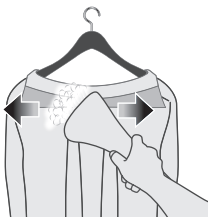

- 4 Либосро кашед. Сараки дарзмоли буғиро ба самти поён дар пеши бадан ҳаракат диҳед.

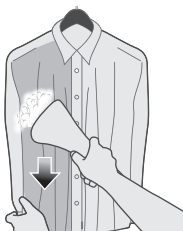

- 5 Сараки дарзмоли буғиро ба самти боло ба тарафи киса ҳаракат диҳед.





6 Либосро кашед. Сараки дарзмоли буғиро ба самти поён ба қафои бадан ҳаракат диҳед.

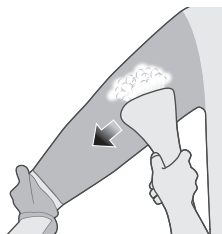

7 Либосро кашед. Сараки дарзмоли буғиро бо остин ба самти параллел ҳаракат диҳед.

Тозакунӣ ва нигоҳдорӣ

Чамъкунандаи карахш

Дастгоҳи шумо бо системаи чамъкунандаи карахш (Calc Collector) тарҳрезӣ шудааст. Ба шумо тавсия дода мешавад, ки дар як моҳ як маротиба ё бештар аз он тоза кардани карахшро анҷом диҳед. Ин барои нигоҳ доштани кори пурқуввати буғ кӯмак мекунад ва баромадани чирк ва доғоро бо мурури замон аз кафи дарзмол пешгирӣ мекунад.

Маслиҳат: Системаи чамъкунандаи карахш (Calc Collector) метавонад дар ҳар вақт истифода шавад. Агар шумо дар як минтақаи бо оби саҳт зиндагӣ кунед, ин функсияро зуд-зуд истифода баред.

Чараёни calc-clean-ро иҷро кунед.

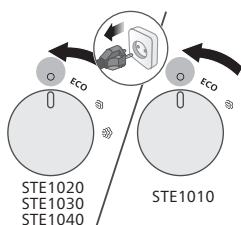

1 Боварӣ ҳосил кунед, ки танзимаи буғӣ дар ҳолати OFF аст ва дастгоҳ аз сими барқ ҷудо карда шудааст.

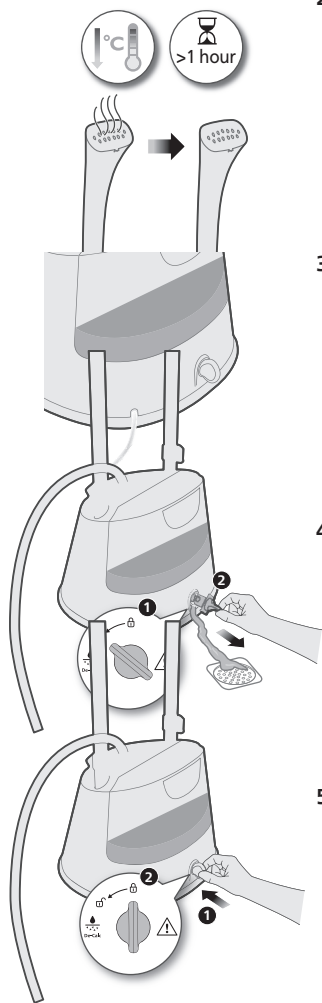

2 Боварӣ ҳосил кунед, ки дарзмол пурра хунук шудааст (> 1 соат).

3 Дарзмоли буғиро дар наздикии канали баромад ҷойгир кунед.

4 Клапани De-calc-ро ба кушоед ва клапани De-calc-ро хориҷ кунед. Обро холи кунед.

5 Клапани De-calc-ро қулф кунед ва тоб диҳед.

Тоза кардан ва нигоҳдории дарзмоли буғӣ

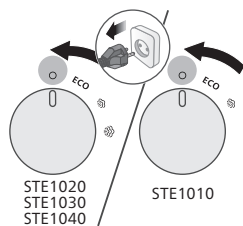

1 Боварӣ ҳосил кунед, ки танзимаи буғӣ дар ҳолати OFF аст ва дастгоҳ аз сими барқ ҷудо карда шудааст.

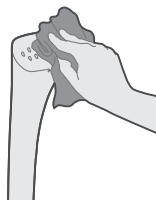
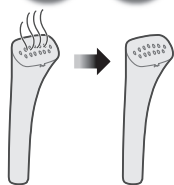

2 Боварӣ ҳосил кунед, ки дарзмомл пурра хунук шудааст (> 1 соат).

3 Ҷои буғқуниро бо матои нам пок кунед.



4 Зарфи обро пурра холӣ кунед.

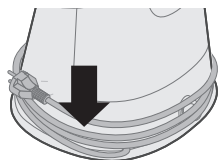

5 Сими барқро дар атрофи пойгоҳ ҷамъ кунед.

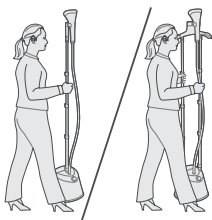

6 Шумо метавонед дармоли буғиро аз сутун бардоред.

Бартараф кардани мушкилот

Ин боб мушкилоти маъмултаринеро, ки шумо бо дастгоҳ дучор меоед, чамъбаст мекунад. Агар шумо наметавонед масъаларо бо маълумоти зерин ҳал кунед, ба www.philips.com/support ташриф оваред, барои рӯйхати саволҳои зуд-зуд додашаванда ё бо Маркази Нигоҳубини Истеъмолкунандагон дар кишвари худ тамос гиред.

Мушкилот	Сабаби эҳтимоли	Роҳи ҳал
Дастгоҳ буғ намебарорад ё буғ номунтазам аст.	Буғбарор ба қадри кофӣ гарм нашудааст.	Бигзор дастгоҳ тақрибан 45 сония гарм шавад (STE1010/75: 2 дақиқа мегирад).
	Буғ дар шланг конденсатсия шудааст.	Сараки деги буғӣ (пароварка) боло кунед, то шлангро амудӣ рост кунед. Ин имкон медиҳад, ки ҳама гуна конденсатсия баргардад.
	Сатҳи пасти об дар зарф ё зарф дуруст ворид карда нашудааст.	Зарфи обро дубора пур кунед ва дуруст ҷойгир кунед.
	Караҳи аз ҳад зиёд дар дастгоҳ чамъ шудааст.	Ҷараёни de-calc -ро иҷро кунед. Ба қисми Calc-Clean муроҷиат намоед.
Аз сараки буғбарор қатраҳои об чорӣ мешаванд, ё дастгоҳ садои кур-кур мебарорад.	Шумо сараки буғбарор ва/ё шланги интиқоли буғро муддати дароз дар ҳолати уфуқӣ гузоштаед.	Сараки деги буғӣ (пароварка) боло кунед, то шлангро амудӣ рост кунед. Ин имкон медиҳад, ки ҳама гуна конденсатсия баргардад.
	Агар шланг U-шакл дошта бошад, конденсати чамъшуда дубора ба зарфи об чорӣ шуда наметавонад.	Сараки деги буғӣ (пароварка) боло кунед, то шлангро амудӣ рост кунед. Ин имкон медиҳад, ки ҳама гуна конденсатсия баргардад.
Ҳангоми гарм шудани дастгоҳ аз сараки буғӣ оби аз ҳад зиёд берун меояд.	Оби дастгоҳ ифлос аст ё муддати дароз дар дохили дастгоҳ мондааст.	Ҷараёни de-calc -ро иҷро кунед. Ба қисми Calc-Clean муроҷиат намоед.
Аз базаи пароход об чорӣ мешавад.	Сарпуши зарфи об баста нашудааст ё клапани de-calc баста нашудааст. Зарфи об дуруст ҷойгир карда нашудааст.	Сарпуши зарфи об ё клапани de-calc-ро дуруст маҳкам кунед. Зарфро дуруст ҷойгир кунед.

Вступ

Вітаємо з придбанням виробу Philips! Щоб у повній мірі скористатися підтримкою, яку пропонує компанія Philips, зареєструйте свій виріб на вебсайті www.philips.com/welcome. Уважно прочитайте цей посібник користувача, інформаційний буклет і короткий посібник, перш ніж користуватися пристроєм. Зберігайте їх для майбутньої довідки.

Огляд виробу

STE1020, STE1030, STE1040

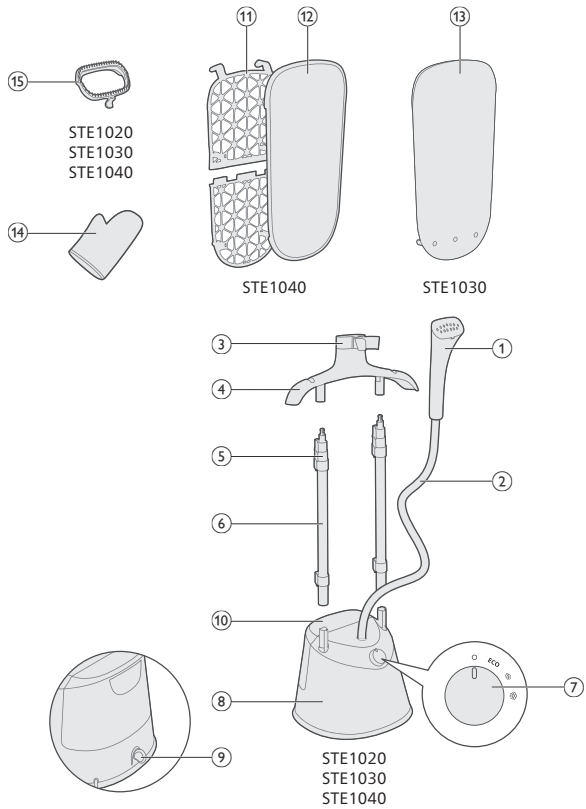

STE1010

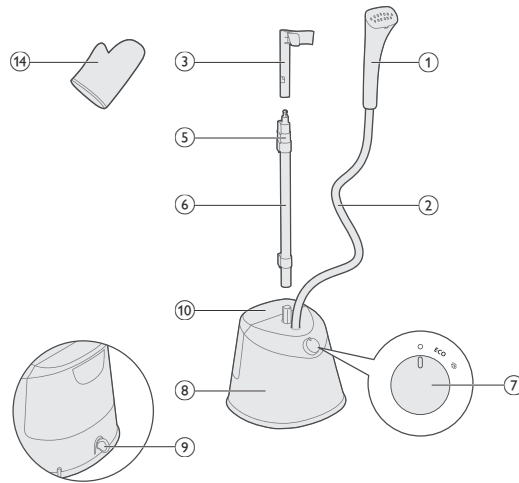

- 1 Головка відпарювача
- 2 Шланг подачі пари
- 3 Док-станція відпарювача
- 4 Вішак (STE1020, STE1030, STE1040)
- 5 Затискач для фіксації стійки
- 6 Стійка
- 7 Регулятор пари
- 8 Платформа
- 9 Регулятор очищення від накипу
- 10 Резервуар для води
- 11 Дошка (STE1040)
- 12 Покриття (STE1040)
- 13 Килимок (STE1030)
- 14 Рукавичка
- 15 Щітка (STE1020, STE1030, STE1040)

Підготовка до використання

Тип води, яку слід використовувати

Для пристрою можна використовувати воду з-під крана. Однак якщо ви живете в області з жорсткою водою, ми рекомендуємо вам змішувати в рівних пропорціях воду з-під крана та дистильовану або демінералізовану воду. Це запобігатиме швидкому утворенню накипу та подовжить строк служби пристрою.

Не додавайте парфуми, воду із сушильної машини, оцет, крохмаль, засоби проти накипу, засоби для прасування, воду після хімічного видалення накипу чи інші хімічні речовини,

оскільки вони можуть спричинити розбризкування води, появу коричневих плям чи пошкодження пристрою.

Попередження

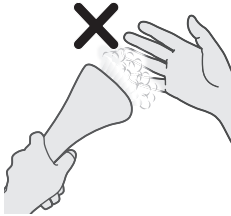

1 Не допускайте прямого контакту шкіри з паром.



2 Не спрямовуйте парову пластину на інших людей.

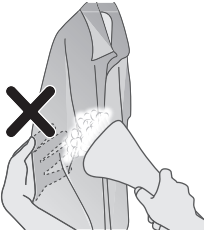

3 Не тримайте одяг так, щоб безпосередньо контактувати з паром.



4 Не використовуйте головку відпарювача в напрямку донизу.



5 Не згинайте шланг під час відпарювання одягу.

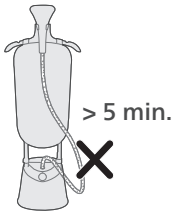

6 Не залишайте відпарювач без нагляду більше ніж на 5 хвилин.

Налаштування пристрою

STE1010

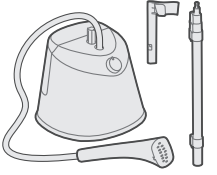

1 Зверніть увагу, які частини доступні для придбаного вами пристрою.

STE1020, STE1030
STE1040



2 Розблокуйте нижні затискачі для фіксації стійки(ок) і вставте стійку(и) на платформу. Профілі стійки(ок) і стержні для стійки(ок) на платформі мають бути вирівняні.

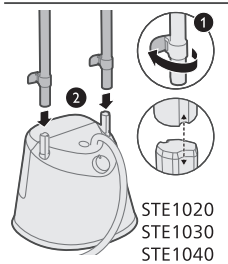
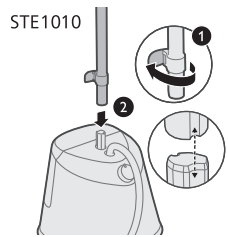

STE1020
STE1030
STE1040

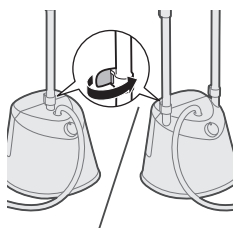

3 Заблокуйте нижні затискачі для фіксації стійок.

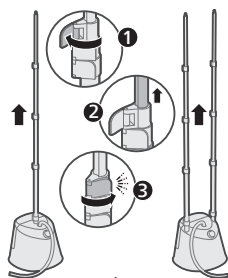

4 Розблокуйте решту затискачів для фіксації стійок, повністю розкладіть стійку(и) вгору й заблокуйте.

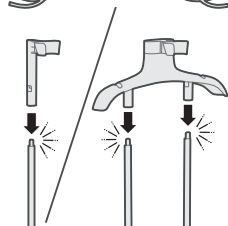

5 Вставте док-станцію відпарювача на стійку(и) до фіксації.

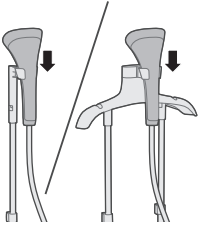

6 Вставте головку відпарювача на док-станцію.

Збирання дошки

1 Зверніть увагу, які частини доступні для вашого придбаного пристрою.

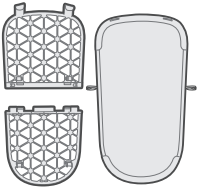

2 Вирівняйте і вставте затискачі стійок до фіксації.

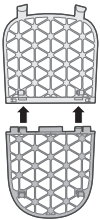

3 Вирівняйте і вставте покриття дошки через гачки дошки.

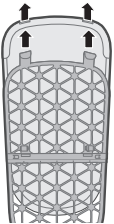

4 Закріпіть лямки покриття дошки на гачках на задній частині дошки.

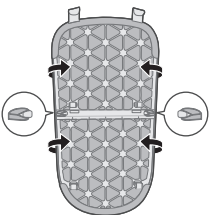

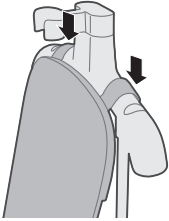

5 Встановіть дошку на вішак.

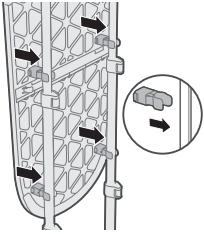

6 Закріпіть дошку на стійках до фіксації.

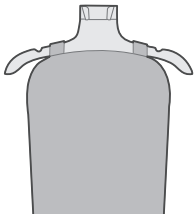

7 На вішак можна повісити одяг.

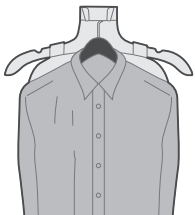
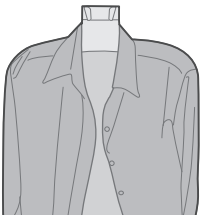

8 Ви можете взяти власний вішак і повісити його на док-станцію відпарювача.

Встановлення килимка

- 1 Протягніть середню лямку через док-станцію відпарювача.

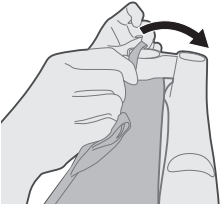

- 2 Закріпіть три лямки на гачках на задній частині вішака.

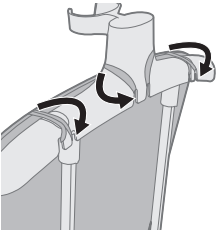

- 3 Закріпіть килимок на стійках до фіксації.

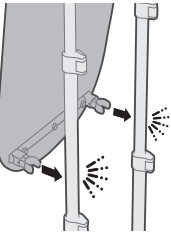

- 4 На вішак можна повісити одяг.

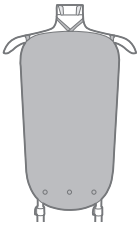



- 5 Ви можете взяти власний вішак і повісити його на док-станцію відпарювача.

Встановлення щітки

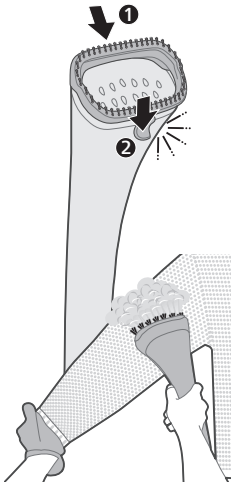

- 1 Вирівняйте каркас щітки вздовж верхньої частини головки відпарювача і зафіксуйте затискач знизу до клацання.

- 2 Ви можете надіти рукавичку й відпарювати одяг за допомогою насадки-щітки.

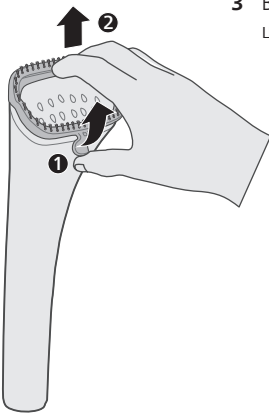

- 3 Візьміться за затискач у нижній частині головки відпарювача і потягніть, щоб зняти насадку-щітку.

Наповнення резервуара для води

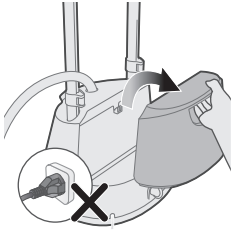

- 1 Не під'єднуйте пристрій до мережі. Зніміть резервуар для води з платформи.

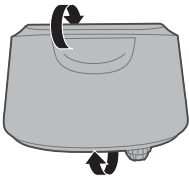

- 2 Переверніть резервуар для води кришкою догори.

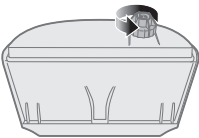

- 3 Відкрутіть кришку резервуара для води проти годинникової стрілки, щоб зняти її.

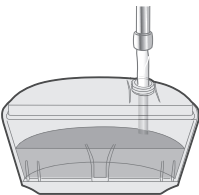

- 4 Наповніть резервуар водою.

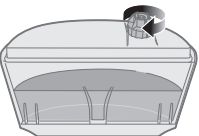

- 5 Закрутіть кришку резервуара для води за годинниковою стрілкою до кінця.

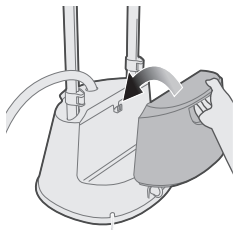

- 6 Вирівняйте резервуар для води із гачком, щоб встановити резервуар назад на платформу.

Зміна налаштувань пари

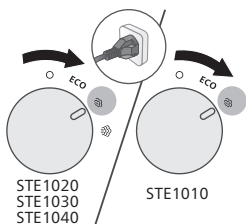

- 1 Переконайтеся, що пристрій під'єднано до електромережі. Поверніть регулятор пари у потрібне значення.

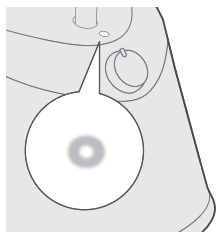

- 2 Індикатор буде постійно світитися, вказуючи на те, що відпарювач на підставці увімкнено.

*STE1010/75: ~2 min

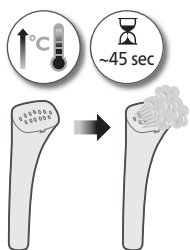

- 3 Почекайте приблизно 45 секунд, поки відпарювач на підставці нагріється й почне подавати пару (STE1010/75: приблизно 2 хвилини).

Поради щодо прасування

- 1 Ви можете взяти власний вішак і повісити його на док-станцію відпарювача.

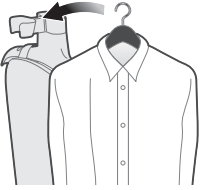

- 2 Ведіть головкою відпарювача паралельно до коміра.

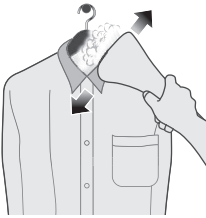

- 3 Ведіть головкою відпарювача горизонтально до лопаток.



- 4 Натягніть одяг. Ведіть головкою відпарювача в напрямку донизу по лицьовій стороні одягу.

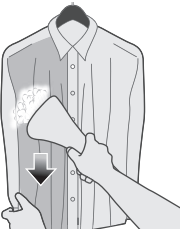

- 5 Ведіть головкою відпарювача в напрямку догори на кишені.



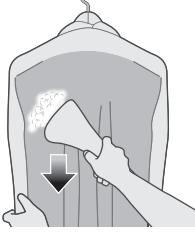

6 Натягніть одяг. Ведіть головкою відпарювача в напрямку донизу на задній частині одягу.

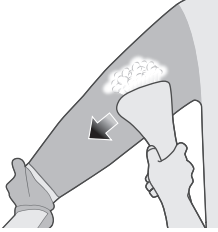

7 Натягніть одяг. Ведіть головкою відпарювача паралельно по рукаву.

Чищення та догляд

Збирач накипу

Ваш пристрій має систему збирання накипу. Рекомендовано видаляти накип раз на місяць або частіше. Це допомагає підтримувати потужну ефективність відпарювання і з часом запобігає виведенню бруду і плям з підшови.

Підказка. Системою збирання накипу можна користуватися в будь-який час. Якщо у вашому регіоні жорстка вода, використовуйте функцію частіше.

Процес очищення від накипу

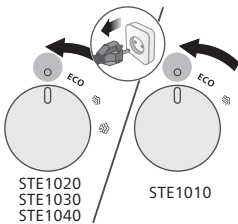

1 Перевірте, чи регулятор пари в положенні OFF, а пристрій від'єднано від мережі.

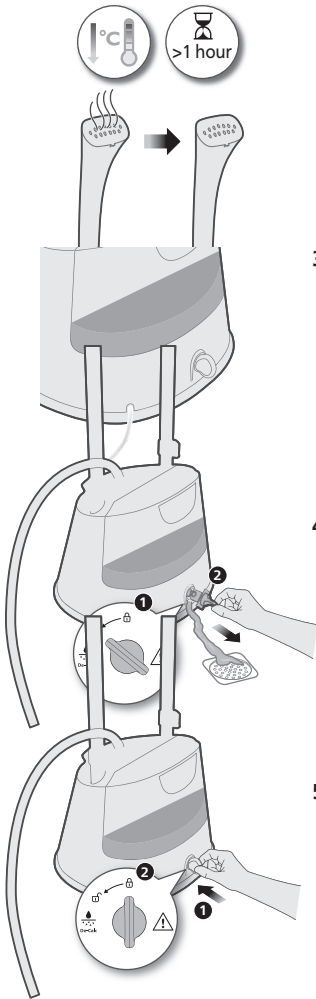

2 Переконайтеся, що праска повністю охолола (> 1 год).

3 Поставте відпарювач неподалік раковини.

4 Поверніть регулятор очищення від накипу в положення розблокування та зніміть його. Дайте воді стекти.

5 Вставте й поверніть регулятор очищення від накипу в положення блокування.

Чищення та зберігання відпарювача на підставці

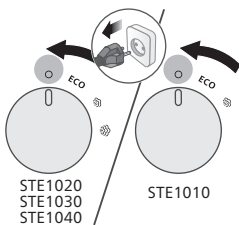

1 Перевірте, чи регулятор пари в положенні OFF, а пристрій від'єднано від мережі.

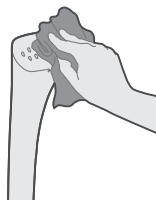
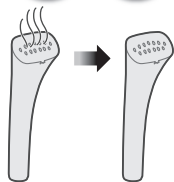

2 Переконайтеся, що праска повністю охолола (> 1 год).

3 Протріть місце відпарювання вологою ганчіркою.



4 Повністю спорожніть резервуар для води.

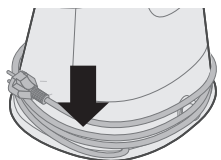

5 Намотайте кабель живлення на платформу.

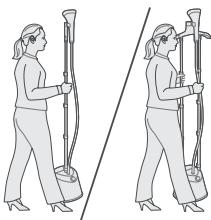

6 Відпарювач із підставкою можна переносити, тримаючи за стійку.

Усунення несправностей

У цьому розділі подано основні проблеми, які можуть виникнути під час використання пристрою. Якщо ви не в змозі вирішити проблему за допомогою інформації, поданої нижче, відвідайте вебсайт www.philips.com/support для перегляду списку поширених запитань або зверніться до Центру обслуговування клієнтів у своїй країні.

Проблема	Можлива причина	Вирішення
Пара не подається або подається нерегулярно.	Відпарювач недостатньо нагрівся.	Дайте пристрою нагрітися протягом приблизно 45 секунд (STE1010/75: приблизно 2 хвилини).
	Пара сконденсувалася у шлангу.	Підніміть головку відпарювача, щоб випрямити шланг вертикально. Конденсат потече назад.
	Низький рівень води в резервуарі або резервуар не встановлено належним чином.	Наповніть резервуар водою та встановіть його належним чином.
	У пристрої утворилося надто багато накипу.	Виконайте очищення від накипу. Див. розділ з інформацією про очищення від накипу.
Із головки відпарювача скрапує вода або пристрій видає звуки булькання.	Головка відпарювача та/або шланг подачі пари довго перебували в горизонтальному положенні.	Підніміть головку відпарювача, щоб випрямити шланг вертикально. Конденсат потече назад.
	Коли шланг набуває U-подібної форми, конденсат у ньому не може потрапляти назад у резервуар для води.	Підніміть головку відпарювача, щоб випрямити шланг вертикально. Конденсат потече назад.
Під час нагрівання пристрою з головки відпарювача скрапує надто багато води.	Вода у пристрої брудна або довго знаходилася у ньому.	Виконайте очищення від накипу. Див. розділ з інформацією про очищення від накипу.
Із платформи відпарювача витікає вода.	Погано закрито кришку резервуара для води або регулятор очищення від накипу. Неправильно вставлено резервуар для води.	Надійно закрийте кришку резервуара для води або регулятор очищення від накипу. Встановіть резервуар належним чином.

Кіріспе

Осы затты сатып алуыңызбен құттықтаймыз және Philips компаниясына қош келдіңіз! Philips ұсынатын қолдауды толық пайдалану үшін өнімді www.philips.com/welcome веб-сайтында тіркеңіз. Құрылғыны пайдаланбастан бұрын, осы пайдаланушы нұсқаулығын, маңызды ақпарат парақшасын және жылдам бастау нұсқаулығын мұқият оқып шығыңыз. Келешекте қарау үшін оларды сақтап қойыңыз.

Өнімге шолу жасау

STE1020, STE1030, STE1040

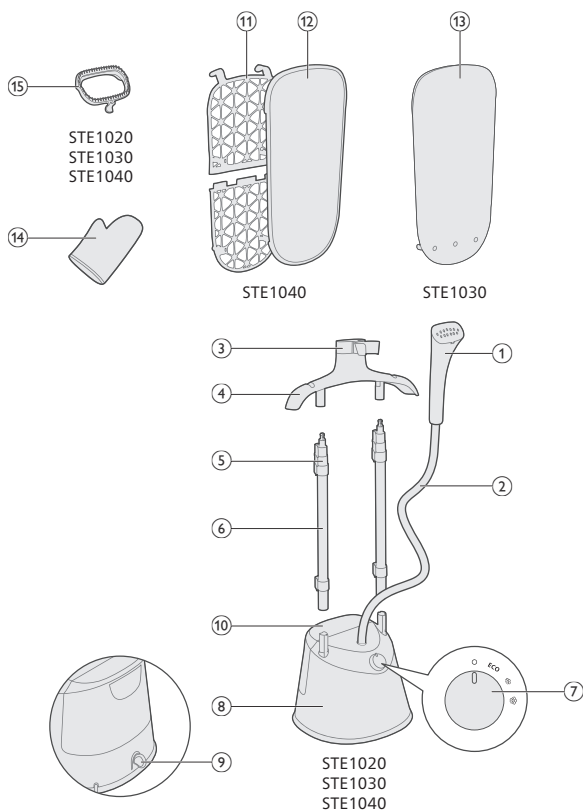

STE1010

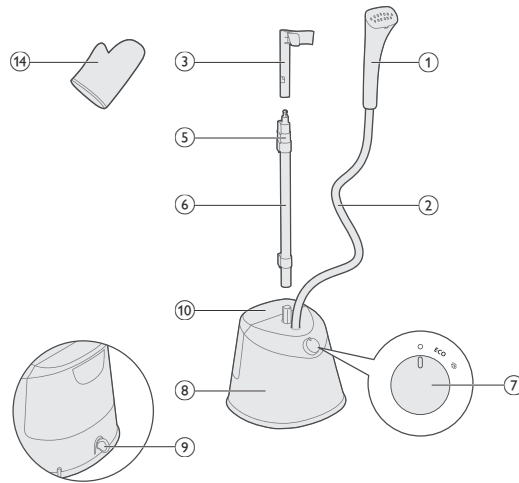

- 1 Бу үтігінің басы
- 2 Бу жеткізу шлангісі
- 3 Бу үтігі қондырмасы
- 4 Ілгіш (STE1020, STE1030, STE1040)
- 5 Тірек құлыптау қысқышы
- 6 Тірек
- 7 Бу дискісі
- 8 Тұғыр
- 9 Қақтан тазалау тұтқасы
- 10 Су ыдысы
- 11 Тақта (STE1040)
- 12 Жабын (STE1040)
- 13 Төсеме қабат (STE1030)
- 14 Қолғап
- 15 Щетка (STE1020, STE1030, STE1040)

Пайдалануға дайындау

Пайдаланылатын су түрі

Аспапты құбыр суымен бірге қолдануға болады. Алайда, егер сіздің ауданыңызда кермек су болса, біз құбыр суын тазартылған немесе минералсызданған сумен тең мөлшерде араластыруды ұсынамыз. Бұл қақтың тез жиналуының алдын алады және аспаптың қызмет ету мерзімін ұзартады.

Иіссуды, кептіргіш барабаннан алынған суды, сірке суын, үтіктеуге көмектесетін сұйықтарды, химиялық жолмен қақ кетіретін суды немесе басқа химиялық заттарды қоспаңыз,

себебі олар судың отыруына, қоңыр дақтардың қалуына себеп болуы немесе құрылғыны зақымдауы мүмкін.

Ескертулер

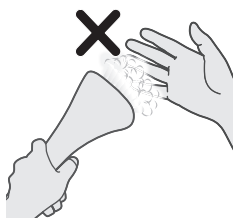

1 Терінің кез келген бөлігін бу шығатын жерге тікелей тигізбеңіз.



2 Бу табағын басқа адамдарға бағыттамаңыз.



3 Киіміңізді бу тікелей тимейтіндей етіп ұстаңыз.

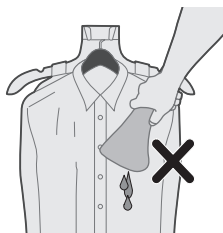

4 Бу үтігінің басын төмен қаратып қолданбаңыз.



5 Киімді бумен үтіктеу үшін шлангіні майыстырмаңыз.

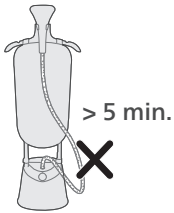

6 Бу үтігін 5 минуттан артық қараусыз қалдырмаңыз.

Құрылғыны орнату

STE1010

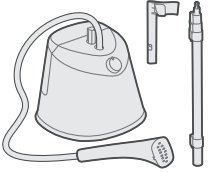

1 Сатып алынған құрылғы үшін қолжетімді бөлшектерге назар аударыңыз.

STE1020, STE1030
STE1040



2 Төменгі тірек құлыптау қысқыштарының құлпын ашып, тіректі (тіректерді) тұғырға салыңыз. Тірек(тер) мен тұғыр тіректерінің штиф(тер)іне тураланғанына көз жеткізіңіз.

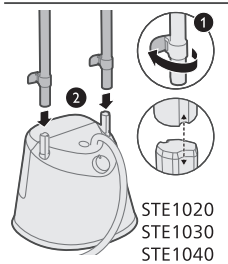
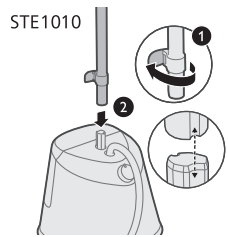

STE1020
STE1030
STE1040

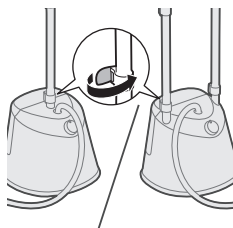

3 Төменгі тірек құлыптау қысқыш(тар)ын бекітіңіз.

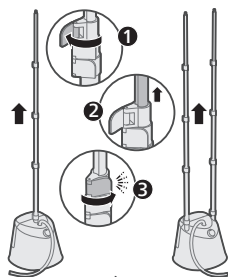

4 Қалған тірек құлыптау қысқыштарының құлпын ашып, тіректерді жоғары қарай толығымен созыңыз да, бекітіңіз.

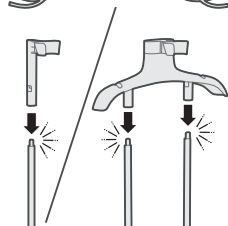

5 Бу үтігі қондырмасын орнына бекітілгенше («сырт» еткен дыбыс шығады) тірекке (тіректерге) салыңыз.

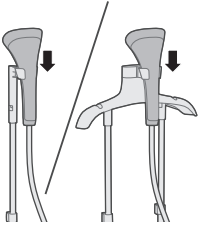

6 Бу үтігінің басын бу үтігі қондырмасына қойыңыз.

Тақтаны орнату

1 Сатып алынған құрылғы үшін қолжетімді бөлшектерге назар аударыңыз.

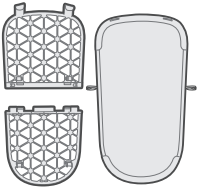

2 Тақта қыстырғыштарын орнына бекітілгенше («сырт» еткен дыбыс шығады) туралап, салыңыз.

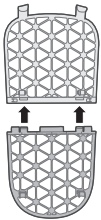

3 Тақта жабынын тақта ілмектеріне сай туралап, салыңыз.

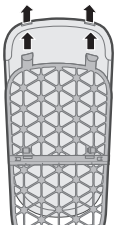

4 Тақта жабынының белдіктерін тақтаның артқы жағындағы ілмектерге іліңіз

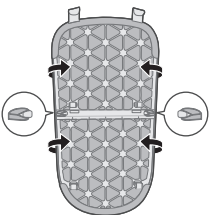

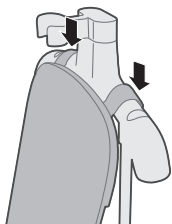

5 Тақтаны ілгішке қойыңыз.

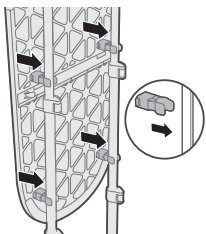

6 Тақтаны орнына бекітілгенше («сырт» еткен дыбыс шығады) тіректерге бекітіңіз.

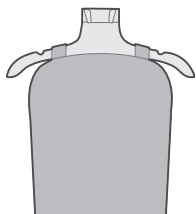

7 Киім ілгішпен киіміңізді іліп алуыңызға болады.

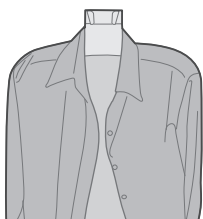

8 Өз ілгішіңізді пайдаланып, оны бу үтігі қондырмасына қоюыңызға болады.

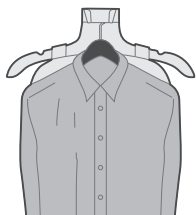

Төсеме қабатын орнату

1 Ортаңғы белдікті бу үтігі қондырмасы арқылы салыңыз.

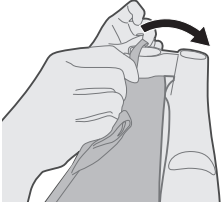

2 3 белдікті ілгіштің артындағы ілгекке бекітіңіз.

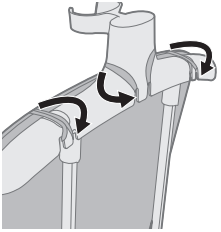

3 Төсеме қабатын орнына салып («сырт» еткен дыбыс шығады), тіректерге бекітіңіз.

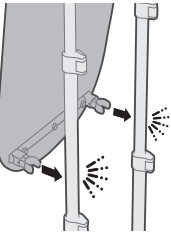

4 Киім ілгішпен киіміңізді іліп алуыңызға болады.

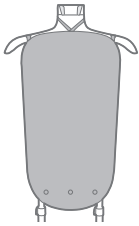



- 5 Өз ілгішіңізді пайдаланып, оны бу үтігі қондырмасына қоюңызға болады.

Щетканы салу

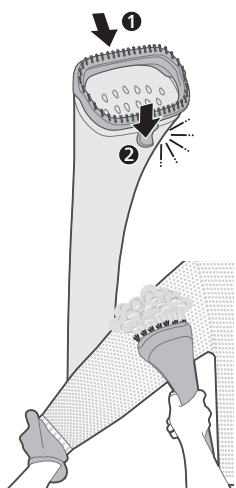

- 1 Бағыттауышты бу үтігінің басының үстіңгі жағымен туралап, астыңғы жағындағы ілмекті бекітіңіз («сырт» еткен дыбыс шығады).

- 2 Қолғап киіп, киімді щетка саптамасы арқылы бумен үтіктеуге болады.

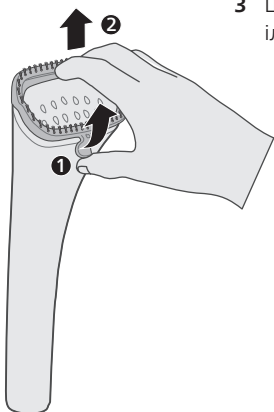

- 3 Щетка саптамасын алу үшін бу үтігінің басының астыңғы жағындағы ілмекті ұстап, тартып шығарыңыз.

Су ыдысын толтыру

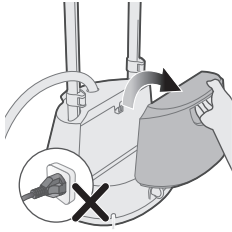

1 Құрылғыны розеткаға қоспаңыз. Су ыдысын тұғырдан шығарып алыңыз.

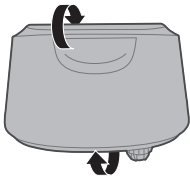

2 Су ыдысының қақпағын жоғары қаратып су ыдысын төңкеріңіз.

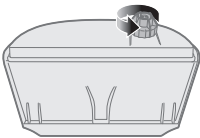

3 Су ыдысының қақпағын сағат тіліне қарсы бұрап алыңыз.

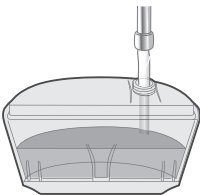

4 Су ыдысын толтырыңыз.

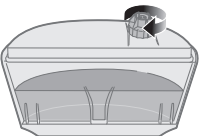

5 Су ыдысының қақпағын сағат тілімен бұрап, қатайтыңыз.

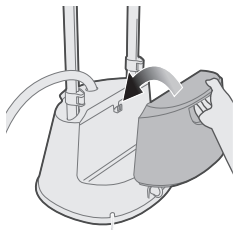

6 Су ыдысын ілмекпен туралап, қайтадан тұғырға қойыңыз.

Бу параметрлерін өзгерту

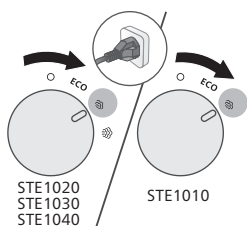

1 Құрылғының розеткаға қосылғанына көз жеткізіңіз. Бу дискісін қажетті бу параметріне бұраңыз.

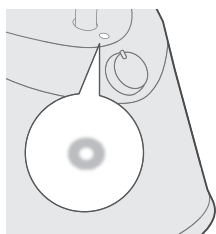

2 Бу үтігі қосылып тұрғанын көрсету үшін шам тұрақты жанып тұрады.

*STE1010/75: ~2 min

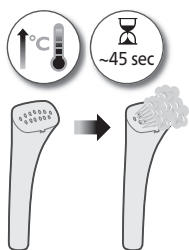

3 Бу үтігі қызып, бу шығарғанша шамамен 45 секунд күтіңіз (STE1010/75: шамамен 2 минут).

Үтіктеу бойынша кеңестер

- 1 Өз ілгішіңізді пайдаланып, оны бу үтігі қондырмасына қоюыңызға болады.

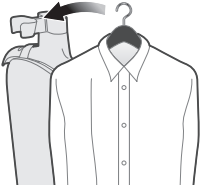

- 2 Бу үтігінің басын жағамен параллель бағытта жылжытыңыз.

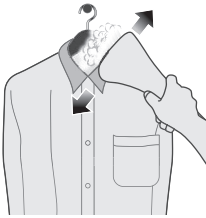

- 3 Бу үтігінің басын иінішпен көлденең бағытта жылжытыңыз.



- 4 Киімді созыңыз. Бу үтігінің басын киімнің алдыңғы жағынан төмен бағытта жылжытыңыз.

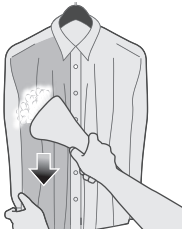

- 5 Бу үтігінің басын қалтадан жоғары бағытта жылжытыңыз.





6 Киімді созыңыз. Бу үтігінің басын киімнің артқы жағынан төмен бағытта жылжытыңыз.

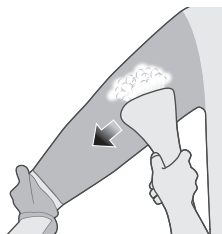

7 Киімді созыңыз. Бу үтігінің басын жеңмен параллель бағытта жылжытыңыз.

Тазалау және күту

Қақ жинағыш

Құрылғыңыз қақ жинағыш жүйесімен жабдықталған. Қақтан тазалау әрекетін айына бір немесе бірнеше рет орындау ұсынылады. Ол бұдың қарқынды берілуіне көмектеседі және уақыт өте келе үтіктің табанынан кір мен дақтардың шығуына жол бермейді.

Кеңес: Қақ жинағыш жүйесін кез келген уақытта пайдалануға болады. Егер суы кермек аймақта тұрсаңыз, функцияны жиі пайдаланыңыз.

Қақ жинау процесін орындау

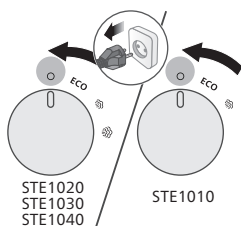

1 Бу дискісінің «ӨШІРУ» күйінде екеніне және құрылғы электр желісінен ажыратылғанына көз жеткізіңіз.

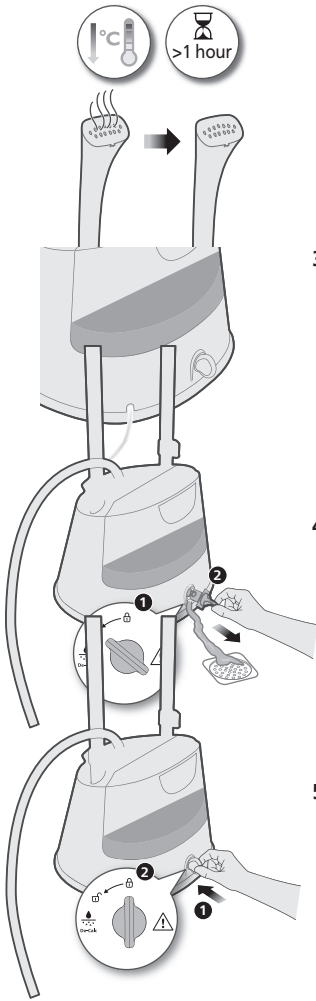

2 Үтіктің толық суығанына көз жеткізіңіз (> 1 сағат).

3 Бу үтігін су төгетін түтікке жақын қойыңыз.

4 Қақтан тазалау тұтқасын құлыпты ашу күйіне бұрап, тұтқаны алыңыз. Суды ағызыңыз.

5 Қақтан тазалау тұтқасын орнына салып, құлыптау күйіне бұраңыз.

Бу үтігін тазалау және сақтау

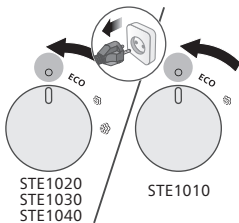

1 Бу дискісінің «ӨШІРУ» күйінде екеніне және құрылғы электр желісінен ажыратылғанына көз жеткізіңіз.

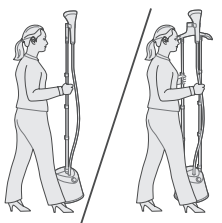
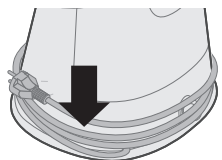
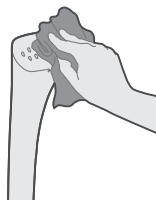
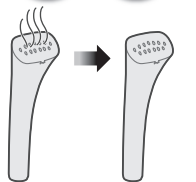

2 Үтіктің толық суығанына көз жеткізіңіз (> 1 сағат).

3 Бу орнын дымқыл шүберекпен сүртіңіз.

4 Су ыдысын толығымен босатыңыз.

5 Қуат сымын корпустың айналасына ораңыз.

6 Бу үтігін тірекпен алып жүруге болады.

Ақаулықтарды табу және жою

Бұл тарауда құралда орын алуы мүмкін ең көп кездесетін ақаулықтар жинақталған. Егер төмендегі ақпараттың көмегімен мәселені шеше алмасаңыз, www.philips.com/support торабына кіріп, жиі қойылатын сұрақтар тізімін қараңыз немесе еліңіздегі тұтынушыларды қолдау орталығына хабарласыңыз.

Мәселе	Ықтимал себебі	Шешімі
Құрылғы бу шығармайды немесе бу тұрақсыз шығады.	Бу үтігі жеткілікті түрде қызбаған.	Құрылғыны шамамен 45 секунд ысытып алыңыз (STE1010/75: шамамен 2 минут).
	Шлангіде бу жиналған.	Шлангті тігінен түзету үшін бу үтігінің басын көтеріңіз. Бұл конденсаттың кері ағып кетуіне мүмкіндік береді.
	Ыдыстағы су деңгейі төмен немесе ыдыс дұрыс салынбаған.	Су ыдысын толтырыңыз және оны дұрыстап жабыңыз.
	Құрылғыда тым көп қақ жиналып қалған.	Қақ кетіру үдерісін орындаңыз. «Қақтан тазалау» бөлімін қараңыз.
Бу үтігінің басынан су тамшылары тамады немесе құрылғыдан құрылдаған дыбыс шығады.	Бу үтігінің басын және/немесе бу беру шлангін көлденең позицияда ұзақ уақыт бойы қалдырғансыз.	Шлангті тігінен түзету үшін бу үтігінің басын көтеріңіз. Бұл конденсаттың кері ағып кетуіне мүмкіндік береді.
	Шланг U пішінді болып иілгенде, шлангтегі конденсат су ыдысына кері қарай ағып кіре алмайды.	Шлангті тігінен түзету үшін бу үтігінің басын көтеріңіз. Бұл конденсаттың кері ағып кетуіне мүмкіндік береді.
Құрал қызып жатқанда судың артық көлемі су үтігінің басынан сыртқа тамшылайды.	Құралдағы су кір немесе құралда ұзақ уақыт тұрған.	Қақ кетіру үдерісін орындаңыз. «Қақтан тазалау» бөлімін қараңыз.
Бу үтігінің түбінен су шығады.	Су ыдысының қақпағын немесе қақтан тазалау қызметі тетігін мықтап жаппағансыз. Су ыдысы дұрыстап салынбаған.	Су ыдысының қақпағын немесе қақтан тазалау тетігін жақсылап жабыңыз. Су ыдысын дұрыстап салыңыз.

Ներածություն

Շնորհավորում ենք գնման կապակցությամբ և բարի գալուստ Philips: Philips-ի առաջարկած աջակցությունից լիարժեք օգտվելու համար գրանցեք ձեր ապրանքն այստեղ՝ www.philips.com/welcome: Սաղքն օգտագործելուց առաջ կարդացեք այս ձեռնարկը, կարևոր տեղեկություններ պարունակող բուկլետը և համառոտ ուղեցույցը: Պահեք դրանք՝ հետագայում օգտվելու համար:

Ապրանքի ընդհանուր բնութագիրը

STE1020, STE1030, STE1040

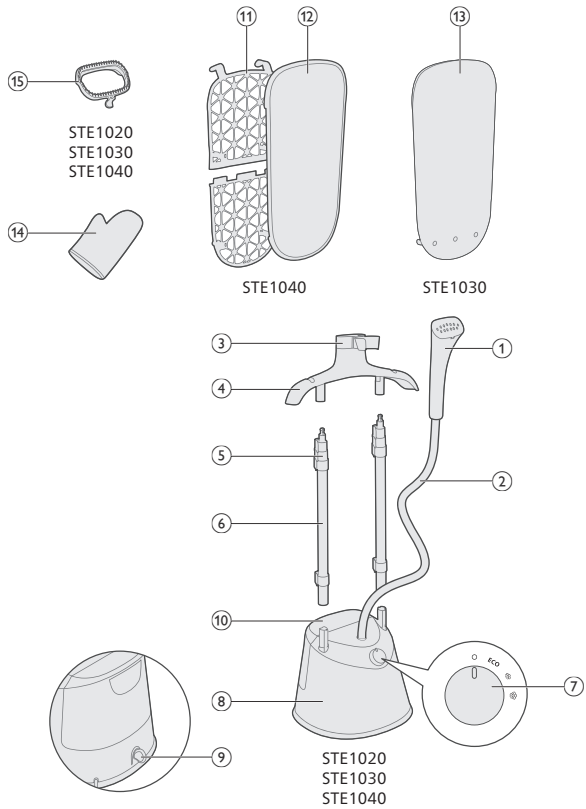

STE1010

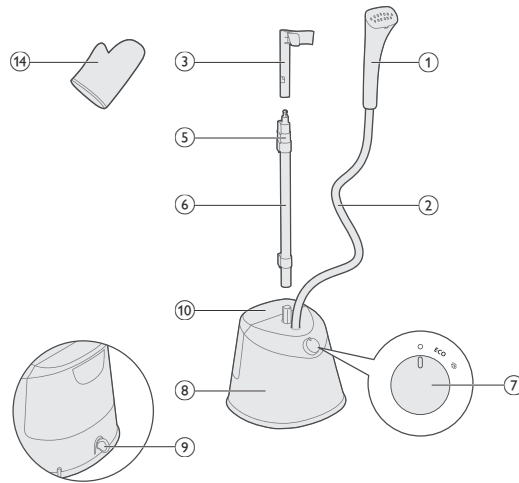

- 1 Շոգեարդուկի գլխիկ
- 2 Գոլորշու մատակարարման ձկափոկ
- 3 Շոգեարդուկի վերին հարթակ
- 4 Կախիչ (STE1020, STE1030, STE1040)
- 5 Հենակների սեղմակ
- 6 Հենակ
- 7 Գոլորշու կարգավորիչ
- 8 Հիմք
- 9 iDe-calc-ի բռնակ
- 10 Ջրի տարա
- 11 Արդուկման սեղան (STE104X)
- 12 Ծածկոց (STE1040)
- 13 Տակդիր (STE1030)
- 14 Ձեռնոց
- 15 Խոզանակ (STE1020, STE1030, STE1040)

Նախապատրաստում

Ինչ տեսակի ջուր պետք է օգտագործել

Սարքը հարմար է ծորակի ջրով օգտագործման համար: Սակայն, եթե դուք ապրում եք այնպիսի տարածքում, որտեղ ջրի կոշտության աստիճանը բարձր է, խորհուրդ ենք տալիս ծորակի ջուրը խառնել թորած կամ դեմիներալիզացված ջրի հետ հավասար քանակությամբ: Դա կկանխի նստվածքի կուտակումը և կերկարացնի սարքի կյանքը:

Մի ավելացրեք օժանելիք, չորանոցի ջուր, քացախ, օսլա, նստվածքի մաքրման, արդուկման օժանդակ միջոցներ, քիմիական միջոցներով մաքրված ջուր կամ քիմիական այլ

նյութեր, քանի որ դրանք կարող են առաջացնել ջրի ցայտեր, շագանակագույն բծեր կամ վնասել ձեր սարքը:

Զգուշացումներ

1 Մի հպեք գուրոշին մաշկի որևէ հատվածին:

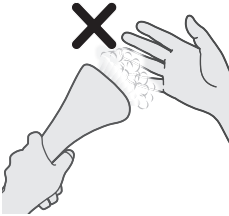

2 Մի ուղղեք շոգեարդուկն այլ մարդկանց ուղղությամբ:



3 Մի պահեք ձեր հագուստը գուրոշու ուղիղ շիթի ներքո:

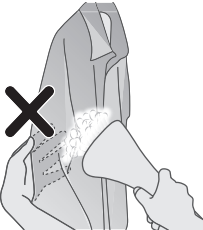

4 Մի օգտագործեք շոգեարդուկի գլխիկը դեպի ներքև ուղղությամբ:

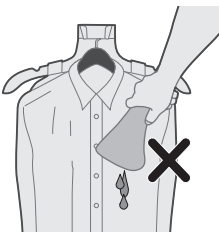



5 Մի ծալեք ձկափուկը՝ հագուստը գոլորշիով արդուկելու համար:

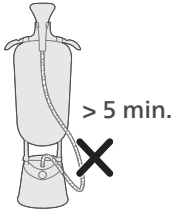

6 Շոգեարդուկը 5 րոպեից ավել առանց հսկողության մի թողեք:

Սարքի կարգաբերում

STE1010

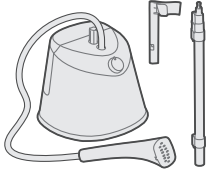

1 Ծանոթացեք ձեր գնած սարքի համար հասանելի մասերի հետ:

STE1020, STE1030
STE1040



2 Բացեք հատակի հենակների սեղմակները և տեղադրեք հենակ(ներ)ը հիմքում: Հանոզվեք, որ հենակ(ներ)ի և հիմքի հենակի գամ(եր)ի պրոֆիլները հավասարեցված լինեն:

624 Հայերեն

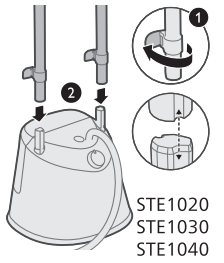
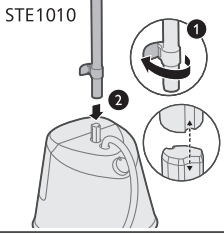

STE1020
STE1030
STE1040

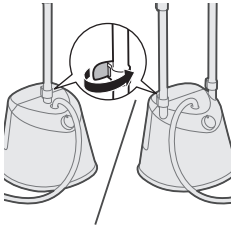

3 Փակեք հատակի հենակի սեղմակ(ներ)ը:

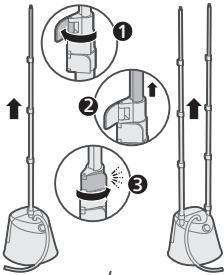

4 Բացեք հենակի մնացած սեղմակները, ամբողջությամբ երկարացրեք հենակ(ներ)ը դեպի վեր և փակեք այն:

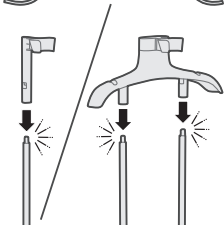

5 Շոգեարդուկի վերին հարթակը տեղադրեք հենակ(ներ)ի վրա և այն իր տեղում ամրացրեք («չխկոց»):

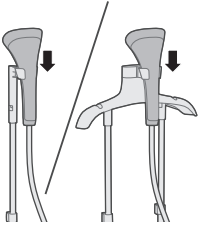

6 Շոգեարդուկի գլխիկը տեղադրեք հարթակի վրա:

Արդուկման սեղանի տեղադրում

1 Ծանոթացեք ձեր գնած սարքի համար հասանելի մասերի հետ:

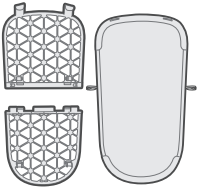

2 Հավասարեցրեք և տեղադրեք սեղանի սեղմակները և այն իր տեղում ամրացրեք («չխկոց»):

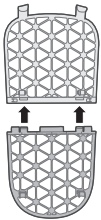

3 Հավասարեցրեք և սեղանի կեռիկների միջով տեղադրեք սեղանի ծածկոցը:

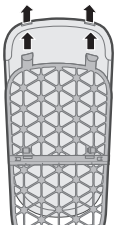

4 Սեղանի ծածկոցի գոտիներն ամրացրեք սեղանի հետևի հատվածում գտնվող կեռիկների վրա:

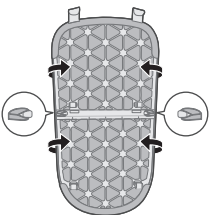

626 Հայերեն

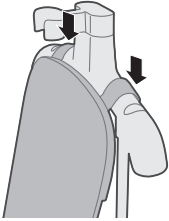

5 Սեղանը տեղադրեք կախիչի վրա:

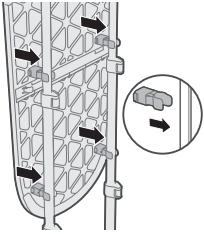

6 Սեղանն ամրացրեք հենակների վրա և այն իր տեղում ամրացրեք («չխկոց»):

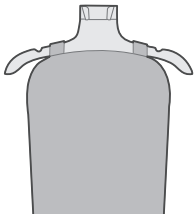

7 Դուք կարող եք կախել ձեր հագուստը կախիչից:

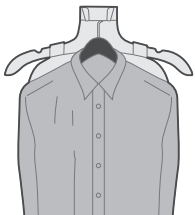
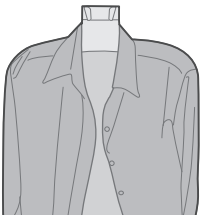

8 Դուք կարող եք օգտագործել ձեր սեփական կախիչը՝ կախելով այն շոգեարդուկի վերին հարթակից:

Տակդիրի տեղադրում

1 Միջին գոտին անցկացրեք շոգեարդուկի վերին հարթակի միջով:

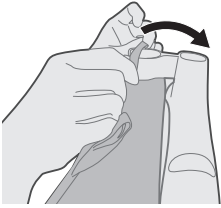

2 3 գոտիներն ամրացրեք կախիչի հետևի մասում գտնվող կեռիկի վրա:

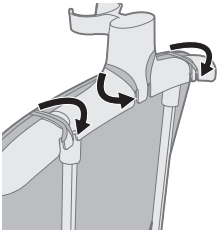

3 Տակդիրն ամրացրեք հենակների վրա («չխկոց»):

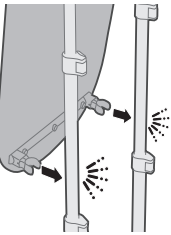

4 Դուք կարող եք կախել ձեր հագուստը կախիչից:

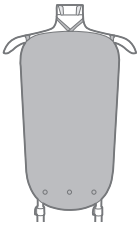



5 Դուք կարող եք օգտագործել ձեր սեփական կախիչը՝ կախելով այն շոգեարդուկի վերին հարթակից:

Խոզանակի տեղադրում

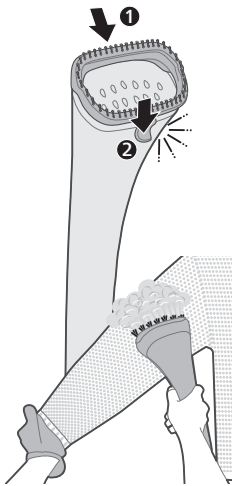

1 Խոզանակը հավասարաչափ տեղադրեք շոգեարդուկի գլխիկի վերին հատվածի երկայնքով և ներքևում սեղմեք բռնակը («չխկոց»):

2 Դուք կարող եք հագնել ձեռնոցը և գլորշիով արդուկել ձեր հագուստը՝ օգտագործելով խոզանակի կցորդը:

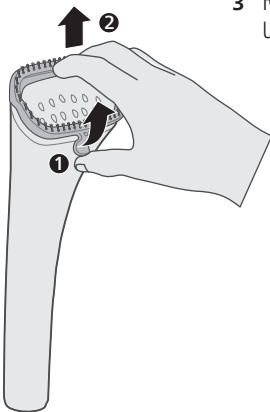

3 Խոզանակի կցորդը հանելու համար շոգեարդուկի գլխիկի տակից բռնեք և դուրս քաշեք բռնակը:

Ջրի տարայի լցնումը

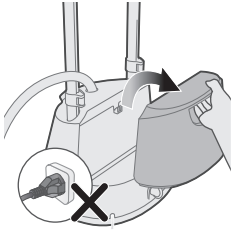

1 Մի միացրեք սարքը: Հանեք ջրի տարան հիմքից:

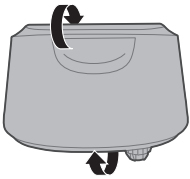

2 Շրջեք ջրի տարան կափույրը դեպի վեր:

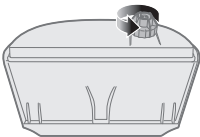

3 Ջրի տարայի կափույրը հանելու համար պտտեք այն ժամացույցի սլաքի հակառակ ուղղությամբ:

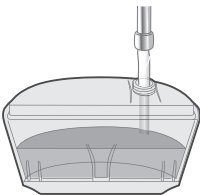

4 Ջուր լցրեք տարայի մեջ:

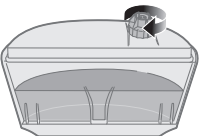

5 Ջրի տարայի կափույրը ամրացնելու համար պտտեք այն ժամացույցի սլաքի ուղղությամբ:

630 Հայերեն

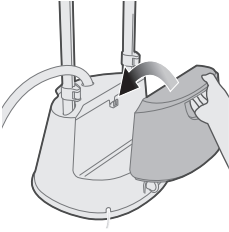

- 6 Ձրի տարան նորից հիմքի վրա տեղադրելու համար հավասարաչափ տեղադրեք այն կեռիկի վրա:

Գոլորշու կարգավորման փոփոխություն

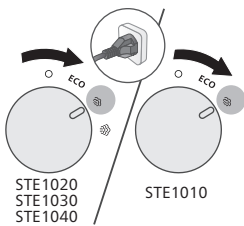

- 1 Համոզվեք, որ սարքը միացված լինի: Պտտեք գոլորշու կարգավորիչը ձեր ցանկացած ջերմաստիճանի վրա:

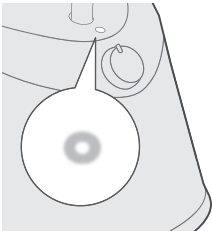

- 2 Լույսը կայուն կդառնա՝ ցույց տալով, որ շոգեարդուկը միացված է:

*STE1010/75: ~2 min

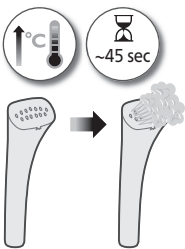

- 3 Սպասեք մոտ 45 վայրկյան, մինչև շոգեարդուկը տաքանա և գոլորշի արձակի (STE1010/75: մոտ 2 րոպե):

Խորհուրդներ արդուկման հետ կապված

- 1 Դուք կարող եք օգտագործել ձեր սեփական կախիչը՝ կախելով այն շոգեարդուկի վերին հարթակից:

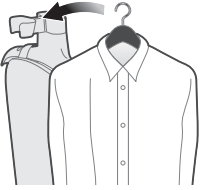

- 2 Օձիքն արդուկելու համար շոգեարդուկի գլխիկը տեղաշարժեք դրա զուգահեռ ուղղությամբ:

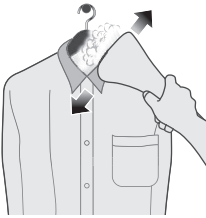

- 3 Ուսահատվածն արդուկելու համար շոգեարդուկի գլխիկը տեղաշարժեք դրա հորիզոնական ուղղությամբ:



- 4 Ձգեք հագուստը: Մարմնի առաջնամասի արդուկման համար շոգեարդուկի գլխիկը տեղաշարժեք դեպի վար:

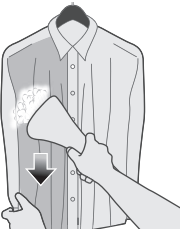

- 5 Գրպանների արդուկման համար շոգեարդուկի գլխիկը տեղաշարժեք դեպի վեր:



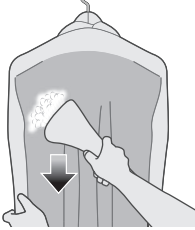

6 Ձգեք հագուստը: Մեջքի հատվածի արդուկման համար շոգեարդուկի գլխիկը տեղաշարժեք դեպի վար:

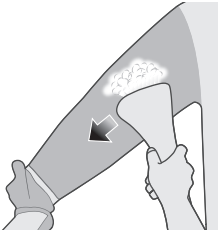

7 Ձգեք հագուստը: Թևերն արդուկելու համար շոգեարդուկի գլխիկը տեղաշարժեք դրանց զուգահեռ ուղղությամբ:

Մաքրում և տեխնիկական սպասարկում

Calc Collector

Ձեր սարքը համարված է Calc Collector համակարգով: Խորհուրդ է տրվում նստվածքի մաքրում կատարել ամիսը մեկ կամ ավելի անգամ: Դա օգնում է պահպանել գոլորշու լավ մատակարարումը և կանխում է, որպեսզի երկար շահագործումից հետո կեղտ և բծեր դուրս գան արդուկի տակի հատվածից:

Խորհուրդ. Calc Collector համակարգը կարող է օգտագործվել ցանկացած ժամանակ: Եթե ապրում եք այնպիսի տարածքում, որտեղ ջրի կոշտության աստիճանը բարձր է, այս ֆունկցիան ավելի հաճախ օգտագործեք:

Նստվածքի մաքրման գործընթացի կատարում

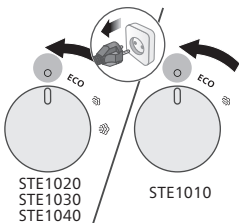

1 Համոզվեք, որ գոլորշու կարգավորիչը գտնվի «OFF/անջատված» դիրքում, իսկ սարքն անջատված լինի հոսանքից:

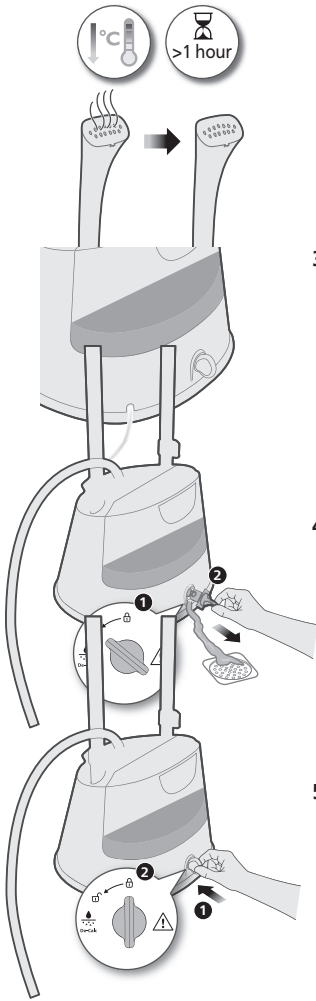

2 Ապասեք մինչև արդուկը լիարժեք սառչի (> 1 ժամ):

3 Շոգեարդուկը դրեք ջրահեռացման մոտ:

4 Թեքեք «De-calc» բռնակը դեպի ապակողպման դիրքը, ապա հանեք «De-calc» բռնակը: Թույլ տվեք, որ ջուրը թափվի:

5 Տեղադրեք և թեքեք «De-calc» բռնակը դեպի կողպման դիրքը:

Շոգեարդուկի մաքրում և պահպանում

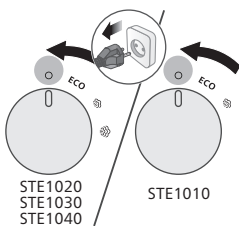

1 Համոզվեք, որ գոլորշու կարգավորիչը գտնվի «OFF/անջատված» դիրքում, իսկ սարքն անջատված լինի հոսանքից:

634 Հայերեն

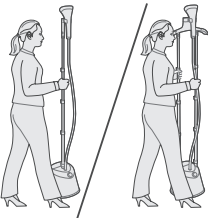
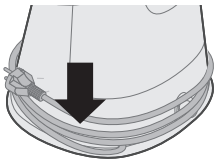
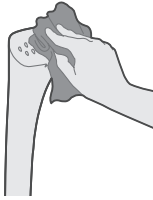
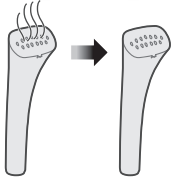

2 Ապասեք մինչև արդուկը լիարժեք սառչի (> 1 ժամ):

3 Սրբեք գոլորշու անցքերը խոնավ շորով:

4 Ամբողջությամբ դատարկեք ջրի տարան:

5 Փաթաթեք հոսանքի լարը հիմքի շուրջ:

6 Դուք կարող եք տանել շոգեարդուկը՝ բռնելով հենակից:

Անսարքությունների ուղղում

Այս գլխում ներկայացված են ամենատարածված խնդիրները, որոնք կարող են հանդիպել սարքի օգտագործման ժամանակ: Եթե չեք կարողանում խնդիրը լուծել ստորև բերված տեղեկատվության օգնությամբ, այցելեք www.philips.com/support հաճախակի տրվող հարցերի համար կամ դիմեք ձեր երկրում գործող Հաճախորդների սպասարկման կենտրոն:

Խնդիր	Չնարավոր պատճառ	Լուծում
Սարքը գուրդի չի մատակարարում կամ անկանոն է մատակարարում:	Շոգեարդուկը բավականաչափ չի տաքացել:	Թողեք, որպեսզի սարքը տաքանա մոտավորապես 45 վայրկյան (STE1010/75 : մոտ 2 րոպե):
	Գուրդը կոնդենսացվել է ձկափոկի ներսում:	Բարձրացրեք շոգեարդուկի գլխիկը՝ ձկափոկն ուղղահայաց դիրքով ուղղելու համար: Այս դիրքում ամբողջ կոնդենսատը նորից կհոսի ջրի տարայի մեջ:
	Տարայի ջրի մակարդակը ցածր է կամ տարան կարգին տեղադրված չէ:	Լցրեք ջրի տարան և այն ձիշտ տեղադրեք:
	Սարքում չափազանց շատ նստվածք է կուտակվել:	Կատարեք նստվածքի մաքրում: Տես Calc-Clean բաժինը:
Շոգեարդուկի գլխիկից ջուր է կաթում, կամ սարքից դլլղոցի ձայն է գալիս:	Շոգեարդուկի գլխիկը և/կամ գուրդը մատակարարման ձկափոկը երկար ժամանակ գտնվել են հորիզոնական դիրքում:	Բարձրացրեք շոգեարդուկի գլխիկը՝ ձկափոկն ուղղահայաց դիրքով ուղղելու համար: Այս դիրքում ամբողջ կոնդենսատը նորից կհոսի ջրի տարայի մեջ:
	Երբ ձկափոկն ընդունում է Ս-աձն տեսք, կուտակված կոնդենսատը չի կարողանում հեռ հոսել ջրի տարայի մեջ:	Բարձրացրեք շոգեարդուկի գլխիկը՝ ձկափոկն ուղղահայաց դիրքով ուղղելու համար: Այս դիրքում ամբողջ կոնդենսատը նորից կհոսի ջրի տարայի մեջ:
Երբ սարքը տաքանում է, շոգեարդուկի գլխիկից չափազանց շատ ջուր է կաթում:	Սարքի ջուրը կեղտոտ է կամ երկար ժամանակ մնացել է սարքի ներսում:	Կատարեք նստվածքի մաքրում: Տես Calc-Clean բաժինը:
Ջրի արտահոսք շոգեարդուկի հիմքից:	Ջրի տարայի կափարիչը փակված չէ կամ De-Calc-ի կափույրը տեղադրված չէ: Ջրի տարան ձիշտ տեղադրված չէ:	Փակեք ջրի տարայի կափարիչը կամ դրեք De-Calc-ի կափույրը: Ձիշտ տեղադրեք տարան:

ข้อมูลเบื้องต้น

ขอแสดงความยินดีที่คุณเลือกซื้อผลิตภัณฑ์ของเรา และยินดีต้อนรับสู่ Philips เพื่อให้คุณได้รับประโยชน์อย่างเต็มที่จากบริการที่ Philips มอบให้ โปรดลงทะเบียนผลิตภัณฑ์ของคุณที่ www.philips.com/welcome โปรดอ่านคู่มือผู้ใช้ เอกสารข้อมูลสำคัญ และคู่มือเริ่มต้นใช้งานอย่างย่อโดยละเอียดก่อนใช้งานผลิตภัณฑ์ และเก็บไว้เพื่ออ้างอิงต่อไป

ภาพรวมของผลิตภัณฑ์

STE1020, STE1030, STE1040

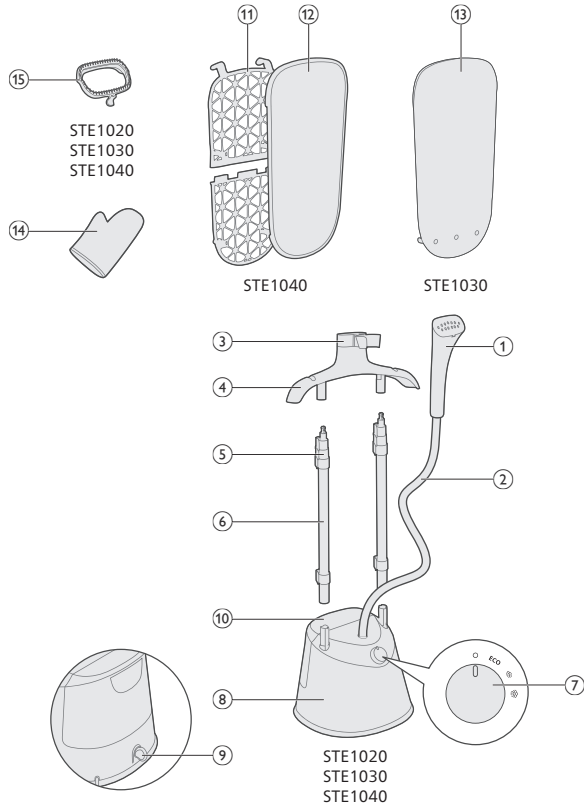

STE1010

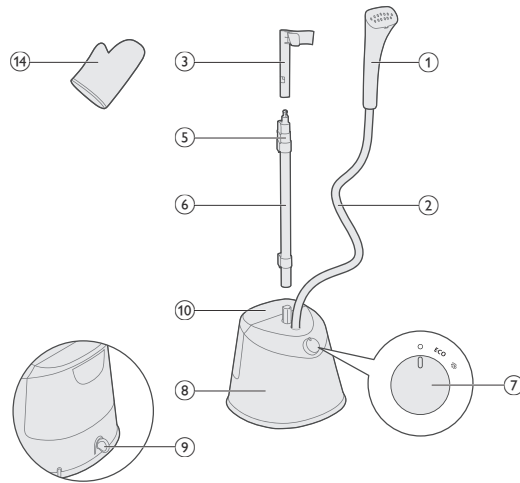

- 1 หัวพ่นไอน้ำ
- 2 สายไอน้ำ
- 3 แท่นวางหัวพ่นไอน้ำ
- 4 ที่แขวน (STE1020, STE1030, STE1040)
- 5 คลิปล็อกคาลา
- 6 เส้า
- 7 ปุ่มควบคุมพลังไอน้ำ
- 8 ฐาน
- 9 ปุ่มขจัดคราบตะกรัน
- 10 แท่งคลื่นน้ำ
- 11 กระจาดรีดผ้า (STE1040)
- 12 ฝาคลุม (STE1040)
- 13 ฝารอง (STE1030)
- 14 ถุงมือ
- 15 แปรง (STE1020, STE1030, STE1040)

การเตรียมตัวก่อนใช้งาน

ชนิดของน้ำที่ใช้งาน

เครื่องเหมาะสำหรับใช้งานกับน้ำประปา อย่างไรก็ตาม

หากคุณอาศัยอยู่ในพื้นที่ที่น้ำกระด้างมาก

เราขอแนะนำให้คุณผสมน้ำประปาในปริมาณที่เท่ากับน้ำกลั่นหรือน้ำประปาจากแร่ธาตุ

ซึ่งจะช่วยป้องกันไม่ให้เกิดตะกรันสะสมอย่างรวดเร็วและยืดอายุการใช้งานของเครื่อง

**อย่าใส่น้ำหอม น้ำจากเครื่องอบผ้า น้ำส้มสายชู แป้ง
น้ำยาขจัดคราบตะกรัน น้ำยารีดผ้าเรียบ
น้ำที่ผ่านการขจัดตะกรันด้วยสารเคมี หรือสารเคมีอื่นๆ
เนื่องจากอาจทำให้น้ำกระเด็น เกิดคราบสีน้ำตาล
หรือทำให้เครื่องเสียหายได้**

คำเตือน

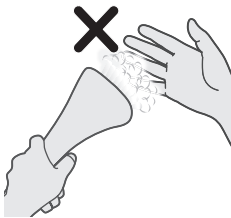

1 อย่าให้ส่วนใดส่วนหนึ่งของผิวหนังสัมผัสกับไอน้ำโดยตรง



2 อย่าหันแผ่นไอน้ำไปทางบุคคลอื่น

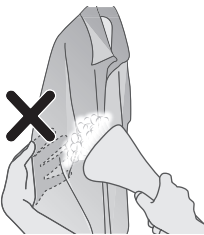

3 อย่าวางเสื้อผ้าในลักษณะที่สัมผัสกับไอน้ำโดยตรง



4 อย่าใช้หัวพ่นไอน้ำในทิศทางลง

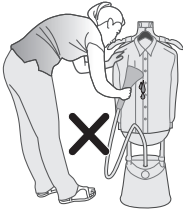

5 อย่างอสายเพื่อปล่อยไอน้ำบนเสื้อผ้า

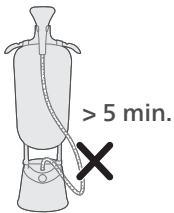

6 อย่าปล่อยเครื่องพ่นไอน้ำตั้งทิ้งไว้นานกว่า 5 นาที

การจัดเตรียมอุปกรณ์

STE1010

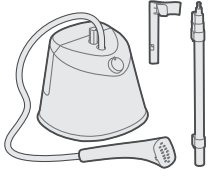

1 จดรายชื่อชิ้นส่วนที่มีให้สำหรับอุปกรณ์ที่คุณซื้อ

STE1020, STE1030
STE1040

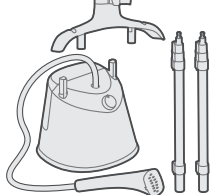

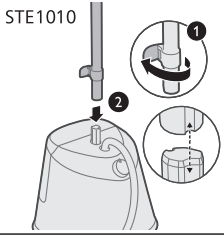

2 ปลดล๊อคคลิปล็อคเสาด้านล่างแล้วสอดเสาเข้ากับฐาน ตรวจสอบให้แน่ใจว่าด้านหน้าของเสาและสลักของเสาฐานอยู่ในแนวเดียวกัน

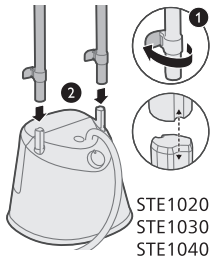

STE1020
STE1030
STE1040

3 ล็อคคลิปล็อคเสาด้านล่าง

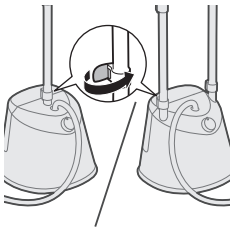

4 ปลดล๊อคคลิปล็อคเสาที่เหลือ ขยายเสาขึ้นจนสุดแล้วล๊อค

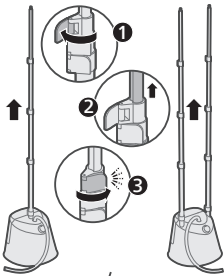

5 ใส่แท่งวางหัวพ่นไอน้ำเข้ากับเสาจนกระทั่งล็อคเข้าที่ ('มีเสียงคลิก')

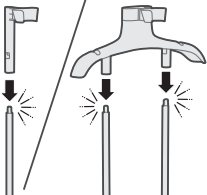

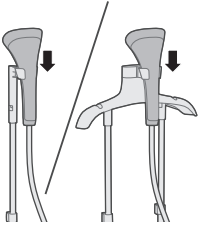

6 วางหัวพ่นไอน้ำไว้บนแท่น

การจัดเตรียมกระดานรีดผ้า

1 จัดรายช่อชั้นส่วนที่มีให้สำหรับอุปกรณ์ที่คุณซื้อ

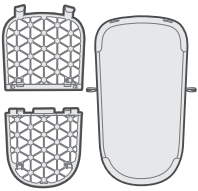

2 จัดตำแหน่งและใส่คลิปกระดานเข้าไปจนกระทั่งล็อกเข้าที่ ('มีเสียงคลิก')

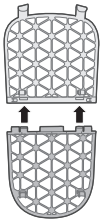

3 จัดแนวและสอดฟ้ารองรีดผ่านตะขอยึดกระดาน

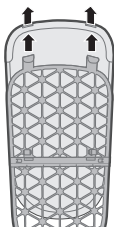

4 เกี่ยวสายรัดฟ้ารองรีดเข้ากับตะขอที่ด้านหลังของกระดาน

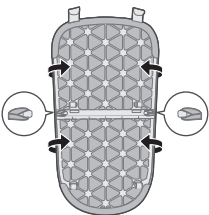

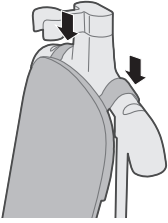

5 วางกระดานไวนั้นที่แขวน

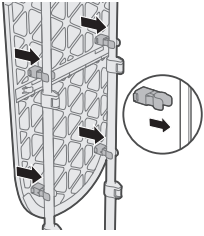

6 ยึดกระดานเข้ากับเสาจนกระทั่งล็อกเข้าที่ ('มีเสียงคลิก')

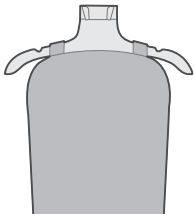

7 คุณสามารถแขวนเสื้อผ้าของคุณโดยใช้ไม้แขวนเสื้อ

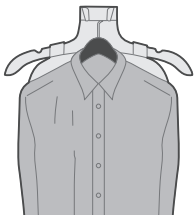
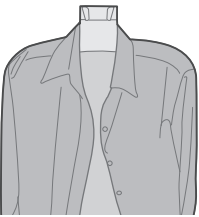

8 คุณสามารถใช้ไม้แขวนเสื้อของคุณเองแล้ววางไวนั้นแทนได้อีกได้

การจัดเตรียมผ้ารอง

1 สอดสายรัดตรงกลางผ่านแท่นวางหัวพ่นไอน้ำ

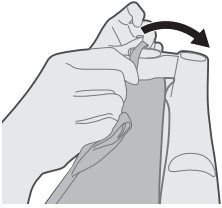

2 ยึดสายรัด 3 เส้นไว้กับตะขอที่ด้านหลังของที่แขวน

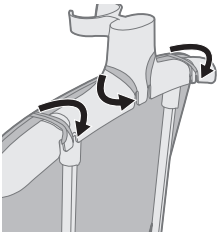

3 ยึดผ้ารองเข้ากับเสาจนกระทั่งล๊อคเข้าที่ ('มีเสียงคลิก')

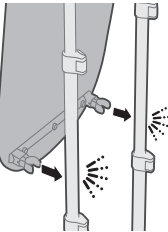

4 คุณสามารถแขวนเสื้อผ้าของคุณโดยใช้ไม้แขวนเสื้อ

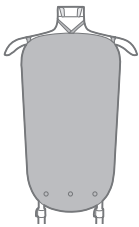



5 คุณสามารถใช้ไม้แขวนเสื้อของคุณเองแล้ววางไว้บนแท่นไอน้ำได้

การใส่แปรง

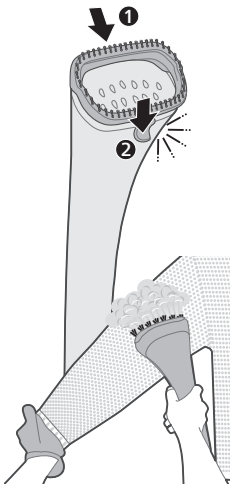

1 จัดแนวรางตามแนวด้านบนบนของหัวพ่นไอน้ำและและติดที่จับด้านล่าง (มีเสียงคลิก)

2 คุณสามารถสวมถุงมือและพ่นไอน้ำเสื้อผ้าของคุณโดยใช้ชุดแปรง

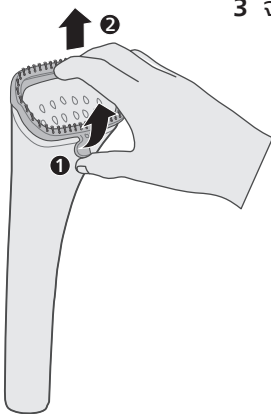

3 จับและดึงที่จับออกจากด้านล่างของหัวพ่นไอน้ำเพื่อถอดชุดแปรงออก

การเติมน้ำลงในแท็งค์

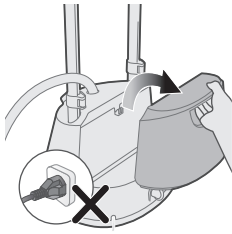

1 อย่าเสียบปลั๊กไฟเครื่อง ถอดแท็งค์น้ำออกจากฐาน

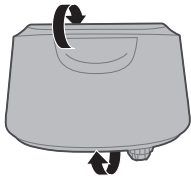

2 พลิกแท็งค์น้ำโดยให้ฝาแท็งค์น้ำหงายขึ้น

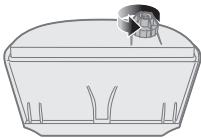

3 คลายเกลียวฝาแท็งค์น้ำทวนเข็มนาฬิกาเพื่อถอดออก

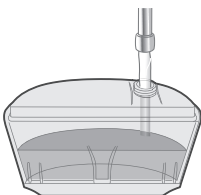

4 เติมน้ำลงในแท็งค์

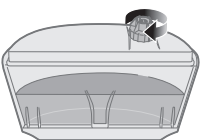

5 ชันฝาแท็งค์น้ำตามเข็มนาฬิกาให้แน่น

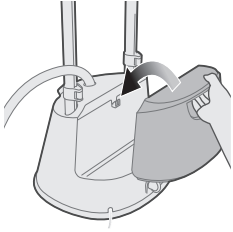

6 จัดตำแหน่งให้ตรงกับตะขอเพื่อวางแท่งค้ำน้ำกลับเข้าที่ฐาน

การเปลี่ยนการตั้งค่าไอน้ำ

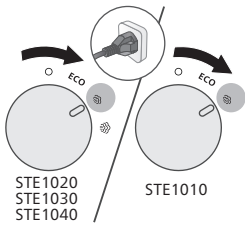

1 ตรวจสอบให้แน่ใจว่าเสียบปลั๊กไฟเครื่องแล้ว
หมุนปุ่มไอน้ำไปยังการตั้งค่าไอน้ำที่ต้องการ

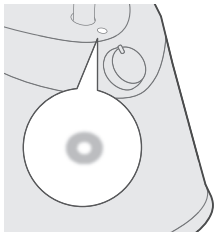

2 ไฟจะติดคงที่เพื่อระบุว่าเครื่องพ่นไอน้ำแบบตั้งเปิดสวิตช์เป็น ON

*STE1010/75: ~2 min

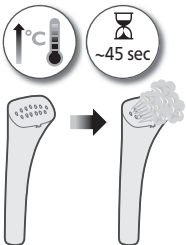

3 รอประมาณ 45 วินาทีเพื่อให้เครื่องนิ่งแบบตั้งพื้นร้อนและปล่อยไอน้ำออกมา (STE1010/75: ประมาณ 2 นาที)

เคล็ดลับการรีดผ้า

1 คุณสามารถใช้ไม้แขวนเสื้อของคุณเองแล้ววางไว้บนแท่นไอน้ำได้

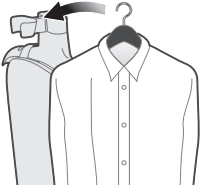

2 ขยับหัวพ่นไอน้ำให้ขนานกับปก

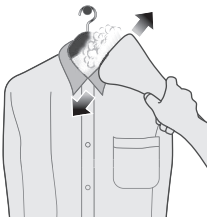

3 ขยับหัวพ่นไอน้ำในแนวนอนกับแอก



4 ยึดเสื้อผ้า ขยับหัวพ่นไอน้ำลงด้านหน้าลำตัว

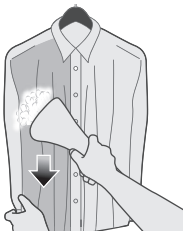

5 ขยับหัวพ่นไอน้ำขึ้นบนกระเป๋าสีเสื้อ



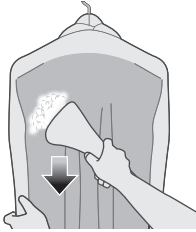

6 ยึดเสื้อผ้า ขยับหัวพ่นไอน้ำลงด้านหลังลำตัว

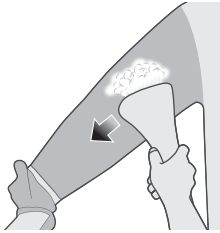

7 ยึดเสื้อผ้า ขยับหัวพ่นไอน้ำให้ขนานกับแขนเสื้อ

การทำความสะอาดและบำรุงรักษา

ที่เก็บตะกรัน

เครื่องใช้ไฟฟ้าของคุณได้รับการออกแบบด้วยระบบที่เก็บตะกรัน
ขอแนะนำให้ทำการขจัดตะกรันเดือนละครั้งขึ้นไป
ซึ่งจะช่วยรักษาประสิทธิภาพไอน้ำทรงพลัง
และป้องกันสิ่งสกปรกและคราบสกปรกที่ออกมาจากแผ่นความร้อนตลอด
เวลา

เคล็ดลับ: สามารถใช้ระบบที่เก็บตะกรันได้ตลอดเวลา
หากคุณอาศัยอยู่ในบริเวณที่มีน้ำกระด้าง ให้ใช้ฟังก์ชันนี้อย่างสม่ำเสมอ

การเริ่มกระบวนการขจัดคราบตะกรัน

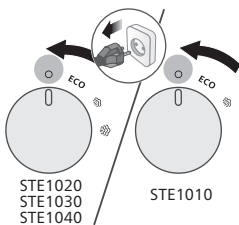

1 ตรวจสอบให้แน่ใจว่าปุ่มหมุนไอน้ำอยู่ที่ตำแหน่ง OFF
และถอดปลั๊กไฟเครื่องแล้ว

2 ตรวจสอบให้แน่ใจว่าเตารีดเย็นลงอย่างสมบูรณ์แล้ว (> 1 ชั่วโมง)



3 วางเครื่องพ่นไอน้ำไว้ใกล้กับท่อระบายน้ำ

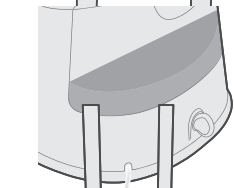

4 หมุนปุ่มขจัดคราบตะกรันไปที่ตำแหน่งปลดล็อก และถอดปุ่มขจัดคราบตะกรันออก ปล่อยให้ไอน้ำระบายออก

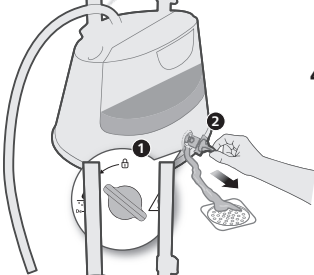

5 ใส่และหมุนปุ่มขจัดคราบตะกรันไปที่ตำแหน่งล็อก

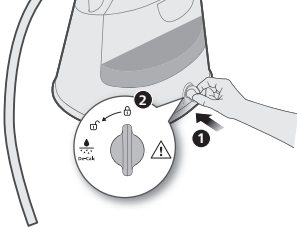

การทำความสะอาดและการจัดเก็บเครื่องพ่นไอน้ำแบบตั้งพื้น

1 ตรวจสอบให้แน่ใจว่าปุ่มหมุนไอน้ำอยู่ที่ตำแหน่ง OFF และถอดปลั๊กไฟเครื่องแล้ว

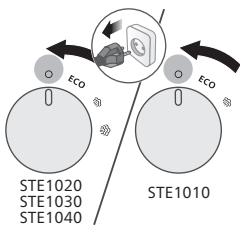

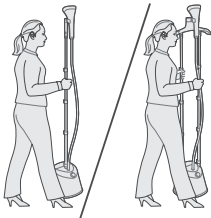
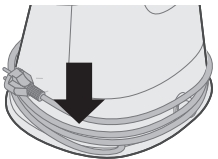
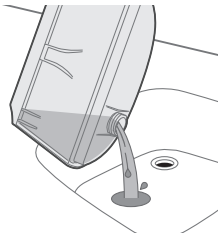
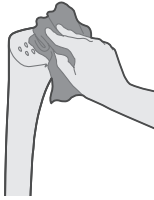
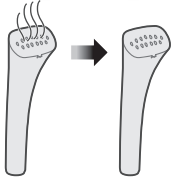

2 ตรวจสอบให้แน่ใจว่าเตารีดเย็นลงอย่างสมบูรณ์แล้ว (> 1 ชั่วโมง)

3 เช็ดบริเวณที่มีไอน้ำด้วยผ้าชุบน้ำหมาดๆ

4 เทน้ำออกจากแท่งค้ำให้หมด

5 พันสายไฟรอบฐาน

6 คุณสามารถถือเครื่องพ่นไอน้ำแบบตั้งข้างเสาดได้

การแก้ไขปัญหา

ในบทนี้ เราได้รวบรวมปัญหาต่างๆ ที่อาจเกิดขึ้นกับเครื่องได้ หากคุณไม่สามารถแก้ไขปัญหาด้วยข้อมูลด้านล่างได้ โปรดดูรายการคำถามที่พบบ่อยที่ www.philips.com/support หรือติดต่อศูนย์บริการลูกค้าในประเทศของคุณ

ปัญหา	สาเหตุที่เป็นไปได้	วิธีแก้ปัญหา
เครื่องไม่ผลิตไอน้ำหรือพ่นไอน้ำผิดปกติ	หัวพ่นไอน้ำยังร้อนไม่พอ	ปล่อยให้เครื่องทำความร้อนประมาณ 45 วินาที (STE1010/75: ประมาณ 2 นาที)
	ไอน้ำควบแน่นเป็นหยดน้ำในสายไอน้ำ	ยกหัวพ่นไอน้ำขึ้นเพื่อให้สายอยู่ในแนวตั้ง การทำเช่นนี้จะทำให้การกลั่นตัวเป็นหยดน้ำที่เกิดขึ้นไหลย้อนกลับไป
	ระดับน้ำในแท็งก์ต่ำหรือใส่แท็งก์น้ำไม่ถูกต้อง	เติมน้ำในแท็งก์น้ำแล้วใส่แท็งก์ให้ถูกต้อง
	มีตะกอนสะสมตัวอยู่ในเครื่องมากเกินไป	เริ่มกระบวนการขจัดคราบตะกอน โปรดดูส่วนขจัดคราบตะกอน
น้ำหยดออกจากหัวพ่นไอน้ำหรือเครื่องมีเสียงดัง	คุณปล่อยให้หัวพ่นไอน้ำและ/หรือสายไอน้ำอยู่ในตำแหน่งแนวขวางเป็นเวลานาน	ยกหัวพ่นไอน้ำขึ้นเพื่อให้สายอยู่ในแนวตั้ง การทำเช่นนี้จะทำให้การกลั่นตัวเป็นหยดน้ำที่เกิดขึ้นไหลย้อนกลับไป
	เมื่อสายไอน้ำมีวนเป็นรูปตัว U หยดน้ำที่เกิดจากการควบแน่นในสายไอน้ำจะไม่สามารถไหลย้อนกลับลงไปในแท็งก์น้ำได้	ยกหัวพ่นไอน้ำขึ้นเพื่อให้สายอยู่ในแนวตั้ง การทำเช่นนี้จะทำให้การกลั่นตัวเป็นหยดน้ำที่เกิดขึ้นไหลย้อนกลับไป

มีน้ำหยดออกจากหัวพ่นไอน้ำ- น้ำในแท่งคัสกปรกหรือทิ้งไว้เป็น- เริ่มกระบวนการขจัดคราบตะกรัน
ากเกินไปเมื่อเครื่องกำลังทำงาน- นเวลานาน น โปรตดูส่วนขจัดคราบตะกรัน
ามร้อน

น้ำรั่วออกมาจากฐานเครื่องพ่น- คุณไม่ได้ปิดฝาแท่งคัสกหรือปุ่ม- ปิดฝาแท่งคัสกน้ำหรือปุ่ม De-Calc
ไอน้ำ De-Calc ปิดไม่แน่น ให้แน่น ประกอบแท่งคัสกให้เข้าที่
ใส่แท่งคัสกน้ำไม่ถูกต้อง

შესავალი

მოგესალმებით Philips და გილოცავთ ახალ შენაძენს! Philips-ის მხარდაჭერით სრულად სარგებლობისთვის თქვენი პროდუქტი დაარეგისტრირეთ აქ: www.philips.com/welcome. მონყობილობის გამოყენებამდე ყურადღებით წაიკითხეთ წინამდებარე მომხმარებლის სახელმძღვანელო, მნიშვნელოვანი საინფორმაციო ბროშურა და მოკლე პრაქტიკული სახელმძღვანელო. შეინახეთ იგი მომავალში გამოსაყენებლად.

პროდუქტის აღწერა

STE1020, STE1030, STE1040

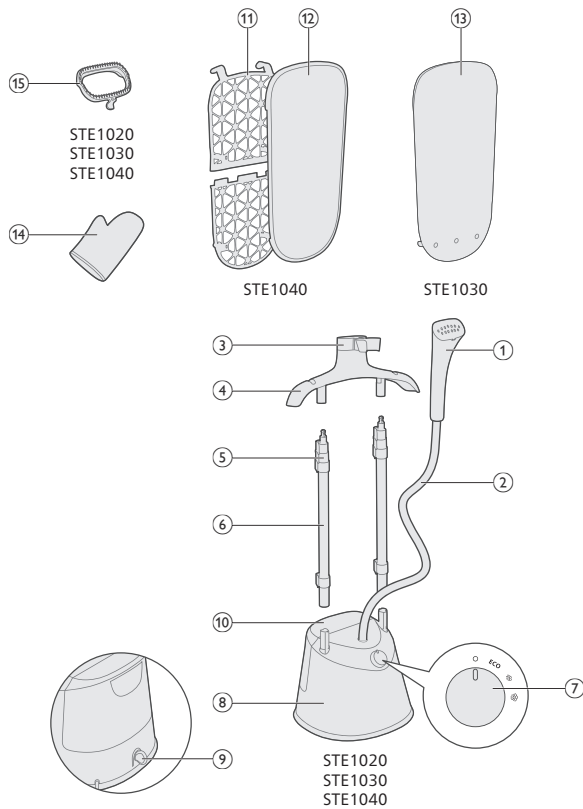

STE1010

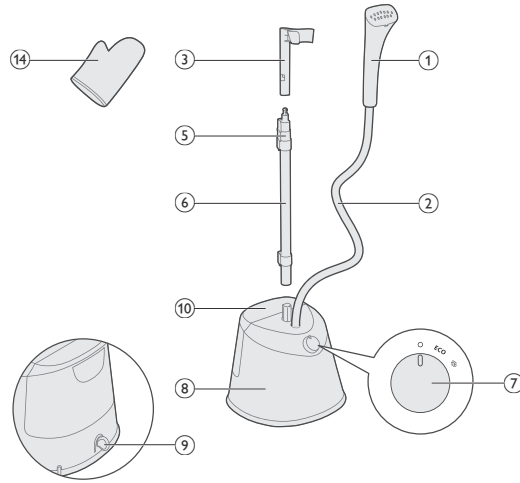

- 1 ორთქლის უთოს თავი
- 2 ორთქლის მისაწოდებელი მილი
- 3 ორთქლის უთოს სადგამი
- 4 საკიდი (STE1020, STE1030, STE1040)
- 5 დგარის მომჭერი
- 6 დგარი
- 7 ორთქლის ციფერბლატი
- 8 ძირი
- 9 ნადების მოცილების ღილაკი
- 10 წყლის რეზერვუარი
- 11 დაფა (STE1040)
- 12 შალითა (STE1040)
- 13 საფენი (STE1030)
- 14 ხელთათმანი
- 15 ჯაგრისი (STE1020, STE1030, STE1040)

გამოსაყენებლად მომზადება

გამოსაყენებელი წყლის ტიპი

მონყობილობაში დასაშვებია ონკანის წყლის გამოყენება. თუმცა, თუ ხისტი წყლის მქონე რეგიონში ცხოვრობთ, რეკომენდებულია ონკანის წყლისა და გამოხდილი ან დემინერალიზებული წყლის თანაბარი ოდენობებით მიღებული ნარევის გამოყენება. ეს დაგეხმარებათ ნალექის დაგროვების თავიდან აცილებაში და მონყობილობის მუშაობის ვადას გაახანგრძლივებს.

არ დაამატოთ სუნამო, საშრობის წყალი, ძმარი, სახამებელი, ნალექისგან გამწმენდი საშუალებები, დაუთოების დამხმარე საშუალებები, ნალექისგან ქიმიურად გასუფთავებული წყალი ან სხვა ქიმიური ნივთიერებები, რადგან ამან შეიძლება

გამოიწვიოს წყლის გაჟონვა, ყავისფრად დალაქავება ან მოწყობილობის დაზიანება.

ყურადღება:

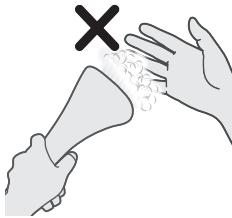

1 მოარიდეთ კანის ნებისმიერი ნაწილი ორთქლთან პირდაპირ კონტაქტს.



2 არ მიმართოთ ორთქლის ფირფიტა სხვა ადამიანების მიმართულებით.

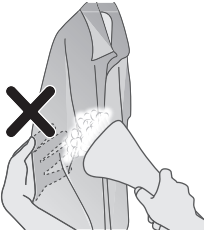

3 არ დაიჭიროთ ტანისამოსი იმგვარად, რომ ორთქლთან პირდაპირ კონტაქტში იყოს.

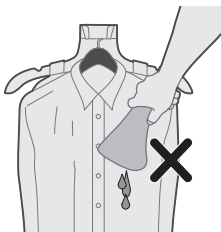

4 არ გამოიყენოთ ორთქლის უთოს თავი ქვემო მიმართულებით.



5 არ მოხაროთ ორთქლის შემყვანი მილი ტანსაცმლის დასაუთოვებლად.

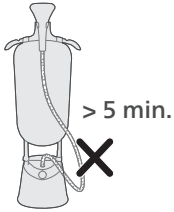

6 არ დატოვოთ ვერტიკალურ მდგომარეობაში მყოფი ორთქლის უთო უყურადღებოდ 5 წუთზე მეტი დროის მანძილზე.

მონყობილობის დამონტაჟება

STE1010

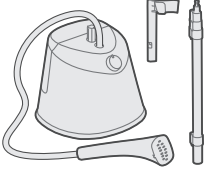

1 მიაქციეთ ყურადღება იმ ნაწილებს, რომელიც ხელმისაწვდომია თქვენს მიერ შექმნილი მონყობილობისთვის.

STE1020, STE1030
STE1040



2 გასხენით ქვედა დგარის მომჭერები და დაამაგრეთ დგარ(ებ)ი ძირზე. დარწმუნდით, რომ დგარ(ებ)ის პროფილები და ძირის დგარ(ებ)ი გასწორებულია.

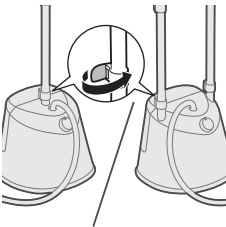
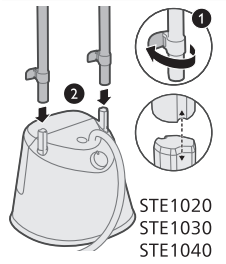
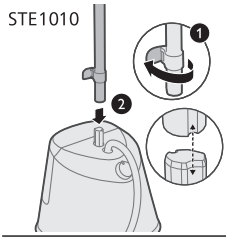

3 ჩაკეტეთ ქვედა დგარის მომჭერ(ებ)ი.

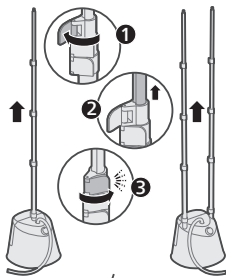

4 გახსენით დანარჩენი დგარის მომჭერების, სრულად გაშალეთ დგარ(ები) ზემოთ და ჩაკეტეთ ის.

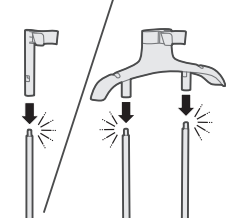

5 ჩასვით ორთქლის უთოს სადგამი დგარ(ებ)ში, სანამ ის ადგილზე არ დაფიქსირდება („დანაკაპუნებამდე“).

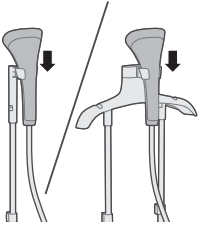

6 მოათავსეთ ორთქლის უთოს თავი ორთქლის უთოს სადგამზე.

დაფის დამონტაჟება

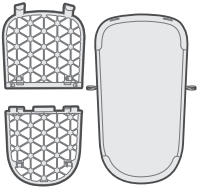

1 მიაქციეთ ყურადღება იმ ნაწილებს, რომელიც ხელმისაწვდომია თქვენს მიერ შექმნილი მოწყობილობისთვის.

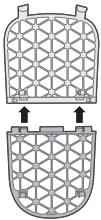

2 გაასწორეთ და ჩასვით დაფის მომჭერების, სანამ ისინი ადგილზე არ დაფიქსირდება („დანაკაპუნებამდე“).

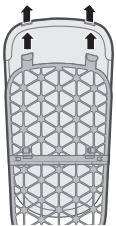

3 გაასწორეთ და დაამაგრეთ დაფის შალითა დაფის კაუჭებზე.

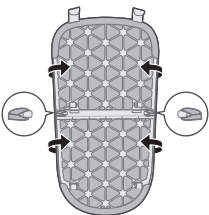

4 დაამაგრეთ დაფის შალითის თასმები დაფის უკან არსებულ კაუჭებზე.

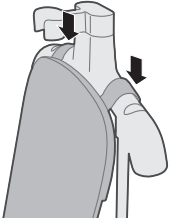

5 მოათავსეთ დაფა საკიდზე.

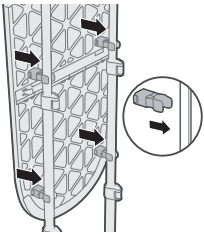

6 გაამაგრეთ დაფა დგარებზე, სანამ ისინი ადგილზე არ დაფიქსირდება („დანაკაპუნებამდე“).

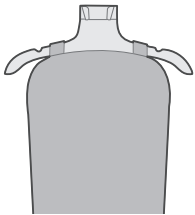

7 ტანსაცმლის დაუთოვება საკიდზე შეგიძლიათ.

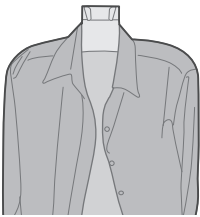

8 შეგიძლიათ სხვა საკიდის გამოყენება და ორთქლის უთოს სადგამზე მოთავსება.

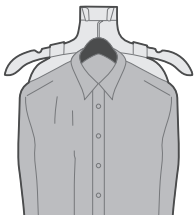

საფენის დამონტაჟება

1 შუა თასმა ორთქლის უთოს სადგამს შორის ჩასვით.

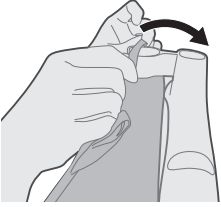

2 გამაგრეთ 3 თასმა საკიდის უკან არსებულ კაუჭზე.

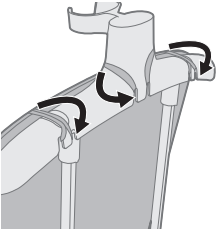

3 გამაგრეთ საფენი დგარებზე, სანამ ისინი ადგილზე არ დაფიქსირდება („დანაკაპუნებამდე“).

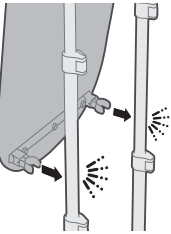

4 ტანსაცმლის დაუთოვება საკიდზე შეგიძლიათ.

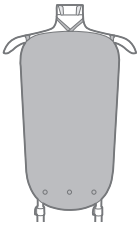



- 5 შეგიძლიათ სხვა საკიდის გამოყენება და ორთქლის უთოს სადგამზე მოთავსება.

ჯაგრისის ჩასმა

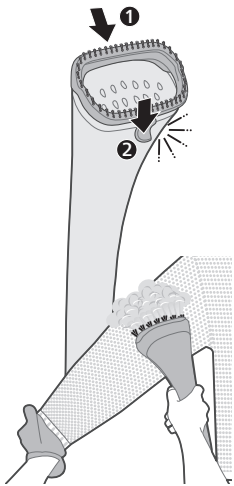

- 1 გაასწორეთ ბილიკი ორთქლის უთოს თავის ზემოთ და ქვედა საკეტი ჩაკეტეთ („დანაკაპუნებამდე“).

- 2 შეგიძლიათ გეცვათ ხელთათმანი და ტანსაცმელი ჯაგრისის სამარჯვით დააუთოვოთ.

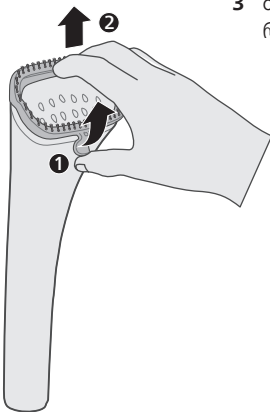

- 3 მოუჭერით და გამოწიეთ საკეტი ორთქლის უთოს თავის ქვემოდან, რათა ჯაგრისის სამარჯვი მოაშოროთ.

წყლის რეზერვუარის შევსება

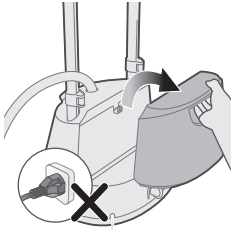

1 არ შეაერთოთ მოწყობილობა ელექტროქსელში. ძირიდან მოხსენით წყლის რეზერვუარი.

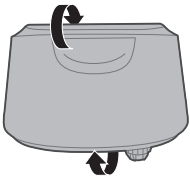

2 გადააბრუნეთ წყლის რეზერვუარი ზევით მიმართული წყლის რეზერვუარის თავსახურით.

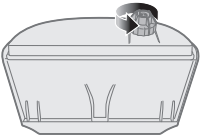

3 მოხსენით წყლის რეზერვუარის თავსახური საათის ისრის საწინააღმდეგო მიმართულებით დატრიალებით.

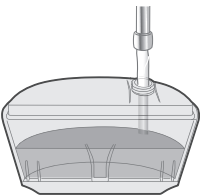

4 შეავსეთ წყლის რეზერვუარი.

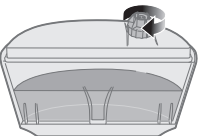

5 დაატრიალეთ წყლის ავზის თავსახური საათის ისრის მიმართულებით მის დასახურად

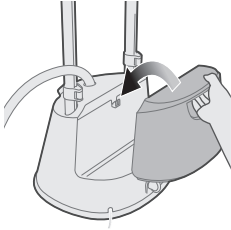

6 გაუსწორეთ კაუჭს, რათა წყლის რეზერვუარი ისევ ბაზაზე მოათავსოთ.

ორთქლის მიწოდების პარამეტრების შეცვლა

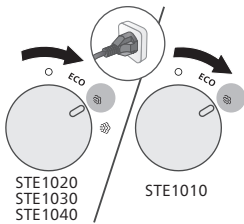

1 დარწმუნდით, რომ მოწყობილობა შეერთებულია ელექტროქსელში. დაატრიალეთ ორთქლის ციფერბლათი სასურველ ორთქლის პარამეტრზე.

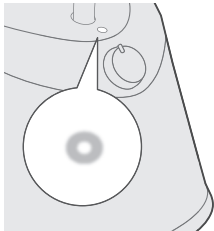

2 ინდიკატორი მუდმივად იქნება ჩართულ, რაც მიუთითებს, რომ ორთქლის უთოს სადგამი ჩართულია.

*STE1010/75: ~2 min

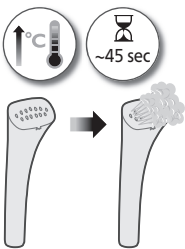

3 დაელოდეთ დაახლოებით 45 წამი, სანამ ორთქლის უთო გახურდება და ორთქლს გამოყოფს (STE1010/75: დაახლოებით 2 წუთი).

უთოობის რჩევები

- 1 შეგიძლიათ სხვა საკიდის გამოყენება და ორთქლის უთოს სადგამზე მოთავსება.

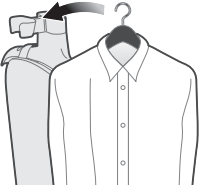

- 2 ამოძრავეთ ორთქლის უთოს თავი საყელოს პარალელური მიმართულებით.

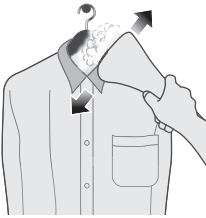

- 3 ამოძრავეთ ორთქლის უთოს თავი საყელოსთან პორიზონტალური მიმართულებით.



- 4 გაჭიმეთ ტანისამოსი. ამოძრავეთ ორთქლის უთოს თავი ქვემო მიმართულებით სხეულის წინა მხარეს.

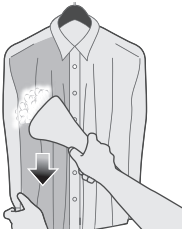

- 5 ამოძრავეთ ორთქლის უთოს თავი ჯიბეზე ზემო მიმართულებით.



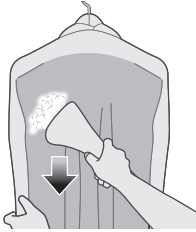

6 გაჭიმეთ ტანისამოსი. ამოძრავეთ ორთქლის უთოს თავი ქვემო მიმართულებით ზურგის მხარეს.

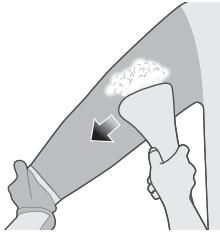

7 გაჭიმეთ ტანისამოსი. ამოძრავეთ ორთქლის უთოს თავი სახელოს პარალელური მიმართულებით.

გასუფთავება და მოვლა-შენახვა

ნადების შემგროვებელი

მონყობილობას აქვს ნადების შემგროვებელი სისტემა. რეკომენდებულია, თვეში ერთხელ ან მეტჯერ ჩაატაროთ ნადების მოშორების პროცედურა. ეს გვეხმარება ორთქლის მიწოდების ეფექტურობის შენარჩუნებაში, და დროთა განმავლობაში ნადებისგან ნაწილაკების და უთოს ძირის ნახვრეტებიდან ჭუჭყის გამოსვლის თავიდან არიდებაში.

რჩევა: ნადების შემგროვებელი სისტემის გამოყენება შესაძლებელია ნებისმიერ დროს. თუ თქვენს რეგიონში ხისტი წყალია, გამოიყენეთ ფუნქცია უფრო ხშირად.

ნადების მოცილების პროცესის შესრულება

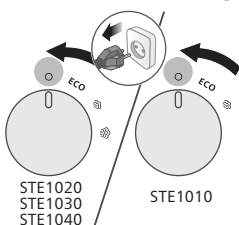

1 დარწმუნდით, რომ ორთქლის ციფერბლატი გამორთულ პოზიციაშია და მონყობილობა დენის წყარონ გამოერთებულია.

666 ქართული ენა

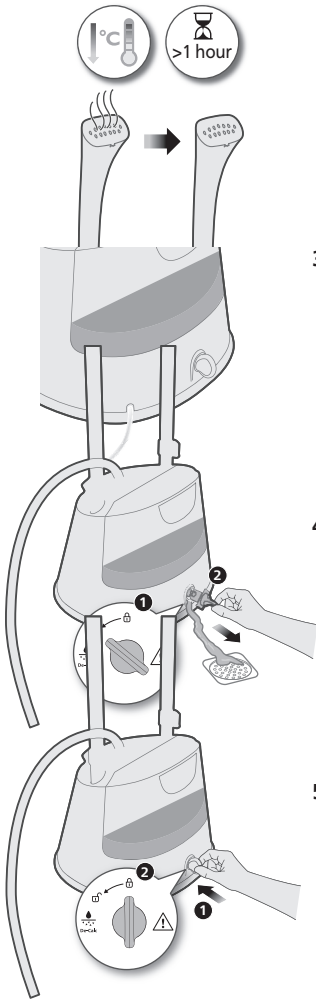

2 დარწმუნდით, რომ უთო მთლიანად გაგრილდა (> 1 საათის განმავლობაში).

3 მოათავსეთ ორთქლის უთო წყალსადინართან ახლოს.

4 გადაატრიალეთ ნადების მოშორების ღილაკი განბლოკვის პოზიციაზე და მოხსენით ნადების მოშორების ღილაკი. დააცადეთ სანამ წყალი არ გამოვა.

5 ჩასვით და გადაატრიალეთ ნადების მოშორების ღილაკი ჩაკეტვის პოზიციაზე.

ორთქლის უთოს განმენდა და შენახვა

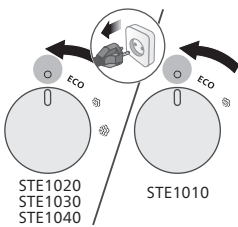

1 დარწმუნდით, რომ ორთქლის ციფერბლათი გამორთულ პოზიციაშია და მოწყობილობა დენის წყარონ გამოერთებულია.

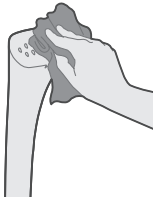
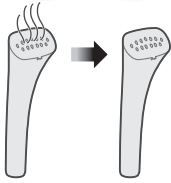

2 დარწმუნდით, რომ უთო მთლიანად გაგრილდა (> 1 საათის განმავლობაში).

3 განმინდეთ ორთქლის ადგილი ნოტიო ქსოვილით.

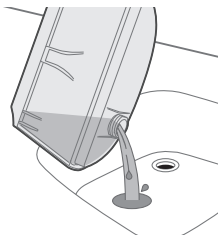

4 სრულად დაცალეთ წყლის რეზერვუარი.

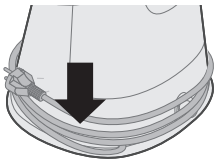

5 შემოახვიეთ დენის კაბელი ძირის გარშემო.

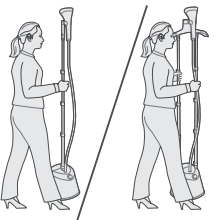

6 ორთქლის უთოს ტარება ბოძით შეგიძლიათ.

პრობლემის აღმოფხვრა

ამ თავში შეჯამებულია ყველაზე გავრცელებული პრობლემები, რომლებსაც მოწყობილობის გამოყენებისას შეიძლება შეხვდეთ. თუ პრობლემას ვერ აგვარებთ ქვემოთ მოცემული ინფორმაციით, ენჯიეთ გვერდს www.philips.com/support ხშირად დასმული კითხვების სისთვის ან დაუკავშირდით მომხმარებელზე ზრუნვის ცენტრს თქვენს ქვეყანაში.

პრობლემა	შესაძლო მიზეზი	გადაწყვეტა
მოწყობილობა არ წარმოქმნის ორთქლს ან არათანაბარ ორთქლს.	ორთქლის უთო საკმარისად არ ცხელდება.	დაელოდეთ მოწყობილობის გაცხელებას დაახლოებით 45 წამი (STE1010/75: დაახლოებით 2 წუთი).
	ორთქლი კონდენსირებულია შლანგში.	ასწიეთ ორთქლის უთოს თავი და ვერტიკალურ მდგომარეობაში გაასწორეთ მილი. ეს ნებისმიერ კონდენსაციას უკან გადინების საშუალებას აძლევს.
	რეზერვუარში წყალი არასაკმარისია ან რეზერვუარი სათანადოდ არ დამონტაჟებულია.	ხელახლა შეავსეთ რეზერვუარი წყლით და დააყენეთ სათანადოდ.
	ძალიან დიდი რაოდენობით დაგროვდა მოწყობილობაში.	შეასრულეთ ნადების მოცილების პროცესი. გაეცანით თავს Calc-Clean.
ორთქლის უთოს თავიდან წყალი მოწვეთავს ან მოწყობილობა ბუხბუყის ხმას გამოსცემს.	თქვენ დიდი ხნის განმავლობაში დატოვებთ ორთქლის უთოს თავი და/ან ორთქლის მიწოდების შლანგი ჰორიზონტალურ მდგომარეობაში.	ასწიეთ ორთქლის უთოს თავი და ვერტიკალურ მდგომარეობაში გაასწორეთ მილი. ეს ნებისმიერ კონდენსაციას უკან გადინების საშუალებას აძლევს.
	როცა შლანგს აქვს „U“ ფორმა, კონდენსაციას შლანგში არა აქვს წყლის ავზში გადინების საშუალება.	ასწიეთ ორთქლის უთოს თავი და ვერტიკალურ მდგომარეობაში გაასწორეთ მილი. ეს ნებისმიერ კონდენსაციას უკან გადინების საშუალებას აძლევს.

როდესაც მოწყობილობა თბება, დიდი რაოდენობით წყალი ამოდის ორთქლის უთოს თავიდან.

მოწყობილობაში წყალი ჭუჭყიანია ან დიდი ხნის განმავლობაში დარჩა მოწყობილობაში.

შეასრულეთ ნადების მოცილების პროცესი. გაეცანით ნადების მოცილების თავს.

ორთქლის უთოს ძირიდან წყალი ჟონავს.

საიმედოდ არ დახურეთ წყლის ავზის თავსახური ან ნადების მოცილების ლილაკი. წყლის რეზერვუარი არასწორადაა ჩასმული.

საიმედოდ დახურეთ წყლის ავზის თავსახური ან ნადების მოცილების ლილაკი. სწორად ჩასვით რეზერვუარი.

产品简介

欢迎购买并使用飞利浦产品！为了让您能充分享受飞利浦提供的支持，请在 www.philips.com/welcome 上注册您的产品。使用本产品前，请认真阅读本用户手册、重要信息手册和快速入门指南。请妥善保管这些文件，以供日后参考。

产品概述

STE1020、STE1030、STE1040

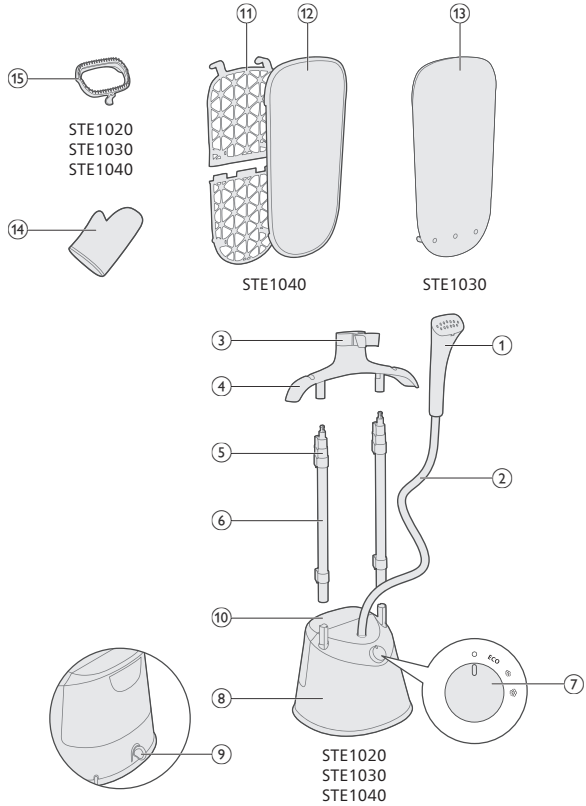

STE1010

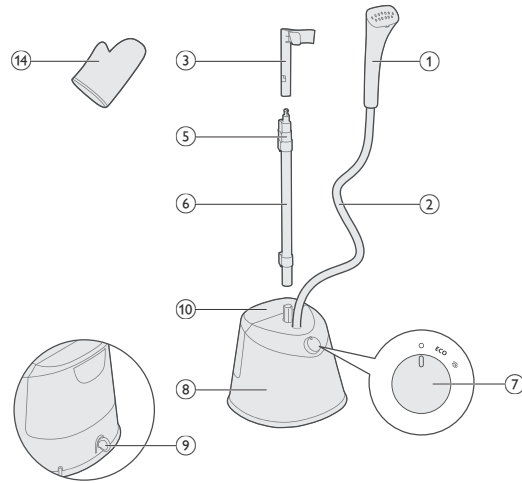

- 1 蒸汽挂烫机蒸汽喷头
- 2 蒸汽输送管
- 3 熨烫机支架
- 4 挂架 (STE1020、STE1030、STE1040)
- 5 衣架锁夹
- 6 衣架杆
- 7 蒸汽旋钮
- 8 底座
- 9 除垢旋钮
- 10 水箱
- 11 熨衣板 (STE1040)
- 12 护盖 (STE1040)
- 13 熨衣垫 (STE1030)
- 14 防烫手套
- 15 毛刷 (STE1020、STE1030、STE1040)

使用准备

所用水质类型

本产品可使用自来水。但如果您居住的区域水质较硬，我们建议您将等量的自来水与蒸馏水或软化水混合使用。这样可以防止水垢快速积聚，从而延长产品的使用寿命。

请勿将香水、转筒式干燥机中的水、醋、淀粉、除垢剂、熨衣剂、化学除垢水或其他化学品加入水箱，因为它们可能会导致喷水、留下褐色污垢或损坏产品。

警告

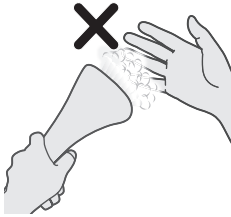

1 切勿让皮肤的任何部分与蒸汽直接接触。



2 切勿将蒸汽面板对准他人。

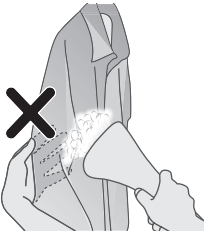

3 切勿以会与蒸汽直接接触的方式握住衣物。



4 使用蒸汽熨烫机蒸汽喷头时切勿向下握持。

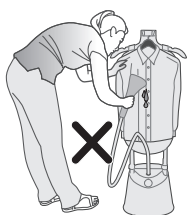

5 使用蒸汽熨烫衣物时应避免蒸汽输送管弯折。

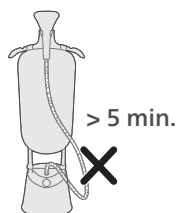

6 切勿使挂烫机无人看管超过 5 分钟。

安装产品

STE1010



1 记下您所购买产品配备的部件。

STE1020, STE1030

STE1040



2 将底部衣架锁夹解锁，然后将衣架杆插入底座。确保衣架杆的孔洞与底座螺柱对齐。

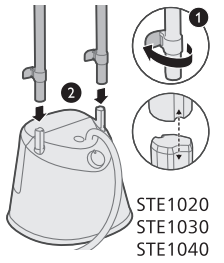
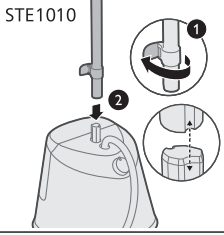

STE1020
STE1030
STE1040

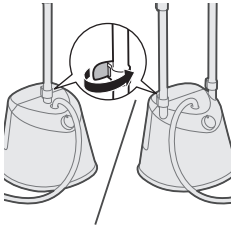

3 将底部衣架锁夹锁定。

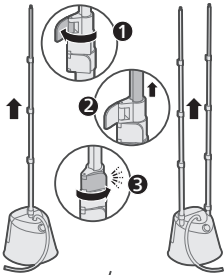

4 将其余衣架锁夹解锁，将衣架杆完全向上展开，然后锁定。

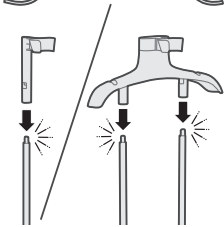

5 将熨烫机支架插入衣架杆上，直至其锁定到位（听到“咔哒”一声）。

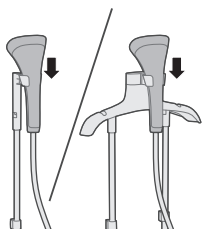

- 6 将蒸汽熨烫机蒸汽喷头放到熨烫机支架上。

安装熨衣板

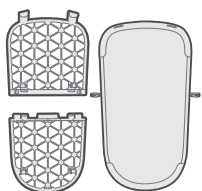

- 1 记下您所购买产品配备的部件。

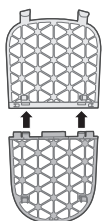

- 2 对齐并插入熨衣板固定夹，直至其锁定到位（听到“咔哒”一声）。

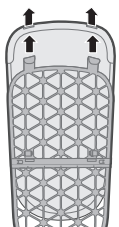

- 3 将熨衣板护盖与熨衣板挂钩对齐并将其插入。

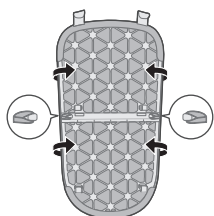

- 4 将熨衣板护盖绑带钩到熨衣板背面的挂钩上

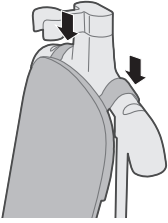

5 将熨衣板放到挂架上。

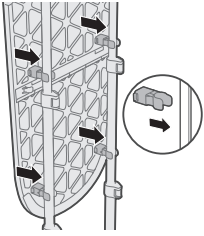

6 将熨衣板固定到两根衣架杆上，直至其锁定到位（听到“咔哒”一声）。

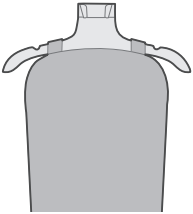

7 您可以用挂架披挂您的衣物。

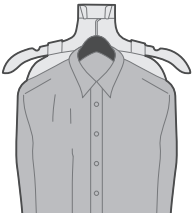
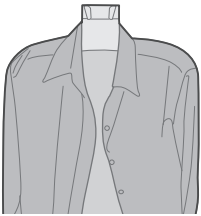

8 您可以使用自己的挂架并将其放在熨烫机支架上。

安装熨衣垫

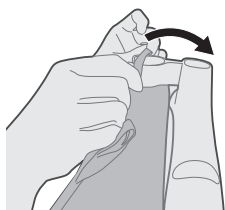

1 将中间的绑带穿过熨烫机支架。

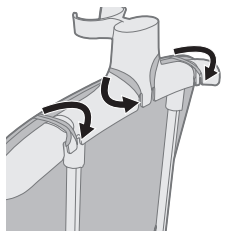

2 将3条绑带固定在挂架背面的挂钩上。

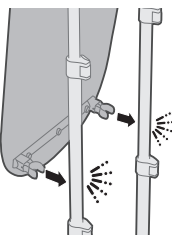

3 将熨衣垫固定到两根衣架杆上，直至其锁定到位（听到“咔哒”一声）。

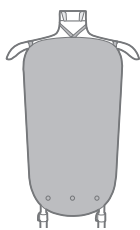

4 您可以用挂架披挂您的衣物。





5 您可以使用自己的挂架并将其放在熨烫机支架上。

插入毛刷

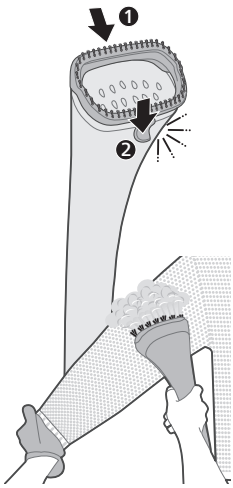

1 沿着蒸汽熨烫机蒸汽喷头的顶部对齐导轨，并锁住底部的锁扣（听到“咔哒”一声）。

2 您可以戴上防烫手套并使用毛刷附件熨烫衣服。

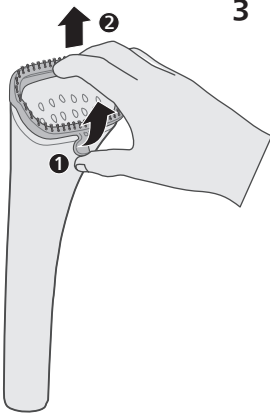

3 握住蒸汽熨烫机蒸汽喷头底部的锁扣并将其拉出，可卸下毛刷附件。

给水箱注水

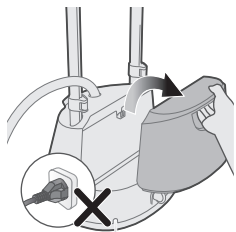

1 确保产品电源插头已拔下。从底座中取出水箱。

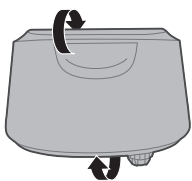

2 翻转水箱，使水箱盖朝上。

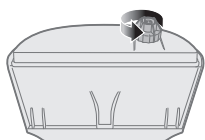

3 逆时针旋下水箱盖以将其取下。

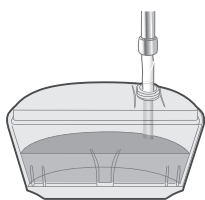

4 为水箱加水。

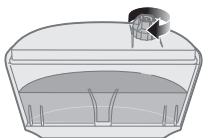

5 顺时针拧紧水箱盖。

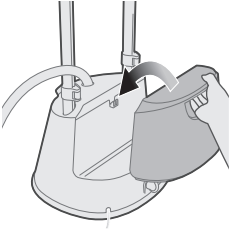

- 6 将水箱与挂钩对齐，然后将其装回底座。

更改蒸汽设置

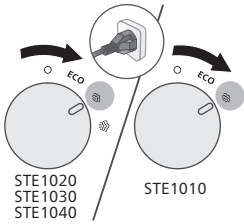

- 1 确保产品已插上电源。将蒸汽旋钮旋转至所需的蒸汽设置。

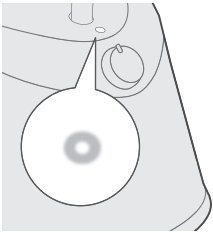

- 2 指示灯将进入常亮状态，表示挂烫机已打开。

*STE1010/75: ~2 min

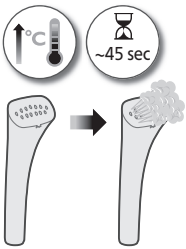

- 3 等待大约 45 秒钟，让挂烫机加热并释放蒸汽。
(STE1010/75: 需 2 分钟左右)。

熨烫提示

- 1 您可以使用自己的挂架并将其放在熨烫机支架上。

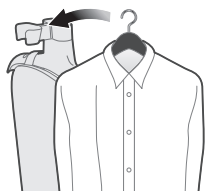

- 2 将蒸汽熨烫机蒸汽喷头朝与衣领平行的方向移动。

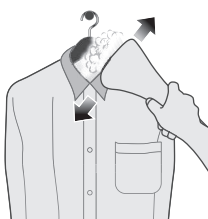

- 3 将蒸汽熨烫机蒸汽喷头朝与衣服过肩平行的方向移动。



- 4 拉伸衣物。熨烫衣物正面时将蒸汽熨烫机蒸汽喷头向下移动。

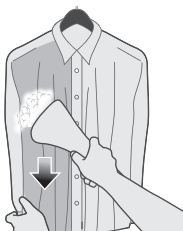

- 5 熨烫口袋部位时将蒸汽熨烫机蒸汽喷头向上移动。





- 6 拉伸衣物。熨烫衣物背面时将蒸汽熨烫机蒸汽喷头向下移动。

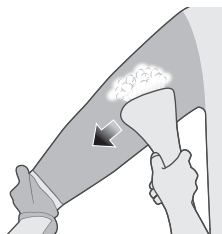

- 7 拉伸衣物。将蒸汽熨烫机蒸汽喷头朝与衣袖平行的方向移动。

清洁和保养

除垢收集器

您的产品设计有除垢收集器系统。建议您至少每月进行一次除垢。这有助于保持强劲的蒸汽性能，且随着时间的推移，防止底板中出现污垢和污渍。

提示：除垢收集器系统可以随时使用。如果您居住的区域水质较硬，请更频繁地使用该功能。

执行除垢程序

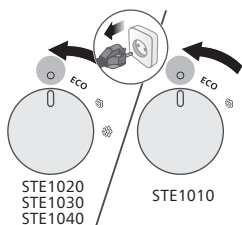

- 1 确保蒸汽旋钮位于 OFF（关）位置，并且产品已拔下电源插头。

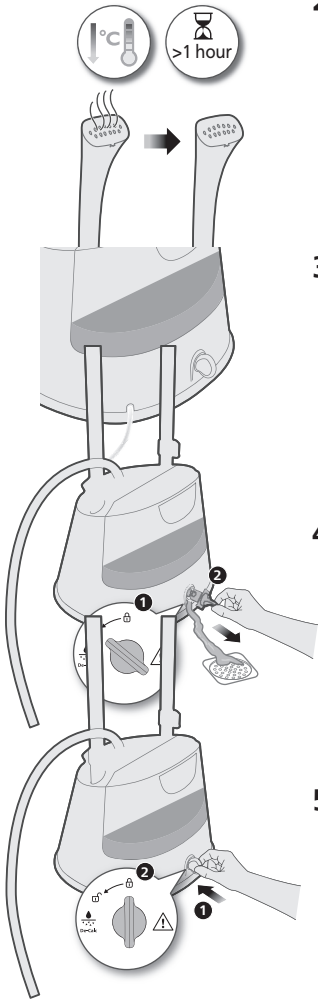

2 确保熨斗已完全冷却 (> 1 小时)。

3 将熨烫机放在靠近排水口的地方。

4 将除垢旋转变到解锁位置，然后取下除垢旋钮。将水排空。

5 装回除垢旋钮并将其转至锁定位置。

清洁和存放挂烫机

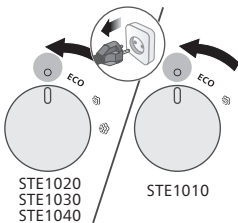

1 确保蒸汽旋钮位于 OFF (关) 位置，并且产品已拔下电源插头。

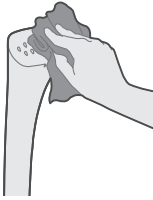
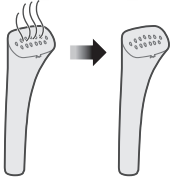

2 确保熨斗已完全冷却 (> 1 小时)。

3 用湿布擦拭蒸汽面板。

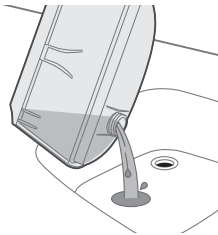

4 完全倒空水箱。

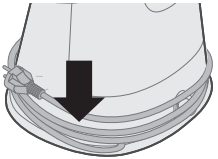

5 将电源线缠绕在底座上。

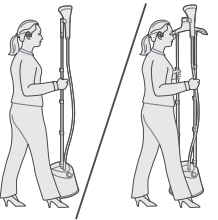

6 您可以握住衣架杆来搬动挂烫机。

故障排除

本章归纳了您在使用本产品时常常遇到的问题。如果您无法根据以下信息解决问题，请访问 www.philips.com/support 查阅常见问题列表，或联系您所在国家/地区的客户服务中心。

问题	可能的原因	解决方法
产品无法产生蒸汽或产生的蒸汽不连贯。	熨烫机未充分加热。	让产品加热约 45 秒钟（STE1010/75：需 2 分钟左右）。
	有蒸汽凝结在输送管内。	提起蒸汽喷头以垂直拉直蒸汽输送管。这样可以使冷凝水回流。
	水箱中的水位低或水箱未正确插入。	为水箱加水并正确装入。
水滴从蒸汽喷头上滴下或产品发出咕噜声。	产品内积聚的水垢太多。	执行除垢程序。参见“除垢”部分。
	蒸汽喷头和/或蒸汽输送管水平摆放了较长时间。	提起蒸汽喷头以垂直拉直蒸汽输送管。这样可以使冷凝水回流。
	当蒸汽输送管处于 U 形状态时，输送管内的冷凝水不能流回水箱中。	提起蒸汽喷头以垂直拉直蒸汽输送管。这样可以使冷凝水回流。
当产品加热时，蒸汽熨烫机蒸汽喷头中滴出的水过多。	产品中的水变脏或留在产品内很长时间。	执行除垢程序。参见“除垢”部分。
蒸汽挂烫机底座漏水。	您没有关闭水箱盖或没有牢固地拧紧除垢旋钮。水箱没有正确地插入。	盖好水箱盖或拧紧除垢旋钮。请正确插入水箱。

簡介

感謝您購買本產品。歡迎來到飛利浦的世界！請至 www.philips.com/welcome 註冊您的產品，以獲得飛利浦提供的完整支援。使用本產品前，請先詳閱本使用手冊、重要資訊手冊及快速入門指南。請妥善保存，以供日後參考。

產品概覽

STE1020、STE1030、STE1040

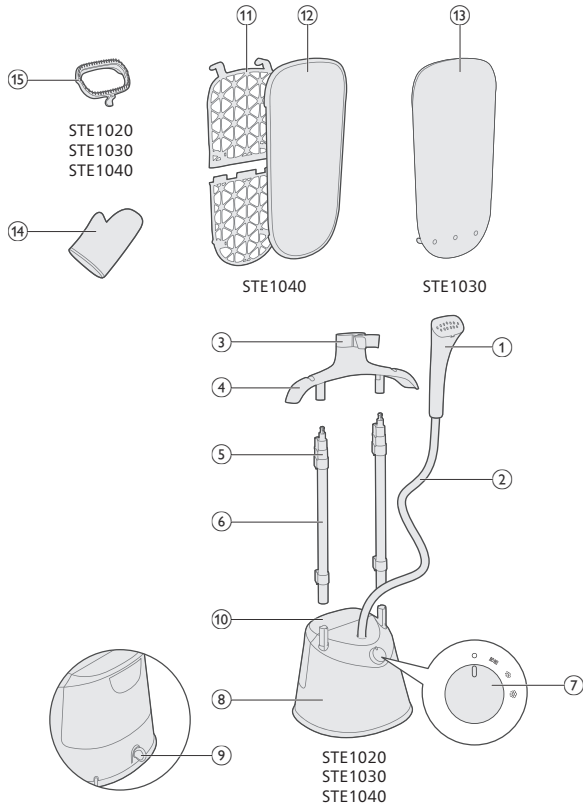

STE1010

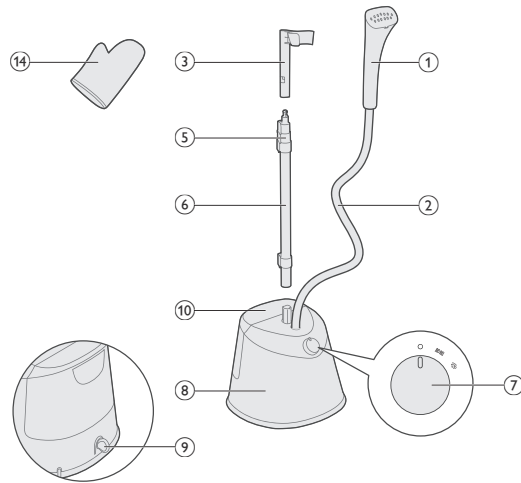

- 1 蒸氣噴頭
- 2 蒸氣膠管
- 3 蒸氣機固定架
- 4 衣架 (STE1020、STE1030、STE1040)
- 5 掛桿鎖固定夾
- 6 掛桿
- 7 蒸氣轉盤
- 8 底座
- 9 除鈣旋鈕
- 10 水箱
- 11 熨燙板 (STE1040)
- 12 熨燙板套 (STE1040)
- 13 熨衣墊 (STE1030)
- 14 手套
- 15 毛刷 (STE1020、STE1030、STE1040)

使用前準備

使用的水質

本產品適合搭配自來水使用。不過，如果您居住地區的水質偏硬，建議您將等量的自來水與蒸餾水或軟化水混合。如此可避免快速累積水垢，並延長產品的使用壽命。

請勿加入香水、滾筒式烘乾機的水、醋、燙衣漿、除垢劑、熨燙添加劑、經化學除垢的水或其他化學物質，否則可能造成水噴濺溢漏、產生棕色汗漬或損壞產品。

警告

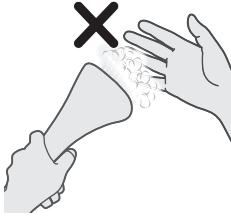

1 請勿讓皮膚的任何部位直接接觸蒸氣。



2 請勿將蒸氣板對準他人。

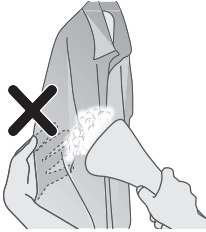

3 請勿以會直接接觸蒸氣的方式握住衣物。

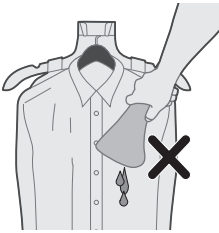

4 請勿朝下使用蒸氣噴頭。

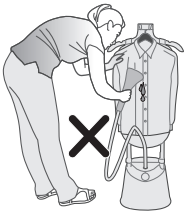

5 請勿彎曲膠管來蒸氣熨燙衣物。

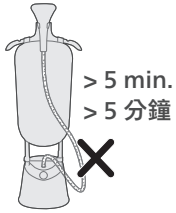

- 6 請勿讓直立式蒸氣機處於無人看管狀態超過 5 分鐘。

安裝產品

STE1010

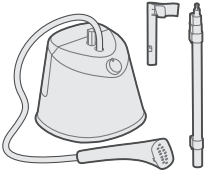

- 1 請記下您購入產品適用的零件。

STE1020, STE1030
STE1040



STE1010

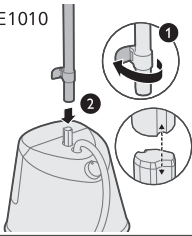

- 2 解開底部掛桿鎖固定夾，並將掛桿插入底座。確保掛桿和底座掛桿孔的輪廓互相對準。

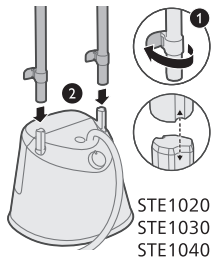

STE1020
STE1030
STE1040

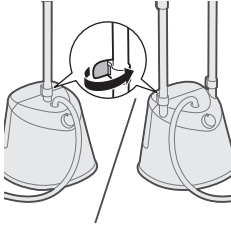

3 鎖定底部掛桿鎖固定夾。

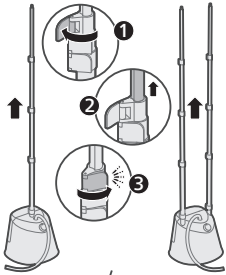

4 解開剩餘的掛桿鎖固定夾，將掛桿完全向上拉出並鎖定。

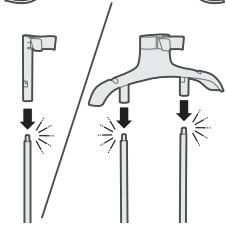

5 將蒸氣機固定架插入掛桿，直到卡入定位為止(會聽見「喀嗒」一聲)。

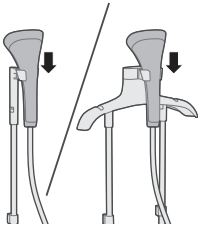

6 將蒸氣噴頭放在蒸氣機固定架上。

安裝熨燙板

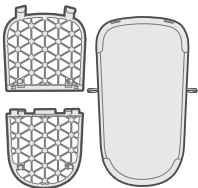

1 請記下您購入產品適用的零件。

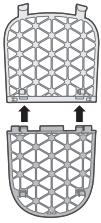

2 對準並插入熨燙板夾，直到卡入定位為止 (會聽見「喀嗒」一聲)。

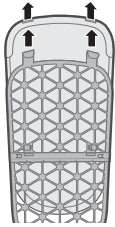

3 將熨燙板套對準並穿過熨燙板掛鉤。

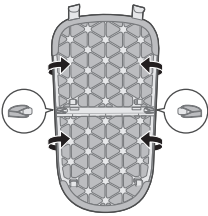

4 將熨燙板套的帶子掛到熨燙板背面的掛鉤上

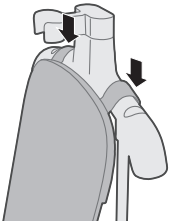

5 將熨燙板放在衣架上。

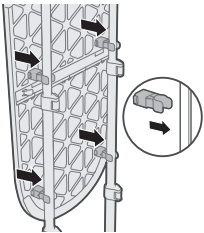

6 將熨燙板固定在掛桿上，直到卡入定位為止 (會聽見「喀嗒」一聲)。

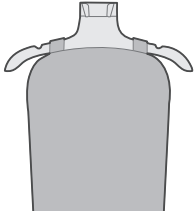

7 您可以使用衣架掛起衣物。

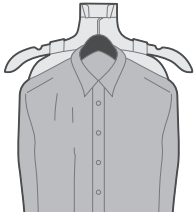
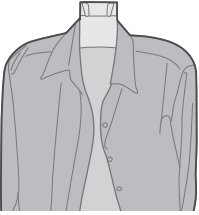

8 您可以使用自己的衣架，並將其放在蒸氣機固定架上。

安裝熨衣墊

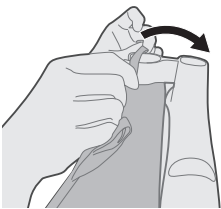

1 將中間的帶子穿過蒸氣機固定架。

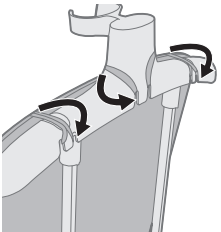

2 將 3 條帶子固定在衣架背面的掛鉤上。

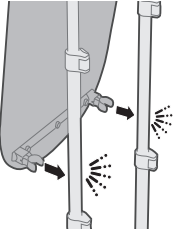

- 3 將熨衣墊固定在掛桿上，直到卡入定位為止 (會聽見「喀嗒」一聲)。

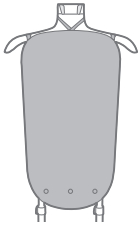

- 4 您可以使用衣架掛起衣物。



- 5 您可以使用自己的衣架，並將其放在蒸氣機固定架上。

裝入毛刷

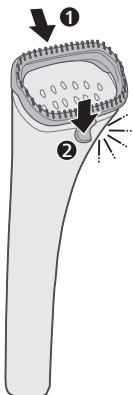

- 1 沿著蒸氣噴頭頂端的軌道對準，然後卡入底部的鎖扣 (會聽見「喀嗒」一聲)。

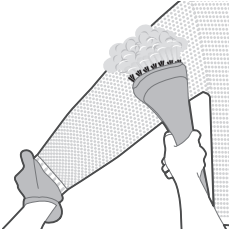

2 您可以戴上手套，使用毛刷配件蒸氣熨燙衣物。

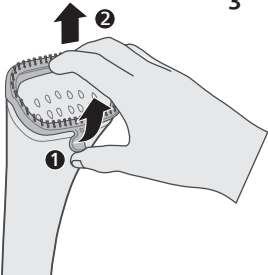

3 抓住蒸氣噴頭底部的鎖扣並拉出，即可拆下毛刷配件。

加水至水箱內

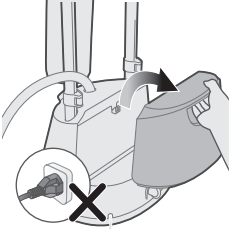

1 請勿將產品插上電源。從底座取出水箱。

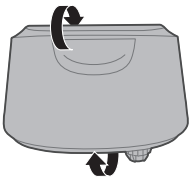

2 翻轉水箱，讓水箱蓋朝上。

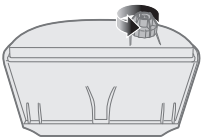

3 逆時針旋開水箱蓋以取下。

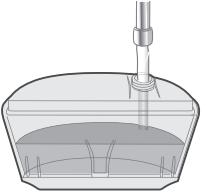

4 為水箱加水。

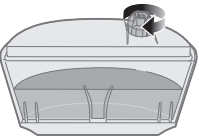

5 順時針旋緊水箱蓋。

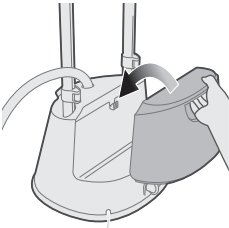

6 對準掛鉤，將水箱放回底座。

變更蒸氣設定

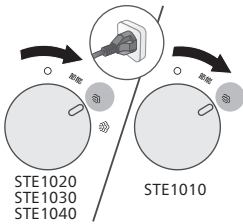

1 確保產品已插上電源。將蒸氣轉盤轉到想要的蒸氣設定。

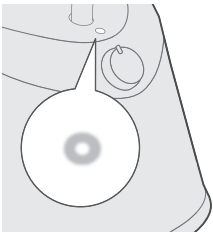

2 指示燈會持續亮起，表示直立式蒸氣機已開啟。

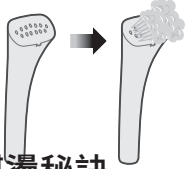
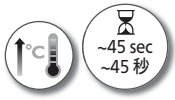

熨燙秘訣

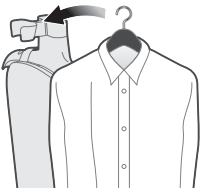

3 等待約 45 秒，讓直立式蒸氣機加熱及釋出蒸氣 (STE1010/75：約 2 分鐘)。

1 您可以使用自己的衣架，並將其放在蒸氣機固定架上。

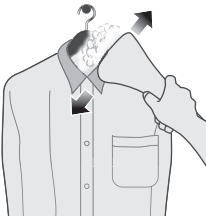

2 以與衣領平行的方向移動蒸氣噴頭。



3 以和抵肩呈水平的方向移動蒸氣噴頭。

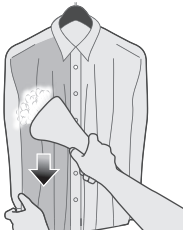

4 拉伸衣物。在衣物正面向下移動蒸氣噴頭。



5 在口袋處向上移動蒸氣噴頭。

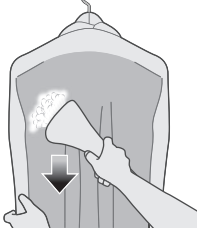

6 拉伸衣物。在衣物背面向下移動蒸氣噴頭。

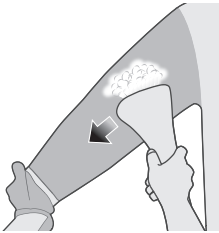

7 拉伸衣物。以與衣袖平行的方向移動蒸氣噴頭。

清潔與維護

鈣垢收集器

您的產品採用鈣垢收集器系統設計。建議您每個月除垢一次或以上。這有助於維持長時間的強力蒸氣效果，並可避免經久使用後灰塵與髒汙從底盤流出的情況。

提示：您可以隨時使用鈣垢收集器系統。如果您居住的區域水質較硬，請更頻繁地使用此功能。

執行除鈣清洗程序

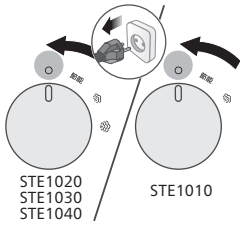

1 確保蒸氣轉盤位於關閉位置，且產品的插頭已經拔除。



2 確保熨斗已完全冷卻 (> 1 小時)。

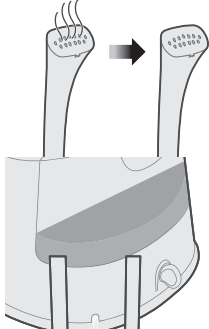

3 將蒸氣機靠近水槽。

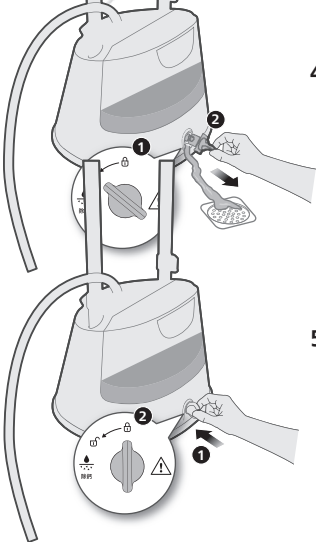

4 將除鈣旋鈕轉至解鎖位置，並取下除鈣旋鈕。讓水排出。

5 將除鈣旋鈕插入並轉至鎖定位置。

清潔與收納直立式蒸氣機

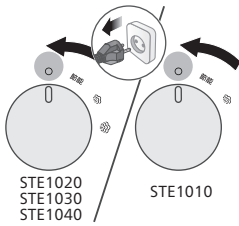

1 確保蒸氣轉盤位於關閉位置，且產品的插頭已經拔除。

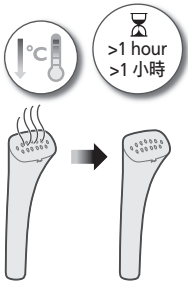

2 確保熨斗已完全冷卻 (> 1 小時)。

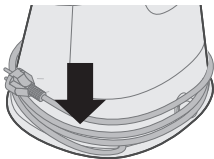
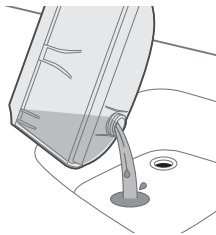
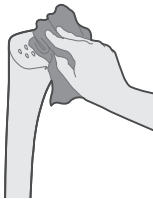

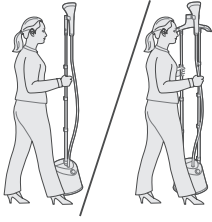

6 您可以握住掛桿來搬運直立式蒸氣機。

疑難排解

本單元概述您使用本產品時可能遇到的最常見問題。如果下方資訊無法解決您遇到的問題，請造訪 www.philips.com/support 查看常見問題集清單，或聯絡您所在國家/地區的飛利浦客戶服務中心。

問題	可能原因	解決方案
本產品無法產生蒸氣或蒸氣量不規律。	蒸氣機未充分加熱。	待產品加熱約 45 秒 (STE1010/75：約 2 分鐘)。
	膠管中的蒸氣凝結。	拿起蒸氣噴頭，讓膠管以垂直方向伸直。這樣可讓凝結水珠流回水箱。
	水箱內的水位過低或水箱未正確裝入。	為水箱加水並正確裝入。
	產品中累積太多水垢。	執行除鈣程序。請參閱「除鈣清洗」一節。
蒸氣噴頭會滴水，或本產品發出汲水聲。	蒸氣噴頭及/或蒸氣膠管長期水平放置。	拿起蒸氣噴頭，讓膠管以垂直方向伸直。這樣可讓凝結水珠流回水箱。
	若膠管呈 U 字型，膠管中凝結的水珠無法流回水箱。	拿起蒸氣噴頭，讓膠管以垂直方向伸直。這樣可讓凝結水珠流回水箱。
當產品加熱時，多餘的水從蒸氣噴頭中滴出。	產品中的水不乾淨，或已經在產品中很長一段時間。	執行除鈣程序。請參閱「除鈣清洗」一節。
蒸氣機底座漏水。	您沒有將水箱蓋或除鈣旋鈕關緊。未正確裝入水箱。	關緊水箱蓋或除鈣旋鈕。將水箱妥善裝入。

소개

필립스 제품을 구입해 주셔서 감사합니다! 필립스가 드리는 지원 혜택을 받으실 수 있도록 www.philips.com/welcome에서 제품을 등록하십시오. 본 제품을 사용하기 전에 이 사용 설명서와 중요 정보 책자, 요약 설명서를 주의 깊게 읽으십시오. 나중에 참조할 수 있도록 이 설명서를 보관하십시오.

제품 개요

STE1020, STE1030, STE1040

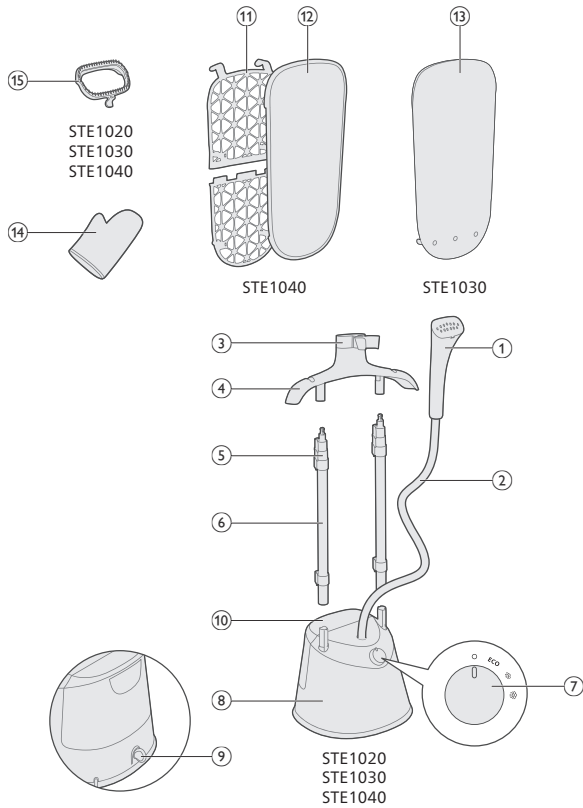

STE1010

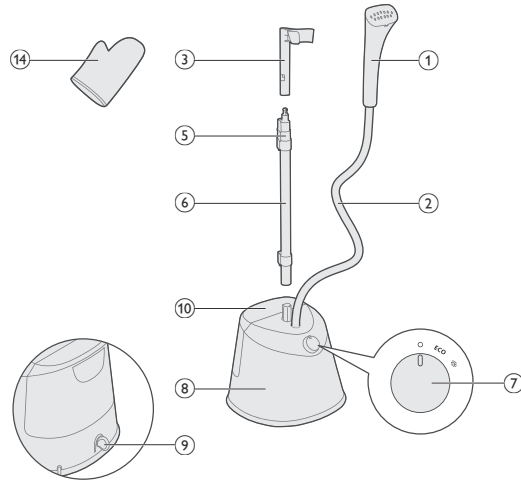

- 1 스티머 헤드
- 2 스티머호스
- 3 스티머머 도크
- 4 옷걸이(STE1020, STE1030, STE1040)
- 5 플 잠금 클립
- 6 플
- 7 스티머량 조절기
- 8 베이스
- 9 석회질 제거 조절기
- 10 물 탱크
- 11 다림판(STE1040)
- 12 덮개(STE1040)
- 13 매트(STE1030)
- 14 장갑
- 15 브러시(STE1020, STE1030, STE1040)

사용 준비

사용할 물의 종류

이 제품은 수도물을 사용하는 것이 적합합니다. 그러나 경수 지역에 거주하는 경우, 수도물과 같은 양의 증류수 또는 탈염수를 혼합하는 것이 좋습니다. 이로써 석회질이 빨리 쌓이지 않고, 제품의 수명이 연장됩니다.

향수, 회전식 건조기의 물, 식초, 플, 석회질 제거제, 다림질 보조제, 이물질 제거용 화학 약품이나 기타 화학 약품을 추가하지 마십시오. 물이 튀거나, 갈색 얼룩이 생기거나, 제품이 손상될 수 있습니다.

경고

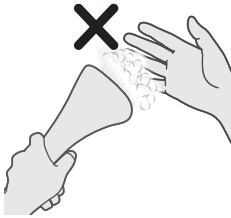

1 스팀이 피부에 직접 닿지 않도록 하십시오.



2 스팀 열판이 다른 사람을 향하게 하지 마십시오.

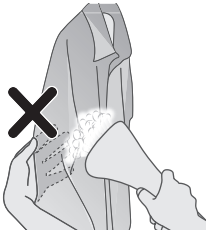

3 스팀에 직접 닿도록 옷감을 잡지 마십시오.

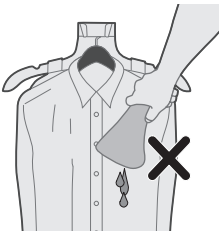

4 스팀머 헤드가 아래쪽을 향하도록 사용하지 마십시오.

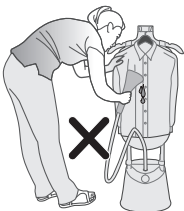

5 호스를 구부려서 옷감에 스팀을 분사하지 마십시오.

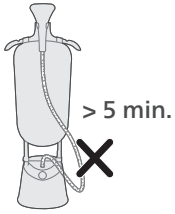

6 스탠드형 다리미를 5분 이상 방치하지 마십시오.

제품 설치

STE1010

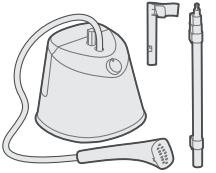

1 구입한 제품에 사용할 수 있는 부품을 확인하십시오.

STE1020, STE1030
STE1040



STE1010

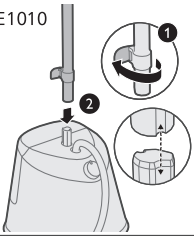

2 하단 폴 잠금 클립의 잠금을 해제하고 폴을 본체에 끼우십시오. 폴 결합부와 받침대 폴 고정부가 정렬되었는지 확인하십시오.

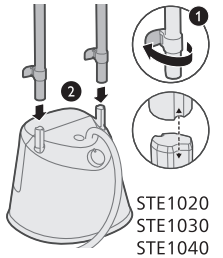

STE1020
STE1030
STE1040

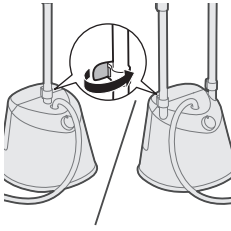

3 하단 풀 잠금 클립을 잠그십시오.

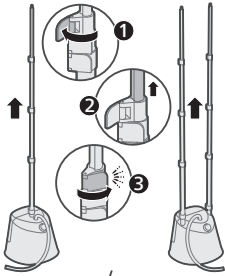

4 나머지 풀 잠금 클립의 잠금을 해제하고 풀을 위쪽으로 완전히 확장한 후 잠그십시오.

5 '딸깍' 소리가 나면서 고정될 때까지 스티머 도크를 풀에 끼우십시오.

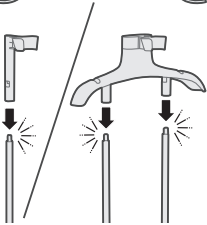

6 스티머 헤드를 스티머 도크에 놓으십시오.

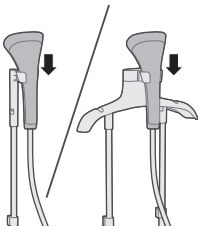

다림판 설치

1 구입한 제품에 사용할 수 있는 부품을 확인하십시오.

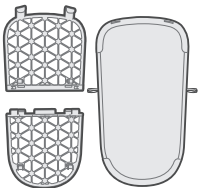

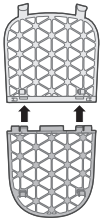

2 다림판 클립을 정렬하고 '딸깍' 소리가 나면서 제자리에 고정될 때까지 끼우십시오.

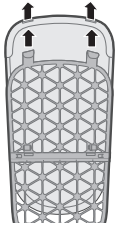

3 다림판 덮개를 다림판 고리에 정렬한 뒤 끼우십시오.

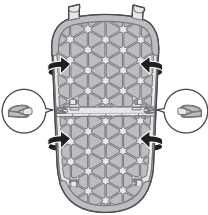

4 다림판 뒷면의 고리에 다림판 덮개 스트랩을 연결하십시오.

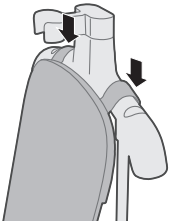

5 옷걸이 위에 다림판을 놓으십시오.

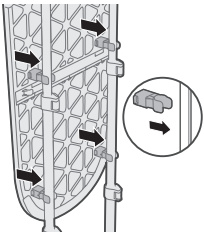

6 '딸깍' 소리가 나면서 고정될 때까지 다림판을 풀에 끼우십시오.

- 7 옷걸이를 사용하여 옷을 걸칠 수 있습니다.

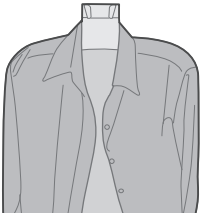
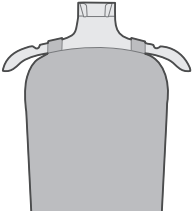

- 8 옷걸이를 사용하여 스티머 도크에 올려 놓을 수 있습니다.

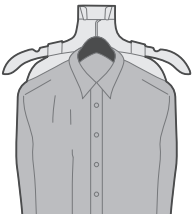

매트 설치

- 1 스티머 도크에 중간 스트랩을 끼우십시오.

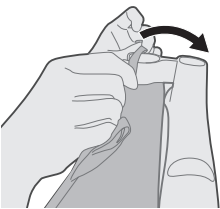

- 2 옷걸이 뒤쪽의 고리에 스트랩 3개를 고정하십시오.

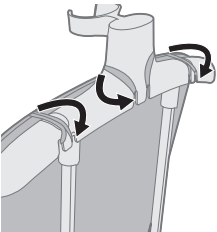

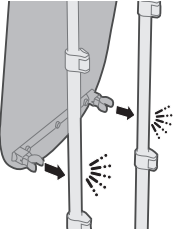

3 '딸깍' 소리가 나면서 고정될 때까지 폴에 매트를 끼우십시오.

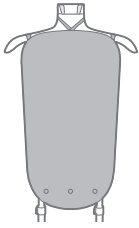

4 옷걸이를 사용하여 옷을 걸칠 수 있습니다.



5 옷걸이를 사용하여 스티머 도크에 올려 놓을 수 있습니다.

브러시 삽입

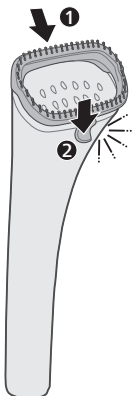

1 스티머 헤드 상단을 따라 트랙을 정렬하고 하단의 걸쇠를 '딸깍' 소리가 나도록 누르십시오.

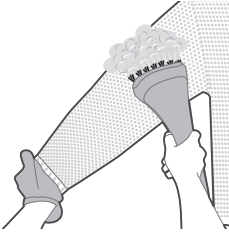

2 장갑을 착용한 뒤 브러시 액세서리를 사용하여 옷을 다림질할 수 있습니다.

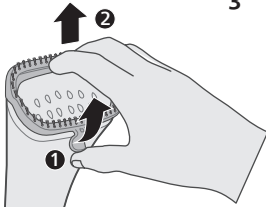

3 스티머 헤드 하단에서 걸쇠를 잡아 당겨 브러시 액세서리를 분리하십시오.

물 탱크 채우기

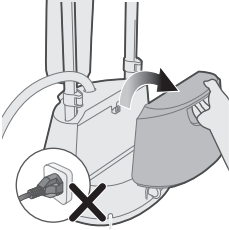

1 제품에 전원을 연결하지 마십시오. 받침대에서 물 탱크를 분리하십시오.

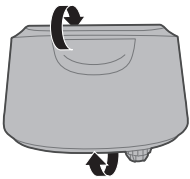

2 물 탱크 캡이 위를 향하도록 물 탱크를 뒤집으십시오.

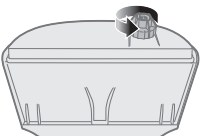

3 물 탱크 캡을 시계 반대 방향으로 돌려 분리하십시오.

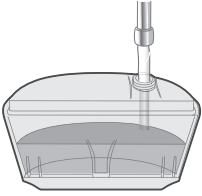

4 물 탱크를 채우십시오.

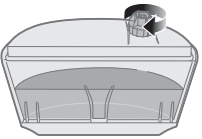

5 물 탱크 캡을 시계 방향으로 돌려 조이십시오.

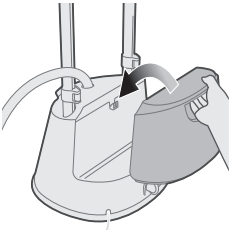

6 물 탱크를 고리에 맞춘 뒤 받침대에 다시 장착하십시오.

스팀 설정 변경

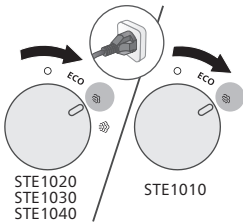

1 제품에 전원을 연결하십시오. 스팀량 조절기를 돌려 원하는 스팀 설정으로 맞추십시오.

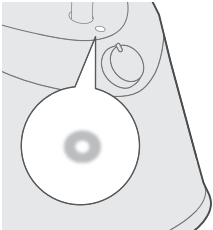

2 표시등이 계속 켜지면 스탠드형 다리미의 전원이 켜져 있음을 나타냅니다.

*STE1010/75: ~2 min

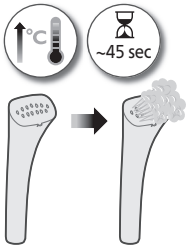

다림질 요령

3 스탠드형 다리미가 가열되어 스팀이 분사될 때까지 약 45초 동안 기다리십시오(STE1010/75의 경우 약 2분).

1 옷걸이를 사용하여 스티머 도크에 올려 놓을 수 있습니다.

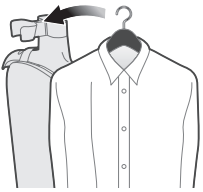

2 스티머 헤드를 칼라와 평행한 방향으로 움직이십시오.

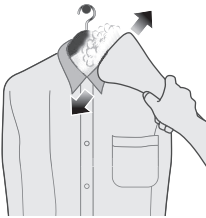

3 스티머 헤드를 요크와 수평인 방향으로 움직이십시오.



4 옷감을 당기십시오. 스티머 헤드를 옷 앞면에서 아래쪽으로 움직이십시오.

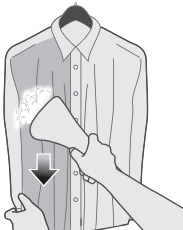



5 스티머 헤드를 주머니에서 위쪽으로 움직이십시오.

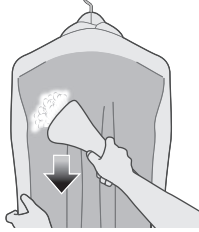

6 옷감을 당기십시오. 스티머 헤드를 옷 뒷면에서 아래쪽으로 움직이십시오.

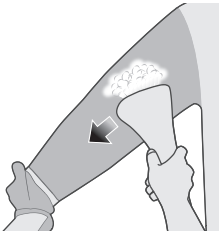

7 옷감을 당기십시오. 스티머 헤드를 슬리브와 평행한 방향으로 움직이십시오.

청소 및 유지관리

석회질 수집기

이 제품은 석회질 수집기 시스템으로 설계되었습니다. 석회질 제거는 한 달에 한 번 이상 수행하는 것이 좋습니다. 이를 통해 강력한 스팀 성능을 유지하고 오랜 기간 사용해도 열판에 먼지와 얼룩이 생기는 것을 방지합니다.

도움말: 석회질 수집기 시스템은 언제든지 사용할 수 있습니다. 경수를 사용하는 지역에 살고 있는 경우에는 이 기능을 더 자주 사용하십시오.

석회질 제거 작업 수행

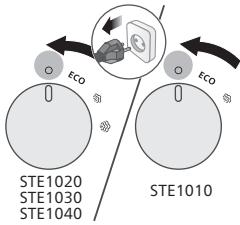

1 스팀량 조절기가 꺼짐 위치에 있고 제품의 플러그가 뽑혀 있는지 확인하십시오.

2 다리미가 완전히 식었는지 확인하십시오(1시간 이상).



3 스티머를 배수구 가까이에 놓으십시오.

4 석회질 제거 조절기를 잠금 해제 위치로 돌리고 석회질 제거 조절기를 분리하십시오. 물이 배출되도록 하십시오.

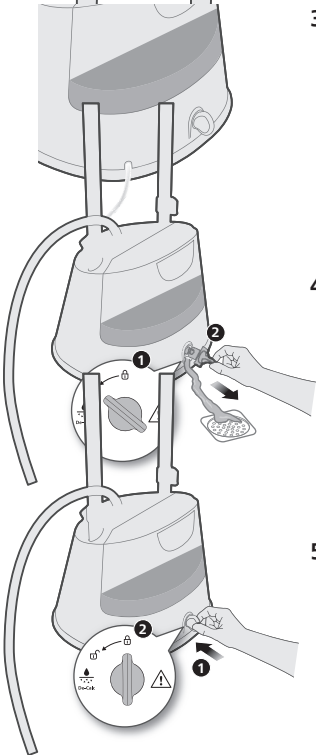

5 석회질 제거 조절기를 잠금 위치로 돌리십시오.

스탠드형 다리미 세척 및 보관

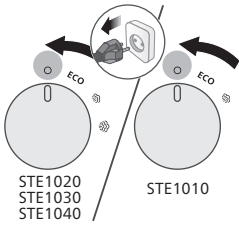

1 스팀량 조절기가 꺼짐 위치에 있고 제품의 플러그가 뽑혀 있는지 확인하십시오.



2 다리미가 완전히 식었는지 확인하십시오(1시간 이상).

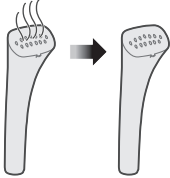

3 스팀 배출구를 젖은 천으로 닦으십시오.

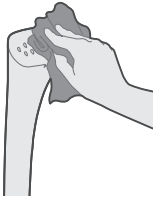

4 물 탱크의 물을 완전히 비우십시오.

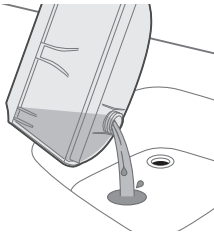

5 본체에 전원 코드를 감으십시오.

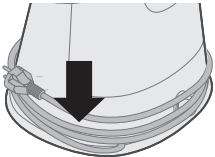

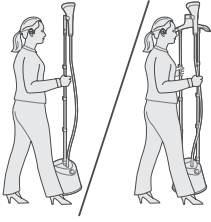

6 폴을 잡고 스탠드형 다리미를 옮길 수 있습니다.

문제 해결

이 장은 제품을 사용하면서 일반적으로 경험하게 되는 문제와 그 해결 방법을 제시합니다. 아래의 정보로도 문제를 해결할 수 없는 경우 www.philips.com/support를 방문하여 자주 묻는 질문(FAQ) 목록을 참조하거나 필립스 고객 상담실로 문의하십시오.

문제점	가능한 원인	해결책
제품에서 스팀이 나오지 않거나 일정하게 나오지 않습니다.	스티머가 충분히 뜨거워지지 않았습니다.	제품이 예열될 때까지 45초간 기다리십시오(STE1010/75의 경우 약 2분).
	호스에 스팀이 고여 있습니다.	스티머 헤드를 올려 호스를 곧게 펴니다. 그러면 고인 스팀이 물 탱크로 되돌아갑니다.
	탱크에 물이 부족하거나 탱크가 제대로 꽂혀 있지 않습니다.	물 탱크를 다시 채운 다음 제대로 장착하십시오.
	제품 내부에 석회질이 너무 많이 축적되었습니다.	석회질 제거 과정을 수행하십시오. 석회질 세척 기능 섹션을 참조하십시오.
스티머 헤드에서 물방울이 떨어지거나 제품에서 끓는 소리가 납니다.	스티머 헤드 및 스팀호스를 긴 시간 동안 수평으로 두었습니다.	스티머 헤드를 올려 호스를 곧게 펴니다. 그러면 고인 스팀이 물 탱크로 되돌아갑니다.
	호스가 U자 모양이 되면 호스에 고인 스팀이 물 탱크로 되돌아갈 수 없게 됩니다.	스티머 헤드를 올려 호스를 곧게 펴니다. 그러면 고인 스팀이 물 탱크로 되돌아갑니다.
제품이 가열되면서 과도한 양의 물이 스팀기 헤드 밖으로 튀니다.	제품 안에 있는 물이 더럽거나 물이 오랫동안 제품 안에 있었습니다.	석회질 제거 과정을 수행하십시오. 석회질 세척 기능 섹션을 참조하십시오.
스티머 받침대에서 물이 샐니다.	물 탱크 캡이나 석회질 제거 조절기를 꼭 닫지 않았습니다. 물 탱크를 올바르게 끼우지 않았습니다.	물 탱크 캡이나 석회질 제거 조절기를 꼭 닫으십시오. 탱크를 제대로 끼우십시오.

المقدمة

تهانينا على شرائك المنتج، ومرحبًا بك في Philips! للاستفادة بالكامل من الدعم الذي تقدّمه Philips، سجّل منتجك على www.philips.com/welcome. اقرأ دليل المستخدم هنا وكتيّب المعلومات الهامة ودليل البدء السريع بدقة قبل استخدام الجهاز. واحتفظ بكل المستندات للرجوع إليها في المستقبل.

نظرة عامة حول المنتج

STE1020، STE1030، STE1040

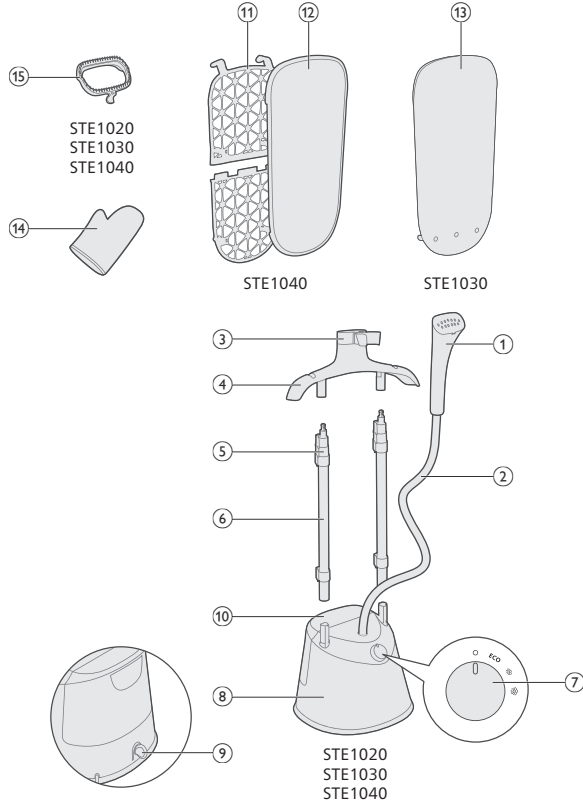

STE1010

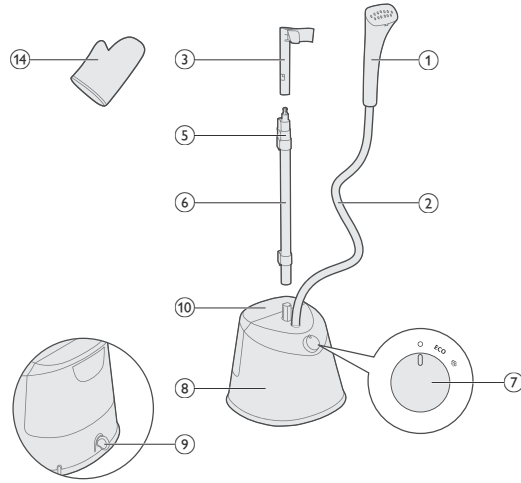

- 1 رأس الجهاز البخاري
- 2 خرطوم الإمداد البخار
- 3 قاعدة الجهاز البخاري
- 4 عاآقة (STE1040, STE1030, STE1020)
- 5 مشبك قفل العمود
- 6 العمود
- 7 قرص البخار
- 8 القاعدة
- 9 مفتاح إزالة الكلس
- 10 خزان المياه
- 11 اللوح (STE1040)
- 12 الغطاء (STE1040)
- 13 البساط (STE1030)
- 14 القفاز
- 15 الفرشاة (STE1040, STE1030, STE1020)

التحضير للاستخدام

نوع المياه الذي يجب استخدامه

يعدّ الجهاز مناسبًا للاستخدام مع مياه الحنفية. ومع ذلك، إذا كنت تعيش في منطقة حيث تكون المياه عسرة، ننصحك بمزج كمية متساوية من مياه الحنفية مع مياه مقطرة أو تمت إزالة المعادن منها. سيمنع ذلك تراكم الترسبات الكلسية بسرعة ويطيل فترة استخدام الجهاز.

لا تستخدم المياه المعطرة أو مياه آلة تجفيف الملابس أو الخل أو النشاء أو مواد إزالة الكلس أو المواد المساعدة على الكي أو المياه التي تمت إزالة الكلس منها كيميائيًا أو غيرها من المواد الكيميائية، إن قد تتسبب بخروج المياه من المكواة أو ظهور بقع بنية أو يالحاق الضرر بالجهاز.

التحذيرات

1 لا توجه البخار مباشرة إلى أي جزء من البشرة.

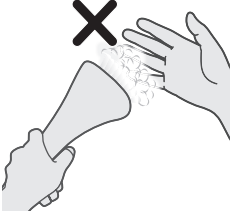

2 لا توجه لوحة البخار نحو أشخاص آخرين.



3 لا تحمل ملابسك بحيث تكون على اتصال مباشر بالبخار.

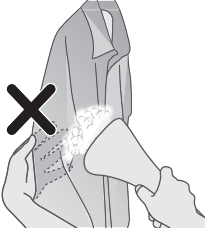

4 لا تستخدم رأس الجهاز البخاري نحو الأسفل.

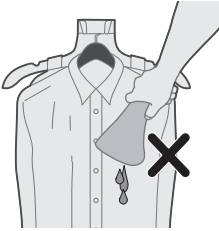

5 لا تقم بثني الخرطوم لكي الملابس بالبخار.

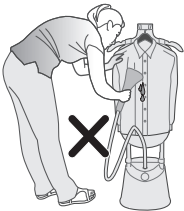

6 لا تترك الجهاز البخاري العمودي من دون مراقبة لأكثر من 5 دقائق.

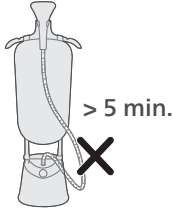

إعداد الجهاز

1 لاحظ الأجزاء المتاحة للجهاز الذي اشتريته.

STE1010

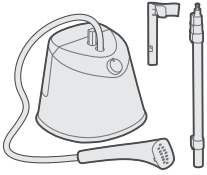

STE1020, STE1030

STE1040



STE1010

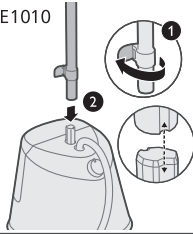

2 قم بإلغاء قفل المشابك السفلية لقفل العمود وأدخل العمود (الأعمدة) في القاعدة. تأكد من محاذاة جوانب العمود (الأعمدة) وبرغي (براغي) عمود الأساس.

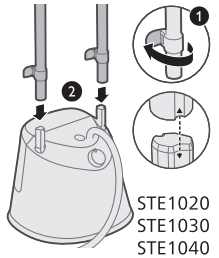

3 قم بفتح المثبوك (المثابك) السفلي لفتح العمود.

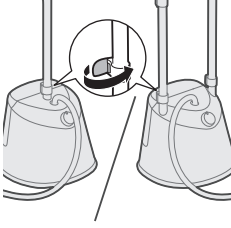

4 قم بإلغاء قفل المثابك المتبقية في قفل العمود، وقم بتمديد العمود (الأعمدة) بالكامل لأعلى وقفلها.

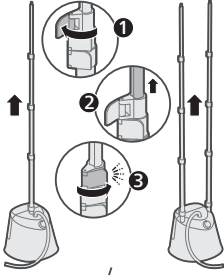

5 أدخل قاعدة الجهاز البخاري في العمود (الأعمدة) حتى تثبت في مكانها ("نقرة").

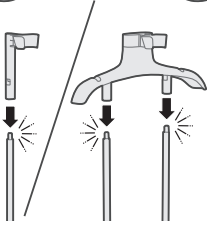

6 ضع رأس الجهاز البخاري على قاعدة الجهاز البخاري.

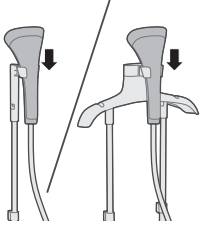

إعداد اللوح

1 لاحظ الأجزاء المتاحة للجهاز الذي اشتريته.

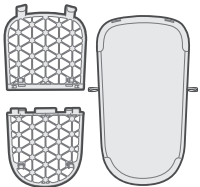

2 قم بمحاذاة مشابك اللوح وأدخلها حتى تثبت في مكانها ("نقرة").

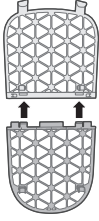

3 قم بمحاذاة غطاء اللوح وأدخله عبر خطافات اللوح.



4 إتشبك أشرطة غطاء اللوح على الخطافات في الجزء الخلفي للوح

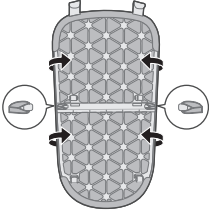

5 ضع اللوح على العاقدة.

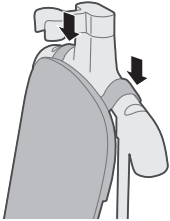

6 ثبت اللوح على الأعمدة حتى يثبت في مكانه ("نقرة").

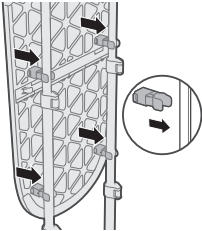

7 يمكنك تجفيف الملابس باستخدام العَلّاقَة.

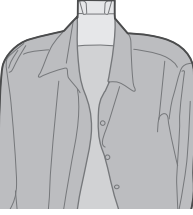
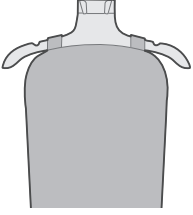

8 يمكنك استخدام عِلّاقَة خاصة بك ووضعها على قاعدة الجهاز البخاري.

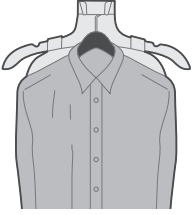

إعداد البساط

1 أدخل الشريط الأوسط عبر قاعدة الجهاز البخاري.

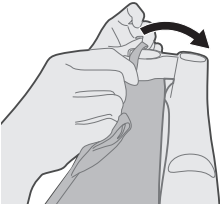

2 ثبت الأشرطة الثلاثة على الخطاف في الجزء الخلفي من العَلّاقَة.

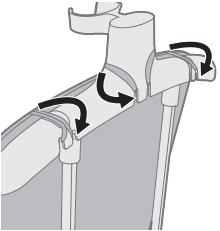

3 ثبتت البساط على الأعمدة حتى يثبت في مكانه ("نقرة").

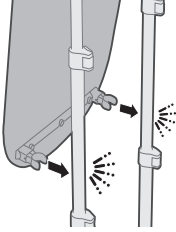

4 يمكنك تجفيف الملابس باستخدام العادّة.

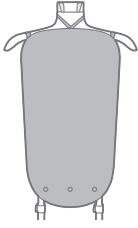

5 يمكنك استخدام عادّة خاصة بك ووضعها على قاعدة الجهاز البخاري.



إدخال الفرشاة

1 قم بمحاذاة المسار على طول الجزء العلوي من رأس الجهاز البخاري وثبت المشبك في الجزء السفلي ("نقرة").

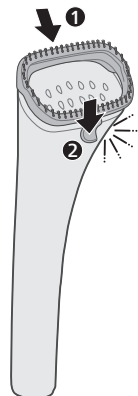

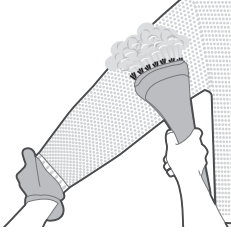

2 يمكنك ارتداء القفاز وكي ملابسك بالبخار باستخدام ملحق الفرشاة.

3 أمسك المشبك واسحب ه من أسفل رأس الجهاز البخاري لإزالة ملحق الفرشاة.

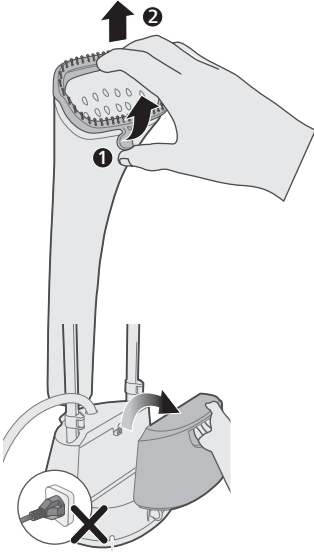

تعبئة خزان المياه

1 لا تقم بتوصيل الجهاز. ارفع خزان المياه عن القاعدة.

2 اقلب خزان المياه مع جعل غطاء خزان المياه يتجه صعوداً.

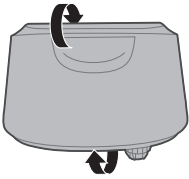

3 قم بفتح غطاء خزان المياه بعكس اتجاه عقارب الساعة لإزالته.

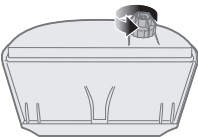

4 املأ خزان المياه.

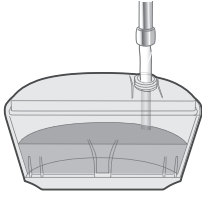

5 ثبت برغي غطاء خزان المياه باتجاه عقارب الساعة لشده.

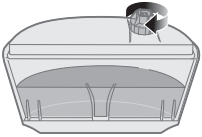

6 قم بالمحاذاة مع الخطاف لوضع خزان المياه مرة أخرى في القاعدة.

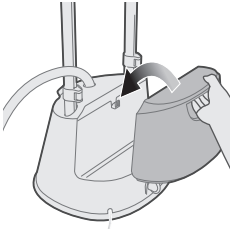

تغيير إعداد الكي بالبخار

1 تأكد من توصيل الجهاز، قم بتدوير قرص البخار إلى إعداد البخار المطلوب.

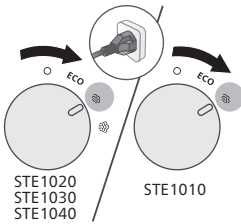

2 سيضيء الضوء بشكل ثابت للإشارة إلى تشغيل الجهاز البخاري العمودي.

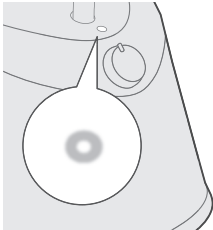

*STE1010/75: ~2 min

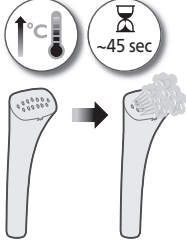

3 انتظر لمدة 45 ثانية حتى يسخن الجهاز البخاري العمودي وانبعاث البخار منه (STE1010/75: حوالى دقيقتين).

نصائح للكيّ

1 يمكنك استخدام علاّقة خاصة بك ووضعها على قاعدة الجهاز البخاري.

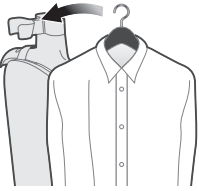

2 حرك رأس الجهاز البخاري باتجاه مواز مع طوق.

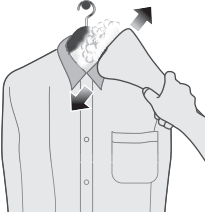

3 حرك رأس الجهاز البخاري باتجاه أفقي بمحاذاة الطوق.

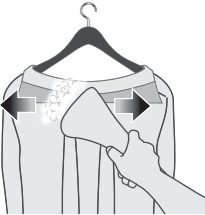

4 قم بشدّ الملابس. حرك رأس الجهاز البخاري إلى أسفل عند الجزء الأمامي من الملابس.

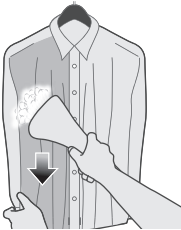

5 حرك رأس الجهاز البخاري إلى أعلى على جيب.



6 قم بشدّ الملابس. حرك رأس الجهاز البخاري إلى أسفل عند الجزء الخلفي من الملابس.

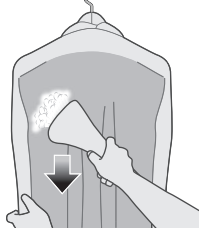

7 قم بشدّ الملابس. حرك رأس الجهاز البخاري باتجاه مواز مع الكم.

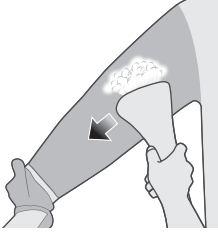

التنظيف والصيانة

أداة جمع الكلس

تم تصميم جهازك مع نظام لجمع الكلس. نوصيك بإزالة الكلس مرة في الشهر أو أكثر. يساعد هذا الأمر في الحفاظ على أداء البخار القوي ويمنع خروج الأوساخ والبقع من قاعدة المكواة مع مرور الوقت.

تلميح: يمكن استخدام نظام جمع الكلس في أي وقت كان. إذا كنت تعيش في منطقة حيث المياه عسرة، فاستخدم الميزة بشكل متكرر أكثر.

إجراء عملية تنظيف الكلس

1 تأكد من أن قرص البخار في وضع إيقاف التشغيل وأن الجهاز غير متصل بالطاقة.

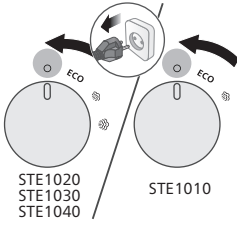

2 تأكد من أن الحديد قد برد تمامًا (أكثر من ساعة واحدة).



3 ضع الجهاز البخاري بالقرب من نظام التصريف.

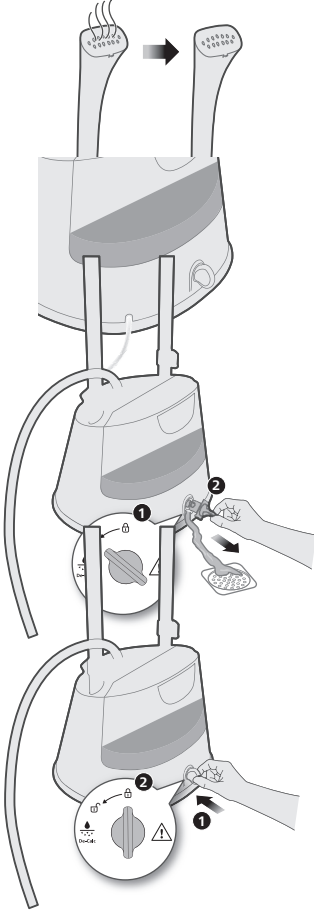

4 أدر مقبض إزالة الكلس إلى موضع الفتح واسحب مقبض إزالة الكلس. قم بتصريف المياه.

5 أدخل مقبض إزالة الكلس ثم أدخله في موضع القفل.

تنظيف الجهاز البخاري وتخزينه

1 تأكد من أن قرص البخار في وضع إيقاف التشغيل وأن الجهاز غير متصل بالطاقة.

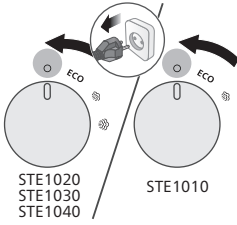

2 تأكد من أن الحديد قد برد تمامًا (أكثر من ساعة واحدة).

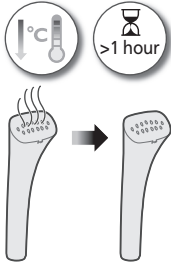

3 امسح الجهاز البخاري بقطعة قماش مبللة.

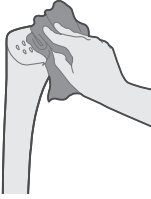

4 أفرغ خزان المياه بالكامل.

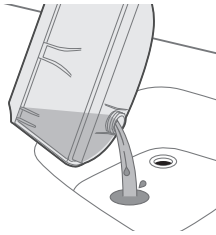

5 قم بتدوير سلك الطاقة حول القاعدة.

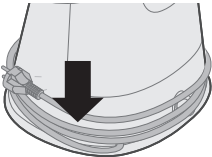

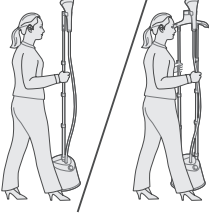

استكشاف الأخطاء وإصلاحها

يلخص هذا الفصل المشاكل الأكثر شيوعاً التي قد تصادفها عند استخدام الجهاز. في حال لم تتمكن من حل المشكلة بواسطة المعلومات الواردة أدناه، ففضل بزيارة www.philips.com/support للاطلاع على لائحة الأسئلة المتداولة أو اتصل بمركز خدمة المستهلك في بلدك.

المشكلة	السبب المحتمل	الحل
لا يخرج الجهاز دفق بخار أو يخرج دفق بخار غير منتظم.	لم يتم إحماء الجهاز البخاري لوقت كافٍ.	دعي الجهاز يحمى لمدة 45 ثانية تقريباً (STE1010/75: حوالي دقيقتين).
	تم تكثيف البخار في الخرطوم.	ارفع رأس الجهاز البخاري لوضع الخرطوم بشكل مستقيم. يسمح هذا الأمر بإرجاع أي دفق تكثيف.
	مستوى المياه في الخزان منخفض أو لم يتم إدخال الخزان بطريقة صحيحة.	أعد ملء خزان المياه وأدخله بالطريقة الصحيحة.
	تراكمت ترسبات كثير في الجهاز.	شغل وظيفة إزالة الكلس. راجع قسم إزالة الكلس.
تنسرب قطرات الماء من رأس الجهاز البخاري أو يصدر الجهاز صوت نعيب.	لقد تركت رأس الجهاز البخاري و/أو خرطوم تزويد البخار بوضعية أفقية لفترة طويلة.	ارفع رأس الجهاز البخاري لوضع الخرطوم بشكل مستقيم. يسمح هذا الأمر بإرجاع أي دفق تكثيف.
	عندما يكون الخرطوم على شكل U، لا يمكن إرجاع دفق التكثيف إلى خزان الماء.	ارفع رأس الجهاز البخاري لوضع الخرطوم بشكل مستقيم. يسمح هذا الأمر بإرجاع أي دفق تكثيف.
تنسرب كمية كبيرة من المياه من رأس الجهاز البخاري عندما يكون الجهاز قيد الإحماء.	إن المياه المتوفرة في الجهاز وسخة أو تم تركها في الجهاز لفترة طويلة.	شغل وظيفة إزالة الكلس. راجع قسم تنظيف الكلس.
تنسرب المياه من قاعدة الجهاز البخاري.	لم تغلق غطاء خزان المياه أو مفتاح إزالة الكلس بإحكام. لم تقم بإدخال خزان الماء بطريقة صحيحة.	أغلق غطاء خزان المياه أو مفتاح إزالة الكلس بإحكام. أدخل الخزان بشكل صحيح.

مقدمه

به دنیای محصولات Philips خوش آمدید. به شما برای خرید این محصول تبریک می‌گوییم! برای استفاده بهینه از خدمات پس از فروش Philips، دستگاه خود را در سایت www.philips.com/welcome ثبت نام کنید. این راهنمای کاربر، پرشور اطلاعات مهم و راهنمای شروع سریع را قبل از استفاده از دستگاه به دقت مطالعه کنید. آنها را برای مراجعات بعدی نزد خود نگه دارید.

نمای کلی دستگاه

STE1040، STE1030، STE1020

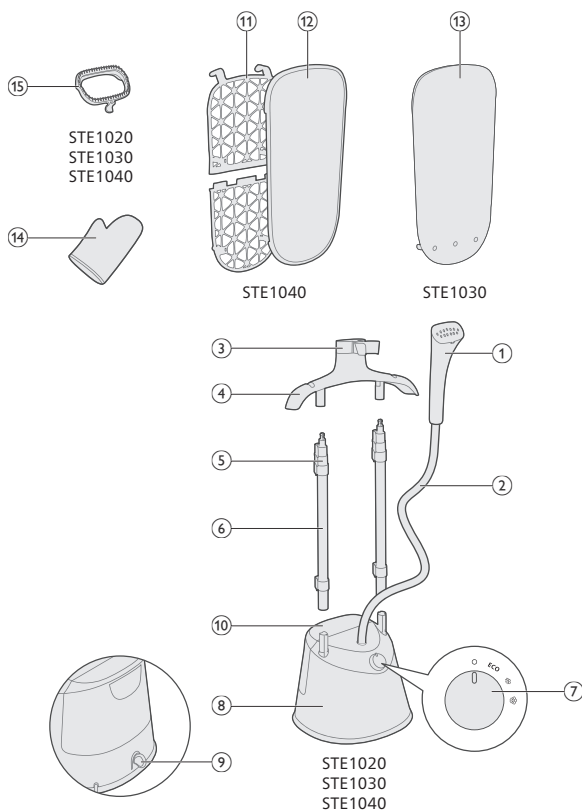

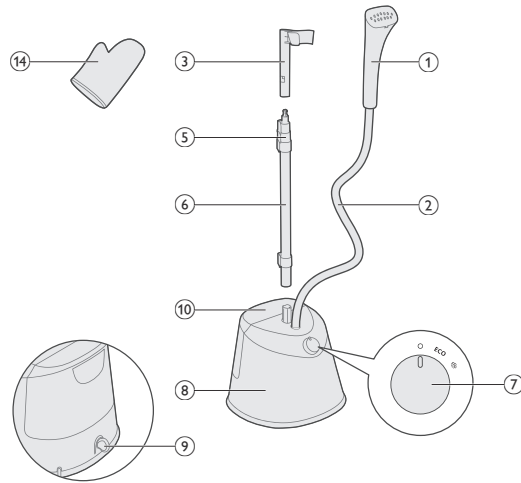

- 1 سر بخارشو
- 2 شلنگ تأمین بخار
- 3 پایه بخارشو
- 4 آویز (STE1040 p, STE1030 p, STE1020)
- 5 گیره قفل پایه آویز لباس
- 6 پایه آویز لباس
- 7 پیچ تنظیم بخار
- 8 ظرف اصلی
- 9 پیچ رسوب زدایی
- 10 مخزن آب
- 11 تخته اتو (STE1040)
- 12 روکش (STE1040)
- 13 مت (STE1030)
- 14 دستکش
- 15 برس (STE1040 p, STE1030 p, STE1020)

آماده سازی برای استفاده

نوع آب مورد استفاده

این دستگاه جهت استفاده با آب لوله طراحی شده است. اگر در منطقه‌ای زندگی می‌کنید که آب سخت است، توصیه می‌کنیم مقدار مساوی آب لوله و آب مقطر یا بدون املاح را مخلوط کنید. این کار از تشکیل سریع رسوب جلوگیری کرده و عمر دستگاه را افزایش می‌دهد.

از استفاده از آب معطر، آب خنثک‌کن، سرکه، نشاسته، مواد رسوب‌زدا، مواد کمکی اتو، آب رسوب‌زدایی شده با مواد شیمیایی یا سایر مواد شیمیایی خودداری کنید چون ممکن است باعث خشک شدن آب، ایجاد لکه‌های قهوه‌ای یا آسیب به دستگاه شود.

هشدارها

1 هیچ قسمتی از پوست را در تماس مستقیم با بخار قرار ندهید.

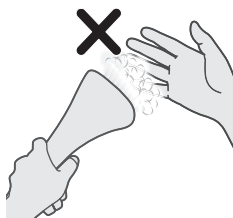

2 صفحه بخار را به سمت افراد دیگر هدف نگیرید.



3 لباس خود را طوری ننگه ندارید که در تماس مستقیم با بخار باشد.



4 از سر بخار در جهت پایین استفاده نکنید.

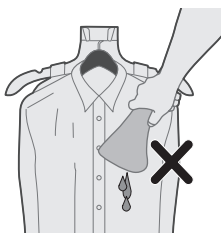

5 برای بخار دادن لباس، شلنگ را خم نکنید.

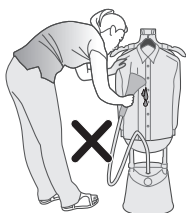

6 بخارشوی ایستاده را بیش از 5 دقیقه بدون توجه رها نکنید.

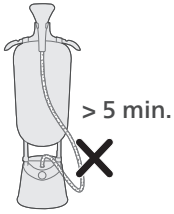

راه اندازی دستگاه

1 به قطعات موجود برای دستگاه خریداری شده خود توجه داشته باشید.

STE1010

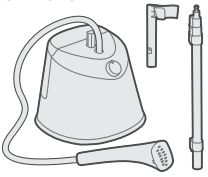

STE1020, STE1030

STE1040



STE1010

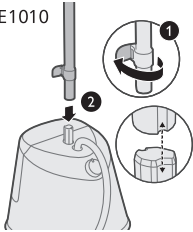

2 گیره های قفل میله پایین را باز کنید و میله(ها) را روی پایه قرار دهید. مطمئن شوید که پروفیل های میله (ها) و گل میخ (های) پایه در یک راستا قرار دارند.

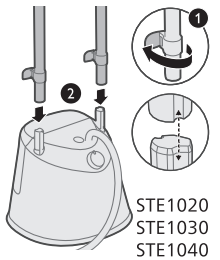

STE1020
STE1030
STE1040

3 گیره(های) قفل میله پایین را قفل کنید.

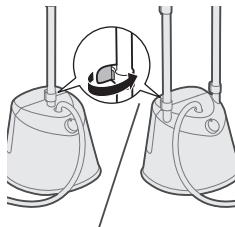

4 سایر گیره‌های قفل میله را باز کنید، میله(ها) را کاملاً به سمت بالا بکشید و قفل کنید.

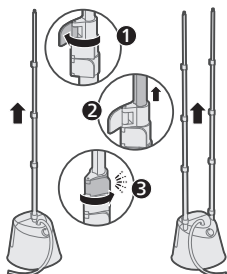

5 پایه بخارشو را روی میله(ها) قرار دهید تا در جای خود قفل شود («کلیک کنید»).

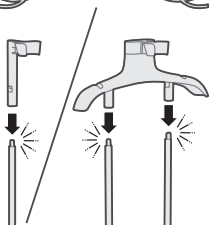

6 سر بخارشو را روی پایه بخارشو قرار دهید.

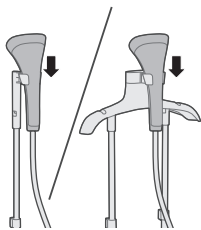

تنظیم تخته اتو

1 به قطعات موجود برای دستگاہ خریداری شده خود توجه داشته باشید.

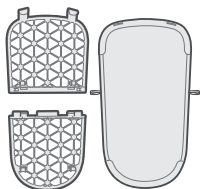

2 گیره‌های تخته را تراز کرده و داخل آن قرار دهید تا در جای خود قفل شود («کلیک»).

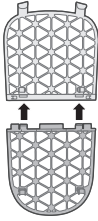

3 روکش تخته را تراز کرده و از طریق قلاب‌های تخته وارد کنید.



4 تسمه‌های پوشش تخته را به قلاب‌های پشت تخته وصل کنید

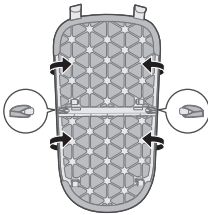

5 تخته را روی آویز قرار دهید.

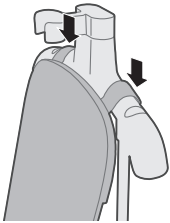

6 تخته را روی میله‌ها محکم کنید تا در جای خود قفل شود («کلیک کنید»).

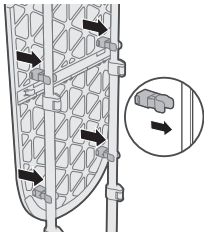

7 می توانید با استفاده از آویز لباس های خود را بپوشانید.

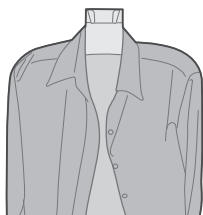
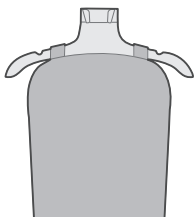

8 می توانید از آویز خودتان استفاده کنید و آن را روی پایه بخارشو قرار دهید.

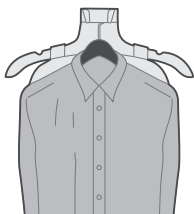

تنظیم مت

1 بند وسط را از پایه بخارشو وارد کنید.

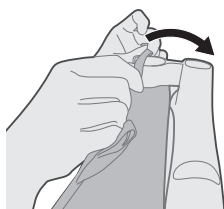

2 بند را روی قلاب پشت آویز محکم کنید.

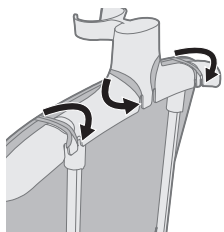

3 مت را روی میله ها محکم کنید تا در جای خود قفل نشود («کلیک کنید»).

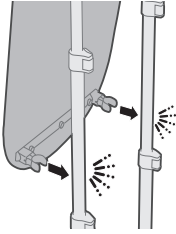

4 می توانید با استفاده از آویز لباس های خود را بپوشانید.

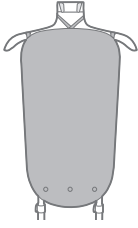

5 می توانید از آویز خودتان استفاده کنید و آن را روی پایه بخارشو قرار دهید.



قرار دادن برسی

1 مسیر را در امتداد بالای سر بخاری تراز کنید و گیره را در پایین بچسبانید («کلیک کنید»).

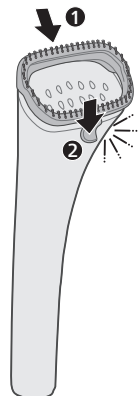

2 می توانید دستکش را بیوشید و لباس های خود را با استفاده از ضمیمه برس بخار کنید.

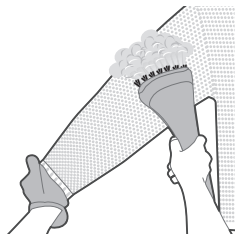

3 گیره را از پایین سر بخارشو بگیرید و بیرون بکشید تا ضمیمه برس جدا شود.

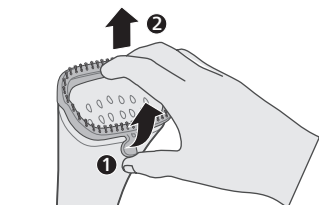

پرکردن مخزن آب

1 دستگاه را به برق وصل نکنید. مخزن آب را از پایه جدا کنید.

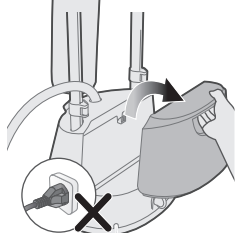

2 مخزن آب را طوری بچرخانید که دریوش مخزن آب رو به بالا باشد.

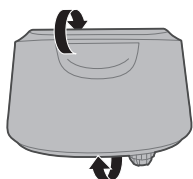

3 دریوش مخزن آب را در خلاف جهت عقربه های ساعت بچرخانید تا جدا شود.

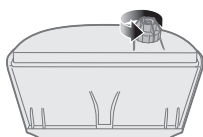

4 مخزن آب را پر کنید.

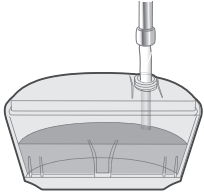

5 درپوش مخزن آب را در جهت عقربه های ساعت پیچ کنید تا سفت شود.

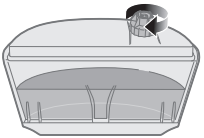

6 با قلاب تراز کنید تا مخزن آب به پایه بازگردد.

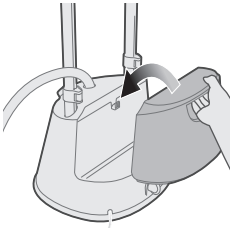

تغییر تنظیمات بخارشو

1 مطمئن شوید که دستگاه به برق وصل است. صفحه بخار را روی تنظیم درجه مورد نظر بخار بچرخانید.

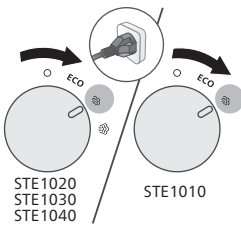

2 چراغ ثابت می شود تا نشان دهد که بخارشوی ایستاده روشن است.

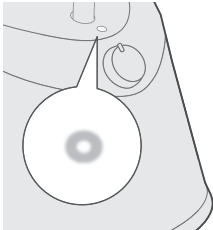

*STE1010/75: ~2 min

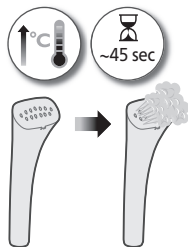

3 حدود 45 ثانیه صبر کنید تا بخارشوی ایستاده گرم شود و بخار پخش نشود (STE1010/75): حدود 2 دقیقه).

نکات اتو کردن

1 می توانید از آویز خودتان استفاده کنید و آن را روی پایه بخارشوی قرار دهید.

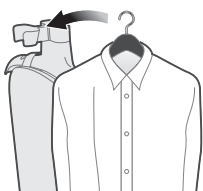

2 سر بخار شو را در جهت موازی با یقه حرکت دهید.

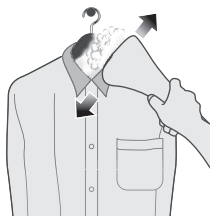

3 سر بخارشوی با یوک در جهت افقی حرکت دهید.

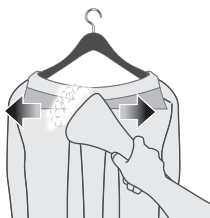

4 لباس را پهن کنید. سر بخار شو را رو به پایین در قسمت جلوی بدنه حرکت دهید.

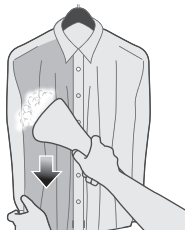



5 سر بخارشو را رو به بالا روی یک جیب حرکت دهید.

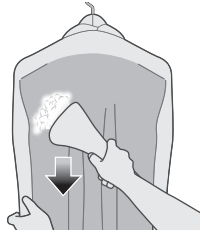

6 لباس را پهن کنید. سر بخار را رو به پایین روی بدنه به عقب حرکت دهید.

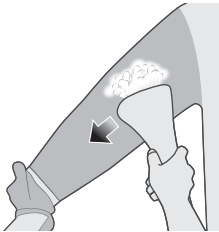

7 لباس را پهن کنید. سر بخار شو را موازی با آستین حرکت دهید.

تمیز کردن و مراقبت از دستگاه

رسوب‌گیر

دستگاه شما با سیستم رسوب‌زدایی طراحی شده است. به شما توصیه می‌شود که یک یا چند بار در ماه رسوب‌زدایی را انجام دهید. این کار باعث می‌شود سطح عملکرد بخار ثابت باقی بماند و از خروج آلودگی از کف اتو جلوگیری شود.

نکته: سیستم رسوب‌زدایی را می‌توان در هر زمانی استفاده کرد. اگر در منطقه‌ای زندگی می‌کنید که آب سخت است، از این عملکرد بیشتر استفاده کنید.

رسوب‌زدایی را انجام دهید.

1 مطمئن شوید که صفحه بخار در موقعیت OFF قرار دارد و دستگاه از برق جدا شده است.

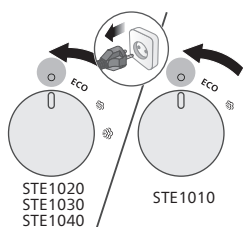

2 مطمئن شوید که اتو کاملاً خنک شده است (بیش از 1 ساعت).



3 بخارشو را نزدیک یک زهکنش قرار دهید.

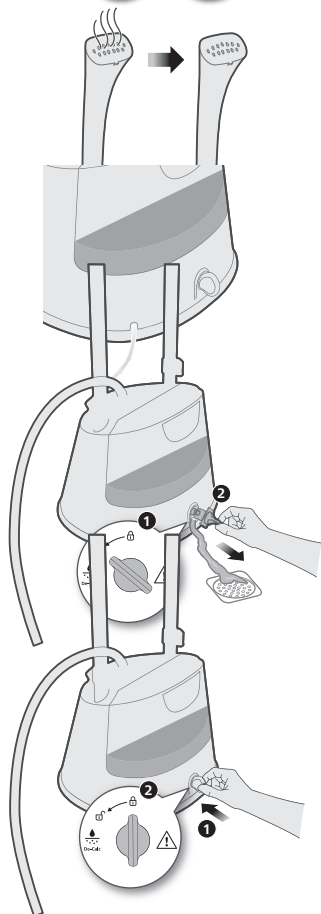

4 دستگیره رسوب‌گیر (De-calc) را در موقعیت باز کردن قفل بچرخانید و دستگیره De-calc را جدا کنید اجازه دهید آب تخلیه شود.

5 دستگیره De-calc را در محل قفل قرار داده و بچرخانید.

تمیز کردن و نگهداری بخارشوی ایستاده

1 مطمئن شوید که صفحه بخار در موقعیت OFF قرار دارد و دستگاه از برق جدا شده است.

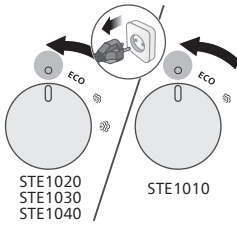

2 مطمئن شوید که اتو کاملاً خنک شده است (بیش از 1 ساعت).

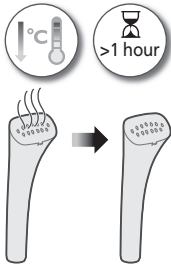

3 محل بخار را با یک پارچه مرطوب پاک کنید.

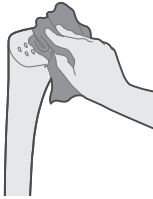

4 مخزن آب را خالی کنید.

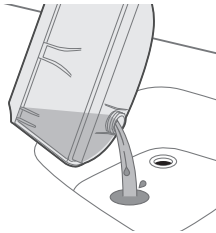

5 سیم برق را دور پایه بپیچید.

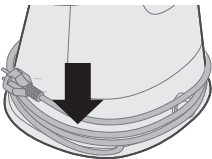

6 شما می توانید بخارشوی ایستاده را توسط میله جابجا کنید.

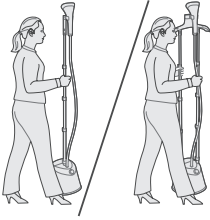

عیب یابی

خلاصه ای از اشکالاتی که ممکن است معمولاً هنگام کار با دستگاه برای شما پیش آید در این بخش گنجانده شده است. اگر نمی‌توانید مشکل را با اطلاعات زیر برطرف کنید، جهت مشاهده لیست سؤالات متداول، از سایت www.philips.com/support بازدید کنید یا با مرکز خدمات مشتری در کشور خود تماس بگیرید.

اشکال	علت احتمالی	راه حل
دستگاه بخار تولید نمی‌کند یا به طور نامنظم بخار تولید می‌کند.	بخارشوی لباس به اندازه کافی گرم نمی‌شود.	اجازه دهید دستگاه حدود 45 ثانیه گرم شود (STE1010/75: حدود 2 دقیقه).
	بخار به صورت قطرات آب در لوله جمع شده است.	سر بخارشو را بالا ببرید تا لوله به صورت عمودی و صاف قرار بگیرد. این باعث می‌شود قطرات آب به مخزن برگردند.
	سطح آب داخل مخزن کم است یا مخزن درست جا نیفتاده است.	مخزن آب را دوباره پر کنید یا مخزن را درست وارد کنید.
	مقدار زیادی رسوب در دستگاه تشکیل شده است.	رسوب‌زدایی را انجام دهید. به بخش رسوب‌زدایی مراجعه کنید.
قطرات آب از سر بخارشو چکه می‌کند یا دستگاه صدای نامالیمی ایجاد می‌کند.	سر بخارشو و/یا لوله بخار را برای مدت طولانی در وضعیت افقی قرار داده‌اید.	سر بخارشو را بالا ببرید تا لوله به صورت عمودی و صاف قرار بگیرد. این باعث می‌شود قطرات آب به مخزن برگردند.
	وقتی لوله بخار حالت U شکل به خود می‌گیرد، قطرات آب داخل لوله نمی‌توانند به مخزن آب برگردند.	سر بخارشو را بالا ببرید تا لوله به صورت عمودی و صاف قرار بگیرد. این باعث می‌شود قطرات آب به مخزن برگردند.
وقتی دستگاه در حال گرم شدن است، مقدار بسیار زیادی قطرات آب از سر بخارشو خارج می‌شود.	آب دستگاه کثیف است یا برای مدت طولانی در دستگاه باقی مانده است.	رسوب‌زدایی را انجام دهید. به بخش رسوب‌زدایی مراجعه کنید.
آب از بدنه اصلی بخارشو نشت می‌کند.	درپوش مخزن آب یا پیچ رسوب‌زدایی را محکم نبسته‌اید. مخزن آب درست جاگذاری نشده است.	درپوش مخزن آب یا پیچ رسوب‌زدایی را محکم ببندید. مخزن آب را به طور صحیح وارد کنید.

RU

Вертикальный отпариватель для одежды

Изготовитель: «ДАП Б.В.», Туссендиепен 4 а, 9206АД, Драхтен, Нидерланды

Импортер: дополнительную информацию смотри во вложении.

STE1020, STE1030, STE1040: 1512-1800Вт, 220-240В, 50-60Гц

Для бытовых нужд

Прибор класса I

Сделано в Китае

Условия хранения, эксплуатации

Температура: +0°C - +35°C

Относительная влажность: 20% - 95%

Атмосферное давление: 85 - 109кPa

KK

Киім тигінен булагыш

Өндүрүш: «ДАП Б.В.», Туссендиепен 4 а, 9206АД, Драхтен, Нидерланды

Импорттаушы: косымша ақпаратты қолданбадан қараңыз.

STE1020, STE1030, STE1040: 1512-1800W, 220-240V, 50-60Hz

Тұрмыстық қажеттіліктерге арналған

I санатты аспап

Қытайда жасалған

Сақтау шарттары, пайдалану

Температура: +0°C - +35°C

Салыстырмалы ылғалдылық: 20% - 95%

Атмосфералық қысым: 85 - 109кPa

HY

Ուղղահայաց գոլորշեփափկացուցիչ զգեստի համար

Արտադրող: «ԴԱՊ Բ.Վ.», Տուսսենդիեպեն 4 ա, 9206ԱԴ, Դրահտեն, Նիդերլանդներ

Ներկրող: Լրացուցիչ տեղեկությունների համար տես հավելվածը.

STE1020, STE1030, STE1040: 1512-1800W, 220-240V, 50-60Hz

Կենցաղային կարիքների համար

Ասար I դասի

Պատրաստված է Չինաստանում

Պահպանման, շահագործման կանոններ

Ձերմաստիճան՝ +0°C - +35°C

Պարաբերական խոնավություն՝ 20% - 95%

Արևոլորտային ճնշում՝ 85 - 109кPa

KY

Тигинен кийимди буулап үтүктөөчү

Өндүрүүчү: «ДАП Б.В.», Нидерланд, Драхтен, 9206АД, Туссендиепен 4 а

Импорттоочу: кошумча маалымат алуу үчүн тиркемени караныз.

STE1020, STE1030, STE1040: 1512-1800W, 220-240V, 50-60Hz

Үй тиричилигине керектөө үчүн

I класстагы жабдык

Кытайда жасалган

Сактоо шарты, иштетүү

Температура: +0°C - +35°C

Тийиштүү нымдуулугу: 20% - 95%

Атмосфералык басым: 85 - 109кPa

PHILIPS and the Philips Shield Emblem are registered trademarks of Koninklijke Philips N.V. and are used under license.

This product has been manufactured by and is sold under the responsibility of Versuni Holding B.V., and Versuni Holding B.V. is the warrantor in relation to this product.

2024 © Versuni Holding B.V.

642001008786 (06/2024)

EAC

