



EN

GB

IE

# INSTRUCTIONS FOR USE OF A BUILT-IN OVEN

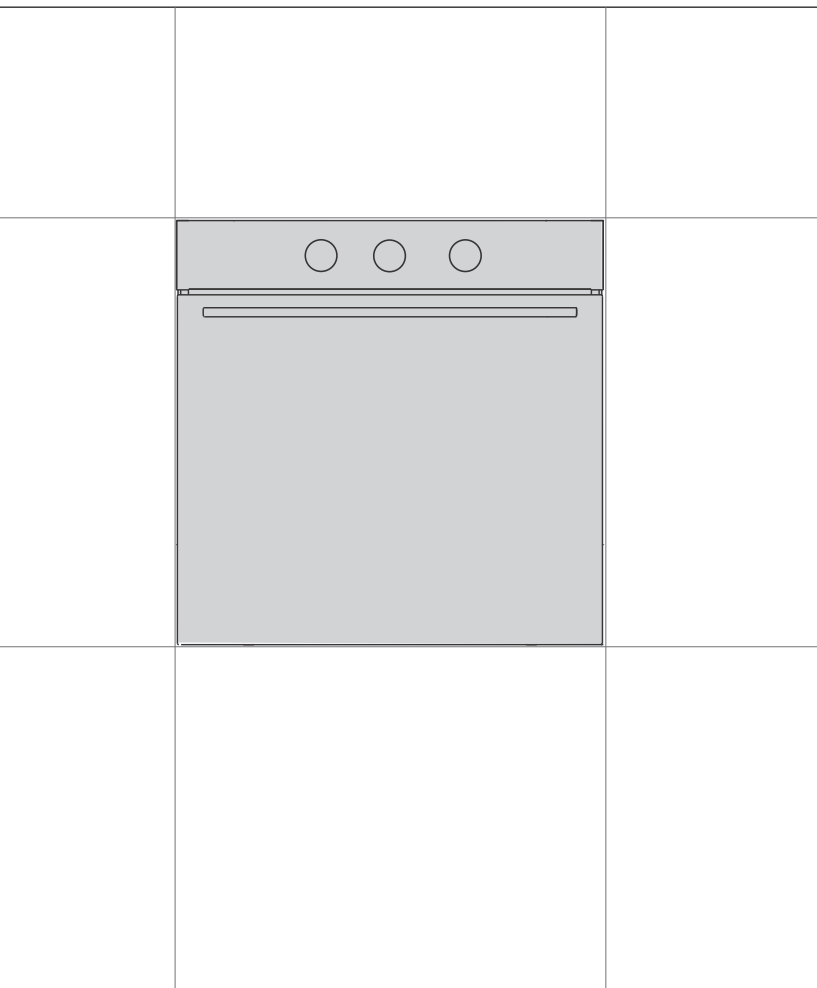

We thank you for your trust and the purchase of our appliance.

This detailed instruction manual is supplied to make the use of this product easier. The instructions should allow you to learn about your new appliance as quickly as possible.

Make sure you have received an undamaged appliance. If you do find transport damage, please contact the seller from which you purchased the appliance, or the regional warehouse from which it was supplied. The telephone number can be found on the invoice or on the delivery note.

Instructions for installation and connection are supplied on a separate sheet.

Instructions for use, installation and connection are also available at our website:

<http://www.gorenje.com>

The following symbols are used throughout the manual and they have the following meanings:



**INFORMATION!**

Information, advice, tip, or recommendation



**WARNING!**

Warning – general danger



It is important that you carefully read the instructions.

# Contents

<b>Safety precautions</b> .....	<b>4</b>
<b>Other important safety warnings</b> .....	<b>6</b>
<b>Appliance description</b> .....	<b>7</b>
Rating plate – product information .....	7
Control unit .....	8
Control lights .....	8
<b>Appliance equipment</b> .....	<b>9</b>
Guides .....	9
Oven door switch .....	10
Cooling fan .....	10
Oven equipment and accessories .....	10
<b>Before first use</b> .....	<b>12</b>
<b>Switching on for the first time</b> .....	<b>12</b>
<b>Choosing the settings</b> .....	<b>12</b>
CHOOSING THE COOKING SYSTEM .....	12
TEMPERATURE SETTING .....	14
TIMER FUNCTIONS .....	14
<b>Starting the cooking process</b> .....	<b>17</b>
<b>End of cooking and switching off the oven</b> .....	<b>17</b>
<b>General tips and advice for baking</b> .....	<b>18</b>
<b>Cooking table</b> .....	<b>19</b>
<b>Cleaning and maintenance</b> .....	<b>23</b>
Using the Aqua Clean program to clean the oven .....	24
Removing wire and fixed pull-out (extendible) guides .....	25
Removing and replacing the oven door and glass panes .....	25
Replacing the bulb .....	27
<b>Troubleshooting table</b> .....	<b>28</b>
Special warnings and fault reporting .....	28
<b>Disposal</b> .....	<b>29</b>

## Safety precautions



### **IMPORTANT SAFETY PRECAUTIONS – CAREFULLY READ THE INSTRUCTIONS AND SAVE THEM FOR FUTURE REFERENCE.**

Appliance must be connected to fixed wiring which has incorporated means of disconnection. Fixed wiring must be made in accordance with the wiring rules.

Means for disconnection must be incorporated in the fixed wiring in accordance with the wiring rules.

The appliance must not be installed behind a decorative door in order to avoid overheating.

If the supply cord is damaged, it must be replaced by the manufacturer, its service agent or similarly qualified persons in order to avoid a hazard (only for appliances supplied with connection cord).

During use the appliance becomes hot. Care should be taken to avoid touching the heating elements inside the oven.

This appliance can be used by children aged 8 years and above, and by persons with reduced physical, sensory or mental capabilities or lack of experience and knowledge, if they have been given supervision or instruction concerning the use of the appliance in a safe way, and if they understand the hazards involved. Children shall not play with the appliance. Cleaning and user maintenance shall not be done by children without supervision.

**WARNING:** Accessible parts may become hot during use. Young children should be kept away.

**WARNING:** The appliance and some of its accessible parts may become very hot during use. Care should be taken to avoid touching heating elements. Children less than 8 years of age shall be kept away unless continuously supervised.

The appliance is not intended to be controlled by external timers or separate remote control system.

Do not use harsh abrasive cleaners or sharp metal scrapers to clean the oven door glass/ the glass of hinged lids of the hob (as appropriate), since they can scratch the surface, which may result in shattering of the glass.

Do not use steam cleaners or high-pressure cleaners to clean the appliance as this may result in an electric shock.

**WARNING:** Before replacing the light bulb, make sure the appliance has been disconnected from the mains power, in order to prevent the hazard of an electric shock.

Never pour water directly on the bottom of the oven cavity. Temperature differences could result in damage to the enamel coating.

## Other important safety warnings

The appliance is intended for household use. Do not use it for any other purpose, such as room heating, drying of pets or other animals, paper, fabrics, herbs etc. As this may lead to injury or fire hazard.

Appliance must be connected to fixed wiring which has incorporated means of disconnection. Fixed wiring must be made in accordance with the wiring rules.

Do not lift the appliance by holding it by the door handle.

Oven door hinges may be damaged when under excessive load. Do not stand or sit on the open oven door, and do not lean against it. Also, do not place any heavy objects onto the oven door.

If the power cords of other appliances placed near this appliance get entangled in the oven door, they can be damaged, which in turn can result in a short circuit. Therefore, make sure the power cords of other appliances are always at a safe distance.

Oven door become very hot during operation. A third glass is installed for extra protection, reducing the temperature of the outside surface (only with some models).

Make sure the vents are never covered or obstructed in any other way.

Do not line the oven cavity with aluminium foil, and do not place any baking trays or other cookware on the oven bottom. This would obstruct and reduce air circulation in the oven, slow down the baking process, and destroy the enamel coating.

We recommend you avoid opening the oven door during baking, as this increases power consumption and increases condensate accumulation.

At the end of the baking process, and during baking, be careful when opening the oven door, as there is danger of scalding.

To prevent limescale accumulation, leave the oven door open after baking or using the oven, to allow the oven cavity to cool down to room temperature.

Clean the oven when it has completely cooled down.

Eventual mismatches in colour shades between different appliances or components within a single design line may occur due to various factors, such as different angles under which the appliances are observed, different coloured backgrounds, materials, and room illumination.

Never pour water onto the oven cavity bottom. Temperature differences could result in damage to the enamel coating.

Do not use the appliance if it is damaged. Call an authorized service centre.



### **WARNING!**

**Carefully read the instructions for use before connecting the appliance. Repair or any warranty claim resulting from incorrect connection or use of the appliance shall not be covered by the warranty.**

# Appliance description



## INFORMATION!

Appliance functions and equipment depend on the model.

Basic equipment of your appliance includes wire guides, shallow baking tray, and a wire rack.

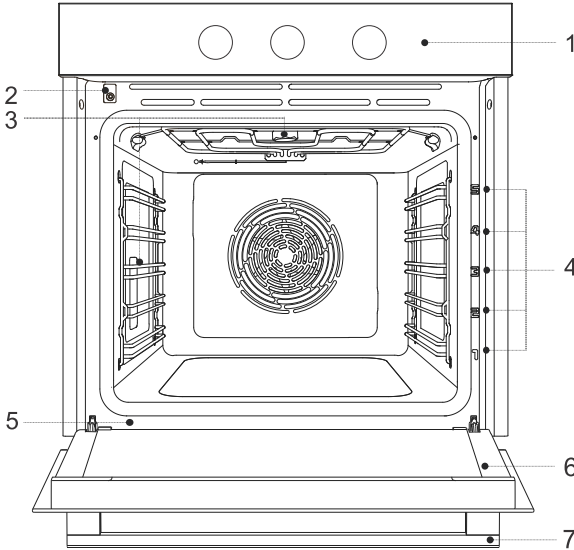

- |                           |                |
|---------------------------|----------------|
| 1 Control unit            | 5 Rating plate |
| 2 Door switch             | 6 Oven door    |
| 3 Lighting                | 7 Door handle  |
| 4 Guides – cooking levels |                |

## Rating plate – product information

A rating plate with basic information about the appliance is attached to the edge of the oven. Precise information on appliance type and model can also be found on the warranty sheet.

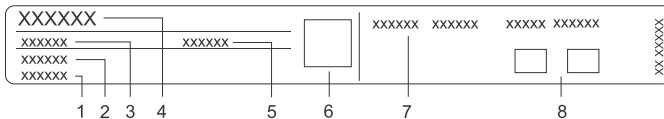

- |                 |                                    |
|-----------------|------------------------------------|
| 1 Serial number | 5 Code/ID                          |
| 2 Model         | 6 QR code (depending on the model) |
| 3 Type          | 7 Technical information            |
| 4 Brand         | 8 Compliance indications/symbols   |

## Control unit

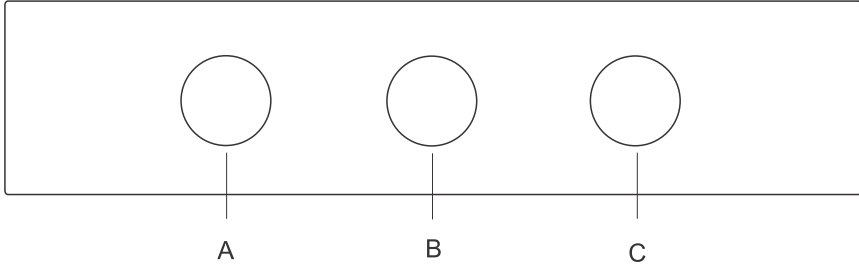

- A. cooking system selector knob
- B. Electronic program timer
- C. Temperature settings knob

## Control lights

**Signal lamp:** the light is on when the oven heaters are activated. When the selected temperature is reached, the light is switched off.



# Appliance equipment

## Guides

- The guides allow cooking or baking on 5 rack levels.
- The height levels of guides into which the racks can be inserted shall be counted from bottom up.
- Guide levels 4 and 5 are intended for grilling/broiling.
- When inserting equipment, it should be correctly rotated.

## Wire guides

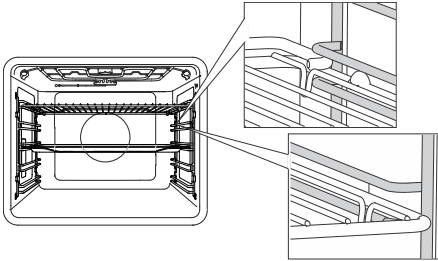

In case of wire guides, always insert the wire rack and the baking tray into the slot between the upper and lower part of each guide level.

## Fixed pull-out guides

(depending on the model)

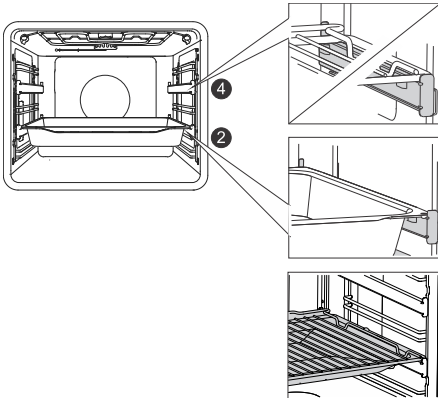

Pull-out guides may be fitted for the 2nd and 4th level.

In case of fixed pull-out guides, place the rack or baking tray onto the guide. You can place the wire rack directly onto a baking tray (shallow or deep all-purpose baking tray) and place both onto the same guide; in this case, the baking tray acts as a drip tray.

## Click-on pull-out guides

(depending on the model)



The click-on pull-out guide can be inserted into any space between two wire guides.

Place the guide symmetrically onto the wire guides on the left and the right side of the oven cavity. First, hook the upper clip of the guide under the wire of the wire guide. Then, press the lower clip into the right position until you hear a **CLICK**.

**NOTE:** The guides can be attached to any height between two levels of wire guides.



### INFORMATION!

The click-on pull-out guides cannot be mounted onto guides with fixed double-level partial extension. They can, however, be mounted on to single-level partially extendible guides, to levels 3-4 and 4-5.

Make sure the pull-out guide is correctly rotated and that it extends outwards, i.e. out from the oven.

## Oven door switch

(depending on the model)

If the oven door is opened during oven operation, the switch turns off the heater and fan in the oven cavity. When the door is closed, the switch turns the appliance operation back on.

## Cooling fan

The appliance is fitted with a cooling fan that cools the housing, the door, and the appliance control unit. After the oven is switched off, the cooling fan continues to operate for a short while in order to cool down the oven.

## Oven equipment and accessories

(depending on the model)



The **WIRE RACK** is used for grilling/broiling or as support for a pan, baking tray or baking dish with the food you are baking.



### INFORMATION!

There is a safety latch on the wire rack. Therefore, the wire rack has to be lifted slightly at the front when pulling it out from the oven.



**SHALLOW BAKING TRAY** is used for flat and small pastry. It can also be used as a drip tray.



**WARNING!**

The shallow baking tray may deform as it heats up in the oven. Once it cools down, it returns to the initial shape. Such deformation does not affect its function.

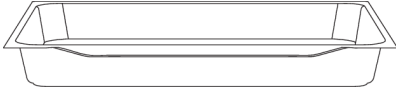

The **ALL-AROUND DEEP BAKING TRAY** is used for roasting vegetables and baking moist pastry. It can also be used as a drip tray.



**INFORMATION!**

Never insert the all-purpose (or universal) deep baking tray into the first guide during baking.



**WARNING!**

The appliance and some of the accessible parts tend to heat up during cooking.

## Before first use

- Remove oven accessories and any packaging (cardboard, polystyrene foam) from the oven.
- Wipe the oven accessories and interior with a damp cloth. Do not use abrasive or aggressive cloths or cleaners.
- Heat an empty oven for approximately one hour with the top and bottom heater system at a temperature of 250 °C. The characteristic "new oven scent" will be released; therefore, ventilate the room thoroughly during this process.

## Switching on for the first time

After connecting your appliance for the first time or after an extended power outage, the symbol  will flash on the display.

In order for the oven to operate, press the timer button and hold it for 2 seconds. Time display will stop flashing. The oven can be used without restrictions if no timer settings are made.

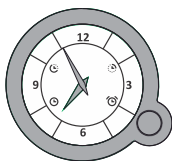

### CLOCK SETTING

Press the timer button repeatedly to select the clock symbol ; the symbol will start flashing.

Rotate the timer button to set the time. Confirm the setting by pressing the button again. If nothing is pressed, the setting will be stored automatically after a few seconds. Each time you press the button, this will be confirmed by a short acoustic signal.

## Choosing the settings

### CHOOSING THE COOKING SYSTEM



Rotate the KNOB (left and right) to select the COOKING SYSTEM (see program table).



### INFORMATION!

Funkcije in oprema aparata so odvisni od modela.





simbol	uporaba
	<b>HITRO PREDGRETJE PEČICE</b> Za čim hitrejšo doseganje nastavljene temperature. Ko se pečica ogreje na nastavljeno temperaturo, se oglasi kratek zvočni signal. Sledi nastavev sistema, ki ga želite uporabiti za pripravo živila. Ta funkcija ni primerna za peko jedi.
	<b>ZGORNJE IN SPODNJE GRELO Z VENTILATORJEM</b> Za enakomerno peko jedi na enem nivoju ter pripravo suflejev.
	<b>VELIKI ŽAR Z VENTILATORJEM</b> Za peko perutnine in večjih kosov mesa na žaru.

Table continued from last page

simbol	uporaba
	<p><b>INTENZIVNO PEČENJE (AIR FRY)<sup>1)</sup></b></p> <p>Takšen način peke daje hrani hrustljivo skorjico brez dodanih maščob. Gre za zdravo različico priprave »hitre hrane«, z manjšo vsebnostjo kalorij. Primerno za manjše kose mesa, ribe, zelenjavo in predhodno pripravljene zamrznjene izdelke (pomfrit, piščančji medaljoni).</p> <p>Dodatek pare površino hrane bolj zapeče in ustvari večjo hrustljivost.</p>
	<p><b>VROČI ZRAK<sup>1)</sup></b></p> <p>Vroči zrak omogoča večji pretok toplega zraka okoli bremena. Na ta način bolj izsuši njegovo površino ter ustvari debelejšo skorjo. Za pečenje mesa, peciva in zelenjave ter za sušenje živil na enem ali več nivojih hkrati.</p> <p>Dodatek pare površino hrane bolj zapeče in ustvari večjo hrustljivost.</p>
	<p><b>ZGORNJE IN SPODNJE GRELO<sup>1)</sup></b></p> <p>Za tradicionalno pečenje jedi na enem nivoju, pripravo suflejev ter za pečenje pri nizkih temperaturah (počasno pečenje).</p> <p>Dodatek pare površino hrane bolj zapeče in ustvari večjo hrustljivost.</p>
	<p><b>ZGORNJE IN SPODNJE GRELO<sup>1)</sup></b></p> <p>Za tradicionalno pečenje jedi na enem nivoju, pripravo suflejev ter za pečenje pri nizkih temperaturah (počasno pečenje).</p> <p>Dodatek pare površino hrane bolj zapeče in ustvari večjo hrustljivost.</p>
	<p><b>ZGORNJE IN SPODNJE GRELO<sup>1)</sup></b></p> <p>Za tradicionalno pečenje jedi na enem nivoju, pripravo suflejev ter za pečenje pri nizkih temperaturah (počasno pečenje).</p> <p>Dodatek pare površino hrane bolj zapeče in ustvari večjo hrustljivost.</p>
	<p><b>VELIKI ŽAR</b></p> <p>Za pečenje večjih količin ploščatih živil (opečenega kruha, obloženih kruhkov, žar klobas, zrezkov, rib, nabodal, ipd.) ter za gratiniranje in doseganje hrustljave skorje živil. Enakomerno se segreje celotna površina pod grelci, ki so nameščeni na strop pečice.</p> <p>Maksimalna dovoljena temperatura 240 °C.</p>
	<p><b>POČASNA PEKA<sup>2)</sup></b></p> <p>Za nežno, počasno in enakomerno peko mesa, rib in peciva na enem nivoju. Takšen način pečenja ohrani večji delež vode v mesu, zaradi česar le-to ostane sočnejše in mehkejše, pecivo pa je enakomerno porjavelo/pečeno. Uporablja se v temperaturnem območju od 140 °C do 220 °C.</p>
	<p><b>SISTEM ZA PICO</b></p> <p>Optimalno za peko pice ter peciva z večjo vsebnostjo vode. Za pečenje na enem nivoju, kadar želite čim hitreje pečene in hrustljave jedi.</p>
	<p><b>PEKA ZAMRZNJENIH ŽIVIL</b></p> <p>Ta način omogoča peko zamrznjenih živil v krajšem času brez potrebnega predgretja. Optimalno za predhodno pripravljene zamrznjene izdelke (pekovski izdelki, rogljički, lazanja, pomfrit, piščančji medaljoni), meso in zelenjavo.</p>
	<p><b>ODTAJANJE</b></p> <p>Uporablja se za kontrolirano odtajevanje zamrznjene hrane (tort, kolačev, peciva, kruha in žemljic ter globoko zamrznjenega sadja). Med odtajevanjem kose hrane obrnite, premešajte in ločite, če so bili primrzni eni eden na drugega. Zaradi mikrobiološke varnosti hrane priporočamo za meso in delikatna živila počasno odtajanje v hladilniku.</p>
	<p><b>AQUA CLEAN</b></p> <p>Program omogoča lažje odstranjevanje madežev v pečici.</p>

Table continued from last page

simbol	uporaba
	<b>PEČNIŠKA LUČKA</b> Pečniška lučka se vklopi ob izbranem sistemu in kadar obrnete gumb na pozicijo lučke.

- 1)  Pri teh sistemih lahko pečete jedi z dodatkom pare. Ob izbiri sistema deluje osnovna funkcija. Z uporabo pekača z vodo funkcijo spremenite v pečenje z dodatkom pare (glejte poglavje Začetek delovanja).
- 2) Ta funkcija se uporablja za določanje energijsko učinkovitega razreda v skladu s standardom EN 60350-1.

## TEMPERATURE SETTING

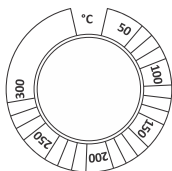

Rotate the knob to set the desired TEMPERATURE.

## TIMER FUNCTIONS

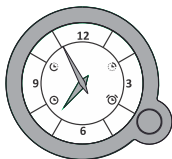

Program timer can be used to set up oven operation in two ways:





### Timed cooking

In this mode, you can specify the duration of oven operation (cooking time).



### INFORMATION!

The longest possible setting is 15 hours from the current time. Check if the clock is set accurately to current time.

Press the timer button repeatedly to select the symbol ; the symbol will start flashing. Rotate the timer button to set the cooking end time. Confirm the setting by pressing the button again. Clock hands will move back to time display. The cooking completion symbol  will light up.

Switch on the oven (use the oven knobs to set the system and temperature). The oven will start to operate immediately and stop and the selected stop time.

When the clock reaches the selected end time, the oven will be switched off. An intermittent acoustic signal will be sounded, which can be switched off by pressing the button; otherwise, it switches off automatically after 1 minute. The symbol  will flash. To continue cooking, press the button and hold it for 2 seconds, and set a new cooking time.





### Delayed start function



Use this function when you wish to start cooking the food in the oven after a certain period of time. Place the dish into the oven. Then, set the program duration and the time when you wish your food done.



### INFORMATION!

The start of the cooking process can be delayed by a maximum of 12 hours relative to the current time, and the time when the cooking process is to end can be set for up to 15 hours in advance. Check if the clock is set accurately to current time.

Press the timer button repeatedly to select the symbol ; the symbol will start flashing. Rotate the button to set the desired start time. Confirm the setting by pressing the button again. Then the cooking end time symbol  will start to flash. Rotate the timer button to set the cooking end time. Confirm the setting by pressing the button again.

Clock hands will move back to time display, and the symbols  and  will light up.

Use the respective knobs to set the system and temperature. The timer will wait for the start of the cooking process. The oven will start to operate at the start time, and stop operating at the stop time.

When the clock reaches the selected end time, the oven will be switched off. An intermittent acoustic signal will be sounded, which can be switched off by pressing the button; otherwise, it switches off automatically after 1 minute. The symbol  will flash. To continue cooking, press the button and hold it for 2 seconds, and set a new cooking time.



### WARNING!

**This function is not suitable for food requiring a preheated oven.**

**Perishable food should not be kept in the oven for a long time.**



### Setting the minute minder

The minute minder can be used independently of oven operation.

Press the timer button repeatedly to select the symbol ; the symbol will start flashing. Rotate the timer button set the time when you wish the minute minder to sound the alarm. The longest possible setting is 3 hours. Confirm the setting by pressing on the button.

Clock hands will move back to time display, and the symbol  will light up.

When the time you set runs out, an intermittent acoustic signal will be sounded. The acoustic signal can be switched off by pressing the button; otherwise, it will switch off automatically after 1 minute.



**INFORMATION!**

If any timer function is set, the minute minder cannot be set up.

### **Displaying the setting**

Whenever a timer function is set, you may check it by pressing the timer button. The clock hands will briefly move to the set value and then return to display the current time.

### **Deleting a setting**

Delete the setting by pressing the button and holding it for 2 seconds. The symbol of the deleted function will be switched off.



# Starting the cooking process

Set the system and the temperature; then, start the cooking process.

## INFORMATION!

During the cooking process, you can change the SYSTEM, TEMPERATURE, and TIMER FUNCTIONS.

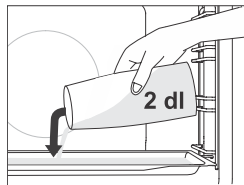

### **Baking with addition of steam**

In systems **with addition of steam**, insert the shallow baking tray in the first-level guide, while the oven is still cool. Pour a maximum of 2 dl of water onto the baking sheet. Place the food to be cooked on the second level and start the system.

## INFORMATION!

If you are using a deep baking tray, insert it one level higher than specified in the recommended settings table.

For optimum operation of the function, do not open the oven door and do not add water during the cooking process.

# End of cooking and switching off the oven

Rotate the SYSTEM SELECTOR KNOB and the TEMPERATURE KNOB to position "0".

## INFORMATION!

After the cooking process, all timer settings are also stopped and deleted, except for the minute minder. Time of day (clock) will be displayed.

After the use of the oven, some water may be left in the condensate channel (underneath the door). Wipe the channel with a sponge or a cloth.

# General tips and advice for baking

- Remove all unnecessary equipment from the oven during baking
- Use equipment made of heat-resistant non-reflective materials (supplied baking trays and dishes, enamel-coated cookware, tempered glass cookware). Bright-coloured materials (stainless steel or aluminium) materials reflect heat. As a result, thermal processing of food in them is less effective.
- Always insert the baking sheets and trays to the end of the guides. When baking on the wire rack, place the baking dishes or trays in the middle of the rack.
- For optimum food preparation, we recommend observing the guidelines specified in the cooking table. Choose the lower specified temperature and the shortest specified cooking time. When this time expires, check the results and then adjust the settings as necessary.
- Unless it is absolutely necessary, do not open the oven door during baking.
- Do not place the baking trays directly onto the oven cavity bottom.
- Do not use the all-purpose deep baking tray on the 1st guide level while the appliance is operating.
- Do not cover the oven cavity bottom or the wire rack with aluminium foil.
- With longer cooking programs, you can switch off the oven approximately 10 minutes before the end of cooking time to make use of the accumulated heat.
- Always place the baking dishes onto the wire rack.
- When baking on several levels at the same time, insert the all-purpose deep baking tray into the lower level.
- When cooking according to recipes from older cookbooks, use the bottom and top heater system (as in conventional ovens) and set the temperature 10 °C lower than specified in the recipe.
- If you are using parchment paper, make sure it is resistant to high-temperatures. Always trim it accordingly. Parchment paper prevents the food from sticking to the baking tray and makes it easier to remove the food from the baking tray.
- When cooking larger cuts of meat or pastry with higher water content, a lot of steam will be generated inside the oven, which in turn may condense on the oven door. This is a normal phenomenon which will not affect the operation of the appliance. After the cooking process, wipe the door and the door glass dry.
- When baking directly on the wire rack, insert the all-purpose deep tray one level lower to serve as a drip tray.

**Fast preheating of the oven:** Only preheat the oven if required by the recipe of in the tables in these instructions for use. If you are using the fast preheating function, do not insert the food into the oven until the oven is fully heated. Temperature has a substantial effect on the final result. Fast preheating is recommended for delicate cuts of meat (sirloin), and for yeast-leavened and sponge dough that require a shorter baking time. Heating an empty oven consumes a lot of energy. Therefore, if possible, we recommend cooking several dishes in succession, or making several dishes simultaneously.

**GentleBake:** Allows slow and controlled cooking at a low temperature. The meat juices are distributed evenly, and the meat remains juicy and tender. The GentleBake slow cooking method is suitable for delicate boneless meat cuts. Before slow cooking, sear the meat thoroughly from all sides in a frying pan.

# Cooking table

NOTE: Dishes requiring a fully pre-heated oven are indicated with a single asterisk \* in the table. Dishes for which a 5-minute pre-heating cycle suffices are indicated with two asterisks \*\*. In this case, do not use the rapid preheat mode.























Dish			°C	⌚ min
<b>PASTRY AND BAKERY PRODUCTS</b>				
<b>pastry/cakes in moulds</b>				
sponge cake	3		150	30-40
pie with filling	1		180	90-120
marble cake	2		170-180	50-60
cake with leavened dough, Gugelhupf (Bundt cake, pound cake)	2		170-180	45-55
open pie, tart	3		170-180	35-45
brownies	2		170-180	30-35
<b>pastry on baking trays and dishes</b>				
strudel	2		180-190	60-70
strudel, frozen	2		200-210	34-45
sponge roll	3	 + baking tray with water	170-180 *	13-18
buchteln	2		180-190	30-40
<b>biscuits, cookies</b>				
cupcakes	3		160 *	20-30
cupcakes, 2 levels	2, 4		145	40-50
yeast-leavened small pastry	2		180 *	17-22
yeast-leavened small pastry, 2 levels	2, 4		160 *	18-25
puff pastry	3		170	30-40
puff pastry, 2 levels	2, 4		170 *	25-30
<b>cookies/biscuits</b>				
pipéd cookies	3		140	30-40
pipéd cookies, 2 levels	2, 4		140	45-55
pipéd cookies, 3 levels	1, 4, 5		145 *	50-60
cookies/biscuits	3		140	20-30

Table continued from last page























































Dish			 °C	 min
biscuits, 2 levels	2, 4		150-160 *	20-25
meringue	3		80-100 *	120-150
meringue, 2 levels	2, 4		80-100 *	120-150
macarons	3		130-140 *	15-20
macarons, 2 levels	2, 4		130-140 *	15-20
<b>bread</b>				
rising and proofing	2		40-45	30-45
bread on a baking tray	2	 + baking tray with water	190-200	40-55
bread on a baking tray, 2 levels	2, 4		190-200 *	40-55
bread in a tin	2		190-200	30-45
bread in a tin, 2 levels	2, 4		200-210	30-45
flatbread (focaccia)	2		270	15-25
fresh bread rolls (Semmel/morning rolls)	3	 + baking tray with water	200-210	10-15
fresh bread rolls (Semmel/morning rolls), 2 levels	2, 4		200-210 *	15-20
toasted bread	5		230	4-7
open sandwiches	5		230	3-5
<b>pizza and other dishes</b>				
homemade pizza	1		300 *	4-7
homemade pizza, 2 rack levels	2, 4		210-220 *	25-30
frozen pizza	2		200-220 *	10-25
frozen pizza, 2 levels	2, 4		200-220 *	10-25
savoury pie, quiche	2		190-200	50-60
burek	2		180-190	40-50
<b>MEAT</b>				
<b>beef and veal</b>				
beef roast (loin, rump), 1.5 kg	2		160-170	130-160
boiled beef, 1.5 kg	2		200-210	90-120

Table continued from last page

Dish			°C	min
sirloin, medium done, 1 kg	2	≡	170-190 *	40-60
beef roast, slow cooked	2	≡	120-140 *	250-300
beef steaks, well done, thickness 4 cm	4	▼▼▼	220-230	25-30
burgers, thickness 3 cm	4	▼▼▼	220-230	25-35
veal roast, 1.5 kg	2	≡	160-170	120-150
<b>pork</b>				
pork roast, rump, 1.5 kg	3		170-180	90-110
pork roast, shoulder, 1.5 kg	3	≡	180-190	120-150
pork loin, 400 g	2	≡	80-100 *	80-100
pork roast, slow cooked	2	≡	100-120 *	200-230
pork ribs, slow cooked	2	≡	120-140 *	210-240
pork chops, thickness 3 cm	4	▼▼▼	220-230	20-25
<b>poultry</b>				
poultry, 1.2-2.0 kg	2	▼▼▼	200-220	60-80
poultry with stuffing, 1.5 kg	2		170-180	80-100
poultry, breast	2		170-180	45-60
chicken thighs	3	▼▼▼	210-220	30-45
chicken wings	4		210-220	30-45
poultry, breast, slow cooked	3	≡	100-120 *	60-90
<b>meat dishes</b>				
meat loaf, 1 kg	2		170-180	60-70
grill sausages, bratwurst	4	▼▼▼	230 **	8-15
<b>FISH AND SEAFOOD</b>				
whole fish, 350 g	4	▼▼▼	230-240	12-20
fish fillet, thickness 1 cm	4	▼▼▼	220-230	8-12
fish steak, thickness 2cm	4	▼▼▼	220-230	10-15
scallops	4	▼▼▼	230 *	5-10
shrimps	4	▼▼▼	230 *	3-10
<b>VEGETABLES</b>				
baked potatoes, wedges	3		210-220 *	30-40
baked potatoes, halved	3	 + baking tray with water	200-210 *	40-50

Table continued from last page

Dish			 °C	 min
stuffed potato (jacket potato)	3		190-200	30-40
French fries, home-made	4		210-220 *	20-30
mixed vegetables, wedges	3	 + baking tray with water	190-200	30-40
stuffed vegetables	3		190-200	30-40
<b>CONVENTIONAL PRODUCTS – FROZEN</b>				
French fries	3		210-220	20-25
french fries, 2 levels	2, 4		190-210	30-40
chicken medallions	4		210-220 *	12-17
fish fingers	2		210-220	15-20
lasagne, 400 g	2		200-210	30-40
diced vegetables	2		190-200	20-30
croissants	3		170-180	18-23
<b>BAKED PUDDINGS, SOUFFLÉS AND DISHES AU GRATIN</b>				
potato moussaka	2		180-190	35-45
lasagne	2		180-190	35-45
sweet baked pudding	2		160-180	40-60
sweet soufflé	2		160-180 *	35-45
dishes au gratin	3		170-190	30-45
stuffed tortillas, enchiladas	2		180-200	20-35
grilling cheese	4		230 **	6-9
<b>OTHER</b>				
preservation	2		180	30
sterilization	3		125	30
cooking in a bain-marie (double boiler)	2		150-170 *	/
reheating	3		60-95	/
plate warming	2		75	15

# Cleaning and maintenance



## **WARNING!**

**Before cleaning, unplug the appliance from the power mains and wait for the appliance to cool down.**

**Children should not clean the appliance or perform maintenance tasks without proper supervision.**

For easier cleaning, oven cavity and baking tray are coated with special enamel for a smooth and resistant surface.

Regularly clean the appliance and use warm water and hand dishwashing liquid to remove larger impurities and limescale. Use a clean soft cloth or sponge cloth.

**Appliance exterior:** use hot soapsuds and a soft cloth to remove impurities, then wipe the surfaces dry.

**Appliance interior:** for stubborn dirt and grime, use conventional oven cleaners. When using such cleaners, thoroughly wipe the appliance with a wet cloth to remove all cleaner residue.

**Accessories and guides:** clean with hot soapsuds and a damp cloth. For stubborn dirt and grime, we recommend prior soaking and use of a brush.

If the cleaning results are not satisfactory, repeat the cleaning process.



## **INFORMATION!**

Never use aggressive or abrasive cleaners and accessories (abrasive sponges and detergents, stain and rust removers, scrapers for glass ceramic plates).

Oven equipment is dishwasher-safe.

Food residue (fat, sugar, protein) can ignite during the use of the appliance. Therefore, remove larger chunks of dirt from the oven interior and accessories before each use.

## Using the Aqua Clean program to clean the oven

This program makes it easier to remove any stains from inside the oven.

The function is the most effective if used regularly, after each use.

Before running the cleaning program, remove all large visible chunks of dirt and food residues from the oven cavity.

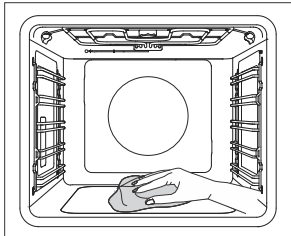
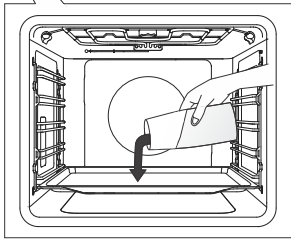
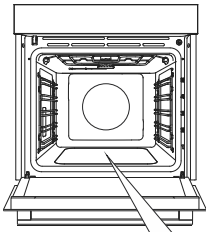

**1** Insert the shallow baking tray into the first guide level and pour 0.4 litres of hot water into it.

**2** Turn the SYSTEM SELECTOR KNOB to Aqua Clean . Set the TEMPERATURE KNOB to 80 °C.

**3** Let the program operate for half an hour.

**4** When the program is completed, carefully remove the baking tray, using oven mitts (there can still be some water on the baking tray). Wipe down the stains with damp cloth and soapsuds. Thoroughly wipe the appliance with a wet cloth to remove all cleaner residue.

### **INFORMATION!**

If the cleaning process is not successful (in case of particularly stubborn dirt), repeat it.

### **WARNING!**

**Use the Aqua Clean system when the oven has fully cooled down.**



## Removing wire and fixed pull-out (extendible) guides

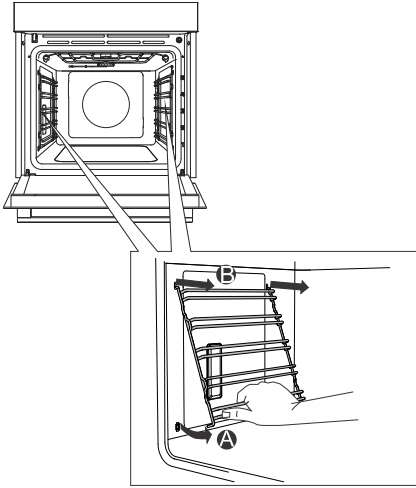

**A** Hold the guides by the bottom side and pull them towards the center of the oven cavity.

**B** Remove them from the openings at the top.

 **INFORMATION!**  
When removing the guides, take care not to damage the enamel coating.

## Removing and replacing the oven door and glass panes

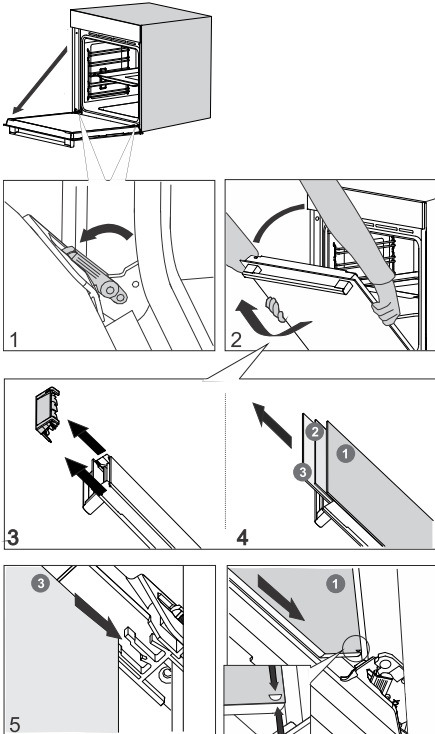

**1** First, fully open the door (as far as it will go).

**2** Oven door is attached to the hinges with special supports that also include safety levers. Rotate the safety levers towards the door by 90°. Slowly close the door to a 45° angle (relative to the position of the fully closed door); then, lift the door and pull it out.

Oven **door glass pane** can be cleaned from the inside, but it has to be removed from the appliance door first. First, proceed as described under item 2, but do not remove it.

**3** Remove the air guide. Hold it on the left- and right-hand side of the door with your hands. Remove it by slightly pulling it towards you.

**4** Hold the door glass at the upper edge and remove it. To the same for the second and third glass pane (depending on the model).

**5** To replace the glass panes, observe the reverse order.

**INFORMATION!**

To replace the door, follow the reverse order. If the door does not open or close properly, make sure the notches on the hinges are aligned with the hinge beds.

**WARNING!**

**The oven door hinge can close with considerable force. Therefore, always rotate both safety levers to the support when fitting or removing the appliance door.**

**Soft door closing and opening**

(depending on the model)

Oven door is fitted with a system that dampens the door closing force, starting at the a 75° angle. It allows simple, quiet, and gentle opening and closing of the door. A gentle push (to a 15° angle relative to the closed door position) is enough for the door to close automatically and softly.

**WARNING!**

**If the force applied to close the door is too strong, the effect of the system is reduced or the system will be bypassed for safety.**

# Replacing the bulb

The bulb is a consumable and therefore not covered by warranty. Before replacing the bulb, remove all accessories from the oven.

Halogen lamp: G9, 230 V, 25 W

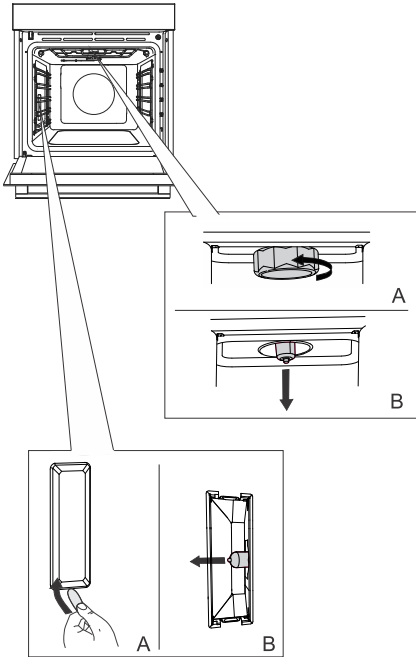

**1** Unscrew and remove the cover (in anti-clockwise direction). Remove the halogen bulb.

**2** Use a flat plastic tool to remove the cover. Remove the halogen bulb.

 **INFORMATION!**  
Take care not to damage the enamel coating.  
Use protection to avoid burning yourself.

 **WARNING!**  
Only replace the light bulb when the appliance is disconnected from power supply.

# Troubleshooting table

## Special warnings and fault reporting

**During the warranty period, only a service center authorized by the manufacturer may carry out any repairs.**

Before making any repairs, make sure the appliance is disconnected from the power mains either by removing the fuse or by disconnecting the power plug from the wall outlet.

Any unauthorized repairs of the appliance may result in electric shock and short circuit hazard; therefore, do not perform them. Leave such work to an expert or a service technician.

In case of minor problems with appliance operation, check this manual to see if you can fix the problem yourself.

If the appliance is not operating properly or at all due to inappropriate operation or handling, a visit from a service technician shall not be free of charge, even during the warranty period.

Save the instructions for future reference and pass them on to any subsequent owners or users of the appliance.

Following is some advice on rectifying some common problems.

<b>Problem/error</b>	<b>Cause</b>
<b>The main fuse in your home trips often.</b>	Call a service technician.
<b>The oven lighting does not work.</b>	The process of changing the light bulb in the oven is described in the chapter Replacing the bulb.

If the problems persist despite observing the above advice, call an authorized service technician. Repair or any warranty claim resulting from incorrect connection or use of the appliance shall not be covered by the warranty. In this case, the user will cover the cost of repair.

# Disposal



Our product packaging is made of environmentally friendly materials that can be recycled, disposed of, or destroyed without any hazard to the environment. To this end, packaging materials are labelled appropriately.

**The symbol** on the product or its packaging indicates that the product should not be treated as normal household waste. Take the product to an authorized collection centre for waste electric and electronic equipment processing.

Correct **disposal** of the product will help prevent any negative effects on the environment and health of people, which could occur in case of incorrect product removal. For detailed information on removal and processing of the product, please contact the relevant municipal body in charge of waste management, your waste disposal service, or the store where you bought the product.

We reserve the right to any changes and errors in the instructions for use.



872293-a5

